



State of West Virginia
 Department of Administration
 Purchasing Division
 2019 Washington Street East
 Post Office Box 50130
 Charleston, WV 25305-0130

Purchase Order

PURCHASE ORDER NO.
 PC07B

PAGE
 1

BLANKET/RELEASE
 00

CORRECT PURCHASE ORDER NUMBER MUST APPEAR ON ALL PACKAGES, INVOICES, AND SHIPPING PAPERS. QUESTIONS CONCERNING THIS PURCHASE ORDER SHOULD BE DIRECTED TO THE BUYER AS NOTED BELOW.

CHANGE ORDER

SEE REVERSE SIDE FOR TERMS AND CONDITIONS

INVOICE TO
 ALL STATE AGENCIES
 AND POLITICAL SUBDIVISIONS
 VARIOUS LOCALES AS INDICATED
 BY ORDER

AGENCY COPY

VENDOR
 *709044554 304-624-7611
 COUNTRY CLUB CHRYSLER DODGE SP
 PO BOX 2321
 ROUTE 19 SOUTH
 CLARKSBURG WV 26301

SHIP TO

ALL STATE AGENCIES
 AND POLITICAL SUBDIVISIONS
 VARIOUS LOCALES AS INDICATED
 BY ORDER

DATE PRINTED		TERMS OF SALE		FEIN/SSN		FUND	
10/25/2006		NET 30		550567749			
SHIP VIA		F.O.B.		FREIGHT TERMS		ACCOUNT NUMBER	
BEST WAY		DESTINATION		PREPAID		MUL-MUL	
LINE	QUANTITY	UOP	VENDOR ITEM NO.		UNIT PRICE	AMOUNT	
	DELIVERY DATE	CAT. NO.	ITEM NUMBER				
BLANKET OPEN-END STATEWIDE CONTRACT							
THIS BLANKET OPEN-END STATEWIDE CONTRACT IS TO SUPPLY 2007 OR CURRENT MODEL YEAR DODGE DURANGO AND DODGE CHARGE POLICE PURSUIT VEHICLES TO ALL WEST VIRGINIA STATE AGENICES AND POLITICAL SUBDIVISIONS.							
0001	10/31/2006	EA	070-06-99-003		20,583.00000		
			2007 OR CURRENT MODEL YEAR DODGE DURANGO				
0002	10/31/2006	EA	070-06-99-002		18,921.00000		
			2007 OR CURRENT MODEL YEAR DODGE CHARGER POLICE				
THIS AWARD IS PER THE FOLLOWING:							
1. REQUEST FOR QUOTATION DATED 8/31/06 AND ALL SPECIFICATIONS CONTAINED THEREIN							

WV STATE PURCHASING DIVISION
 ADMINISTRATION UNIT
 CERTIFIED ENCUMBERED

NOV - 3 2006

Beverly Toler

IF APPROVAL AS TO FORM IS REQUIRED BY ATTORNEY GENERAL, CHECK HERE

OPEN END

TOTAL

APPROVED FOR ONE FISCAL YEAR
Dwayne Wayfield

APPROVED AS TO FORM BY
 ASSISTANT ATTORNEY GENERAL

BETTY FRANCISCO 304-558-0468

BY *[Signature]*
 PURCHASING DIVISION AUTHORIZED SIGNATURE

**GENERAL TERMS & CONDITIONS
PURCHASE ORDER/CONTRACT**

1. **ACCEPTANCE:** Seller shall be bound by this order and its terms and conditions upon receipt of acceptance of this order.
2. **APPLICABLE LAW:** The laws of the State of West Virginia and the *Legislative Rules* of the Purchasing Division shall govern all rights and duties under the Contract, including without limitation the validity of this Purchase Order/Contract.
3. **NON-FUNDING:** All services performed or goods delivered under State Purchase Orders/Contracts are to be continued for the terms of the Purchase Order/Contract, contingent upon funds being appropriated by the Legislature or otherwise being made available. In the event funds are not appropriated or otherwise available for these services or goods, this Purchase Order/Contract becomes void and of no effect after June 30.
4. **COMPLIANCE:** Seller shall comply with all Federal, State and local laws, regulations and ordinances including, but not limited to, the prevailing wage rates of the WV Division of Labor.
5. **MODIFICATIONS:** This writing is the parties final expression of intent. No modification of this order shall be binding unless agreed to in writing by the Buyer.
6. **ASSIGNMENT:** Neither this Order nor any monies due, or to become due hereunder may be assigned by the Seller without the Buyer's consent.
7. **WARRANTY:** The Seller expressly warrants that the goods and/or services covered by this Order will: [a] conform to the specifications, drawings, samples or other description furnished or specified by the Buyer; [b] be merchantable and fit for the purpose intended; and/or [c] be free from defect in material and workmanship.
8. **CANCELLATION:** The Director of Purchasing may cancel any Purchase Order/Contract upon 30 days written notice to the Seller.
9. **SHIPPING, BILLING & PRICES:** Prices are those stated in this order. No price increase will be accepted without written authority from the Buyer. All goods or services shall be shipped on or before the date specified in this Order.
10. **LATE PAYMENTS:** Payments may only be made after the delivery of goods or services. Interest may be paid on late payments in accordance with the *West Virginia Code*.
11. **TAXES:** The State of West Virginia is exempt from Federal and State taxes and will not pay or reimburse such taxes.
12. **RENEWAL:** Any reference to automatic renewal is hereby deleted. The Contract may be renewed only upon mutual written agreement of the parties.
13. **BANKRUPTCY:** In the event the vendor/contractor files for bankruptcy protection, this Contract is automatically null and void, and is terminated without further order.
14. **HIPAA BUSINESS ASSOCIATE ADDENDUM:** The West Virginia State Government HIPAA Business Associate Addendum (BAA), approved by the Attorney General, and available online at the Purchasing Division's web site (<http://www.state.wv.us/admin/purchase/vrc/hipaa.htm>) is hereby made part of the agreement. Provided that, the Agency meets the definition of a Covered Entity (45 CFR §160.103) and will be disclosing Protected Health Information (45 CFR §160.103) to the vendor.



State of West Virginia
 Department of Administration
 Purchasing Division
 2019 Washington Street East
 Post Office Box 50130
 Charleston, WV 25305-0130

Purchase Order

PURCHASE ORDER NO.
 PC07B

PAGE
 2

BLANKET RELEASE
 00

CORRECT PURCHASE ORDER NUMBER MUST APPEAR ON ALL PACKAGES, INVOICES, AND SHIPPING PAPERS. QUESTIONS CONCERNING THIS PURCHASE ORDER SHOULD BE DIRECTED TO THE BUYER AS NOTED BELOW.

CHANGE ORDER

REPRINT NUMBER
 1

SEE REVERSE SIDE FOR TERMS AND CONDITIONS

INVOICE TO

ALL STATE AGENCIES
 AND POLITICAL SUBDIVISIONS
 VARIOUS LOCALES AS INDICATED
 BY ORDER

VENDOR

*709044554 304-624-7611
 COUNTRY CLUB CHRYSLER DODGE SP
 PO BOX 2321
 ROUTE 19 SOUTH
 CLARKSBURG WV 26301

SHIP TO

ALL STATE AGENCIES
 AND POLITICAL SUBDIVISIONS
 VARIOUS LOCALES AS INDICATED
 BY ORDER

DATE PRINTED		TERMS OF SALE		FEIN/SSN		FUND	
10/25/2006		NET 30		550567749			
SHIP VIA		F.O.B.		FREIGHT TERMS		ACCOUNT NUMBER	
BEST WAY		DESTINATION		PREPAID		MUL-MUL	
LINE	QUANTITY	UOP	VENDOR ITEM NO.		UNIT PRICE	AMOUNT	
	DELIVERY DATE	CAT. NO.	ITEM NUMBER				
2.	VENDOR'S		BID DATED 10/11/2006				
	SEE THE ATTACHED FOR LIST OF STANDARD EQUIPMENT INCLUDED IN THE BASE PRICE AND THE LIST OF OPTIONAL EQUIPMENT AVAILABLE AND COST THEREOF.						
	POLITICAL SUBDIVISIONS SHALL CONTACT THE VENDOR DIRECTLY FOR PURCHASES THROUGH THIS CONTRACT.						
	EXHIBIT 2						
	LIFE OF CONTRACT: THIS CONTRACT BECOMES EFFECTIVE ON NOVEMBER 1, 2006, AND EXTENDS FOR A PERIOD OF ONE (1) YEAR OR UNTIL SUCH "REASONABLE TIME" THEREAFTER AS IS NECESSARY TO OBTAIN A NEW CONTRACT OR RENEW THE ORIGINAL CONTRACT. THE "REASONABLE TIME" PERIOD SHALL NOT EXCEED TWELVE (12) MONTHS. DURING THIS "REASONABLE TIME" THE VENDOR MAY TERMINATE THIS CONTRACT FOR ANY REASON UPON GIVING THE DIRECTOR OF PURCHASING THIRTY (30) DAYS WRITTEN NOTICE.						
	UNLESS SPECIFIC PROVISIONS ARE STIPULATED IN THIS CONTRACT DOCUMENT, THE TERMS, CONDITIONS, AND PRICING SET HEREIN ARE FIRM FOR THE LIFE OF THE CONTRACT.						
	RENEWAL: THIS CONTRACT MAY BE RENEWED UPON THE MUTUAL WRITTEN CONSENT OF THE SPENDING UNIT AND VENDOR, SUBMITTED TO THE DIRECTOR OF PURCHASING THIRTY (30)						

IF APPROVAL AS TO FORM IS REQUIRED BY ATTORNEY GENERAL, CHECK HERE

TOTAL

APPROVED AS TO FORM BY
 ASSISTANT ATTORNEY GENERAL

BY _____
 PURCHASING DIVISION AUTHORIZED SIGNATURE



State of West Virginia
 Department of Administration
 Purchasing Division
 2019 Washington Street East
 Post Office Box 50130
 Charleston, WV 25305-0130

Purchase Order

PURCHASE ORDER NO.
 PC07B

PAGE
 3

BLANKET RELEASE
 00

CORRECT PURCHASE ORDER NUMBER
 MUST APPEAR ON ALL PACKAGES,
 INVOICES, AND SHIPPING PAPERS.
 QUESTIONS CONCERNING THIS PUR-
 CHASE ORDER SHOULD BE DIRECTED
 TO THE BUYER AS NOTED BELOW.

CHANGE ORDER

REPRINT NUMBER
 1

**SEE REVERSE SIDE FOR
 TERMS AND CONDITIONS**

INVOICE TO
 ALL STATE AGENCIES
 AND POLITICAL SUBDIVISIONS
 VARIOUS LOCALES AS INDICATED
 BY ORDER

VENDOR
 *709044554 304-624-7611
 COUNTRY CLUB CHRYSLER DODGE SP
 PO BOX 2321
 ROUTE 19 SOUTH
 CLARKSBURG WV 26301

SHIP TO
 ALL STATE AGENCIES
 AND POLITICAL SUBDIVISIONS
 VARIOUS LOCALES AS INDICATED
 BY ORDER

DATE PRINTED		TERMS OF SALE		FEIN/SSN		FUND	
10/25/2006		NET 30		550567749			
SHIP VIA		F.O.B.		FREIGHT TERMS		ACCOUNT NUMBER	
BEST WAY		DESTINATION		PREPAID		MUL-MUL	
LINE	QUANTITY	UOP	VENDOR ITEM NO.		UNIT PRICE	AMOUNT	
	DELIVERY DATE	CAT. NO.	ITEM NUMBER				
	DAYS PRIOR TO THE EXPIRATION DATE. SUCH RENEWAL SHALL BE IN ACCORDANCE WITH THE TERMS AND CONDITIONS OF THE ORIGINAL CONTRACT AND SHALL BE LIMITED TO TWO (2) ONE (1) YEAR PERIODS.						
	CANCELLATION: THE DIRECTOR OF PURCHASING RESERVES THE RIGHT TO CANCEL THIS CONTRACT IMMEDIATELY UPON WRITTEN NOTICE TO THE VENDOR IF THE COMMODITIES AND/OR SERVICES SUPPLIED ARE OF AN INFERIOR QUALITY OR DO NOT CONFORM WITH THE SPECIFICATIONS OF THE BID AND CONTRACT HEREIN.						
	OPEN MARKET CLAUSE: THE DIRECTOR OF PURCHASING MAY AUTHORIZE A SPENDING UNIT TO PURCHASE ON THE OPEN MARKET, WITHOUT THE FILING OF A REQUISITION OR COST ESTIMATE, ITEMS SPECIFIED ON THIS CONTRACT FOR IMMEDIATE DELIVERY IN EMERGENCIES DUE TO UNFORESEEN CAUSES (INCLUDING BUT NOT LIMITED TO DELAYS IN TRANSPORTATION OR AN UNANTICIPATED INCREASE IN THE VOLUME OF WORK).						
	QUANTITIES: QUANTITIES LISTED IN THE REQUISITION ARE APPROXIMATIONS ONLY, BASED ON ESTIMATES SUPPLIES BY THE STATE SPENDING UNIT. IT IS UNDERSTOOD AND AGREED THAT THE CONTRACT SHALL COVER THE QUANTITIES ACTUALLY ORDERED FOR DELIVERY DURING THE TERM OF CONTRACT, WHETHER MORE OR LESS THAN THE QUANTITIES SHOWN.						
	ORDERING PROCEDURE: SPENDING UNIT(S) SHALL ISSUE A WRITTEN EQUIPMENT CONTRACT ORDER (FORM NUMBER WV-35)						

IF APPROVAL AS TO FORM IS REQUIRED BY ATTORNEY GENERAL, CHECK HERE

TOTAL

APPROVED AS TO FORM BY
 ASSISTANT ATTORNEY GENERAL

BY _____
 PURCHASING DIVISION AUTHORIZED SIGNATURE



State of West Virginia
 Department of Administration
 Purchasing Division
 2019 Washington Street East
 Post Office Box 50130
 Charleston, WV 25305-0130

Purchase Order

PURCHASE ORDER NO.
 PC07B

PAGE
 4

BLANKET RELEASE
 00

CORRECT PURCHASE ORDER NUMBER MUST APPEAR ON ALL PACKAGES, INVOICES, AND SHIPPING PAPERS. QUESTIONS CONCERNING THIS PURCHASE ORDER SHOULD BE DIRECTED TO THE BUYER AS NOTED BELOW.

CHANGE ORDER

REPRINT NUMBER
 1

SEE REVERSE SIDE FOR TERMS AND CONDITIONS

I N V O I C E T O
 ALL STATE AGENCIES
 AND POLITICAL SUBDIVISIONS
 VARIOUS LOCALES AS INDICATED
 BY ORDER

V E N D O R
 *709044554 304-624-7611
 COUNTRY CLUB CHRYSLER DODGE SP
 PO BOX 2321
 ROUTE 19 SOUTH
 CLARKSBURG WV 26301

S H I P T O
 ALL STATE AGENCIES
 AND POLITICAL SUBDIVISIONS
 VARIOUS LOCALES AS INDICATED
 BY ORDER

DATE PRINTED		TERMS OF SALE		FEIN/SSN		FUND	
10/25/2006		NET 30		550567749			
SHIP VIA		F.O.B.		FREIGHT TERMS		ACCOUNT NUMBER	
BEST WAY		DESTINATION		PREPAID		MUL-MUL	
LINE	QUANTITY	UOP	VENDOR ITEM NO.		UNIT PRICE	AMOUNT	
	DELIVERY DATE	CAT. NO.	ITEM NUMBER				
FOR COMMODITIES COVERED BY THIS CONTRACT. THE ORIGINAL WV-35 MUST BE SENT TO THE PURCHASING DIVISION OF THE DEPARTMENT OF ADMINISTRATION. AFTER APPROVAL AND ENCUMBRANCE, ONE COPY OF THE PURCHASE ORDER WILL BE RETURNED TO THE SPENDING UNIT AND ONE COPY FORWARDED TO THE VENDOR AS AUTHORIZATION FOR SHIPMENT. NO ORDER IS VALID UNLESS APPROVED AND ENCUMBERED BY THE PURCHASING DIVISION. BANKRUPTCY: IN THE EVENT THE VENDOR/CONTRACTOR FILES FOR BANKRUPTCY PROTECTION, THIS CONTRACT IS AUTOMATICALLY NULL AND VOID, AND IS TERMINATED WITHOUT FURTHER ORDER.							

IF APPROVAL AS TO FORM IS REQUIRED BY ATTORNEY GENERAL, CHECK HERE

TOTAL

APPROVED AS TO FORM BY
 ASSISTANT ATTORNEY GENERAL

BY _____
 PURCHASING DIVISION AUTHORIZED SIGNATURE

Don McNemar
COUNTRY CLUB CHRYSLER DODGE
PO Box 2321 - US Rt 19 S.
Clarksburg, WV 26302-2321
800-424-7611 FAX 304-624-5428

**2007 DODGE CHARGER POLICE PURSUIT VEHICLE
(MID-SIZE, FOUR DOOR, REAR WHEEL DRIVE)**

The base price bid of the specified vehicle will include all items/features/equipment listed by Dodge as standard equipment, as well as any other "optional" features listed below under Mandatory Equipment Base Package. These features include:

MODEL: 2007 Dodge Charger- 4 door Sedan
Order Code:

Mandatory Equipment Base Package:

Air Conditioning:	Installed
Locks:	Power with rear door child security
Radio:	AM/FM/Cassette with Clock
Steering:	Power, with Tilt Wheel
Wipers:	Intermittent with high speed Anti-lift Wipers System on Driver side
Brakes:	4 Wheel Anti-Lock disc brakes with Police Calibration and Heavy duty front brake pads.
Suspension:	
Transmission:	Five-Speed automatic transmission with overdrive plus autostick (column shifter)
Engine:	3.5 Liter V-6 engine
Cooling:	Severe Duty Cooling System
Engine Cradle:	Reinforced
Front Struts:	Reinforced
Alternator:	160-Amp high-output alternator
Battery:	Heavy Duty
Tires:	P225/60R18 BSW V-Rated performance tires
Wheels/Covers:	18 x 7.5 inch steel wheels with standard Dodge Wheel Covers.
Spare Tire:	Full
Seats-Front:	Heavy-duty cloth front bucket seats with manual lumbar .
Seats-Rear:	Cloth Bench.
Speedometer:	160-mph certified-calibrated speedometer.
Key:	Separate key and key fob
Defogger:	Rear Window installed.
License Bracket:	Front and rear
Dome Light:	Door Switch Deactivated
Electric Mirrors:	LH & RH Remote installed
Windows:	Power with drivers' one touchdown feature
Floor Covering:	Full Carpeting to include a set of four, color-coordinated factory floor mats
Trunk Release:	Electric
Dome Lamp ()	Front Aux.

Service Manuals (one set) (complete Set of "dealer" shop manuals, inclusive of any future updates)	\$	85.00 CD ONLY
	\$	STANDARD
Mats, Front and Rear ()	\$	37.00
All Vehicles Keyed Alike:	\$	-142.00
Spare Tire-Full Size (credit)	\$	STANDARD
Traction Control	\$	37.00
Switchable Daytime Running Lights	\$	STANDARD
Auxiliary wiring battery ignition feed to The front passenger floor/dash area	\$	STANDARD
Grounding Stud located in trunk	\$	STANDARD
Wiring for alternating lamps (Wig Wag)	\$	350.00
Power Drivers Seat	\$	COLUMN MOUNT ONLY
Shift Lever ()	\$	-168.00
West Virginia State Police custom paint Scheme (credit)	\$	

SEE ATTACHED OPTION SHEET

Important Note: The above specified base vehicle cost for vehicles painted "standard factor colors" (no two tone).

The base price quoted above is for any of the specified "standard factor colors" and must include color keyed // matching body trim and bumper covering, if available.

The below listed paint schemes are optional and shall be priced as indicated:

Standard Factory Color in Two-Tone Paint Scheme: **NOT AVAILABLE**
\$ _____

If minimum order quantity required for Special Police Paint Schemes, specify here:

NOT AVAILABLE AT THIS TIME
Minimum # **POSSIBILITY AT LATER DATE**

PC07 DODGE CHARGER

ADDITIONAL 2007 CHARGER OPTION'S

	COST
18' FULL FACE BOLT ON WHEEL COVERS	\$28.00
DEACTIVATE REAR DOORS & WINDOWS	\$23.00
DISABLES LEVERS & SWITCHES RELOCATES DOOR LOCKS	
FACTORY FOG LIGHT NOT AVAILABLE FROM FACTORY [DEALER INSTALLED]	\$193.00
WIRING ADAPTER KIT DEALER PARTS ONLY	\$10.27

DODGE MAGNUM OPTION ADD ON TO BASE CHARGER PRICE

V-6 3.5L POLICE UNIT	\$1,488.00
V-8 5.7L MDS HEMI POLICE UNIT	\$4,552.00
CARGO COMPARTMENT COVER	\$69.00
REAR CARGO ORGANIZER	\$147.00

STANDARD COLORS - - - - ALL MODELS

BRIGHT SILVER
BRILIANT BLACK
MARINE BLUE
SLIVER STEEL
STEEL BLUE
STONE WHITE

OPTIONAL COLOR

INFERNO RED \$207.00

INTERIOR COLOR

DK/LT SLATE GRAY - - - ONLY

DON McNEMAR
COUNTRY CLUB CHRYSLER DODGE INC
PO BOX 2321
CLARKSBURG, WV 26302
304-624-7611 800-424-7611
FAX 304-624-5428
CELL-304-669-0192
E-MAIL businesslink@countryclubchrysler.com



PC07

2007 SPORT UTILITY VEHICLE DODGE DURANGO, ~~FORD EXPLORER, JEEP GRAND CHEROKEE~~ (FULL SIZE, FOUR DOOR, FOUR WHEEL DRIVE, UTILITY VEHICLE)

COUNTRY CLUB CHRYSLER DODGE
PO BOX 2321
CHARLESTON, WV 26302
800-424-7611 304-624-7611
FAX 304-624-5428
E-MAIL
businessclub@countryclubchrysler.com

Vehicles bid in this classification shall be full-size, four door vehicles commonly referred to as sport utility vehicles. In addition to four passenger doors, they must also include a rear lift gate or cargo doors. Any vehicle bid must be able to withstand the rigors of police use and shall meet the following minimum specifications.

The base price bid of the specified vehicle will include all items/features/equipment listed by the manufacturer as standard equipment, as well as any other "optional" features listed below. These features include, but are not limited to the following.

Mandatory Equipment Package:

- Engine: Minimum 4.6 Liter, V8 **4.7 L V-8**
- Wheelbase: Minimum 113"
- Transmission: Automatic, with Heavy Duty Oil Cooler, Maximum Available
- Differential: Limited Slip, Rear **TRACTION CONTROL W/ Electronic Stability**
- Transfer Case: 4 wheel Drive, with no Center Mounted Shifter(s)
- Suspension: Heavy Duty with Front and Rear Stabilizer
- Engine Cooling: Heavy Duty, Maximum Available for Vehicle
- Steering: Power Assisted
- Brakes: Power Assisted / 4 Wheel ABS
- Radio: AM/FM Cassette Stereo (AM/FM CD - Standard)
- Front Seats: Cloth, High Back, Bucket Seats
- Rear Seat: Cloth Bench
- Third Seat: None
- Windows: Power Operated
- Door Locks: Power Operated with Rear Child Safety Feature
- Floor Covering: Fully Carpeted Passenger Compartment and Cargo Area with Coordinating Carpeted Floor Mats (4) or Heavy Duty Black Vinyl Floor Covering (if Available with other Equipment Specified)
- Rear Window Defogger: Installed
- Air Conditioning: Installed
- Spare Tire: Full Size
- Skid Plates: Transmission and Transfer Case

- End of Base Equipment Listing B

IMPORTANT NOTE: Prospective Vendors must include all profit margins for the vehicle bid in the "Base Vehicle Cost" specified below. Any and all options must be made available at actual Dealer Cost (the below listing is not all-inclusive). Pricing for all options listed below must be provided with the bid package. Failure to provide option-pricing information (at dealer cost) shall be grounds for disqualification of the bid.

Model: **DODGE DURANGO SXT**

Base Vehicle Cost: **\$ 20,583.00**

**2007 SPORT UTILITY VEHICLE DODGE DURANGO, FORD EXPLORER,
JEEP GRAND CHEROKEE (FULL SIZE, FOUR DOOR, FOUR WHEEL
DRIVE, UTILITY VEHICLE)**

OPTION PRICING INFORMATION:

Trailer Towing Package:

\$ INCLUDED WITH STANDARD
NO COOLING

Service Manuals (one set)-
(complete set of "dealer" shop manuals,
Inclusive of any future updates)

\$ 85.00 CD ONLY

ADDITIONAL OPTIONS:	
5.7 L MULTI-DISPLACEMENT ENGINE	
REQUIRES SLT & INCLUDED	\$3400.00
SLT PACKAGE W/ 4.7L ENG	\$2377.00
2 SPEEDTRANSFER CASE	\$168.00
GRAY RUNNING BOARDS	\$338.00

Miscellaneous: Inspection of Sample Vehicle(s): Within one week after the issuance of a purchase order, the successful bidder shall make arrangements to deliver to the West Virginia State Police, 725 Jefferson Road, South Charleston, West Virginia, a sample vehicle having the same general body, chassis, engine and transmission as the vehicle on which the bid was submitted. This vehicle is not a patrol vehicle and may be a vehicle from the dealer's stock. It will be used as a prototype for determining the method of attaching various items of police equipment.

The standard factory warranty of the vehicle bid shall be clearly specified within the body of the Vendor's bid submission. In addition, any available extended factory warranties which are optional shall also be bid as separate items, listing all areas and items covered.

Note: Equipment installation to be at the factory and not "add on" dealer accessories. Any exception(s) will be clearly stated within the body of the respective Vendor's bid submission.

Inspection, Testing and Evaluation -- State Police Vehicle Only .

Pre-Delivery: Prior to delivery, each, new vehicle must be completely serviced in accordance with standard new car dealer "make ready" preparation and in accordance with these specifications and the manufacturer's recommendations. Crankcase, differential, transmissions and fuel tank must be filled to capacity as recommended by the manufacturer. Each vehicle shall contain a pre-delivery check sheet showing what operations have been performed on the vehicle and signed by the mechanic(s) or individuals that worked on the same prior to the department inspection.

Delivery, Testing and Evaluation: Vehicles will be inspected, tested and evaluated to determine if they meet the requirements of this specification.

Vehicles will be delivered by the dealer. (Vehicles purchased by the West Virginia State Police will be delivered to 725 Jefferson Road, South Charleston, West Virginia.) Vehicles will not be accepted until inspected and approved by the Purchaser. All repairs and corrections will be the responsibility of the dealer. Dealer will provide dealer's license, insurance (as required for dealer license), and reasonable management assistance for pre-delivery acceptance inspections. If the successful bidder's car does not meet the requirements of this specification, it will be rejected.



Dodge Charger: Taking Control at All Times

Police-Specific ESP

For maximum vehicle control, the Dodge Charger Police Vehicle is equipped with our exclusive Electronic Stability Program⁽¹⁾ (ESP), which has been specifically calibrated for police use. It electronically detects and automatically assists drivers in critical driving situations, including adverse conditions.

ESP Components:

- Antilock Brake System (ABS)
- All-Speed Traction Control
- Yaw Sensor
- Steering Angle Sensor

ESP technology works by constantly comparing the driver's intended course with the vehicle's actual course, detecting differences, applying the brakes to individual wheels and controlling engine power to help keep the vehicle on its intended path.

For example, in the event the vehicle understeers, ESP automatically applies the inside rear brake to help the driver achieve the desired turn. It may also reduce engine power.

The opposite occurs when a vehicle oversteers. ESP automatically applies the outside front brake to help correct the oversteer or "fishtail" situation.

⁽¹⁾ No system, no matter how sophisticated, can repeal the laws of physics or overcome careless driving actions. Performance is limited by available traction, which snow, ice and other conditions can affect. When the ESP warning lamp in the speedometer flashes, the driver needs to use less throttle and adapt speed and driving behavior to prevailing road conditions. Always drive carefully, consistent with conditions. Please always wear your seat belt.

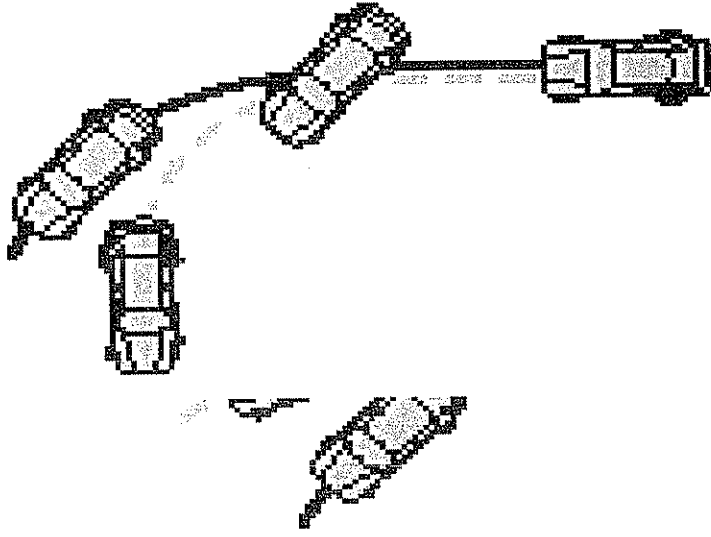

Standard ESP — One of a Kind

Charger is the only police vehicle with standard ESP with three different modes. A study conducted by the National Highway Traffic Safety Administration (NHTSA) shows that electronic stability control, our ESP system, reduced single-vehicle crash risk for cars by 35 percent.

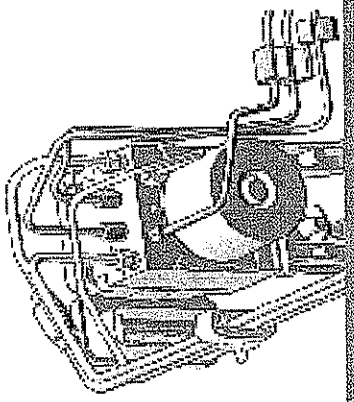

Three Levels of Stability

The special police version of ESP found on Charger and Magnum operates in three different modes:

- **ESP On** offers fully enhanced vehicle stability
- **Partial Off** turns the system partially off, modifying ESP thresholds and disabling traction control at low speeds
- **Full Off** works the same as **Partial Off**; however the ESP function is turned completely off

In all modes, ABS and Brake Assist are not affected.

ESP works in concert with the vehicle's brake system, which includes heavy-duty, four-wheel disc antilock brakes and Brake Assist — all standard and all designed to deliver maximum braking power.

Dodge Charger: Engineered to Handle the Way You Drive

Police-Specific Brake System

For quicker stopping power, Charger is equipped with an impressive brake system that is unique to police vehicles and includes:

- High-performance brake pads — front and rear
- Heavy-duty four-wheel disc brakes with ABS
- 13.6x1.1-inch-vented front rotors
- 13.8x1.0-inch-vented rear rotors
- Modified rear caliper
- Larger master cylinder

The standard antilock brake system — with unique ABS calibration — increases vehicle control and stability under extreme braking conditions. Charger is also equipped with Brake Assist. This standard feature helps apply maximum braking power in emergency situations.

Steering/Suspension

Dodge Charger features performance-tuned steering that really excels at high speeds, as well as a heavy-duty, performance-tuned suspension that incorporates rear load leveling and height control to handle bigger cargo loads. Charger is also the only rear-wheel-drive police vehicle with a standard short/long arm front suspension and a five-link rear suspension, providing high-performance handling, optimal ride comfort and maximum traction.

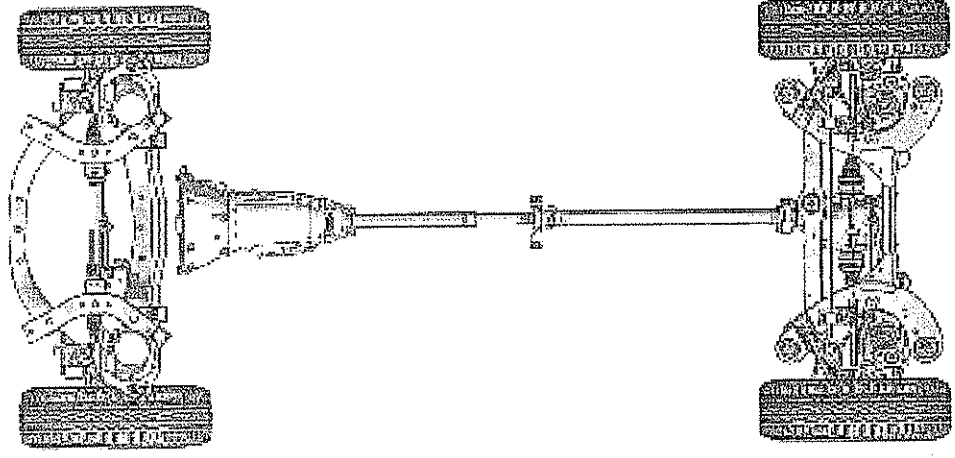

Best-in-Class Braking and Handling

According to 2005 Michigan State Police vehicle testing, Dodge Charger delivers best-in-class braking power — 60-0 mph in 130.1 feet (projected stopping distance). And according to 2005 Los Angeles County Police testing, Dodge Magnum and Dodge Charger took first and second place in the handling phase, as well as top honors in brake testing, pursuit and acceleration.

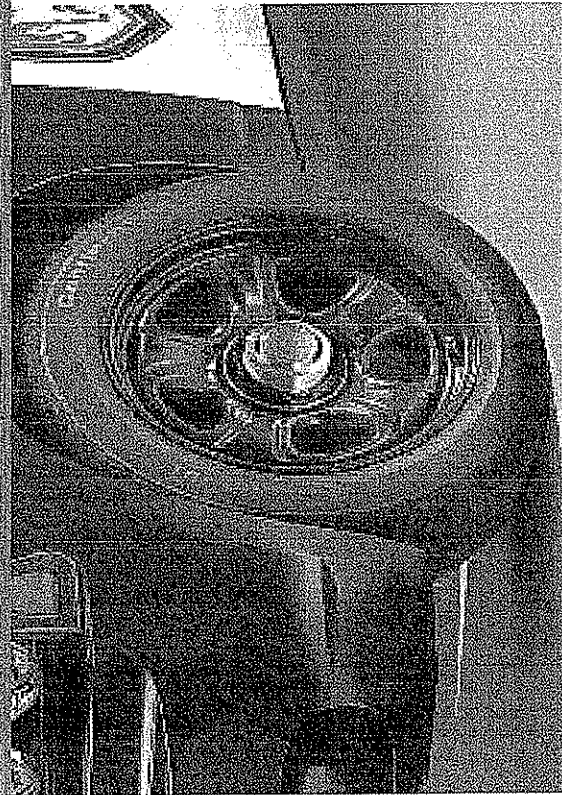
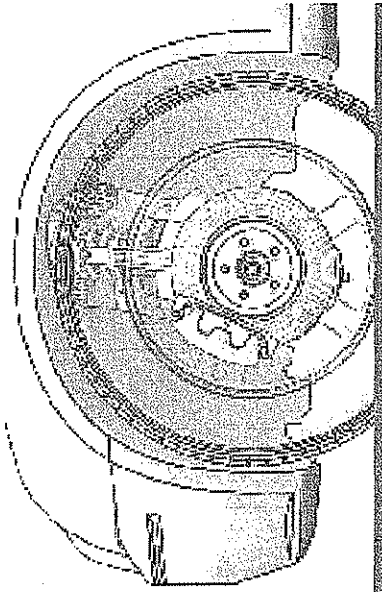

Tires/Wheelbase

Handling, ride comfort and traction are further accentuated by Charger's standard 18-inch heavy-duty steel wheels and P225/60R18 all-season performance tires — the largest offered on a police car.

Dodge Charger has the longest wheelbase in its class — 120 inches. It also has a nearly 50/50 front-to-rear weight distribution for improved balance and traction. Its “wheels-to-the-corners” design and wider track provide greater stability and improved handling.

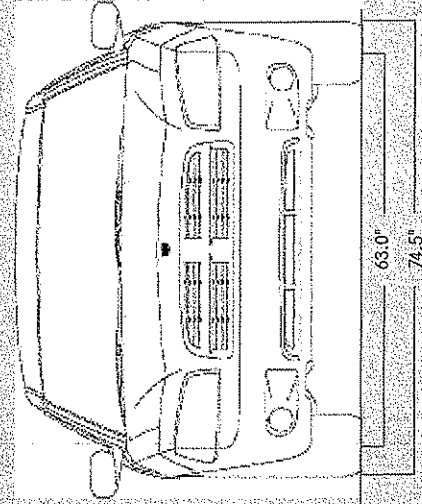
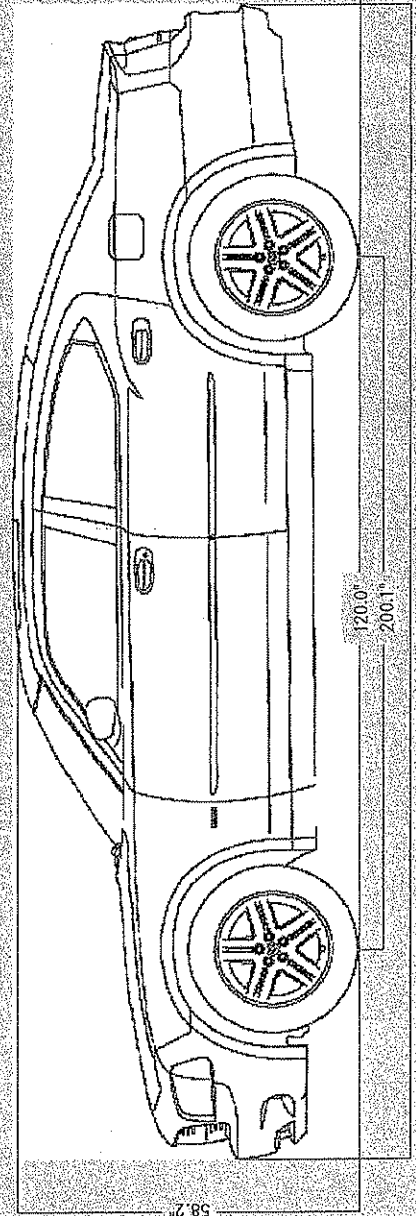

Dodge Charger: Designed with Police Officers in Mind

Outstanding Safety Features

Dodge Charger has earned five stars, the highest frontal crash test rating, from NHTSA. This outstanding rating results from Charger's rigid Unibody steel construction, a structure that provides solid occupant protection. Three distinct front-crush zones absorb and direct-impact energy away from the passenger compartment.

Front and Supplemental Side Air Bags

To protect officers inside the vehicle, multistage driver and front-passenger air bags are standard.⁽¹⁾

Supplemental side-curtain air bags are available and provide an additional level of protection from side impacts. They may not be compatible with the prisoner partition.

Charger is equipped with a saddlebag fuel tank that is mounted forward of the rear axle.

⁽¹⁾ Always use seat belts. Remember, a booster seat is the safest place for children 12 and under.

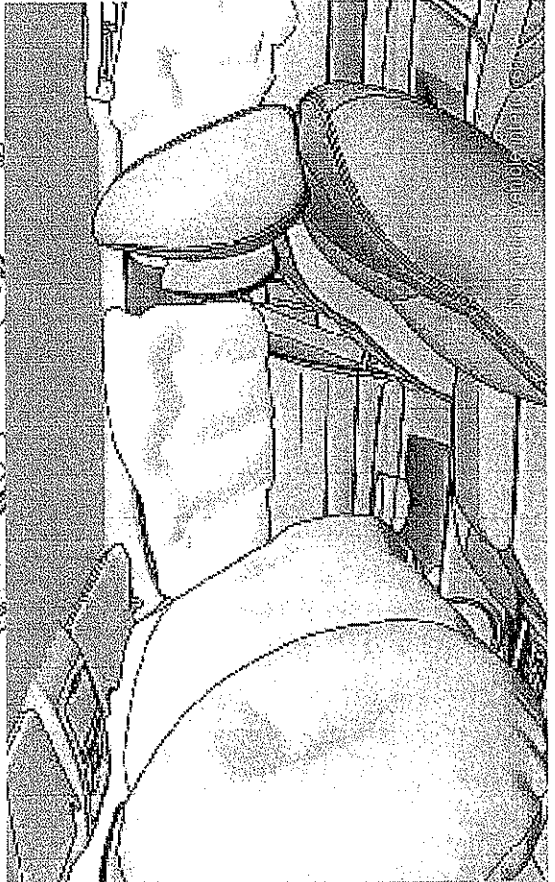
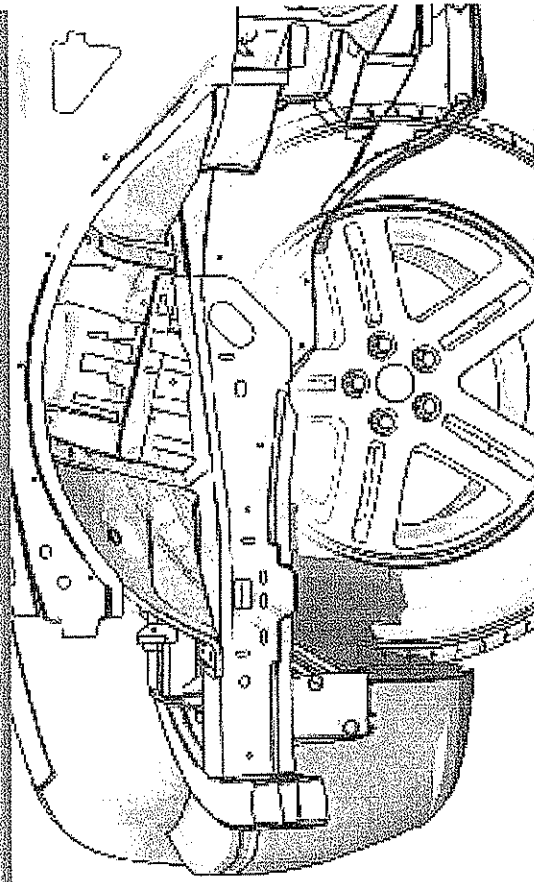

Best-in-Class Rear-Seat Leg Room

Dodge Charger provides more rear-seat leg room than the Ford Crown Victoria or Chevrolet Impala police vehicles.

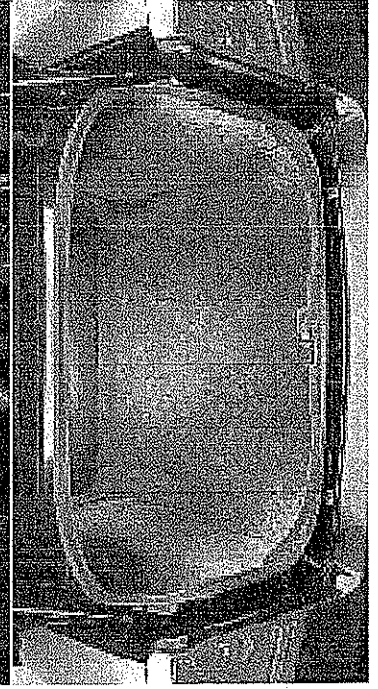
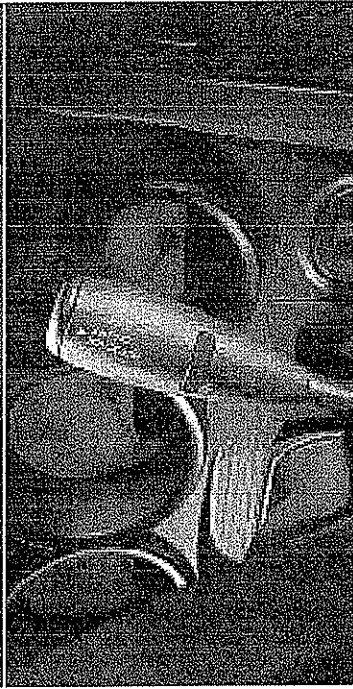
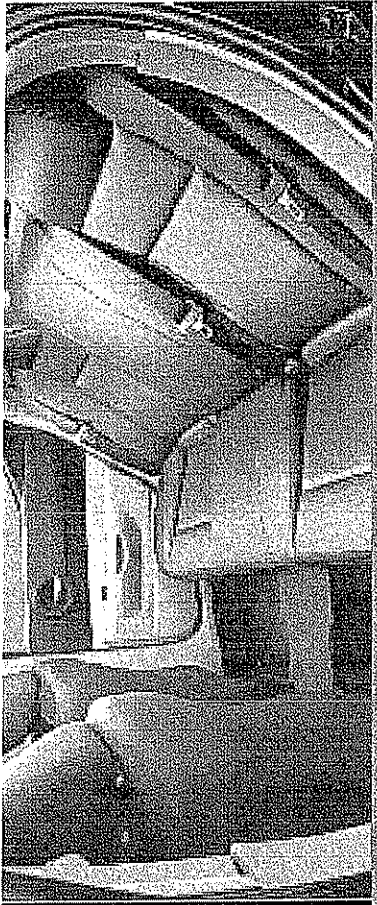

Seats

Charger's heavy-duty front bucket seats are covered in heavyweight cloth, and the seats' low side bolsters allow enough space for taller, fully equipped officers to comfortably buckle their seat belts over their utility belts.

Police-Specific Shifter

The five-speed automatic transmission shift lever is mounted on the instrument panel to make room for police equipment in the center console area, and to prevent accidental downshifting. When activated, AutoStick® enables police officers to manually select optimal gearing while driving. The standard tilt steering column adjusts easily to the driver's comfort.

Police Lighting

To also help with nighttime activities, the Stealth Mode Switch turns off instrument cluster and radio indicators and dims the PRNDL to the lowest legal level.

Spacious Trunk

When outfitted with the standard compact spare tire, Charger's trunk delivers 16.2 cubic feet of cargo capacity. The optional full-size spare tire mounts above and forward of the compact tire mounting, providing plenty of storage room for police equipment.

Dodge Charger and Magnum Designed to Keep Your Uprighting Costs Down

Police-Specific Features

From their inception, Dodge Charger and Magnum Police Vehicles were designed with the needs of law enforcement agencies in mind. Proof can be found in the many features that are exclusive to these vehicles ... police-specific features designed to make it easier for your officers to do their jobs while keeping your upfitting costs down.

LED Interior Dome Lamp

Charger and Magnum have an available unique, independently-switched red/white LED interior dome lamp. It gives officers a white light to illuminate the interior and a red light for use with night vision equipment.

Police Equipment Mounting Bracket

The Chrysler Group is also the only OEM to provide a standard Police Equipment Mounting Bracket. This unique bracket is installed in the center console area between the front and rear seats and provides a single surface to easily mount a radio, computer system, video control and other police equipment.

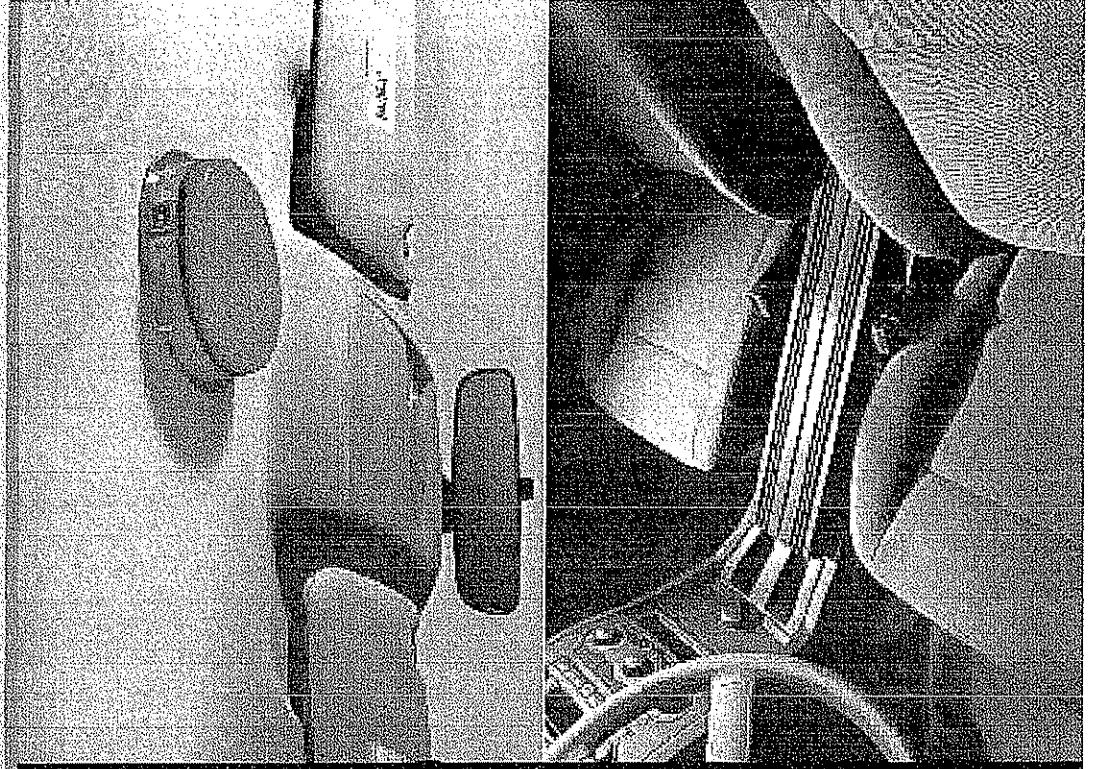

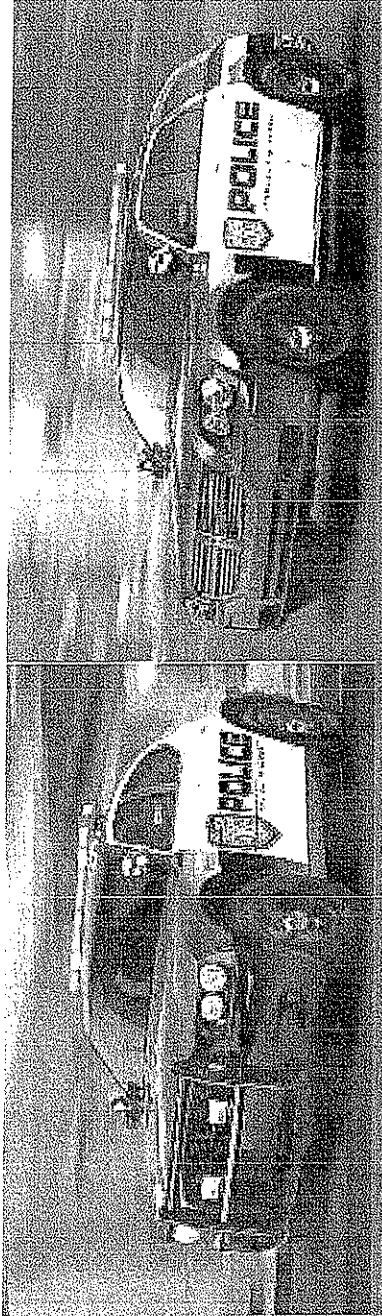

Police Equipment Interface Module

Another feature unique to Charger and Magnum is the Police Equipment Interface Module. This police vehicle first gives upfitters a single interface connection for most aftermarket electrical police equipment. It's located under the instrument panel center stack area.

120-Amp Power Connection

In the same location is a standard, auxiliary 120-amp power connection that consists of three 20-amp fused battery feeds and three 20-amp fused ignition feeds.

Easy Path Wiring Grommet

Both Charger and Magnum are equipped with a unique Easy Path Wiring Grommet in the engine bulkhead. It makes wiring easier for upfitters and the flexible cone can be adjusted to the amount of wiring passing through, thus providing a tight seal to prevent moisture from entering the cabin.

Wigwags

Completing our list of best-in-class interior features are the standard integrated headlamp and taillamp flashers, or wigwags. This police vehicle first — direct from an automotive manufacturer — provides a single connection that helps reduce the amount of time an upfitter would spend installing the wigwags. The wigwags must be activated by the upfitter.



Dodge Charger and Magnum:
Standard and Optional Police Equipment

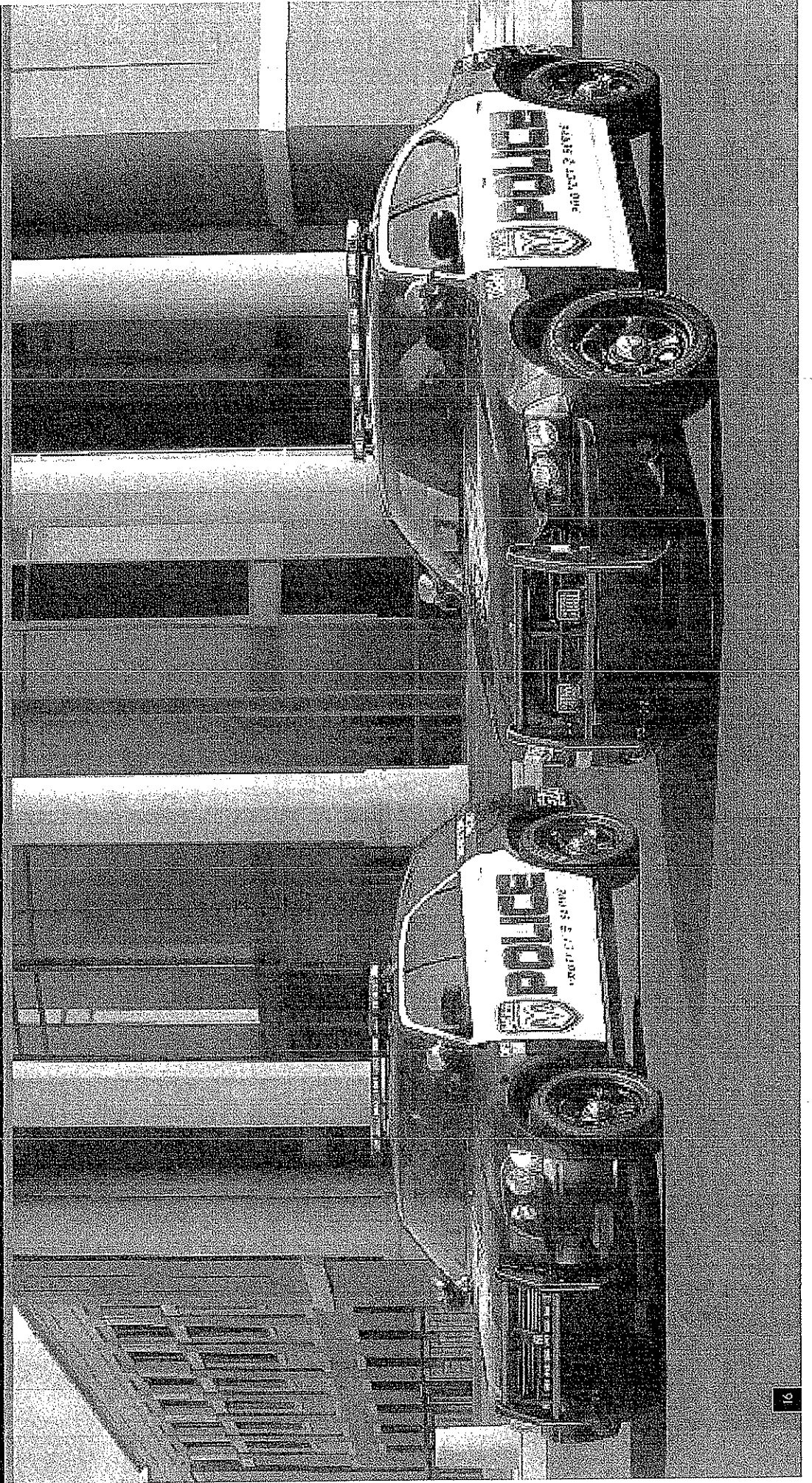

STANDARD POLICE EQUIPMENT

- 160-amp high-output alternator
- 160-mph or 260-km/h (certified) calibrated speedometer
- 18x7.5-inch steel wheels
- 3.5-liter High Output V6 engine with 250 hp @ 6,400 rpm and 250 lb-ft of torque @ 3,800 rpm
- 800 CCA battery
- AM/FM radio with CD player, changer controls, four speakers, and clock with auxiliary audio input jack
- Bright hubcaps
- Easy Path Wiring Grommet between underhood and passenger compartments
- External oil coolers: engine oil, transmission fluid, power steering fluid
- Five-speed automatic transmission with overdrive and AutoStick®
- Four-wheel disc heavy-duty antilock brakes with all-speed traction control
- Four-wheel independent performance suspension
- Heavy-duty cloth front bucket seats with manual lumbar and rear fixed cloth bench seat
- Fixed vinyl rear bench seat (Magnum)
- Instrument panel-mounted shift lever
- Load-leveling, height-control shock absorbers
- P225/60R18 BSW V-rated performance tires
- Police Equipment Mounting Bracket
- Police Performance Electronic Stability Program (ESP)⁽¹⁾ with Brake Assist and all-speed traction control
- Police performance-tuned steering
- Trunk-lid/rear liftgate key lock cylinder (Charger/Magnum)

STANDARD POLICE EQUIPMENT (CONT.)

- Security alarm system⁽²⁾
 - Separate key and key fob
 - Severe-duty cooling system
- #### STANDARD POLICE ELECTRICAL EQUIPMENT
- Center instrument panel stack power connector with three 20-amp-fused battery feeds and three 20-amp-fused ignition feeds
 - Dome lamp door switch deactivated
 - Dual Spot Lamp Prep Package
 - Integrated engine hour meter
 - Police equipment interface module
 - Separate fuses for left and right battery-fed spot lamps
 - Software-controlled alternating head- and taillamps (wigwag)
 - Stealth mode switch (turns off instrument cluster and radio indicators; PRNDL dims to lowest legal limit)
 - Three pairs of twisted 18-gauge wiring for sirens, speakers or controls provided from interior to front bumper
 - Underhood lamp

OPTIONAL POLICE EQUIPMENT

- 18-inch bolt-on wheel covers
- 5.7-liter HEMI® V8 with Multi-Displacement System and 340 hp @ 5,000 rpm and 390 lb-ft of torque @ 4,000 rpm
- Daytime running lamps
- Easy-clean black vinyl floor covering
- Emergency rear door lock override
- Engine block heater

OPTIONAL POLICE EQUIPMENT (CONT.)

- Entire fleet keyed alike (without alarm)
- Fixed vinyl rear bench seat (Charger)
- Front-door bodyside molding delete
- Full-size spare tire and wheel with battery cover or cargo compartment floor mat
- Independently switched red/white LED dome lamp
- Power eight-way driver's seat
- Rear inside door locks and handles deactivated
- Rear windows inoperative from rear seat
- Supplemental side-curtain air bags,⁽³⁾ front and rear passenger⁽⁴⁾
- Spot lamp, driver's side or dual (Black or Chrome)

CHARGER AND MAGNUM POLICE

MODELS INCLUDE:

- Air Bags⁽⁵⁾ — Advanced multistage driver and front-passenger air bags
- Air Conditioning — Manual
- Brake-Park Interlock — Driver must apply brake before shifting from Park
- Defroster — Electric, rear window
- Gauges — 160-mph speedometer, tachometer, odometer, trip odometer, fuel level and coolant temperature, outside temperature
- Indicators (up to 18 depending on equipment) — Warning lamps for low oil pressure, charging system, low fuel and low washer fluid, seat belt reminder, door/trunk ajar, cruise, brake system, headlamp high beam, turn signals, engine and air bag

CHARGER AND MAGNUM POLICE

MODELS INCLUDE: (CONT.)

- Instrument Cluster
- Keyless Entry/Illuminated Entry
- Lighting
 - Exterior — Quad halogen headlamps with automatic off feature, taillamps and center high-mounted stoplamp
 - Interior — Dual front map lamps, trunk lamp
- Mirrors
 - Exterior — Dual, power
 - Interior — Day/night center rearview
- Seat Belts
 - Front — Height-adjustable, outboard shoulder belts, three-point
 - Rear — Non-height-adjustable shoulder belts, three-point
- Speed Control
- Steering Column — Tilt
- Windows — Power with driver's one-touch-down feature
- Windshield Wipers — Two-speed with variable intermittent modes

⁽¹⁾ No system, no matter how sophisticated, can repeal the laws of physics or overcome careless driving actions. Performance is limited by available traction, which snow, ice and other conditions can affect. When the ESP warning light in the speedometer flashes, the driver needs to use less throttle and adapt speed and driving behavior to prevailing road conditions. Always drive carefully, consistent with conditions. Please always wear your seat belt.

⁽²⁾ Not available with key alike.

⁽³⁾ Always use seat belts. Remember, a backseat is the safest place for children 12 and under.

⁽⁴⁾ May not be compatible with some aftermarket equipment.

Dodge Charger and Magnum: Dimensions/Specifications/Colors

DIMENSIONS⁽¹⁾/SPECIFICATIONS

Exterior	Charger	Magnum
Wheelbase	120.0	120.0
Overall Length	200.1	197.7
Overall Height	58.2	58.3
Overall Width	74.5	74.1
Front Track	63.0	63.0
Rear Track	63.1	63.1
Turning Diameter (ft)	38.9	38.9
Interior		
Head Room (Front/Rear)	38.7/36.2	38.7/38.1
Leg Room (Front/Rear)	41.8/40.2	41.8/40.2
Shoulder Room (Front/Rear)	59.3/57.6	58.7/57.6
Hip Room (Front/Rear)	56.2/55.5	56.2/55.5
SAE Volume (cu ft)	104.0	105.9
EPA Volume Index (cu ft)	120.2	133.1
Seating Capacity	5	5
Trunk Capacity (cu ft)	16.2	
Cargo Capacity (cu ft)		
— Rear Seat Up		27.2
— Rear Seat Folded		71.6
Curb Weight (lb, estimated)	3,946	4,027
Fuel Tank Capacity (U.S. gal)	19	19

⁽¹⁾ Inches unless otherwise specified.

EXTERIOR COLORS

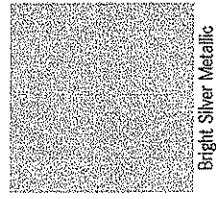

Bright Silver Metallic



Inferno Red Crystal Pearl

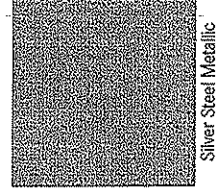

Silver Steel Metallic

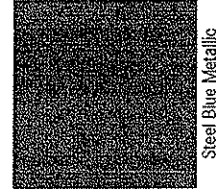

Steel Blue Metallic

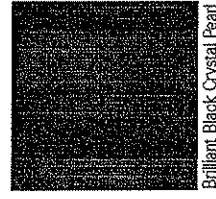

Brilliant Black Crystal Pearl

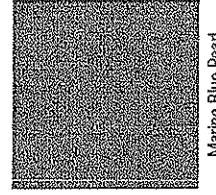

Marine Blue Pearl

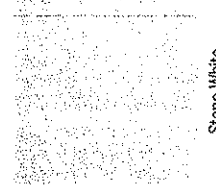

Stone White

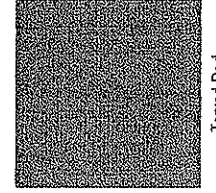

Torred Red

SPECIAL PRODUCTION PAINT COLORS

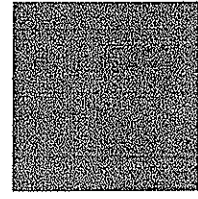

MS Blue, PY8999

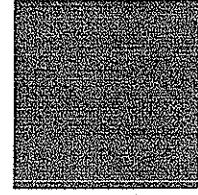

Forest Green, PY9324

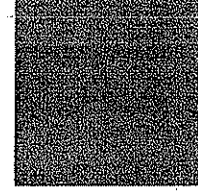

Navy Blue, PY9326



Cream, PY6672



State of West Virginia
 Department of Administration
 Purchasing Division
 2019 Washington Street East
 Post Office Box 50130
 Charleston, WV 25305-0130

Purchase Order

PURCHASE ORDER NO.
PC07B

PAGE

BLANKET RELEASE
00

CORRECT PURCHASE ORDER NUMBER MUST APPEAR ON ALL PACKAGES, INVOICES, AND SHIPPING PAPERS. QUESTIONS CONCERNING THIS PURCHASE ORDER SHOULD BE DIRECTED TO THE BUYER AS NOTED BELOW.

CHANGE ORDER

REPRINT NUMBER
1

SEE REVERSE SIDE FOR TERMS AND CONDITIONS

INVOICE TO

ALL STATE AGENCIES
 AND POLITICAL SUBDIVISIONS
 VARIOUS LOCALES AS INDICATED
 BY ORDER

VENDOR

*709044554 304-624-7611
 COUNTRY CLUB CHRYSLER DODGE SP
 PO BOX 2321
 ROUTE 19 SOUTH
 CLARKSBURG WV 26301

SHIP TO

ALL STATE AGENCIES
 AND POLITICAL SUBDIVISIONS
 VARIOUS LOCALES AS INDICATED
 BY ORDER

DATE PRINTED		TERMS OF SALE		FEIN/SSN		FUND	
10/25/2006		NET 30		550567749			
SHIP VIA		F.O.B		FREIGHT TERMS		ACCOUNT NUMBER	
BEST WAY		DESTINATION		PREPAID		MUL-MUL	
LINE	QUANTITY	UOP	VENDOR ITEM NO.		UNIT PRICE		AMOUNT
	DELIVERY DATE	CAT. NO.	ITEM NUMBER				
			RECEIPT TICKET FOR PURCHASE ORDER:				PC07B
LINE	CATNO	ITEM	NUMBER		DESCRIPTION		QTY DATE
0001	070-06	-99-003	2007 OR CURRENT MODEL YEAR DODGE		DU		_____
0002	070-06	-99-002	2007 OR CURRENT MODEL YEAR DODGE		CH		_____
			SIGNATURE _____		DATE _____		

IF APPROVAL AS TO FORM IS REQUIRED BY ATTORNEY GENERAL, CHECK HERE

TOTAL

APPROVED AS TO FORM BY
 ASSISTANT ATTORNEY GENERAL

BY _____
 PURCHASING DIVISION AUTHORIZED SIGNATURE