



State of West Virginia
 Department of Administration
 Purchasing Division
 2019 Washington Street East
 Post Office Box 50130
 Charleston, WV 25305-0130

Solicitation

NUMBER
6613C031

PAGE
1

ADDRESS CORRESPONDENCE TO ATTENTION OF:
ALAN CUMMINGS 804-558-2402

RFQ COPY
 TYPE NAME/ADDRESS HERE

V
E
N
D
O
R

DIVISION OF HIGHWAYS
 VARIOUS LOCALES AS INDICATED
 BY ORDER

S
H
I
P
T
O

DATE PRINTED
04/26/2013

BID OPENING DATE: 05/22/2013 BID OPENING TIME 1:30PM

LINE	QUANTITY	UOP	CAT. NO.	ITEM NUMBER	UNIT PRICE	AMOUNT
0001	1	EA		570-28		
CABLE GUARDRAIL REPLACEMENT PARTS						
REQUEST FOR QUOTATION (OPEN-END CONTRACT)						
THE WEST VIRGINIA STATE PURCHASING DIVISION FOR THE AGENCY, THE WEST VIRGINIA DIVISION OF HIGHWAYS, IS SOLICITING BIDS TO PROVIDE THE AGENCY WITH AN OPEN-END CONTRACT FOR CABLE GUARDRAIL PARTS PER THE ATTACHED SPECIFICATIONS.						
***** THIS IS THE END OF RFQ 6613C031 ***** TOTAL:						

SIGNATURE		TELEPHONE	DATE
TITLE	FEIN	ADDRESS CHANGES TO BE NOTED ABOVE	

WHEN RESPONDING TO SOLICITATION, INSERT NAME AND ADDRESS IN SPACE ABOVE LABELED 'VENDOR'

INSTRUCTIONS TO VENDORS SUBMITTING BIDS

1. **REVIEW DOCUMENTS THOROUGHLY:** The attached documents contain a solicitation for bids. Please read these instructions and all documents attached in their entirety. These instructions provide critical information about requirements that if overlooked could lead to disqualification of a Vendor's bid. All bids must be submitted in accordance with the provisions contained in these instructions and the Solicitation. Failure to do so may result in disqualification of Vendor's bid.
2. **MANDATORY TERMS:** The Solicitation may contain mandatory provisions identified by the use of the words "must," "will," and "shall." Failure to comply with a mandatory term in the Solicitation will result in bid disqualification.
3. **PREBID MEETING:** The item identified below shall apply to this Solicitation.

A pre-bid meeting will not be held prior to bid opening.

A **NON-MANDATORY PRE-BID** meeting will be held at the following place and time:

A **MANDATORY PRE-BID** meeting will be held at the following place and time:

All Vendors submitting a bid must attend the mandatory pre-bid meeting. Failure to attend the mandatory pre-bid meeting shall result in disqualification of the Vendor's bid. No one person attending the pre-bid meeting may represent more than one Vendor.

An attendance sheet provided at the pre-bid meeting shall serve as the official document verifying attendance. The State will not accept any other form of proof or documentation to verify attendance. Any person attending the pre-bid meeting on behalf of a Vendor must list on the attendance sheet his or her name and the name of the Vendor he or she is representing. Additionally, the person attending the pre-bid meeting should include the Vendor's E-Mail address, phone number, and Fax number on the attendance sheet. It is the Vendor's responsibility to locate the attendance sheet and provide the required

information. Failure to complete the attendance sheet as required may result in disqualification of Vendor's bid.

All Vendors should arrive prior to the starting time for the pre-bid. Vendors who arrive after the starting time but prior to the end of the pre-bid will be permitted to sign in, but are charged with knowing all matters discussed at the pre-bid.

Questions submitted at least five business days prior to a scheduled pre-bid will be discussed at the pre-bid meeting if possible. Any discussions or answers to questions at the pre-bid meeting are preliminary in nature and are non-binding. Official and binding answers to questions will be published in a written addendum to the Solicitation prior to bid opening.

4. **VENDOR QUESTION DEADLINE:** Vendors may submit questions relating to this Solicitation to the Purchasing Division. Questions must be submitted in writing. All questions must be submitted on or before the date listed below and to the address listed below in order to be considered. A written response will be published in a Solicitation addendum if a response is possible and appropriate. Non-written discussions, conversations, or questions and answers regarding this Solicitation are preliminary in nature and are non-binding.

Question Submission Deadline: 05/14/2013

Submit Questions to:

Alan Cummings

2019 Washington Street, East

P.O. Box 50130

Charleston, WV 25305

Fax: 304-558-3970

Email: Alan.W.Cummings@WV.Gov

5. **VERBAL COMMUNICATION:** Any verbal communication between the Vendor and any State personnel is not binding, including that made at the mandatory pre-bid conference. Only information issued in writing and added to the Solicitation by an official written addendum by the Purchasing Division is binding.
6. **BID SUBMISSION:** All bids must be signed and delivered by the Vendor to the Purchasing Division at the address listed below on or before the date and time of the bid opening. Any bid received by the Purchasing Division staff is considered to be in the possession of the Purchasing Division and will not be returned for any reason. The bid delivery address is:

Department of Administration, Purchasing Division
2019 Washington Street East
P.O. Box 50130,
Charleston, WV 25305-0130

The bid should contain the information listed below on the face of the envelope or the bid may not be considered:

SEALED BID

BUYER: _____
SOLICITATION NO.: _____
BID OPENING DATE: _____
BID OPENING TIME: _____
FAX NUMBER: _____

In the event that Vendor is responding to a request for proposal, the Vendor shall submit one original technical and one original cost proposal plus n/a convenience copies of each to the Purchasing Division at the address shown above. Additionally, the Vendor should identify the bid type as either a technical or cost proposal on the face of each bid envelope submitted in response to a request for proposal as follows:

BID TYPE: Technical
 Cost

- 7. **BID OPENING:** Bids submitted in response to this Solicitation will be opened at the location identified below on the date and time listed below. Delivery of a bid after the bid opening date and time will result in bid disqualification. For purposes of this Solicitation, a bid is considered delivered when time stamped by the official Purchasing Division time clock.

Bid Opening Date and Time:

05/22/2013 - 1:30 P.M.

Bid Opening Location:

Department of Administration, Purchasing Division
2019 Washington Street East
P.O. Box 50130,
Charleston, WV 25305-0130

- 8. **ADDENDUM ACKNOWLEDGEMENT:** Changes or revisions to this Solicitation will be made by an official written addendum issued by the Purchasing Division. Vendor should acknowledge receipt of all addenda issued with this Solicitation by completing an Addendum Acknowledgment Form, a copy of which is included herewith. Failure to acknowledge addenda may result in bid disqualification. The addendum acknowledgement should be submitted with the bid to expedite document processing.
- 9. **BID FORMATTING:** Vendor should type or electronically enter the information onto its bid to prevent errors in the evaluation. Failure to type or electronically enter the information may result in bid disqualification.

GENERAL TERMS AND CONDITIONS:

1. **CONTRACTUAL AGREEMENT:** Issuance of a Purchase Order signed by the Purchasing Division Director, or his designee, and approved as to form by the Attorney General's office constitutes acceptance of this Contract made by and between the State of West Virginia and the Vendor. Vendor's signature on its bid signifies Vendor's agreement to be bound by and accept the terms and conditions contained in this Contract.

2. **DEFINITIONS:** As used in this Solicitation / Contract, the following terms shall have the meanings attributed to them below. Additional definitions may be found in the specifications included with this Solicitation / Contract.
 - 2.1 **"Agency" or "Agencies"** means the agency, board, commission, or other entity of the State of West Virginia that is identified on the first page of the Solicitation or any other public entity seeking to procure goods or services under this Contract.
 - 2.2 **"Contract"** means the binding agreement that is entered into between the State and the Vendor to provide the goods and services requested in the Solicitation.
 - 2.3 **"Director"** means the Director of the West Virginia Department of Administration, Purchasing Division.
 - 2.4 **"Purchasing Division"** means the West Virginia Department of Administration, Purchasing Division.
 - 2.5 **"Purchase Order"** means the document signed by the Agency and the Purchasing Division, and approved as to form by the Attorney General, that identifies the Vendor as the successful bidder and Contract holder.
 - 2.6 **"Solicitation"** means the official solicitation published by the Purchasing Division and identified by number on the first page thereof.
 - 2.7 **"State"** means the State of West Virginia and/or any of its agencies, commissions, boards, etc. as context requires.
 - 2.8 **"Vendor" or "Vendors"** means any entity submitting a bid in response to the Solicitation, the entity that has been selected as the lowest responsible bidder, or the entity that has been awarded the Contract as context requires.

3. **CONTRACT TERM; RENEWAL; EXTENSION:** The term of this Contract shall be determined in accordance with the category that has been identified as applicable to this Contract below:

Term Contract

Initial Contract Term: This Contract becomes effective on

and extends for a period of year(s).

Renewal Term: This Contract may be renewed upon the mutual written consent of the Agency, and the Vendor, with approval of the Purchasing Division and the Attorney General's office (Attorney General approval is as to form only). Any request for renewal must be submitted to the Purchasing Division Director thirty (30) days prior to the expiration date of the initial contract term or appropriate renewal term. A Contract renewal shall be in accordance with the terms and conditions of the original contract. Renewal of this Contract is limited to successive one (1) year periods. Automatic renewal of this Contract is prohibited. Notwithstanding the foregoing, Purchasing Division approval is not required on agency delegated or exempt purchases. Attorney General approval may be required for vendor terms and conditions.

Reasonable Time Extension: At the sole discretion of the Purchasing Division Director, and with approval from the Attorney General's office (Attorney General approval is as to form only), this Contract may be extended for a reasonable time after the initial Contract term or after any renewal term as may be necessary to obtain a new contract or renew this Contract. Any reasonable time extension shall not exceed twelve (12) months. Vendor may avoid a reasonable time extension by providing the Purchasing Division Director with written notice of Vendor's desire to terminate this Contract 30 days prior to the expiration of the then current term. During any reasonable time extension period, the Vendor may terminate this Contract for any reason upon giving the Purchasing Division Director 30 days written notice. Automatic extension of this Contract is prohibited. Notwithstanding the foregoing, Purchasing Division approval is not required on agency delegated or exempt purchases, but Attorney General approval may be required.

Fixed Period Contract: This Contract becomes effective upon Vendor's receipt of the notice to proceed and must be completed within days.

One Time Purchase: The term of this Contract shall run from the issuance of the Purchase Order until all of the goods contracted for have been delivered, but in no event shall this Contract extend for more than one fiscal year.

Other: See attached.

4. **NOTICE TO PROCEED:** Vendor shall begin performance of this Contract immediately upon receiving notice to proceed unless otherwise instructed by the Agency. Unless otherwise specified, the fully executed Purchase Order will be considered notice to proceed
5. **QUANTITIES:** The quantities required under this Contract shall be determined in accordance with the category that has been identified as applicable to this Contract below.
- Open End Contract:** Quantities listed in this Solicitation are approximations only, based on estimates supplied by the Agency. It is understood and agreed that the Contract shall cover the quantities actually ordered for delivery during the term of the Contract, whether more or less than the quantities shown.
- Service:** The scope of the service to be provided will be more clearly defined in the specifications included herewith.
- Combined Service and Goods:** The scope of the service and deliverable goods to be provided will be more clearly defined in the specifications included herewith.
- One Time Purchase:** This Contract is for the purchase of a set quantity of goods that are identified in the specifications included herewith. Once those items have been delivered, no additional goods may be procured under this Contract without an appropriate change order approved by the Vendor, Agency, Purchasing Division, and Attorney General's office.
6. **PRICING:** The pricing set forth herein is firm for the life of the Contract, unless specified elsewhere within this Solicitation/Contract by the State. A Vendor's inclusion of price adjustment provisions in its bid, without an express authorization from the State in the Solicitation to do so, may result in bid disqualification.
7. **EMERGENCY PURCHASES:** The Purchasing Division Director may authorize the Agency to purchase goods or services in the open market that Vendor would otherwise provide under this Contract if those goods or services are for immediate or expedited delivery in an emergency. Emergencies shall include, but are not limited to, delays in transportation or an unanticipated increase in the volume of work. An emergency purchase in the open market, approved by the Purchasing Division Director, shall not constitute of breach of this Contract and shall not entitle the Vendor to any form of compensation or damages. This provision does not excuse the State from fulfilling its obligations under a One Time Purchase contract.
8. **REQUIRED DOCUMENTS:** All of the items checked below must be provided to the Purchasing Division by the Vendor as specified below.
- BID BOND:** All Vendors shall furnish a bid bond in the amount of five percent (5%) of the total amount of the bid protecting the State of West Virginia. The bid bond must be submitted with the bid.

[] **PERFORMANCE BOND:** The apparent successful Vendor shall provide a performance bond in the amount of []. The performance bond must be issued and received by the Purchasing Division prior to Contract award. On construction contracts, the performance bond must be 100% of the Contract value.

[] **LABOR/MATERIAL PAYMENT BOND:** The apparent successful Vendor shall provide a labor/material payment bond in the amount of 100% of the Contract value. The labor/material payment bond must be issued and delivered to the Purchasing Division prior to Contract award.

In lieu of the Bid Bond, Performance Bond, and Labor/Material Payment Bond, the Vendor may provide certified checks, cashier's checks, or irrevocable letters of credit. Any certified check, cashier's check, or irrevocable letter of credit provided in lieu of a bond must be of the same amount and delivered on the same schedule as the bond it replaces. A letter of credit submitted in lieu of a performance and labor/material payment bond will only be allowed for projects under \$100,000. Personal or business checks are not acceptable.

[] **MAINTENANCE BOND:** The apparent successful Vendor shall provide a two (2) year maintenance bond covering the roofing system. The maintenance bond must be issued and delivered to the Purchasing Division prior to Contract award.

[] **WORKERS' COMPENSATION INSURANCE:** The apparent successful Vendor shall have appropriate workers' compensation insurance and shall provide proof thereof upon request.

[] **INSURANCE:** The apparent successful Vendor shall furnish proof of the following insurance prior to Contract award:

[] **Commercial General Liability Insurance:**
[] or more.

[] **Builders Risk Insurance:** builders risk – all risk insurance in an amount equal to 100% of the amount of the Contract.

[] []

[] []

[] []

[] []

[] []

The apparent successful Vendor shall also furnish proof of any additional insurance requirements contained in the specifications prior to Contract award regardless of whether or not that insurance requirement is listed above.

[] **LICENSE(S) / CERTIFICATIONS / PERMITS:** In addition to anything required under the Section entitled Licensing, of the General Terms and Conditions, the apparent successful Vendor shall furnish proof of the following licenses, certifications, and/or permits prior to Contract award, in a form acceptable to the Purchasing Division.

[]

[]

[]

[]

The apparent successful Vendor shall also furnish proof of any additional licenses or certifications contained in the specifications prior to Contract award regardless of whether or not that requirement is listed above.

9. **LITIGATION BOND:** The Director reserves the right to require any Vendor that files a protest of an award to submit a litigation bond in the amount equal to one percent of the lowest bid submitted or \$5,000, whichever is greater. The entire amount of the bond shall be forfeited if the hearing officer determines that the protest was filed for frivolous or improper purpose, including but not limited to, the purpose of harassing, causing unnecessary delay, or needless expense for the Agency. All litigation bonds shall be made payable to the Purchasing Division. In lieu of a bond, the protester may submit a cashier's check or certified check payable to the Purchasing Division. Cashier's or certified checks will be deposited with and held by the State Treasurer's office. If it is determined that the protest has not been filed for frivolous or improper purpose, the bond or deposit shall be returned in its entirety.

10. **ALTERNATES:** Any model, brand, or specification listed herein establishes the acceptable level of quality only and is not intended to reflect a preference for, or in any way favor, a particular brand or vendor. Vendors may bid alternates to a listed model or brand provided that the alternate is at least equal to the model or brand and complies with the required specifications. The equality of any alternate being bid shall be determined by the State at its sole discretion. Any Vendor bidding an alternate model or brand should clearly identify the alternate items in its bid and should include manufacturer's specifications, industry literature, and/or any other relevant documentation demonstrating the equality of the alternate items. Failure to provide information for alternate items may be grounds for rejection of a Vendor's bid.

11. **EXCEPTIONS AND CLARIFICATIONS:** The Solicitation contains the specifications that shall form the basis of a contractual agreement. Vendor shall clearly mark any exceptions, clarifications, or

other proposed modifications in its bid. Exceptions to, clarifications of, or modifications of a requirement or term and condition of the Solicitation may result in bid disqualification.

12. LIQUIDATED DAMAGES: Vendor shall pay liquidated damages in the amount

n/a	for	n/a

This clause shall in no way be considered exclusive and shall not limit the State or Agency's right to pursue any other available remedy.

- 13. ACCEPTANCE/REJECTION:** The State may accept or reject any bid in whole, or in part. Vendor's signature on its bid signifies acceptance of the terms and conditions contained in the Solicitation and Vendor agrees to be bound by the terms of the Contract, as reflected in the Purchase Order, upon receipt.
- 14. REGISTRATION:** Prior to Contract award, the apparent successful Vendor must be properly registered with the West Virginia Purchasing Division and must have paid the \$125 fee if applicable.
- 15. COMMUNICATION LIMITATIONS:** In accordance with West Virginia Code of State Rules §148-1-6.6, communication with the State of West Virginia or any of its employees regarding this Solicitation during the solicitation, bid, evaluation or award periods, except through the Purchasing Division, is strictly prohibited without prior Purchasing Division approval. Purchasing Division approval for such communication is implied for all agency delegated and exempt purchases.
- 16. FUNDING:** This Contract shall continue for the term stated herein, contingent upon funds being appropriated by the Legislature or otherwise being made available. In the event funds are not appropriated or otherwise made available, this Contract becomes void and of no effect beginning on July 1 of the fiscal year for which funding has not been appropriated or otherwise made available.
- 17. PAYMENT:** Payment in advance is prohibited under this Contract. Payment may only be made after the delivery and acceptance of goods or services. The Vendor shall submit invoices, in arrears, to the Agency at the address on the face of the purchase order labeled "Invoice To."
- 18. UNIT PRICE:** Unit prices shall prevail in cases of a discrepancy in the Vendor's bid.
- 19. DELIVERY:** All quotations are considered freight on board destination ("F.O.B. destination") unless alternate shipping terms are clearly identified in the bid. Vendor's listing of shipping terms that contradict the shipping terms expressly required by this Solicitation may result in bid disqualification.
- 20. INTEREST:** Interest attributable to late payment will only be permitted if authorized by the West Virginia Code. Presently, there is no provision in the law for interest on late payments.
- 21. PREFERENCE:** Vendor Preference may only be granted upon written request and only in accordance with the West Virginia Code § 5A-3-37 and the West Virginia Code of State Rules. A Resident Vendor Certification form has been attached hereto to allow Vendor to apply for the preference. Vendor's

failure to submit the Resident Vendor Certification form with its bid will result in denial of Vendor Preference. Vendor Preference does not apply to construction projects.

- 22. SMALL, WOMEN-OWNED, OR MINORITY-OWNED BUSINESSES:** For any solicitations publicly advertised for bid on or after July 1, 2012, in accordance with West Virginia Code §5A-3-37(a)(7) and W. Va. CSR § 148-22-9, any non-resident vendor certified as a small, women-owned, or minority-owned business under W. Va. CSR § 148-22-9 shall be provided the same preference made available to any resident vendor. Any non-resident small, women-owned, or minority-owned business must identify itself as such in writing, must submit that writing to the Purchasing Division with its bid, and must be properly certified under W. Va. CSR § 148-22-9 prior to submission of its bid to receive the preferences made available to resident vendors. Preference for a non-resident small, women-owned, or minority owned business shall be applied in accordance with W. Va. CSR § 148-22-9.
- 23. TAXES:** The Vendor shall pay any applicable sales, use, personal property or any other taxes arising out of this Contract and the transactions contemplated thereby. The State of West Virginia is exempt from federal and state taxes and will not pay or reimburse such taxes.
- 24. CANCELLATION:** The Purchasing Division Director reserves the right to cancel this Contract immediately upon written notice to the vendor if the materials or workmanship supplied do not conform to the specifications contained in the Contract. The Purchasing Division Director may cancel any purchase or Contract upon 30 days written notice to the Vendor in accordance with West Virginia Code of State Rules § 148-1-7.16.2.
- 25. WAIVER OF MINOR IRREGULARITIES:** The Director reserves the right to waive minor irregularities in bids or specifications in accordance with West Virginia Code of State Rules § 148-1-4.6.
- 26. TIME:** Time is of the essence with regard to all matters of time and performance in this Contract.
- 27. APPLICABLE LAW:** This Contract is governed by and interpreted under West Virginia law without giving effect to its choice of law principles. Any information provided in specification manuals, or any other source, verbal or written, which contradicts or violates the West Virginia Constitution, West Virginia Code or West Virginia Code of State Rules is void and of no effect.
- 28. COMPLIANCE:** Vendor shall comply with all applicable federal, state, and local laws, regulations and ordinances. By submitting a bid, Vendors acknowledge that they have reviewed, understand, and will comply with all applicable law.
- 29. PREVAILING WAGE:** On any contract for the construction of a public improvement, Vendor and any subcontractors utilized by Vendor shall pay a rate or rates of wages which shall not be less than the fair minimum rate or rates of wages (prevailing wage), as established by the West Virginia Division of Labor under West Virginia Code §§ 21-5A-1 et seq. and available at <http://www.sos.wv.gov/administrative-law/wagerates/Pages/default.aspx>. Vendor shall be responsible for ensuring compliance with prevailing wage requirements and determining when prevailing wage

requirements are applicable. The required contract provisions contained in West Virginia Code of State Rules § 42-7-3 are specifically incorporated herein by reference.

- 30. ARBITRATION:** Any references made to arbitration contained in this Contract, Vendor's bid, or in any American Institute of Architects documents pertaining to this Contract are hereby deleted, void, and of no effect.
- 31. MODIFICATIONS:** This writing is the parties' final expression of intent. Notwithstanding anything contained in this Contract to the contrary, no modification of this Contract shall be binding without mutual written consent of the Agency, and the Vendor, with approval of the Purchasing Division and the Attorney General's office (Attorney General approval is as to form only). **No Change shall be implemented by the Vendor until such time as the Vendor receives an approved written change order from the Purchasing Division.**
- 32. WAIVER:** The failure of either party to insist upon a strict performance of any of the terms or provision of this Contract, or to exercise any option, right, or remedy herein contained, shall not be construed as a waiver or a relinquishment for the future of such term, provision, option, right, or remedy, but the same shall continue in full force and effect. Any waiver must be expressly stated in writing and signed by the waiving party.
- 33. SUBSEQUENT FORMS:** The terms and conditions contained in this Contract shall supersede any and all subsequent terms and conditions which may appear on any form documents submitted by Vendor to the Agency or Purchasing Division such as price lists, order forms, invoices, sales agreements, or maintenance agreements, and includes internet websites or other electronic documents. Acceptance or use of Vendor's forms does not constitute acceptance of the terms and conditions contained thereon.
- 34. ASSIGNMENT:** Neither this Contract nor any monies due, or to become due hereunder, may be assigned by the Vendor without the express written consent of the Agency, the Purchasing Division, the Attorney General's office (as to form only), and any other government agency or office that may be required to approve such assignments. Notwithstanding the foregoing, Purchasing Division approval may or may not be required on certain agency delegated or exempt purchases.
- 35. WARRANTY:** The Vendor expressly warrants that the goods and/or services covered by this Contract will: (a) conform to the specifications, drawings, samples, or other description furnished or specified by the Agency; (b) be merchantable and fit for the purpose intended; and (c) be free from defect in material and workmanship.
- 36. STATE EMPLOYEES:** State employees are not permitted to utilize this Contract for personal use and the Vendor is prohibited from permitting or facilitating the same.
- 37. BANKRUPTCY:** In the event the Vendor files for bankruptcy protection, the State of West Virginia may deem this Contract null and void, and terminate this Contract without notice.

- 38. HIPAA BUSINESS ASSOCIATE ADDENDUM:** The West Virginia State Government HIPAA Business Associate Addendum (BAA), approved by the Attorney General, is available online at <http://www.state.wv.us/admin/purchase/vrc/hipaa.html> and is hereby made part of the agreement provided that the Agency meets the definition of a Covered entity (45 CFR §160.103) and will be disclosing Protected Health Information (45 CFR §160.103) to the Vendor. Additionally, the HIPAA Privacy, Security, Enforcement & Breach Notification Final Omnibus Rule was published on January 25, 2013. It may be viewed online at <http://www.gpo.gov/fdsys/pkg/FR-2013-01-25/pdf/2013-01073.pdf>. Any organization, that qualifies as the Agency's Business Associate, is expected to be in compliance with this Final Rule. For those Business Associates entering into contracts with a HIPAA Covered State Agency between January 25, 2013 and the release of the 2013 WV State Agency Business Associate Agreement, or September 23, 2013 (whichever is earlier), be advised that you will be required to comply with the 2013 WV State Agency Business Associate Agreement. For those Business Associates with contracts with a HIPAA Covered State Agency executed prior to January 25, 2013, be advised that upon renewal or modification, you will be required to comply with the 2013 WV State Agency Business Associate Agreement no later than September 22, 2014.
- 39. CONFIDENTIALITY:** The Vendor agrees that it will not disclose to anyone, directly or indirectly, any such personally identifiable information or other confidential information gained from the Agency, unless the individual who is the subject of the information consents to the disclosure in writing or the disclosure is made pursuant to the Agency's policies, procedures, and rules. Vendor further agrees to comply with the Confidentiality Policies and Information Security Accountability Requirements, set forth in <http://www.state.wv.us/admin/purchase/privacy/default.html>.
- 40. DISCLOSURE:** Vendor's response to the Solicitation and the resulting Contract are considered public documents and will be disclosed to the public in accordance with the laws, rules, and policies governing the West Virginia Purchasing Division. Those laws include, but are not limited to, the Freedom of Information Act found in West Virginia Code § 29B-1-1 et seq.

If a Vendor considers any part of its bid to be exempt from public disclosure, Vendor must so indicate by specifically identifying the exempt information, identifying the exemption that applies, providing a detailed justification for the exemption, segregating the exempt information from the general bid information, and submitting the exempt information as part of its bid but in a segregated and clearly identifiable format. Failure to comply with the foregoing requirements will result in public disclosure of the Vendor's bid without further notice. A Vendor's act of marking all or nearly all of its bid as exempt is not sufficient to avoid disclosure and WILL NOT BE HONORED. Vendor's act of marking a bid or any part thereof as "confidential" or "proprietary" is not sufficient to avoid disclosure and WILL NOT BE HONORED. In addition, a legend or other statement indicating that all or substantially all of the bid is exempt from disclosure is not sufficient to avoid disclosure and WILL NOT BE HONORED. Vendor will be required to defend any claimed exemption for nondisclosure in the event of an administrative or judicial challenge to the State's nondisclosure. Vendor must indemnify the State for any costs incurred related to any exemptions claimed by Vendor. Any questions regarding the applicability of the various public records laws should be addressed to your own legal counsel prior to bid submission.

- 41. LICENSING:** In accordance with West Virginia Code of State Rules §148-1-6.1.7, Vendor must be licensed and in good standing in accordance with any and all state and local laws and requirements by any state or local agency of West Virginia, including, but not limited to, the West Virginia Secretary of State's Office, the West Virginia Tax Department, West Virginia Insurance Commission, or any other state agency or political subdivision. Upon request, the Vendor must provide all necessary releases to obtain information to enable the Purchasing Division Director or the Agency to verify that the Vendor is licensed and in good standing with the above entities.
- 42. ANTITRUST:** In submitting a bid to, signing a contract with, or accepting a Purchase Order from any agency of the State of West Virginia, the Vendor agrees to convey, sell, assign, or transfer to the State of West Virginia all rights, title, and interest in and to all causes of action it may now or hereafter acquire under the antitrust laws of the United States and the State of West Virginia for price fixing and/or unreasonable restraints of trade relating to the particular commodities or services purchased or acquired by the State of West Virginia. Such assignment shall be made and become effective at the time the purchasing agency tenders the initial payment to Vendor.
- 43. VENDOR CERTIFICATIONS:** By signing its bid or entering into this Contract, Vendor certifies (1) that its bid was made without prior understanding, agreement, or connection with any corporation, firm, limited liability company, partnership, person or entity submitting a bid for the same material, supplies, equipment or services; (2) that its bid is in all respects fair and without collusion or fraud; (3) that this Contract is accepted or entered into without any prior understanding, agreement, or connection to any other entity that could be considered a violation of law; and (4) that it has reviewed this RFQ in its entirety; understands the requirements, terms and conditions, and other information contained herein. Vendor's signature on its bid also affirms that neither it nor its representatives have any interest, nor shall acquire any interest, direct or indirect, which would compromise the performance of its services hereunder. Any such interests shall be promptly presented in detail to the Agency.

The individual signing this bid on behalf of Vendor certifies that he or she is authorized by the Vendor to execute this bid or any documents related thereto on Vendor's behalf; that he or she is authorized to bind the Vendor in a contractual relationship; and that, to the best of his or her knowledge, the Vendor has properly registered with any State agency that may require registration.

- 44. PURCHASING CARD ACCEPTANCE:** The State of West Virginia currently utilizes a Purchasing Card program, administered under contract by a banking institution, to process payment for goods and services. The Vendor must accept the State of West Virginia's Purchasing Card for payment of all orders under this Contract unless the box below is checked.

Vendor is not required to accept the State of West Virginia's Purchasing Card as payment for all goods and services.

- 45. VENDOR RELATIONSHIP:** The relationship of the Vendor to the State shall be that of an independent contractor and no principal-agent relationship or employer-employee relationship is contemplated or created by this Contract. The Vendor as an independent contractor is solely liable for the acts and omissions of its employees and agents. Vendor shall be responsible for selecting,

supervising, and compensating any and all individuals employed pursuant to the terms of this Solicitation and resulting contract. Neither the Vendor, nor any employees or subcontractors of the Vendor, shall be deemed to be employees of the State for any purpose whatsoever. Vendor shall be exclusively responsible for payment of employees and contractors for all wages and salaries, taxes, withholding payments, penalties, fees, fringe benefits, professional liability insurance premiums, contributions to insurance and pension, or other deferred compensation plans, including but not limited to, Workers' Compensation and Social Security obligations, licensing fees, *etc.* and the filing of all necessary documents, forms and returns pertinent to all of the foregoing. Vendor shall hold harmless the State, and shall provide the State and Agency with a defense against any and all claims including, but not limited to, the foregoing payments, withholdings, contributions, taxes, Social Security taxes, and employer income tax returns.

- 46. INDEMNIFICATION:** The Vendor agrees to indemnify, defend, and hold harmless the State and the Agency, their officers, and employees from and against: (1) Any claims or losses for services rendered by any subcontractor, person, or firm performing or supplying services, materials, or supplies in connection with the performance of the Contract; (2) Any claims or losses resulting to any person or entity injured or damaged by the Vendor, its officers, employees, or subcontractors by the publication, translation, reproduction, delivery, performance, use, or disposition of any data used under the Contract in a manner not authorized by the Contract, or by Federal or State statutes or regulations; and (3) Any failure of the Vendor, its officers, employees, or subcontractors to observe State and Federal laws including, but not limited to, labor and wage and hour laws.
- 47. PURCHASING AFFIDAVIT:** In accordance with West Virginia Code § 5A-3-10a, all Vendors are required to sign, notarize, and submit the Purchasing Affidavit stating that neither the Vendor nor a related party owe a debt to the State in excess of \$1,000. The affidavit must be submitted prior to award, but should be submitted with the Vendor's bid. A copy of the Purchasing Affidavit is included herewith.
- 48. ADDITIONAL AGENCY AND LOCAL GOVERNMENT USE:** This Contract may be utilized by and extends to other agencies, spending units, and political subdivisions of the State of West Virginia; county, municipal, and other local government bodies; and school districts ("Other Government Entities"). This Contract shall be extended to the aforementioned Other Government Entities on the same prices, terms, and conditions as those offered and agreed to in this Contract. If the Vendor does not wish to extend the prices, terms, and conditions of its bid and subsequent contract to the Other Government Entities, the Vendor must clearly indicate such refusal in its bid. A refusal to extend this Contract to the Other Government Entities shall not impact or influence the award of this Contract in any manner.
- 49. CONFLICT OF INTEREST:** Vendor, its officers or members or employees, shall not presently have or acquire any interest, direct or indirect, which would conflict with or compromise the performance of its obligations hereunder. Vendor shall periodically inquire of its officers, members and employees to ensure that a conflict of interest does not arise. Any conflict of interest discovered shall be promptly presented in detail to the Agency.

50. REPORTS: Vendor shall provide the Agency and/or the Purchasing Division with the following reports identified by a checked box below:

- Such reports as the Agency and/or the Purchasing Division may request. Requested reports may include, but are not limited to, quantities purchased, agencies utilizing the contract, total contract expenditures by agency, etc.
- Quarterly reports detailing the total quantity of purchases in units and dollars, along with a listing of purchases by agency. Quarterly reports should be delivered to the Purchasing Division via email at purchasing.requisitions@wv.gov.

51. BACKGROUND CHECK: In accordance with W. Va. Code § 15-2D-3, the Director of the Division of Protective Services shall require any service provider whose employees are regularly employed on the grounds or in the buildings of the Capitol complex or who have access to sensitive or critical information to submit to a fingerprint-based state and federal background inquiry through the state repository. The service provider is responsible for any costs associated with the fingerprint-based state and federal background inquiry.

After the contract for such services has been approved, but before any such employees are permitted to be on the grounds or in the buildings of the Capitol complex or have access to sensitive or critical information, the service provider shall submit a list of all persons who will be physically present and working at the Capitol complex to the Director of the Division of Protective Services for purposes of verifying compliance with this provision.

The State reserves the right to prohibit a service provider's employees from accessing sensitive or critical information or to be present at the Capitol complex based upon results addressed from a criminal background check.

Service providers should contact the West Virginia Division of Protective Services by phone at (304) 558-9911 for more information.

52. PREFERENCE FOR USE OF DOMESTIC STEEL PRODUCTS: Except when authorized by the Director of the Purchasing Division pursuant to W. Va. Code § 5A-3-56, no contractor may use or supply steel products for a State Contract Project other than those steel products made in the United States. A contractor who uses steel products in violation of this section may be subject to civil penalties pursuant to W. Va. Code § 5A-3-56. As used in this section:

- a. "State Contract Project" means any erection or construction of, or any addition to, alteration of or other improvement to any building or structure, including, but not limited to, roads or highways, or the installation of any heating or cooling or ventilating plants or other equipment, or the supply of and materials for such projects, pursuant to a contract with the State of West Virginia for which bids were solicited on or after June 6, 2001.
- b. "Steel Products" means products rolled, formed, shaped, drawn, extruded, forged, cast, fabricated or otherwise similarly processed, or processed by a combination of two or more or

such operations, from steel made by the open hearth, basic oxygen, electric furnace, Bessemer or other steel making process.

The Purchasing Division Director may, in writing, authorize the use of foreign steel products if:

- a. The cost for each contract item used does not exceed one tenth of one percent (.1%) of the total contract cost or two thousand five hundred dollars (\$2,500.00), whichever is greater. For the purposes of this section, the cost is the value of the steel product as delivered to the project; or
- b. The Director of the Purchasing Division determines that specified steel materials are not produced in the United States in sufficient quantity or otherwise are not reasonably available to meet contract requirements.

53. PREFERENCE FOR USE OF DOMESTIC ALUMINUM, GLASS, AND STEEL: In Accordance with W. Va. Code § 5-19-1 et seq., and W. Va. CSR § 148-10-1 et seq., for every contract or subcontract, subject to the limitations contained herein, for the construction, reconstruction, alteration, repair, improvement or maintenance of public works or for the purchase of any item of machinery or equipment to be used at sites of public works, only domestic aluminum, glass or steel products shall be supplied unless the spending officer determines, in writing, after the receipt of offers or bids, (1) that the cost of domestic aluminum, glass or steel products is unreasonable or inconsistent with the public interest of the State of West Virginia, (2) that domestic aluminum, glass or steel products are not produced in sufficient quantities to meet the contract requirements, or (3) the available domestic aluminum, glass, or steel do not meet the contract specifications. This provision only applies to public works contracts awarded in an amount more than fifty thousand dollars (\$50,000) or public works contracts that require more than ten thousand pounds of steel products.

The cost of domestic aluminum, glass, or steel products may be unreasonable if the cost is more than twenty percent (20%) of the bid or offered price for foreign made aluminum, glass, or steel products. If the domestic aluminum, glass or steel products to be supplied or produced in a “substantial labor surplus area”, as defined by the United States Department of Labor, the cost of domestic aluminum, glass, or steel products may be unreasonable if the cost is more than thirty percent (30%) of the bid or offered price for foreign made aluminum, glass, or steel products.

This preference shall be applied to an item of machinery or equipment, as indicated above, when the item is a single unit of equipment or machinery manufactured primarily of aluminum, glass or steel, is part of a public works contract and has the sole purpose or of being a permanent part of a single public works project. This provision does not apply to equipment or machinery purchased by a spending unit for use by that spending unit and not as part of a single public works project.

All bids and offers including domestic aluminum, glass or steel products that exceed bid or offer prices including foreign aluminum, glass or steel products after application of the preferences provided in this provision may be reduced to a price equal to or lower than the lowest bid or offer price for foreign aluminum, glass or steel products plus the applicable preference. If the reduced bid or offer prices are made in writing and supersede the prior bid or offer prices, all bids or offers, including the reduced bid or offer prices, will be reevaluated in accordance with this rule.

CERTIFICATION AND SIGNATURE PAGE

By signing below, I certify that I have reviewed this Solicitation in its entirety; understand the requirements, terms and conditions, and other information contained herein; that I am submitting this bid or proposal for review and consideration; that I am authorized by the bidder to execute this bid or any documents related thereto on bidder's behalf; that I am authorized to bind the bidder in a contractual relationship; and that to the best of my knowledge, the bidder has properly registered with any State agency that may require registration.

(Company)

(Authorized Signature)

(Representative Name, Title)

(Phone Number) (Fax Number)

(Date)

ADDENDUM ACKNOWLEDGEMENT FORM
SOLICITATION NO.: 6613C031

Instructions: Please acknowledge receipt of all addenda issued with this solicitation by completing this addendum acknowledgment form. Check the box next to each addendum received and sign below. Failure to acknowledge addenda may result in bid disqualification.

Acknowledgment: I hereby acknowledge receipt of the following addenda and have made the necessary revisions to my proposal, plans and/or specification, etc.

Addendum Numbers Received:
(Check the box next to each addendum received)

- | | |
|-----------------------------------------|------------------------------------------|
| <input type="checkbox"/> Addendum No. 1 | <input type="checkbox"/> Addendum No. 6 |
| <input type="checkbox"/> Addendum No. 2 | <input type="checkbox"/> Addendum No. 7 |
| <input type="checkbox"/> Addendum No. 3 | <input type="checkbox"/> Addendum No. 8 |
| <input type="checkbox"/> Addendum No. 4 | <input type="checkbox"/> Addendum No. 9 |
| <input type="checkbox"/> Addendum No. 5 | <input type="checkbox"/> Addendum No. 10 |

I understand that failure to confirm the receipt of addenda may be cause for rejection of this bid. I further understand that any verbal representation made or assumed to be made during any oral discussion held between Vendor's representatives and any state personnel is not binding. Only the information issued in writing and added to the specifications by an official addendum is binding.

Company

Authorized Signature

Date

NOTE: This addendum acknowledgement should be submitted with the bid to expedite document processing.

SPECIFICATIONS

1. **PURPOSE AND SCOPE:** The West Virginia Purchasing Division is soliciting bids on behalf of the West Virginia Division of Highways to establish an open-end contract to provide cable guardrail repairs parts for use at locations throughout the State of WV by the WV Division of Highways.

2. **DEFINITIONS:** The terms listed below shall have the meanings assigned to them below. Additional definitions can be found in section 2 of the General Terms and Conditions.
 - 2.1 **“Contract Item”** or **“Contract Items”** means the list of items identified in Section III, Subsection 1 below.
 - 2.2 **“Pricing Pages”** means the schedule of prices, estimated order quantity, and totals attached hereto as Exhibit A used to evaluate the RFQ.
 - 2.3 **“RFQ”** means the official request for quotation published by the Purchasing Division and identified as 6613C031.
 - 2.4 **“WVDOH”** used through this RFQ means the West Virginia Division of Highways.
 - 2.5 **“ASTM”** used throughout this RFQ means the American Society for Testing and Materials, reference: www.astm.org.
 - 2.6 **“AASHTO”** used throughout this RFQ means American Association of State Highway and Transportation Officials. Reference: www.transportation.org.
 - 2.7 **“Contractor”** or **“Vendor”** used throughout this RFQ and in any cited sections of the West Virginia Department of Transportation, Division of Highways Standard Specifications, Roads and Bridges, adopted 2010, as modified by the January 1, 2011 Supplemental Specifications, the January 1, 2012 Supplemental Specifications and the January 1, 2013 Supplemental Specifications are interchangeable.
 - 2.8 **“Standard Specs”** used throughout this RFQ means the West Virginia Department of Transportation, Division of Highways Standard Specifications, Roads and Bridges, adopted 2010, as modified by the January 1, 2011 Supplemental Specifications, the January 1, 2012 Supplemental Specifications and the January 1, 2013 Supplemental Specifications.

REQUEST FOR QUOTATION
6613C031 Cable Guardrail – Generic System

A copy of these Standard Specs may be obtained from:

West Virginia Division of Highways
Contract Administration
Building 5, Room 722
1900 Kanawha Boulevard, East
Charleston, West Virginia 25305
(Phone) 304-558-2885

<http://www.transportation.wv.gov/highways/contractadmin/specifications/2010StandSpec/Pages/default.aspx>

3. GENERAL REQUIREMENTS:

3.1 Contract Items and Mandatory Requirements: Vendor shall provide Agency with the Contract Items listed below on an open-end and continuing basis. Contract Items must meet or exceed the mandatory requirements as shown below.

3.1.1 Generic System:

- All posts shall be S3 x 5.7 rolled steel sections in accordance with ASTM A-6. Posts, plates and anchor angles shall conform to the requirements of section 607 of the Standard Specs. Where the rail is parallel to the edge of the travel lane, every 6th post (96') shall be reflectorized (see Standard TE1 1-5 for delineators). Double face cable guiderail shall have a delineator visible, one every 6th post, to traffic in either direction. Do not reflectorize posts in the typical intermediate anchorage section, typical approach or terminal sections.
- Round ¾" diameter zinc coated cable wire shall consist of three strands (7 wires per strand) having a minimum tensile strength of 25,000 lbs. in accordance with AASHTO M-30 Type I cable, class 'A' coating.
- Materials indicated as "Cast Steel" shall conform to AASHTO M 103.
- Installed hook bolts shall develop an ultimate pull open strength of 500 lbs. to 1,000 lbs. applied in a direction normal to the longitudinal axis of the post.
- All fittings, including splices, shall be designed to use the cable wedge and shall develop the full strength of the ¾" cable. All fittings except the cable wedge, shall be hot dipped galvanized in accordance with AASHTO M-30.
- One wire of the wire rope shall be crimped over the base of the wedge to hold it firmly in place at all locations where the cable is connected to a cable splice connection.
- Designs for a combination or single unit compensating device and turnbuckle assembly may be submitted for approval. Compensating devices must have a spring rate of 450 lbs. per inch with a minimum total throw of 6".

REQUEST FOR QUOTATION
6613C031 Cable Guardrail – Generic System

- The following criteria shall apply for arrangement of spring cable end assemblies (compensating devices) and turnbuckle cable end assemblies:
Length of cable runs:
To 1,000' - use compensating device on one end and turnbuckle on the other end of each individual cable.
1,000' to 2,000' - use compensating device on each end of each cable.
Over 2,000' - start new stretch by interlacing at last parallel post (typical layout).
- Intermediate splicing of the cable guardrail will not be permitted.
- Prior to final acceptance by the WVDOH District Engineer, use the following values to tighten the turnbuckles based on the temperature at the time of adjustment:

Temperature (Fahrenheit)	Spring Compression From unloaded position In each Spring
110° - 120°	1"
100° - 109°	1 ¼"
90° - 99°	1 ½"
80° - 89°	1 ¾"
70° - 79°	2"
60° - 69°	2 ¼"
50° - 59°	2 ½"
40° - 49°	2 ¾"
30° - 39°	3"
20° - 29°	3 ¼"
10° - 19°	3 ½"
0° - 9°	3 ¾"
-10° - -1°	4"
-20° - -11°	4 ¼"

4. CONTRACT AWARD:

- 4.1 Contract Award:** The Contract is intended to provide Agencies with a purchase price on all Contract Items. The Contract shall be awarded to the Vendor that provides the Contract Items meeting the required specifications for the lowest overall total cost as shown on the Pricing Pages.
- 4.2 Pricing Pages:** Vendor should complete the Pricing Pages by providing a per Unit Cost per each item requested. Vendor should complete the Pricing Pages in their entirety as failure to do so may result in Vendor's bids being disqualified.

REQUEST FOR QUOTATION
6613C031 Cable Guardrail – Generic System

The Pricing Pages contain a list of the Contract Items and estimated purchase volume. The estimated purchase volume for each item represents the approximate volume of anticipated purchases only. No future use of the Contract or any individual item is guaranteed or implied.

Notwithstanding the foregoing, the Purchasing Division may correct errors at its discretion. Vendor should type or electronically enter the information into the Pricing Pages to prevent errors in the evaluation. The Pricing Pages were created as a Microsoft Excel document and Vendor can request an electronic copy for bid purposes by sending an email request to the following address:
alan.w.cummings@wv.gov.

5. ORDERING AND PAYMENT:

5.1 Ordering: Vendor shall accept orders by regular mail, facsimile, e-mail, or any other written forms of communication. Vendor may, but is not required to, accept on-line orders through a secure internet ordering portal/website. If Vendor has the ability to accept on-line orders, it should include in its response a brief description of how Agencies may utilize the on-line ordering system. Any on-line ordering system must have the capability to restrict prices and available items to conform to the Catalog originally submitted with this RFQ. Vendor shall ensure that its on-line ordering system is properly secured prior to processing Agency orders on-line.

5.2 Payment: Vendor shall accept payment in accordance with the payment procedures of the State of West Virginia. The State of West Virginia currently utilizes a Purchasing Card program, administered under contract by a banking institution, to process payment for goods and services. The Vendor must accept the State of West Virginia's Purchasing Card for payment of all orders under this Contract.

6. DELIVERY AND RETURN:

6.1 Delivery Time: Vendor shall deliver standard orders within 30 working days after receipt of the Agency Release. Vendor shall deliver emergency orders within the accepted alternative timeframe as agreed upon by the WVDOH and the Vendor after receipt of the Agency Release. Vendor shall ship all orders in accordance with the above schedule and shall not hold orders until a minimum delivery quantity is met.

6.2 Late Delivery: The Agency placing the order under this Contract must be notified in writing if orders will be delayed for any reason. Any delay in delivery that could cause harm to an Agency will be grounds for cancellation of the delayed order,

and/or obtaining the items ordered from a third party.

Any Agency seeking to obtain items from a third party under this provision must first obtain approval of the Purchasing Division.

- 6.3 Delivery Payment/Risk of Loss:** Standard order delivery shall be F.O.B. destination to the Agency's location. Vendor shall include the cost of standard order delivery charges in its bid pricing/discount and is not permitted to charge the Agency separately for such delivery. The Agency will pay delivery charges on all emergency orders provided that Vendor invoices those delivery costs as a separate charge with the original freight bill attached to the invoice.
- 6.4 Return of Unacceptable Items:** If the Agency deems the Contract Items to be unacceptable, the Contract Items shall be returned to Vendor at Vendor's expense and with no restocking charge. Vendor shall either make arrangements for the return within five (5) days of being notified that items are unacceptable, or permit the Agency to arrange for the return and reimburse Agency for delivery expenses. If the original packaging cannot be utilized for the return, Vendor will supply the Agency with appropriate return packaging upon request. All returns of unacceptable items shall be F.O.B. the Agency's location. The returned product shall either be replaced, or the Agency shall receive a full credit or refund for the purchase price, at the Agency's discretion.
- 6.5 Return Due to Agency Error:** Items ordered in error by the Agency will be returned for credit within 30 days of receipt, F.O.B. Vendor's location. Vendor shall not charge a restocking fee if returned products are in a resalable condition. Items shall be deemed to be in a resalable condition if they are unused and in the original packaging. Any restocking fee for items not in a resalable condition shall be the lower of the Vendor's customary restocking fee or 5% of the total invoiced value of the returned items.

7. MISCELLANEOUS:

- 7.1 No Substitutions:** Vendor shall supply only Contract Items submitted in response to the RFQ unless a contract modification is approved in accordance with the provisions contained in this Contract.
- 7.2 Vendor Supply:** Vendor must carry sufficient inventory of the Contract Items being offered to fulfill its obligations under this Contract. By signing its bid, Vendor certifies that it can supply the Contract Items contained in its bid response.

REQUEST FOR QUOTATION
6613C031 Cable Guardrail – Generic System

- 7.3 Reports:** Vendor shall provide quarterly reports and annual summaries to the Agency showing the Agency's items purchased, quantities of items purchased, and total dollar value of the items purchased. Vendor shall also provide reports, upon request, showing the items purchased during the term of this Contract, the quantity purchased for each of those items, and the total value of purchases for each of those items. Failure to supply such reports may be grounds for cancellation of this Contract.
- 7.4 Contract Manager:** During its performance of this Contract, Vendor must designate and maintain a primary contract manager responsible for overseeing Vendor's responsibilities under this Contract. The Contract manager must be available during normal business hours to address any customer service or other issues related to this Contract. Vendor should list its Contract manager and his or her contact information below.

Contract Manager: _____
Telephone Number: _____
Fax Number: _____
Email Address: _____

RFQ#6613C031

**CABLE GUARDRAIL REPLACEMENT/REPAIR PARTS
GENERIC SYSTEM PARTS LIST
(Per Attachment A Drawings)**

Shipped prepaid F.O.B. delivery to any WVDOT District Storeroom which will be identified on the Agency Release at the time of need.

		Per Each	Extended
Description	Quantity	Unit Price	Price
End Assembly, Turnbuckle Cable	10		
End Assembly, Spring Cable, Compensating Device	10		
Cable Splice	10		
Intermediate Post, G/R 5'10" Galvanized	10		
Wedge for Splice and Cable Fittings	10		
End Assembly, Cable Rod, Cable to Anchor	10		
Breakaway Anchor Angle	10		
J-Hook Bolts for Post 4 1/2"	10		
J-Hook Bolts for Post 1 3/4"	10		
Keeper Rods 3/16 ϕ Brass Rod	10		
Keeper Plates, Bottom of Anchor Post	10		
Rod, All Thread 3/4", End of Cable Assembly, 1' - 6"	10		
Post G/R Anchor, Top and Bottom Complete	10		
Clamp, Rod fits into Cable, Brass U	10		
Cable, G/R Wire	10		
Post G/R Anchor, Top Only	10		
Post G/R Anchor, Bottom Only	10		
End Post, 5' - 10", with Bearing Plate	10		
Cross Over End Post, 5' - 1-", with Bearing Plate	10		
3" Reflector with Bolt, Nut and Spacer	10		
TOTAL EXTENDED PRICE BID			

*Quantities listed in this RFQ are approximations only. It is understood and agreed that the contract shall cover the quantities actually ordered for delivery during the term of the contract, whether more or less than the quantities shown above.

Public Roads Dist. No.	State No.	State Project No.	Federal Project No.	Fiscal Year	County	Sheet No.	Sheet Amount
W. V. 03	0318-11	131.90	DCRO-0773 (300)	2005	JACKSON	11	48

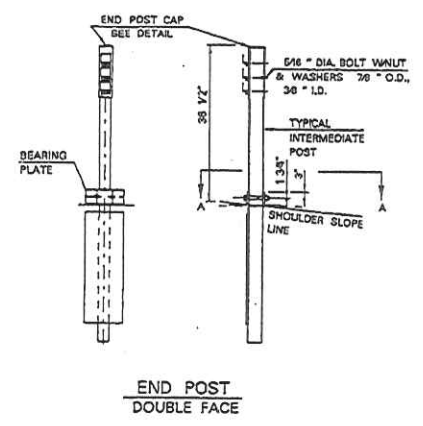

END POST
DOUBLE FACE

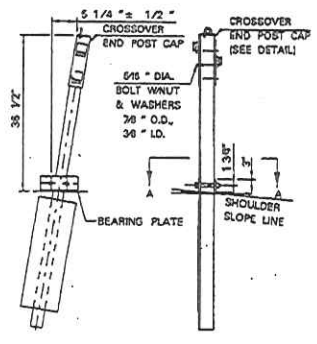

CROSSOVER END POST
DOUBLE FACE

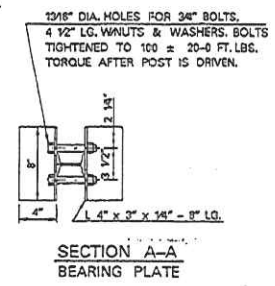

SECTION A-A
BEARING PLATE

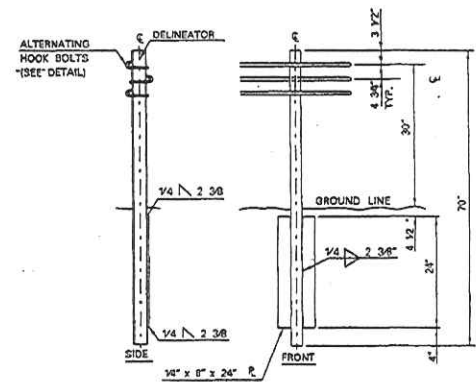

DOUBLE FACE CABLE GUARDRAIL
INTERMEDIATE POST

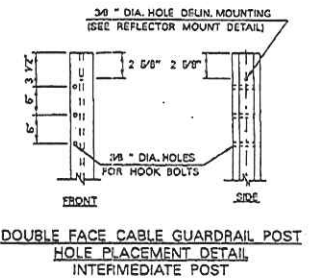

DOUBLE FACE CABLE GUARDRAIL
POST HOLE PLACEMENT DETAIL
INTERMEDIATE POST

DOUBLE FACE CABLE GUARDRAIL - POST DETAILS

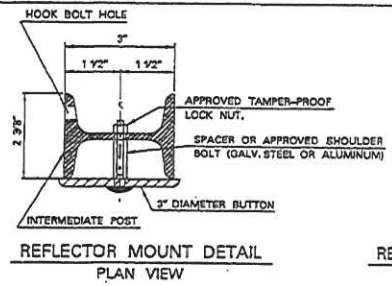

REFLECTOR MOUNT DETAIL
PLAN VIEW

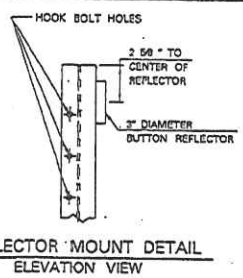

REFLECTOR MOUNT DETAIL
ELEVATION VIEW

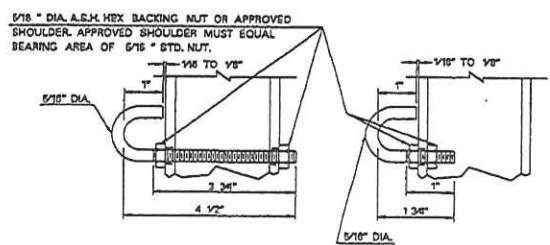

HOOK BOLT (ALTERNATES)

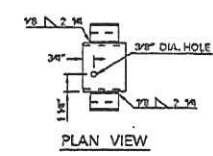

PLAN VIEW

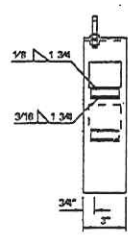

CROSSOVER END POST CAP
ELEVATION VIEW

DOUBLE FACE POST HARDWARE DETAILS

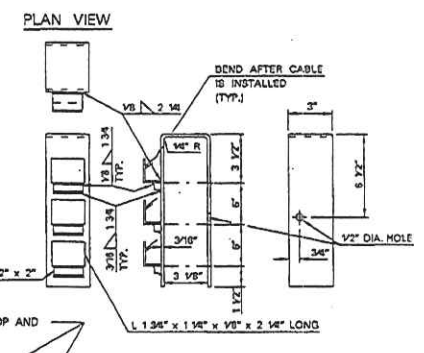

PLAN VIEW

END POST CAP
ELEVATION VIEW

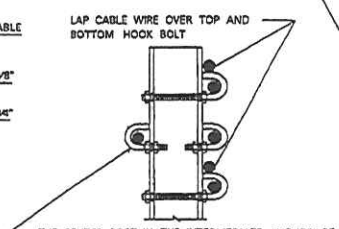

THE CENTER POST IN THE INTERMEDIATE ANCHORAGE SECTION WILL HAVE CABLE WIRE ON BOTH SIDES OF THE MIDDLE STRAND REQUIRING THE USE OF TWO 1 3/4\"/>

DETAIL "A" CENTER POST
INTERMEDIATE ANCHORAGE SECTION

WEST VIRGINIA DEPARTMENT OF TRANSPORTATION
DIVISION OF HIGHWAYS
SPECIAL DETAIL

REVISION DATE
6-23-04
10-23-04

DOUBLE FACE CABLE GUARDRAIL
POST AND HARDWARE DETAILS

SPECIAL DETAIL SHEET CG5

Project Name	State	Project No.	Federal Project No.	Fiscal Year	County	Sheet No.	Total Sheets
W. V.	03	0318-77-137.90	OCRD-0773 (380)	2005	JACKSON	13	48

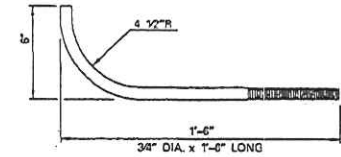
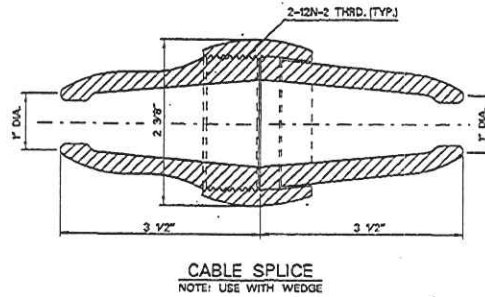
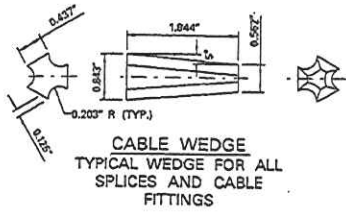

GALVANIZED ANCHOR STUD OPTION

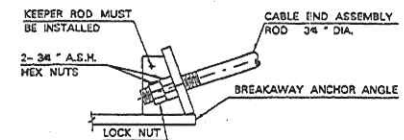
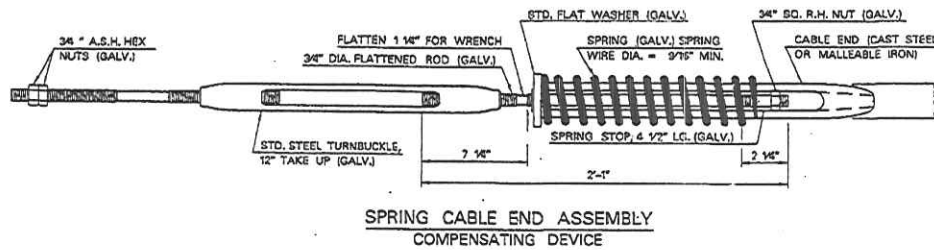

CABLE END ASSEMBLY ROD CABLE TO ANCHOR



WASHER	WASHER SERIES	A INSIDE DIA.	B OUTSIDE DIA.	C THICKNESS
3/4"	REGULAR	7/8"	2"	5/32"
	WIDE	7/8"	2 1/8"	3/16"
1/2"	NARROW	17/32"	1"	3/32"

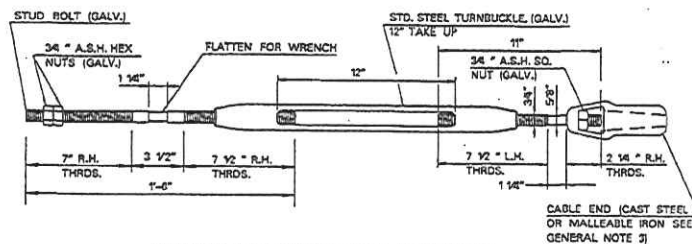

CABLE END (CAST STEEL OR MALLEABLE IRON SEE GENERAL NOTE 3)

WEST VIRGINIA DEPARTMENT OF TRANSPORTATION
DIVISION OF HIGHWAYS
SPECIAL DETAIL

REVISION DATE
6-19-04

SINGLE AND DOUBLE FACE
CABLE GUARDRAIL
ANCHOR DETAILS

SPECIAL DETAIL SHEET CG8

State of West Virginia
VENDOR PREFERENCE CERTIFICATE

Certification and application* is hereby made for Preference in accordance with *West Virginia Code*, §5A-3-37. (Does not apply to construction contracts). *West Virginia Code*, §5A-3-37, provides an opportunity for qualifying vendors to request (at the time of bid) preference for their residency status. Such preference is an evaluation method only and will be applied only to the cost bid in accordance with the *West Virginia Code*. This certificate for application is to be used to request such preference. The Purchasing Division will make the determination of the Resident Vendor Preference, if applicable.

- 1. **Application is made for 2.5% resident vendor preference for the reason checked:**
 Bidder is an individual resident vendor and has resided continuously in West Virginia for four (4) years immediately preceding the date of this certification; **or,**
 Bidder is a partnership, association or corporation resident vendor and has maintained its headquarters or principal place of business continuously in West Virginia for four (4) years immediately preceding the date of this certification; **or 80% of the ownership interest of Bidder is held by another individual, partnership, association or corporation resident vendor who has maintained its headquarters or principal place of business continuously in West Virginia for four (4) years immediately preceding the date of this certification; or,**
 Bidder is a nonresident vendor which has an affiliate or subsidiary which employs a minimum of one hundred state residents and which has maintained its headquarters or principal place of business within West Virginia continuously for the four (4) years immediately preceding the date of this certification; **or,**
- 2. **Application is made for 2.5% resident vendor preference for the reason checked:**
 Bidder is a resident vendor who certifies that, during the life of the contract, on average at least 75% of the employees working on the project being bid are residents of West Virginia who have resided in the state continuously for the two years immediately preceding submission of this bid; **or,**
- 3. **Application is made for 2.5% resident vendor preference for the reason checked:**
 Bidder is a nonresident vendor employing a minimum of one hundred state residents or is a nonresident vendor with an affiliate or subsidiary which maintains its headquarters or principal place of business within West Virginia employing a minimum of one hundred state residents who certifies that, during the life of the contract, on average at least 75% of the employees or Bidder's affiliate's or subsidiary's employees are residents of West Virginia who have resided in the state continuously for the two years immediately preceding submission of this bid; **or,**
- 4. **Application is made for 5% resident vendor preference for the reason checked:**
 Bidder meets either the requirement of both subdivisions (1) and (2) or subdivision (1) and (3) as stated above; **or,**
- 5. **Application is made for 3.5% resident vendor preference who is a veteran for the reason checked:**
 Bidder is an individual resident vendor who is a veteran of the United States armed forces, the reserves or the National Guard and has resided in West Virginia continuously for the four years immediately preceding the date on which the bid is submitted; **or,**
- 6. **Application is made for 3.5% resident vendor preference who is a veteran for the reason checked:**
 Bidder is a resident vendor who is a veteran of the United States armed forces, the reserves or the National Guard, if, for purposes of producing or distributing the commodities or completing the project which is the subject of the vendor's bid and continuously over the entire term of the project, on average at least seventy-five percent of the vendor's employees are residents of West Virginia who have resided in the state continuously for the two immediately preceding years.
- 7. **Application is made for preference as a non-resident small, women- and minority-owned business, in accordance with *West Virginia Code* §5A-3-59 and *West Virginia Code of State Rules*.**
 Bidder has been or expects to be approved prior to contract award by the Purchasing Division as a certified small, women- and minority-owned business.

Bidder understands if the Secretary of Revenue determines that a Bidder receiving preference has failed to continue to meet the requirements for such preference, the Secretary may order the Director of Purchasing to: (a) reject the bid; or (b) assess a penalty against such Bidder in an amount not to exceed 5% of the bid amount and that such penalty will be paid to the contracting agency or deducted from any unpaid balance on the contract or purchase order.

By submission of this certificate, Bidder agrees to disclose any reasonably requested information to the Purchasing Division and authorizes the Department of Revenue to disclose to the Director of Purchasing appropriate information verifying that Bidder has paid the required business taxes, provided that such information does not contain the amounts of taxes paid nor any other information deemed by the Tax Commissioner to be confidential.

Under penalty of law for false swearing (*West Virginia Code*, §61-5-3), Bidder hereby certifies that this certificate is true and accurate in all respects; and that if a contract is issued to Bidder and if anything contained within this certificate changes during the term of the contract, Bidder will notify the Purchasing Division in writing immediately.

Bidder: _____ Signed: _____
Date: _____ Title: _____

RFQ No. _____

STATE OF WEST VIRGINIA
Purchasing Division

PURCHASING AFFIDAVIT

MANDATE: Under W. Va. Code §5A-3-10a, no contract or renewal of any contract may be awarded by the state or any of its political subdivisions to any vendor or prospective vendor when the vendor or prospective vendor or a related party to the vendor or prospective vendor is a debtor and: (1) the debt owed is an amount greater than one thousand dollars in the aggregate; or (2) the debtor is in employer default.

EXCEPTION: The prohibition listed above does not apply where a vendor has contested any tax administered pursuant to chapter eleven of the W. Va. Code, workers' compensation premium, permit fee or environmental fee or assessment and the matter has not become final or where the vendor has entered into a payment plan or agreement and the vendor is not in default of any of the provisions of such plan or agreement.

DEFINITIONS:

"Debt" means any assessment, premium, penalty, fine, tax or other amount of money owed to the state or any of its political subdivisions because of a judgment, fine, permit violation, license assessment, defaulted workers' compensation premium, penalty or other assessment presently delinquent or due and required to be paid to the state or any of its political subdivisions, including any interest or additional penalties accrued thereon.

"Employer default" means having an outstanding balance or liability to the old fund or to the uninsured employers' fund or being in policy default, as defined in W. Va. Code § 23-2c-2, failure to maintain mandatory workers' compensation coverage, or failure to fully meet its obligations as a workers' compensation self-insured employer. An employer is not in employer default if it has entered into a repayment agreement with the Insurance Commissioner and remains in compliance with the obligations under the repayment agreement.

"Related party" means a party, whether an individual, corporation, partnership, association, limited liability company or any other form or business association or other entity whatsoever, related to any vendor by blood, marriage, ownership or contract through which the party has a relationship of ownership or other interest with the vendor so that the party will actually or by effect receive or control a portion of the benefit, profit or other consideration from performance of a vendor contract with the party receiving an amount that meets or exceed five percent of the total contract amount.

AFFIRMATION: By signing this form, the vendor's authorized signer affirms and acknowledges under penalty of law for false swearing (*W. Va. Code §61-5-3*) that neither vendor nor any related party owe a debt as defined above and that neither vendor nor any related party are in employer default as defined above, unless the debt or employer default is permitted under the exception above.

WITNESS THE FOLLOWING SIGNATURE:

Vendor's Name: _____

Authorized Signature: _____ Date: _____

State of _____

County of _____, to-wit:

Taken, subscribed, and sworn to before me this ____ day of _____, 20__.

My Commission expires _____, 20__.

AFFIX SEAL HERE

NOTARY PUBLIC _____

Purchasing Affidavit (Revised 07/01/2012)

NOTE:

Vendor and Notary's date must be the same.

Notary required to AFFIX SEAL on Purchasing Affidavit.