



State of West Virginia
 Department of Administration
 Purchasing Division
 2019 Washington Street East
 Post Office Box 50130
 Charleston, WV 25305-0130

Request for Quotation

RFQ NUMBER
05110326

PAGE
1

ADDRESS CORRESPONDENCE TO ATTENTION OF:
BUYER 33 304-558-2402

VENDOR

RFQ COPY
 TYPE NAME/ADDRESS HERE

SHIP TO

DIVISION OF HIGHWAYS
 DISTRICT FIVE
 RT US 50, P.O. BOX 99
 BURLINGTON, WV
 26710-0099 304-289-3521

DATE PRINTED	TERMS OF SALE	SHIP VIA	F.O.B.	FREIGHT TERMS
01/12/2011				

BID OPENING DATE: 02/16/2011 BID OPENING TIME 01:30PM

LINE	QUANTITY	UOP	CAT NO.	ITEM NUMBER	UNIT PRICE	AMOUNT
0001	1	EA		750-30		
FORMS AND POUR CONCRETE WALL						
REQUEST FOR QUOTATION (RFQ)						
THE WEST VIRGINIA STATE PURCHASING DIVISION FOR THE AGENCY, THE WEST VIRGINIA DIVISION OF HIGHWAYS, IS SOLICITING BIDS FOR A CONTRACT TO PROVIDE FORMS AND POUR CONCRETE WALL PER THE ATTACHED SPECIFICATIONS.						
TECHNICAL QUESTIONS CONCERNING THIS SOLICITATION MUST BE SUBMITTED IN WRITING TO SHERI SLONE IN THE WEST VIRGINIA STATE PURCHASING DIVISION VIA MAIL AT THE ADDRESS SHOWN IN THE BODY OF THIS RFQ, VIA FAX AT 304-558-4115, OR VIA EMAIL AT SHERI.D.SLONE@WV.GOV. DEADLINE FOR TECHNICAL QUESTIONS IS 02/03/2011 AT THE CLOSE OF BUSINESS. ANY TECHNICAL QUESTIONS RECEIVED WILL BE ANSWERED BY FORMAL ADDENDUM TO BE ISSUED BY THE PURCHASING DIVISION AFTER THE DEADLINE HAS LAPSED.						
VENDORS WISHING TO SCHEDULE A SITE VISIT MAY DO SO BY CONTACTING: BARRY KNOTTS, MAINTENANCE ENGINEER, WVDOT AT 304-289-2208 - OFFICE PHONE, OR 304-813-2596 CELL PHONE						
ANY TECHNICAL QUESTIONS ARISING FROM SITE VISITS MUST BE SUBMITTED IN ACCORDANCE WITH THE PROVISIONS OF THE ORIGINAL REQUEST FOR QUOTATION NO. 05110326 AND MUST						

SEE REVERSE SIDE FOR TERMS AND CONDITIONS

SIGNATURE	TELEPHONE	DATE
-----------	-----------	------

TITLE	FEIN	ADDRESS CHANGES TO BE NOTED ABOVE
-------	------	-----------------------------------

WHEN RESPONDING TO RFQ, INSERT NAME AND ADDRESS IN SPACE ABOVE LABELED 'VENDOR'

GENERAL TERMS & CONDITIONS
REQUEST FOR QUOTATION (RFQ) AND REQUEST FOR PROPOSAL (RFP)

1. Awards will be made in the best interest of the State of West Virginia.
2. The State may accept or reject in part, or in whole, any bid.
3. Prior to any award, the apparent successful vendor must be properly registered with the Purchasing Division and have paid the required \$125 fee.
4. All services performed or goods delivered under State Purchase Order/Contracts are to be continued for the term of the Purchase Order/Contracts, contingent upon funds being appropriated by the Legislature or otherwise being made available. In the event funds are not appropriated or otherwise available for these services or goods this Purchase Order/Contract becomes void and of no effect after June 30.
5. Payment may only be made after the delivery and acceptance of goods or services.
6. Interest may be paid for late payment in accordance with the *West Virginia Code*.
7. Vendor preference will be granted upon written request in accordance with the *West Virginia Code*.
8. The State of West Virginia is exempt from federal and state taxes and will not pay or reimburse such taxes.
9. The Director of Purchasing may cancel any Purchase Order/Contract upon 30 days written notice to the seller.
10. The laws of the State of West Virginia and the *Legislative Rules* of the Purchasing Division shall govern the purchasing process.
11. Any reference to automatic renewal is hereby deleted. The Contract may be renewed only upon mutual written agreement of the parties.
12. **BANKRUPTCY:** In the event the vendor/contractor files for bankruptcy protection, the State may deem this contract null and void, and terminate such contract without further order.
13. **HIPAA BUSINESS ASSOCIATE ADDENDUM:** The West Virginia State Government HIPAA Business Associate Addendum (BAA), approved by the Attorney General, is available online at www.state.wv.us/admin/purchase/vrc/hipaa.htm and is hereby made part of the agreement. Provided that the Agency meets the definition of a Cover Entity (45 CFR §160.103) and will be disclosing Protected Health Information (45 CFR §160.103) to the vendor.
14. **CONFIDENTIALITY:** The vendor agrees that he or she will not disclose to anyone, directly or indirectly, any such personally identifiable information or other confidential information gained from the agency, unless the individual who is the subject of the information consents to the disclosure in writing or the disclosure is made pursuant to the agency's policies, procedures, and rules. Vendor further agrees to comply with the Confidentiality Policies and Information Security Accountability Requirements, set forth in <http://www.state.wv.us/admin/purchase/privacy/noticeConfidentiality.pdf>.
15. **LICENSING:** Vendors must be licensed and in good standing in accordance with any and all state and local laws and requirements by any state or local agency of West Virginia, including, but not limited to, the West Virginia Secretary of State's Office, the West Virginia Tax Department, and the West Virginia Insurance Commission. The vendor must provide all necessary releases to obtain information to enable the director or spending unit to verify that the vendor is licensed and in good standing with the above entities.
16. **ANTITRUST:** In submitting a bid to any agency for the State of West Virginia, the bidder offers and agrees that if the bid is accepted the bidder will convey, sell, assign or transfer to the State of West Virginia all rights, title and interest in and to all causes of action it may now or hereafter acquire under the antitrust laws of the United States and the State of West Virginia for price fixing and/or unreasonable restraints of trade relating to the particular commodities or services purchased or acquired by the State of West Virginia. Such assignment shall be made and become effective at the time the purchasing agency tenders the initial payment to the bidder.

I certify that this bid is made without prior understanding, agreement, or connection with any corporation, firm, limited liability company, partnership, or person or entity submitting a bid for the same material, supplies, equipment or services and is in all respects fair and without collusion or Fraud. I further certify that I am authorized to sign the certification on behalf of the bidder or this bid.

INSTRUCTIONS TO BIDDERS

1. Use the quotation forms provided by the Purchasing Division. Complete all sections of the quotation form.
2. Items offered must be in compliance with the specifications. Any deviation from the specifications must be clearly indicated by the bidder. Alternates offered by the bidder as **EQUAL** to the specifications must be clearly defined. A bidder offering an alternate should attach complete specifications and literature to the bid. The Purchasing Division may waive minor deviations to specifications.
3. Unit prices shall prevail in case of discrepancy. All quotations are considered F.O.B. destination unless alternate shipping terms are clearly identified in the quotation.
4. All quotations must be delivered by the bidder to the office listed below prior to the date and time of the bid opening. Failure of the bidder to deliver the quotations on time will result in bid disqualifications: Department of Administration, Purchasing Division, 2019 Washington Street East, P.O. Box 50130, Charleston, WV 25305-0130
5. Communication during the solicitation, bid, evaluation or award periods, except through the Purchasing Division, is strictly prohibited (W.Va. C.S.R. §148-1-6.6).



State of West Virginia
 Department of Administration
 Purchasing Division
 2019 Washington Street East
 Post Office Box 50130
 Charleston, WV 25305-0130

Request for Quotation

RFQ NUMBER
05110326

PAGE
2

ADDRESS CORRESPONDENCE TO ATTENTION OF:
BUYER 33 304-558-2402

VENDOR	RFQ COPY
	TYPE NAME/ADDRESS HERE

SHIP TO	DIVISION OF HIGHWAYS DISTRICT FIVE
	RT US 50, P.O. BOX 99 BURLINGTON, WV 26710-0099 304-289-3521

DATE PRINTED	TERMS OF SALE	SHIP VIA	F.O.B.	FREIGHT TERMS
01/12/2011				

BID OPENING DATE:	02/16/2011	BID OPENING TIME	01:30PM
-------------------	------------	------------------	---------

LINE	QUANTITY	UOP	CAT NO.	ITEM NUMBER	UNIT PRICE	AMOUNT
<p>BE WITHIN THE ALLOTTED TIMEFRAME. NO VERBAL REPRESENTATIONS SHALL BE BINDING UNTIL SUCH TIME AS IT IS ISSUED BY FORMAL WRITTEN ADDENDUM TO BE ISSUED BY THE PURCHASING DIVISION AFTER THE DEADLINE FOR TECHNICAL QUESTIONS HAS LAPSED.</p> <p>EXHIBIT 5</p> <p>WEST VIRGINIA CODE 21-1D-5 PROVIDES THAT: ANY SOLICITATION FOR A PUBLIC IMPROVEMENT CONSTRUCTION CONTRACT REQUIRES EACH VENDOR THAT SUBMITS A BID FOR THE WORK TO SUBMIT AT THE SAME TIME AN AFFIDAVIT OF COMPLIANCE WITH THE BID. THE ENCLOSED DRUG-FREE WORKPLACE AFFIDAVIT MUST BE SIGNED AND SUBMITTED WITH THE BID AS EVIDENCE OF THE VENDOR'S COMPLIANCE WITH THE PROVISIONS OF ARTICLE 1D, CHAPTER 21 OF THE WEST VIRGINIA CODE. FAILURE TO SUBMIT THE SIGNED DRUG-FREE WORKPLACE AFFIDAVIT WITH THE BID SHALL RESULT IN DISQUALIFICATION OF SUCH BID.</p> <p>NOTICE TO PROCEED: THIS CONTRACT IS TO BE PERFORMED WITHIN 120 CALENDAR DAYS AFTER THE NOTICE TO PROCEED IS RECEIVED. UNLESS OTHERWISE SPECIFIED, THE FULLY EXECUTED PURCHASE ORDER WILL BE CONSIDERED NOTICE TO PROCEED.</p> <p>CANCELLATION: THE DIRECTOR OF PURCHASING RESERVES THE RIGHT TO CANCEL THIS CONTRACT IMMEDIATELY UPON WRITTEN NOTICE TO THE VENDOR IF THE MATERIALS OR WORKMANSHIP SUPPLIED ARE OF AN INFERIOR QUALITY OR DO NOT CONFORM WITH THE SPECIFICATIONS OF THE BID AND CONTRACT HERE IN.</p> <p>WAGE RATES: THE CONTRACTOR OR SUBCONTRACTOR SHALL PAY THE HIGHER OF THE U.S. DEPARTMENT OF LABOR MINIMUM WAGE RATES AS ESTABLISHED FOR GRANT COUNTY, PURSUANT</p>						

SEE REVERSE SIDE FOR TERMS AND CONDITIONS			
SIGNATURE	TELEPHONE	DATE	
TITLE	FEIN	ADDRESS CHANGES TO BE NOTED ABOVE	

WHEN RESPONDING TO RFQ, INSERT NAME AND ADDRESS IN SPACE ABOVE LABELED 'VENDOR'



State of West Virginia
 Department of Administration
 Purchasing Division
 2019 Washington Street East
 Post Office Box 50130
 Charleston, WV 25305-0130

Request for Quotation

RFQ NUMBER
05110326

PAGE
3

ADDRESS CORRESPONDENCE TO ATTENTION OF:
BUYER 33 304-558-2402

RFQ COPY
 TYPE NAME/ADDRESS HERE

VENDOR

SHIP TO

DIVISION OF HIGHWAYS
 DISTRICT FIVE
 RT US 50, P.O. BOX 99
 BURLINGTON, WV
 26710-0099 304-289-3521

DATE PRINTED	TERMS OF SALE	SHIP VIA	F.O.B.	FREIGHT TERMS
01/12/2011				

BID OPENING DATE: 02/16/2011 BID OPENING TIME 01:30PM

LINE	QUANTITY	UOP	CAT NO.	ITEM NUMBER	UNIT PRICE	AMOUNT
<p>TO WEST VIRGINIA CODE 21-5A, ET, SEQ. (PREVAILING WAGE RATES APPLY TO THIS PROJECT)</p> <p>ARBITRATION: ANY REFERENCES MADE TO ARBITRATION OR INTEREST FOR PAYMENTS DUE (EXCEPT FOR ANY INTEREST REQUIRED BY STATE LAW) CONTAINED IN THIS CONTRACT OR IN ANY AMERICAN INSTITUTE OF ARCHITECTS DOCUMENTS PERTAINING TO THIS CONTRACT ARE HEREBY DELETED.</p> <p>WORKERS' COMPENSATION: VENDOR IS REQUIRED TO PROVIDE A CERTIFICATE FROM WORKERS' COMPENSATION IF SUCCESSFUL.</p> <p>ALL OF THE ITEMS CHECKED BELOW WILL BE A REQUIREMENT OF THIS CONTRACT:</p> <p>(XX) INSURANCE: SUCCESSFUL VENDOR SHALL FURNISH PROOF OF COMMERCIAL GENERAL LIABILITY INSURANCE PRIOR TO ISSUANCE OF CONTRACT. UNLESS OTHERWISE SPECIFIED IN THE BID DOCUMENTS, THE MINIMUM AMOUNT OF INSURANCE COVERAGE REQUIRED IS \$250,000.</p> <p>() BUILDERS RISK INSURANCE: SUCCESSFUL VENDOR SHALL FURNISH PROOF OF BUILDERS RISK - ALL RISK INSURANCE IN AN AMOUNT EQUAL TO 100% OF THE AMOUNT OF THE CONTRACT.</p> <p>(XX) BONDS: FIVE PERCENT (5%) OF THE TOTAL AMOUNT OF THE BID PAYABLE TO THE STATE OF WEST VIRGINIA, SHALL BE SUBMITTED WITH EACH BID AS A BID BOND. THE SUCCESSFUL BIDDER SHALL ALSO FURNISH A PERFORMANCE BOND AND LABOR/MATERIAL BOND FOR 100% OF THE AMOUNT OF THE CONTRACT. BONDS MAY BE PROVIDED IN THE FORM OF A CERTIFIED CHECK, IRREVOCABLE LETTER OF CREDIT, OR BOND FURNISHED BY A SOLVENT SURETY COMPANY AUTHORIZED TO DO BUSINESS IN THE STATE OF WEST VIRGINIA. A LETTER OF CREDIT SUBMITTED IN LIEU OF A BOND WILL ONLY BE ALLOWED FOR PROJECTS UNDER \$100,000. PERSONAL OR BUSINESS CHECKS ARE NOT</p>						

SEE REVERSE SIDE FOR TERMS AND CONDITIONS

SIGNATURE	TELEPHONE	DATE
TITLE	FEIN	ADDRESS CHANGES TO BE NOTED ABOVE

WHEN RESPONDING TO RFQ, INSERT NAME AND ADDRESS IN SPACE ABOVE LABELED 'VENDOR'



State of West Virginia
 Department of Administration
 Purchasing Division
 2019 Washington Street East
 Post Office Box 50130
 Charleston, WV 25305-0130

Request for Quotation

RFQ NUMBER
05110326

PAGE
5

ADDRESS CORRESPONDENCE TO ATTENTION OF:
BUYER 33 304-558-2402

VENDOR

RFQ COPY
 TYPE NAME/ADDRESS HERE

SHIP TO

DIVISION OF HIGHWAYS
 DISTRICT FIVE
 RT US 50, P.O. BOX 99
 BURLINGTON, WV
 26710-0099 304-289-3521

DATE PRINTED	TERMS OF SALE	SHIP VIA	F.O.B.	FREIGHT TERMS
01/12/2011				

BID OPENING DATE: **02/16/2011** BID OPENING TIME **01:30PM**

LINE	QUANTITY	UOP	CAT NO.	ITEM NUMBER	UNIT PRICE	AMOUNT
<p>DEPARTMENT OF LABOR, FOREIGN PRODUCTS MAY BE SUPPLIED ONLY IF DOMESTIC PRODUCTS ARE 30% OR MORE HIGHER IN PRICE THAN THE FOREIGN MADE PRODUCTS.</p> <p>IF, PRIOR TO THE AWARD OF A CONTRACT UNDER THE ABOVE PROVISIONS, THE SPENDING OFFICER OF THE SPENDING UNIT DETERMINES THAT THERE EXISTS A BID FOR LIKE FOREIGN ALUMINUM, GLASS OR STEEL THAT IS REASONABLE AND LOWER THAN THE LOWEST BID DOMESTIC PRODUCTS, THE SPENDING OFFICE MAY REQUEST, IN WRITING, A REEVALUATION AND REDUCTION IN THE LOWEST BID FOR SUCH DOMESTIC PRODUCTS. ALL VENDORS MUST INDICATE IN THEIR BID IF THEY ARE SUPPLYING FOREIGN ALUMINUM, GLASS OR STEEL.</p> <p>REV. 3/88</p> <p>EXHIBIT 9</p> <p>NOTICE FOR ISSUANCE & ACKNOWLEDGEMENT OF CONSTRUCTION PROJECT ADDENDA</p> <p>THE ARCHITECT/ENGINEER AND/OR AGENCY SHALL BE REQUIRED TO ABIDE BY THE FOLLOWING SCHEDULE IN ISSUING CONSTRUCTION PROJECT ADDENDA FOR STATE AGENCIES:</p> <p>(1) THE ARCHITECT/ENGINEER SHALL PREPARE THE ADDENDUM AND A LIST OF ALL PARTIES THAT HAVE PROCURED DRAWINGS AND SPECIFICATIONS FOR THE PROJECT. THE ADDENDUM AND LIST SHALL BE FORWARDED TO THE BUYER IN THE STATE PURCHASING DIVISION. THE ARCHITECT/ENGINEER SHALL ALSO SEND A COPY OF THE ADDENDUM TO THE STATE AGENCY FOR WHICH THE CONTRACT IS ISSUED.</p> <p>(2) THE BUYER SHALL SEND THE ADDENDUM TO ALL INTERESTED PARTIES AND, IF NECESSARY, EXTEND THE BID</p>						

SEE REVERSE SIDE FOR TERMS AND CONDITIONS

SIGNATURE	TELEPHONE	DATE
TITLE	FEIN	ADDRESS CHANGES TO BE NOTED ABOVE

WHEN RESPONDING TO RFQ, INSERT NAME AND ADDRESS IN SPACE ABOVE LABELED 'VENDOR'



State of West Virginia
 Department of Administration
 Purchasing Division
 2019 Washington Street East
 Post Office Box 50130
 Charleston, WV 25305-0130

Request for Quotation

RFQ NUMBER
05110326

PAGE
6

ADDRESS CORRESPONDENCE TO ATTENTION OF:
BUYER 33 304-558-2402

RFQ COPY
 TYPE NAME/ADDRESS HERE

VENDOR

SHIP TO

DIVISION OF HIGHWAYS
 DISTRICT FIVE

 RT US 50, P.O. BOX 99
 BURLINGTON, WV
 26710-0099 304-289-3521

DATE PRINTED	TERMS OF SALE	SHIP VIA	F.O.B.	FREIGHT TERMS
01/12/2011				

BID OPENING DATE: 02/16/2011 BID OPENING TIME 01:30PM

LINE	QUANTITY	UOP	CAT NO	ITEM NUMBER	UNIT PRICE	AMOUNT
<p>OPENING DATE. ANY ADDENDUM SHOULD BE RECEIVED BY THE BUYER WITHIN FOURTEEN (14) DAYS PRIOR TO THE BID OPENING DATE.</p> <p>(3) ALL ADDENDA SHOULD BE FORMALLY ACKNOWLEDGED BY ALL BIDDERS AND SUBMITTED TO THE STATE PURCHASING DIVISION. THE SAME RULES AND REGULATIONS THAT APPLY TO THE ORIGINAL BIDDING DOCUMENT SHALL ALSO APPLY TO AN ADDENDUM DOCUMENT. THE ONLY EXCEPTION MAY BE FOR AN ADDENDUM THAT IS ISSUED FOR THE SOLE PURPOSE OF CHANGING A BID OPENING TIME AND/OR DATE.</p> <p>REV. 11/96</p> <p>EXHIBIT 10</p> <p>ADDENDUM ACKNOWLEDGEMENT</p> <p>I HEREBY ACKNOWLEDGE RECEIPT OF THE FOLLOWING CHECKED ADDENDUM(S) AND HAVE MADE THE NECESSARY REVISIONS TO MY PROPOSAL, PLANS AND/OR SPECIFICATION, ETC.</p> <p>ADDENDUM NOS.:</p> <p>NO. 1</p> <p>NO. 2</p> <p>NO. 3</p> <p>NO. 4</p> <p>NO. 5</p>						

SEE REVERSE SIDE FOR TERMS AND CONDITIONS

SIGNATURE	TELEPHONE	DATE
TITLE	FEIN	ADDRESS CHANGES TO BE NOTED ABOVE

WHEN RESPONDING TO RFQ, INSERT NAME AND ADDRESS IN SPACE ABOVE LABELED 'VENDOR'



State of West Virginia
 Department of Administration
 Purchasing Division
 2019 Washington Street East
 Post Office Box 50130
 Charleston, WV 25305-0130

Request for Quotation

RFQ NUMBER
 05110326

PAGE
 7

ADDRESS CORRESPONDENCE TO ATTENTION OF
 BUYER 33
 304-558-2402

VENDOR

RFQ COPY
 TYPE NAME/ADDRESS HERE

SHIP TO

DIVISION OF HIGHWAYS
 DISTRICT FIVE
 RT US 50, P.O. BOX 99
 BURLINGTON, WV
 26710-0099 304-289-3521

DATE PRINTED 01/12/2011	TERMS OF SALE	SHIP VIA	F.O.B.	FREIGHT TERMS
----------------------------	---------------	----------	--------	---------------

BID OPENING DATE: 02/16/2011 BID OPENING TIME 01:30PM

LINE	QUANTITY	UOP	CAT NO.	ITEM NUMBER	UNIT PRICE	AMOUNT
<p>I UNDERSTAND THAT FAILURE TO CONFIRM THE RECEIPT OF THE ADDENDUM(S) MAY BE CAUSE FOR REJECTION OF THE BIDS.</p> <p>VENDOR MUST CLEARLY UNDERSTAND THAT ANY VERBAL REPRESENTATION MADE OR ASSUMED TO BE MADE DURING ANY ORAL DISCUSSION HELD BETWEEN VENDOR'S REPRESENTATIVES AND ANY STATE PERSONNEL IS NOT BINDING. ONLY THE INFORMATION ISSUED IN WRITING AND ADDED TO THE SPECIFICATIONS BY AN OFFICIAL ADDENDUM IS BINDING.</p> <p>.....SIGNATURE</p> <p>.....COMPANY</p> <p>.....DATE</p> <p>REV. 11/96</p> <p>CONTRACTORS LICENSE</p> <p>WEST VIRGINIA STATE CODE 21-11-2 REQUIRES THAT ALL PERSONS DESIRING TO PERFORM CONTRACTING WORK IN THIS STATE MUST BE LICENSED. THE WEST VIRGINIA CONTRACTORS LICENSING BOARD IS EMPOWERED TO ISSUE THE CONTRACTORS LICENSE. APPLICATIONS FOR A CONTRACTORS LICENSE MAY BE MADE BY CONTACTING THE WEST VIRGINIA DIVISION OF LABOR CAPITOL COMPLEX, BUILDING 3, ROOM 319, CHARLESTON, WV 25305. TELEPHONE: (304) 558-7890.</p> <p>WEST VIRGINIA STATE CODE 21-11-11 REQUIRES ANY PROSPECTIVE BIDDER TO INCLUDE THE CONTRACTORS LICENSE NUMBER ON THEIR BID.</p> <p>BIDDER TO COMPLETE:</p>						

SEE REVERSE SIDE FOR TERMS AND CONDITIONS

SIGNATURE	TELEPHONE	DATE
TITLE	FEIN	ADDRESS CHANGES TO BE NOTED ABOVE

WHEN RESPONDING TO RFQ, INSERT NAME AND ADDRESS IN SPACE ABOVE LABELED 'VENDOR'



State of West Virginia
 Department of Administration
 Purchasing Division
 2019 Washington Street East
 Post Office Box 50130
 Charleston, WV 25305-0130

Request for Quotation

RFQ NUMBER
05110326

PAGE
8

ADDRESS CORRESPONDENCE TO ATTENTION OF:
BUYER 33 304-558-2402

RFQ COPY
 TYPE NAME/ADDRESS HERE

VENDOR

SHIP TO

DIVISION OF HIGHWAYS
 DISTRICT FIVE
 RT US 50, P.O. BOX 99
 BURLINGTON, WV
 26710-0099 304-289-3521

DATE PRINTED	TERMS OF SALE	SHIP VIA	F.O.B.	FREIGHT TERMS
01/12/2011				

BID OPENING DATE: 02/16/2011 BID OPENING TIME 01:30PM

LINE	QUANTITY	UOP	CAT NO.	ITEM NUMBER	UNIT PRICE	AMOUNT
<p>CONTRACTORS NAME:</p> <p>CONTRACTORS LICENSE NO.:</p> <p>THE SUCCESSFUL BIDDER WILL BE REQUIRED TO FURNISH A COPY OF THEIR CONTRACTORS LICENSE PRIOR TO ISSUANCE OF A PURCHASE ORDER/CONTRACT</p> <p>APPLICABLE LAW</p> <p>THE WEST VIRGINIA STATE CODE, PURCHASING DIVISION RULE AND REGULATIONS, AND THE INFORMATION PROVIDED IN THE "REQUEST FOR QUOTATION" ISSUED BY THE PURCHASING DIVISION IS THE SOLE AUTHORITY GOVERNING THIS PROCUREMENT.</p> <p>ANY INFORMATION PROVIDED IN SPECIFICATION MANUALS, OR ANY OTHER SOURCE, VERBAL OR WRITTEN, WHICH CONTRADICTS OR ALTERS THE INFORMATION PROVIDED FROM THE SOURCES AS DESCRIBED IN THE ABOVE PARAGRAPH IS VOID AND OF NO EFFECT.</p> <p>BANKRUPTCY: IN THE EVENT THE VENDOR/CONTRACTOR FILES FOR BANKRUPTCY PROTECTION, THE STATE MAY DEEM THE CONTRACT NULL AND VOID, AND TERMINATE SUCH CONTRACT WITHOUT FURTHER ORDER.</p> <p>REV. 5/2009</p> <p>NOTICE</p> <p>A SIGNED BID MUST BE SUBMITTED TO:</p> <p>DEPARTMENT OF ADMINISTRATION</p>						

SEE REVERSE SIDE FOR TERMS AND CONDITIONS

SIGNATURE	TELEPHONE	DATE
TITLE	FEIN	ADDRESS CHANGES TO BE NOTED ABOVE

WHEN RESPONDING TO RFQ, INSERT NAME AND ADDRESS IN SPACE ABOVE LABELED 'VENDOR'



State of West Virginia
 Department of Administration
 Purchasing Division
 2019 Washington Street East
 Post Office Box 50130
 Charleston, WV 25305-0130

Request for Quotation

RFQ NUMBER
05110326

PAGE
9

ADDRESS CORRESPONDENCE TO ATTENTION OF:
BUYER 33 304-558-2402

RFQ COPY
 TYPE NAME/ADDRESS HERE

VENDOR

DIVISION OF HIGHWAYS
 DISTRICT FIVE
 RT US 50, P.O. BOX 99
 BURLINGTON, WV
 26710-0099 304-289-3521

SHIP TO

DATE PRINTED	TERMS OF SALE	SHIP VIA	F.O.B.	FREIGHT TERMS
01/12/2011				

BID OPENING DATE: 02/16/2011 BID OPENING TIME 01:30PM

LINE	QUANTITY	UOP	CAT NO	ITEM NUMBER	UNIT PRICE	AMOUNT
				PURCHASING DIVISION BUILDING 15 2019 WASHINGTON STREET, EAST CHARLESTON, WV 25305-0130		
				THE BID SHOULD CONTAIN THIS INFORMATION ON THE FACE OF THE ENVELOPE OR THE BID MAY NOT BE CONSIDERED: SEALED BID BUYER: SHERI SLONE - FILE 33 REQ. NO.: 05110326 BID OPENING DATE: 02/16/2011 BID OPENING TIME: 1:30 PM PLEASE PROVIDE A FAX NUMBER IN CASE IT IS NECESSARY TO CONTACT YOU REGARDING YOUR BID: ----- PLEASE PRINT OR TYPE NAME OF PERSON TO CONTACT CONCERNING THIS QUOTE: -----		

SEE REVERSE SIDE FOR TERMS AND CONDITIONS

SIGNATURE	TELEPHONE	DATE
TITLE	FEIN	ADDRESS CHANGES TO BE NOTED ABOVE

WHEN RESPONDING TO RFQ, INSERT NAME AND ADDRESS IN SPACE ABOVE LABELED 'VENDOR'



State of West Virginia
 Department of Administration
 Purchasing Division
 2019 Washington Street East
 Post Office Box 50130
 Charleston, WV 25305-0130

Request for Quotation

RFQ NUMBER
05110326

PAGE
10

ADDRESS CORRESPONDENCE TO ATTENTION OF:
BUYER 33 304-558-2402

VENDOR

RFQ COPY
 TYPE NAME/ADDRESS HERE

SHIP TO

DIVISION OF HIGHWAYS
 DISTRICT FIVE
 RT US 50, P.O. BOX 99
 BURLINGTON, WV
 26710-0099 304-289-3521

DATE PRINTED	TERMS OF SALE	SHIP VIA	F.O.B.	FREIGHT TERMS
01/12/2011				

BID OPENING DATE: 02/16/2011 BID OPENING TIME 01:30PM

LINE	QUANTITY	UOP	CAT NO.	ITEM NUMBER	UNIT PRICE	AMOUNT
***** THIS IS THE END OF RFQ 05110326 ***** TOTAL: _____						

SEE REVERSE SIDE FOR TERMS AND CONDITIONS

SIGNATURE	TELEPHONE	DATE
TITLE	FEIN	ADDRESS CHANGES TO BE NOTED ABOVE

WHEN RESPONDING TO RFQ, INSERT NAME AND ADDRESS IN SPACE ABOVE LABELED 'VENDOR'

**Bid to Provide Forms and Pour Concrete Wall
WVDOH Corridor H Salt Shed at Knobley Road
Grant County, West Virginia**

Description

This bid is for construction of reinforced concrete walls for the WVDOH Corridor H salt shed located at the intersection of Corridor H and Knobley Road (County Route 3) in Grant County, West Virginia (see attached map).

Finish shall be plain, rubbed finish or have a simulated brick pattern. Walls are to be constructed in accordance with the attached plans on concrete footings previously constructed by the WVDOH.

Contractor shall provide:

- Form panels and all form hardware, including all necessary ties and bracing.
- All labor to set and brace forms.
- All labor to install and tie reinforcing steel.
- All labor to pour and consolidate concrete.
- All labor to strip forms, repair voids, and finish concrete as needed.
- Concrete pump to place concrete.
- Insulating blankets as required.

WVDOH shall provide:

- WVDOH Class B concrete
- Reinforcing steel bars and tie wire.
- Epoxy bonding agent as needed.

- Notes:
1. WVDOH shall cut reinforcing steel to length as needed.
 2. Vertical reinforcing steel bars shall be 12'-6" long and will be either one piece or lap spliced from two 7'-6" long pieces.
 3. Minimum lap splice length for #5 horizontal bars is 19".

Suggested Vendors:

- North Star Foundations, 5920 Frederick Crossing Lane, Frederick, MD 21704
- Lang Poured Walls, 19371 State Route 60, Beverly, OH 45715
- Shiley Construction, 1446 Nadenbousch Lane, Inwood, WV 25428

1	2	3	4	5	6	7	8	9	10
---	---	---	---	---	---	---	---	---	----

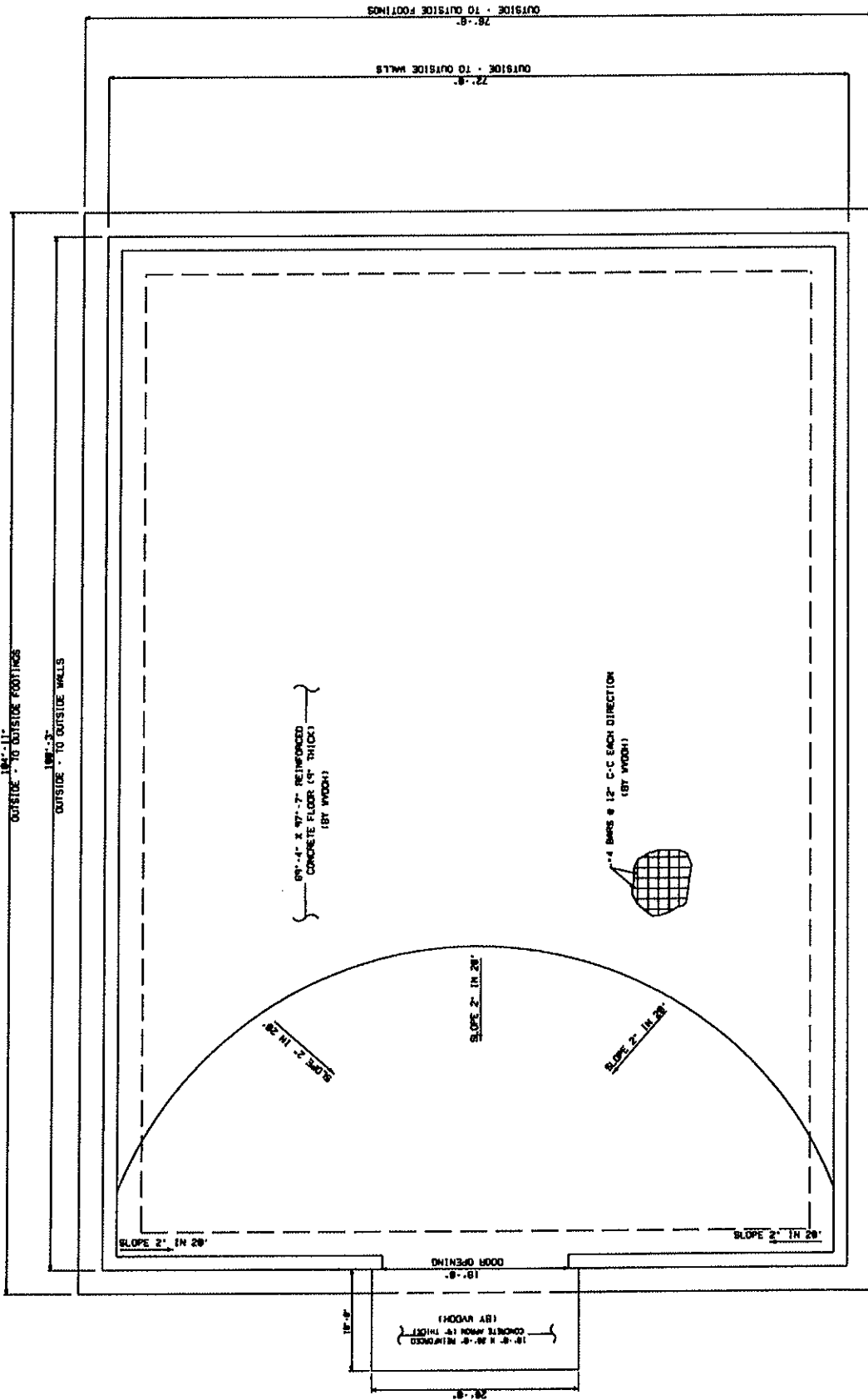

THE WEST VIRGINIA DEPARTMENT OF TRANSPORTATION
DIVISION OF HIGHWAYS
CORRIDOR H-KNOBLEY SALT SHED

NO SCALE

--	--	--	--	--

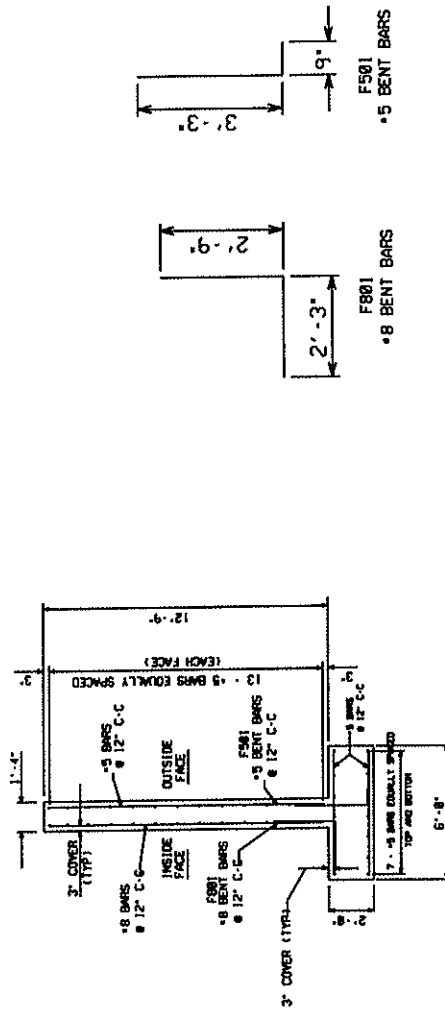
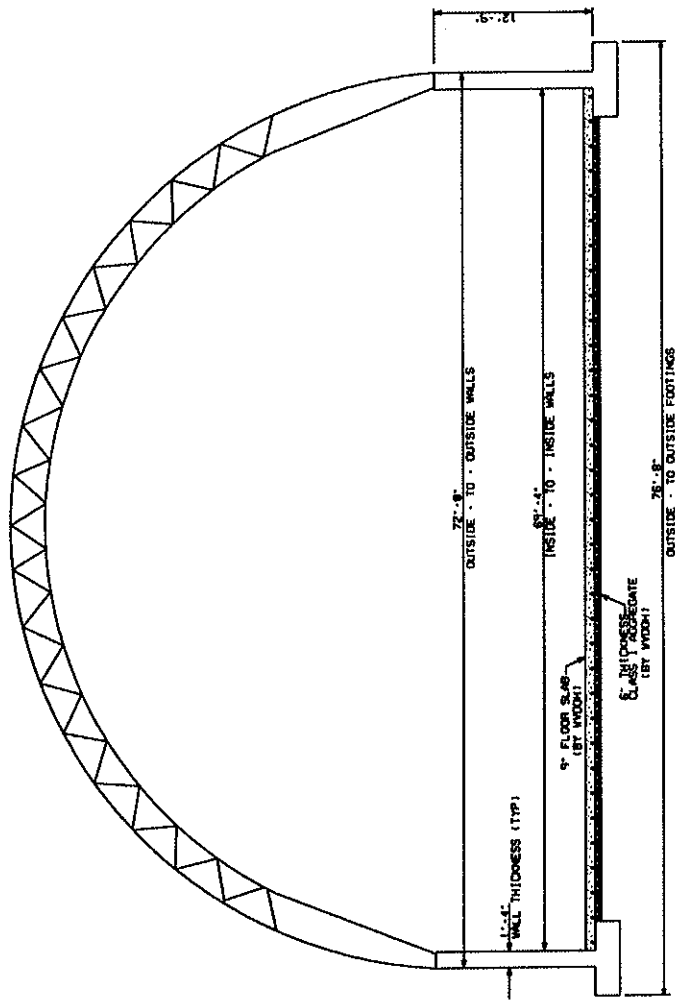

72 X 100 SHED
EXTERIOR WALL

THE WEST VIRGINIA DEPARTMENT OF TRANSPORTATION
DIVISION OF HIGHWAYS
CORRIDOR H-KNOBLEY SALT SHEI

NO SCALE

REV	DATE	BY	CHK

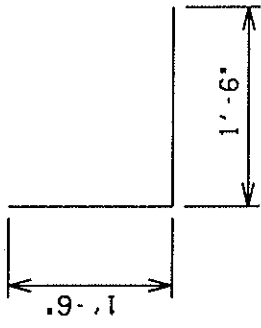

W501 - •5 BENT BARS

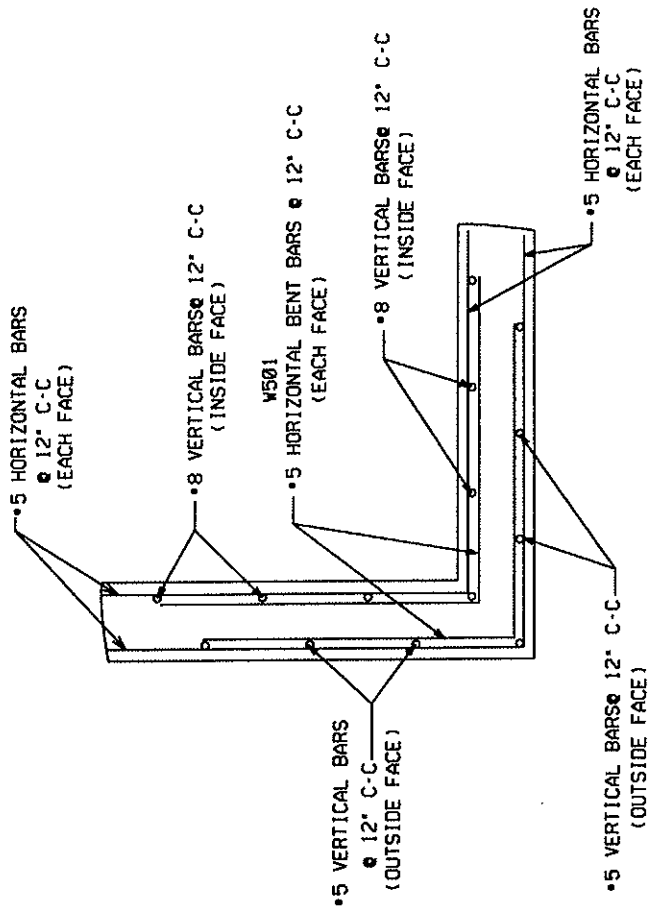

WALL CORNER DETAIL

NO SCALE

THE WEST VIRGINIA DEPARTMENT OF TRANSPORTATION
DIVISION OF HIGHWAYS
CORRIDOR H-KNOBLEY SALT SHED

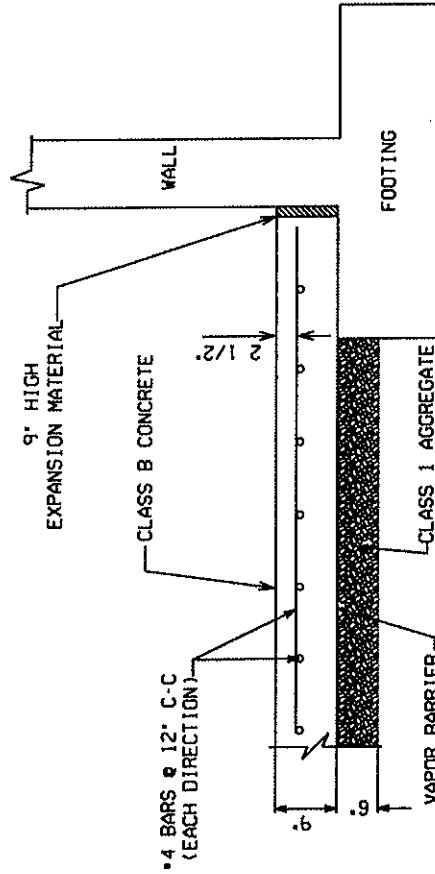

9" CONCRETE FLOOR SLAB DETAIL

(BY WVD0H)

WVDOH Corridor H Salt Shed Grant County

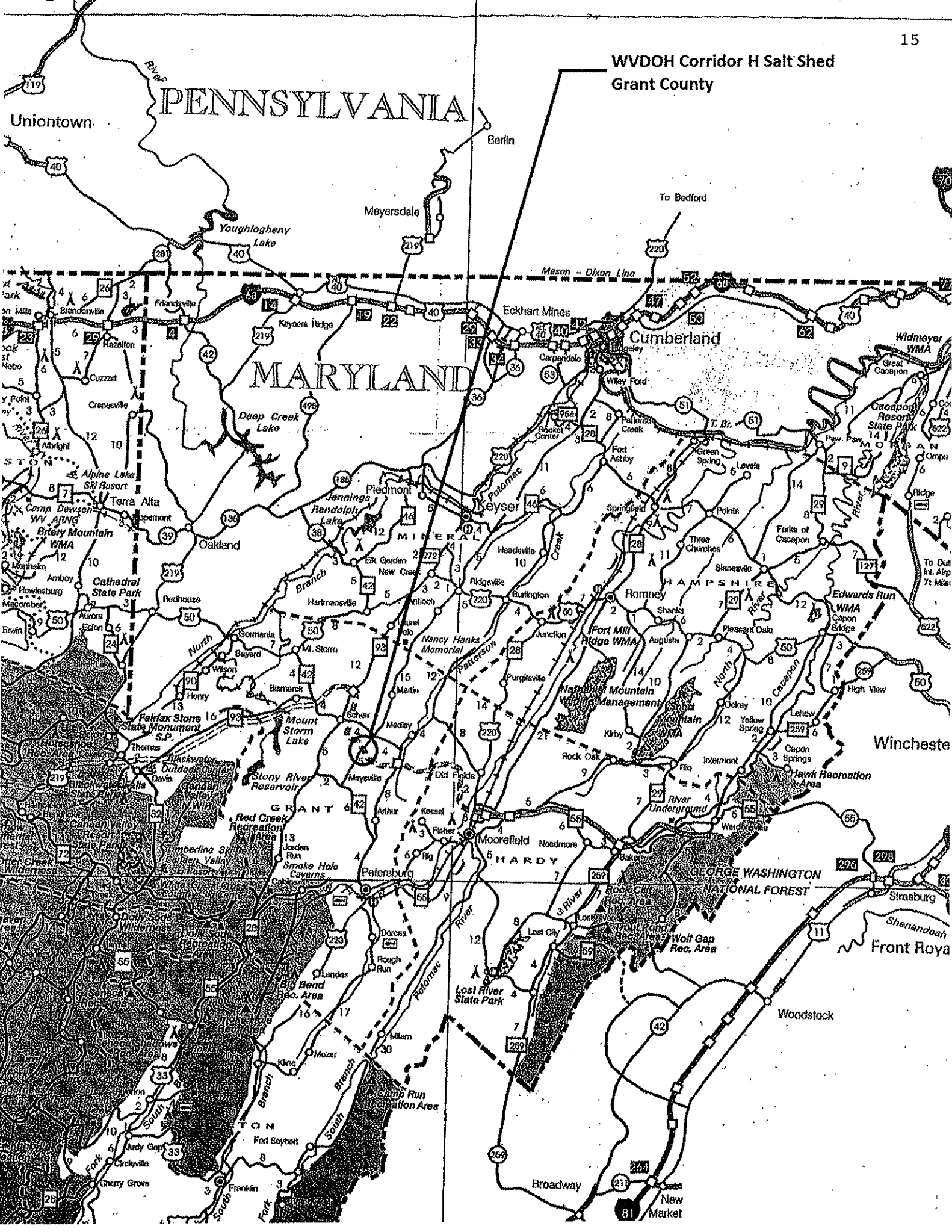

RFQ No. _____

STATE OF WEST VIRGINIA
Purchasing Division

PURCHASING AFFIDAVIT

West Virginia Code §5A-3-10a states: No contract or renewal of any contract may be awarded by the state or any of its political subdivisions to any vendor or prospective vendor when the vendor or prospective vendor or a related party to the vendor or prospective vendor is a debtor and the debt owed is an amount greater than one thousand dollars in the aggregate.

DEFINITIONS:

"Debt" means any assessment, premium, penalty, fine, tax or other amount of money owed to the state or any of its political subdivisions because of a judgment, fine, permit violation, license assessment, defaulted workers' compensation premium, penalty or other assessment presently delinquent or due and required to be paid to the state or any of its political subdivisions, including any interest or additional penalties accrued thereon.

"Debtor" means any individual, corporation, partnership, association, limited liability company or any other form or business association owing a debt to the state or any of its political subdivisions. "Political subdivision" means any county commission; municipality; county board of education; any instrumentality established by a county or municipality; any separate corporation or instrumentality established by one or more counties or municipalities, as permitted by law; or any public body charged by law with the performance of a government function or whose jurisdiction is coextensive with one or more counties or municipalities. "Related party" means a party, whether an individual, corporation, partnership, association, limited liability company or any other form or business association or other entity whatsoever, related to any vendor by blood, marriage, ownership or contract through which the party has a relationship of ownership or other interest with the vendor so that the party will actually or by effect receive or control a portion of the benefit, profit or other consideration from performance of a vendor contract with the party receiving an amount that meets or exceed five percent of the total contract amount.

EXCEPTION: The prohibition of this section does not apply where a vendor has contested any tax administered pursuant to chapter eleven of this code, workers' compensation premium, permit fee or environmental fee or assessment and the matter has not become final or where the vendor has entered into a payment plan or agreement and the vendor is not in default of any of the provisions of such plan or agreement.

Under penalty of law for false swearing (*West Virginia Code §61-5-3*), it is hereby certified that the vendor affirms and acknowledges the information in this affidavit and is in compliance with the requirements as stated.

WITNESS THE FOLLOWING SIGNATURE

Vendor's Name: _____

Authorized Signature: _____ Date: _____

State of _____

County of _____, to-wit:

Taken, subscribed, and sworn to before me this ___ day of _____, 20__.

My Commission expires _____, 20__.

AFFIX SEAL HERE

NOTARY PUBLIC _____



State of West Virginia
DRUG FREE WORKPLACE CONFORMANCE AFFIDAVIT
West Virginia Code §21-1D-5

STATE OF _____

COUNTY OF _____, TO-WIT:

I, _____, after being first duly sworn, depose and state as follows:

- 1. I am an employee of _____; and, (Company Name)
2. I do hereby attest that _____ (Company Name)

maintains a valid written drug free workplace policy and that such policy is in compliance with West Virginia Code §21-1D-5.

The above statements are sworn to under the penalty of perjury.

_____, (Company Name)

By: _____

Title: _____

Date: _____

Taken, subscribed and sworn to before me this _____ day of _____.

By Commission expires _____

(Seal)

_____, (Notary Public)

THIS AFFIDAVIT MUST BE SUBMITTED WITH THE BID IN ORDER TO COMPLY WITH WV CODE PROVISIONS. FAILURE TO INCLUDE THE AFFIDAVIT WITH THE BID SHALL RESULT IN DISQUALIFICATION OF THE BID.

AGENCY _____ (A)
RFQ/RFP# _____ (B)

Bid Bond

- (A) WV State Agency
(Stated on Page 1 "Spending Unit")
Request for Quotation Number (upper right corner of page #1)
- (C) Your Company Name
- (D) City, Location of your Company
- (E) State, Location of your Company
- (F) Surety Corporate Name
- (G) City, Location of Surety
- (H) State, Location of Surety
- (I) State of Surety Incorporation
- (J) City of Surety Incorporation
- (K) Minimum amount of acceptable bid bond is 5% of total bid. You may state "5% of bid" or a specific amount on this line in words.
- (L) Amount of bond in figures
- (M) Brief Description of scope of work
- (N) Day of the month
- (O) Month
- (P) Year
- (Q) Name of Corporation
- (R) Raised Corporate Seal of Principal
- (S) Signature of President or Vice President
- (T) Title of person signing
- (U) Raised Corporate Seal of Surety
- (V) Corporate Name of Surety
- (W) Signature of Attorney in Fact of the Surety

NOTE: Dated, Power of Attorney with Raised Surety Seal must accompany this bid bond.

KNOW ALL MEN BY THESE PRESENTS, That we, the undersigned, _____ (C) of _____ (D), _____ (E), as Principal, and _____ (F) of _____ (G), _____ (H), a corporation organized and existing under the laws of the State of _____ (I) with its principal office in the City of _____ (J), as Surety, are held and firmly bound unto The State of West Virginia, as Obligee, in the penal sum of _____ (K) (\$ _____ (L)) for the payment of which, well and truly to be made, we jointly and severally bind ourselves, our heirs, administrators, executors, successors and assigns.

The Condition of the above obligation is such that whereas the Principal has submitted to the Purchasing Section of the Department of Administration a certain bid or proposal, attached hereto and made a part hereof to enter into a contract in writing for _____ (M)

NOW THEREFORE.

- (a) If said bid shall be rejected, or
- (b) If said bid shall be accepted and the Principal shall enter into a contract in accordance with the bid or proposal attached hereto and shall furnish any other bonds and insurance required by the bid or proposal, and shall in all other respects perform the agreement created by the acceptance of said bid then this obligation shall be null and void, otherwise this obligation shall remain in full force and effect. It is expressly understood and agreed that the liability of the Surety for any and all claims hereunder shall, in no event, exceed the penal amount of this obligation as herein stated

The Surety for value received, hereby stipulates and agrees that the obligations of said Surety and its bond shall be in no way impaired or affected by any extension of time within which the Obligee may accept such bid: and said Surety does hereby waive notice of any such extension.

IN WITNESS WHEREOF, Principal and Surety have hereunto set their hands and seals, and such of them as are corporations have caused their corporate seals to be affixed hereto and these presents to be signed by their proper officers, this _____ (N) day of _____ (O), 20 _____ (P).

Principal Corporate Seal _____ (Q)
(Name of Principal)
(R) By _____ (S)
(Must be President or Vice President)

(T)
Title

Surety Corporate Seal _____ (U)
(V)
(Name of Surety)

(W)
Attorney-in-Fact

IMPORTANT – Surety executing bonds must be licensed in West Virginia to transact surety insurance. Raised Corporate Seals must be affixed and a Power of Attorney must be attached.

BID BOND

KNOW ALL MEN BY THESE PRESENTS, That we, the undersigned, _____
_____ of _____, _____, as Principal, and _____
_____ of _____, _____, a corporation organized and existing under the laws of the State of _____
_____ with its principal office in the City of _____, as Surety, are held and firmly bound unto the State
of West Virginia, as Obligee, in the penal sum of _____ (\$ _____) for the payment of which,
well and truly to be made, we jointly and severally bind ourselves, our heirs, administrators, executors, successors and assigns.

The Condition of the above obligation is such that whereas the Principal has submitted to the Purchasing Section of the
Department of Administration a certain bid or proposal, attached hereto and made a part hereof, to enter into a contract in writing for

NOW THEREFORE,

- (a) If said bid shall be rejected, or
- (b) If said bid shall be accepted and the Principal shall enter into a contract in accordance with the bid or proposal attached
hereto and shall furnish any other bonds and insurance required by the bid or proposal, and shall in all other respects perform the
agreement created by the acceptance of said bid, then this obligation shall be null and void, otherwise this obligation shall remain in full
force and effect. It is expressly understood and agreed that the liability of the Surety for any and all claims hereunder shall, in no event,
exceed the penal amount of this obligation as herein stated.

The Surety, for the value received, hereby stipulates and agrees that the obligations of said Surety and its bond shall be in no
way impaired or affected by any extension of the time within which the Obligee may accept such bid, and said Surety does hereby
waive notice of any such extension.

IN WITNESS WHEREOF, Principal and Surety have hereunto set their hands and seals, and such of them as are corporations
have caused their corporate seals to be affixed hereunto and these presents to be signed by their proper officers, this
_____ day of _____, 20_____.

Principal Corporate Seal

(Name of Principal)

By _____

(Must be President or
Vice President)

(Title)

Surety Corporate Seal

(Name of Surety)

Attorney-in-Fact

IMPORTANT – Surety executing bonds must be licensed in West Virginia to transact surety insurance. Raised corporate seals must be affixed, a power of attorney must be attached.