



State of West Virginia
 Department of Administration
 Purchasing Division
 2019 Washington Street East
 Post Office Box 50130
 Charleston, WV 25305-0130

Request for Quotation

RFQ NUMBER
DNR90185

PAGE
1

ADDRESS CORRESPONDENCE TO ATTENTION OF
FRANK WHITTAKER
304-558-2316

RFQ COPY
 TYPE NAME/ADDRESS HERE

VENDOR

SHIP TO

DIVISION OF NATURAL RESOURCES
 PIPESTEM STATE PARK
 ATTN: PARK SUPERINTENDENT
 STATE ROUTE 20
 PIPESTEM, WV
 25979 304-466-2804

DATE PRINTED	TERMS OF SALE	SHIP VIA	F.O.B.	FREIGHT TERMS
07/16/2008				

BID OPENING DATE: **07/30/2008** BID OPENING TIME **01:30PM**

LINE	QUANTITY	UOP	CAT NO	ITEM NUMBER	UNIT PRICE	AMOUNT
0001	1	LS		370-99		
EQUIPMENT: FOOD SERVICE						
<p>THE WEST VIRGINIA PURCHASING DIVISION, FOR THE AGENCY, THE WEST VIRGINIA DIVISION OF NATURAL RESOURCES, IS SOLICITING BIDS FOR RESTAURANT BUFFET EQUIPMENT TO BE DELIVERED TO PIPESTEM STATE PARK PER THE ATTACHED SPECIFICATIONS AND DRAWINGS.</p> <p>BANKRUPTCY: IN THE EVENT THE VENDOR/CONTRACTOR FILES FOR BANKRUPTCY PROTECTION, THIS CONTRACT MAY BE DEEMED NULL AND VOID, AND TERMINATED WITHOUT FURTHER ORDER.</p> <p>THE MODEL/BRAND/SPECIFICATIONS NAMED HEREIN ESTABLISH THE ACCEPTABLE LEVEL OF QUALITY ONLY AND ARE NOT INTENDED TO REFLECT A PREFERENCE OR FAVOR ANY PARTICULAR BRAND OR VENDOR. VENDORS WHO ARE BIDDING ALTERNATES SHOULD SO STATE AND INCLUDE PERTINENT LITERATURE AND SPECIFICATIONS. FAILURE TO PROVIDE INFORMATION FOR ANY ALTERNATES MAY BE GROUNDS FOR REJECTION OF THE BID. THE STATE RESERVES THE RIGHT TO WAIVE MINOR IRREGULARITIES IN BIDS OR SPECIFICATIONS IN ACCORDANCE WITH SECTION 148-1-4(F) OF THE WEST VIRGINIA LEGISLATIVE RULES AND REGULATIONS.</p> <p>VENDOR PREFERENCE CERTIFICATE</p> <p>CERTIFICATION AND APPLICATION* IS HEREBY MADE FOR PREFERENCE IN ACCORDANCE WITH WEST VIRGINIA CODE, 5A-3-37 (DOES NOT APPLY TO CONSTRUCTION CONTRACTS).</p> <p>A. APPLICATION IS MADE FOR 2.5% PREFERENCE FOR THE</p>						

SEE REVERSE SIDE FOR TERMS AND CONDITIONS

SIGNATURE	TELEPHONE	DATE
-----------	-----------	------

TITLE	FEIN	ADDRESS CHANGES TO BE NOTED ABOVE
-------	------	-----------------------------------

WHEN RESPONDING TO RFQ, INSERT NAME AND ADDRESS IN SPACE ABOVE LABELED 'VENDOR'

**GENERAL TERMS & CONDITIONS
REQUEST FOR QUOTATION (RFQ) AND REQUEST FOR PROPOSAL (RFP)**

1. Awards will be made in the best interest of the State of West Virginia.
2. The State may accept or reject in part, or in whole, any bid.
3. All quotations are governed by the *West Virginia Code* and the *Legislative Rules* of the Purchasing Division.
4. Prior to any award, the apparent successful vendor must be properly registered with the Purchasing Division and have paid the required \$125.00 registration fee.
5. All services performed or goods delivered under State Purchase Orders/Contracts are to be continued for the term of the Purchase Order/Contract, contingent upon funds being appropriated by the Legislature or otherwise being made available. In the event funds are not appropriated or otherwise available for these services or goods, this Purchase Order/Contract becomes void and of no effect after June 30.
6. Payment may only be made after the delivery and acceptance of goods or services.
7. Interest may be paid for late payment in accordance with the *West Virginia Code*.
8. Vendor preference will be granted upon written request in accordance with the *West Virginia Code*.
9. The State of West Virginia is exempt from federal and state taxes and will not pay or reimburse such taxes.
10. The Director of Purchasing may cancel any Purchase Order/Contract upon 30 days written notice to the seller.
11. The laws of the State of West Virginia and the *Legislative Rules* of the Purchasing Division shall govern all rights and duties under the Contract, including without limitation the validity of this Purchase Order/Contract.
12. Any reference to automatic renewal is hereby deleted. The Contract may be renewed only upon mutual written agreement of the parties.
13. **BANKRUPTCY:** In the event the vendor/contractor files for bankruptcy protection, this Contract may be deemed null and void, and terminated without further order.
14. **HIPAA Business Associate Addendum:** The West Virginia State Government HIPAA Business Associate Addendum (BAA), approved by the Attorney General, and available online at the Purchasing Division's web site (<http://www.state.wv.us/admin/purchase/vrc/hipaa.htm>) is hereby made part of the agreement. Provided that, the Agency meets the definition of a Covered Entity (45 CFR §160.103) and will be disclosing Protected Health Information (45 CFR §160.103) to the vendor.
15. **West Virginia Alcohol & Drug-Free Workplace Act:** If this Contract constitutes a public improvement construction contract as set forth in Article 1D, Chapter 21 of the West Virginia Code ("The West Virginia Alcohol and Drug-Free Workplace Act"), then the following language shall hereby become part of this Contract: "The contractor and its subcontractors shall implement and maintain a written drug-free workplace policy in compliance with the West Virginia Alcohol and Drug-Free Workplace Act, as set forth in Article 1D, Chapter 21 of the West Virginia Code. The contractor and its subcontractors shall provide a sworn statement in writing, under the penalties of perjury, that they maintain a valid drug-free work place policy in compliance with the West Virginia Alcohol and Drug-Free Workplace Act. It is understood and agreed that this Contract shall be cancelled by the awarding authority if the Contractor: 1) Fails to implement its drug-free workplace policy; 2) Fails to provide information regarding implementation of the contractor's drug-free workplace policy at the request of the public authority; or 3) Provides to the public authority false information regarding the contractor's drug-free workplace policy."

INSTRUCTIONS TO BIDDERS

1. Use the quotation forms provided by the Purchasing Division.
2. **SPECIFICATIONS:** Items offered must be in compliance with the specifications. Any deviation from the specifications must be clearly indicated by the bidder. Alternates offered by the bidder as **EQUAL** to the specifications must be clearly defined. A bidder offering an alternate should attach complete specifications and literature to the bid. The Purchasing Division may waive minor deviations to specifications.
3. Complete all sections of the quotation form.
4. Unit prices shall prevail in cases of discrepancy.
5. All quotations are considered F.O.B. destination unless alternate shipping terms are clearly identified in the quotation.
6. **BID SUBMISSION:** All quotations must be delivered by the bidder to the office listed below prior to the date and time of the bid opening. Failure of the bidder to deliver the quotations on time will result in bid disqualifications:
Department of Administration, Purchasing Division, 2019 Washington Street East, P.O. Box 50130,
Charleston, WV 25305-0130



State of West Virginia
 Department of Administration
 Purchasing Division
 2019 Washington Street East
 Post Office Box 50130
 Charleston, WV 25305-0130

Request for Quotation

RFQ NUMBER
DNR90185

PAGE
2

ADDRESS CORRESPONDENCE TO ATTENTION OF
FRANK WHITTAKER 304-558-2316

RFQ COPY
 TYPE NAME/ADDRESS HERE

VENDOR

SHIP TO

DIVISION OF NATURAL RESOURCES
 PIPESTEM STATE PARK
 ATTN: PARK SUPERINTENDENT
 STATE ROUTE 20
 PIPESTEM, WV
 25979 304-466-2804

DATE PRINTED	TERMS OF SALE	SHIP VIA	F.O.B.	FREIGHT TERMS
07/16/2008				

BID OPENING DATE: 07/30/2008 BID OPENING TIME 01:30PM

LINE	QUANTITY	UOP	CAT NO	ITEM NUMBER	UNIT PRICE	AMOUNT
<p>REASON CHECKED:</p> <p>() BIDDER IS AN INDIVIDUAL RESIDENT VENDOR AND HAS RESIDED CONTINUOUSLY IN WEST VIRGINIA FOR FOUR (4) YEARS IMMEDIATELY PRECEDING THE DATE OF THIS CERTIFICATION; OR</p> <p>() BIDDER IS A PARTNERSHIP, ASSOCIATION OR CORPORATION RESIDENT VENDOR AND HAS MAINTAINED ITS HEAD-QUARTERS OR PRINCIPAL PLACE OF BUSINESS CONTINUOUSLY IN WEST VIRGINIA FOR FOUR (4) YEARS IMMEDIATELY PRECEDING THE DATE OF THIS CERTIFICATION; OR 80% OF THE OWNERSHIP INTEREST OF BIDDER IS HELD BY ANOTHER INDIVIDUAL, PARTNERSHIP, ASSOCIATION OR CORPORATION RESIDENT VENDOR WHO HAS MAINTAINED ITS HEADQUARTERS OR PRINCIPAL PLACE OF BUSINESS CONTINUOUSLY IN WEST VIRGINIA FOR FOUR (4) YEARS IMMEDIATELY PRECEDING THE DATE OF THIS CERTIFICATION; OR</p> <p>() BIDDER IS A CORPORATION NONRESIDENT VENDOR WHICH HAS AN AFFILIATE OR SUBSIDIARY WHICH EMPLOYS A MINIMUM OF ONE HUNDRED STATE RESIDENTS AND WHICH HAS MAINTAINED ITS HEADQUARTERS OR PRINCIPAL PLACE OF BUSINESS WITHIN WEST VIRGINIA CONTINUOUSLY FOR THE FOUR (4) YEARS IMMEDIATELY PRECEDING THE DATE OF THIS CERTIFICATION.</p> <p>B. APPLICATION IS MADE FOR 2.5% PREFERENCE FOR THE REASON CHECKED:</p> <p>() BIDDER IS A RESIDENT VENDOR WHO CERTIFIES THAT, DURING THE LIFE OF THE CONTRACT, ON AVERAGE AT LEAST 75% OF THE EMPLOYEES WORKING ON THE PROJECT BEING BID ARE RESIDENTS OF WEST VIRGINIA WHO HAVE RESIDED IN THE STATE CONTINUOUSLY FOR THE TWO YEARS IMMEDIATELY PRECEDING SUBMISSION OF THIS BID;</p>						

SEE REVERSE SIDE FOR TERMS AND CONDITIONS

SIGNATURE	TELEPHONE	DATE
-----------	-----------	------

TITLE	FEIN	ADDRESS CHANGES TO BE NOTED ABOVE
-------	------	-----------------------------------

WHEN RESPONDING TO RFQ, INSERT NAME AND ADDRESS IN SPACE ABOVE LABELED 'VENDOR'



State of West Virginia
 Department of Administration
 Purchasing Division
 2019 Washington Street East
 Post Office Box 50130
 Charleston, WV 25305-0130

Request for Quotation

RFQ NUMBER
DNR90185

PAGE
3

ADDRESS CORRESPONDENCE TO ATTENTION OF
FRANK WHITTAKER
304-558-2316

VENDOR

RFQ COPY
TYPE NAME/ADDRESS HERE

SHIP TO

DIVISION OF NATURAL RESOURCES
PIPESTEM STATE PARK
ATTN: PARK SUPERINTENDENT
STATE ROUTE 20
PIPESTEM, WV
25979 **304-466-2804**

DATE PRINTED	TERMS OF SALE	SHIP VIA	F.O.B.	FREIGHT TERMS
07/16/2008				

BID OPENING DATE: **07/30/2008** BID OPENING TIME **01:30PM**

LINE	QUANTITY	UOP	CAT NO	ITEM NUMBER	UNIT PRICE	AMOUNT
<p>OR () BIDDER IS A NONRESIDENT VENDOR EMPLOYING A MINIMUM OF ONE HUNDRED STATE RESIDENTS OR IS A NONRESIDENT VENDOR WITH AN AFFILIATE OR SUBSIDIARY WHICH MAINTAINS ITS HEADQUARTERS OR PRINCIPAL PLACE OF BUSINESS WITHIN WEST VIRGINIA EMPLOYING A MINIMUM OF ONE HUNDRED STATE RESIDENTS WHO CERTIFIES THAT, DURING THE LIFE OF THE CONTRACT, ON AVERAGE AT LEAST 75% OF THE EMPLOYEES OR BIDDERS' AFFILIATE'S OR SUBSIDIARY'S EMPLOYEES ARE RESIDENTS OF WEST VIRGINIA WHO HAVE RESIDED IN THE STATE CONTINUOUSLY FOR THE TWO YEARS IMMEDIATELY PRECEDING SUBMISSION OF THIS BID.</p> <p>BIDDER UNDERSTANDS IF THE SECRETARY OF TAX & REVENUE DETERMINES THAT A BIDDER RECEIVING PREFERENCE HAS FAILED TO CONTINUE TO MEET THE REQUIREMENTS FOR SUCH PREFERENCE, THE SECRETARY MAY ORDER THE DIRECTOR OF PURCHASING TO: (A) RESCIND THE CONTRACT OR PURCHASE ORDER ISSUED; OR (B) ASSESS A PENALTY AGAINST SUCH BIDDER IN AN AMOUNT NOT TO EXCEED 5% OF THE BID AMOUNT AND THAT SUCH PENALTY WILL BE PAID TO THE CONTRACTING AGENCY OR DEDUCTED FROM ANY UNPAID BALANCE ON THE CONTRACT OR PURCHASE ORDER.</p> <p>BY SUBMISSION OF THIS CERTIFICATE, BIDDER AGREES TO DISCLOSE ANY REASONABLY REQUESTED INFORMATION TO THE PURCHASING DIVISION AND AUTHORIZES THE DEPARTMENT OF TAX AND REVENUE TO DISCLOSE TO THE DIRECTOR OF PURCHASING APPROPRIATE INFORMATION VERIFYING THAT BIDDER HAS PAID THE REQUIRED BUSINESS TAXES, PROVIDED THAT SUCH INFORMATION DOES NOT CONTAIN THE AMOUNTS OF TAXES PAID NOR ANY OTHER INFORMATION DEEMED BY THE TAX COMMISSIONER TO BE CONFIDENTIAL.</p> <p>UNDER PENALTY OF LAW FOR FALSE SWEARING (WEST VIRGINIA CODE 61-5-3), BIDDER HEREBY CERTIFIES THAT THIS</p>						

SEE REVERSE SIDE FOR TERMS AND CONDITIONS

SIGNATURE	TELEPHONE	DATE
-----------	-----------	------

TITLE	FEIN	ADDRESS CHANGES TO BE NOTED ABOVE
-------	------	-----------------------------------

WHEN RESPONDING TO RFQ, INSERT NAME AND ADDRESS IN SPACE ABOVE LABELED 'VENDOR'



State of West Virginia
 Department of Administration
 Purchasing Division
 2019 Washington Street East
 Post Office Box 50130
 Charleston, WV 25305-0130

Request for Quotation

RFQ NUMBER
DNR90185

PAGE
4

ADDRESS CORRESPONDENCE TO ATTENTION OF
FRANK WHITTAKER 304-558-2316

RFQ COPY

TYPE NAME/ADDRESS HERE

SHIP TO

DIVISION OF NATURAL RESOURCES
 PIPESTEM STATE PARK
 ATTN: PARK SUPERINTENDENT
 STATE ROUTE 20
 PIPESTEM, WV
 25979 304-466-2804

DATE PRINTED	TERMS OF SALE	SHIP VIA	F.O.B.	FREIGHT TERMS
07/16/2008				

BID OPENING DATE: **07/30/2008** BID OPENING TIME **01:30PM**

LINE	QUANTITY	UOP	CAT NO	ITEM NUMBER	UNIT PRICE	AMOUNT
<p>CERTIFICATE IS TRUE AND ACCURATE IN ALL RESPECTS; AND THAT IF A CONTRACT IS ISSUED TO BIDDER AND IF ANYTHING CONTAINED WITHIN THIS CERTIFICATE CHANGES DURING THE TERM OF THE CONTRACT, BIDDER WILL NOTIFY THE PURCHASING DIVISION IN WRITING IMMEDIATELY.</p> <p style="text-align: center;">NOTICE</p> <p>A SIGNED BID MUST BE SUBMITTED TO:</p> <p style="text-align: center;">DEPARTMENT OF ADMINISTRATION PURCHASING DIVISION BUILDING 15 2019 WASHINGTON STREET, EAST CHARLESTON, WV 25305-0130</p> <p>THE BID SHOULD CONTAIN THIS INFORMATION ON THE FACE OF THE ENVELOPE OR THE BID MAY NOT BE CONSIDERED:</p> <p>SEALED BID</p> <p>BUYER: 44</p> <p>RFQ. NO.: DNR90185</p> <p>BID OPENING DATE: 08/05/08</p> <p>BID OPENING TIME: 1:30 PM</p> <p>PLEASE PROVIDE A FAX NUMBER IN CASE IT IS NECESSARY TO CONTACT YOU REGARDING YOUR BID:</p>						

SEE REVERSE SIDE FOR TERMS AND CONDITIONS

SIGNATURE	TELEPHONE	DATE
TITLE	FEIN	ADDRESS CHANGES TO BE NOTED ABOVE

WHEN RESPONDING TO RFQ, INSERT NAME AND ADDRESS IN SPACE ABOVE LABELED 'VENDOR'



State of West Virginia
 Department of Administration
 Purchasing Division
 2019 Washington Street East
 Post Office Box 50130
 Charleston, WV 25305-0130

Request for Quotation

RFQ NUMBER
DNR90185

PAGE
5

ADDRESS CORRESPONDENCE TO ATTENTION OF
FRANK WHITTAKER 304-558-2316

RFQ COPY
 TYPE NAME/ADDRESS HERE

VENDOR

SHIP TO

**DIVISION OF NATURAL RESOURCES
 PIPESTEM STATE PARK
 ATTN: PARK SUPERINTENDENT
 STATE ROUTE 20
 PIPESTEM, WV
 25979 304-466-2804**

DATE PRINTED	TERMS OF SALE	SHIP VIA	F.O.B.	FREIGHT TERMS
07/16/2008				

BID OPENING DATE: **07/30/2008** BID OPENING TIME **01:30PM**

LINE	QUANTITY	UOP	CAT. NO.	ITEM NUMBER	UNIT PRICE	AMOUNT

CONTACT PERSON (PLEASE PRINT CLEARLY):						

***** THIS IS THE END OF RFQ DNR90185 ***** TOTAL: _____						

SEE REVERSE SIDE FOR TERMS AND CONDITIONS

SIGNATURE	TELEPHONE	DATE
TITLE	FEIN	ADDRESS CHANGES TO BE NOTED ABOVE

WHEN RESPONDING TO RFQ, INSERT NAME AND ADDRESS IN SPACE ABOVE LABELED 'VENDOR'

Buffet Line Restaurant Equipment
Bluestone Dining Room
Pipestem Resort State Park

This requisition is for the purchase of new restaurant buffet equipment for the Bluestone Dining Room at McKeever Lodge, Pipestem State Park. All equipment furnished shall be as manufactured by the Vollrath Company LLC., 1236 N.18th St., Sheboygan, WI 53082, or equal.

All bids are to include shipping costs and crating. Shipments for all equipment must be together and not separated at various time intervals. Items received damaged will be returned at bidder's expense with bidder responsible for re-shipment of item to avoid project delays. Should lift gate service be required, bidder must include with bid.

Shipments are only accepted Monday through Thursday from 9:00 am to 2:00 pm (excluding holidays). Shipper must contact Superintendent of Park prior to shipping date to allow storage area preparation. The Park Superintendent's telephone number is 304-466-2804 (8:30 am to 4:30 pm).

All equipment shall be delivered no more than 120 calendar days from receipt of purchase order and signed approved drawings.

All measurements for Vollrath buffet equipment is accurate to existing buffet equipment. All bids submitted with any deviations shall submit complete specifications and drawings confirming placement. All colors, finishes and countertop materials have been selected to match existing dining room décor and should not change.

Warranty should be against defects in materials and workmanship for a period of one year.

Should you have questions, please contact:

Frank Whittaker, Senior Buyer, Purchasing Division
PO Box 50130, Charleston, WV 25305-0130
Phone: 304-558-2316 Fax: 304-558-4115
Email: Frank.M.Whittaker@wv.gov

Specifications

Server 1: Carving Station 32" L x 32"W x 34"H
Server Type: Carving Station, Material: Aluminum Composite Material (ACM)
construction, Total AMPS for the Unit: 4.6

Finish: Formica Brand Woodgrains, Color Number: 7008 Acajou Mahogany, Customer
Side Door Style: Hinged Door Panel, Server Support: 5" Locking Casters, Toe Kick: Toe
Kick

Heat Lamps: One Heat Lamp w/Cutting Board, Heat Lamp Finish: Brass, Scrap Bin: Yes,
Swinging Doors: Yes

Countertop Material Type: Corian Solid Surface
Countertop Material Number: Pompeii Red

Server 1: Base 78"L x 40"W x 34"H
Server Type: Base, Material: Aluminum Composite Material (ACM) construction, Total
AMPS for the Unit: 18.4

Finish: Formica Brand Woodgrains, Color Number: 7008 Acajou Mahogany, Customer
Side Door Style: Hinged Door Panel, Server Support: 5" Locking Casters, Toe Kick: Toe
Kick

Countertop Material Type: Corian Solid Surface, Countertop Material Number: Pompeii
Red

Breath Guard Type: Double-Sided Self Service Buffet, Finish: Brass

Panel Options: Both End Panels, Lighting Options: Cayenne Heat Strip w/Lights
w/Remote Toggle (120V)

Drop-In #1: Plate Dispenser 9-1/4 to 10-1/8" Centered, Vollrath Model: 2323107,
Description: Dish Dispenser, open frame drop-in, single self-leveling dish dispensing
tube, maximum dish size 10-1/8" diameter, stainless steel construction, NSF
Covered by a breath guard? No

Drop-In #2: 3 Well Hot 240 Volt, Vollrath Model: 3647350, Description: 3-well hot
modular drop-in w/infinite controls & manifold drains, drip-free flng, ind drain shutoffs,
6-3/8" dp wells operate moist/dry, dial controls, 625W per well, 208V, 9.0A, 6-15P plug,
OA 41-1/2" x 26", cutout 40-3/4" x 25-1/4", 7/8" corner radius
Covered by a breath guard? Yes

Server 2: Base 72"L x 40"W x 34"H
Server Type: Base, Material: Aluminum Composite Material (ACM) construction, Total
AMPS for the Unit: 25.5

Finish: Formica Brand Woodgrains, Color Number: 7008 Acajou Mahogany, Customer Side Door Style: Hinged Door Panel, Server Support: 5" Locking Casters, Toe Kick: Toe Kick

Countertop Material Type: Corian Solid Surface, Countertop Material Number: Pompeii Red

Breath Guard Type: Double-Sided Self Service Buffet, Finish: Brass

Panel Options: Both End Panels

Lighting Options: Cayenne Heat Strip w/Lights w/Remote Toggle (120V)

Extend Breath Guard Full Length? Yes

Drop-In #1: 4 Well Hot 240 Volt

Vollrath Model 3647450

Description: 4-WELL HOT MODULAR DROP-IN W/INFINITE CONTROLS & MANIFOLD DRAINS, drip-free flange, ind drain shutoffs, 6-3/8" deep wells operate moist/dry, dial controls, 625W per well, 208V, 12.0A, 6-15P plug, OA 54-3/4" x 26", cutout 54" x 25-1/4", 7/8" corner radius

Covered by a breath guard? Yes

Server 1: Base 78"L x 40"W x 34"H

Server Type: Base, Material: Aluminum Composite Material (ACM) construction, Total AMPS for the Unit: 5.2

Finish: Formica Brand Woodgrains, Color Number: 7008 Acajou Mahogany, Customer Side Door Style: Hinged Door Panel, Server Support: 5" Locking Casters, Toe Kick: Toe Kick

Countertop Material Type: Corian Solid Surface, Countertop Material Number: Pompeii Red

Breath Guard Type: Double-Sided Self Service Buffet, Finish: Brass

Panel Options: Both End Panels, Lighting Options: Fluorescent

Drop-In #1: Plate Dispenser 7-3/8 to 8-1/8" Double

Vollrath Model: 2323105

Description: Dish Dispenser, open frame drop-in, single self-leveling dish dispensing tube, maximum dish size 8-1/8" diameter, stainless steel construction, NSF

Covered by a breath guard? No

Drop-In #2: 3 Pan NSF7 Refrig

Vollrath Model: 36430

Description: 3-PAN NSF7 REFRIGERATED COLD PAN MODULAR DROP-IN, 18-8 s/s, drip-free flange, polyurethane foam insulation, 3" deep well, ¼ HP compressor, 120V, 4.9A, 5-15P plug, OA dim 41-1/2" x 26", cutout dim 40-3/4" x 25-1/4", 7/8" corner radius, display area length 37-1/2", USA made
Covered by a breath guard? Yes

Server 2: Base 72"L x 40"W x 34"H

Server Type: Base, Material: Aluminum Composite Material (ACM) construction, Total AMPS for the Unit: 7.5

Finish: Formica Brand Woodgrains, Color Number: 7008 Acajou Mahogany, Customer Side Door Style: Hinged Door Panel, Server Support: 5" Locking Casters, Toe Kick: Toe Kick

Countertop Material Type: Corian Solid Surface, Countertop Material Number: Pompeii Red

Breath Guard Type: Double-Sided Self Service Buffet, Finish: Brass
Panel Options: Both End Panels, Lighting Options: Fluorescent, Extend Breath Guard Full Length? Yes

Drop-In #1: 4 Pan NSF7 Refrig

Vollrath Model: 36434

Description: 4-PAN NSF7 REFRIGERATED COLD PAN MODULAR DROP-IN, 18-8 s/s, drip-free flange, polyurethane foam insulation, 3" deep well, 1/3 HP compressor, 120V, 7.2A, 5-15P plug, OA dim 54-3/4" x 26", cutout dim 54"x 25-1/4", 7/8" corner radius, display area length 50-1/4", USA made
Covered by a breath guard? Yes

Server 1: Base 36"L x 40"W x 34"H

Material: Aluminum Composite Material (ACM) construction
Total Amps for Unit: 6

Finish: Formica Brand Woodgrains, Color Number: 7008 Acajou Mahogany, Customer Side Door Style: Hinged Door Panel, Server Support: 5" Locking Casters, Toe Kick: Toe Kick

Countertop Material Type: Corian Solid Surface, Countertop Material Number: Pompeii Red

Drop-In #1: Soup Well 7 Qt. (120V) Customer Side, Vollrath Model: 3646210

Description: SOUP WELL< MODULAR DROP_IN W/THERMOSTATIC CONTROL, holds one 7-1/4 qt inset, s.s. well, 3/4" drain, power cord, control cord for remote installation, dia. over flange 11-3/16", cutout dia. 10-9/16", well outer dia. 10-5/16, 120V, 720W, 6.0A, 5-15P, UL, CUL, NSF4, USA made

Covered by breath guard?: No

Custom Notes: Drop in to be installed on customer left side.

QUOTE #002282

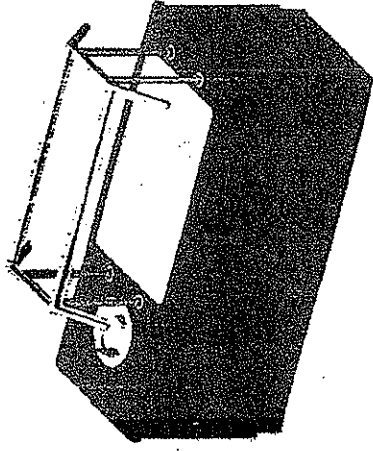

Revised Dimension By Brian Carney

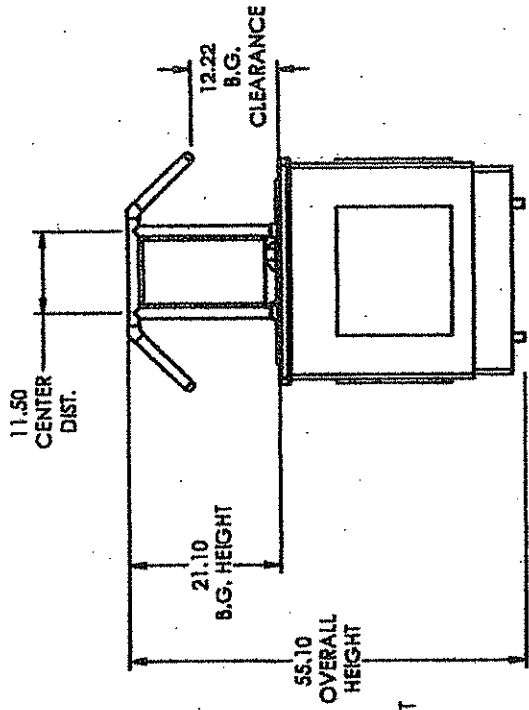
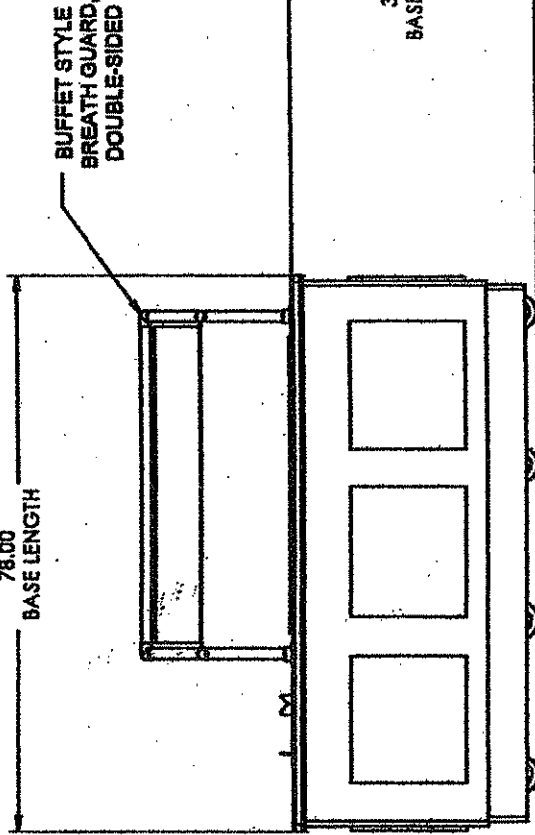
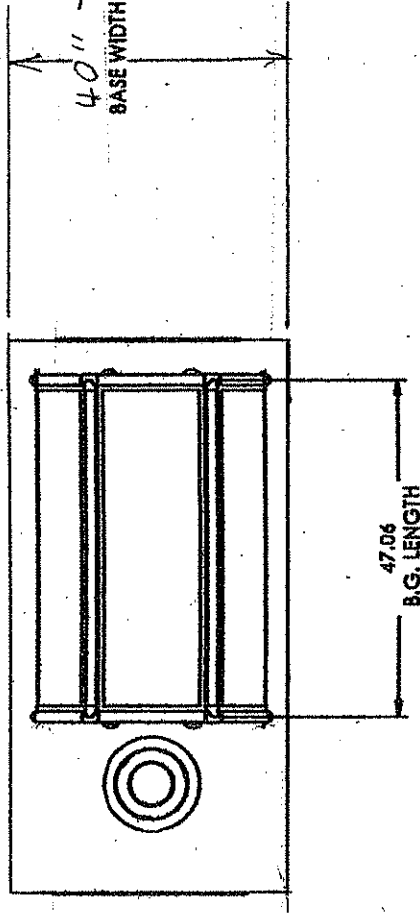

CONFIDENTIAL DESIGN

The Voltrath Company, L.L.C. ("Voltrath") considers this an
 design proprietary and confidential. One is to be used only for
 the purpose of manufacturing and/or assembly of the product.
 Voltrath is not responsible for any unauthorized use, disclosure,
 or distribution of this information. Voltrath shall not be held
 liable for any damages, including consequential damages, arising
 from the use of this information without the express
 written prior consent of The Voltrath Company, L.L.C.

- NOTES:
1. Add second 8 to 10" lowerator
 3. Custom width of countertop to be 40". Add 25% cost to countertop.



NEMA Configuration: 14-30R
 Total Amps: 18.4

DO NOT SCALE THIS DRAWING

Premier Server
 Assembly

TOLERANCE UNLESS OTHERWISE SPECIFIED	1"
3 P.L. DEC.	3.281
3 P.L. DEC.	3.281
3 P.L. DEC.	3.281

VOLTRATH

THE VOLTRATH COMPANY
 SHREVEPORT, LA, USA

QUOTE #002282

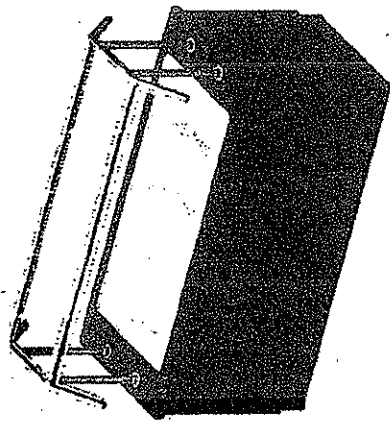

Revised Dimension by Brian Carney

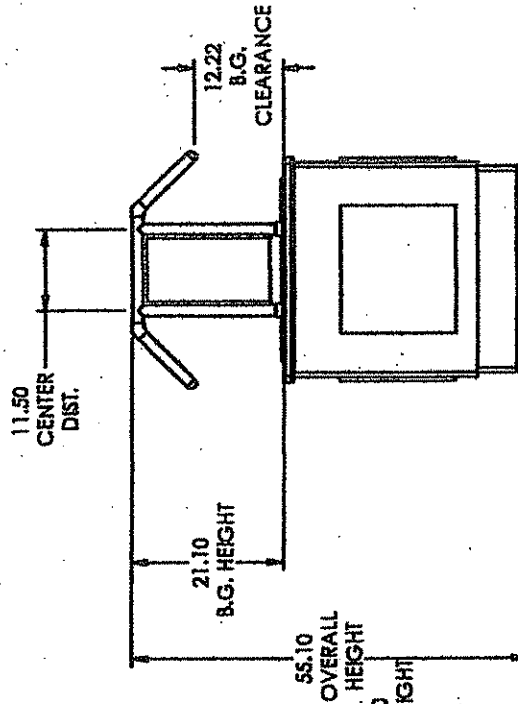
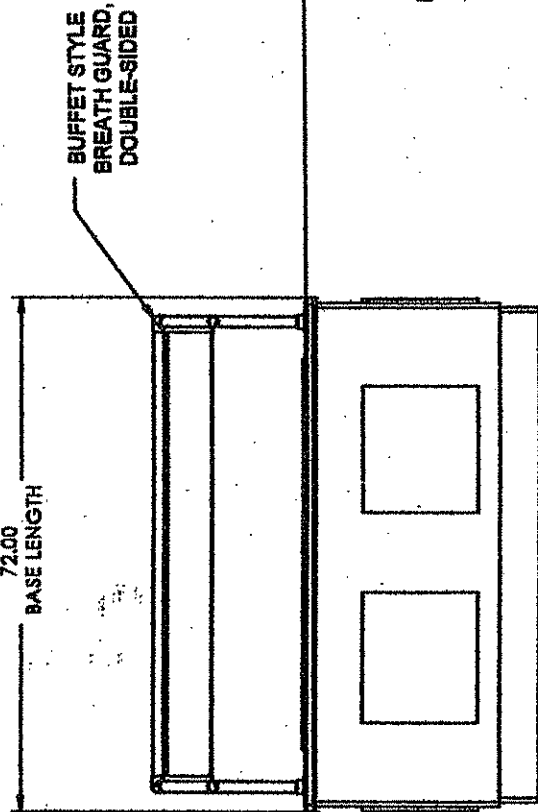
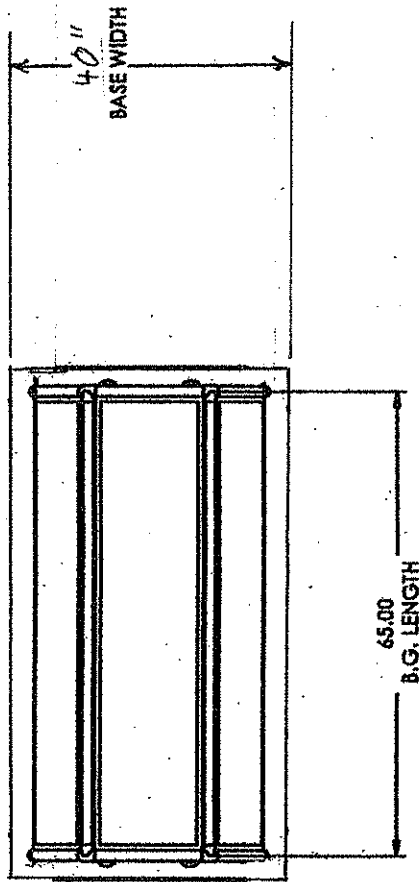

CONFIDENTIAL DESIGN
The Viltrak Company, L.L.C. ("Viltrak") warrants the accuracy of the information provided herein. Viltrak is providing this preliminary multi-disciplinary design for informational purposes only. It is not intended to be used for construction or any other purpose without the written consent of Viltrak. Viltrak shall not be held liable for any errors or omissions in this preliminary design.

NOTES:
2. Custom width of counter top to 47". Add 25% to cost of counter top.



NEMA Configuration: 14-60R
Total Amps: 25.5

DO NOT SCALE THIS DRAWING
Premier Server Assembly
TOLERANCE UNLESS OTHERWISE SPECIFIED
3 PL. DES. 3 PL. DES. 3 PL. DES. 3 PL. DES.
VOLLRATH

QUOTE #002280

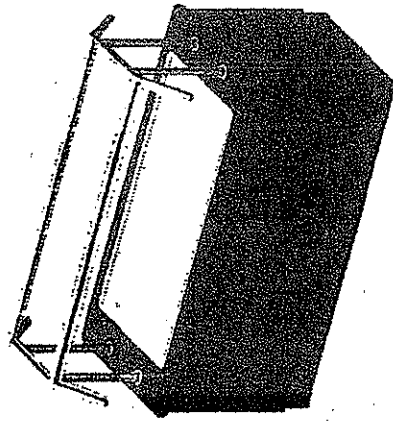

Revised Dimension By Brian Carney

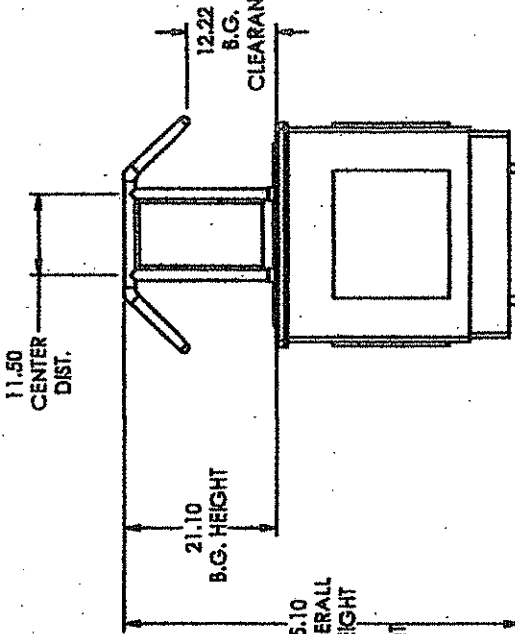
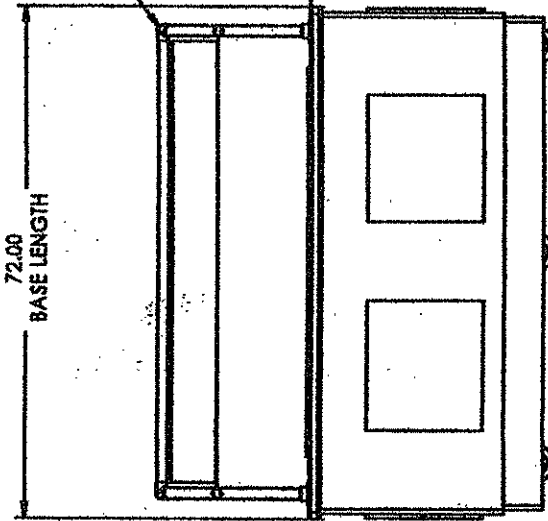
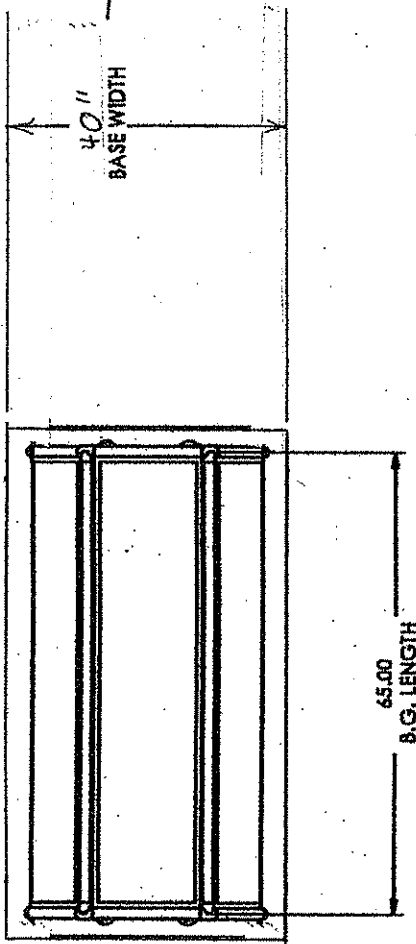

- NOTES:
1. Countertop to be modified to 40" width.
 2. Add 25% to cost of top in the top.

CONFIDENTIAL DESIGN

The Vollrath Company, L.L.C. ("Vollrath") provides this drawing to you as a confidential document. It is the property of Vollrath and is not to be used, copied, or disseminated in any form without the express written consent of Vollrath. This document is provided to you for your use only and is not to be used for any other purpose. If you have any questions, please contact your account manager or the Vollrath Customer Service Department.



NEMA Configuration: 5-15R
Total Amps: 7.5

DO NOT SCALE THIS DRAWING

Premier Server Assembly

TOLERANCE UNLESS OTHERWISE SPECIFIED	3 PL. DEC.	4.00	ANGLES	A.11
1 PL. DEC.	3.00	4.00	ANGLES	A.11

VOLLRATH

THE VOLLRATH CO. L.L.C.
BIRCHMOUNT, W. VIRGINIA

QUOTE #002278

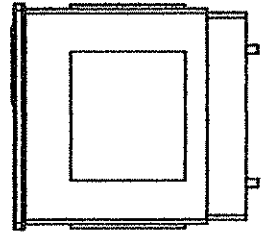
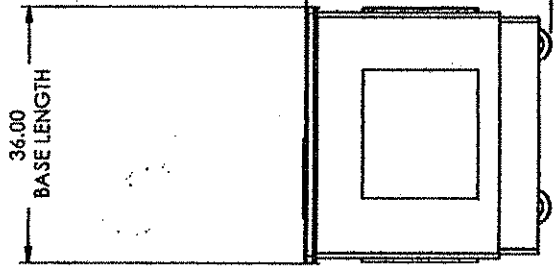
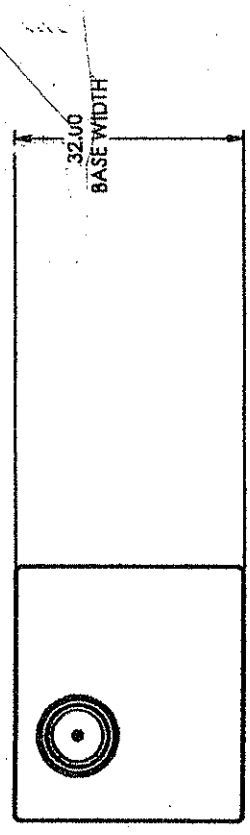
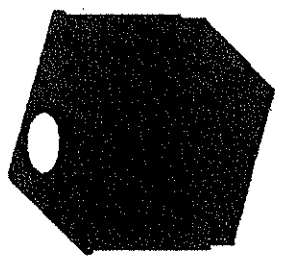

CONFIDENTIAL DESIGN
The Vendor Company, L.L.C. ("Vendor") considers this user manual to be a confidential document. Vendor and its employees, agents, contractors, and subcontractors are prohibited from disclosing this information to any third party without the express written consent of Vendor. Vendor is providing this proprietary and confidential design and related information to recipient with the understanding that recipient will not directly or indirectly use, disseminate, or otherwise disclose this proprietary and confidential information to any third party or organization without the express written consent of Vendor.

NOTES:
Drop in to be installed on customer left side.

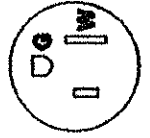

NEMA Configuration: S-15R
Total Amps: 6

DO NOT SCALE THIS DRAWING

Premier Server Assembly

2 PL. DEC.	3 PL. DEC.	4.001	3.1"
2 PL. DEC.	3 PL. DEC.	4.001	3.1"

TOLEANCE UNLESS OTHERWISE SPECIFIED

VOLLRATH

THE VOLLRATH CO., L.L.C.

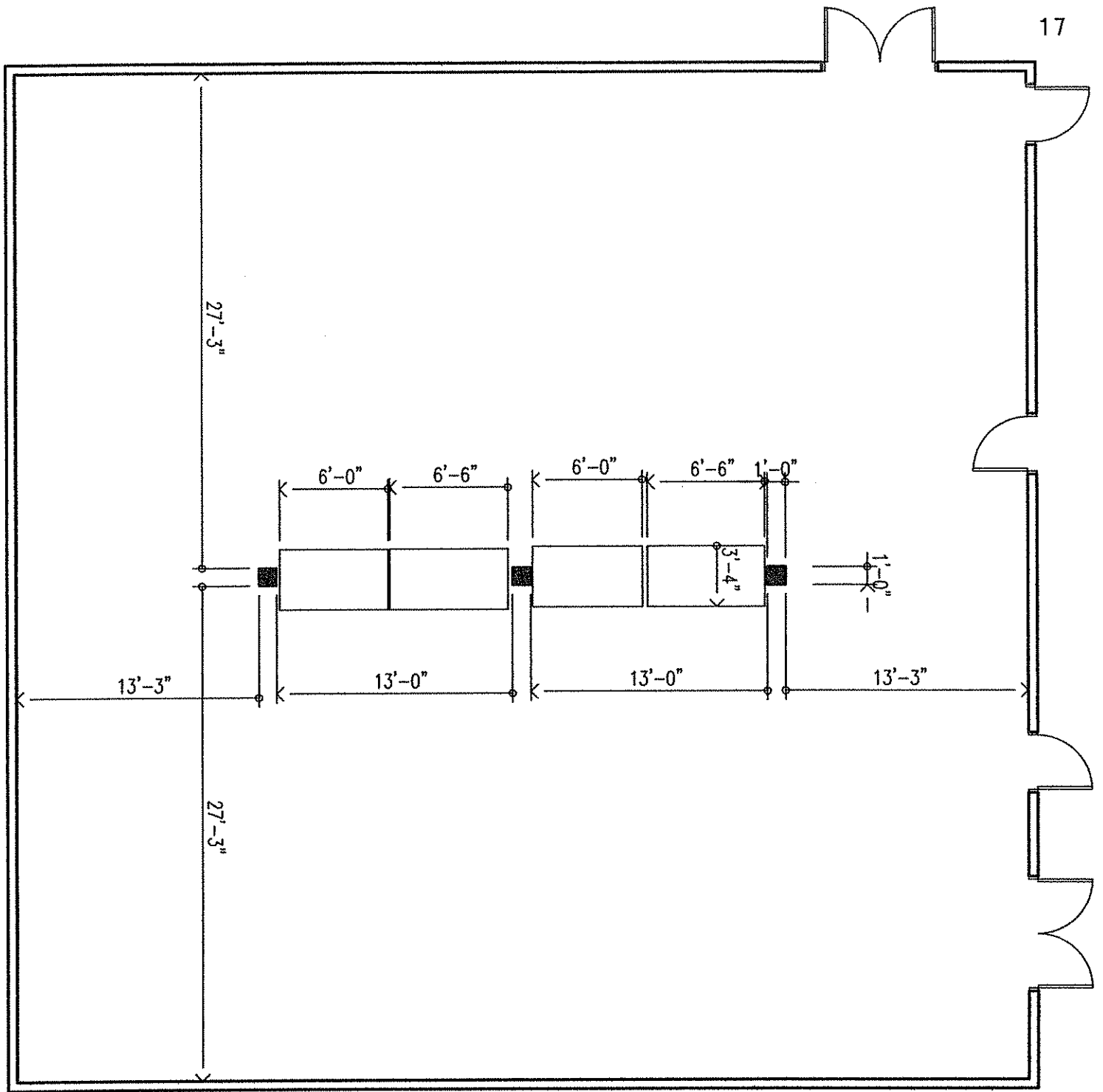

STATE OF WEST VIRGINIA
Purchasing Division

PURCHASING AFFIDAVIT

West Virginia Code §5A-3-10a states: No contract or renewal of any contract may be awarded by the state or any of its political subdivisions to any vendor or prospective vendor when the vendor or prospective vendor or a related party to the vendor or prospective vendor is a debtor and the debt owed is an amount greater than one thousand dollars in the aggregate

DEFINITIONS:

"Debt" means any assessment, premium, penalty, fine, tax or other amount of money owed to the state or any of its political subdivisions because of a judgment, fine, permit violation, license assessment, defaulted workers' compensation premium, penalty or other assessment presently delinquent or due and required to be paid to the state or any of its political subdivisions, including any interest or additional penalties accrued thereon.

"Debtor" means any individual, corporation, partnership, association, limited liability company or any other form or business association owing a debt to the state or any of its political subdivisions. "Political subdivision" means any county commission; municipality; county board of education; any instrumentality established by a county or municipality; any separate corporation or instrumentality established by one or more counties or municipalities, as permitted by law; or any public body charged by law with the performance of a government function or whose jurisdiction is coextensive with one or more counties or municipalities. "Related party" means a party, whether an individual, corporation, partnership, association, limited liability company or any other form or business association or other entity whatsoever, related to any vendor by blood, marriage, ownership or contract through which the party has a relationship of ownership or other interest with the vendor so that the party will actually or by effect receive or control a portion of the benefit, profit or other consideration from performance of a vendor contract with the party receiving an amount that meets or exceed five percent of the total contract amount.

EXCEPTION: The prohibition of this section does not apply where a vendor has contested any tax administered pursuant to chapter eleven of this code, workers' compensation premium, permit fee or environmental fee or assessment and the matter has not become final or where the vendor has entered into a payment plan or agreement and the vendor is not in default of any of the provisions of such plan or agreement.

LICENSING: Vendors must be licensed and in good standing in accordance with any and all state and local laws and requirements by any state or local agency of West Virginia, including, but not limited to, the West Virginia Secretary of State's Office, the West Virginia Tax Department, West Virginia Insurance Commission, or any other state agencies or political subdivision. Furthermore, the vendor must provide all necessary releases to obtain information to enable the Director or spending unit to verify that the vendor is licensed and in good standing with the above entities.

CONFIDENTIALITY: The vendor agrees that he or she will not disclose to anyone, directly or indirectly, any such personally identifiable information or other confidential information gained from the agency, unless the individual who is the subject of the information consents to the disclosure in writing or the disclosure is made pursuant to the agency's policies, procedures and rules. Vendors should visit www.state.wv.us/admin/purchase/privacy for the Notice of Agency Confidentiality Policies.

Under penalty of law for false swearing (West Virginia Code, §61-5-3), it is hereby certified that the vendor acknowledges the information in this said affidavit and are in compliance with the requirements as stated.

Vendor's Name: _____

Authorized Signature: _____ Date: _____