

SOLE SOURCE DETERMINATION

The Purchasing Division has been requested to approve a sole source purchase for the commodity or service described below. Pursuant to West Virginia Code 5A-3-10c, the Purchasing Division is attempting to determine whether the commodity or service is a sole source procurement. If you believe your company meets the required experience and qualification criteria stated below, please e-mail the Purchasing Division Buyer at Krista.s.ferrell@wv.gov with a copy to Karen.Q.Byrd@wv.gov to express your interest in the project. Please forward any and all information that will support your company's compliance with required qualification and eligibility criteria along with any other pertinent information relative to this project to the Purchasing Division no later than January 22, 2009.

Requisition Number: AVN096604 Department/Agency: Aviation

Detailed Description of Project: (1) New 2009 Cessna 208B2077 Aircraft per the attached specifications.

Proposed Sole Source Vendor: Cessna Aircraft Company

Specific Eligibility Criteria: Vendor must accept as a trade in (1) Cessna 2005 208B1132 Aircraft. Vendor must be an authorized Cessna retailer.

Specific Qualification Criteria: N/A

Exhibit A

Purchaser: _____ Seller: _____

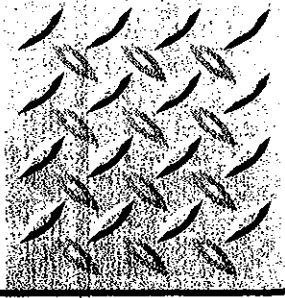

GRAND CARAVAN

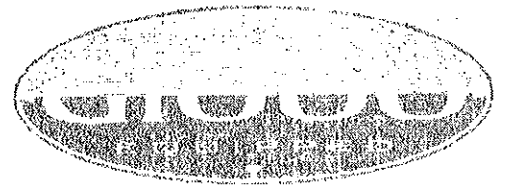
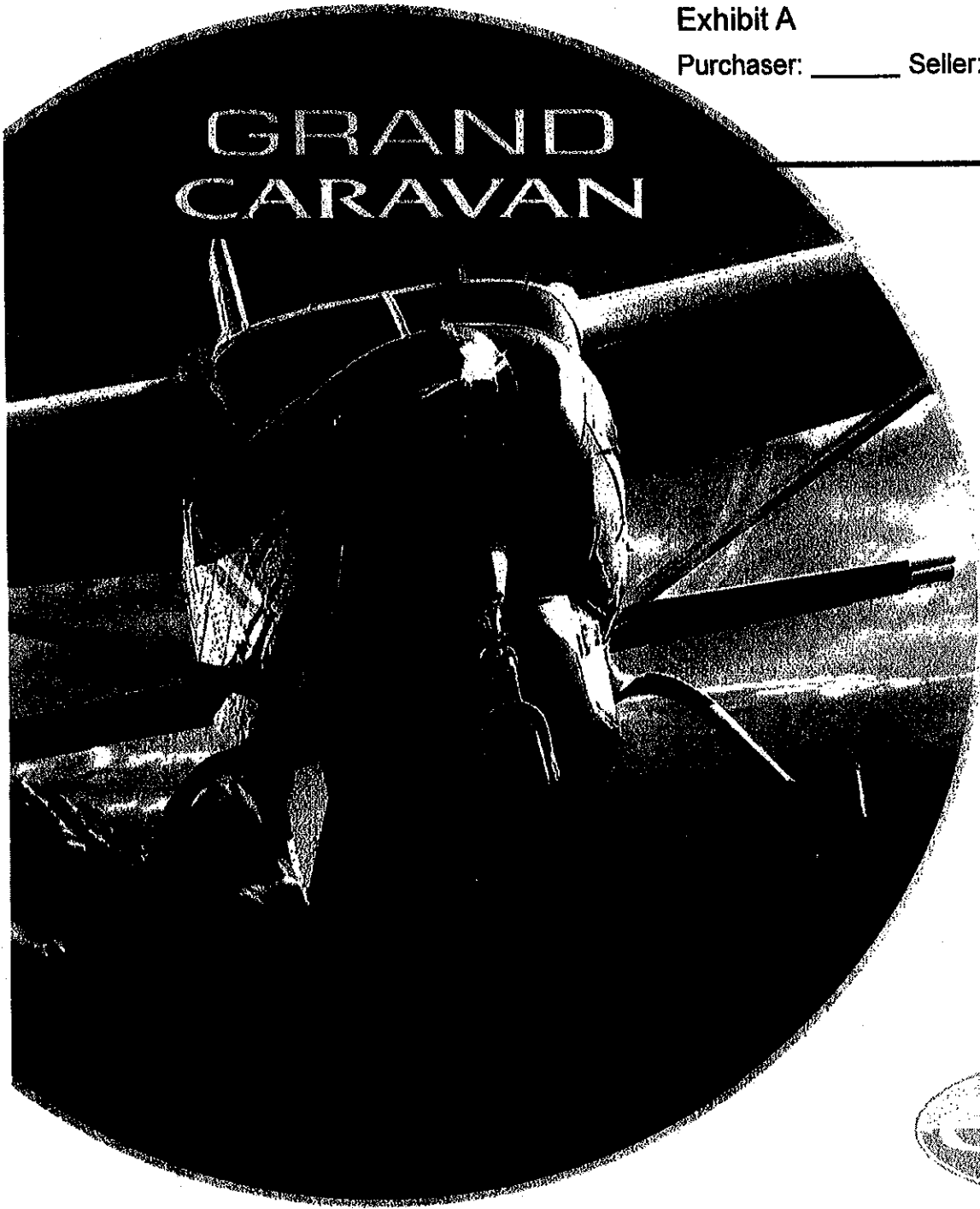

Specification & Description

August 2007
(G1000 equipped units 208B-2000 and on)

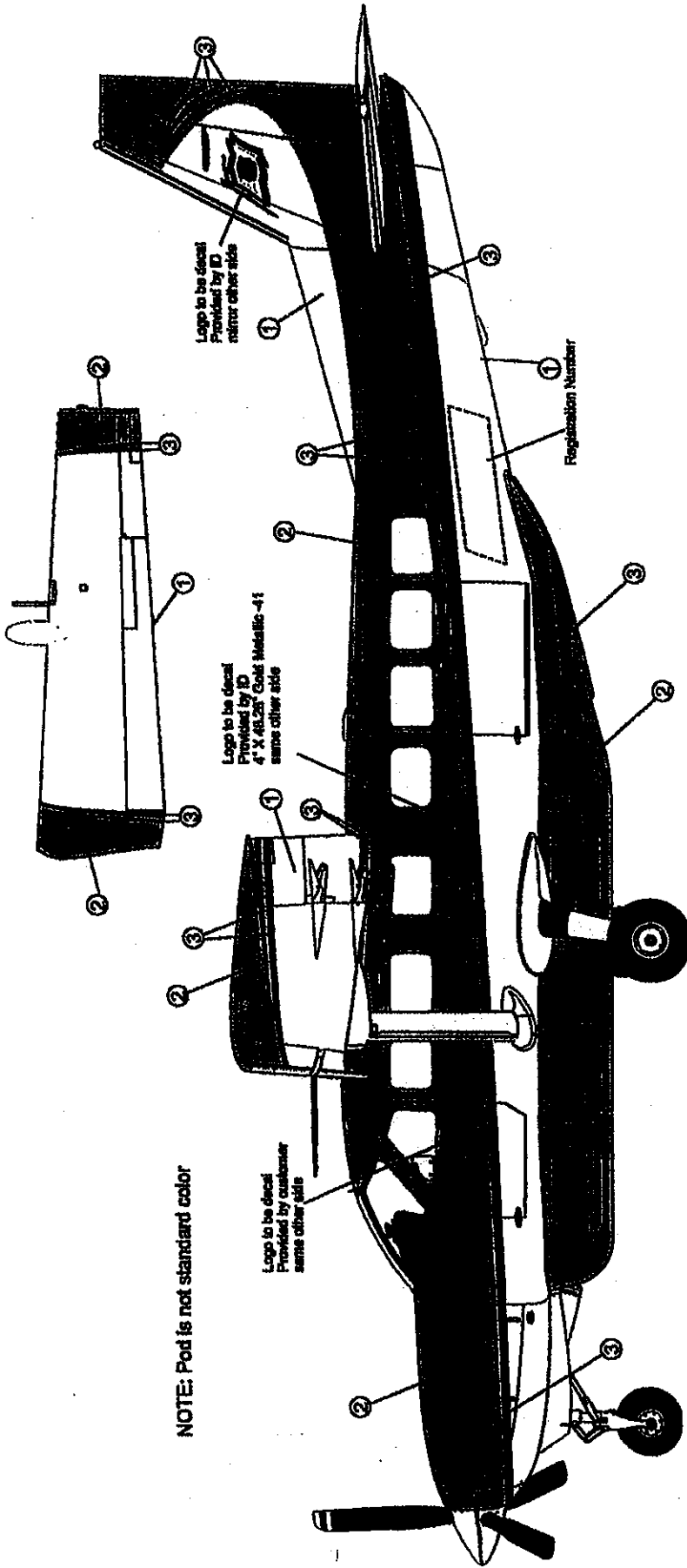

NOTE: Pod is not standard color

**GRAND
CARAVAN**



UNIT NUMBER: 20862077

| REGISTRATION NUMBER | DATE: 9/12/88 | PAINT CODE | COLOR |
|---|-------------------------|------------|--------------------|
| LOCATION: Lower Fuselage | DRAWN BY: Roger Keating | 1 AHS-G-35 | Matthorn White |
| STYLE: Slant | RENDERING VERSION: 6 | 2 P1230 | Dark Blue Metallic |
| | LINE DRAWING: A | 3 P1183 | Las Vegas Gold Met |
| COLOR: Dark Blue Met with Las Vegas Gold shadow | | 4 | |
| | | 5 | |
| | | 6 | |
| | | 7 | |

STANDARD SPECIAL

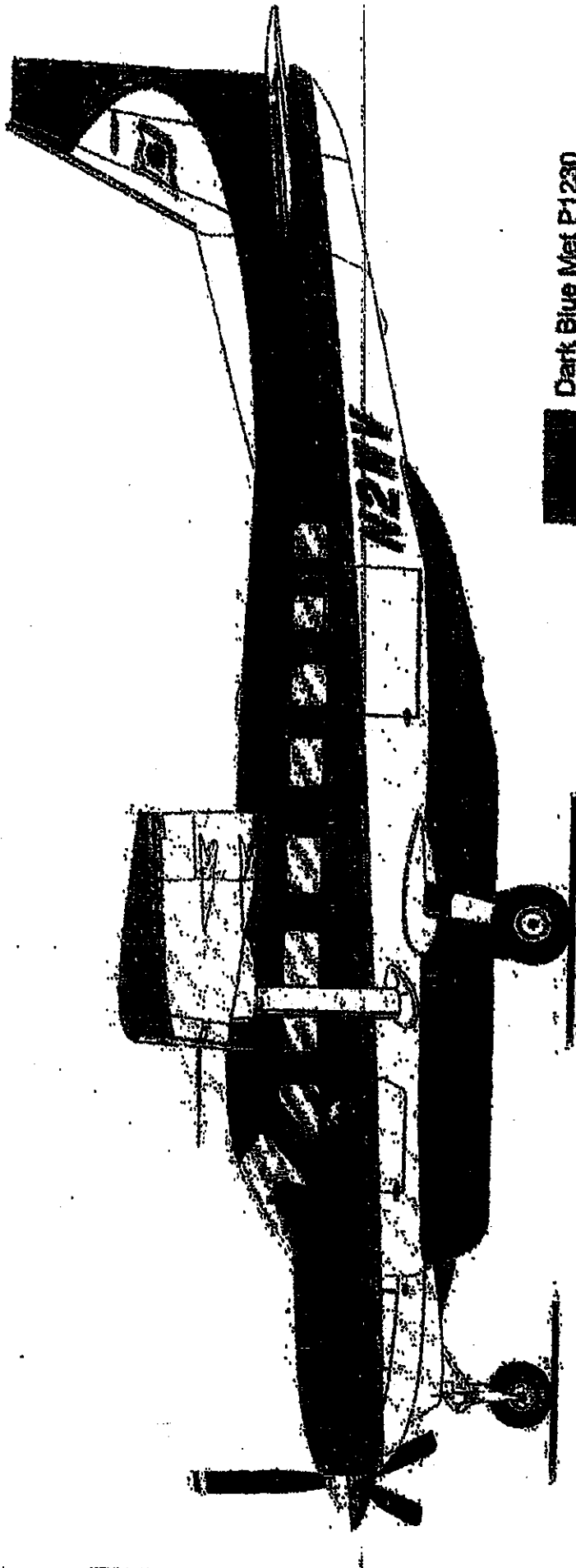
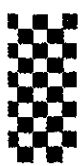

Dark Blue Met P1230

Las Vegas Gold Met P1183

 Serial Number: 20852077
 Rendering Version: 6
 Date: 06/22/08
 Drawn By: RCK

GRAND
CARAVAN

OK
[Handwritten signature]
 Date: 01/07/09
 2/5/09



Cessna Caravan Oasis Interior

Purchase Agreement 2008

Serial No./ Reg. No.

Date: 1-07-09

State of West Virginia

Oasis Interior:

please mark your selection

Oasis Floor Plan (FAA, EASA, CTA approved STC)

| | | |
|---|---|---|
| X | A | 10 Place including crew - aft dual divan certified for occupancy with toilet - aft club, fwd cabinets |
| | B | 10 Place including crew - aft dual divan certified for occupancy with toilet - forward club, fwd cabinets |
| | C | 10 Place including crew - aft dual divan certified for occupancy with toilet - aft club, mid ship cabinets |
| | D | 11 Place including crew - aft dual divan certified for occupancy with toilet - half club and single fwd cabinet |
| | E | 11 Place including crew - 8 fwd facing seats - single seat toilet with cargo storage certified for occupancy |
| | F | 8 Place including crew - certified for occupancy aft dual divan with toilet - club with fwd cabinets |
| | | Cargo/Seat Conversion upgrade (available all floor plans) |
| | | <i>*Requires Cessna Provisions for aft lap belt (for Yingling to install the aft belt provisions the cost is \$7,500. And an additional 8 day) downtime.)</i> |

OASIS Floor plans

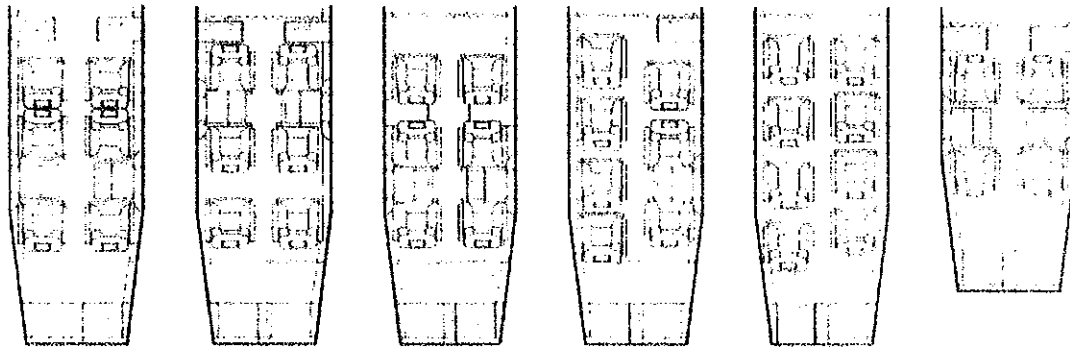

FLOOR PLAN A FLOOR PLAN B FLOOR PLAN C FLOOR PLAN D FLOOR PLAN E FLOOR PLAN F

Oasis Features

| | | | |
|----|---|---|---|
| X | 6 Executive seats are covered in leather and fully featured. | X | Aft divan with lavatory belted for take off and landing |
| X | Executive side tables with leather writing surface | X | Sidewall accent trim with metal inlay |
| X | Forward cabinets which include, thermos, ice liners, and locked drawer (Floor Plan A, B, F) | | 100% wool carpet level loop with tip sheer |
| NO | Mid Ship cabinets includes thermos and ice liner. (Floor Plan C) | X | (2) 110 outlets |
| X | Decorative lower sidewall fabric | X | Reupholstered crew seats to match interior |
| X | Forward closeout curtain | X | Aft close out curtain |

Oasis Color Options

Huntington (solid leather inserts)

Starlight (perforated leather inserts)

Mayan Sunrise (solid leather inserts)

Sandalwood (perforated leather inserts)

Prices are valid though 9-30-08
Prices are subject to change without notice.

Accepted By: _____

Date: _____



Cessna Caravan Oasis Interior

Purchase Agreement 2008

Serial No./ Reg. No.

Date: 1-07-09

Please see swatch cards for detailed material information

Oasis Extra's

- Aft full length curtain
- Forward split curtain full length
- Forward split curtain half length
- Forward Dividers
- Sm. Mid-Ship Cabinet at 7,800. each

Interior Options, (FAA 337 field approval installation)

- Plating
- Headliner Replacement
- Painted Window Reveals
- Leather Wrapped Control Wheels
- Window Curtains

Interior Options, (Loose Equipment)

- Center Console
- Utility Slipcovers: 6 Passenger Seats, 2 Crew Seats
- Vinyl Floor Mats
- Extra Set Loose Carpet Mats
(2) Sheepskin Slipcovers for Crew
- Tail Stand
- Cowl Plugs
- Pitot Tube Covers

Airframe Options (Installed on FAA 337 using approved data)

- Extended Baggage Compartment (Aftermarket STC)
- Single Point Fueling System (Aftermarket STC)
- 208 APE II Kit (Aftermarket STC) (TO wt increase of 362 lbs)
- 208 APE III Kit (Aftermarket STC) (TO wt increase of 362 lbs, Ldg wt increase of 562 lbs)
- 208B APE II Kit (Aftermarket STC) (TO wt increase of 312 lbs)
- 208B APEIII Kit (Aftermarket STC) (TO wt increase of 362 lbs, Ldg wt increase of 500 lbs)

Avionics Options, (FAA 337 field approval installation)

Entertainment

Select Entertainment Options

Three Sirius 7" screens with 3 sidewall mounts, one DVD player with remote, Six wireless headsets. (Floor Plans A & C.)
(Fwd. monitor sidewall mount will be replaced with ceiling mount when optional fwd. dividers are specified on page 1)

\$24,375.

Prices are valid through 9-30-08
Prices are subject to change without notice.

Accepted By: _____

Date: _____



Cessna Caravan Oasis Interior

Purchase Agreement 2008

Serial No./ Reg. No.

Date: 1-07-09

Three Sirius 7" screens with two sidewall mounts and one ceiling mount, one DVD player with remote, Six wireless headsets. (Floor plans B & D) (Fwd. monitor sidewall mount will be replaced with ceiling mount when optional fwd. dividers are specified on page 1)

Three Sirius 7" screens with three ceiling mounts, one DVD player with remote, six wireless headsets. (Floor plan E)

Deluxe Entertainment Options

Three Rosen 7" screens with 5 mounts and arms, one DVD player with remote, 6 wireless headsets. (Floor Plan A & C)

Two Rosen 7" screens with 4 mounts and arms, one Sirius 7" screen with ceiling mount, one DVD player with remote, 6 wireless headsets. (Floor Plan B)

Two Rosen 7" screens with 3 mounts and arms, one Sirius 7" screen with ceiling mount, one DVD player with remote, 6 wireless headsets. (Floor Plan D)

Two Rosen 7" screens with 4 mounts and arms, one DVD player with remote, 6 wireless headsets. (Floor Plan F)

Intercom

6 Place Intercom - crew plus 4 passengers

8 Place Intercom - crew plus 6 passengers

9/10 Place Intercom - crew plus 8 passengers

Flight Display Moving Map

Flight Display - Moving Map for Select Entertainment Package

Flight Display - Moving Map for Deluxe Entertainment Package

Precise Flight Pulselight

2 Channel Pulselite Kit

Cabin Lighting

LED Aisle Lights

LED Reading Lights

LED Dome Lights

Export Certificate of Airworthiness for new aircraft

Export C of A, new aircraft only

International Kit

Order Totals

Contact Information

Name

Phone

Prices are valid through 9-30-08
Prices are subject to change without notice.

Accepted By: _____

Date: _____

Exhibit B

State of West Virginia
Department of Administration State
Capitol Complex
Building 1, Room E-119
1900 Kanawha Boulevard East
Charleston, West Virginia 25305

12/15/2008

AIRCRAFT SPECIFICATIONS

2009

208B-2077

Spec Due: PAST

Preliminary Del: Febuary 2009

Revision Level: 1

| | |
|-----------------------------|--------------------------------|
| FK06M | FK06M Cargo Pod Installation |
| FK161A | FK161A 12VDC Pwrr Outlets (2) |
| FK02B | FK02B Cabin A/C |
| FK60D | FK60D Oxygen Sys, 17 Port |
| FK06V | FK06V Oasis Interior Prov |
| FK22T | FK22T TKS Ice Protect - Radar |
| FK635Q | FK635Q Traffic Advisory System |
| FK629U | FK629U GWX-68 Weather Radar |
| FK650C | FK650C Garmin TAWS |
| FK632K | FK632K XM Weather/Radio Sys |
| RENDERING #6 | RENDERING #6 |
| Exhaust Def-Installed (SAO) | Exhaust Deflector, Installed |
| Teflon Coating (SAO) | Teflon Coating, RH Carg Pod&St |
| DRAWING A | DRAWING A |
| FK655 | FK655 Jeppesen Chart View |