



The following documentation is an electronically-submitted vendor response to an advertised solicitation from the *West Virginia Purchasing Bulletin* within the Vendor Self-Service portal at *wvOASIS.gov*. As part of the State of West Virginia's procurement process, and to maintain the transparency of the bid-opening process, this documentation submitted online is publicly posted by the West Virginia Purchasing Division at *WVPurchasing.gov* with any other vendor responses to this solicitation submitted to the Purchasing Division in hard copy format.

Header 1

[List View](#)**General Information** | [Contact](#) | [Default Values](#) | [Discount](#) | [Document Information](#) | [Clarification Request](#)

Procurement Folder: 1278455

Procurement Type: Central Purchase Order

Vendor ID: 000000211224 

Legal Name: ANDERSON EXCAVATING LLC

Alias/DBA: RODNEY B ANDERSON

Total Bid: \$1,106,255.40

Response Date: 09/12/2023 

Response Time: 11:27

Responded By User ID: sjeffries 

First Name: Steven

Last Name: Jeffries

Email: sjeffries@andersonexcav

Phone: 3049832296

SO Doc Code: CRFQ

SO Dept: 0603

SO Doc ID: ADJ2400000004

Published Date: 9/5/23

Close Date: 9/12/23

Close Time: 13:30

Status: Closed

Solicitation Description: Construction: Camp Dawson South Gate Road Slip Stabilization

Total of Header Attachments: 1

Total of All Attachments: 1



Department of Administration
 Purchasing Division
 2019 Washington Street East
 Post Office Box 50130
 Charleston, WV 25305-0130

**State of West Virginia
 Solicitation Response**

Proc Folder: 1278455
Solicitation Description: Construction: Camp Dawson South Gate Road Slip Stabilization
Proc Type: Central Purchase Order

Solicitation Closes	Solicitation Response	Version
2023-09-12 13:30	SR 0603 ESR09122300000001338	1

VENDOR
 000000211224
 ANDERSON EXCAVATING LLC

Solicitation Number: CRFQ 0603 ADJ2400000004
Total Bid: 1106255.399999999906867742538 **Response Date:** 2023-09-12 **Response Time:** 11:27:03
Comments:

FOR INFORMATION CONTACT THE BUYER
 David H Pauline
 304-558-0067
 david.h.pauline@wv.gov

Vendor Signature X **FEIN#** **DATE**

All offers subject to all terms and conditions contained in this solicitation

Line	Comm Ln Desc	Qty	Unit Issue	Unit Price	Ln Total Or Contract Amount
1	BASE BID- Camp Dawson South Gate Road Slip				593626.20

Comm Code	Manufacturer	Specification	Model #
72000000			

Commodity Line Comments:

Extended Description:

See attached Pricing Page, Bid Form
 Contract Item #1- BASE BID- Labor & materials per the construction documents

Line	Comm Ln Desc	Qty	Unit Issue	Unit Price	Ln Total Or Contract Amount
2	Alternate #1- Repair and Stabilize additional 0.15 acres				512629.20

Comm Code	Manufacturer	Specification	Model #
72000000			

Commodity Line Comments:

Extended Description:

See attached Pricing Page, Bid Form
 Contract Item#2- Alternate #1- To repair and stabilize an additional 0.15 acres at the site per the contract documents.



Department of Administration
 Purchasing Division
 2019 Washington Street East
 Post Office Box 50130
 Charleston, WV 25305-0130

State of West Virginia
 Centralized Request for Quote

Proc Folder: 1278455	Reason for Modification:
Doc Description: Construction: Camp Dawson South Gate Road Slip Stabilization	
Proc Type: Central Purchase Order	

Date Issued	Solicitation Closes	Solicitation No	Version
2023-08-18	2023-09-06 13:30	CRFQ 0603 ADJ2400000004	1

BID RECEIVING LOCATION

BID CLERK
 DEPARTMENT OF ADMINISTRATION
 PURCHASING DIVISION
 2019 WASHINGTON ST E
 CHARLESTON WV 25305
 US

VENDOR

Vendor Customer Code:

Vendor Name : Anderson Excavating, LLC

Address : 343 Williams Rd

Street :

City : Morgentown

State : WV **Country :** **Zip :** 26501

Principal Contact : Josh Owens

Vendor Contact Phone: 304-983-2296 **Extension:**

FOR INFORMATION CONTACT THE BUYER

David H Pauline
 304-558-0067
 david.h.pauline@wv.gov

Vendor Signature X 

FEIN# 55-0785115 **DATE** 9/12/23

All offers subject to all terms and conditions contained in this solicitation

ADDITIONAL INFORMATION**Construction:**

The West Virginia Purchasing Division is soliciting bids on behalf of the Adjutant General's Office, Division of Engineering and Facilities to establish a contract to provide all labor, material, tools, equipment, supplies and supervision necessary to complete the South Gate Road Slip Stabilization construction, at the Camp Dawson Army Training Site, near Kingwood, WV, per the attached specifications.

Mandatory Pre-bid Meeting
 Camp Dawson Training Site- Building 301-Post Engineering
 240 Army Road, Kingwood, WV 26537
 August 24, 2023 at 10:30 am., est.

INVOICE TO		SHIP TO	
ADJUTANT GENERALS OFFICE 1707 COONSKIN DR		CAMP DAWSON ARMY TRAINING SITE 240 ARMY RD	
CHARLESTON	WV	KINGWOOD	WV
US		US	

Line	Comm Ln Desc	Qty	Unit Issue	Unit Price	Total Price
1	BASE BID- Camp Dawson South Gate Road Slip				

Comm Code	Manufacturer	Specification	Model #
72000000			

Extended Description:

See attached Pricing Page, Bid Form

Contract Item #1- BASE BID- Labor & materials per the construction documents

INVOICE TO		SHIP TO	
ADJUTANT GENERALS OFFICE 1707 COONSKIN DR		CAMP DAWSON ARMY TRAINING SITE 240 ARMY RD	
CHARLESTON	WV	KINGWOOD	WV
US		US	

Line	Comm Ln Desc	Qty	Unit Issue	Unit Price	Total Price
2	Alternate #1- Repair and Stabilize additional 0.15 acres				

Comm Code	Manufacturer	Specification	Model #
72000000			

Extended Description:

See attached Pricing Page, Bid Form

Contract Item#2- Alternate #1- To repair and stabilize an additional 0.15 acres at the site per the contract documents.

SCHEDULE OF EVENTS

<u>Line</u>	<u>Event</u>	<u>Event Date</u>
1	Mandatory Pre-bid Meeting at 10:30 am., est.	2023-08-24
2	Vendor Technical Questions Due By Noon est.	2023-08-30

	Document Phase	Document Description	Page 4
ADJ2400000004	Draft	Construction: Camp Dawson South Gate Road Slip Stabilization	

ADDITIONAL TERMS AND CONDITIONS

See attached document(s) for additional Terms and Conditions

INSTRUCTIONS TO VENDORS SUBMITTING BIDS

1. REVIEW DOCUMENTS THOROUGHLY: The attached documents contain a solicitation for bids. Please read these instructions and all documents attached in their entirety. These instructions provide critical information about requirements that if overlooked could lead to disqualification of a Vendor's bid. All bids must be submitted in accordance with the provisions contained in these instructions and the Solicitation. Failure to do so may result in disqualification of Vendor's bid.

2. MANDATORY TERMS: The Solicitation may contain mandatory provisions identified by the use of the words "must," "will," and "shall." Failure to comply with a mandatory term in the Solicitation will result in bid disqualification.

3. PREBID MEETING: The item identified below shall apply to this Solicitation.

A pre-bid meeting will not be held prior to bid opening

A **MANDATORY PRE-BID** meeting will be held at the following place and time:

Camp Dawson Training Site- Building 301-Post Engineering

240 Army Road, Kingwood, WV 26537

August 24, 2023 at 10:30am

See General Construction Specifications for additional information
regarding site visits.

All Vendors submitting a bid must attend the mandatory pre-bid meeting. Failure to attend the mandatory pre-bid meeting shall result in disqualification of the Vendor's bid. No one individual is permitted to represent more than one vendor at the pre-bid meeting. Any individual that does attempt to represent two or more vendors will be required to select one vendor to which the individual's attendance will be attributed. The vendors not selected will be deemed to have not attended the pre-bid meeting unless another individual attended on their behalf.

An attendance sheet provided at the pre-bid meeting shall serve as the official document verifying attendance. Any person attending the pre-bid meeting on behalf of a Vendor must list on the attendance sheet his or her name and the name of the Vendor he or she is representing.

Additionally, the person attending the pre-bid meeting should include the Vendor's E-Mail address, phone number, and Fax number on the attendance sheet. It is the Vendor's responsibility to locate the attendance sheet and provide the required information. Failure to complete the attendance sheet as required may result in disqualification of Vendor's bid.

All Vendors should arrive prior to the starting time for the pre-bid. Vendors who arrive after the starting time but prior to the end of the pre-bid will be permitted to sign in but are charged with knowing all matters discussed at the pre-bid.

Questions submitted at least five business days prior to a scheduled pre-bid will be discussed at the pre-bid meeting if possible. Any discussions or answers to questions at the pre-bid meeting are preliminary in nature and are non-binding. Official and binding answers to questions will be published in a written addendum to the Solicitation prior to bid opening.

4. VENDOR QUESTION DEADLINE: Vendors may submit questions relating to this Solicitation to the Purchasing Division. Questions must be submitted in writing. All questions must be submitted on or before the date listed below and to the address listed below to be considered. A written response will be published in a Solicitation addendum if a response is possible and appropriate. Non-written discussions, conversations, or questions and answers regarding this Solicitation are preliminary in nature and are nonbinding.

Submitted emails should have the solicitation number in the subject line.

Question Submission Deadline: August 30, 2023, at Noon Est.

Submit Questions to: David Pauline, Senior Buyer
2019 Washington Street, East
Charleston, WV 25305
Fax: (304) 558-3970
Email: David.H.Pauline@wv.gov

5. VERBAL COMMUNICATION: Any verbal communication between the Vendor and any State personnel is not binding, including verbal communication at the mandatory pre-bid conference. Only information issued in writing and added to the Solicitation by an official written addendum by the Purchasing Division is binding.

6. BID SUBMISSION: All bids must be submitted on or before the date and time of the bid opening listed in section 7 below. Vendors can submit bids electronically through wvOASIS, in paper form delivered to the Purchasing Division at the address listed below either in person or by courier, or in facsimile form by faxing to the Purchasing Division at the number listed below. Notwithstanding the foregoing, the Purchasing Division may prohibit the submission of bids electronically through wvOASIS at its sole discretion. Such a prohibition will be contained and communicated in the wvOASIS system resulting in the Vendor's inability to submit bids through wvOASIS. The Purchasing Division will not accept bids, modification of bids, or addendum acknowledgment forms via email. Bids submitted in paper or facsimile form must contain a signature. Bids submitted in wvOASIS are deemed to be electronically signed.

Any bid received by the Purchasing Division staff is considered to be in the possession of the Purchasing Division and will not be returned for any reason.

For Request for Proposal ("RFP") Responses Only: Submission of a response to a Request for Proposal is not permitted in wvOASIS. In the event that Vendor is responding to a request for proposal, the Vendor shall submit one original technical and one original cost proposal prior to the bid opening date and time identified in Section 7 below, plus N/A convenience copies of each to the Purchasing Division at the address shown below. Additionally, the Vendor should clearly identify and segregate the cost proposal from the technical proposal in a separately sealed envelope.

Bid Delivery Address and Fax Number:

Department of Administration, Purchasing Division
2019 Washington Street East
Charleston, WV 25305-0130
Fax: 304-558-3970

A bid submitted in paper or facsimile form should contain the information listed below on the face of the submission envelope or fax cover sheet. Otherwise, the bid may be rejected by the Purchasing Division.

VENDOR NAME:

BUYER:

SOLICITATION NO.:

BID OPENING DATE:

BID OPENING TIME:

FAX NUMBER:

7. BID OPENING: Bids submitted in response to this Solicitation will be opened at the location identified below on the date and time listed below. Delivery of a bid after the bid opening date and time will result in bid disqualification. For purposes of this Solicitation, a bid is considered delivered when confirmation of delivery is provided by wvOASIS (in the case of electronic submission) or when the bid is time stamped by the official Purchasing Division time clock (in the case of hand delivery).

Bid Opening Date and Time: September 6, 2023, at 1:30 pm., est.

Bid Opening Location: Department of Administration, Purchasing Division
2019 Washington Street East
Charleston, WV 25305-0130

8. ADDENDUM ACKNOWLEDGEMENT: Changes or revisions to this Solicitation will be made by an official written addendum issued by the Purchasing Division. Vendor should acknowledge receipt of all addenda issued with this Solicitation by completing an Addendum Acknowledgment Form, a copy of which is included herewith. Failure to acknowledge addenda may result in bid disqualification. The addendum acknowledgement should be submitted with the bid to expedite document processing.

9. BID FORMATTING: Vendor should type or electronically enter the information onto its bid to prevent errors in the evaluation. Failure to type or electronically enter the information may result in bid disqualification.

10. ALTERNATE MODEL OR BRAND: Unless the box below is checked, any model, brand, or specification listed in this Solicitation establishes the acceptable level of quality only and is not intended to reflect a preference for, or in any way favor, a particular brand or vendor. Vendors may bid alternates to a listed model or brand provided that the alternate is at least equal to the model or brand and complies with the required specifications. The equality of any alternate being bid shall be determined by the State at its sole discretion. Any Vendor bidding an alternate model or brand should clearly identify the alternate items in its bid and should include manufacturer's specifications, industry literature, and/or any other relevant documentation demonstrating the equality of the alternate items. Failure to provide information for alternate items may be grounds for rejection of a Vendor's bid.

This Solicitation is based upon a standardized commodity established under W. Va. Code § 5A-3-61. Vendors are expected to bid the standardized commodity identified. Failure to bid the standardized commodity will result in your firm's bid being rejected.

11. EXCEPTIONS AND CLARIFICATIONS: The Solicitation contains the specifications that shall form the basis of a contractual agreement. Vendor shall clearly mark any exceptions, clarifications, or other proposed modifications in its bid. Exceptions to, clarifications of, or modifications of a requirement or term and condition of the Solicitation may result in bid disqualification.

12. COMMUNICATION LIMITATIONS: In accordance with West Virginia Code of State Rules §148-1-6.6, communication with the State of West Virginia or any of its employees regarding this Solicitation during the solicitation, bid, evaluation or award periods, except through the Purchasing Division, is strictly prohibited without prior Purchasing Division approval. Purchasing Division approval for such communication is implied for all agency delegated and exempt purchases.

13. REGISTRATION: Prior to Contract award, the apparent successful Vendor must be properly registered with the West Virginia Purchasing Division and must have paid the \$125 fee, if applicable.

14. UNIT PRICE: Unit prices shall prevail in cases of a discrepancy in the Vendor's bid.

15. PREFERENCE: Vendor Preference may be requested in purchases of motor vehicles or construction and maintenance equipment and machinery used in highway and other infrastructure projects. Any request for preference must be submitted in writing with the bid, must specifically identify the preference requested with reference to the applicable subsection of West Virginia Code § 5A-3-37, and must include with the bid any information necessary to evaluate and confirm the applicability of the requested preference. A request form to help facilitate the request can be found at: www.state.wv.us/admin/purchase/vrc/Venpref.pdf.

15A. RECIPROCAL PREFERENCE: The State of West Virginia applies a reciprocal preference to all solicitations for commodities and printing in accordance with W. Va. Code § 5A-3-37(b). In effect, non-resident vendors receiving a preference in their home states, will see that same preference granted to West Virginia resident vendors bidding against them in West Virginia. Any request for reciprocal preference must include with the bid any information necessary to evaluate and confirm the applicability of the preference. A request form to help facilitate the request can be found at: www.state.wv.us/admin/purchase/vrc/Venpref.pdf.

16. SMALL, WOMEN-OWNED, OR MINORITY-OWNED BUSINESSES: For any solicitations publicly advertised for bid, in accordance with West Virginia Code §5A-3-37 and W. Va. CSR § 148-22-9, any non-resident vendor certified as a small, women- owned, or minority-owned business under W. Va. CSR § 148-22-9 shall be provided the same preference made available to any resident vendor. Any non-resident small, women-owned, or minority-owned business must identify itself as such in writing, must submit that writing to the Purchasing Division with its bid, and must be properly certified under W. Va. CSR § 148-22-9 prior to contract award to receive the preferences made available to resident vendors. Preference for a non-resident small, women-owned, or minority owned business shall be applied in accordance with W. Va. CSR § 148-22-9.

17. WAIVER OF MINOR IRREGULARITIES: The Director reserves the right to waive minor irregularities in bids or specifications in accordance with West Virginia Code of State Rules § 148-1-4.6.

18. ELECTRONIC FILE ACCESS RESTRICTIONS: Vendor must ensure that its submission in wvOASIS can be accessed and viewed by the Purchasing Division staff immediately upon bid opening. The Purchasing Division will consider any file that cannot be immediately accessed and viewed at the time of the bid opening (such as, encrypted files, password protected files, or incompatible files) to be blank or incomplete as context requires and are therefore unacceptable. A vendor will not be permitted to unencrypt files, remove password protections, or resubmit documents after bid opening to make a file viewable if those documents are required with the bid. A Vendor may be required to provide document passwords or remove access restrictions to allow the Purchasing Division to print or electronically save documents provided that those documents are viewable by the Purchasing Division prior to obtaining the password or removing the access restriction.

19. NON-RESPONSIBLE: The Purchasing Division Director reserves the right to reject the bid of any vendor as Non-Responsible in accordance with W. Va. Code of State Rules § 148-1-5.3, when the Director determines that the vendor submitting the bid does not have the capability to fully perform or lacks the integrity and reliability to assure good-faith performance.”

20. ACCEPTANCE/REJECTION: The State may accept or reject any bid in whole, or in part in accordance with W. Va. Code of State Rules § 148-1-4.5. and § 148-1-6.4.b.”

21. YOUR SUBMISSION IS A PUBLIC DOCUMENT: Vendor's entire response to the Solicitation and the resulting Contract are public documents. As public documents, they will be disclosed to the public following the bid/proposal opening or award of the contract, as required by the competitive bidding laws of West Virginia Code §§ 5A-3-1 et seq., 5-22-1 et seq., and 5G-1-1 et seq. and the Freedom of Information Act West Virginia Code §§ 29B-1-1 et seq.

DO NOT SUBMIT MATERIAL YOU CONSIDER TO BE CONFIDENTIAL, A TRADE SECRET, OR OTHERWISE NOT SUBJECT TO PUBLIC DISCLOSURE.

Submission of any bid, proposal, or other document to the Purchasing Division constitutes your explicit consent to the subsequent public disclosure of the bid, proposal, or document. The Purchasing Division will disclose any document labeled "confidential," "proprietary," "trade secret," "private," or labeled with any other claim against public disclosure of the documents, to include any "trade secrets" as defined by West Virginia Code § 47-22-1 et seq. All submissions are subject to public disclosure without notice.

22. WITH THE BID REQUIREMENTS: In instances where these specifications require documentation or other information with the bid, and a vendor fails to provide it with the bid, the Director of the Purchasing Division reserves the right to request those items after bid opening and prior to contract award pursuant to the authority to waive minor irregularities in bids or specifications under W. Va. CSR § 148-1-4.6. This authority does not apply to instances where state law mandates receipt with the bid.

23. EMAIL NOTIFICATION OF AWARD: The Purchasing Division will attempt to provide bidders with e-mail notification of contract award when a solicitation that the bidder participated in has been awarded. For notification purposes, bidders must provide the Purchasing Division with a valid email address in the bid response. Bidders may also monitor wvOASIS or the Purchasing Division's website to determine when a contract has been awarded.

24. ISRAEL BOYCOTT CERTIFICATION: Vendor's act of submitting a bid in response to this solicitation shall be deemed a certification from bidder to the State that bidder is not currently engaged in, and will not for the duration of the contract, engage in a boycott of Israel. This certification is required by W. Va. Code § 5A-3-63.

GENERAL TERMS AND CONDITIONS:

1. CONTRACTUAL AGREEMENT: Issuance of an Award Document signed by the Purchasing Division Director, or his designee, and approved as to form by the Attorney General's office constitutes acceptance by the State of this Contract made by and between the State of West Virginia and the Vendor. Vendor's signature on its bid, or on the Contract if the Contract is not the result of a bid solicitation, signifies Vendor's agreement to be bound by and accept the terms and conditions contained in this Contract.

2. DEFINITIONS: As used in this Solicitation/Contract, the following terms shall have the meanings attributed to them below. Additional definitions may be found in the specifications included with this Solicitation/Contract.

2.1. "Agency" or "Agencies" means the agency, board, commission, or other entity of the State of West Virginia that is identified on the first page of the Solicitation or any other public entity seeking to procure goods or services under this Contract.

2.2. "Bid" or "Proposal" means the vendors submitted response to this solicitation.

2.3. "Contract" means the binding agreement that is entered into between the State and the Vendor to provide the goods or services requested in the Solicitation.

2.4. "Director" means the Director of the West Virginia Department of Administration, Purchasing Division.

2.5. "Purchasing Division" means the West Virginia Department of Administration, Purchasing Division.

2.6. "Award Document" means the document signed by the Agency and the Purchasing Division, and approved as to form by the Attorney General, that identifies the Vendor as the contract holder.

2.7. "Solicitation" means the official notice of an opportunity to supply the State with goods or services that is published by the Purchasing Division.

2.8. "State" means the State of West Virginia and/or any of its agencies, commissions, boards, etc. as context requires.

2.9. "Vendor" or "Vendors" means any entity submitting a bid in response to the Solicitation, the entity that has been selected as the lowest responsible bidder, or the entity that has been awarded the Contract as context requires.

3. CONTRACT TERM; RENEWAL; EXTENSION: The term of this Contract shall be determined in accordance with the category that has been identified as applicable to this Contract below:

Term Contract

Initial Contract Term: The Initial Contract Term will be for a period of _____
_____. The Initial Contract Term becomes effective on the effective start date listed on the first page of this Contract, identified as the State of West Virginia contract cover page containing the signatures of the Purchasing Division, Attorney General, and Encumbrance clerk (or another page identified as _____), and the Initial Contract Term ends on the effective end date also shown on the first page of this Contract.

Renewal Term: This Contract may be renewed upon the mutual written consent of the Agency, and the Vendor, with approval of the Purchasing Division and the Attorney General's office (Attorney General approval is as to form only). Any request for renewal should be delivered to the Agency and then submitted to the Purchasing Division thirty (30) days prior to the expiration date of the initial contract term or appropriate renewal term. A Contract renewal shall be in accordance with the terms and conditions of the original contract. Unless otherwise specified below, renewal of this Contract is limited to _____ successive one (1) year periods or multiple renewal periods of less than one year, provided that the multiple renewal periods do not exceed the total number of months available in all renewal years combined. Automatic renewal of this Contract is prohibited. Renewals must be approved by the Vendor, Agency, Purchasing Division and Attorney General's office (Attorney General approval is as to form only)

Alternate Renewal Term – This contract may be renewed for _____ successive _____ year periods or shorter periods provided that they do not exceed the total number of months contained in all available renewals. Automatic renewal of this Contract is prohibited. Renewals must be approved by the Vendor, Agency, Purchasing Division and Attorney General's office (Attorney General approval is as to form only)

Delivery Order Limitations: In the event that this contract permits delivery orders, a delivery order may only be issued during the time this Contract is in effect. Any delivery order issued within one year of the expiration of this Contract shall be effective for one year from the date the delivery order is issued. No delivery order may be extended beyond one year after this Contract has expired.

Fixed Period Contract: This Contract becomes effective upon Vendor's receipt of the notice to proceed and must be completed within Three hundred sixty five(365) calendar days.

Fixed Period Contract with Renewals: This Contract becomes effective upon Vendor's receipt of the notice to proceed and part of the Contract more fully described in the attached specifications must be completed within _____ days. Upon completion of the work covered by the preceding sentence, the vendor agrees that:

the contract will continue for _____ years;

the contract may be renewed for _____ successive _____ year periods or shorter periods provided that they do not exceed the total number of months contained in all available renewals. Automatic renewal of this Contract is prohibited. Renewals must be approved by the Vendor, Agency, Purchasing Division and Attorney General's Office (Attorney General approval is as to form only).

One-Time Purchase: The term of this Contract shall run from the issuance of the Award Document until all of the goods contracted for have been delivered, but in no event will this Contract extend for more than one fiscal year.

Construction/Project Oversight: This Contract becomes effective on the effective start date listed on the first page of this Contract, identified as the State of West Virginia contract cover page containing the signatures of the Purchasing Division, Attorney General, and Encumbrance clerk (or another page identified as _____), and continues until the project for which the vendor is providing oversight is complete.

Other: Contract Term specified in _____

4. AUTHORITY TO PROCEED: Vendor is authorized to begin performance of this contract on the date of encumbrance listed on the front page of the Award Document unless either the box for "Fixed Period Contract" or "Fixed Period Contract with Renewals" has been checked in Section 3 above. If either "Fixed Period Contract" or "Fixed Period Contract with Renewals" has been checked, Vendor must not begin work until it receives a separate notice to proceed from the State. The notice to proceed will then be incorporated into the Contract via change order to memorialize the official date that work commenced.

5. QUANTITIES: The quantities required under this Contract shall be determined in accordance with the category that has been identified as applicable to this Contract below.

Open End Contract: Quantities listed in this Solicitation/Award Document are approximations only, based on estimates supplied by the Agency. It is understood and agreed that the Contract shall cover the quantities actually ordered for delivery during the term of the Contract, whether more or less than the quantities shown.

Service: The scope of the service to be provided will be more clearly defined in the specifications included herewith.

Combined Service and Goods: The scope of the service and deliverable goods to be provided will be more clearly defined in the specifications included herewith.

One-Time Purchase: This Contract is for the purchase of a set quantity of goods that are identified in the specifications included herewith. Once those items have been delivered, no additional goods may be procured under this Contract without an appropriate change order approved by the Vendor, Agency, Purchasing Division, and Attorney General's office.

Construction: This Contract is for construction activity more fully defined in the specifications.

6. EMERGENCY PURCHASES: The Purchasing Division Director may authorize the Agency to purchase goods or services in the open market that Vendor would otherwise provide under this Contract if those goods or services are for immediate or expedited delivery in an emergency. Emergencies shall include, but are not limited to, delays in transportation or an unanticipated increase in the volume of work. An emergency purchase in the open market, approved by the Purchasing Division Director, shall not constitute of breach of this Contract and shall not entitle the Vendor to any form of compensation or damages. This provision does not excuse the State from fulfilling its obligations under a One-Time Purchase contract.

7. REQUIRED DOCUMENTS: All of the items checked in this section must be provided to the Purchasing Division by the Vendor as specified:

LICENSE(S) / CERTIFICATIONS / PERMITS: In addition to anything required under the Section of the General Terms and Conditions entitled Licensing, the apparent successful Vendor shall furnish proof of the following licenses, certifications, and/or permits upon request and in a form acceptable to the State. The request may be prior to or after contract award at the State's sole discretion.

West Virginia Contractor's License

The apparent successful Vendor shall also furnish proof of any additional licenses or certifications contained in the specifications regardless of whether or not that requirement is listed above.

8. INSURANCE: The apparent successful Vendor shall furnish proof of the insurance identified by a checkmark below prior to Contract award. The insurance coverages identified below must be maintained throughout the life of this contract. Thirty (30) days prior to the expiration of the insurance policies, Vendor shall provide the Agency with proof that the insurance mandated herein has been continued. Vendor must also provide Agency with immediate notice of any changes in its insurance policies, including but not limited to, policy cancelation, policy reduction, or change in insurers. The apparent successful Vendor shall also furnish proof of any additional insurance requirements contained in the specifications prior to Contract award regardless of whether that insurance requirement is listed in this section.

Vendor must maintain:

Commercial General Liability Insurance in at least an amount of: \$1,000,000.00 per occurrence.

Automobile Liability Insurance in at least an amount of: \$1,000,000.00 per occurrence.

Professional/Malpractice/Errors and Omission Insurance in at least an amount of: _____ per occurrence. Notwithstanding the forgoing, Vendor's are not required to list the State as an additional insured for this type of policy.

Commercial Crime and Third Party Fidelity Insurance in an amount of: _____ per occurrence.

Cyber Liability Insurance in an amount of: _____ per occurrence.

Builders Risk Insurance in an amount equal to 100% of the amount of the Contract.

Pollution Insurance in an amount of: _____ per occurrence.

Aircraft Liability in an amount of: _____ per occurrence.

*****Please make Insurance Certificate Holder to Read***
West Virginia Army National Guard
1707 Coonskin Drive, Charleston, WV 25311**

9. WORKERS' COMPENSATION INSURANCE: Vendor shall comply with laws relating to workers compensation, shall maintain workers' compensation insurance when required, and shall furnish proof of workers' compensation insurance upon request.

10. VENUE: All legal actions for damages brought by Vendor against the State shall be brought in the West Virginia Claims Commission. Other causes of action must be brought in the West Virginia court authorized by statute to exercise jurisdiction over it.

11. LIQUIDATED DAMAGES: This clause shall in no way be considered exclusive and shall not limit the State or Agency's right to pursue any other available remedy. Vendor shall pay liquidated damages in the amount specified below or as described in the specifications:

_____ for _____.

Liquidated Damages Contained in the Specifications.

Liquidated Damages Are Not Included in this Contract.

12. ACCEPTANCE: Vendor's signature on its bid, or on the certification and signature page, constitutes an offer to the State that cannot be unilaterally withdrawn, signifies that the product or service proposed by vendor meets the mandatory requirements contained in the Solicitation for that product or service, unless otherwise indicated, and signifies acceptance of the terms and conditions contained in the Solicitation unless otherwise indicated.

13. PRICING: The pricing set forth herein is firm for the life of the Contract, unless specified elsewhere within this Solicitation/Contract by the State. A Vendor's inclusion of price adjustment provisions in its bid, without an express authorization from the State in the Solicitation to do so, may result in bid disqualification. Notwithstanding the foregoing, Vendor must extend any publicly advertised sale price to the State and invoice at the lower of the contract price or the publicly advertised sale price.

14. PAYMENT IN ARREARS: Payments for goods/services will be made in arrears only upon receipt of a proper invoice, detailing the goods/services provided or receipt of the goods/services, whichever is later. Notwithstanding the foregoing, payments for software maintenance, licenses, or subscriptions may be paid annually in advance.

15. PAYMENT METHODS: Vendor must accept payment by electronic funds transfer and P-Card. (The State of West Virginia's Purchasing Card program, administered under contract by a banking institution, processes payment for goods and services through state designated credit cards.)

16. TAXES: The Vendor shall pay any applicable sales, use, personal property or any other taxes arising out of this Contract and the transactions contemplated thereby. The State of West Virginia is exempt from federal and state taxes and will not pay or reimburse such taxes.

17. ADDITIONAL FEES: Vendor is not permitted to charge additional fees or assess additional charges that were not either expressly provided for in the solicitation published by the State of West Virginia, included in the Contract, or included in the unit price or lump sum bid amount that Vendor is required by the solicitation to provide. Including such fees or charges as notes to the solicitation may result in rejection of vendor's bid. Requesting such fees or charges be paid after the contract has been awarded may result in cancellation of the contract.

18. FUNDING: This Contract shall continue for the term stated herein, contingent upon funds being appropriated by the Legislature or otherwise being made available. In the event funds are not appropriated or otherwise made available, this Contract becomes void and of no effect beginning on July 1 of the fiscal year for which funding has not been appropriated or otherwise made available. If that occurs, the State may notify the Vendor that an alternative source of funding has been obtained and thereby avoid the automatic termination. Non-appropriation or non-funding shall not be considered an event of default.

19. CANCELLATION: The Purchasing Division Director reserves the right to cancel this Contract immediately upon written notice to the vendor if the materials or workmanship supplied do not conform to the specifications contained in the Contract. The Purchasing Division Director may also cancel any purchase or Contract upon 30 days written notice to the Vendor in accordance with West Virginia Code of State Rules § 148-1-5.2.b.

20. TIME: Time is of the essence regarding all matters of time and performance in this Contract.

21. APPLICABLE LAW: This Contract is governed by and interpreted under West Virginia law without giving effect to its choice of law principles. Any information provided in specification manuals, or any other source, verbal or written, which contradicts or violates the West Virginia Constitution, West Virginia Code, or West Virginia Code of State Rules is void and of no effect.

22. COMPLIANCE WITH LAWS: Vendor shall comply with all applicable federal, state, and local laws, regulations and ordinances. By submitting a bid, Vendor acknowledges that it has reviewed, understands, and will comply with all applicable laws, regulations, and ordinances.

SUBCONTRACTOR COMPLIANCE: Vendor shall notify all subcontractors providing commodities or services related to this Contract that as subcontractors, they too are required to comply with all applicable laws, regulations, and ordinances. Notification under this provision must occur prior to the performance of any work under the contract by the subcontractor.

23. ARBITRATION: Any references made to arbitration contained in this Contract, Vendor's bid, or in any American Institute of Architects documents pertaining to this Contract are hereby deleted, void, and of no effect.

24. MODIFICATIONS: This writing is the parties' final expression of intent. Notwithstanding anything contained in this Contract to the contrary no modification of this Contract shall be binding without mutual written consent of the Agency, and the Vendor, with approval of the Purchasing Division and the Attorney General's office (Attorney General approval is as to form only). Any change to existing contracts that adds work or changes contract cost, and were not included in the original contract, must be approved by the Purchasing Division and the Attorney General's Office (as to form) prior to the implementation of the change or commencement of work affected by the change.

25. WAIVER: The failure of either party to insist upon a strict performance of any of the terms or provision of this Contract, or to exercise any option, right, or remedy herein contained, shall not be construed as a waiver or a relinquishment for the future of such term, provision, option, right, or remedy, but the same shall continue in full force and effect. Any waiver must be expressly stated in writing and signed by the waiving party.

26. SUBSEQUENT FORMS: The terms and conditions contained in this Contract shall supersede any and all subsequent terms and conditions which may appear on any form documents submitted by Vendor to the Agency or Purchasing Division such as price lists, order forms, invoices, sales agreements, or maintenance agreements, and includes internet websites or other electronic documents. Acceptance or use of Vendor's forms does not constitute acceptance of the terms and conditions contained thereon.

27. ASSIGNMENT: Neither this Contract nor any monies due, or to become due hereunder, may be assigned by the Vendor without the express written consent of the Agency, the Purchasing Division, the Attorney General's office (as to form only), and any other government agency or office that may be required to approve such assignments.

28. WARRANTY: The Vendor expressly warrants that the goods and/or services covered by this Contract will: (a) conform to the specifications, drawings, samples, or other description furnished or specified by the Agency; (b) be merchantable and fit for the purpose intended; and (c) be free from defect in material and workmanship.

29. STATE EMPLOYEES: State employees are not permitted to utilize this Contract for personal use and the Vendor is prohibited from permitting or facilitating the same.

30. PRIVACY, SECURITY, AND CONFIDENTIALITY: The Vendor agrees that it will not disclose to anyone, directly or indirectly, any such personally identifiable information or other confidential information gained from the Agency, unless the individual who is the subject of the information consents to the disclosure in writing or the disclosure is made pursuant to the Agency's policies, procedures, and rules. Vendor further agrees to comply with the Confidentiality Policies and Information Security Accountability Requirements, set forth in <http://www.state.wv.us/admin/purchase/privacy/default.html>.

31. YOUR SUBMISSION IS A PUBLIC DOCUMENT: Vendor's entire response to the Solicitation and the resulting Contract are public documents. As public documents, they will be disclosed to the public following the bid/proposal opening or award of the contract, as required by the competitive bidding laws of West Virginia Code §§ 5A-3-1 et seq., 5-22-1 et seq., and 5G-1-1 et seq. and the Freedom of Information Act West Virginia Code §§ 29B-1-1 et seq.

DO NOT SUBMIT MATERIAL YOU CONSIDER TO BE CONFIDENTIAL, A TRADE SECRET, OR OTHERWISE NOT SUBJECT TO PUBLIC DISCLOSURE.

Submission of any bid, proposal, or other document to the Purchasing Division constitutes your explicit consent to the subsequent public disclosure of the bid, proposal, or document. The Purchasing Division will disclose any document labeled "confidential," "proprietary," "trade secret," "private," or labeled with any other claim against public disclosure of the documents, to include any "trade secrets" as defined by West Virginia Code § 47-22-1 et seq. All submissions are subject to public disclosure without notice.

32. LICENSING: In accordance with West Virginia Code of State Rules § 148-1-6.1.e, Vendor must be licensed and in good standing in accordance with any and all state and local laws and requirements by any state or local agency of West Virginia, including, but not limited to, the West Virginia Secretary of State's Office, the West Virginia Tax Department, West Virginia Insurance Commission, or any other state agency or political subdivision. Obligations related to political subdivisions may include, but are not limited to, business licensing, business and occupation taxes, inspection compliance, permitting, etc. Upon request, the Vendor must provide all necessary releases to obtain information to enable the Purchasing Division Director or the Agency to verify that the Vendor is licensed and in good standing with the above entities.

SUBCONTRACTOR COMPLIANCE: Vendor shall notify all subcontractors providing commodities or services related to this Contract that as subcontractors, they too are required to be licensed, in good standing, and up-to-date on all state and local obligations as described in this section. Obligations related to political subdivisions may include, but are not limited to, business licensing, business and occupation taxes, inspection compliance, permitting, etc. Notification under this provision must occur prior to the performance of any work under the contract by the subcontractor.

33. ANTITRUST: In submitting a bid to, signing a contract with, or accepting a Award Document from any agency of the State of West Virginia, the Vendor agrees to convey, sell, assign, or transfer to the State of West Virginia all rights, title, and interest in and to all causes of action it may now or hereafter acquire under the antitrust laws of the United States and the State of West Virginia for price fixing and/or unreasonable restraints of trade relating to the particular commodities or services purchased or acquired by the State of West Virginia. Such assignment shall be made and become effective at the time the purchasing agency tenders the initial payment to Vendor.

34. VENDOR NON-CONFLICT: Neither Vendor nor its representatives are permitted to have any interest, nor shall they acquire any interest, direct or indirect, which would compromise the performance of its services hereunder. Any such interests shall be promptly presented in detail to the Agency.

Revised 11/1/2022

35. VENDOR RELATIONSHIP: The relationship of the Vendor to the State shall be that of an independent contractor and no principal-agent relationship or employer-employee relationship is contemplated or created by this Contract. The Vendor as an independent contractor is solely liable for the acts and omissions of its employees and agents. Vendor shall be responsible for selecting, supervising, and compensating any and all individuals employed pursuant to the terms of this Solicitation and resulting contract. Neither the Vendor, nor any employees or subcontractors of the Vendor, shall be deemed to be employees of the State for any purpose whatsoever. Vendor shall be exclusively responsible for payment of employees and contractors for all wages and salaries, taxes, withholding payments, penalties, fees, fringe benefits, professional liability insurance premiums, contributions to insurance and pension, or other deferred compensation plans, including but not limited to, Workers' Compensation and Social Security obligations, licensing fees, etc. and the filing of all necessary documents, forms, and returns pertinent to all of the foregoing.

Vendor shall hold harmless the State, and shall provide the State and Agency with a defense against any and all claims including, but not limited to, the foregoing payments, withholdings, contributions, taxes, Social Security taxes, and employer income tax returns.

36. INDEMNIFICATION: The Vendor agrees to indemnify, defend, and hold harmless the State and the Agency, their officers, and employees from and against: (1) Any claims or losses for services rendered by any subcontractor, person, or firm performing or supplying services, materials, or supplies in connection with the performance of the Contract; (2) Any claims or losses resulting to any person or entity injured or damaged by the Vendor, its officers, employees, or subcontractors by the publication, translation, reproduction, delivery, performance, use, or disposition of any data used under the Contract in a manner not authorized by the Contract, or by Federal or State statutes or regulations; and (3) Any failure of the Vendor, its officers, employees, or subcontractors to observe State and Federal laws including, but not limited to, labor and wage and hour laws.

37. NO DEBT CERTIFICATION: In accordance with West Virginia Code §§ 5A-3-10a and 5-22-1(i), the State is prohibited from awarding a contract to any bidder that owes a debt to the State or a political subdivision of the State. By submitting a bid, or entering into a contract with the State, Vendor is affirming that (1) for construction contracts, the Vendor is not in default on any monetary obligation owed to the state or a political subdivision of the state, and (2) for all other contracts, neither the Vendor nor any related party owe a debt as defined above, and neither the Vendor nor any related party are in employer default as defined in the statute cited above unless the debt or employer default is permitted under the statute.

38. CONFLICT OF INTEREST: Vendor, its officers or members or employees, shall not presently have or acquire an interest, direct or indirect, which would conflict with or compromise the performance of its obligations hereunder. Vendor shall periodically inquire of its officers, members and employees to ensure that a conflict of interest does not arise. Any conflict of interest discovered shall be promptly presented in detail to the Agency.

39. REPORTS: Vendor shall provide the Agency and/or the Purchasing Division with the following reports identified by a checked box below:

Such reports as the Agency and/or the Purchasing Division may request. Requested reports may include, but are not limited to, quantities purchased, agencies utilizing the contract, total contract expenditures by agency, etc.

Quarterly reports detailing the total quantity of purchases in units and dollars, along with a listing of purchases by agency. Quarterly reports should be delivered to the Purchasing Division via email at purchasing.division@wv.gov.

40. BACKGROUND CHECK: In accordance with W. Va. Code § 15-2D-3, the State reserves the right to prohibit a service provider's employees from accessing sensitive or critical information or to be present at the Capitol complex based upon results addressed from a criminal background check. Service providers should contact the West Virginia Division of Protective Services by phone at (304) 558-9911 for more information.

41. PREFERENCE FOR USE OF DOMESTIC STEEL PRODUCTS: Except when authorized by the Director of the Purchasing Division pursuant to W. Va. Code § 5A-3-56, no contractor may use or supply steel products for a State Contract Project other than those steel products made in the United States. A contractor who uses steel products in violation of this section may be subject to civil penalties pursuant to W. Va. Code § 5A-3-56. As used in this section:

- a. "State Contract Project" means any erection or construction of, or any addition to, alteration of or other improvement to any building or structure, including, but not limited to, roads or highways, or the installation of any heating or cooling or ventilating plants or other equipment, or the supply of and materials for such projects, pursuant to a contract with the State of West Virginia for which bids were solicited on or after June 6, 2001.
- b. "Steel Products" means products rolled, formed, shaped, drawn, extruded, forged, cast, fabricated or otherwise similarly processed, or processed by a combination of two or more or such operations, from steel made by the open heath, basic oxygen, electric furnace, Bessemer or other steel making process.
- c. The Purchasing Division Director may, in writing, authorize the use of foreign steel products if:
 1. The cost for each contract item used does not exceed one tenth of one percent (.1%) of the total contract cost or two thousand five hundred dollars (\$2,500.00), whichever is greater. For the purposes of this section, the cost is the value of the steel product as delivered to the project; or
 2. The Director of the Purchasing Division determines that specified steel materials are not produced in the United States in sufficient quantity or otherwise are not reasonably available to meet contract requirements.

42. PREFERENCE FOR USE OF DOMESTIC ALUMINUM, GLASS, AND STEEL: In Accordance with W. Va. Code § 5-19-1 et seq., and W. Va. CSR § 148-10-1 et seq., for every contract or subcontract, subject to the limitations contained herein, for the construction, reconstruction, alteration, repair, improvement or maintenance of public works or for the purchase of any item of machinery or equipment to be used at sites of public works, only domestic aluminum, glass or steel products shall be supplied unless the spending officer determines, in writing, after the receipt of offers or bids, (1) that the cost of domestic aluminum, glass or steel products is unreasonable or inconsistent with the public interest of the State of West Virginia, (2) that domestic aluminum, glass or steel products are not produced in sufficient quantities to meet the contract requirements, or (3) the available domestic aluminum, glass, or steel do not meet the contract specifications. This provision only applies to public works contracts awarded in an amount more than fifty thousand dollars (\$50,000) or public works contracts that require more than ten thousand pounds of steel products.

The cost of domestic aluminum, glass, or steel products may be unreasonable if the cost is more than twenty percent (20%) of the bid or offered price for foreign made aluminum, glass, or steel products. If the domestic aluminum, glass or steel products to be supplied or produced in a “substantial labor surplus area”, as defined by the United States Department of Labor, the cost of domestic aluminum, glass, or steel products may be unreasonable if the cost is more than thirty percent (30%) of the bid or offered price for foreign made aluminum, glass, or steel products. This preference shall be applied to an item of machinery or equipment, as indicated above, when the item is a single unit of equipment or machinery manufactured primarily of aluminum, glass or steel, is part of a public works contract and has the sole purpose or of being a permanent part of a single public works project. This provision does not apply to equipment or machinery purchased by a spending unit for use by that spending unit and not as part of a single public works project.

All bids and offers including domestic aluminum, glass or steel products that exceed bid or offer prices including foreign aluminum, glass or steel products after application of the preferences provided in this provision may be reduced to a price equal to or lower than the lowest bid or offer price for foreign aluminum, glass or steel products plus the applicable preference. If the reduced bid or offer prices are made in writing and supersede the prior bid or offer prices, all bids or offers, including the reduced bid or offer prices, will be reevaluated in accordance with this rule.

43. INTERESTED PARTY SUPPLEMENTAL DISCLOSURE: W. Va. Code § 6D-1-2 requires that for contracts with an actual or estimated value of at least \$1 million, the Vendor must submit to the Agency a disclosure of interested parties prior to beginning work under this Contract. Additionally, the Vendor must submit a supplemental disclosure of interested parties reflecting any new or differing interested parties to the contract, which were not included in the original pre-work interested party disclosure, within 30 days following the completion or termination of the contract. A copy of that form is included with this solicitation or can be obtained from the WV Ethics Commission. This requirement does not apply to publicly traded companies listed on a national or international stock exchange. A more detailed definition of interested parties can be obtained from the form referenced above.

44. PROHIBITION AGAINST USED OR REFURBISHED: Unless expressly permitted in the solicitation published by the State, Vendor must provide new, unused commodities, and is prohibited from supplying used or refurbished commodities, in fulfilling its responsibilities under this Contract.

45. VOID CONTRACT CLAUSES: This Contract is subject to the provisions of West Virginia Code § 5A-3-62, which automatically voids certain contract clauses that violate State law.

46. ISRAEL BOYCOTT: Bidder understands and agrees that, pursuant to W. Va. Code § 5A-3-63, it is prohibited from engaging in a boycott of Israel during the term of this contract.

ADDITIONAL TERMS AND CONDITIONS (Construction Contracts Only)

1. CONTRACTOR'S LICENSE: Until June 15, 2021, West Virginia Code § 21-11-2, and after that date, § 30-42-2, requires that all persons desiring to perform contracting work in this state be licensed. The West Virginia Contractors Licensing Board is empowered to issue the contractor's license. Applications for a contractor's license may be made by contacting the West Virginia Contractor Licensing Board.

The apparent successful Vendor must furnish a copy of its contractor's license prior to the issuance of a contract award document.

2. BONDS: The following bonds must be submitted:

- a. BID BOND:** Pursuant to the requirements contained in W. Va. Code § 5-22-1(c), All Vendors submitting a bid on a construction project shall furnish a valid bid bond in the amount of five percent (5%) of the total amount of the bid protecting the State of West Virginia. **THE BID BOND MUST BE SUBMITTED WITH THE BID OR VENDOR'S BID WILL BE DISQUALIFIED.**
- b. PERFORMANCE BOND:** The apparent successful Vendor shall provide a performance bond in the amount of 100% of the contract. The performance bond must be received by the Purchasing Division prior to Contract award. (Attorney General requires use of the State approved bond forms found at: www.state.wv.us/admin/purchase/forms2.html)
- c. LABOR/MATERIAL PAYMENT BOND:** The apparent successful Vendor shall provide a labor/material payment bond in the amount of 100% of the Contract value. The labor/material payment bond must be delivered to the Purchasing Division prior to Contract award. (Attorney General requires use of the State approved bond forms found at: www.state.wv.us/admin/purchase/forms2.html)
- d. MAINTENANCE BOND:** The apparent successful Vendor shall provide a two (2) year maintenance bond covering the roofing system if the work impacts an existing roof. The amount of the bond must be equal to the price associated with the percentage of the project impacting the roof. The maintenance bond must be issued and delivered to the Purchasing Division prior to Contract award. (Attorney General requires use of the State approved bond forms found at: www.state.wv.us/admin/purchase/forms2.html)

In lieu of the Bid Bond, the Vendor may provide certified checks, cashier's checks, or irrevocable letters of credit. Any certified check, cashier's check, or irrevocable letter of credit provided in lieu of the bid bond must be of the same amount required of the Bid Bond and delivered with the bid.

3. DRUG-FREE WORKPLACE AFFIDAVIT: W. Va. Code § 21-1D-5 provides that any solicitation for a public improvement contract requires each Vendor that submits a bid for the work to submit an affidavit that the Vendor has a written plan for a drug-free workplace policy. If the affidavit is not submitted with the bid submission, the Purchasing Division shall promptly request by telephone and electronic mail that the low bidder and second low bidder provide the affidavit within one business day of the request. Failure to submit the affidavit within one business day of receiving the request shall result in disqualification of the bid. To comply with this law, Vendor should complete the enclosed drug-free workplace affidavit and submit the same with its bid. Failure to submit the signed and notarized drugfree workplace affidavit or a similar affidavit that fully complies with the requirements of the applicable code, within one business day of being requested to do so shall result in disqualification of Vendor's bid. Pursuant to W. Va. Code 21-1D-2(b) and (k), this provision does not apply to public improvement contracts the value of which is \$100,000 or less or temporary or emergency repairs.

3.1. DRUG-FREE WORKPLACE POLICY: Pursuant to W. Va. Code § 21-1D-4, Vendor and its subcontractors must implement and maintain a written drug-free workplace policy that complies with said article. The awarding public authority shall cancel this contract if: (1) Vendor fails to implement and maintain a written drug-free workplace policy described in the preceding paragraph, (2) Vendor fails to provide information regarding implementation of its drug-free workplace policy at the request of the public authority; or (3) Vendor provides to the public authority false information regarding the contractor's drug-free workplace policy.

Pursuant to W. Va. Code 21-1D-2(b) and (k), this provision does not apply to public improvement contracts the value of which is \$100,000 or less or temporary or emergency repairs.

4. DRUG FREE WORKPLACE REPORT: Pursuant to W. Va. Code § 21-1D-7b, no less than once per year, or upon completion of the project, every contractor shall provide a certified report to the public authority which let the contract. For contracts over \$25,000, the public authority shall be the West Virginia Purchasing Division. For contracts of \$25,000 or less, the public authority shall be the agency issuing the contract. The report shall include:

- (1) Information to show that the education and training service to the requirements of West Virginia Code § 21-1D-5 was provided;
- (2) The name of the laboratory certified by the United States Department of Health and Human Services or its successor that performs the drug tests;
- (3) The average number of employees in connection with the construction on the public improvement;
- (4) Drug test results for the following categories including the number of positive tests and the number of negative tests: (A) Pre-employment and new hires; (B) Reasonable suspicion; (C) Post-accident; and (D) Random.

Vendor should utilize the attached Certified Drug Free Workplace Report Coversheet when submitting the report required hereunder. Pursuant to W. Va. Code 21-1D-2(b) and (k), this provision does not apply to public improvement contracts the value of which is \$100,000 or less or temporary or emergency repairs.

5. AIA DOCUMENTS: All construction contracts that will be completed in conjunction with architectural services procured under Chapter 5G of the West Virginia Code will be governed by the attached AIA documents, as amended by the Supplementary Conditions for the State of West Virginia, in addition to the terms and conditions contained herein.

6. PROHIBITION AGAINST GENERAL CONDITIONS: Notwithstanding anything contained in the AIA Documents or the Supplementary Conditions, the State of West Virginia will not pay for general conditions, or winter conditions, or any other condition representing a delay in the contracts. The Vendor is expected to mitigate delay costs to the greatest extent possible and any costs associated with Delays must be specifically and concretely identified. The state will not consider an average daily rate multiplied by the number of days extended to be an acceptable charge.

7. GREEN BUILDINGS MINIMUM ENERGY STANDARDS: In accordance with § 22-29-4, all new building construction projects of public agencies that have not entered the schematic design phase prior to July 1, 2012, or any building construction project receiving state grant funds and appropriations, including public schools, that have not entered the schematic design phase prior to July 1, 2012, shall be designed and constructed complying with the ICC International Energy Conservation Code, adopted by the State Fire Commission, and the ANSI/ASHRAE/IESNA Standard 90.1-2007: Provided, That if any construction project has a commitment of federal funds to pay for a portion of such project, this provision shall only apply to the extent such standards are consistent with the federal standards.

8. LOCAL LABOR MARKET HIRING REQUIREMENT: Pursuant to West Virginia Code §21-1C-1 et seq., Employers shall hire at least seventy-five percent of employees for public improvement construction projects from the local labor market, to be rounded off, with at least two employees from outside the local labor market permissible for each employer per project.

Any employer unable to employ the minimum number of employees from the local labor market shall inform the nearest office of Workforce West Virginia of the number of qualified employees needed and provide a job description of the positions to be filled.

If, within three business days following the placing of a job order, Workforce West Virginia is unable to refer any qualified job applicants to the employer or refers less qualified job applicants than the number requested, then Workforce West Virginia shall issue a waiver to the employer stating the unavailability of applicant and shall permit the employer to fill any positions covered by the waiver from outside the local labor market. The waiver shall be in writing and shall be issued within the prescribed three days. A waiver certificate shall be sent to both the employer for its permanent project records and to the public authority.

Any employer who violates this requirement is subject to a civil penalty of \$250 per each employee less than the required threshold of seventy-five percent per day of violation after receipt of a notice of violation.

Any employer that continues to violate any provision of this article more than fourteen calendar days after receipt of a notice of violation is subject to a civil penalty of \$500 per each employee less than the required threshold of seventy-five percent per day of violation.

The following terms used in this section have the meaning shown below.

(1) The term "construction project" means any construction, reconstruction, improvement, enlargement, painting, decorating or repair of any public improvement let to contract in an amount equal to or greater than \$500,000. The term "construction project" does not include temporary or emergency repairs;

(2) The term "employee" means any person hired or permitted to perform hourly work for wages by a person, firm or corporation in the construction industry; The term "employee" does not include:(i) Bona fide employees of a public authority or individuals engaged in making temporary or emergency repairs;(ii) Bona fide independent contractors; or(iii) Salaried supervisory personnel necessary to assure efficient execution of the employee's work;

(3) The term "employer" means any person, firm or corporation employing one or more employees on any public improvement and includes all contractors and subcontractors;

(4) The term "local labor market" means every county in West Virginia and any county outside of West Virginia if any portion of that county is within fifty miles of the border of West Virginia;

(5) The term "public improvement" includes the construction of all buildings, roads, highways, bridges, streets, alleys, sewers, ditches, sewage disposal plants, waterworks, airports and all other structures that may be let to contract by a public authority, excluding improvements funded, in whole or in part, by federal funds.

9. DAVIS-BACON AND RELATED ACT WAGE RATES:

The work performed under this contract is federally funded in whole, or in part. Pursuant to 2 CFR 200.317, Vendors are required to pay applicable Davis-Bacon wage rates.

The work performed under this contract is not subject to Davis-Bacon wage rates.

10. SUBCONTRACTOR LIST SUBMISSION: In accordance with W. Va. Code § 5-22-1, the apparent low bidder on a contract valued at more than \$250,000.00 for the construction, alteration, decoration, painting or improvement of a new or existing building or structure shall submit a list of all subcontractors who will perform more than \$25,000.00 of work on the project including labor and materials. (This section does not apply to any other construction projects, such as highway, mine reclamation, water or sewer projects.) The subcontractor list shall be provided to the Purchasing Division within one business day of the opening of bids for review.

If the apparent low bidder fails to submit the subcontractor list, the Purchasing Division shall promptly request by telephone and electronic mail that the low bidder and second low bidder provide the subcontractor list within one business day of the request. Failure to submit the subcontractor list within one business day of receiving the request shall result in disqualification of the bid.

If no subcontractors who will perform more than \$25,000.00 of work are to be used to complete the project, the apparent low bidder must make this clear on the subcontractor list, in the bid itself, or in response to the Purchasing Division's request for the subcontractor list.

a. Required Information. The subcontractor list must contain the following information:

i. Bidder's name

ii. Name of each subcontractor performing more than \$25,000 of work on the project.

iii. The license number of each subcontractor, as required by W. Va. Code § 21-11-1 et. seq.

iv. If applicable, a notation that no subcontractor will be used to perform more than \$25,000.00 of work. (This item iv. is not required if the vendor makes this clear in the bid itself or in documentation following the request for the subcontractor list.)

b. Subcontractor List Submission Form: The subcontractor list may be submitted in any form, including the attached form, as long as the required information noted above is included. If any information is missing from the bidder's subcontractor list submission, it may be obtained from other documents such as bids, emails, letters, etc. that accompany the subcontractor list submission.

c. Substitution of Subcontractor. Written approval must be obtained from the State Spending Unit before any subcontractor substitution is permitted. Substitutions are not permitted unless:

i. The subcontractor listed in the original bid has filed for bankruptcy;

ii. The subcontractor in the original bid has been debarred or suspended; or

iii. The contractor certifies in writing that the subcontractor listed in the original bid fails, is unable, or refuses to perform his subcontract.

Subcontractor List Submission (Construction Contracts Only)

Bidder's Name: Anderson Excavating, LLC

Check this box if no subcontractors will perform more than \$25,000.00 of work to complete the project.

Subcontractor Name	License Number if Required by W. Va. Code § 21-11-1 et. seq.
Diesel Drilling Corp	[REDACTED]

Attach additional pages if necessary

DESIGNATED CONTACT: Vendor appoints the individual identified in this Section as the Contract Administrator and the initial point of contact for matters relating to this Contract.

(Printed Name and Title) Jash Owens, Project Manager

(Address) 343 Williams Rd. Morgantown, WV 26501

(Phone Number) / (Fax Number) P: 304-983-2296 / F: 304-983-4755

(Email address) jowens@andersonexcavating.com

CERTIFICATION AND SIGNATURE: By signing below, or submitting documentation through WV OASIS, I certify that: I have reviewed this Solicitation/Contract in its entirety; that I understand the requirements, terms and conditions, and other information contained herein; that this bid, offer or proposal constitutes an offer to the State that cannot be unilaterally withdrawn; that the product or service proposed meets the mandatory requirements contained in the Solicitation/Contract for that product or service, unless otherwise stated herein; that the Vendor accepts the terms and conditions contained in the Solicitation, unless otherwise stated herein; that I am submitting this bid, offer or proposal for review and consideration; that this bid or offer was made without prior understanding, agreement, or connection with any entity submitting a bid or offer for the same material, supplies, equipment or services; that this bid or offer is in all respects fair and without collusion or fraud; that this Contract is accepted or entered into without any prior understanding, agreement, or connection to any other entity that could be considered a violation of law; that I am authorized by the Vendor to execute and submit this bid, offer, or proposal, or any documents related thereto on Vendor's behalf; that I am authorized to bind the vendor in a contractual relationship; and that to the best of my knowledge, the vendor has properly registered with any State agency that may require registration.

By signing below, I further certify that I understand this Contract is subject to the provisions of West Virginia Code § 5A-3-62, which automatically voids certain contract clauses that violate State law; and that pursuant to W. Va. Code 5A-3-63, the entity entering into this contract is prohibited from engaging in a boycott against Israel.

Anderson Excavating, LLC

(Company)

(Signature of Authorized Representative)

Steven Jeffries, Estimator 9/12/23

(Printed Name and Title of Authorized Representative) (Date)

P: 304-983-2296 / F: 304-983-4755

(Phone Number) (Fax Number)

Sjeffries@andersonexcavating.com

(Email Address)

REQUEST FOR QUOTATION – CRFQ ADJ24*04
Camp Dawson South Gate Road Slip Stabilization (Construction)

GENERAL CONSTRUCTION SPECIFICATIONS

- 1. PURPOSE AND SCOPE:** The West Virginia Purchasing Division is soliciting bids on behalf of the West Virginia Army National Guard, Construction & Facilities Management Office, to establish a contract for the one-time purchase of all material, labor, tools, taxes, transportation and expendable equipment necessary for the satisfactory and full completion of Camp Dawson South Gate Road Slip Stabilization (Construction), for Camp Dawson, located near Kingwood, WV. CTL Engineering of West Virginia, Inc., is serving as the Engineer on this project. This definition of scope is provided only to indicate the very general nature of the work that is more fully defined in the Drawings, Specifications and Project Plans.

Please follow the guidelines below regarding the meeting.

- No more than two (2) representatives of the interested bidder may attend the site visit; to limit group size.
- Site visits will take place the day of the Pre-Bid meeting in small groups as directed by the Agency Project Manager, vendors should plan on the possibility of being onsite for several hours, depending on the number of contractors who attend.
- Visiting bidder representative(s) must abide by all safety precautions for safe social distancing, as prescribed by the Agency Project Manager.
- The site visit is NOT an opportunity to ask or submit technical questions about the project. No verbal representations provided at a site visit are binding in any manner. Interested bidders should submit all technical questions per the instructions in the CRFQ.

- 2. DEFINITIONS:** The terms listed below shall have the meanings assigned to them below. Additional definitions can be found in section 2 of the General Terms and Conditions and in the Specification's Manual as defined below.

2.1 "Construction Services" means materials, labor, tools, taxes, transportation and expendable equipment necessary to complete Camp Dawson South Gate Road Slip Stabilization (Construction), as more fully described in these specifications and the Drawings/Specifications/Project Manual.

2.2 "Pricing Page" means the pages contained in wvOASIS, attached hereto, or included in the Specifications/Project Manual upon which Vendor should list its proposed price for the Construction Services.

REQUEST FOR QUOTATION – CRFQ ADJ24*04
Camp Dawson South Gate Road Slip Stabilization (Construction)

2.3 “Solicitation” means the official notice of an opportunity to supply the State with Construction Services that is published by the Purchasing Division.

2.4 “Specifications/Project Manual” means the American Institute of Architect forms, specifications, plans, drawings, and related documents developed by the architect, engineer, or Agency that provide detailed instructions on how the Construction Services are to be performed along with any American Institute of Architects documents (“AIA documents”) attached thereto.

3. ORDER OF PRECEDENCE: This General Construction Specifications document will have priority over, and supersede, anything contained in the Specifications/Project Manual.

4. QUALIFICATIONS: Vendor, or Vendor’s staff if requirements are inherently limited to individuals rather than corporate entities, shall have the following minimum qualifications:

4.1. Experience: Vendor, or Vendor’s supervisory staff assigned to this project, must have successfully completed at least 5 (five) projects that involved work similar to that described in the Specifications/Project Manual. Compliance with this experience requirement will be determined prior to contract award by the State through references provided by the Vendor upon request, through knowledge or documentation of the Vendor’s past projects, through confirmation of experience requirements from the architect assisting the State in this project, or some other method that the State determines to be acceptable. Vendor must provide any documentation requested by the State to assist in confirmation of compliance with this provision. References, documentation, or other information to confirm compliance with this experience requirement may be requested after bid opening and prior to contract award.

5. CONTRACT AWARD: The Contract is intended to provide Agency with a purchase price for the Construction Services. The Contract will be awarded to the lowest qualified responsible bidder meeting the required specifications. If the Pricing Pages contain alternates/add-ons, the Contract will be awarded based on the grand total of the base bid and any alternates/add-ons selected. This contract has **One (1)** alternate.

6. SELECTION OF ALTERNATES: Pursuant to W. Va. Code § 5-22-1(f), any solicitation of bids shall include no more than five alternates. Alternates, if accepted, shall be accepted in the order in which they are listed on the bid form. Any unaccepted alternate contained within a bid shall expire 90 days after the date of the opening of bids for review. Determination of the lowest qualified responsible bidder shall be based on the sum of the base bid and any alternates accepted. Alternate selection will be identified in the Purchase Order. This contract has **One (1)** alternate.

REQUEST FOR QUOTATION – CRFQ ADJ24*04
Camp Dawson South Gate Road Slip Stabilization (Construction)

7. **PROGRESS PAYMENTS:** The Vendor will be paid in the form of periodic progress payments for work completed. Payment requests along with documentation supporting the request will be submitted to and reviewed by the Architect. If approved, the Architect will communicate approval to the Owner and Owner will process payment. The Owner reserves the right to withhold liquidated damages from progress payments. Progress payments will be made no more than monthly.

Approval and payment of progress payments will be based on Contractor's submission of a payment allocation schedule which allocates the entire contract sum to payment milestones. Architect and Owner will review the payment allocation and may mandate changes that they believe are necessary.

8. **RETAINAGE:** Agency is entitled to withhold 10% from each progress payment made as retainage. Agency will partially release retainage upon certification of substantial completion by the Architect in accordance with this Contract but will continue to retain amounts sufficient to cover activities needed to reach final completion.
9. **PERFORMANCE:** Vendor shall perform the Construction Services in accordance with this document and the Specifications/Project Manual.
10. **SUBSTANTIAL AND FINAL COMPLETION:** Vendor shall achieve substantial completion by a date to be determined based on the notice to proceed and final completion by a date to be determined based on the notice to proceed. Failure to meet the deadlines established herein, unless extended by change order authorizing additional time free of liquidated damages, will result in liquidated damages being applied.
11. **LIQUIDATED DAMAGES:** Contractor shall pay liquidated damages in the amount of \$1,500.00 per day of delay, plus a one-time fixed cost of \$1,250.00 for Staff Judge Advocate review for work not completed after contract completion date. This clause shall in no way be considered exclusive and shall not limit the State or Agency's right to pursue any other available remedy.
12. **PROJECT PLANS:** Copies of the project plans can be obtained on the WV Oasis website.
13. **SUBSTITUTIONS:** Any substitution requests must be submitted in accordance with the official question and answer period described in the INSTRUCTIONS TO VENDORS SUBMITTING BIDS, Paragraph 4. Vendor Question Deadline.
14. **FACILITIES ACCESS:** Performance of Contract Services may require access cards and/or keys to gain entrance to Agency's facilities. In the event that access cards and/or keys are required:

REQUEST FOR QUOTATION – CRFQ ADJ24*04
Camp Dawson South Gate Road Slip Stabilization (Construction)

- 14.1. Vendor must identify principal service personnel which will be issued access cards and/or keys to perform service.
- 14.2. Vendor will be responsible for controlling cards and keys and will pay replacement fee, if the cards or keys become lost or stolen.
- 14.3. Vendor shall notify Agency immediately of any lost, stolen, or missing card or key.
- 14.4. Anyone performing under this Contract will be subject to Agency's security protocol and procedures.
- 14.5. Vendor shall inform all staff of Agency's security protocol and procedures.

15. MISCELLANEOUS:

- 15.1. **Contract Manager:** During its performance of this Contract, Vendor must designate and maintain a primary contract manager responsible for overseeing Vendor's responsibilities under this Contract. The Contract manager must be available during normal business hours to address any customer service or other issues related to this Contract. Vendor should list its Contract manager and his or her contact information below.

Contract Manager: Josh Owens

Telephone Number: 304-983-2296

Fax Number: 304-983-4755

Email Address: jowens@andersonexcavating.com

- 15.2. **Owner's Representative:** Owner's representative for notice purposes is

Name: Bob Grimm

Telephone Number: 304-791-4959

Email Address: robert.c.grimm11.nfg@army.mil

- 16. **Initial Decision Maker:** CTL Engineering of West Virginia, Inc., the Engineer, shall serve as the Initial Decision Maker in matters relating to this contract.

CAMP DAWSON SOUTH GATE ROAD SLIP STABILIZATION DESIGN

KINGWOOD, PRESTON COUNTY, WEST VIRGINIA

OWNER/DEVELOPER:

WEST VIRGINIA ARMY NATIONAL GUARD
CONTACT PERSON: JONATHAN L. NEAL
1707 COONSKIN DRIVE
CHARLESTON, WEST VIRGINIA 25311

BASE BID
(100% SUBMITTAL)

DATE: JANUARY 31, 2023

ENGINEER:

CTL CTL ENGINEERING OF WEST VIRGINIA, INC.
 Morgantown Office: 1591 Chapin Road, Morgantown, WV 26501, Phone: 304.282.1155, Fax: 304.296.8332
 Corporate Office: 2805 Fisher Road, Columbus, OH 43234, Phone: 614.276.8123, Fax: 614.276.6377
 TESTING & CONSTRUCTION OBSERVATION * LABORATORY * ENVIRONMENTAL * MINING *
 * GEOTECHNICAL * CIVIL & SITE PLANNING * SURVEYING & MAPPING

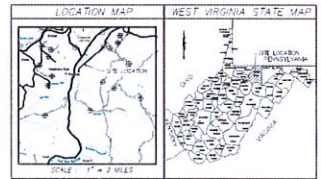

ESTIMATE OF QUANTITY				
ITEM NO.	ALT.	ITEM/DESCRIPTION	UNITS	QUANTITY
201001-000		CLEARING AND GRUBBING	AC	0.3
204001-000		MOBILIZATION	LS	1
207001-001		UNCLASSIFIED EXCAVATION	CY	306.7
211002-000		ROCK BORROW EXCAVATION	CY	151.1
229025-000		SHOULDER AND DITCH	MI	0.08
606025-004		6 INCH UNDERDRAIN PIPE	LF	207
606030-001		6 INCH OUTLET PIPE	LF	3
606020-001		AGGREGATE FILLED FABRIC UNDERDRAIN	LF	156
607001-001		TYPE 1 GUARDRAIL, CLASS 1, 31 INCH HEIGHT	LF	197
607010-020		GUARDRAIL REMOVAL	LF	57
614001-220		PILING WALL	LF	802.3
614003-001		CONCRETE LAGGING, THICKNESS 6 INCH	SF	744
636011-001		TRAFFIC CONTROL DEVICE (ROAD CLOSED)	UN	360
601002-001		CLASS B CONCRETE (WALL FOOTING ABOVE PILE CONCRETE LINE)	CY	39.7
652001-001		SEED MIXTURES, TYPE B	LB	11
652004-001		STRAW OR HAY MULCH	TN	0.206
382001-001		CONSTRUCTION LAYOUT STAKE	LS	1
542012-001		SILT FENCE	LF	218
307005-001	4.41	AGGREGATE BASE COURSE STONE OR GRAVEL, CLASS 1	TN	135

SHEET INDEX	
TITLE	SHEET NO.
TITLE SHEET	1
GENERAL NOTES	2
TRAFFIC CONTROL PLAN	3
PLAN AND PROFILE	4
PLAN	5
DRILLED PILE SUMMARY	6
DETAILS	7
BORING LOGS	8

GENERAL NOTES:

- TOTAL CONSTRUCTION AREA IS APPROX. 0.31 AC.
- ALL UNITS IN AREAS OF CONSTRUCTION TO BE FIELD-LOCATED AND VERIFIED PRIOR TO BEGINNING CONSTRUCTION.
- EROSION CONTROL MEASURES ARE TO BE INSTALLED PRIOR TO ANY OTHER CONSTRUCTION ON THE SITE AND SHALL BE MAINTAINED UNTIL PERMANENT GROUND COVER IS ESTABLISHED.



WEST VIRGINIA MISS UTILITY
1-800-245-4848

THE LOCATION OF ALL UTILITIES (ASBESTOS, GAS, ELECTRIC, TELEPHONE, CABLE, ETC.) SHOWN ON THIS PLAN IS BASED ON THE MOST RECENT RECORD DRAWINGS AND FIELD SURVEY DATA. THE CONTRACTOR SHALL BE RESPONSIBLE FOR VERIFYING THE LOCATION OF ALL UTILITIES PRIOR TO ANY CONSTRUCTION. THE CONTRACTOR SHALL BE RESPONSIBLE FOR NOTIFYING THE WEST VIRGINIA MISS UTILITY (800-245-4848) PRIOR TO ANY CONSTRUCTION.



TITLE SHEET

ITEM 616 - MAINTAINING TRAFFIC
 THE ROAD WILL BE CLOSED FOR A MAXIMUM OF 90 DAYS. LOCAL TRAFFIC WILL BE DETOURED.
 THE CONTRACTOR SHALL PROVIDE, ERECT AND MAINTAIN ALL NECESSARY BARRICADES, SUITABLE AND SUFFICIENT LIGHT, DANGER SIGNALS, SIGNS AND OTHER TRAFFIC CONTROL DEVICES. THE CONTRACTOR SHALL TAKE ALL NECESSARY PRECAUTIONS FOR THE PROTECTION OF THE WORK AND SAFETY OF THE PUBLIC. THE ROADWAYS TO BE CLOSED TO TRAFFIC AND SHALL BE PROTECTED BY EFFECTIVE BARRICADES, AND OBSTRUCTIONS SHALL BE ILLUMINATED DURING HOURS OF DARKNESS. SUITABLE WARNING SIGNS SHALL BE PROVIDED TO PROPERLY CONTROL AND DIRECT TRAFFIC.
 ALL WORK AND TRAFFIC CONTROL DEVICES SHALL BE IN ACCORDANCE WITH SECTION 6.06 AND OTHER APPLICABLE PORTIONS OF THE SPECIFICATIONS, AS WELL AS THE INSDOT 2008 EDITION MANUAL ON TEMPORARY TRAFFIC CONTROL FOR STREETS AND HIGHWAYS AND THE PROVISIONS OF 17S.3.
 PAYMENT FOR ALL LABOR, EQUIPMENT AND MATERIALS SHALL BE INCLUDED IN THE LUMP SUM CONTRACT PRICE FOR SUB MAINTAINING TRAFFIC.

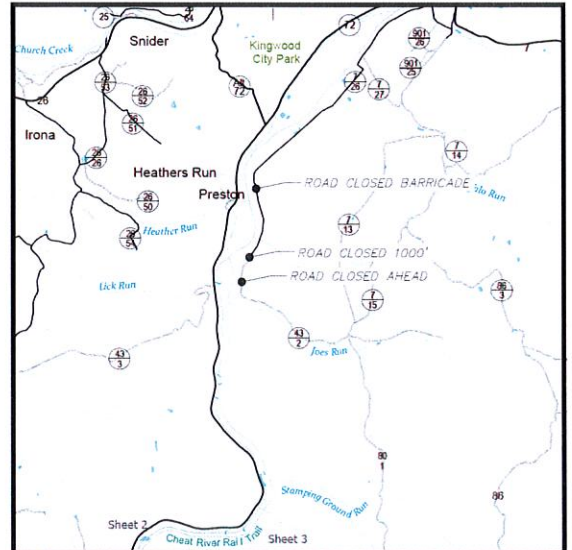
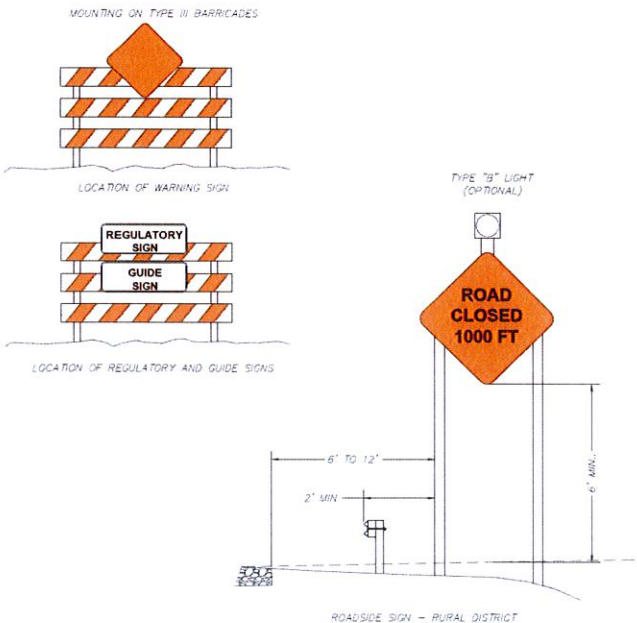

SCALE: 1" = 2000'



W20-3
48" X 48"



R11-2
48" X 30"

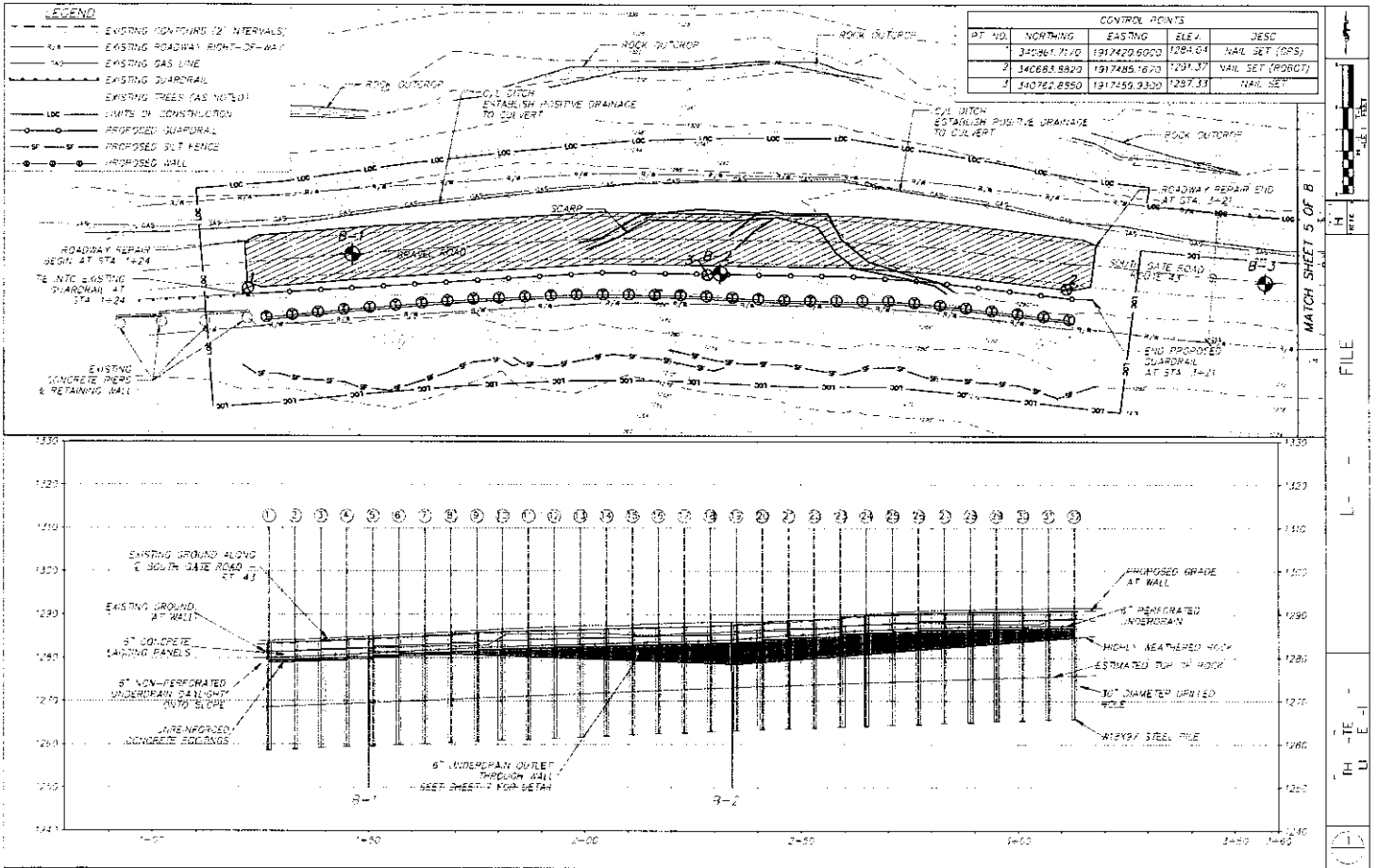

MATCH SHEET 5 OF 8

FILE

L -

H - U E -

1

LEGEND

- - - - - EXISTING CONTOURS 1' INTERVAL
- 1/4" — EXISTING ROADWAY RIGHT-OF-WAY
- 3/4" — EXISTING GAS LINE
- — — EXISTING DRAINAGE
- — — EXISTING DRAINAGE
- — — EXISTING TREES (AS NOTED)
- LOC — LIMITS OF CONSTRUCTION
- — ○ — PROPOSED GUARDRAIL
- — — PROPOSED SILT FENCE
- — ● — PROPOSED WALL

CONTROL POINTS				
PT. NO.	NORTHING	EASTING	ELEV.	DESC.
1	340562.5510	1817525.6450	1500.27	VARE SET

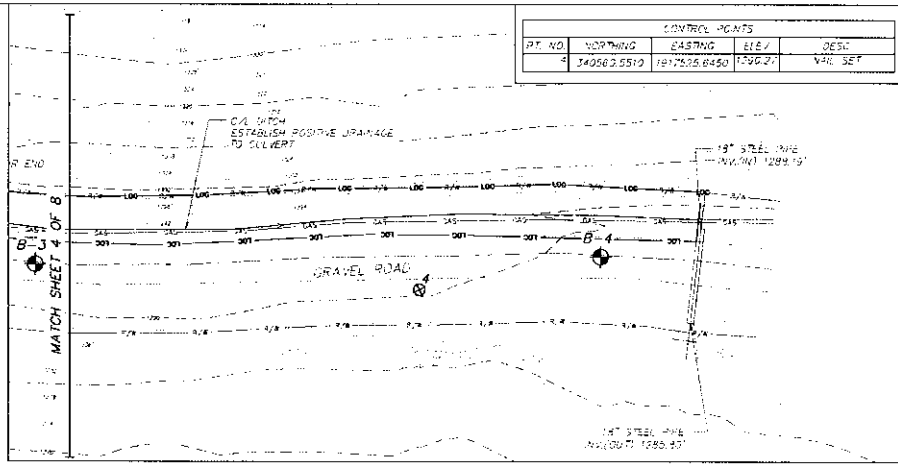

TH - TE -

U E T

Table 4-1. (continued)

WELL	DATE	ELEVATION	DEPTH	METER	TOP OF		BOTTOM OF	BOTTOM OF		APPROX TOP	CORRECT	ELEVATION	DATE
					ROCK	ROCK		ROCK	ROCK				
11	1-17	117.75	12.82	BT	340855 1673	1917413 8747	1281.4	1281.4	1272.4	1253.6	1253.6	22.5	24.9
12	1-17	117.75	12.86	BT	340843 2315	1917413 1949	1281.7	1281.4	1272.4	1253.9	1253.9	22.5	24.9
13	1-17	117.75	12.76	BT	340844 3788	1917413 6943	1281.9	1281.9	1272.7	1253.7	1253.7	22.5	24.9
14	1-17	117.75	12.81	BT	340839 1674	1917413 5853	1281.2	1281.2	1272.9	1253.1	1253.1	22.5	24.9
15	1-17	117.98	12.67	BT	340833 7300	1917413 1313	1281.3	1281.2	1269.2	1249.6	1249.6	22.5	24.9
16	1-17	118.00	12.50	BT	340828 2821	1917413 6452	1281.4	1281.4	1269.5	1249.8	1249.8	22.5	24.9
17	1-17	118.00	12.38	BT	340822 3364	1917413 1857	1281.2	1281.6	1269.8	1249.2	1249.2	22.5	24.9
18	1-17	118.20	12.26	BT	340817 4894	1917413 8816	1281.3	1281.7	1261.2	1249.4	1249.4	22.5	24.9
19	1-17	118.00	12.32	BT	340811 3142	1917413 1407	1281.2	1281.8	1261.3	1249.8	1249.8	22.5	24.9
20	1-17	118.20	12.35	BT	340808 3674	1917413 4697	1281.2	1281.7	1261.3	1249.8	1249.8	22.5	24.9
21	1-17	118.00	12.41	BT	340800 2273	1917413 2275	1281.2	1281.2	1261.3	1249.8	1249.8	22.5	24.9
22	1-17	118.00	12.41	BT	340795 2776	1917413 3122	1281.2	1281.2	1261.3	1249.8	1249.8	22.5	24.9
23	1-17	118.00	12.58	BT	340789 2121	1917413 2023	1281.2	1281.7	1261.3	1249.8	1249.8	22.5	24.9
24	1-17	118.00	12.62	BT	340783 1215	1917413 3653	1281.2	1281.2	1261.3	1249.8	1249.8	22.5	24.9
25	1-17	118.00	12.67	BT	340778 4843	1917413 3523	1281.2	1281.3	1261.3	1249.8	1249.8	22.5	24.9
26	1-17	118.00	12.67	BT	340772 4843	1917413 3523	1281.2	1281.3	1261.3	1249.8	1249.8	22.5	24.9
27	1-17	118.00	12.67	BT	340767 1119	1917413 3692	1281.2	1281.2	1261.3	1249.8	1249.8	22.5	24.9
28	1-17	118.00	12.71	BT	340761 4027	1917413 1676	1281.2	1281.8	1261.3	1249.8	1249.8	22.5	24.9
29	1-17	118.00	12.71	BT	340755 3273	1917413 810	1281.2	1281.4	1261.3	1249.8	1249.8	22.5	24.9
30	1-17	118.00	12.81	BT	340749 3478	1917413 1232	1281.2	1281.4	1261.3	1249.8	1249.8	22.5	24.9
31	1-17	118.00	12.81	BT	340744 2120	1917413 2121	1281.2	1281.7	1261.3	1249.8	1249.8	22.5	24.9
32	1-17	118.00	12.81	BT	340738 2377	1917413 1423	1281.2	1281.7	1261.3	1249.8	1249.8	22.5	24.9
33	1-17	118.00	12.81	BT	340732 2377	1917413 4403	1281.2	1281.3	1261.3	1249.8	1249.8	22.5	24.9
34	1-17	118.00	12.81	BT	340727 2430	1917413 4327	1281.2	1281.7	1261.3	1249.8	1249.8	22.5	24.9
35	1-17	118.00	12.81	BT	340721 2430	1917413 5375	1281.2	1281.2	1261.3	1249.8	1249.8	22.5	24.9
36	1-17	118.00	12.81	BT	340715 2430	1917413 1211	1281.2	1281.2	1261.3	1249.8	1249.8	22.5	24.9
37	1-17	118.00	12.81	BT	340709 2430	1917413 1406	1281.2	1281.2	1261.3	1249.8	1249.8	22.5	24.9
38	1-17	118.00	12.81	BT	340703 2430	1917413 1034	1281.2	1281.2	1261.3	1249.8	1249.8	22.5	24.9
39	1-17	118.00	12.81	BT	340697 2430	1917413 922	1281.2	1281.2	1261.3	1249.8	1249.8	22.5	24.9
40	1-17	118.00	12.81	BT	340691 2430	1917413 2458	1281.2	1281.2	1261.3	1249.8	1249.8	22.5	24.9
41	1-17	118.00	12.81	BT	340685 2430	1917413 3200	1281.2	1281.2	1261.3	1249.8	1249.8	22.5	24.9
42	1-17	118.00	12.81	BT	340679 2430	1917413 1492	1281.2	1281.2	1261.3	1249.8	1249.8	22.5	24.9

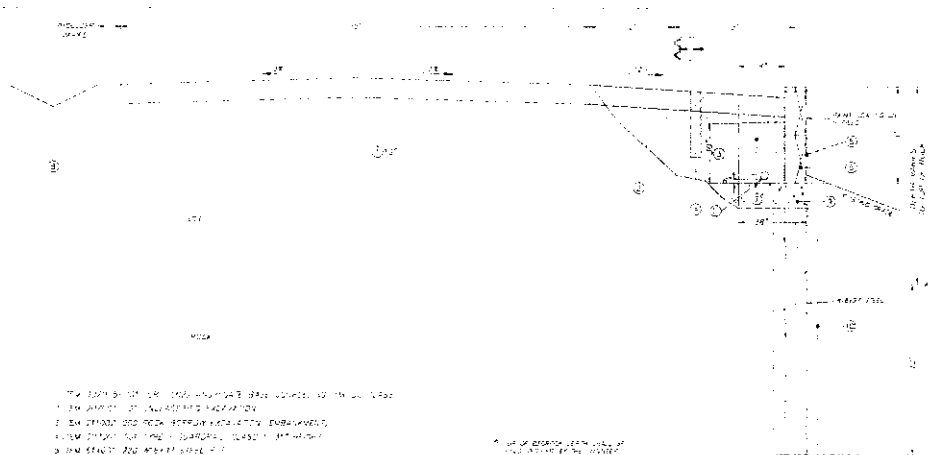

- 1. THE ROOMS ON THE GROUND FLOOR SHALL BE CONSIDERED AS PER PLAN
- 2. THE ROOMS ON THE GROUND FLOOR SHALL BE CONSIDERED AS PER PLAN
- 3. THE ROOMS ON THE GROUND FLOOR SHALL BE CONSIDERED AS PER PLAN
- 4. THE ROOMS ON THE GROUND FLOOR SHALL BE CONSIDERED AS PER PLAN
- 5. THE ROOMS ON THE GROUND FLOOR SHALL BE CONSIDERED AS PER PLAN
- 6. THE ROOMS ON THE GROUND FLOOR SHALL BE CONSIDERED AS PER PLAN
- 7. THE ROOMS ON THE GROUND FLOOR SHALL BE CONSIDERED AS PER PLAN
- 8. THE ROOMS ON THE GROUND FLOOR SHALL BE CONSIDERED AS PER PLAN
- 9. THE ROOMS ON THE GROUND FLOOR SHALL BE CONSIDERED AS PER PLAN
- 10. THE ROOMS ON THE GROUND FLOOR SHALL BE CONSIDERED AS PER PLAN
- 11. THE ROOMS ON THE GROUND FLOOR SHALL BE CONSIDERED AS PER PLAN

ALL DIMENSIONS ARE IN METERS
 UNLESS SPECIFIED OTHERWISE

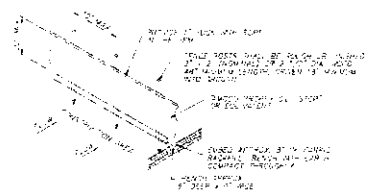

- 1. THE ROOF SHALL BE CONSIDERED AS PER PLAN
- 2. THE ROOF SHALL BE CONSIDERED AS PER PLAN
- 3. THE ROOF SHALL BE CONSIDERED AS PER PLAN
- 4. THE ROOF SHALL BE CONSIDERED AS PER PLAN
- 5. THE ROOF SHALL BE CONSIDERED AS PER PLAN
- 6. THE ROOF SHALL BE CONSIDERED AS PER PLAN
- 7. THE ROOF SHALL BE CONSIDERED AS PER PLAN
- 8. THE ROOF SHALL BE CONSIDERED AS PER PLAN
- 9. THE ROOF SHALL BE CONSIDERED AS PER PLAN
- 10. THE ROOF SHALL BE CONSIDERED AS PER PLAN
- 11. THE ROOF SHALL BE CONSIDERED AS PER PLAN

ALL DIMENSIONS ARE IN METERS
 UNLESS SPECIFIED OTHERWISE



- 1. THE WALL SHALL BE CONSIDERED AS PER PLAN
- 2. THE WALL SHALL BE CONSIDERED AS PER PLAN
- 3. THE WALL SHALL BE CONSIDERED AS PER PLAN
- 4. THE WALL SHALL BE CONSIDERED AS PER PLAN
- 5. THE WALL SHALL BE CONSIDERED AS PER PLAN
- 6. THE WALL SHALL BE CONSIDERED AS PER PLAN
- 7. THE WALL SHALL BE CONSIDERED AS PER PLAN
- 8. THE WALL SHALL BE CONSIDERED AS PER PLAN
- 9. THE WALL SHALL BE CONSIDERED AS PER PLAN
- 10. THE WALL SHALL BE CONSIDERED AS PER PLAN
- 11. THE WALL SHALL BE CONSIDERED AS PER PLAN

ALL DIMENSIONS ARE IN METERS
 UNLESS SPECIFIED OTHERWISE



ALL DIMENSIONS ARE IN METERS
 UNLESS SPECIFIED OTHERWISE

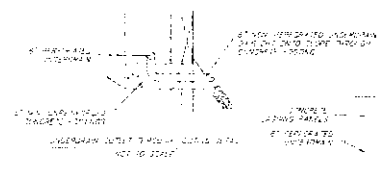

ALL DIMENSIONS ARE IN METERS
 UNLESS SPECIFIED OTHERWISE

ALL DIMENSIONS ARE IN METERS
 UNLESS SPECIFIED OTHERWISE

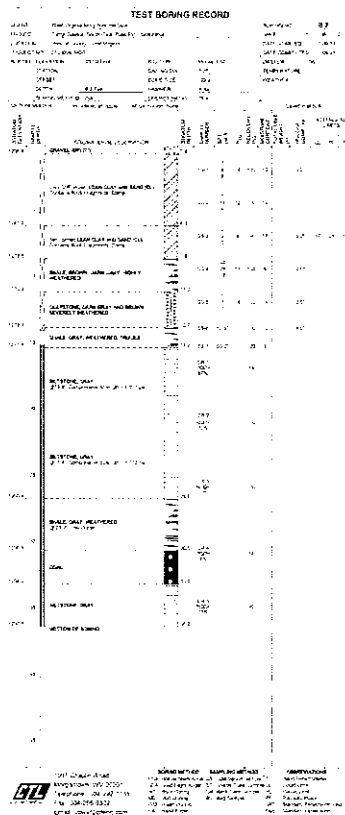
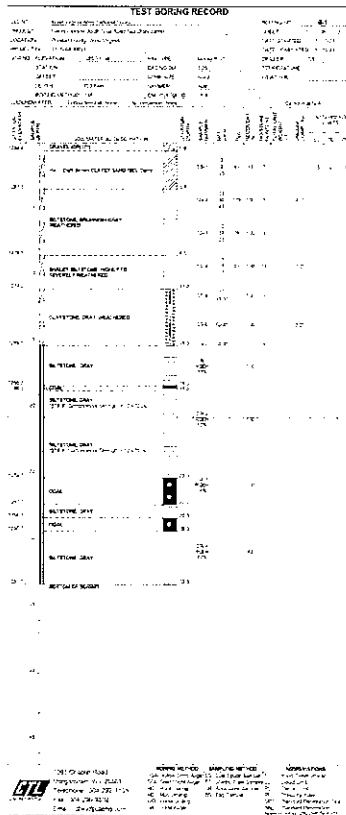

CAMP DAWSON SOUTH GATE ROAD SLIP STABILIZATION DESIGN

KINGWOOD, PRESTON COUNTY, WEST VIRGINIA

OWNER/DEVELOPER:

WEST VIRGINIA ARMY NATIONAL GUARD
CONTACT PERSON: JONATHAN L. NEAL
1707 COONSKIN DRIVE
CHARLESTON, WEST VIRGINIA 25311

ALTERNATE BID (100% SUBMITTAL)

DATE: JANUARY 31, 2023

ENGINEER:



GENERAL NOTES:

1. TOTAL DISTURBED AREA = APPROX. 0.18 AC.
2. ALL UTILITIES IN AREA OF CONSTRUCTION TO BE FIELD-LOCATED AND VERIFIED PRIOR TO BEGINNING CONSTRUCTION.
3. DETENTION FACILITIES AND EROSION CONTROL MEASURES ARE TO BE INSTALLED PRIOR TO ANY OTHER CONSTRUCTION ON THE SITE AND SHALL BE MAINTAINED UNTIL TEMPORARY GROUND COVER IS ESTABLISHED.
4. ALL DEMOLITION OF EXISTING STRUCTURES SHALL BE PERFORMED BY THE SITE CONTRACTOR.

ESTIMATE OF QUANTITY				
ITEM NO.	ALT.	ITEM/DESCRIPTION	UNITS	QUANTITY
201001-000		CLEARING AND GRUBBING	AC	0.15
204001-000		MOBILIZATION	LS	1
207001-001		UNCLASSIFIED EXCAVATION	CY	263.6
211002-000		ROCK BORROW EXCAVATION	CY	126.9
675021-320		18 INCH STEEL CASING PIPE	LF	22
633001-001		DUMP ROCK GUTTER D50 = 12 INCHES	CY	3.6
606025-004		6 INCH UNDERDRAIN PIPE	LF	132
606030-001		6 INCH OUTLET PIPE	LF	3
606020-001		AGGREGATE FILLED FABRIC UNDERDRAIN	LF	132
607001-001		TYPE 1 GUARDRAIL, CLASS 1, 31 INCH HEIGHT	LF	200
614001-220		PILE WALL	LF	657
614001-001		CONCRETE LAGGING, THICKNESS 6 INCH	SF	268
636001-001		TRAFFIC CONTROL DEVICE (ROAD CLOSED)	UN	350
601002-001		CLASS B CONCRETE (WALL FOOTING ABOVE PILE CONCRETE LINE)	CY	12.4
652003-001		SEED MIXTURES, TYPE B	LB	11
652004-001		STRAW OR HAY MULCH	TN	0.205
638001-001		CONSTRUCTION LAYOUT STAKE	LS	1
642012-001		SILT FENCE	LF	205
307009-001	441	AGGREGATE BASE COURSE STONE OR GRAVEL, CLASS 1	TN	136

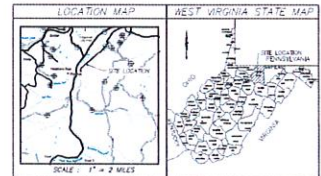

SHEET INDEX

TITLE	SHEET NO.
TITLE SHEET	1
GENERAL NOTES	2
TRAFFIC CONTROL PLAN	3
PLAN AND PROFILE	4
DRILLED SHAFT SUMMARY	5
GULVERT DETAIL	6
DETAILS	7
BORING LOGS	8



WEST VIRGINIA MISS UTILITY
1-800-245-4548



TITLE SHEET

WEST VIRGINIA MISS UTILITY



ITEM 636 - MAINTAINING TRAFFIC
 THE ROAD WILL BE CLOSED FOR A MAXIMUM OF 90 DAYS. LOCAL TRAFFIC WILL BE DETOURED.
 THE CONTRACTOR SHALL PROVIDE, ERECT, AND MAINTAIN ALL NECESSARY BARRICADES, SUITABLE AND SUFFICIENT LIGHTS, DANGER SIGNALS, SIGNS, AND OTHER TRAFFIC CONTROL DEVICES. THE CONTRACTOR SHALL TAKE ALL NECESSARY PRECAUTIONS FOR THE PROTECTION OF THE WORK AND SAFETY OF THE PUBLIC. THE ROADWAYS IS TO BE CLOSED TO TRAFFIC AND SHALL BE PROTECTED BY ERECTING BARRICADES, AND OBSTRUCTIONS SHALL BE ILLUMINATED DURING HOURS OF DARKNESS. SUITABLE WARNING SIGNS SHALL BE PROVIDED TO PROPERLY CONTROL AND DIRECT TRAFFIC.
 ALL WORK AND TRAFFIC CONTROL DEVICES SHALL BE IN ACCORDANCE WITH SECTION 636 AND OTHER APPLICABLE PORTIONS OF THE SPECIFICATIONS, AS WELL AS THE WISCONSIN 2006 EDITION MANUAL ON TEMPORARY TRAFFIC CONTROL FOR STREETS AND HIGHWAYS, AND THE PROVISIONS OF 715.3.
 PAYMENT FOR ALL LABOR, EQUIPMENT AND MATERIALS SHALL BE INCLUDED IN THE LUMP SUM CONTRACT PRICE FOR 636, MAINTAINING TRAFFIC.

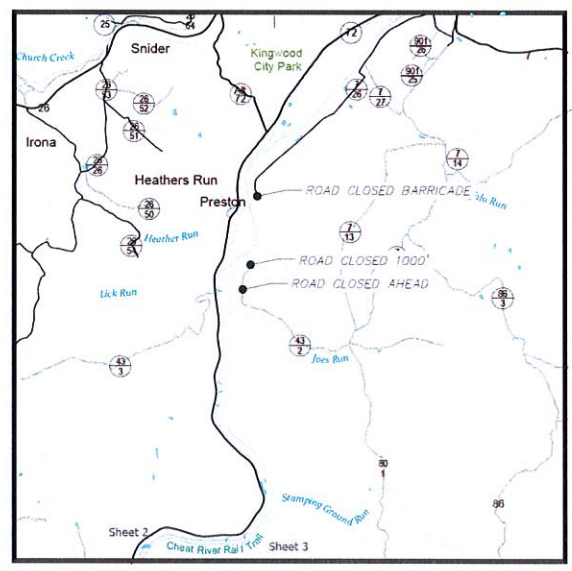
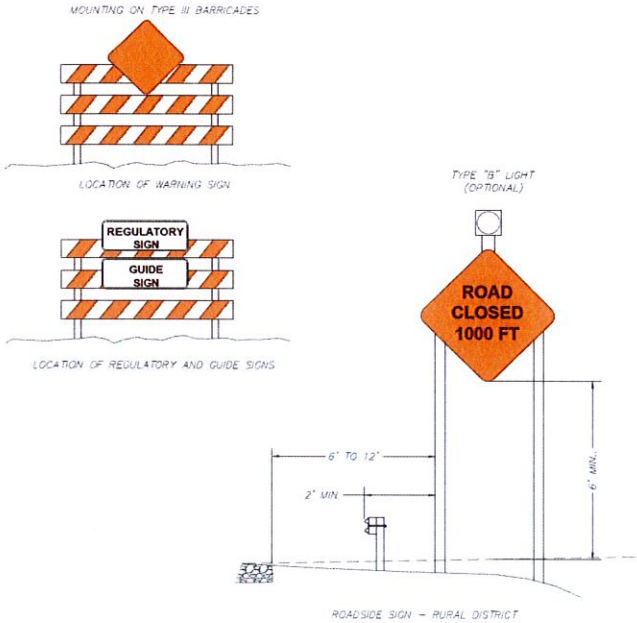

W20-3
48" X 48"

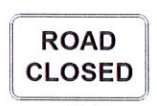

R11-2
48" X 30"

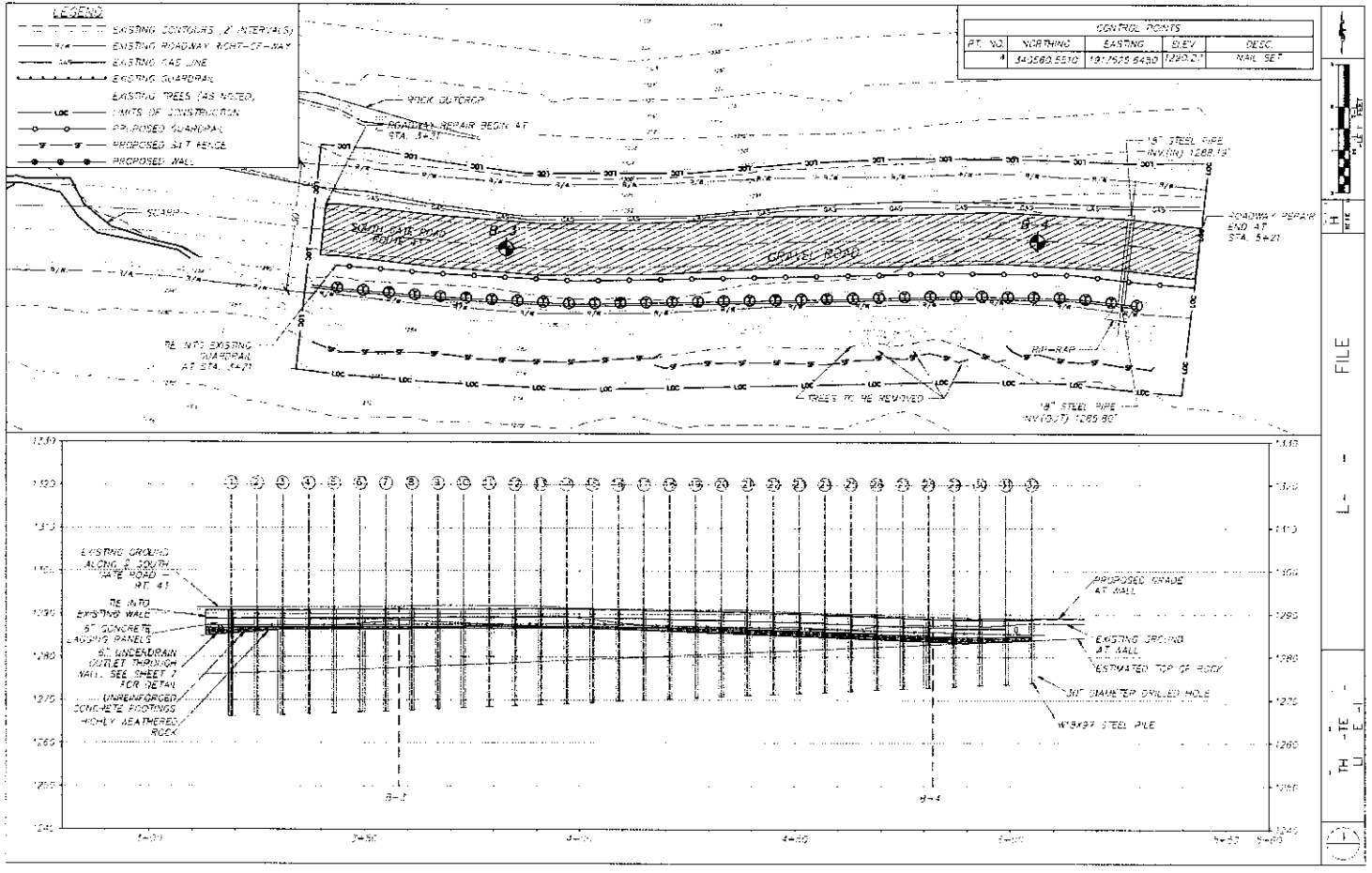

- LEGEND**
- - - - - EXISTING CONTOURS 2' INTERVALS
 - 1/4" — EXISTING ROADWAY RIGHT-OF-WAY
 - 1/4" — EXISTING GAS LINE
 - 1/4" — EXISTING GAS LINE
 - 1/4" — EXISTING GUARDRAIL
 - 1/4" — EXISTING TREES (AS NOTED)
 - LOC — LIMITS OF CONSTRUCTION
 - — PROPOSED GUARDRAIL
 - ○ — PROPOSED S&T FENCE
 - ○ — PROPOSED WALL

CONTROL POINTS				
PT. NO.	NORTHING	EASTING	ELEV.	DESC.
4	343880.5510	1917565.6430	1289.27	NAIL SET



FILE

L

H
H
H



561 WA. SUMMARY

NO.	DATE	TIME	TYPE	MON. TIME	TUE. TIME	TOP OF TERRACE ELEV.	TOP OF CORRAL E. ELEV.	NO. IN CORRAL E. ELEV.	SOUTH OF CORRAL E. ELEV.	APPROX. TOP OF ROCK ELEV.	WINDING VALLEY ELEV.	BLM	
1	3-10	3-20	22	17.11	17.11	340675.0068	1917480.0000	1290.2	1288.7	1286.0	1286.2	278.2	24.7
2	3-10	3-28	20	18.23	18.23	340669.2103	1917481.6124	1290.2	1289.1	1286.9	1286.4	278.4	24.0
3	3-11	3-34	20	18.09	18.09	340663.4340	1917483.1634	1290.2	1288.8	1286.9	1286.9	278.8	24.3
4	3-11	3-40	20	18.01	18.01	340657.2433	1917484.3409	1290.2	1288.8	1286.0	1286.8	278.8	24.1
5	3-11	3-46	20	18.07	18.07	340651.2127	1917486.3653	1290.2	1288.7	1286.2	1287.2	278.2	24.0
6	3-11	3-51	25	18.01	18.01	340645.1243	1917488.1243	1290.2	1288.2	1286.0	1287.2	277.7	24.0
7	3-11	3-57	25	18.44	18.44	340640.2393	1917490.9378	1290.2	1288.2	1287.0	1287.4	277.4	24.8
8	3-11	3-57	34	18.21	18.21	340634.6644	1917491.6644	1290.2	1288.0	1286.0	1287.6	277.6	24.3
9	3-11	3-58	20	18.24	18.24	340628.9340	1917493.4336	1290.2	1288.1	1286.1	1287.2	277.2	24.5
10	3-11	3-58	21	18.26	18.26	340623.1985	1917493.1933	1290.2	1288.1	1286.1	1288.1	278.1	24.0
11	3-11	3-59	21	18.59	18.59	340617.8650	1917497.2407	1290.2	1288.4	1287.2	1288.4	278.4	24.8
12	3-11	3-59	23	18.52	18.52	340611.9653	1917499.3253	1290.2	1288.3	1287.2	1288.1	278.1	24.8
13	3-11	3-59	24	18.44	18.44	340606.3653	1917501.6903	1290.2	1288.1	1287.2	1288.9	278.9	24.4
14	3-11	3-59	24	18.38	18.38	340600.7661	1917503.7021	1290.2	1288.4	1287.2	1288.2	278.2	24.3
15	3-11	4-00	24	18.02	18.02	340595.1661	1917505.6603	1290.2	1288.2	1287.2	1288.2	278.2	24.1
16	3-11	4-00	27	18.02	18.02	340589.5710	1917508.1099	1290.2	1288.1	1287.1	1288.2	278.2	24.1
17	3-11	4-01	27	18.27	18.27	340583.9759	1917510.1041	1290.2	1287.9	1287.0	1288.1	278.1	24.0
18	3-11	4-01	28	18.41	18.41	340578.3812	1917512.1612	1290.2	1287.8	1286.0	1288.3	278.3	24.7
19	3-11	4-02	28	18.38	18.38	340572.7913	1917514.2113	1290.2	1288.2	1286.9	1288.0	278.0	24.9
20	3-11	4-04	28	18.42	18.42	340567.1903	1917516.6075	1290.2	1288.2	1286.6	1288.8	278.8	24.8
21	3-11	4-04	28	18.28	18.28	340561.5893	1917518.4658	1290.2	1288.3	1286.5	1288.5	278.5	24.9
22	3-11	4-06	28	18.16	18.16	340556.2243	1917521.0827	1290.2	1288.3	1286.9	1288.2	278.2	24.9
23	3-11	4-07	28	18.12	18.12	340550.4190	1917523.2743	1290.2	1288.4	1286.9	1288.4	278.4	24.9
24	3-11	4-08	28	18.16	18.16	340544.8526	1917525.4667	1290.2	1288.2	1286.9	1288.3	278.3	24.9
25	3-11	4-08	28	18.23	18.23	340539.2547	1917527.6577	1290.2	1288.2	1286.8	1288.2	278.2	24.4
26	3-11	4-09	28	18.50	18.50	340533.6517	1917529.8500	1290.2	1288.2	1286.5	1288.4	278.4	24.9
27	3-11	4-10	28	18.24	18.24	340527.9179	1917531.9600	1290.2	1288.2	1286.3	1288.5	278.5	24.7
28	3-11	4-11	28	18.21	18.21	340522.2440	1917534.0100	1290.2	1288.2	1286.3	1288.9	278.9	24.9
29	3-11	4-12	28	18.26	18.26	340516.5734	1917536.0600	1290.2	1288.2	1286.3	1289.1	279.1	24.9
30	3-11	4-13	28	18.12	18.12	340510.9028	1917538.1100	1290.2	1288.2	1286.2	1289.4	279.4	24.8
31	3-11	4-13	28	18.03	18.03	340505.2322	1917540.1600	1290.2	1288.1	1286.2	1289.3	279.3	24.9
32	3-11	4-13	28	18.03	18.03	340499.5616	1917542.2100	1290.2	1288.0	1286.2	1289.3	279.3	24.8

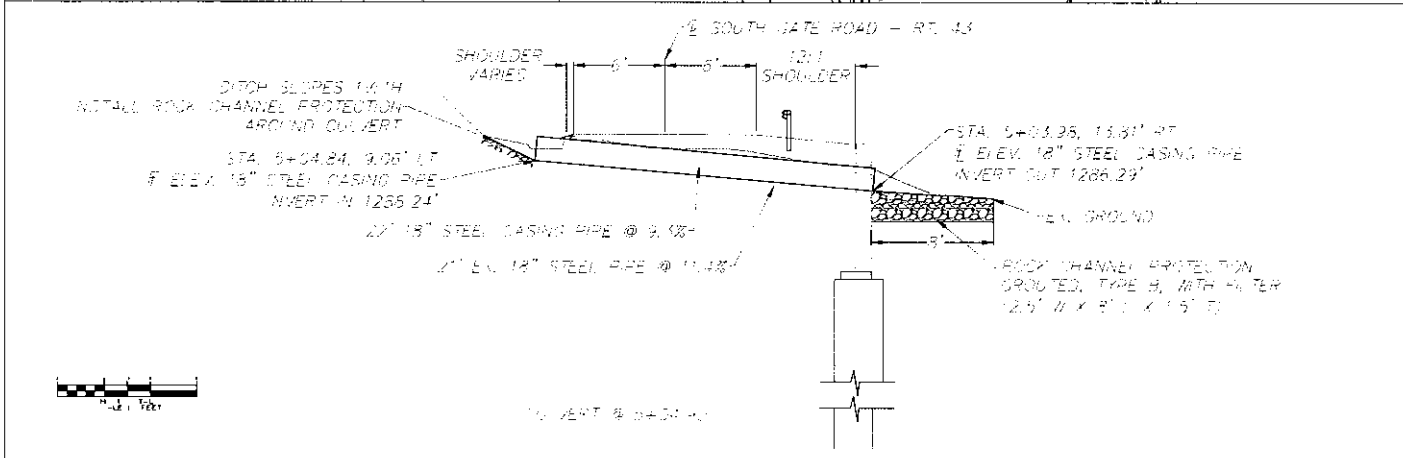
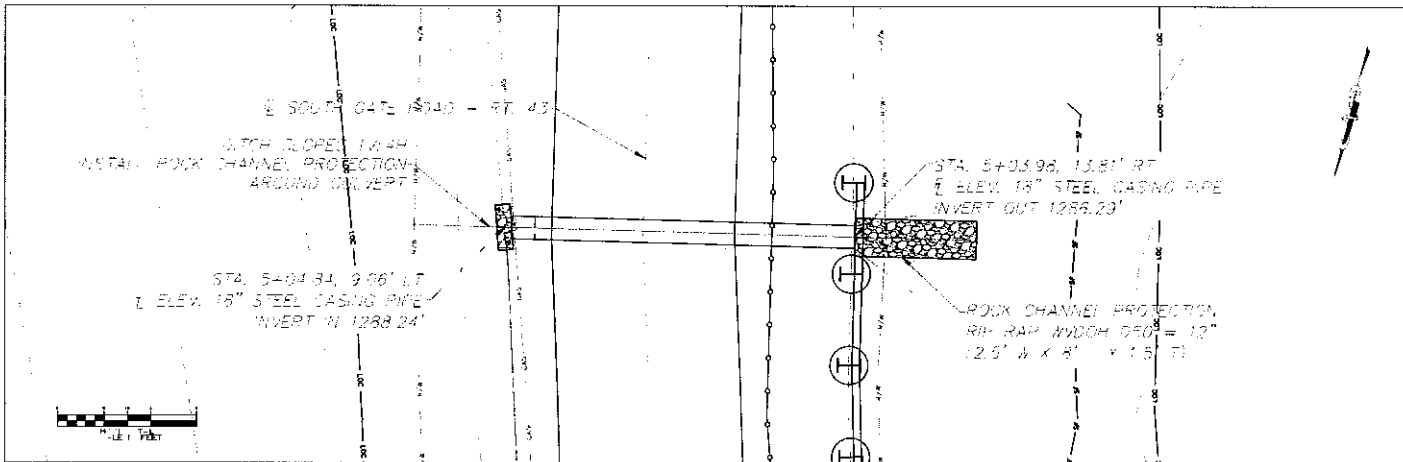

A
 L E T E T - I L
 T H U
 ()

EXHIBIT A- BID FORM

THE PROJECT AND THE PARTIES

1.01 TO:

- A. Owner
 WV Army National Guard
 1707 Coonskin Drive
 Charleston, WV 25311

1.02 FOR:

- A. Project: Camp Dawson South Gate Road Slip
 Stabilization Construction
 1001 Army Road
 Kingwood, WV 26537

1.03 DATE: 9/12/23 (BIDDER TO ENTER DATE)

1.04 SUBMITTED BY: (BIDDER TO ENTER NAME AND ADDRESS)

- A. Bidder's Full Name Anderson Excavating
 1. Address 343 Williams Rd.
 2. City, State, Zip Morgantown, WV 26501

1.05 OFFER

- A. Having examined the Place of The Work and all matters referred to in the Instructions to Bidders and the Contract Documents prepared by CTL Engineering of West Virginia, Inc., for the above project, we, the undersigned, hereby offer to enter into a Contract to perform the Work for the Sum of:
- B. Base Bid: Five Hundred Ninety Three Thousand Six Hundred Twenty Six dollars and Twenty cents dollars
 (\$ 593,626.20), in lawful money of the United States of America.
- C. Alternate No. 1 (To repair and stabilize an additional 0.15 acres at the site): ADD Five Hundred Twelve Thousand Six Hundred Twenty Nine dollars and Twenty cents dollars
 (\$ 512,629.20), in lawful money of the United States of America.
- D. We have included the required security deposit as required by the Instruction to Bidders.

1.06 ACCEPTANCE

- A. This offer shall be open to acceptance and is irrevocable for sixty days from the bid closing date.
- B. If this bid is accepted by Owner within the time period stated above, we will:
 1. Execute the Agreement within seven days of receipt of Notice of Award.
 2. Furnish the required bonds within seven days of receipt of Notice of Award.
- C. If this bid is accepted within the time stated, and we fail to commence the Work or we fail to provide the required Bond(s), the security deposit shall be forfeited as damages to Owner by reason of our failure, limited in amount to the lesser of the face value of the security deposit or the difference between this bid and the bid upon which a Contract is signed.

1.07 ADDENDA

- A. The following Addenda have been received. The modifications to the Bid Documents noted below have been considered and all costs are included in the Bid Sum.
 1. Addendum # 1 Dated 9/5/23
 2. Addendum # _____ Dated _____
 3. Addendum # _____ Dated _____
 4. Addendum # _____ Dated _____

1.08 BID FORM SIGNATURE(S)

- A. 

Camp Dawson South Gate Road
Slip Stabilization

Bid Form

EXHIBIT A- BID FORM

Anderson Excavating, LLC

B. (Bidder - print the full name of your firm)

C. Steven Jeffries, Estimator

D. (Authorized signing officer, Title)

1.09 IF THE BID IS A JOINT VENTURE OR PARTNERSHIP, ADD ADDITIONAL FORMS OF EXECUTION FOR EACH MEMBER OF THE JOINT VENTURE IN THE APPROPRIATE FORM OR FORMS AS ABOVE.

END OF SECTION

CAMP DAWSON SOUTH GATE ROAD SLIP - BASE BID UNIT PRICE DETAILS

ITEM NO.	ITEM/DESCRIPTION	UNITS	QUANTITY	UNIT COST	TOTAL
201001-000	CLEARING AND GRUBBING	LS	1	8,500	8,500. ⁰⁰
204001-000	MOBILIZATION	LS	1	63,000	63,000. ⁰⁰
207001-001	UNCLASSIFIED EXCAVATION	CY	307	117. ⁰⁰	35,919. ⁰⁰
211002-000	ROCK BORROW EXCAVATION	CY	151	144. ⁰⁰	21,744. ⁰⁰
229001-000	SHOULDERS AND DITCHES	LF	423	10. ⁰⁰	4,230. ⁰⁰
606025-004	6 INCH UNDERDRAIN PIPE	LF	207	20. ⁰⁰	4,140. ⁰⁰
606030-001	6 INCH OUTLET PIPE	LF	3	111. ⁰⁰	333. ⁰⁰
606020-001	AGGREGATE FILLED FABRIC UNDERDRAIN	LF	186	50. ⁰⁰	9,300. ⁰⁰
607001-001	TYPE 1 GUARDRAIL, CLASS 1, 31 INCH HEIGHT	LF	197	78. ⁰⁰	15,366. ⁰⁰
607010-020	GUARDRAIL REMOVAL	LF	57	26. ⁰⁰	1,482. ⁰⁰
614001-220	PILING WALL	LF	803	343. ⁰⁰	275,429. ⁰⁰
614003-001	CONCRETE LAGGING, THICKNESS 6 INCH	SF	1488	52. ⁰⁰	77,376. ⁰⁰
636011-001	TRAFFIC CONTROL DEVICE (ROAD CLOSED)	LS	1	2,500	2,500. ⁰⁰
601002-001	CLASS B CONCRETE (Wall Footing above Pile Concrete Line)	CY	40	1,400	56,000. ⁰⁰
652003-001	SEED MIXTURES, TYPE B	LB	11	70. ⁰⁰	770. ⁰⁰
652004-001	STRAW OR HAY MULCH	TN	.206	5,200	1,071. ²⁰
639001-001	CONSTRUCTION LAYOUT STAKE	LS	1	5,750	5,750. ⁰⁰
642012-001	SILT FENCE	LF	218	12. ⁰⁰	2,616. ⁰⁰
307005-001	AGGREGATE BASE COURSE STONE OR GRAVEL, CLASS 1	TN	135	60. ⁰⁰	8,100. ⁰⁰
				BASE BID TOTAL	593,626.²⁰

CAMP DAWSON SOUTH GATE ROAD SLIP - ALTERNATE BID ITEM #1 UNIT PRICE DETAILS					
ITEM NO.	ITEM/DESCRIPTION	UNITS	QUANTITY	UNIT COST	TOTAL
201001-000	CLEARING AND GRUBBING	LS	1	8,100	8,100. ⁰⁰
204001-000	MOBILIZATION	LS	1	62,000	62,000. ⁰⁰
207001-001	UNCLASSIFIED EXCAVATION	CY	264	110. ⁰⁰	29,040. ⁰⁰
211002-000	ROCK BORROW EXCAVATION	CY	126	175. ⁰⁰	22,050. ⁰⁰
675021-320	18 INCH STEEL CASING	LF	22	336. ⁰⁰	7,392. ⁰⁰
633003-001	DUMP ROCK GUTTER, D50 = 12 INCHES	CY	4	500. ⁰⁰	2,000. ⁰⁰
606025-004	6 INCH UNDERDRAIN PIPE	LF	132	20. ⁰⁰	2,640. ⁰⁰
606030-001	6 INCH OUTLET PIPE	LF	3	111. ⁰⁰	333. ⁰⁰
606020-001	AGGREGATE FILLED FABRIC UNDERDRAIN	LF	198	50. ⁰⁰	9,600. ⁰⁰
607001-001	TYPE 1 GUARDRAIL, CLASS 1, 31 INCH HEIGHT	LF	200	78. ⁰⁰	15,600. ⁰⁰
614001-220	PILING WALL	LF	657	343. ⁰⁰	225,351. ⁰⁰
614003-001	CONCRETE LAGGING, THICKNESS 6 INCH	SF	1536	52. ⁰⁰	79,872. ⁰⁰
636011-001	TRAFFIC CONTROL DEVICE (ROAD CLOSED)	LS	1	2,500	2,500. ⁰⁰
601002-001	CLASS B CONCRETE (Wall Footing above Pile Concrete Line)	CY	20	1,400	28,000. ⁰⁰
652003-001	SEED MIXTURES, TYPE B	LB	11	70. ⁰⁰	770. ⁰⁰
652004-001	STRAW OR HAY MULCH	TN	.206	5,200	1,071. ⁰⁰
639001-001	CONSTRUCTION LAYOUT STAKE	LS	1	5,750	5,750. ⁰⁰
642012-001	SILT FENCE	LF	205	12. ⁰⁰	2,460. ⁰⁰
307005-001	AGGREGATE BASE COURSE STONE OR GRAVEL, CLASS 1	TN	135	60. ⁰⁰	8,100. ⁰⁰
				ALT. BID #1 TOTAL	512,629. ⁰⁰

BID BOND

KNOW ALL MEN BY THESE PRESENTS, That we, the undersigned, Anderson Excavating, LLC
of Morgantown, West Virginia, as Principal, and Ohio farmers Insurance Co
of Westfield Center, Ohio, a corporation organized and existing under the laws of the State of OH
with its principal office in the City of Westfield Center, as Surety, are held and firmly bound unto the State
of West Virginia, as Obligee, in the penal sum of Five Percent of Bid (\$ 5%) for the payment of which,
well and truly to be made, we jointly and severally bind ourselves, our heirs, administrators, executors, successors and assigns.

The Condition of the above obligation is such that whereas the Principal has submitted to the Purchasing Section of the
Department of Administration a certain bid or proposal, attached hereto and made a part hereof, to enter into a contract in writing for
Construction : Camp Dawson South Gate Road Slip Stabilization

NOW THEREFORE,

- (a) If said bid shall be rejected, or
- (b) If said bid shall be accepted and the Principal shall enter into a contract in accordance with the bid or proposal
attached hereto and shall furnish any other bonds and insurance required by the bid or proposal, and shall in all other respects perform
the agreement created by the acceptance of said bid, then this obligation shall be null and void, otherwise this obligation shall remain in
full force and effect. It is expressly understood and agreed that the liability of the Surety for any and all claims hereunder shall, in no
event, exceed the penal amount of this obligation as herein stated.

The Surety, for the value received, hereby stipulates and agrees that the obligations of said Surety and its bond shall be in no
way impaired or affected by any extension of the time within which the Obligee may accept such bid, and said Surety does hereby
waive notice of any such extension.

WITNESS, the following signatures and seals of Principal and Surety, executed and sealed by a proper officer of Principal and
Surety, or by Principal individually if Principal is an individual, this 12th day of September, 2023.

Principal Seal

Anderson Excavating, LLC
(Name of Principal)

By [Signature]
(Must be President, Vice President, or
Duly Authorized Agent)

Managing Member
(Title)

Surety Seal

Ohio Farmers Insurance Co
(Name of Surety)

[Signature]
Attorney-in-Fact

**IMPORTANT – Surety executing bonds must be licensed in West Virginia to transact surety insurance, must affix its seal, and
must attach a power of attorney with its seal affixed.**

THIS POWER OF ATTORNEY SUPERCEDES ANY PREVIOUS POWER BEARING THIS SAME POWER # AND ISSUED PRIOR TO 02/08/23, FOR ANY PERSON OR PERSONS NAMED BELOW.

POWER NO. 4750402 02

General Power of Attorney

Westfield Insurance Co. Westfield National Insurance Co. Ohio Farmers Insurance Co. Westfield Center, Ohio

CERTIFIED COPY

Know All Men by These Presents, That WESTFIELD INSURANCE COMPANY, WESTFIELD NATIONAL INSURANCE COMPANY and OHIO FARMERS INSURANCE COMPANY, corporations, hereinafter referred to individually as a "Company" and collectively as "Companies," duly organized and existing under the laws of the State of Ohio, and having its principal office in Westfield Center, Medina County, Ohio, do by these presents make, constitute and appoint JOHN JAY PALLOTTA, TIMOTHY CRAIG JENNINGS, TODD HOY, SHELLI ANDERSON, KELLY L. TASKER, ALEXANDER DAVID BARONE, EMILY ZIMMERMAN, JOINTLY OR SEVERALLY

of FAIRMONT and State of WV its true and lawful Attorney(s)-in-Fact, with full power and authority hereby conferred in its name, place and stead, to execute, acknowledge and deliver any and all bonds, recognizances, undertakings, or other instruments or contracts of suretyship in any penal limit.

LIMITATION: THIS POWER OF ATTORNEY CANNOT BE USED TO EXECUTE NOTE GUARANTEE, MORTGAGE DEFICIENCY, MORTGAGE GUARANTEE, OR BANK DEPOSITORY BONDS.

and to bind any of the Companies thereby as fully and to the same extent as if such bonds were signed by the President, sealed with the corporate seal of the applicable Company and duly attested by its Secretary, hereby ratifying and confirming all that the said Attorney(s)-in-Fact may do in the premises. Said appointment is made under and by authority of the following resolution adopted by the Board of Directors of each of the WESTFIELD INSURANCE COMPANY, WESTFIELD NATIONAL INSURANCE COMPANY and OHIO FARMERS INSURANCE COMPANY:

"Be It Resolved, that the President, any Senior Executive, any Secretary or any Fidelity & Surety Operations Executive or other Executive shall be and is hereby vested with full power and authority to appoint any one or more suitable persons as Attorney(s)-in-Fact to represent and act for and on behalf of the Company subject to the following provisions:

The Attorney-in-Fact may be given full power and authority for and in the name of and on behalf of the Company, to execute, acknowledge and deliver, any and all bonds, recognizances, contracts, agreements of indemnity and other conditional or obligatory undertakings and any and all notices and documents canceling or terminating the Company's liability thereunder, and any such instruments so executed by any such Attorney-in-Fact shall be as binding upon the Company as if signed by the President and sealed and attested by the Corporate Secretary."

"Be it Further Resolved, that the signature of any such designated person and the seal of the Company heretofore or hereafter affixed to any power of attorney or any certificate relating thereto by facsimile, and any power of attorney or certificate bearing facsimile signatures or facsimile seal shall be valid and binding upon the Company with respect to any bond or undertaking to which it is attached." (Each adopted at a meeting held on February 8, 2000).

In Witness Whereof, WESTFIELD INSURANCE COMPANY, WESTFIELD NATIONAL INSURANCE COMPANY and OHIO FARMERS INSURANCE COMPANY have caused these presents to be signed by their National Surety Leader and Senior Executive and their corporate seals to be hereto affixed this 08th day of FEBRUARY A.D., 2023.

Corporate Seals Affixed



WESTFIELD INSURANCE COMPANY WESTFIELD NATIONAL INSURANCE COMPANY OHIO FARMERS INSURANCE COMPANY

Handwritten signature of Gary W. Stumper

By: Gary W. Stumper, National Surety Leader and Senior Executive

State of Ohio County of Medina ss.:

On this 08th day of FEBRUARY A.D., 2023, before me personally came Gary W. Stumper to me known, who, being by me duly sworn, did depose and say, that he resides in Medina, OH; that he is National Surety Leader and Senior Executive of WESTFIELD INSURANCE COMPANY, WESTFIELD NATIONAL INSURANCE COMPANY and OHIO FARMERS INSURANCE COMPANY, the companies described in and which executed the above instrument; that he knows the seals of said Companies; that the seals affixed to said instrument are such corporate seals; that they were so affixed by order of the Boards of Directors of said Companies; and that he signed his name thereto by like order.

Notarial Seal Affixed



Handwritten signature of David A. Kotnik

David A. Kotnik, Attorney at Law, Notary Public My Commission Does Not Expire (Sec. 147.03 Ohio Revised Code)

State of Ohio County of Medina ss.:

I, Frank A. Carrino, Secretary of WESTFIELD INSURANCE COMPANY, WESTFIELD NATIONAL INSURANCE COMPANY and OHIO FARMERS INSURANCE COMPANY, do hereby certify that the above and foregoing is a true and correct copy of a Power of Attorney, executed by said Companies, which is still in full force and effect; and furthermore, the resolutions of the Boards of Directors, set out in the Power of Attorney are in full force and effect.

In Witness Whereof, I have hereunto set my hand and affixed the seals of said Companies at Westfield Center, Ohio, this 12th day of

September, 2023



Handwritten signature of Frank A. Carrino

Frank A. Carrino, Secretary



CERTIFICATE OF LIABILITY INSURANCE

DATE (MM/DD/YYYY)
9/5/2023

THIS CERTIFICATE IS ISSUED AS A MATTER OF INFORMATION ONLY AND CONFERS NO RIGHTS UPON THE CERTIFICATE HOLDER. THIS CERTIFICATE DOES NOT AFFIRMATIVELY OR NEGATIVELY AMEND, EXTEND OR ALTER THE COVERAGE AFFORDED BY THE POLICIES BELOW. THIS CERTIFICATE OF INSURANCE DOES NOT CONSTITUTE A CONTRACT BETWEEN THE ISSUING INSURER(S), AUTHORIZED REPRESENTATIVE OR PRODUCER, AND THE CERTIFICATE HOLDER.

IMPORTANT: If the certificate holder is an ADDITIONAL INSURED, the policy(ies) must be endorsed. If SUBROGATION IS WAIVED, subject to the terms and conditions of the policy, certain policies may require an endorsement. A statement on this certificate does not confer rights to the certificate holder in lieu of such endorsement(s).

PRODUCER Bond Insurance Agency 104 Adams St Fairmont WV 26554	CONTACT NAME: Shelli Anderson PHONE (A/C No. Ext): 304-534-7047 E-MAIL ADDRESS: sanderson@bondins.com FAX (A/C No): 304-842-7321													
	<table border="1"> <tr> <th>INSURER(S) AFFORDING COVERAGE</th> <th>NAIC #</th> </tr> <tr> <td>INSURER A : Westfield Insurance Company</td> <td>24112</td> </tr> <tr> <td>INSURER B : Indian Harbor Insurance Co</td> <td></td> </tr> <tr> <td>INSURER C : Brickstreet Insurance</td> <td>12372</td> </tr> <tr> <td>INSURER D :</td> <td></td> </tr> <tr> <td>INSURER E :</td> <td></td> </tr> <tr> <td>INSURER F :</td> <td></td> </tr> </table>	INSURER(S) AFFORDING COVERAGE	NAIC #	INSURER A : Westfield Insurance Company	24112	INSURER B : Indian Harbor Insurance Co		INSURER C : Brickstreet Insurance	12372	INSURER D :		INSURER E :		INSURER F :
INSURER(S) AFFORDING COVERAGE	NAIC #													
INSURER A : Westfield Insurance Company	24112													
INSURER B : Indian Harbor Insurance Co														
INSURER C : Brickstreet Insurance	12372													
INSURER D :														
INSURER E :														
INSURER F :														
INSURED Anderson Excavating, LLC 343 Williams Rd Morgantown WV 26501 <small>ANDEEXC-02</small>														

COVERAGES **CERTIFICATE NUMBER:** 1685018662 **REVISION NUMBER:**

THIS IS TO CERTIFY THAT THE POLICIES OF INSURANCE LISTED BELOW HAVE BEEN ISSUED TO THE INSURED NAMED ABOVE FOR THE POLICY PERIOD INDICATED. NOTWITHSTANDING ANY REQUIREMENT, TERM OR CONDITION OF ANY CONTRACT OR OTHER DOCUMENT WITH RESPECT TO WHICH THIS CERTIFICATE MAY BE ISSUED OR MAY PERTAIN, THE INSURANCE AFFORDED BY THE POLICIES DESCRIBED HEREIN IS SUBJECT TO ALL THE TERMS, EXCLUSIONS AND CONDITIONS OF SUCH POLICIES. LIMITS SHOWN MAY HAVE BEEN REDUCED BY PAID CLAIMS.

INSR LTR	TYPE OF INSURANCE	ADDL INSD	SUBR WVD	POLICY NUMBER	POLICY EFF (MM/DD/YYYY)	POLICY EXP (MM/DD/YYYY)	LIMITS
A	<input checked="" type="checkbox"/> COMMERCIAL GENERAL LIABILITY <input type="checkbox"/> CLAIMS-MADE <input checked="" type="checkbox"/> OCCUR <input checked="" type="checkbox"/> XCU Included GEN'L AGGREGATE LIMIT APPLIES PER: <input type="checkbox"/> POLICY <input checked="" type="checkbox"/> PROJECT <input type="checkbox"/> LOC <input type="checkbox"/> OTHER:			CMM3432577	5/29/2023	5/29/2024	EACH OCCURRENCE \$ 1,000,000 DAMAGE TO RENTED PREMISES (Ea occurrence) \$ 500,000 MED EXP (Any one person) \$ 5,000 PERSONAL & ADV INJURY \$ 1,000,000 GENERAL AGGREGATE \$ 2,000,000 PRODUCTS - COMP/OP AGG \$ 2,000,000 \$
A	<input checked="" type="checkbox"/> AUTOMOBILE LIABILITY <input checked="" type="checkbox"/> ANY AUTO <input type="checkbox"/> ALL OWNED AUTOS <input checked="" type="checkbox"/> HIRED AUTOS <input type="checkbox"/> SCHEDULED AUTOS <input checked="" type="checkbox"/> NON-OWNED AUTOS			CMM3432577	5/29/2023	5/29/2024	COMBINED SINGLE LIMIT (Ea accident) \$ 1,000,000 BODILY INJURY (Per person) \$ BODILY INJURY (Per accident) \$ PROPERTY DAMAGE (Per accident) \$ \$
A	<input checked="" type="checkbox"/> UMBRELLA LIAB <input checked="" type="checkbox"/> OCCUR <input type="checkbox"/> EXCESS LIAB <input type="checkbox"/> CLAIMS-MADE DED <input checked="" type="checkbox"/> RETENTION \$ 0			CMM3432577	5/29/2023	5/29/2024	EACH OCCURRENCE \$ 10,000,000 AGGREGATE \$ 10,000,000 \$
C	WORKERS COMPENSATION AND EMPLOYERS' LIABILITY ANY PROPRIETOR/PARTNER/EXECUTIVE OFFICER/MEMBER EXCLUDED? (Mandatory in NH) if yes, describe under DESCRIPTION OF OPERATIONS below Y / N <input type="checkbox"/> N/A			WCB1009899	12/16/2022	12/16/2023	<input checked="" type="checkbox"/> PER STATUTE <input type="checkbox"/> OTHER WW Broad Form EL E.L. EACH ACCIDENT \$ 1,000,000 E.L. DISEASE - EA EMPLOYEE \$ 1,000,000 E.L. DISEASE - POLICY LIMIT \$ 1,000,000
A	Motor Truck Cargo			CMM3432577	5/29/2023	5/29/2024	Occurrence Limit 500,000 Occurrence/Aggregate \$5 Million/\$5 Mil Deductible \$2,500 500,000
B	Pollution/Professional			PEC004890005	12/19/2022	12/19/2023	
A	Blanket Equipment Rental			CMM3432577	5/29/2023	5/29/2024	

DESCRIPTION OF OPERATIONS / LOCATIONS / VEHICLES (ACORD 101, Additional Remarks Schedule, may be attached if more space is required)
 *NOTE: Employers Liability for Ohio Workers Compensation is included under policy #CMM3432577 for \$1,000,000.
 Workers Compensation coverage is provided in both West Virginia and Pennsylvania.
 Federal Black Lung coverage is included in Workers Compensation policy. Broad Form applied to WV Workers Compensation
 Project: Camp Dawson South Gate Road Slip Stabilization. Solicitation No: CRFQ 0603 ADJ2400000004.

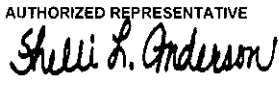
CERTIFICATE HOLDER West Virginia Army National Guard 1707 Coonskin Drive Charleston WV 25311 United States	CANCELLATION SHOULD ANY OF THE ABOVE DESCRIBED POLICIES BE CANCELLED BEFORE THE EXPIRATION DATE THEREOF, NOTICE WILL BE DELIVERED IN ACCORDANCE WITH THE POLICY PROVISIONS.
	AUTHORIZED REPRESENTATIVE 

© 1988-2014 ACORD CORPORATION. All rights reserved.



**State of West Virginia
DRUG FREE WORKPLACE CONFORMANCE AFFIDAVIT
West Virginia Code §21-1D-5**

I, Steven Jeffries, after being first duly sworn, depose and state as follows:

1. I am an employee of Anderson Excavating; and,
(Company Name)
2. I do hereby attest that Anderson Excavating
(Company Name)

maintains a written plan for a drug-free workplace policy and that such plan and policy are in compliance with **West Virginia Code §21-1D**.

The above statements are sworn to under the penalty of perjury.

Printed Name: Steven Jeffries

Signature: [Handwritten Signature]

Title: Estimator

Company Name: Anderson Excavating

Date: 9/12/23

STATE OF WEST VIRGINIA,

COUNTY OF Monongalia, TO-WIT:

Taken, subscribed and sworn to before me this 12th day of September, 2023.

By Commission expires 02/09/2028

(Seal)

[Handwritten Signature]
(Notary Public)

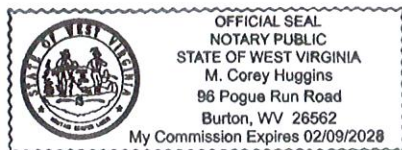



CONTRACTOR LICENSE

AUTHORIZED BY THE
West Virginia Contractor
Licensing Board

NUMBER: WV033687

CLASSIFICATION:

GENERAL BUILDING
GENERAL ENGINEERING
EXCAVATION

ANDERSON EXCAVATING LLC
DBA ANDERSON EXCAVATING LLC
343 WILLIAMS ROAD
MORGANTOWN, WV 26501

DATE ISSUED

FEBRUARY 13, 2023

EXPIRATION DATE

FEBRUARY 13, 2024

Authorized Signature

Chair, West Virginia Contractor
Licensing Board



A copy of this license must be readily available for inspection by the Board on every job site where contracting work is being performed. This license number must appear in all advertisements, on all bid submissions, and on all fully executed and binding contracts. This license is non-transferable. This license is being issued under the provisions of West Virginia Code, Chapter 30, Article 42.



State of West Virginia
PURCHASING DIVISION
Construction Bid Submission Review Form

This list has been provided for informational purposes only and is not to be construed as a complete list of request for quotation or bidding requirements for any individual construction project. This list does not and cannot include every item, mistake or oversight that could cause a contractor's bid to be disqualified. Rather, this list is intended to draw attention to some of the most common problems that the Purchasing Division encounters in the bidding process for construction projects. All potential bidders must read the request for quotation, all additional documents, and all instructions relating thereto ("Bid Documents") in their entirety to identify the actual request for quotation and bidding requirements. Failure to read the Bid Documents in their entirety and comply with the stated requirements contained therein may result in bid disqualification.

Errors That Shall Be Reason for Immediate Bid Disqualification

1. Failure to attend a mandatory pre-bid meeting
2. Failure to sign the bid
3. Failure to supply a valid bid bond or other surety approved by the state of West Virginia
4. Failure to meet any mandatory requirement of the solicitation
5. Failure to submit bid prior to the bid opening date and time
6. Federal debarment
7. State of West Virginia debarment or suspension

Errors that May Be Reason for Bid Disqualification Before Contract Award

1. Failure to acknowledge receipt of Addenda (only if stipulated as mandatory)
2. Debt to the state or political subdivision (must be cured prior to award)
3. Workers' Compensation or Unemployment Compensation delinquency (must be cured prior to award)
4. Not registered as a vendor with the state of West Virginia (must be cured prior to award)
5. Failure to obtain required bonds and/or insurance
6. Failure to provide the sub-contractor listing within one business day of bid opening or one business day of the request to do so by the Purchasing Division
7. Failure to supply West Virginia contractor's license number with bid or within one day of Purchasing Division request to do so
8. Failure to supply a signed drug-free workplace affidavit with bid or within one day of Purchasing Division request to do so
9. Failure to use the provided solicitation form (only if stipulated as mandatory)



Department of Administration
 Purchasing Division
 2019 Washington Street East
 Post Office Box 50130
 Charleston, WV 25305-0130

**State of West Virginia
 Centralized Request for Quote**

Proc Folder: 1278455			Reason for Modification: Addendum No. 1
Doc Description: Construction: Camp Dawson South Gate Road Slip Stabilization			
Proc Type: Central Purchase Order			
Date Issued	Solicitation Closes	Solicitation No	Version
2023-09-05	2023-09-12 13:30	CRFQ 0603 ADJ2400000004	2

BID RECEIVING LOCATION

BID CLERK
 DEPARTMENT OF ADMINISTRATION
 PURCHASING DIVISION
 2019 WASHINGTON ST E
 CHARLESTON WV 25305
 US

VENDOR

Vendor Customer Code:

Vendor Name :

Address :

Street :

City :

State : **Country :** **Zip :**

Principal Contact :

Vendor Contact Phone: **Extension:**

FOR INFORMATION CONTACT THE BUYER
 David H Pauline
 304-558-0067
 david.h.pauline@wv.gov

Vendor Signature X **FEIN#** **DATE**

All offers subject to all terms and conditions contained in this solicitation

ADDITIONAL INFORMATION

Addendum No. 1 -

1. Provide copies of pre-bid sign-in sheets from mandatory pre-bid meeting held on 08/24/2023.
2. To provide a clarification to the specifications - see attached pages.
3. To move the bid opening date from 09/06/2023 to 09/12/2023.
The bid opening time remains at 1:30 pm.

No other changes.

INVOICE TO

ADJUTANT GENERALS
OFFICE
1707 COONSKIN DR

CHARLESTON
US

WV

SHIP TO

CAMP DAWSON ARMY
TRAINING SITE
240 ARMY RD

KINGWOOD
US

WV

Line	Comm Ln Desc	Qty	Unit Issue	Unit Price	Total Price
1	BASE BID- Camp Dawson South Gate Road Slip				

Comm Code**Manufacturer****Specification****Model #**

72000000

Extended Description:

See attached Pricing Page, Bid Form

Contract Item #1- BASE BID- Labor & materials per the construction documents

INVOICE TO		SHIP TO	
ADJUTANT GENERALS OFFICE 1707 COONSKIN DR		CAMP DAWSON ARMY TRAINING SITE 240 ARMY RD	
CHARLESTON	WV	KINGWOOD	WV
US		US	

Line	Comm Ln Desc	Qty	Unit Issue	Unit Price	Total Price
2	Alternate #1- Repair and Stabilize additional 0.15 acres				

Comm Code	Manufacturer	Specification	Model #
72000000			

Extended Description:

See attached Pricing Page, Bid Form

Contract Item#2- Alternate #1- To repair and stabilize an additional 0.15 acres at the site per the contract documents.

SCHEDULE OF EVENTS		
<u>Line</u>	<u>Event</u>	<u>Event Date</u>
1	Mandatory Pre-bid Meeting at 10:30 am., est.	2023-08-24
2	Vendor Technical Questions Due By Noon est.	2023-08-30

SOLICITATION NUMBER: ADJ2400000004
Addendum Number: 1

The purpose of this addendum is to modify the solicitation identified as ("Solicitation") to reflect the change(s) identified and described below.

Applicable Addendum Category:

- Modify bid opening date and time
- Modify specifications of product or service being sought
- Attachment of vendor questions and responses
- Attachment of pre-bid sign-in sheet
- Correction of error
- Other

Description of Modification to Solicitation:

1. **To provide a clarification to the specifications. See attachment.**
2. **To provide copies of the pre-bid sign-in sheets from the mandatory pre-bid meeting held on 8/24/2023.**
3. **To extend the bid opening from 09/06/2023 to 09/12/2023 at 1:30 pm.**

Additional Documentation: Documentation related to this Addendum (if any) has been included herewith as Attachment A and is specifically incorporated herein by reference.

Terms and Conditions:

1. All provisions of the Solicitation and other addenda not modified herein shall remain in full force and effect.
2. Vendor should acknowledge receipt of all addenda issued for this Solicitation by completing an Addendum Acknowledgment, a copy of which is included herewith. Failure to acknowledge addenda may result in bid disqualification. The addendum acknowledgement should be submitted with the bid to expedite document processing.



DEPARTMENT OF THE ARMY
JOINT FORCES HEADQUARTERS WEST VIRGINIA
1707 COONSKIN DRIVE
CHARLESTON, WEST VIRGINIA 25311-1026

September 5, 2023

ADDENDUM NO. 1- CRFQ-ADJ2400000004

RE: Construction - Camp Dawson South Gate Road Slip Stabilization
West Virginia Army National Guard
Camp Dawson, Kingwood, WV 26537

TO: Prospective Bidders

FROM: West Virginia Army National Guard

NOTE: This Addendum forms a part of the Contract Documents and modifies the original Bidding Documents.

PART 1 – INFORMATION FOR BIDDERS

Bid Date moved to September 12, 2023 @ 1:30 pm EST

PART 2 – CLARIFICATIONS TO SPECIFICATIONS

Clarification No. 1: NOTE: The current plans show Lagging Panels at four feet (4'), in height. Due to additional movement on the landslide the Lagging Panel Height will need to be adjusted to eight feet (8') in height.

END OF ADDENDUM

Pre-Bid Sign-In Sheet

Solicitation Number: ADJ2400000004

Date of Pre-Bid Meeting: August 24th, 2023

Location of Prebid Meeting: Camp Dawson, Kingwood, WV

Please Note:

Vendors must sign-in on this sheet to verify attendance at the Pre-Bid meeting.
 Failure to legibly sign in may be grounds for declaring a vendor ineligible to bid.
 For further verification, please also provide a business card if possible.

<u>Firm Represented:*</u>	<u>Rep Name (Printed):</u>	<u>Firm Address:</u>	<u>Telephone #:</u>	<u>Fax #:</u>	<u>Email:</u>
West Virginia Army National Guard Construction and Facility Management Office	LTC Jonathan Judy	1001 Army Road Kingwood, WV 26537	304-791-4160		jonathan.b.judy.mil@army.mil
West Virginia Army National Guard Construction and Facility Management Office	Jonathan L. Neal	1001 Army Road Kingwood, WV 26537	304-791-4138		jonathan.l.neal.nfg@army.mil
West Virginia Army National Guard Construction and Facility Management Office	Robert Grimm	1001 Army Road Kingwood, WV 26537	304-791-2959		robert.c.grimm11.nfg@army.mil
West Virginia Army National Guard Construction and Facility Management Office	Phillip J. Cantrell	1001 Army Road Kingwood, WV 26537	304-791-4089		phillip.j.cantrell2.nfg@army.mil
The Dirt Doctor	Joe Williams	6341 Tal Bott Rd Belington, WV 26025	304-614-8887		jwilliams@thedirtdoctor.com
B&A	Bob Ayersman	13972 George W. Hays Roxburgh, WV	304-290-2885		bobayersman@yahoo.com

**One Vendor Per Representative - No one individual is permitted to represent more than one vendor at the pre-bid meeting. Any individual that does attempt to represent two or more vendors will be required to select one vendor to which the individual's attendance will be attributed. The vendors not selected will be deemed to have not attended the pre-bid meeting unless another individual attended on their behalf.*

Pre-Bid Sign-In Sheet

Solicitation Number: ADJ2400000004

Date of Pre-Bid Meeting: August 24th, 2023

Location of Prebid Meeting: Camp Dawson, Kingwood, WV

Please Note:

Vendors must sign-in on this sheet to verify attendance at the Pre-Bid meeting.
 Failure to legibly sign in may be grounds for declaring a vendor ineligible to bid.
 For further verification, please also provide a business card if possible.

Firm Represented:*	Rep Name (Printed):	Firm Address:	Telephone #:	Fax #:	Email:
CTL Engineering	JOE Grani	1091 Chaplin Rd Morgantown WV 26501	(304) 292 1135		jgrani@ ctleng.com
Doss ENTERPRISES	Ron Haymond	JANE LEW, WV	304-627-8324		ron.haymond@ DossEnterprises.com
Coastal Drilling	Devin Milton	130 Meadow Ridge Rd. Mt. Morris PA	304-695-8958		dmitton@shaftdrillers.com
Carl Belt	Avery Costlow	11521 Milnor Ave Cumberland, MD 21502	301-724-8900		awilson@thecbeltgroup.com
Rock Forge Bridge	Nash Thomas	15237 South Preston Highway Kingwood WV 26537	304-695-6829		nash.thomas@mcwv.com
Green River Group LLC	Steve Colvert	714 Venture Dr. #180	304-288-1217		Steve@greenrivergroupllc.com

**One Vendor Per Representative - No one individual is permitted to represent more than one vendor at the pre-bid meeting. Any individual that does attempt to represent two or more vendors will be required to select one vendor to which the individual's attendance will be attributed. The vendors not selected will be deemed to have not attended the pre-bid meeting unless another individual attended on their behalf.*

Pre-Bid Sign-In Sheet

Solicitation Number: ADJ2400000004

Date of Pre-Bid Meeting: August 24th, 2023

Location of Prebid Meeting: Camp Dawson, Kingwood, WV

Please Note:

Vendors must sign-in on this sheet to verify attendance at the Pre-Bid meeting.
 Failure to legibly sign in may be grounds for declaring a vendor ineligible to bid.
 For further verification, please also provide a business card if possible.

<u>Firm Represented:*</u>	<u>Rep Name (Printed):</u>	<u>Firm Address:</u>	<u>Telephone #:</u>	<u>Fax #:</u>	<u>Email:</u>
Anderson Excavating LLC	Calvin Sorenson	343 Williams Rd Morgantown WV	304-365-1281		CSorenson@Anderson Excavating.com

**One Vendor Per Representative - No one individual is permitted to represent more than one vendor at the pre-bid meeting. Any individual that does attempt to represent two or more vendors will be required to select one vendor to which the individual's attendance will be attributed. The vendors not selected will be deemed to have not attended the pre-bid meeting unless another individual attended on their behalf.*

ADDENDUM ACKNOWLEDGEMENT FORM
SOLICITATION NO.: ADJ240000004

Instructions: Please acknowledge receipt of all addenda issued with this solicitation by completing this addendum acknowledgment form. Check the box next to each addendum received and sign below. Failure to acknowledge addenda may result in bid disqualification.

Acknowledgment: I hereby acknowledge receipt of the following addenda and have made the necessary revisions to my proposal, plans and/or specification, etc.

Addendum Numbers Received:

(Check the box next to each addendum received)

- | | |
|--|--|
| <input checked="" type="checkbox"/> Addendum No. 1 | <input type="checkbox"/> Addendum No. 6 |
| <input type="checkbox"/> Addendum No. 2 | <input type="checkbox"/> Addendum No. 7 |
| <input type="checkbox"/> Addendum No. 3 | <input type="checkbox"/> Addendum No. 8 |
| <input type="checkbox"/> Addendum No. 4 | <input type="checkbox"/> Addendum No. 9 |
| <input type="checkbox"/> Addendum No. 5 | <input type="checkbox"/> Addendum No. 10 |

I understand that failure to confirm the receipt of addenda may be cause for rejection of this bid. I further understand that that any verbal representation made or assumed to be made during any oral discussion held between Vendor's representatives and any state personnel is not binding. Only the information issued in writing and added to the specifications by an official addendum is binding.

Anderson Excavating, LLC

Company



Authorized Signature

9/12/23

Date

NOTE: This addendum acknowledgment should be submitted with the bid to expedite document processing.