



The following documentation is an electronically-submitted vendor response to an advertised solicitation from the *West Virginia Purchasing Bulletin* within the Vendor Self-Service portal at *wvOASIS.gov*. As part of the State of West Virginia's procurement process, and to maintain the transparency of the bid-opening process, this documentation submitted online is publicly posted by the West Virginia Purchasing Division at *WVPurchasing.gov* with any other vendor responses to this solicitation submitted to the Purchasing Division in hard copy format.

Header @ 2

List View

- General Information**
- Contact
- Default Values
- Discount
- Document Information
- Clarification Request

Procurement Folder: 1268735

Procurement Type: Central Contract - Fixed Amt

Vendor ID: 000000205574

Legal Name: FAMCO INC

Alias/DBA:

Total Bid: \$657,147.32

Response Date: 09/26/2023

Response Time: 13.02

Responded By User ID: famco2094

First Name: Sara

Last Name: Gutzmer

Email: sara.gutzmer@comcast.net

Phone: 304-529-3328

SO Doc Code: CRFQ

SO Dept: 0506

SO Doc ID: BHS2400000001

Published Date: 9/21/23

Close Date: 9/26/23

Close Time: 13:30

Status: Closed

Solicitation Description: BARBOURSVILLE SCHOOL SEWER PROJECT

Total of Header Attachments: 2

Total of All Attachments: 2



Department of Administration
 Purchasing Division
 2019 Washington Street East
 Post Office Box 50130
 Charleston, WV 25305-0130

**State of West Virginia
 Solicitation Response**

Proc Folder: 1268735
Solicitation Description: BARBOURSVILLE SCHOOL SEWER PROJECT
Proc Type: Central Contract - Fixed Amt

Solicitation Closes	Solicitation Response	Version
2023-09-26 13:30	SR 0506 ESR09262300000001525	1

VENDOR
 000000205574
 FAMCO INC

Solicitation Number: CRFQ 0506 BHS2400000001
Total Bid: 657147.3199999999487772583961 **Response Date:** 2023-09-26 **Response Time:** 13:02:13
Comments:

FOR INFORMATION CONTACT THE BUYER
 Crystal G Husted
 (304) 558-2402
 crystal.g.husted@wv.gov

Vendor Signature X **FEIN#** **DATE**

All offers subject to all terms and conditions contained in this solicitation

Line	Comm Ln Desc	Qty	Unit Issue	Unit Price	Ln Total Or Contract Amount
1	Barboursville School Sewer Project				657147.32

Comm Code	Manufacturer	Specification	Model #
72121505			

Commodity Line Comments:

Extended Description:

Lump Sum total for all labor, material, and equipment to complete Barboursville School Wastewater pump stations and force Main



Department of Administration
 Purchasing Division
 2019 Washington Street East
 Post Office Box 50130
 Charleston, WV 25305-0130

State of West Virginia
 Centralized Request for Quote
 Construction

Proc Folder: 1268735			Reason for Modification: ADDENDUM 3 PROVIDE ANSWERS TO VENDOR QUESTIONS AND PRE-BID SIGN-IN SHEETS
Doc Description: BARBOURSVILLE SCHOOL SEWER PROJECT			
Proc Type: Central Contract - Fixed Amt			
Date Issued	Solicitation Closes	Solicitation No	Version
2023-09-21	2023-09-26 13:30	CRFQ 0506 BHS2400000001	4

BID RECEIVING LOCATION

BID CLERK
 DEPARTMENT OF ADMINISTRATION
 PURCHASING DIVISION
 2019 WASHINGTON ST E
 CHARLESTON WV 25305
 US

VENDOR

Vendor Customer Code: 000000205574

Vendor Name : FAMCO, INC.

Address : P.O. BOX 1577

Street : 3450 16TH STREET ROAD

City : HUNTINGTON

State : WV **Country :** USA **Zip :** 25716

Principal Contact : RICHARD C. SMAILES, CHIEF EXECUTIVE OFFICER

Vendor Contact Phone: 304-529-3328 **Extension:** 2

FOR INFORMATION CONTACT THE BUYER
 Crystal G Hustead
 (304) 558-2402
 crystal.g.hustead@wv.gov

Vendor Signature X  **FEIN#** 55-0662094 **DATE** SEPTEMBER 26, 2023

All offers subject to all terms and conditions contained in this solicitation

ADDITIONAL INFORMATION

THE STATE OF WEST VIRGINIA PURCHASING DIVISION FOR THE AGENCY, WEST VIRGINIA DEPARTMENT OF HEALTH AND HUMAN RESOURCES, IS SOLICITING BIDS TO ESTABLISH A CONTRACT FOR THE BARBOURSVILLE SCHOOL SEWER PROJECT PER THE ATTACHED DOCUMENTS.

QUESTIONS REGARDING THE SOLICITATION MUST BE SUBMITTED IN WRITING TO CRYSTAL.G.HUSTEAD@WV.GOV PRIOR TO THE QUESTION PERIOD DEADLINE CONTAINED IN THE INSTRUCTIONS TO VENDORS SUBMITTING BIDS

INVOICE TO

HEALTH AND HUMAN
RESOURCES
BBH/HF
350 CAPITOL ST, RM 350
CHARLESTON WV
US

SHIP TO

HEALTH AND HUMAN
RESOURCES
BBH/HF
350 CAPITOL ST, RM 350
CHARLESTON WV
US

Line	Comm Ln Desc	Qty	Unit Issue	Unit Price	Total Price
1	Barboursville School Sewer Project	1	LS	\$ 657,147.32	\$ 657,147.32

Comm Code	Manufacturer	Specification	Model #
72121505	GENERAC	25KW	QT025A

Extended Description:

Lump Sum total for all labor, material, and equipment to complete Barboursville School Wastewater pump stations and force Main

SCHEDULE OF EVENTS

<u>Line</u>	<u>Event</u>	<u>Event Date</u>
1	MANDATORY PRE-BID MEETING	2023-09-12
2	VENDOR QUESTION DEADLINE	2023-09-15

**REQUEST FOR QUOTATION
CRFQ BHS240000001
Barbourville School Sewer Project**

EXHIBIT A - Pricing Page

The undersigned, hereafter called the Bidder, being familiar with and understanding the bidding documents; and being familiar with the site and all local conditions affecting the Project, hereby proposes to furnish labor, material, equipment, supplies, and transportation to perform the work as described in the bidding documents

BIDDERS COMPANY NAME: FAMCO, INC.

VENDOR ADDRESS: P.O. BOX 1577
HUNTINGTON, WV 25716

TELEPHONE: 304-529-3328

E-MAIL ADDRESS: dick.smailes@comcast.net

WV CONTRACTOR'S
LICENSE NO. WV000408

CONTRACT OVERALL TOTAL COST:
**SIX HUNDRED FIFTY-SEVEN THOUSAND, ONE HUNDRED FORTY-SEVEN
DOLLARS AND THIRTY-TWO CENTS**

(Written Bid Amount)
(\$ 657,147.32) *** (Contract bid to be written in words and numbers.)

SIGNATURE:  DATE: 09/26/2023

NAME: RICHARD C. SMAILES

(Please Print)

TITLE: CHIEF EXECUTIVE OFFICER

ADDENDUM ACKNOWLEDGEMENT FORM
SOLICITATION NO.: BHS240000001

Instructions: Please acknowledge receipt of all addenda issued with this solicitation by completing this addendum acknowledgment form. Check the box next to each addendum received and sign below. Failure to acknowledge addenda may result in bid disqualification.

Acknowledgment: I hereby acknowledge receipt of the following addenda and have made the necessary revisions to my proposal, plans and/or specification, etc.

Addendum Numbers Received:

(Check the box next to each addendum received)

- | | |
|--|--|
| <input checked="" type="checkbox"/> Addendum No. 1 | <input type="checkbox"/> Addendum No. 6 |
| <input checked="" type="checkbox"/> Addendum No. 2 | <input type="checkbox"/> Addendum No. 7 |
| <input checked="" type="checkbox"/> Addendum No. 3 | <input type="checkbox"/> Addendum No. 8 |
| <input type="checkbox"/> Addendum No. 4 | <input type="checkbox"/> Addendum No. 9 |
| <input type="checkbox"/> Addendum No. 5 | <input type="checkbox"/> Addendum No. 10 |

I understand that failure to confirm the receipt of addenda may be cause for rejection of this bid. I further understand that any verbal representation made or assumed to be made during any oral discussion held between Vendor's representatives and any state personnel is not binding. Only the information issued in writing and added to the specifications by an official addendum is binding.

FAMCO, INC

Company

Authorized Signature

RICHARD C. SMAILES, CHIEF EXECUTIVE OFFICER

SEPTEMBER 26, 2023

Date

NOTE: This addendum acknowledgement should be submitted with the bid to expedite document processing.

Revised 6/8/2012

Agency _____
REQ. P.O.# _____

BID BOND

KNOW ALL MEN BY THESE PRESENTS, That we, the undersigned, FAMCO, Inc.
of 3450 16th Street Road, Huntington, WV 25716, as Principal, and Travelers Casualty and Surety Company
of One Tower Square, Hartford, CT 06183, a corporation organized and existing under the laws of the State of Connecticut
of America with its principal office in the City of Hartford, as Surety, are held and firmly bound unto the State
of West Virginia, as Obligee, in the penal sum of Five Percent of the Amount Bid (\$ 5%) for the payment of which,
well and truly to be made, we jointly and severally bind ourselves, our heirs, administrators, executors, successors and assigns.

The Condition of the above obligation is such that whereas the Principal has submitted to the Purchasing Section of the
Department of Administration a certain bid or proposal, attached hereto and made a part hereof, to enter into a contract in writing for
Barboursville School Wastewater Pump Stations and Force Main, #CRFQ 0506 BHS240000001

NOW THEREFORE,

(a) If said bid shall be rejected, or
(b) If said bid shall be accepted and the Principal shall enter into a contract in accordance with the bid or proposal attached
hereto and shall furnish any other bonds and insurance required by the bid or proposal, and shall in all other respects perform the
agreement created by the acceptance of said bid, then this obligation shall be null and void, otherwise this obligation shall remain in full
force and effect. It is expressly understood and agreed that the liability of the Surety for any and all claims hereunder shall, in no event,
exceed the penal amount of this obligation as herein stated.

The Surety, for the value received, hereby stipulates and agrees that the obligations of said Surety and its bond shall be in no
way impaired or affected by any extension of the time within which the Obligee may accept such bid, and said Surety does hereby
waive notice of any such extension.

IN WITNESS WHEREOF, Principal and Surety have hereunto set their hands and seals, and such of them as are corporations
have caused their corporate seals to be affixed hereunto and these presents to be signed by their proper officers, this
26th day of September, 2023.

Principal Corporate Seal

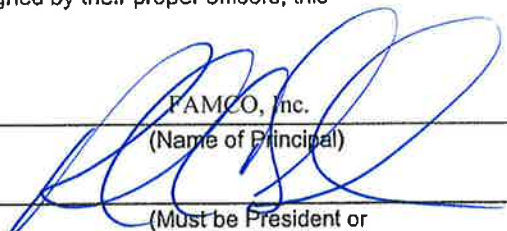
FAMCO, Inc.
(Name of Principal)
By 
(Must be President or
Vice President)
RICHARD C. SMAILES
CHIEF EXECUTIVE OFFICER
(Title)

Surety Corporate Seal

Travelers Casualty and Surety Company of America
(Name of Surety)

William A. Kantlehner, III Attorney-in-Fact

IMPORTANT – Surety executing bonds must be licensed in West Virginia to transact surety insurance. Raised corporate seals must be affixed, a power of attorney must be attached.



**Travelers Casualty and Surety Company of America
Travelers Casualty and Surety Company
St. Paul Fire and Marine Insurance Company**

POWER OF ATTORNEY

KNOW ALL MEN BY THESE PRESENTS: That Travelers Casualty and Surety Company of America, Travelers Casualty and Surety Company, and St. Paul Fire and Marine Insurance Company are corporations duly organized under the laws of the State of Connecticut (herein collectively called the "Companies"), and that the Companies do hereby make, constitute and appoint **Andrea Cortes, Elizabeth Dawson, William A. Kantlehner III, William A. Kantlehner IV, Ryan P. Mitchell, Thomas J. Mitchell, S. Annette Mullet, Christopher E. von Allmen, Andrew O. Mucci, Kevin H. Bowling, Adam Terry, and Andrew G. Windhorst Jr. of Louisville, Kentucky** their true and lawful Attorney (s)-in-Fact to sign, execute, seal and acknowledge any and all bonds, recognizances, conditional undertakings and other writings obligatory in the nature thereof on behalf of the Companies, business of guaranteeing the fidelity of persons, guaranteeing the performance of contracts and executing or guaranteeing bonds and undertakings required or permitted in any actions or proceedings allowed by law.

IN WITNESS WHEREOF, the Companies have caused this instrument to be signed, and their corporate seals to be hereto affixed, this **21st** day of **April, 2021**.



State of Connecticut

City of Hartford ss.

By: 
Robert L. Raney, Senior Vice President

On this the **21st** day of **April, 2021**, before me personally appeared **Robert L. Raney**, who acknowledged himself to be the Senior Vice President of each of the Companies, and that he, as such, being authorized so to do, executed the foregoing instrument for the purposes therein contained by signing on behalf of said Companies by himself as a duly authorized officer.

IN WITNESS WHEREOF, I hereunto set my hand and official seal.

My Commission expires the **30th** day of **June, 2026**

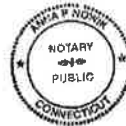

Anna P. Nowik, Notary Public

This Power of Attorney is granted under and by the authority of the following resolutions adopted by the Boards of Directors of each of the Companies, which resolutions are now in full force and effect, reading as follows:

RESOLVED, that the Chairman, the President, any Vice Chairman, any Executive Vice President, any Senior Vice President, any Vice President, any Second Vice President, the Treasurer, any Assistant Treasurer, the Corporate Secretary or any Assistant Secretary may appoint Attorneys-in-Fact and Agents to act for and on behalf of the Company and may give such appointee such authority as his or her certificate of authority may prescribe to sign with the Company's name and seal with the Company's seal bonds, recognizances, contracts of indemnity, and other writings obligatory in the nature of a bond, recognizance, or conditional undertaking, and any of said officers or the Board of Directors at any time may remove any such appointee and revoke the power given him or her; and it is

FURTHER RESOLVED, that the Chairman, the President, any Vice Chairman, any Executive Vice President, any Senior Vice President or any Vice President may delegate all or any part of the foregoing authority to one or more officers or employees of this Company, provided that each such delegation is in writing and a copy thereof is filed in the office of the Secretary; and it is

FURTHER RESOLVED, that any bond, recognizance, contract of indemnity, or writing obligatory in the nature of a bond, recognizance, or conditional undertaking shall be valid and binding upon the Company when (a) signed by the President, any Vice Chairman, any Executive Vice President, any Senior Vice President or any Vice President, any Second Vice President, the Treasurer, any Assistant Treasurer, the Corporate Secretary or any Assistant Secretary and duly attested and sealed with the Company's seal by a Secretary or Assistant Secretary; or (b) duly executed (under seal, if required) by one or more Attorneys-in-Fact and Agents pursuant to the power prescribed in his or her certificate or their certificates of authority or by one or more Company officers pursuant to a written delegation of authority; and it is

FURTHER RESOLVED, that the signature of each of the following officers: President, any Executive Vice President, any Senior Vice President, any Vice President, any Assistant Vice President, any Secretary, any Assistant Secretary, and the seal of the Company may be affixed by facsimile to any Power of Attorney or to any certificate relating thereto appointing Resident Vice Presidents, Resident Assistant Secretaries or Attorneys-in-Fact for purposes only of executing and attesting bonds and undertakings and other writings obligatory in the nature thereof, and any such Power of Attorney or certificate bearing such facsimile signature or facsimile seal shall be valid and binding upon the Company and any such power so executed and certified by such facsimile signature and facsimile seal shall be valid and binding on the Company in the future with respect to any bond or understanding to which it is attached.

I, **Kevin E. Hughes**, the undersigned, Assistant Secretary of each of the Companies, do hereby certify that the above and foregoing is a true and correct copy of the Power of Attorney executed by said Companies, which remains in full force and effect.

Dated this 26th day of September, 2023



Kevin E. Hughes, Assistant Secretary

**To verify the authenticity of this Power of Attorney, please call us at 1-800-421-3880.
Please refer to the above-named Attorney(s)-in-Fact and the details of the bond to which this Power of Attorney is attached.**



**State of West Virginia
DRUG FREE WORKPLACE CONFORMANCE AFFIDAVIT
West Virginia Code §21-1D-5**

I, RICHARD C. SMAILES, after being first duly sworn, depose and state as follows:

1. I am an employee of FAMCO, INC.; and,
(Company Name)
2. I do hereby attest that FAMCO, INC.
(Company Name)

maintains a written plan for a drug-free workplace policy and that such plan and policy are in compliance with **West Virginia Code** §21-1D.

The above statements are sworn to under the penalty of perjury.

Printed Name: RICHARD C. SMAILES

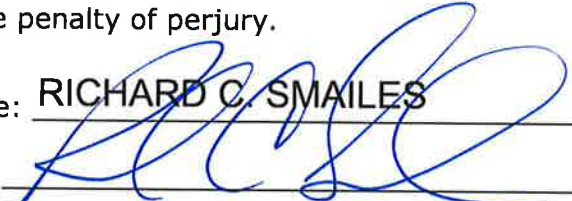
Signature: 

Title: CHIEF EXECUTIVE OFFICER

Company Name: FAMCO, INC.

Date: SEPTEMBER 26, 2023

STATE OF WEST VIRGINIA,

COUNTY OF CABELL, TO-WIT:

Taken, subscribed and sworn to before me this 26 day of SEPTEMBER, 2023.

By Commission expires MAY 04, 2026

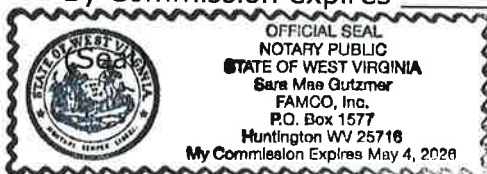

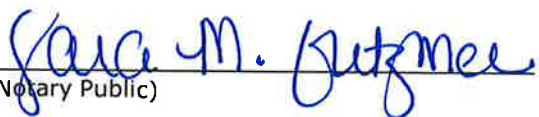
(Notary Public)



CONTRACTOR LICENSE

AUTHORIZED BY THE
West Virginia Contractor
Licensing Board

NUMBER: WV000408

CLASSIFICATION:
GENERAL ENGINEERING

FAMCO INC
DBA .FAMCO INC
PO BOX 1577
HUNTINGTON, WV 25716

DATE ISSUED

EXPIRATION DATE

AUGUST 05, 2023

AUGUST 05, 2024

Authorized Signature

Chair, West Virginia Contractor
Licensing Board



WEST VIRGINIA
CONTRACTOR
LICENSING BOARD

A copy of this license must be readily available for inspection by the Board on every job site where contracting work is being performed. This license number must appear in all advertisements, on all bid submissions, and on all fully executed and binding contracts. This license is non-transferable. This license is being issued under the provisions of West Virginia Code, Chapter 30, Article 42.

DESIGNATED CONTACT: Vendor appoints the individual identified in this Section as the Contract Administrator and the initial point of contact for matters relating to this Contract.

(Printed Name and Title) RICHARD C. SMAILES, CHIEF EXECUTIVE OFFICER

(Address) P.O. BOX 1577, HUNTINGTON, WV 25716

(Phone Number) / (Fax Number) 304-529-3328 / 304-529-3325

(Email address) dick.smailes@comcast.net

CERTIFICATION AND SIGNATURE: By signing below, or submitting documentation through wvOASIS, I certify that: I have reviewed this Solicitation/Contract in its entirety; that I understand the requirements, terms and conditions, and other information contained herein; that this bid, offer or proposal constitutes an offer to the State that cannot be unilaterally withdrawn; that the product or service proposed meets the mandatory requirements contained in the Solicitation/Contract for that product or service, unless otherwise stated herein; that the Vendor accepts the terms and conditions contained in the Solicitation, unless otherwise stated herein; that I am submitting this bid, offer or proposal for review and consideration; that this bid or offer was made without prior understanding, agreement, or connection with any entity submitting a bid or offer for the same material, supplies, equipment or services; that this bid or offer is in all respects fair and without collusion or fraud; that this Contract is accepted or entered into without any prior understanding, agreement, or connection to any other entity that could be considered a violation of law; that I am authorized by the Vendor to execute and submit this bid, offer, or proposal, or any documents related thereto on Vendor's behalf; that I am authorized to bind the vendor in a contractual relationship; and that to the best of my knowledge, the vendor has properly registered with any State agency that may require registration.

By signing below, I further certify that I understand this Contract is subject to the provisions of West Virginia Code § 5A-3-62, which automatically voids certain contract clauses that violate State law; and that pursuant to W. Va. Code 5A-3-63, the entity entering into this contract is prohibited from engaging in a boycott against Israel.

FAMCO, INC.

(Company)

(Signature of Authorized Representative)

RICHARD C. SMAILES, CHIEF EXECUTIVE OFFICER

(Printed Name and Title of Authorized Representative) (Date)

304-529-3328 304-529-3325

(Phone Number) (Fax Number)

dick.smailes@comcast.net

(Email Address)

ADDENDUM ACKNOWLEDGEMENT FORM
SOLICITATION NO.: CRFQ BHS240000001

Instructions: Please acknowledge receipt of all addenda issued with this solicitation by completing this addendum acknowledgment form. Check the box next to each addendum received and sign below. Failure to acknowledge addenda may result in bid disqualification.

Acknowledgment: I hereby acknowledge receipt of the following addenda and have made the necessary revisions to my proposal, plans and/or specification, etc.

Addendum Numbers Received:
(Check the box next to each addendum received)

- | | |
|--|--|
| <input checked="" type="checkbox"/> Addendum No. 1 | <input type="checkbox"/> Addendum No. 6 |
| <input checked="" type="checkbox"/> Addendum No. 2 | <input type="checkbox"/> Addendum No. 7 |
| <input checked="" type="checkbox"/> Addendum No. 3 | <input type="checkbox"/> Addendum No. 8 |
| <input type="checkbox"/> Addendum No. 4 | <input type="checkbox"/> Addendum No. 9 |
| <input type="checkbox"/> Addendum No. 5 | <input type="checkbox"/> Addendum No. 10 |

I understand that failure to confirm the receipt of addenda may be cause for rejection of this bid. I further understand that any verbal representation made or assumed to be made during any oral discussion held between Vendor's representatives and any state personnel is not binding. Only the information issued in writing and added to the specifications by an official addendum is binding.

FAMCO, INC
Company

Authorized Signature

RICHARD C. SMAILES
CHIEF EXECUTIVE OFFICER

SEPTEMBER 26, 2023

Date

NOTE: This addendum acknowledgement should be submitted with the bid to expedite document processing.

**REQUEST FOR QUOTATION
CRFQ BHS240000001
Barboursville School Sewer Project**

11.4. Anyone performing under this Contract will be subject to Agency's security protocol and procedures.

11.5. Vendor shall inform all staff of Agency's security protocol and procedures.

12. MISCELLANEOUS:

12.1. Contract Manager: During its performance of this Contract, Vendor must designate and maintain a primary contract manager responsible for overseeing Vendor's responsibilities under this Contract. The Contract manager must be available during normal business hours to address any customer service or other issues related to this Contract. Vendor should list its Contract manager and his or her contact information below.

Contract Manager: RICHARD C. SMAILES

Telephone Number: 304-529-3328

Fax Number: 304-529-3325

Email Address: dick.smailes@comcast.net

FAMCO, INC.
GENERAL CONTRACTORS
3450 16TH ST. ROAD P.O. BOX 1577
(304) 529-3328 FAX NO. 529-3325
HUNTINGTON, WEST VIRGINIA 25716



CORPORATE AUTHORIZATION RESOLUTION
OF FAMCO, INC.

1. A meeting of the Board of Directors of Famco, Inc., P.O. Box 1577, Huntington, West Virginia 25716, was held on the 19th day of May, 2023, at 3:30 P.M. at the Famco, Inc. corporate office located at 3450 16th Street Road, Huntington, West Virginia 25701.

2. I, Robert M. Lafon II, certify that I am President and Secretary of Famco, Inc. organized under the laws of the State of West Virginia on the 26th day of March, 1986, Federal Employer Identification number 55-0662094, engaged in business under the trade name of Famco, Inc., and that the following resolutions are hereby adopted:

a. Be it resolved that:

i. Robert M. Lafon II is President of Famco, Inc.

ii. Robert M. Lafon II shall have unlimited power to enter into contracts, borrow funds, and pledge the assets of the corporation.

3. I further certify that the Board of Directors of this corporation has full power and lawful authority to adopt the foregoing resolutions and to confer the powers granted to the persons named who have full power and lawful authority to exercise the same.

IN WITNESS WHEREOF, the undersigned hereunto subscribed their names and affixed the seal of this corporation on the 19th day of May, 2023.



Robert M. Lafon II,
President & Secretary



Richard C. Smailes,
Chief Executive Officer

SEAL

QT025A

Industrial Gaseous Generator Set

EPA Certified Stationary Emergency

Standby Power Rating
31kVA 25kW 60Hz

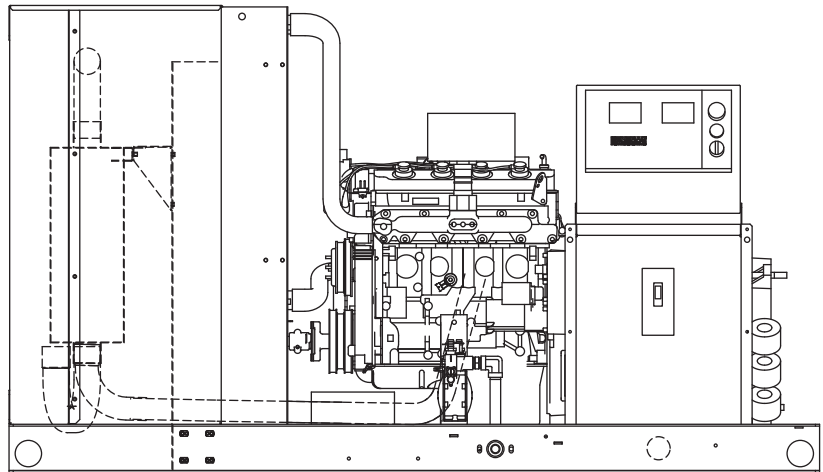

Generator image used for illustration purposes only

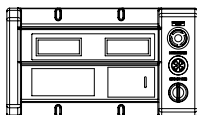
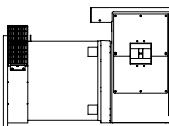
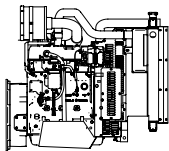
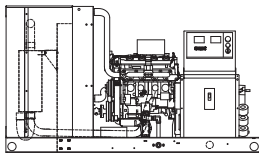

features

Generator Set

- PROTOTYPE & TORSIONALLY TESTED
- UL2200 TESTED
- RHINOCOAT PAINT SYSTEM

Engine

- EPA COMPLIANT
- INDUSTRIAL TESTED, GENERAC APPROVED
- POWER-MATCHED OUTPUT
- INDUSTRIAL GRADE

Alternator

- TWO-THIRDS PITCH
- LAYER WOUND ROTOR & STATOR
- CLASS H MATERIALS
- DIGITAL 3-PHASE VOLTAGE CONTROL

Controls

- ENCAPSULATED BOARD W/ SEALED HARNESS
- 4-20mA VOLTAGE-TO-CURRENT SENSORS
- SURFACE-MOUNT TECHNOLOGY
- ADVANCED DIAGNOSTICS & COMMUNICATIONS

benefits

- ▶ PROVIDES A PROVEN UNIT
- ▶ ENSURES A QUALITY PRODUCT
- ▶ IMPROVES RESISTANCE TO ELEMENTS

- ▶ ENVIRONMENTALLY FRIENDLY
- ▶ ENSURES INDUSTRIAL STANDARDS
- ▶ ENGINEERED FOR PERFORMANCE
- ▶ IMPROVES LONGEVITY AND RELIABILITY

- ▶ ELIMINATES HARMFUL 3RD HARMONIC
- ▶ IMPROVES COOLING
- ▶ HEAT TOLERANT DESIGN
- ▶ FAST AND ACCURATE RESPONSE

- ▶ EASY, AFFORDABLE REPLACEMENT
- ▶ NOISE RESISTANT 24/7 MONITORING
- ▶ PROVIDES VIBRATION RESISTANCE
- ▶ HARDENED RELIABILITY

primary codes and standards



QT025A

application and engineering data

ENGINE SPECIFICATIONS

General

Make	Generac
EPA Emissions Compliance	Stationary Emergency
EPA Emissions Engine Reference	See Emissions Data Sheet
Cylinder #	4
Type	In-line
Displacement - L	2.4
Bore - mm (in.)	86.61 (3.41)
Stroke - mm (in.)	100.08 (3.94)
Compression Ratio	9.5:1
Intake Air Method	Naturally Aspirated
Number of Main Bearings	5
Connecting Rods	Forged
Cylinder Head	Aluminum
Cylinder Liners	No
Ignition	High Energy
Pistons	Aluminum Alloy
Crankshaft	Cast
Lifter Type	Overhead Cam
Intake Valve Material	Steel Alloy
Exhaust Valve Material	Hardened Steel
Hardened Valve Seats	Yes

Lubrication System

Oil Pump Type	Gear
Oil Filter Type	Full-flow spin-on cartridge
Crankcase Capacity - L (qts)	3.8 (4)

Cooling System

Cooling System Type	Pressurized Closed
Water Pump Flow	11 gal/min
Fan Type	Pusher
Fan Speed (rpm)	2150
Fan Diameter mm (in.)	457 (18)
Coolant Heater Wattage	1500
Coolant Heater Standard Voltage	120VAC

Fuel System

Fuel Type	Natural Gas, Propane Vapor
Carburetor	Down Draft
Secondary Fuel Regulator	Standard
Fuel Shut Off Solenoid	Standard
Operating Fuel Pressure	5" - 14" H2O*

*Fuel pressure must remain within specified range and not drop more than 1 in. w.c. from static (no-load) to full load.

Engine Electrical System

System Voltage	12VDC
Battery Charging Alternator (Amps)	30
Battery Size (at 0°C)	525CCA
Battery Group	26
Battery Voltage	12VDC
Ground Polarity	Negative

ALTERNATOR SPECIFICATIONS

Standard Model	390mm
Poles	4
Field Type	Revolving
Insulation Class - Rotor	H
Insulation Class - Stator	H
Total Harmonic Distortion	<5%
Telephone Interference Factor (TIF)	<50
Standard Excitation	Brush Type
Bearings	Sealed Ball
Coupling	Flexible Disc
Load Capacity - Standby	100%
Prototype Short Circuit Test	Yes

Voltage Regulator Type	Full Digital
Number of Sensed Phases	3
Regulation Accuracy (Steady State)	+/- 0.25%

Engine Governing

Governor	Electronic
Frequency Regulation (Steady State)	+/- 0.25%

CODES AND STANDARDS COMPLIANCE (WHERE APPLICABLE)

NFPA 99	BS5514
NFPA 110	SAE J1349
ISO 8528-5	DIN6271
ISO 1708A.5	IEEE C62.41 TESTING
ISO 3046	NEMA ICS 1
	UL2200

Rating Definitions:

Standby – Applicable for a varying emergency load for the duration of a utility power outage with no overload capability. (Max. load factor = 70%)

QT025A

operating data (60Hz)

POWER RATINGS (kW)

	Natural Gas		Propane Vapor	
	kW	Amps	kW	Amps
Single-Phase 120/240VAC @1.0pf	25	104	25	104
Three-Phase 120/208VAC @0.8pf	25	87	25	87
Three-Phase 120/240VAC @0.8pf	25	75	25	75
Three-Phase 277/480VAC @0.8pf	25	38	25	38

STARTING CAPABILITIES (sKVA)

		sKVA vs. Voltage Dip											
		480VAC						208/240VAC					
Alternator	kW	10%	15%	20%	25%	30%	35%	10%	15%	20%	25%	30%	35%
Standard	25	16	25	33	41	49	57	12	19	25	31	37	43

FUEL

Fuel Consumption Rates*

Natural Gas			Propane Vapor		
Percent Load	ft ³ /hr	m ³ /hr	Percent Load	ft ³ /hr	m ³ /hr
25%	140	3.9	25%	56	1.6
50%	220	6.2	50%	87	2.5
75%	300	8.5	75%	119	3.4
100%	380	10.8	100%	151	4.3

* Refer to "Emissions Data Sheet" for maximum fuel flow for EPA and SCAQMD permitting purposes.

COOLING

		STANDBY
Air Flow (inlet air combustion and radiator)	ft ³ /min (m ³ /min)	1500 (42.48)
System Coolant Capacity	Gal (Liters)	2.5 (9.46)
Heat Rejection to Coolant	BTU/hr	95,000
Max. Operating Air Temp on Radiator	°F (°C)	122 (50)
Max. Ambient Temperature	°F (°C)	104 (40)
Maximum Radiator Backpressure	in H ₂ O	1.5

COMBUSTION AIR REQUIREMENTS

		STANDBY
Flow at Rated Power	cfm	70

ENGINE

		STANDBY
Rated Engine Speed	rpm	1800
Horsepower at Rated kW**	hp	40
Piston Speed	ft/min	1182
BMEP	psi	120

** Refer to "Emissions Data Sheet" for maximum bHP for EPA and SCAQMD permitting purposes.

EXHAUST

		STANDBY
Exhaust Flow (Rated Output)	cfm (m ³ /min)	220 (6.2)
Maximum Recommended Back Pressure	inHg	1.5
Exhaust Temp (Rated Output)	°F (°C)	975 (524)
Exhaust Outlet Size	in	2.5

QT025A

standard features and options

GENERATOR SET

- Genset Vibration Isolation Std
- Extended warranty Opt
- Gen-Link™ Communications Software Opt
- Steel Enclosure Opt
- Aluminum Enclosure Opt

ENGINE SYSTEM

General

- Oil Drain Extension Std
- Critical Exhaust Silencer Std
- Air cleaner Std
- Fan guard Std
- Radiator duct adapter Std

Fuel System

- Fuel lockoff solenoid Std
- Secondary Fuel Regulator Std
- Flexible fuel lines Std

Cooling System

- 120VAC Coolant Heater Std
- Closed Coolant Recovery System Std
- UV/Ozone resistant hoses Std
- Factory-Installed Radiator Std
- Radiator Drain Extension Std

Engine Electrical System

- Battery charging alternator Std
- Battery cables Std
- Battery tray Std
- Solenoid activated starter motor Std
- 10A UL float/equalize battery charger Std
- Rubber-booted engine electrical connections Std

ALTERNATOR SYSTEM

- UL2200 GENprotect™ Std
- Main Line Circuit Breaker Std

CONTROL SYSTEM

Control Panel

- Digital H Control Panel - Dual 4x20 Display Std
- Programmable Crank Limiter Std
- 21-Light Remote Annunciator Opt
- Remote Relay Panel (8 or 16) Opt
- 7-Day Programmable Exerciser Std
- Special Applications Programmable PLC Std
- RS-232 Communications Std
- RS-485 Communications Std
- All-Phase Sensing DVR Std
- Full System Status Std
- Utility Monitoring (Req. H-Transfer Switch) Std
- 2-Wire Start Compatible Std
- Power Output (kW) Std
- Power Factor Std
- Reactive Power Std
- All phase AC Voltage Std
- All phase Currents Std
- Oil Pressure Std
- Coolant Temperature Std
- Coolant Level Std
- Fuel Pressure Std
- Engine Speed Std
- Battery Voltage Std
- Frequency Std
- Isochronous Governor Control Std
- -40deg C - 70deg C Operation Std
- Waterproof Plug-In Connectors Std
- Audible Alarms and Shutdowns Std
- Not in Auto (Flashing Light) Std
- Auto/Off/Manual Switch Std
- E-Stop (Red Mushroom-Type) Std
- NFPA 110 Level I and II (Programmable) Std
- Remote Communication - RS232 Std

Alarms (Programmable Tolerances, Pre-Alarms and Shutdowns)

- Low Fuel Pressure Std
- Oil Pressure (Pre-programmed Low Pressure Shutdown) Std
- Coolant Temperature (Pre-programmed High Temp Shutdown) Std
- Coolant Level (Pre-programmed Low Level Shutdown) Std
- Engine Speed (Pre-programmed Overspeed Shutdown) Std
- Voltage (Pre-programmed Overvoltage Shutdown) Std
- Battery Voltage Std

QT025A

dimensions, weights and sound levels

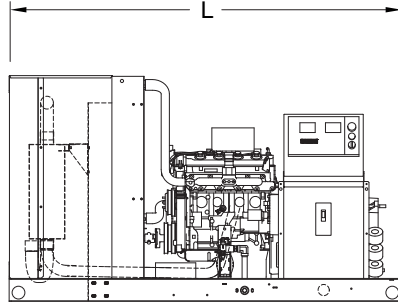
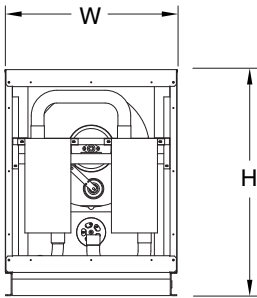

OPEN SET

L	W	H	WT	dBA*
77	34	43	1163	83

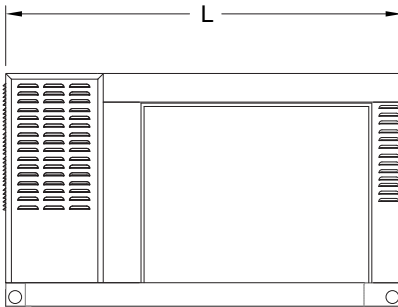
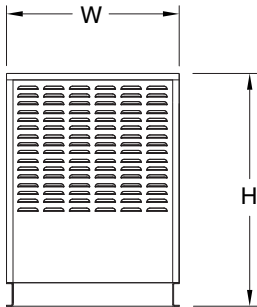

LEVEL 1 ACOUSTIC ENCLOSURE

L	W	H	WT	dBA*
77	34	46	1414	60

*All measurements are approximate and *All measurements are approximate and for estimation purposes only. Sound levels measured at 23ft (7m) under normal operation and do not account for ambient site conditions. estimation purposes only. Sound levels measured at 23ft (7m) and does not account for ambient site conditions.

YOUR FACTORY RECOGNIZED GENERAC INDUSTRIAL DEALER

Specification characteristics may change without notice. Dimensions and weights are for preliminary purposes only. Please consult a Generac Power Systems Industrial Dealer for detailed installation drawings.