



(800) 218-9462 www.gtmidatlantic.com

COVER SHEET

BID SUBMISSION
CRFQ 0803 DOT2300000135

June 22, 2023

Vendor Name: Groff Tractor Mid Atlantic, LLC
Buyer: John Estep
Solicitation: CRFQ 0803 DOT2300000135
Bid Opening Date: June 22, 2023
Bid Opening Time: 1:30 PM
FAX Number: 304-558-3970

Groff Tractor Mid Atlantic, LLC CASE 580SV+ bid submission

06/22/23 10:23:41
GW Purchasing Division

Delaware
Greenwood



Maryland
Aberdeen
Baltimore
Frederick
Upper Marlboro

New Jersey
Freehold
Totowa
Vineland

Pennsylvania
Folcroft

06-22-23 09:42 FROM-

VENDOR:Groff Tractor Mid Atlantic, LLC Class 352 Loader w/Backhoe

Item No.	Description:	Model & Part Number Being Bid	Estimated Unit Quantity	Unit Price	Item Total Cost
1	Four Wheel Drive John Deere 320 P-Tier Loader with backhoe or equal.	Four Wheel Drive CASE 580SV+ Loader with Backhoe	20	\$119,000.00	\$2,380,000.00
Total Bid Cost					\$2,380,000.00
Bid Will Be Awarded To The Lowest Overall Bid Total For All Items					
Vendor Information					
Company Name: Groff Tractor Mid Atlantic, LLC					
Contact Manager: Karen Gibison					
Address: 8404 Kelso Drive Essex MD 21221					
Phone: 908-910-1899					
Fax: 856-697-4842					
E-mail: karengibison@gtmidatlantic.com					
Signature: 					

Received: 8566973933

Jun 22 2023 10:05am
T-123 P0002/0060 F-870 P002



Equipment - Parts - Service - Rentals
www.grofftractor.com

State of West Virginia

Mr John Estep

June 21 2023

2019 Washington Street East

Charleston, WV 25305

Dear Mr. Estep,

Groff Tractor Mid Atlantic appreciates the opportunity to present the State of West Virginia an equivalent /equal Loader Backhoe option in the CASE 580SV+ 4WD Loader Backhoe. The CASE 580SV+ 4WD Loader Backhoe meets or exceeds the general requirements of your bid specifications. I have attached the CASE 580SV+ Specification sheet for your review. I would like to highlight some of the options that have been included:

- Standard Dipper Stick
- Transmission is PowerDrive H-Type
- Pilot Control
- 1 way/ 2 way Aux. Hydraulics
- Bid required instruments and gauges including Transmission Temp and Volt Amp gauge
- Bid required lighting including (2) LED side cab roof; boom mounted LED working lights
- Loader bucket width : 94" 1.4 C.Y.
- Backhoe digging depth 15ft with 24" Bucket
- Cab includes 2 Doors, Heat, A/C , Bluetooth am/fm radio, LH/RH ext. Rearview Mirrors
- Lockable engine service door keyed the same as Cab, Hyd Tank and Fuel Tank
- One Complete set of additional filters
- Radial front and rear tires
- 580SV+ Loader w/ Straight Line Arms is self-leveling w/ 11ft 11in raised bucket pin height
- Bid required Boom Guard
- Two 850 CCA batteries
- Hand Held Tool port w/ hydraulic quick couplings for tools
- 12 Printed service/shop maintenance manuals and 14 USB storage drive Parts Manuals
- 3Yr/5000Hr Premier Warranty

If you should have any questions or need clarity on any item, please do not hesitate to contact me @ Groff Tractor Mid Atlantic directly 240-446-1391. Thank you for your consideration.

Sincerely,

A handwritten signature in black ink that reads 'Donovan Bolland'.

Donavan Bolland

Territory Sales Manager

CASE

CONSTRUCTION KING TOOL CARRIER

580SV+

CONSTRUCTION KING TOOL CARRIER BACKHOE LOADER
TIER 4 FINAL CERTIFIED



ENGINE

Model	FPT F5BFL413B*B
Emissions Certification	Tier 4 Final
Type	Diesel 4-stroke, Turbocharged
Cylinders	4
Bore/Stroke	3.90 x 4.33 in (99 x 110 mm)
Displacement	207 in ³ (3.4 L)
Fuel injection	Direct, high pressure common rail – HPCR
Fuel	Diesel
Engine speeds*	RPM
Rated speed – full load	2200
Low idle	900 – 1000
High idle – no load	2330 – 2430
Horsepower @ 2200 RPM:	
Gross	110 hp (82 kW)
Net	108 hp (81 kW)
Maximum torque @ 1400 RPM:	
Gross	339 lb-ft (460 N-m)
Net	338 lb-ft (459 N-m)
Torque rise at rated speed	29% +/- 5%
Radiator:	
Core type	Square wave
Core size area	486 in ² (3 145 cm ²)
Rows of tubes	4
39° fan:	
Style	9 blade suction
Diameter	19.65 in (499 mm)
Ratio**	1.4:1
Pump operating angle ratings:	
Side to side	Rated 35°
Fore and aft	Rated 35°
Oil filtration	Replaceable, full flow cartridge

NOTE: *Engine speeds w/ standard transmission.
Meets federal emission regulations.
**Viscous fan.

DRIVETRAIN

Transmission – standard:
4F-4R Power Shuttle Synchronesh Transmission
manual gear shift, fully synchronized

Specifications below apply to the Power Shuttle
transmission.

Gear ratios	Forward/Reverse
1st	5.603/4.643
2nd	3.481/2.884
3rd	1.684/1.313
4th	0.793/0.657

Travel speeds – Standard Power Shuttle

Transmission	Forward	Reverse
	mph (kph)	mph (kph)
1st	3.4 (5.5)	4.1 (6.6)
2nd	5.5 (8.9)	6.6 (10.7)
3rd	11.8 (19)	14.2 (22.8)
4th	22.5 (36.2)	27 (43.4)

Transmission – optional:
Powershift H-Type, 4F-3R hydraulic clutch
shifting w/ auto shift mode

Gear ratios	Forward/Reverse
1st	5.533/4.549
2nd	3.359/2.762
3rd	1.533/1.260
4th	0.811/--

Travel speeds – Optional H-Type Powershift

Transmission:	Forward	Reverse
	mph (kph)	mph (kph)
1st	3.5 (5.6)	4.2 (6.7)
2nd	5.7 (9.1)	6.8 (10.9)
3rd	12.1 (19.4)	14.5 (23.3)
4th	22.1 (35.5)	—

Torque converter ratio 2.38

Differential-lock:
On-the-go push-button activation

Front/Rear axle:	
Differential ratio	2.29/2.75
Planetary hub ratio	6.0/6.4
Total reduction ratio	13.7/17.6

Service brakes:
Individually applied, power assisted,
hydraulically actuated, maintenance-free,
self-adjusting, outboard mounted, wet disc,
2 per side.
Total disc area 384 in² (0.25 m²)

Parking brakes Trans Mounted
spring-applied hydraulic release – SAHR

NOTE: Travel speeds w/ 19.5 L x 24.0 tires.

ELECTRICAL

Voltage	12 Volts, negative ground
Alternator	160 amp
Single Battery	900 amp
Power plugs – 1	20 amp

OPERATOR ENVIRONMENT

ROPS/FOPS certified protective cab; 2 door w/
heat, A/C, defroster, floor mat, Bluetooth radio,
front and rear wiper; Interior rearview convex
mirror; Mechanical suspension deluxe seat; 2 in
(50 mm) retractable seat belt; Cup holder and
storage trays positioned on the right side; and
enclosed storage compartment on left side.

Gauges:

Engine water temperature; Converter oil
temperature; Fuel level; Tachometer/
hourmeter; DEF level.

Warning lights:

Air cleaner restriction; Alternator; A/C high
pressure; Cold start; Engine oil pressure;
Hydraulic oil filter bypass; Parking brake
engagement; Low fuel; Water In fuel; Low DEF.

Audible alarms w/ diagnostics:

Coolant temperature; Engine oil pressure;
Parking brake engagement; Converter oil
temperature; Shuttle engagement/seat
position; Backup alarm; Low DEF.

Horn Dual switched front and rear

OPERATING WEIGHT

Configuration 1:

Cab, HVAC, 14' standard backhoe, standard
loader bucket with cutting edge, large
counterweight, 24" HD backhoe bucket, Front
Wheels 14 x 17.5 Rear Wheels 21L x 24, ride
control and operator.
18,695 lb (8 480 kg)

Configuration 2:

Cab, HVAC, 15' Extendahoe backhoe, standard
loader bucket with cutting edge, medium
counterweight, 24" HD backhoe bucket, Front
Wheels 14 x 17.5, Rear Wheels 21L x 24, ride
control and operator.
19,709 lb (8 940 kg)

HYDRAULICS**Pump:**

Sauer Danfoss Variable Displacement Axial
Piston Pump
Flow Ratings 43.6 gpm @ 2,973 psi
(165 L/min @ 205 bar)

Main relief pressure:

2,973 +/- 44 psi (205 +/- 3 bar)

Filtration:

7-micron, full flow replaceable cartridge on
return line, condition indicator light for filter.

Oil cooler

Heavy-duty

Loader control valve:

Two or three spool sectional valve. The two
spool valve has single lever control for lift and
tilt. The three spool valve has a pilot controlled
clam valve. The lift lever has positive hold "float"
position and "return to dig" feature. Valve is
post compensated with flow sharing. Valve
allows simultaneous operation of loader lift and
loader bucket.

Backhoe flow @ 2200 RPM:

Maximum backhoe flow for 1-way hydraulics:
35.9 gpm @ 2,973 psi
(136 L/min @ 205 bar)

Pilot backhoe control valve:

Six, seven, or eight spool sectional closed
center control valve. Basic control valve is
closed center, w/ circuits in parallel w/ a post-
compensated, flow sharing feature for
simultaneous operation of all circuits.

1-way flow auxiliary hydraulics:

1-way flow hydraulic valve is equipped with a
variable flow feature adjustable at the valve.

Actuation:

Pilot controls – left-hand joystick/pedal.

2-way flow auxiliary hydraulics:

2-way flow hydraulic valve is equipped with a
variable flow feature adjustable at the valve

Actuation:

Left-hand joystick.

Combo auxiliary hydraulics:

Incorporates both a 1-way flow control valve
and a 2-way control valve, using only 2 hydraulic
lines through the boom.

Actuation:

Activate the 2-way flow switch located on
the rear console
Pilot controls – left-hand joystick

Standard front axle:

4WD Differential 1.7 gal (6.5 L)

Rear axle:

Differential and planetaries 5.6 gal (21.2 L)

Engine oil w/ filter

8.5 qt (8.0 L)

OTHER SPECIFICATIONS**Front tires:**

14 L x 17.5, 10-ply rating
12.0 L x 16.5, 10-ply rating
12.5/80 x 18.0 10-ply rating

Rear tires:

19.5 L x 24.0, 10-ply rating
16.9 L x 28.0, 10-ply rating
21 L x 24.0, 10-ply rating

Turning radius: Curb to Curb:**4WD – disengaged*:**

Turning Right 14 ft 7 in (4.44 m)
Turning Left 15 ft 5 in (4.70 m)

NOTE: *Turning radius dimensions curb to curb
w/ 12.5/80 x 18.0 front tires and 18.4 x 26.0
R4 rear tires.

SERVICE CAPACITIES

Fuel tank 34.6 gal (131 L)

DEF tank 3.5 gal (13.2 L)

Hydraulic system:

Total 37 gal (142 L)

Transmission – total system:

4WD Standard 22 qt (20.8 L)

LOADER BUCKET SIZES

Type	Width	Weight	Struck	Heaped Capacity
Heavy Duty Bucket with bolt-on edge	89 in (2.30 m)	1,042 lb (473 kg)	1.05 yd ³ (0.80 m ³)	1.30 yd ³ (1.00 m ³)
	94 in (2.40 m)	1,116 lb (506 kg)	1.20 yd ³ (0.92 m ³)	1.50 yd ³ (1.15 m ³)
4 IN 1* Bucket with bolt-on edge	89 in (2.30 m)	1,721 lb* (781 kg)	1.05 yd ³ (0.80 m ³)	1.30 yd ³ (1.00 m ³)

NOTE: *Weight of 4 IN 1* bucket includes cylinders and hoses.

BACKHOE BUCKET SIZES

Type	Width	Weight	Heaped Capacity
Heavy Duty	12 in (305 mm)	245 lb (111 kg)	2.8 ft ³ (0.08 m ³)
	18 in (457 mm)	302 lb (137 kg)	4.2 ft ³ (0.12 m ³)
	24 in (610 mm)	348 lb (158 kg)	6.0 ft ³ (0.17 m ³)
	30 in (762 mm)	388 lb (176 kg)	8.1 ft ³ (0.23 m ³)
	36 in (914 mm)	439 lb (199 kg)	9.9 ft ³ (0.28 m ³)
High Capacity Bucket	24 in (610 mm)	388 lb (176 kg)	7.1 ft ³ (0.20 m ³)

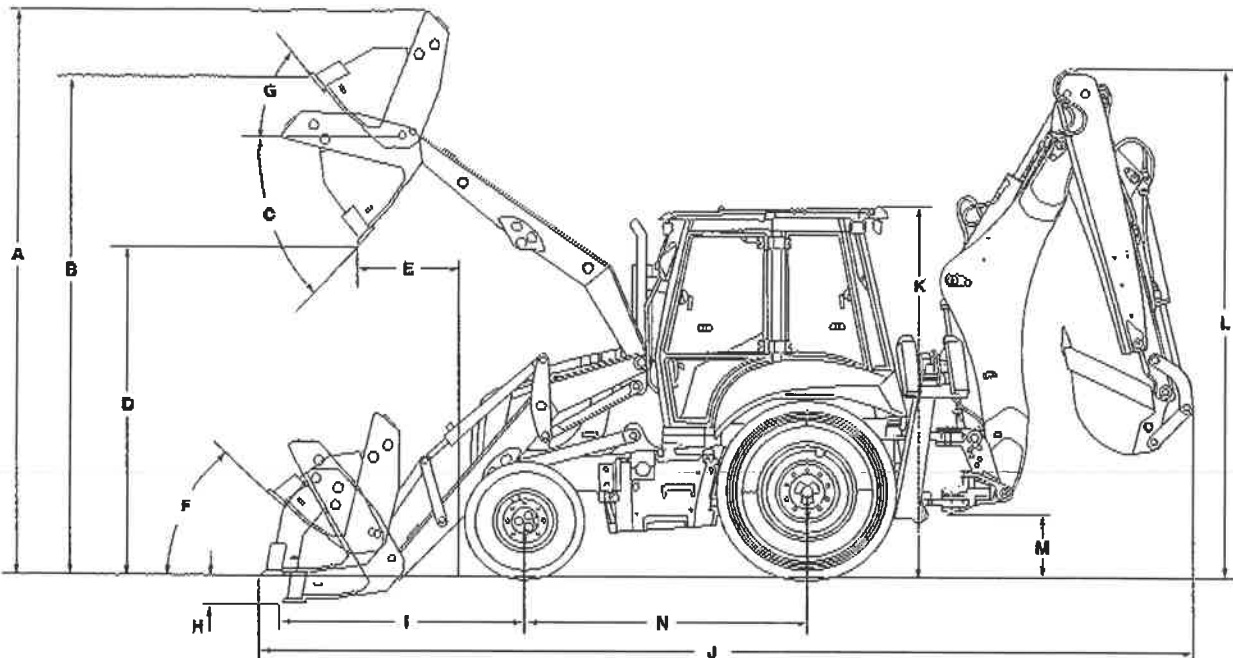

Line drawings are for illustrative purpose only and may not be exact representation of unit.

LOADER DIMENSIONS

	Heavy Duty Bucket	4 IN 1 st Bucket
A. Overall operating height – fully raised	13 ft 11 in (4.25 m)	14 ft 5 in (4.38 m)
Height to:		
B. Bucket hinge pin fully raised	11 ft 11 in (3.63 m)	11 ft 1 in (3.38 m)
C. Dump angle at full height	47°	47°
D. Dump clearance at full height, 45° dump: Bucket	9 ft 3 in (2.84 m)	8 ft 4 in (2.55 m)
E. Dump reach at full height, 45° dump – from bumper: Bucket	2 ft 9 in (829 mm)	2 ft 8 in (824 mm)
Bucket rollback:		
F. @ Groundline	42°	42°
G. @ Full height	50°	50°
H. Digging depth below grade: Bucket flat	5.0 in (120 mm)	8.6 in (219 mm)
I. Reach from front axle centerline – bucket on ground	—	6 ft 10 in (2.07 m)
Lift capacity to full height – calculated values	7,758 lb (3 520 kg)	7,044 lb (3 195 kg)
Breakout force:		
Lift cylinders	8,391 lbf (3 728 daN)	8,041 lbf (3 577 daN)
Dump cylinders	15,670 lbf (6 970 daN)	14,950 lbf (6 650 daN)
Raising time to full height	3.4 sec	3.4 sec
Bucket dumping time	2.3 sec	2.3 sec
Lowering time:		
Power down	2.8 sec	2.8 sec
Clam:		
Open time	—	1.9 sec
Close time	—	1.4 sec

NOTE: Loader dimensions taken with 4WD, 14 x 17.5 front tires and 16.9 L x 28.0 rear tires.

DIMENSIONS

	Center Pivot Backhoe with 16.9 L x 28.0 tires	Side Shift Backhoe with 16.9 L x 28.0 tires
J. Overall transport length:		
Heavy Duty bucket	23 ft 7 in (7.19 m)	19 ft 3 in (5.87 m)
Overall transport width	8 ft 2 in (2.48 m)	7 ft 10 in (2.39 m)
Height:		
K. To top of cab	9 ft 5 in (2.86 m)	9 ft 5 in (2.86 m)
L. Transport	13 ft 0 in (3.96 m)	12 ft 10 in (3.90 m)
M. Ground clearance at backhoe frame	13.4 in (341 mm)	11.3 in (286 mm)
Angle of departure	25°	20°
N. Wheelbase:		
16.9 x 28.0 tires	7 ft 2 in (2.18 m)	7 ft 2 in (2.18 m)

CYLINDERS

	Bore Diameter	Rod Diameter	Stroke	Closed Length
Loader:				
Lift - 2	3.54 in (90 mm)	1.97 in (50 mm)	29.62 in (727 mm)	40.94 in (1 040 mm)
Dump - 2	3.25 in (82.6 mm)	1.75 in (44.5 mm)	30.59 in (777 mm)	40.16 in (1 020 mm)
4 IN 1° clam - 2	3.00 in (76.2 mm)	1.75 in (44.5 mm)	9.08 in (230.6 mm)	19.62 in (498.3 mm)
Backhoe:				
14 ft Boom	5.12 in (130 mm)	2.56 in (65 mm)	35.71 in (907 mm)	47.52 in (1 207 mm)
14 ft Dipperstick	4.92 in (125 mm)	2.56 in (65 mm)	27.60 in (701 mm)	39.72 in (1 009 mm)
Bucket	3.54 in (90 mm)	2.56 in (65 mm)	30.00 in (762 mm)	42.24 in (1 073 mm)
14 ft Extendahoe®	2.95 in (75 mm)	1.77 in (45 mm)	41.34 in (1 050 mm)	55.12 in (1 400 mm)
Swing - 2	4.93 in (110 mm)	1.97 in (50 mm)	9.40 in (238.6 mm)	5.40 in (137.1 mm)
Stabilizer - 2	3.94 in (100 mm)	2.20 in (56 mm)	24.8 in (630 mm)	37.01 in (940 mm)

AXLE RATINGS

	Rear	Front - 4WD
Maximum static	—	46,367 lbf (20 625 daN)
Dynamic operating	16,861 lbf (7 500 daN)	18,546 lbf (8 250 daN)
Static operating	42,152 lbf (18 750 daN)	46,367 lbf (20 625 daN)
Oscillation - front axle	—	22° total - 11° side to side

BACKHOE LIFT CAPACITIES

In-Line Cylinder Standard Backhoe		In-Line Cylinder Backhoe with Extendahoe®			
		Retracted		Extended	
14 ft Backhoe		14 ft Backhoe	15 ft Backhoe	14 ft Backhoe	15 ft Backhoe
Boom Lift	Lift Capacity lb (kg)	Lift Capacity lb (kg)	Lift Capacity lb (kg)	Lift Capacity lb (kg)	Lift Capacity lb (kg)
+16 ft (4.87 m)	3,574 (1 624)	3,055 (1 389)	3,168 (1 440)	1,844 (838)	2,409 (1 095)
+14 ft (4.27 m)	4,023 (1 829)	3,516 (1 598)	3,729 (1 695)	2,513 (1 142)	2,607 (1 185)
+12 ft (3.66 m)	4,139 (1 881)	3,597 (1 635)	3,828 (1 740)	2,582 (1 174)	2,673 (1 215)
+10 ft (3.05 m)	4,069 (1 850)	3,539 (1 609)	3,784 (1 720)	2,594 (1 179)	2,706 (1 230)
+8 ft (2.44 m)	3,954 (1 797)	3,424 (1 556)	3,454 (1 570)	2,571 (1 169)	2,673 (1 215)
+8 ft (1.83 m)	3,816 (1 734)	3,309 (1 504)	3,245 (1 475)	2,536 (1 153)	2,563 (1 165)
+4 ft (1.22 m)	3,689 (1 677)	3,193 (1 451)	3,135 (1 425)	2,490 (1 132)	2,497 (1 135)
+2 ft (0.61 m)	3,574 (1 624)	3,078 (1 399)	3,080 (1 400)	2,455 (1 116)	2,464 (1 120)
Ground Level	3,470 (1 577)	2,986 (1 357)	3,102 (1 410)	2,409 (1 095)	2,464 (1 120)
-2 ft (0.61 m)	3,366 (1 530)	2,894 (1 315)	3,179 (1 445)	2,375 (1 079)	2,508 (1 140)
-4 ft (1.22 m)	3,297 (1 499)	2,813 (1 278)	3,113 (1 415)	2,352 (1 069)	2,530 (1 150)
-6 ft (1.83 m)	3,239 (1 472)	2,755 (1 252)	3,089 (1 395)	2,329 (1 058)	2,519 (1 145)
-8 ft (2.44 m)	3,228 (1 467)	2,732 (1 242)	3,047 (1 385)	2,329 (1 058)	2,530 (1 150)
-10 ft (3.05 m)	3,343 (1 520)	2,801 (1 273)	3,113 (1 415)	2,363 (1 074)	2,583 (1 166)
-12 ft (3.66 m)	3,574 (1 624)	3,090 (1 404)	3,586 (1 630)	2,467 (1 121)	2,662 (1 210)
-14 ft (4.27 m)	—	—	—	2,859 (1 300)	2,915 (1 325)
Dipper Lift					
+14 ft (4.27 m)	—	—	—	3,613 (1 642)	3,388 (1 540)
+12 ft (3.66 m)	5,545 (2 520)	4,948 (2 249)	4,312 (1 960)	3,935 (1 789)	3,311 (1 505)
+10 ft (3.05 m)	5,330 (2 423)	5,819 (2 645)	4,158 (1 890)	3,875 (1 762)	3,267 (1 485)
+8 ft (2.44 m)	5,437 (2 472)	5,819 (2 645)	4,202 (1 910)	3,923 (1 783)	3,300 (1 500)
+6 ft (1.83 m)	5,962 (2 710)	5,819 (2 645)	4,488 (2 040)	4,102 (1 864)	3,410 (1 550)
+4 ft (1.22 m)	—	5,819 (2 645)	5,324 (2 420)	4,495 (2 043)	3,685 (1 675)
+2 ft (0.61 m)	—	—	—	5,390 (2 450)	4,191 (1 905)

NOTE: Boom and Dipper Lift Capacities are rated per SAE J31 and are 87% of the maximum hydraulic lift force available with the specified options.

BACKHOE OPERATIONAL DATA

	In-Line Cylinder 14 ft Standard Backhoe	In-Line Cylinder 15 ft Backhoe with Extendahoe®	
		Retracted	Extended
Digging depth:			
Maximum	14 ft 5 in (4.40 m)	15 ft 1 in (4.60 m)	18 ft 6 in (5.63 m)
Maximum with 15 ft standard backhoe	15 ft 0 in (4.51 m)	—	—
2 ft (610 mm) flat bottom	14 ft 3 in (4.34 m)	14 ft 11 in (4.55 m)	18 ft 4 in (5.58 m)
8 ft (2.44 m) flat bottom	13 ft 1 in (3.99 m)	13 ft 9 in (4.19 m)	17 ft 5 in (5.30 m)
Overall reach from swing pivot	18 ft 7 in (5.68 m)	19 ft 5 in (5.91 m)	23 ft 0 in (7.00 m)
Loading height	11 ft 9 in (3.57 m)	12 ft 1 in (3.68 m)	14 ft 2 in (4.32 m)
Loading reach	6 ft 9 in (2.05 m)	7 ft 0 in (2.13 m)	9 ft 9 in (2.98 m)
Swing arc	180°	180°	180°
Bucket rotation – speed hole	204°	204°	204°
Stabilizer spread – in up position	7 ft 6 in (2.30 m)	7 ft 6 in (2.30 m)	7 ft 6 in (2.30 m)
Digging force:			
Bucket cylinder – SAE rated 3,050 psi	13,795 lb (6 136 daN)	12,933 lb (5 755 daN)	12,933 lb (5 755 daN)
Dipper cylinder – SAE rated 3,050 psi	9,146 lb (4 070 daN)	8,100 lb (3 605 daN)	5,782 lb (2 573 daN)

NOTE: Lift capacities apply straight to the rear of prime mover. 4WD with 14 x 17.5 front tires, 18.9 x 28 rear tires, and equipped with 24 in (610 mm) heavy-duty bucket except as noted.

STANDARD EQUIPMENT**OPERATOR ENVIRONMENT**

See page 1

ENGINE

FPT F5 diesel
 Selective Catalytic Reduction – SCR
 Full flow engine oil filter
 Aspirated air cleaner – replaceable dual element dry type with radial seal
 Fuel filter with water trap
 Radiator with de-aeration bottle
 Antifreeze to -34° F (-37° C)
 Electronic throttles – foot and rotary hand
 Self-adjusting belt
 High Pressure Common Rail computer controlled injection with diagnostic features
 ECO Power Mode
 Auto Engine Idle
 Auto Engine Shutdown
 Auto Protection Shutdown
 Electronic Fuel Priming
 Glow Plugs

OPTIONAL EQUIPMENT**OPERATOR ENVIRONMENT**

Speed selectable Auto Ride Control
 ROPS/FOPS certified protective canopy

DRIVETRAIN

H-Type Powershift transmission, 4F-3R, hydraulic clutch shifting, kick down, transmission disconnect and FNR switch in loader control lever, includes auto shift mode

LOADER

Auxiliary hydraulics for loader-mounted equipment with thumb-operated proportional control
 Hydraulic front quick coupler
 Tool portfolio of additional attachments
 Buckets – see page 2

DRIVETRAIN

Power Shuttle 4F-4R synchromesh transmission
 Front axle:
 4WD mechanically driven front axle with 14.0 L x 17.5 tires
 Rear axle:
 4WD heavy-duty outboard planetary drive, with 16.9 L x 28.0 tires
 Torque converter – 11.8 in (300 mm)
 On-the-go electric 4WD control
 Electric F/R shuttle control
 Electric differential lock control, push-button
 Park brake, spring-applied, hydraulic release – SAHR

HYDRAULICS

Load Sensing Closed Center with Variable Volume Pump
 Heavy-duty hydraulic oil cooler
 7-micron, spin on oil filter

LOADER

Tool carrier loader arms with self leveling in both directions and return to dig; Single lever 4-function loader control: lift, dump, clutch cut-out, differential lock

BACKHOE

Backhoe design styles:
 Side Shift
 Center Pivot
 Overlapping Cylinder Boom with Extendahoe®
 1-way Auxiliary backhoe hydraulics for hammers, plate compactors or similar 1-way flow attachments
 1-way/2-way Auxiliary backhoe hydraulics for hammers, plate compactors or similar 1-way flow attachments or switch to 2-way flow for augers or similar 2-way flow attachments
 Backhoe Booms:
 14 ft Standard Boom
 14 ft Extendahoe®
 15 ft Extendahoe®
 Pilot operated control system:
 Thumb-operated proportional Electro-Hydraulic Extendahoe® control
 Thumb-operated horn button
 Thumb-operated auxiliary hydraulic control
 Infinitely adjustable towers
 In-cab switchable “excavator to backhoe” control pattern change

BACKHOE

In-line cylinder curved boom backhoe design
 Cleated dirt stabilizer pads (center pivot)
 Mechanical Transport Lock

OTHER

Forward tilt engine hood
 Front/Rear tie downs
 Reflective logos
 Signal Lights – cab and canopy:
 2 rear tail/stop
 2 front flashers/turn
 2 rear flashers/turn
 Working/Driving Lights – cab and canopy:
 — Adjustable halogen work lights – 55 W—
 4 front
 4 rear
 Master disconnect switch and remote jump-start terminals
 Hydrostatic steering
 Backup alarm
 Vertical spin-on engine oil, fuel and hydraulic filters
 Tool Box

WARRANTY

1-Year/Unlimited-Hour Full-Coverage Base Limited Warranty
 2-Year/2,000-Hour Extended Engine Warranty

Dirt stabilizer pads (side shift)
 Universal Footrest stabilizer pads (side shift)
 Flip over stabilizer pads (center pivot)
 Bucket quick coupler
 Buckets – see page 2

OTHER

LED Working/Driving Light Package:
 4 front
 4 rear
 Dual 12 volt batteries
 Cold Weather Lubricants

TELEMATICS

CASE SiteWatch™ Telematics

SERVICE PARTS

3 inch seat belt
 N Series compatible backhoe coupler for in-line cylinder backhoe

CaseCE.com

©2023 CNH Industrial America LLC. All rights reserved. CASE is a trademark registered in the United States and many other countries, owned by or licensed to CNH Industrial N.V., its subsidiaries or affiliates. CNH Industrial Capital is a trademark in the United States and many other countries, owned by or licensed to CNH Industrial N.V., its subsidiaries or affiliates. Printed in U.S.A. Contains 10% post-consumer fiber.

Form No. CCE202306580SV+
 Replaces Form No. CCE202308580SV

580SV+

IMPORTANT: CASE Construction Equipment Inc. reserves the right to change these specifications without notice and without incurring any obligation relating to such change. Availability of some models and equipment builds vary according to the country in which the equipment is used. The illustrations and text may include optional equipment and accessories and may not include all standard equipment. Your CASE dealer/distributor will be able to give you details of the products and their specifications available in your area.



CASE Construction Equipment is biodiesel-friendly. NOTE: All engines meet current EPA emissions regulations. All specifications are stated in accordance with SAE Standards or Recommended Practices, where applicable.



Always read the Operator's Manual before operating any equipment. Inspect equipment before using it, and be sure it is operating properly. Follow the product safety signs and use any safety features provided.



Department of Administration
Purchasing Division
2019 Washington Street East
Post Office Box 50130
Charleston, WV 25305-0130

State of West Virginia
Centralized Request for Quote
Equipment

Proc Folder: 1226210		Reason for Modification:	
Doc Description: Four Wheel Drive Loader w/backhoe			
Proc Type: Central Master Agreement			
Date Issued	Solicitation Closes	Solicitation No	Version
2023-05-18	2023-06-14 13:30	CRFQ 0803 DOT2300000135	1

BID RECEIVING LOCATION

BID CLERK
DEPARTMENT OF ADMINISTRATION
PURCHASING DIVISION
2019 WASHINGTON ST E
CHARLESTON WV 25305
US

VENDOR

Vendor Customer Code: VS0000038128
Vendor Name : Groff Tractor Mid Atlantic, LLC
Address : 8404 Kelso Drive
Street :
City : Essex
State : MD **Country :** USA **Zip :** 21221
Principal Contact : Karen Gibison karengibison@gtmidatlantic.com
Vendor Contact Phone: 908-910-1899 **Extension:** n/a

FOR INFORMATION CONTACT THE BUYER

John W Estep
304-558-2566
john.w.estep@wv.gov

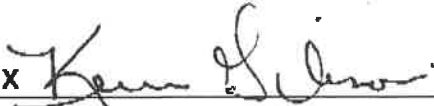
Vendor Signature X  FEIN# 82-2037629 DATE 6/21/23

All offers subject to all terms and conditions contained in this solicitation

ADDITIONAL INFORMATION

REQUEST FOR QUOTATION:

The West Virginia Purchasing Division is soliciting bids on behalf of West Virginia Division of Highways to establish an open-end contract for a Four-Wheel Drive Loader with Backhoe John Deere 320 P-Tier or equal. Per the Bid Requirements, Specifications, Terms and Conditions attached to this solicitation.

INVOICE TO	SHIP TO
------------	---------

DIVISION OF HIGHWAYS EQUIPMENT DIVISION RT 33 83 BRUSHY ROAD CROSSING, PO BOX 610 BUCKHANNON WV US	DIVISION OF HIGHWAYS EQUIPMENT DIVISION 83 BRUSHY FORK RD CROSSING BUCKHANNON WV US
---	--

Line	Comm Ln Desc	Qty	Unit Issue	Unit Price	Total Price
1	Loader/Backhoe	20.00000	EA		

Comm Code	Manufacturer	Specification	Model #
22101509			

Extended Description:
Four Wheel Drive Loader w/backhoe

SCHEDULE OF EVENTS

Line	Event	Event Date
1	Pre-Bid Meeting 9:00am - Equipment Div.	2023-06-01
2	Tech Questions due by 10:00am	2023-06-08

06-22-'23 09:46 FROM-

Received:8566973933

Jun 22 2023 10:09am

P012

T-123 P0012/0060 F-870

	Document Phase	Document Description	Days
DOT2300000135	Final	Four Wheel Drive Loader w/backhoe	3

ADDITIONAL TERMS AND CONDITIONS

See attached document(s) for additional Terms and Conditions



Department of Administration
Purchasing Division
2019 Washington Street East
Post Office Box 50130
Charleston, WV 25305-0130

State of West Virginia
Centralized Request for Quote
Equipment

Proc Folder: 1226210		Reason for Modification:	
Doc Description: ADDENDUM NO_1 Four Wheel Drive Loader w/backhoe		ADDENDUM NO_1 Attach Pre-bid Sign-In Sheets	
Proc Type: Central Master Agreement			
Date Issued	Solicitation Closes	Solicitation No	Version
2023-06-01	2023-06-14 13:30	CRFQ 0803 DOT2300000135	2

BID RECEIVING LOCATION

BID CLERK
DEPARTMENT OF ADMINISTRATION
PURCHASING DIVISION
2019 WASHINGTON ST E
CHARLESTON WV 25305
US

VENDOR

Vendor Customer Code: VS0000038128
Vendor Name : Groff Tractor Mid Atlantic, LLC
Address : 8404 Kelso Drive
Street :
City : Essex
State : MD **Country:** USA **Zip:** 21221
Principal Contact : Karen Gibison karengibison@gtmidatlantic.com
Vendor Contact Phone: 908-910-1899 **Extension:** n/a

FOR INFORMATION CONTACT THE BUYER

John W Estep
304-558-2566
john.w.estep@wv.gov

Vendor
Signature X

FEIN# 82-2037629

DATE 6/21/2023

All offers subject to all terms and conditions contained in this solicitation

ADDITIONAL INFORMATION

ADDENDUM NO_1

Addendum No_1 issued to publish and distribute the attached information to the Vendor Community.

REQUEST FOR QUOTATION:

The West Virginia Purchasing Division is soliciting bids on behalf of West Virginia Division of Highways to establish an open-end contract for a Four-Wheel Drive Loader with Backhoe John Deere 320 P-Tier or equal. Per the Bid Requirements, Specifications, Terms and Conditions attached to this solicitation.

INVOICE TO SHIP TO

DIVISION OF HIGHWAYS EQUIPMENT DIVISION RT 33 83 BRUSHY ROAD CROSSING, PO BOX 610 BUCKHANNON WV US	DIVISION OF HIGHWAYS EQUIPMENT DIVISION 83 BRUSHY FORK RD CROSSING BUCKHANNON WV US
---	--

Line	Comm Ln Desc	Qty	Unit Issue	Unit Price	Total Price
1	Loader/Backhoe	20.00000	EA		

Comm Code	Manufacturer	Specification	Model #
22101509			

Extended Description:
Four Wheel Drive Loader w/backhoe

SCHEDULE OF EVENTS

Line	Event	Event Date
1	Pre-Bid Meeting 9:00am - Equipment Div.	2023-06-01
2	Tech Questions due by 10:00am	2023-06-08

	Document Name	Document Description	Page 3
DOT2300000135	Final	ADDENDUM NO_1 Four Wheel Drive Loader w/backhoe	

ADDITIONAL TERMS AND CONDITIONS

See attached document(s) for additional Terms and Conditions



Purchasing Division
2019 Washington Street East
Post Office Box 50130
Charleston, WV 25305-0130

STATE OF WEST VIRGINIA
Centralized Request for Quote
Equipment

Proc Folder: 1226210		Reason for Modification:	
Doc Description: ADDENDUM NO_1 Four Wheel Drive Loader w/backhoe		ADDENDUM NO_1 Attach Pre-bid Sign-In Sheets	
Proc Type: Central Master Agreement			
Date Issued	Solicitation Closes	Solicitation No	Version
2023-06-01	2023-06-14 13:30	CRFQ 0803 DOT2300000135	2

BID RECEIVING LOCATION

BID CLERK
DEPARTMENT OF ADMINISTRATION
PURCHASING DIVISION
2019 WASHINGTON ST E
CHARLESTON WV 25305
US

VENDOR

Vendor Customer Code: VS0000038128
Vendor Name : Groff Tractor Mid Atlantic, LLC
Address : 8404 Kelso Drive
Street :
City : Essex
State : MD **Country :** USA **Zip :** 21221
Principal Contact : Karen Gibison karengibison@gtmidatlantic.com
Vendor Contact Phone: 908-910-1899 **Extension:** n/a

FOR INFORMATION CONTACT THE BUYER

John W Estep
304-558-2566
john.w.estep@wv.gov

Vendor Signature X  **FEIN#** 82-2037629 **DATE** 6/21/2023

All offers subject to all terms and conditions contained in this solicitation

SOLICITATION NUMBER: CRFQ DOT2300000135**Addendum Number: 1**

The purpose of this addendum is to modify the solicitation identified as CRFQ DOT2300000135 ("Solicitation") to reflect the change(s) identified and described below.

Applicable Addendum Category:

- Modify bid opening date and time
- Modify specifications of product or service being sought
- Attachment of vendor questions and responses
- Attachment of pre-bid sign-in sheet
- Correction of error
- Other

Additional Documentation:

Pre-Bid Sign-In Sheets

Bid Opening remains 06/14/2023 at 1:30pm

Terms and Conditions:

1. All provisions of the Solicitation and other addenda not modified herein shall remain in full force and effect.
2. Vendor should acknowledge receipt of all addenda issued for this Solicitation by completing an Addendum Acknowledgment, a copy of which is included herewith. Failure to acknowledge addenda may result in bid disqualification. The addendum acknowledgement should be submitted with the bid to expedite document processing.

Pre-Bid Sign-In Sheet

Solicitation Number: CRFQ DOT2300000135
 Date of Pre-Bid Meeting: June 1, 2023
 Location of Prebid Meeting: Buckhannon, WV Equip. Division

Please Note:

Vendors must sign-in on this sheet to verify attendance at the Pre-Bid meeting. Failure to legibly sign in may be grounds for declaring a vendor ineligible to bid. For further verification, please also provide a business card if possible.

Firm Represented:*	Rep Name (Printed):	Firm Address:	Telephone #:	Fax #:	Email:
CASE Construction Equipment	Ryan Mitvalsky	621 STATE ST Racine, WV 25302	570-335-8334		ryan.mitvalsky@casece.com
GT Mid Atlantic	Donovan Balland	1561 Tileo Dr. Frederick, md 21704	246-446-1391	31-482-6075	DonovanBalland@GTMidAtlantic.com
Lestic Equipment	Bo Kester	2098 Wilkin Lane Fairmont WV 26554	304-534-5454		kesterbob@lect.com
Lestic Equipment	Trent May	19 Goff Crossing Drive, Cross Lanes WV 25313	304-542-0433	304-204-1811	may.trent@lect.com
STATE Equipment	TERRY LAMA	560 NEW Goff Mt. Road CROSS LANES WV	304 539 8691	304 776 4409	terry1@stateequipment.com
STATE EQUIPMENT	EDDIE ROMAN	560 NEW Goff Mt. CROSS LANES WV 25313	(CALL) 304-539-8691 304-776-4465 (OFFICE)	304-776-4465	EDDIE@STATEEQUIPMENT.COM

***One Vendor Per Representative - No one individual is permitted to represent more than one vendor at the pre-bid meeting. Any individual that does attempt to represent two or more vendors will be required to select one vendor to which the individual's attendance will be attributed. The vendors not selected will be deemed to have not attended the pre-bid meeting unless another individual attended on their behalf.**

Pre-Bid Sign-In Sheet

Solicitation Number: CRFQ DOT2300000135
 Date of Pre-Bid Meeting: June 1, 2023
 Location of Prebid Meeting: Buckhannon, WV Equip. Division

Please Note:

Vendors must sign-in on this sheet to verify attendance at the Pre-Bid meeting. Failure to legibly sign in may be grounds for declaring a vendor ineligible to bid. For further verification, please also provide a business card if possible.

<u>Firm Represented:*</u>	<u>Rep Name (Printed):</u>	<u>Firm Address:</u>	<u>Telephone #:</u>	<u>Fax #:</u>	<u>Email:</u>
BOYD CAT	MATT CONNER	3 PARK RD. HUB INDUSTRIAL PARK NITRO, WV 25143	(304)543-5406	(304)759-6404	matthewconner@boycat.com

***One Vendor Per Representative - No one individual is permitted to represent more than one vendor at the pre-bid meeting. Any individual that does attempt to represent two or more vendors will be required to select one vendor to which the individual's attendance will be attributed. The vendors not selected will be deemed to have not attended the pre-bid meeting unless another individual attended on their behalf.**

Pre-Bid Sign-In Sheet

Solicitation Number: CRFQ DOT2300000135
 Date of Pre-Bid Meeting: June 1, 2023
 Location of Prebid Meeting: Buckhannon, WV Equip. Division

Please Note:
 Vendors must sign-in on this sheet to verify attendance at the Pre-Bid meeting.
 Failure to legibly sign in may be grounds for declaring a vendor ineligible to bid.
 For further verification, please also provide a business card if possible.

<u>Firm Represented:*</u>	<u>Rep Name (Printed):</u>	<u>Firm Address:</u>	<u>Telephone #:</u>	<u>Fax #:</u>	<u>Email:</u>
WV DOT	Pam Hall	23 Brushy Fork Crossing Buckhannon WV	304-477-0139		pamela.j.hall@wv.gov
WV DOT	JD Haller	11	304-477-0141		

**One Vendor Per Representative - No one individual is permitted to represent more than one vendor at the pre-bid meeting. Any individual that does attempt to represent two or more vendors will be required to select one vendor to which the individual's attendance will be attributed. The vendors not selected will be deemed to have not attended the pre-bid meeting unless another individual attended on their behalf.*

06-22-23 09:49 FROM-
 Received: 656973933
 Jun 22 2023 10:11am
 T-123 P0021/0060 F-870
 P021

STATE EQUIPMENT, INC.



TERRY LAMM
PRESIDENT

CELL: 304-539-8651
OFFICE: 304-776-4405
FAX: 304-776-4409
EMAIL: TERRY.L@STATEEQUIPMENT.COM
WWW.STATEEQUIPMENT.COM

560 NEW GOFF MOUNTAIN RD
CROSS LANES, WV 25313









Matt Conner
Sales Representative
Construction

Boyd Company
3 Park Drive
Hub Industrial Park
Martinsburg, WV 25143
304.759.6400

304.543.5406 mobile

MatthewConner@boydcat.com
www.boydcat.com



"Run with the Best"

Bo Kesler Corporate

2098 Lillian Lane
Pleasant Valley, WV 26554
keslerbo@lec1.com
www.lec1.com



Office: 304-534-5454
Fax: 304-534-5888
Cell: 304-663-2004



"Run with the Best"

Trent May Sales Representative

19 Goff Crossing Drive
Cross Lanes, WV 25313
maytrent@lec1.com
www.lec1.com



Office: 304-204-1811
Fax: 304-204-1811
Cell: 304-542-8431



Ryan R. Mitvalsky
Case Business Manager - Northeast

CNH Industrial America LLC
621 State Street
Racine, WI 53402
Phone 570 335 8334
ryan.mitvalsky@casece.com



Mid Atlantic



Donavan Bolland
Sales Representative

1561 Tilco Drive
Frederick, MD 21704
Office (301) 682-4441, Cell (240) 446-1391
donavanbolland@gmtatlantic.com
www.gmtatlantic.com

A subsidiary of Goff Tractor Holdings, LLC

ADDENDUM ACKNOWLEDGEMENT FORM
SOLICITATION NO.: CRFO DOT2300000135

Instructions: Please acknowledge receipt of all addenda issued with this solicitation by completing this addendum acknowledgment form. Check the box next to each addendum received and sign below. Failure to acknowledge addenda may result in bid disqualification.

Acknowledgment: I hereby acknowledge receipt of the following addenda and have made the necessary revisions to my proposal, plans and/or specification, etc.

Addendum Numbers Received:

(Check the box next to each addendum received)

- | | |
|--|--|
| <input checked="" type="checkbox"/> Addendum No. 1 | <input type="checkbox"/> Addendum No. 6 |
| <input type="checkbox"/> Addendum No. 2 | <input type="checkbox"/> Addendum No. 7 |
| <input type="checkbox"/> Addendum No. 3 | <input type="checkbox"/> Addendum No. 8 |
| <input type="checkbox"/> Addendum No. 4 | <input type="checkbox"/> Addendum No. 9 |
| <input type="checkbox"/> Addendum No. 5 | <input type="checkbox"/> Addendum No. 10 |

I understand that failure to confirm the receipt of addenda may be cause for rejection of this bid. I further understand that that any verbal representation made or assumed to be made during any oral discussion held between Vendor's representatives and any state personnel is not binding. Only the information issued in writing and added to the specifications by an official addendum is binding.

Groff Tractor Mid Atlantic, LLC

Company

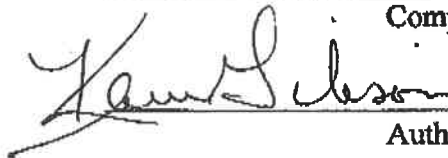

Karen Gibison

Authorized Signature

06-21-2023

Date

NOTE: This addendum acknowledgement should be submitted with the bid to expedite document processing.



Department of Administration
Purchasing Division
2019 Washington Street East
Post Office Box 50130
Charleston, WV 25305-0130

State of West Virginia
Centralized Request for Quote
Equipment

Proc Folder: 1226210		Reason for Modification:	
Doc Description: ADDENDUM NO_2 Four Wheel Drive Loader w/backhoe		ADDENDUM NO_2 Vendor Questions and Responses Bid Opening Moves to 06/22/23	
Proc Type: Central Master Agreement			
Date Issued	Solicitation Closes	Solicitation No	Version
2023-06-09	2023-06-22 13:30	CRFQ 0803 DOT2300000135	3

BID RECEIVING LOCATION

BID CLERK
DEPARTMENT OF ADMINISTRATION
PURCHASING DIVISION
2019 WASHINGTON ST E
CHARLESTON WV 25305
US

VENDOR

Vendor Customer Code: VS0000038128
Vendor Name : Groff Tractor Mid Atlantic, LLC
Address : 8404 Kelso Drive
Street :
City : Essex
State : MD **Country :** USA **Zip :** 21221
Principal Contact : Karen Gibison **karengibison@gtmidatlantic.com**
Vendor Contact Phone: 908-910-1899 **Extension:** n/a

FOR INFORMATION CONTACT THE BUYER

John W Estep
304-558-2566
john.w.estep@wv.gov

Vendor
Signature X

FEIN# 82-2037629

DATE 06-21-2023

All offers subject to all terms and conditions contained in this solicitation

ADDITIONAL INFORMATION

ADDENDUM NO_2

Addendum No_2 issued to publish and distribute the attached information to the Vendor Community.

REQUEST FOR QUOTATION:

The West Virginia Purchasing Division is soliciting bids on behalf of West Virginia Division of Highways to establish an open-end contract for a Four-Wheel Drive Loader with Backhoe John Deere 320 P-Tier or equal. Per the Bid Requirements, Specifications, Terms and Conditions attached to this solicitation.

INVOICE TO	SHIP TO
------------	---------

DIVISION OF HIGHWAYS EQUIPMENT DIVISION RT 33 83 BRUSHY ROAD CROSSING, PO BOX 610 BUCKHANNON WV US	DIVISION OF HIGHWAYS EQUIPMENT DIVISION 83 BRUSHY FORK RD CROSSING BUCKHANNON WV US
---	--

Line	Comm Ln Desc	Qty	Unit Issue	Unit Price	Total Price
1	Loader/Backhoe	20.00000	EA		

Comm Code	Manufacturer	Specification	Model #
22101509			

Extended Description:
Four Wheel Drive Loader w/backhoe

SCHEDULE OF EVENTS

Line	Event	Event Date
1	Pre-Bid Meeting 9:00am - Equipment Div.	2023-06-01
2	Tech Questions due by 10:00am	2023-06-08

	Document Phase	Document Description	Page
DOT2300000135	Final	ADDENDUM NO_2 Four Wheel Drive Loader w/backhoe	3

ADDITIONAL TERMS AND CONDITIONS

See attached document(s) for additional Terms and Conditions



Purchasing Division
2019 Washington Street East
Post Office Box 50130
Charleston, WV 25305-0130

**Centralized Request for Quote
Equipment**

Proc Folder: 1226210		Reason for Modification:	
Doc Description: ADDENDUM NO_2 Four Wheel Drive Loader w/backhoe		ADDENDUM NO_2 Vendor Questions and Responses Bid Opening Moves to 06/22/23	
Proc Type: Central Master Agreement			
Date Issued	Solicitation Closes	Solicitation No	Version
2023-06-09	2023-06-22 13:30	CRFQ 0803 DOT2300000135	3

BID RECEIVING LOCATION

BID CLERK
DEPARTMENT OF ADMINISTRATION
PURCHASING DIVISION
2019 WASHINGTON ST E
CHARLESTON WV 25305
US

VENDOR

Vendor Customer Code: VS0000038128

Vendor Name : Groff Tractor Mid Atlantic, LLC

Address : 8404 Kelso Drive

Street :

City : Essex

State : MD **Country:** USA **Zip :** 21221

Principal Contact : Karen Gibison karengibison@gtmidatlantic.com

Vendor Contact Phone: 908-910-1899 **Extension:** n/a

FOR INFORMATION CONTACT THE BUYER
John W Estep
304-558-2566
john.w.estep@wv.gov

Vendor Signature:  **FEIN#** 82-2037629 **DATE** 6/21/2023

All offers subject to all terms and conditions contained in this solicitation

ADDITIONAL INFORMATION

ADDENDUM NO_2

Addendum No_2 issued to publish and distribute the attached information to the Vendor Community.

REQUEST FOR QUOTATION:

The West Virginia Purchasing Division is soliciting bids on behalf of West Virginia Division of Highways to establish an open-end contract for a Four-Wheel Drive Loader with Backhoe John Deere 320 P-Tier or equal. Per the Bid Requirements, Specifications, Terms and Conditions attached to this solicitation.

INVOICE TO **SHIP TO**

DIVISION OF HIGHWAYS
EQUIPMENT DIVISION RT 33
83 BRUSHY ROAD
CROSSING, PO BOX 610
BUCKHANNON WV
US

DIVISION OF HIGHWAYS
EQUIPMENT DIVISION
83 BRUSHY FORK RD
CROSSING
BUCKHANNON WV
US

Line	Comm Ln Desc	Qty	Unit Issue	Unit Price	Total Price
1	Loader/Backhoe	20.00000	EA		

Comm Code	Manufacturer	Specification	Model #
22101609			

Extended Description:
Four Wheel Drive Loader w/backhoe

SCHEDULE OF EVENTS

Line	Event	Event Date
1	Pre-Bid Meeting 9:00am - Equipment Div.	2023-06-01
2	Tech Questions due by 10:00am	2023-06-08

SOLICITATION NUMBER: CRFQ DOT2300000135**Addendum Number: 2**

The purpose of this addendum is to modify the solicitation identified as CRFQ DOT2300000135 ("Solicitation") to reflect the change(s) identified and described below.

Applicable Addendum Category:

- Modify bid opening date and time
- Modify specifications of product or service being sought
- Attachment of vendor questions and responses
- Attachment of pre-bid sign-in sheet
- Correction of error
- Other

Additional Documentation:

Vendor Questions and Responses

Bid Opening moves to 06/22/2023 at 1:30pm

Terms and Conditions:

1. All provisions of the Solicitation and other addenda not modified herein shall remain in full force and effect.
2. Vendor should acknowledge receipt of all addenda issued for this Solicitation by completing an Addendum Acknowledgment, a copy of which is included herewith. Failure to acknowledge addenda may result in bid disqualification. The addendum acknowledgement should be submitted with the bid to expedite document processing.

ADDENDUM FOR PRE-BID

CRFQ 0803 DOT2300000135

4 Wheel Drive John Deere 320 P-Tier Loader w/Backhoe or Equal

The original language in the contract will be listed first with questions and answer to follow below.

1. 3.1.2 Unit shall be of Manufacturers 4WD (FOUR Wheel Drive) design and shall provide engage and disengage selection accessible from operator's station. Front axle shall have remote grease bank.

Question # 1 State Eq.: Our machine does have grease points on the front axle, but they are not a remote grease bank. We kindly ask for your approval to submit our bid without the remote grease points.

Question # 2 GT Mid-Atlantic : The CASE machine does have grease points on the front axle, but they are not a remote grease bank. We kindly ask for your approval to submit our bid without the remote grease points.

Answer: Yes, we will accept either.

2. 3.1.3.3 Shall have foot operated or button, automatic release, rear axle differential lock engageable under full engine RPM required.

Question # 1 State Eq.: Our machine has a limited slip differential to assist when traction is needed, we kindly ask for your approval to submit our bid with the limited slip differentials.

Question # 2 GT Mid-Atlantic: The CASE machine has a limited slip differential to assist when traction is needed, we kindly ask for your approval to submit our bid with the limited slip differentials.

Answer: No

3. 3.1.9.9 Unit cab shall have a maximum operating decibel level of 73 decibel.

Question # 1 State Eq.: Our machine has a registered dBA rating of 74. We kindly ask for your approval to submit our bid with this difference of 1 dBA.

Question # 2 GT Mid-Atlantic: The Case machine has a registered dBA rating of 74. We kindly ask for your approval to submit our bid with this difference of 1dBA.

Question # 3 Leslie Eq.: Would you allow a cab operating decibel of 74?

Answer: Yes

4. 3.1.10.A and 3.1.10.G

A. Transmission Temperature

G. Volt/Amp Gauge

Question # 1 State Eq.: Our machine does not offer these gauges, and we kindly ask for your approval to submit our bid without these gauges.

Question # 2 GT Mid-Atlantic: The CASE machine does not offer these gauges, and we kindly ask for your approval to submit our bid without these gauges.

Answer: No

5. 3.1.11.6 Unit shall have lockable engine service door and keyed same as cab door(s). Hydraulic tank and fuel tank shall also be lockable.

Question State Eq.: We have a lockable engine service door, but it is not keyed the same as the cab door. Is that acceptable?

Answer: Yes

6. 3.1.15.1 Loader shall be self-leveling with minimum 11ft 3in full raised Bucket pin height

Question # 1 State Eq.: Our machine has a fully raised bucket pin height of 11 ft 1 in. and we kindly ask for your approval to submit our bid with this 2 in. difference.

Question # 2 GT Mid-Atlantic : The CASE machine has a fully raised bucket pin height of 11 ft 1 in. and we kindly ask for your approval to submit our bid with this 2 in. difference.

Answer: No

7. 3.1.15.3 Unit shall provide a G.P. bucket rated at 1.3 C.Y. SAE minimum heaped capacity and a width of 92 inches minimum with bolt on cutting.

Question # 1 State Eq.: Our machine has a capacity of 1.3 Cu Yd. minimum heaped capacity and a width of 89 inches, we kindly ask for your approval to submit our bid with this 3 inch difference.

Question # 2 GT Mid-Atlantic: The CASE machine has a capacity of 1.3 Cu Yd. but with a width of 89 inches, we kindly ask for your approval to submit our bid with this 3 inch difference.

Question # 3 State EQ.: Is a 1.29 cubic yard GP loader bucket acceptable?

Answer: No

8. 3.1.15.4 Unit shall have breakout force of 11,000 pounds minimum.

Question # 1 Leslie Eq.: Would you allow a unit with a breakout force of 10,500 pounds?

Question # 2 State Eq.: Would 10,873 pounds loader breakout force be acceptable?

Answer: Yes, we will accept 10,500 and 10,873 pounds.

9. 3.1.15.5 Unit shall have a loader lift rating of 7,000 pounds minimum to full height.

Question Leslie Eq.: Would a loader with 7,000-pound lift rating at full reach suffice?

Answer: Yes

10. 3.1.16.1 Unit shall have a digging depth of at least 15 feet minimum.

Question #1 Leslie Eq.: Would you allow a unit with a standard max digging depth of 14 ft 2 inches?

Question # 2 State Eq.: Is a 14'6" minimum digging depth acceptable?

Answer: No

11. 3.1.16.2 Backhoe lifting capacity shall be 3,500 pounds minimum to 8-foot lift height minimum through the full 180 degrees swing arc.

Question # 1 State Eq.: Our machine has a rated lifting capacity of 3,454 with retracted extendahoe. We kindly ask for your approval to submit our bid with this 46 pound difference.

Question # 2 GT Mid-Atlantic: The CASE machine has a rated lifting capacity of 3,454 with retracted extendahoe. We kindly ask for your approval to submit our bid with this 46 pound difference.

Answer: No, extendahoe models will not be accepted.

12. 3.1.16.3 Shall have a backhoe bucket cylinder digging force of 14,000 pounds minimum.

Question # 1 State Eq.: Our machine has a rated cylinder force of 12,933 pounds. We kindly ask for your approval to submit our bid with this 1,077 pound difference.

Question # 2 GT Mid Atlantic: The CASE machine has a rated cylinder force of 12,933 pounds. We kindly ask for your approval to submit our bid with this 1,077 pound difference.

Question # 3 Leslie Eq.: Would you allow bucket cylinder digging force of 12,000 pounds?

Question # 4 State Eq.: Is a 13,795 lb. backhoe cylinder digging force acceptable?

**Answer: Question # 1 No
Question # 2 No
Question # 3 No
Question # 4 Yes**

13. 3.1.16.10 Backhoe boom shall have a factory bolt on boom protection plate mounted to the underside of the backhoe boom.

Question # 1 State Eq.: We kindly ask for your approval to submit our bid without this option.

Question # 2 GT Mid Atlantic: We kindly ask for your approval to submit our bid without this option.

Answer: No

14. 3.1.19.1 Unit bid shall have a minimum three-year 5000 hour parts and service warranty.

Question Leslie Eq.: Would you allow standard manufacture warranty?

Answer: No

15. Boyd Cat would like to request that the bid opening date on DOT2300000135, Four wheel drive loader w/backhoe, be extended from June 14th to at least June 21st, or possibly June 28th. There is a process involved with governmental pricing that can take a couple weeks to get through on our side. We can't start that process until after questions are submitted and answered, as they can affect the build of the machine we are quoting.

Answer: We will extend bid opening until June 22 2023, but will not entertain any more technical questions at that time.

ADDENDUM ACKNOWLEDGEMENT FORM
SOLICITATION NO.: CRFO DOT2300000135

Instructions: Please acknowledge receipt of all addenda issued with this solicitation by completing this addendum acknowledgment form. Check the box next to each addendum received and sign below. Failure to acknowledge addenda may result in bid disqualification.

Acknowledgment: I hereby acknowledge receipt of the following addenda and have made the necessary revisions to my proposal, plans and/or specification, etc.

Addendum Numbers Received:

(Check the box next to each addendum received)

- | | |
|--|--|
| <input type="checkbox"/> Addendum No. 1 | <input type="checkbox"/> Addendum No. 6 |
| <input checked="" type="checkbox"/> Addendum No. 2 | <input type="checkbox"/> Addendum No. 7 |
| <input type="checkbox"/> Addendum No. 3 | <input type="checkbox"/> Addendum No. 8 |
| <input type="checkbox"/> Addendum No. 4 | <input type="checkbox"/> Addendum No. 9 |
| <input type="checkbox"/> Addendum No. 5 | <input type="checkbox"/> Addendum No. 10 |

I understand that failure to confirm the receipt of addenda may be cause for rejection of this bid. I further understand that that any verbal representation made or assumed to be made during any oral discussion held between Vendor's representatives and any state personnel is not binding. Only the information issued in writing and added to the specifications by an official addendum is binding.

Groff Tractor Mid Atlantic, LLC

Company

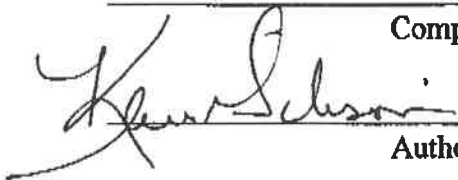

Karen Gibison

Authorized Signature

06/21/2023

Date

NOTE: This addendum acknowledgement should be submitted with the bid to expedite document processing.

GENERAL TERMS AND CONDITIONS:

1. CONTRACTUAL AGREEMENT: Issuance of an Award Document signed by the Purchasing Division Director, or his designee, and approved as to form by the Attorney General's office constitutes acceptance by the State of this Contract made by and between the State of West Virginia and the Vendor. Vendor's signature on its bid, or on the Contract if the Contract is not the result of a bid solicitation, signifies Vendor's agreement to be bound by and accept the terms and conditions contained in this Contract.

2. DEFINITIONS: As used in this Solicitation/Contract, the following terms shall have the meanings attributed to them below. Additional definitions may be found in the specifications included with this Solicitation/Contract.

2.1. "Agency" or "Agencies" means the agency, board, commission, or other entity of the State of West Virginia that is identified on the first page of the Solicitation or any other public entity seeking to procure goods or services under this Contract.

2.2. "Bid" or "Proposal" means the vendors submitted response to this solicitation.

2.3. "Contract" means the binding agreement that is entered into between the State and the Vendor to provide the goods or services requested in the Solicitation.

2.4. "Director" means the Director of the West Virginia Department of Administration, Purchasing Division.

2.5. "Purchasing Division" means the West Virginia Department of Administration, Purchasing Division.

2.6. "Award Document" means the document signed by the Agency and the Purchasing Division, and approved as to form by the Attorney General, that identifies the Vendor as the contract holder.

2.7. "Solicitation" means the official notice of an opportunity to supply the State with goods or services that is published by the Purchasing Division.

2.8. "State" means the State of West Virginia and/or any of its agencies, commissions, boards, etc. as context requires.

2.9. "Vendor" or "Vendors" means any entity submitting a bid in response to the Solicitation, the entity that has been selected as the lowest responsible bidder, or the entity that has been awarded the Contract as context requires.

Fixed Period Contract with Renewals: This Contract becomes effective upon Vendor's receipt of the notice to proceed and part of the Contract more fully described in the attached specifications must be completed within _____ days. Upon completion of the work covered by the preceding sentence, the vendor agrees that:

the contract will continue for _____ years;

the contract may be renewed for _____ successive _____ year periods or shorter periods provided that they do not exceed the total number of months contained in all available renewals. Automatic renewal of this Contract is prohibited. Renewals must be approved by the Vendor, Agency, Purchasing Division and Attorney General's Office (Attorney General approval is as to form only).

One-Time Purchase: The term of this Contract shall run from the issuance of the Award Document until all of the goods contracted for have been delivered, but in no event will this Contract extend for more than one fiscal year.

Construction/Project Oversight: This Contract becomes effective on the effective start date listed on the first page of this Contract, identified as the State of West Virginia contract cover page containing the signatures of the Purchasing Division, Attorney General, and Encumbrance clerk (or another page identified as _____), and continues until the project for which the vendor is providing oversight is complete.

Other: Contract Term specified in _____

4. AUTHORITY TO PROCEED: Vendor is authorized to begin performance of this contract on the date of encumbrance listed on the front page of the Award Document unless either the box for "Fixed Period Contract" or "Fixed Period Contract with Renewals" has been checked in Section 3 above. If either "Fixed Period Contract" or "Fixed Period Contract with Renewals" has been checked, Vendor must not begin work until it receives a separate notice to proceed from the State. The notice to proceed will then be incorporated into the Contract via change order to memorialize the official date that work commenced.

5. QUANTITIES: The quantities required under this Contract shall be determined in accordance with the category that has been identified as applicable to this Contract below.

Open End Contract: Quantities listed in this Solicitation/Award Document are approximations only, based on estimates supplied by the Agency. It is understood and agreed that the Contract shall cover the quantities actually ordered for delivery during the term of the Contract, whether more or less than the quantities shown.

Service: The scope of the service to be provided will be more clearly defined in the specifications included herewith.

Combined Service and Goods: The scope of the service and deliverable goods to be provided will be more clearly defined in the specifications included herewith.

8. INSURANCE: The apparent successful Vendor shall furnish proof of the insurance identified by a checkmark below prior to Contract award. The insurance coverages identified below must be maintained throughout the life of this contract. Thirty (30) days prior to the expiration of the insurance policies, Vendor shall provide the Agency with proof that the insurance mandated herein has been continued. Vendor must also provide Agency with immediate notice of any changes in its insurance policies, including but not limited to, policy cancelation, policy reduction, or change in insurers. The apparent successful Vendor shall also furnish proof of any additional insurance requirements contained in the specifications prior to Contract award regardless of whether that insurance requirement is listed in this section.

Vendor must maintain:

Commercial General Liability Insurance in at least an amount of: \$1,000,000.00 per occurrence.

Automobile Liability Insurance in at least an amount of: \$1,000,000.00 per occurrence.

Professional/Malpractice/Errors and Omission Insurance in at least an amount of: _____ per occurrence. Notwithstanding the forgoing, Vendor's are not required to list the State as an additional insured for this type of policy.

Commercial Crime and Third Party Fidelity Insurance in an amount of: _____ per occurrence.

Cyber Liability Insurance in an amount of: _____ per occurrence.

Builders Risk Insurance in an amount equal to 100% of the amount of the Contract.

Pollution Insurance in an amount of: _____ per occurrence.

Aircraft Liability in an amount of: _____ per occurrence.

17. ADDITIONAL FEES: Vendor is not permitted to charge additional fees or assess additional charges that were not either expressly provided for in the solicitation published by the State of West Virginia, included in the Contract, or included in the unit price or lump sum bid amount that Vendor is required by the solicitation to provide. Including such fees or charges as notes to the solicitation may result in rejection of vendor's bid. Requesting such fees or charges be paid after the contract has been awarded may result in cancellation of the contract.

18. FUNDING: This Contract shall continue for the term stated herein, contingent upon funds being appropriated by the Legislature or otherwise being made available. In the event funds are not appropriated or otherwise made available, this Contract becomes void and of no effect beginning on July 1 of the fiscal year for which funding has not been appropriated or otherwise made available. If that occurs, the State may notify the Vendor that an alternative source of funding has been obtained and thereby avoid the automatic termination. Non-appropriation or non-funding shall not be considered an event of default.

19. CANCELLATION: The Purchasing Division Director reserves the right to cancel this Contract immediately upon written notice to the vendor if the materials or workmanship supplied do not conform to the specifications contained in the Contract. The Purchasing Division Director may also cancel any purchase or Contract upon 30 days written notice to the Vendor in accordance with West Virginia Code of State Rules § 148-1-5.2.b.

20. TIME: Time is of the essence regarding all matters of time and performance in this Contract.

21. APPLICABLE LAW: This Contract is governed by and interpreted under West Virginia law without giving effect to its choice of law principles. Any information provided in specification manuals, or any other source, verbal or written, which contradicts or violates the West Virginia Constitution, West Virginia Code, or West Virginia Code of State Rules is void and of no effect.

22. COMPLIANCE WITH LAWS: Vendor shall comply with all applicable federal, state, and local laws, regulations and ordinances. By submitting a bid, Vendor acknowledges that it has reviewed, understands, and will comply with all applicable laws, regulations, and ordinances.

SUBCONTRACTOR COMPLIANCE: Vendor shall notify all subcontractors providing commodities or services related to this Contract that as subcontractors, they too are required to comply with all applicable laws, regulations, and ordinances. Notification under this provision must occur prior to the performance of any work under the contract by the subcontractor.

23. ARBITRATION: Any references made to arbitration contained in this Contract, Vendor's bid, or in any American Institute of Architects documents pertaining to this Contract are hereby deleted, void, and of no effect.

31. YOUR SUBMISSION IS A PUBLIC DOCUMENT: Vendor's entire response to the Solicitation and the resulting Contract are public documents. As public documents, they will be disclosed to the public following the bid/proposal opening or award of the contract, as required by the competitive bidding laws of West Virginia Code §§ 5A-3-1 et seq., 5-22-1 et seq., and 5G-1-1 et seq. and the Freedom of Information Act West Virginia Code §§ 29B-1-1 et seq.

DO NOT SUBMIT MATERIAL YOU CONSIDER TO BE CONFIDENTIAL, A TRADE SECRET, OR OTHERWISE NOT SUBJECT TO PUBLIC DISCLOSURE.

Submission of any bid, proposal, or other document to the Purchasing Division constitutes your explicit consent to the subsequent public disclosure of the bid, proposal, or document. The Purchasing Division will disclose any document labeled "confidential," "proprietary," "trade secret," "private," or labeled with any other claim against public disclosure of the documents, to include any "trade secrets" as defined by West Virginia Code § 47-22-1 et seq. All submissions are subject to public disclosure without notice.

32. LICENSING: In accordance with West Virginia Code of State Rules § 148-1-6.1.e, Vendor must be licensed and in good standing in accordance with any and all state and local laws and requirements by any state or local agency of West Virginia, including, but not limited to, the West Virginia Secretary of State's Office, the West Virginia Tax Department, West Virginia Insurance Commission, or any other state agency or political subdivision. Obligations related to political subdivisions may include, but are not limited to, business licensing, business and occupation taxes, inspection compliance, permitting, etc. Upon request, the Vendor must provide all necessary releases to obtain information to enable the Purchasing Division Director or the Agency to verify that the Vendor is licensed and in good standing with the above entities.

SUBCONTRACTOR COMPLIANCE: Vendor shall notify all subcontractors providing commodities or services related to this Contract that as subcontractors, they too are required to be licensed, in good standing, and up-to-date on all state and local obligations as described in this section. Obligations related to political subdivisions may include, but are not limited to, business licensing, business and occupation taxes, inspection compliance, permitting, etc. Notification under this provision must occur prior to the performance of any work under the contract by the subcontractor.

33. ANTITRUST: In submitting a bid to, signing a contract with, or accepting a Award Document from any agency of the State of West Virginia, the Vendor agrees to convey, sell, assign, or transfer to the State of West Virginia all rights, title, and interest in and to all causes of action it may now or hereafter acquire under the antitrust laws of the United States and the State of West Virginia for price fixing and/or unreasonable restraints of trade relating to the particular commodities or services purchased or acquired by the State of West Virginia. Such assignment shall be made and become effective at the time the purchasing agency tenders the initial payment to Vendor.

34. VENDOR NON-CONFLICT: Neither Vendor nor its representatives are permitted to have any interest, nor shall they acquire any interest, direct or indirect, which would compromise the performance of its services hereunder. Any such interests shall be promptly presented in detail to the Agency.

Revised 11/1/2022

39. REPORTS: Vendor shall provide the Agency and/or the Purchasing Division with the following reports identified by a checked box below:

Such reports as the Agency and/or the Purchasing Division may request. Requested reports may include, but are not limited to, quantities purchased, agencies utilizing the contract, total contract expenditures by agency, etc.

Quarterly reports detailing the total quantity of purchases in units and dollars, along with a listing of purchases by agency. Quarterly reports should be delivered to the Purchasing Division via email at purchasing.division@wv.gov.

40. BACKGROUND CHECK: In accordance with W. Va. Code § 15-2D-3, the State reserves the right to prohibit a service provider's employees from accessing sensitive or critical information or to be present at the Capitol complex based upon results addressed from a criminal background check. Service providers should contact the West Virginia Division of Protective Services by phone at (304) 558-9911 for more information.

41. PREFERENCE FOR USE OF DOMESTIC STEEL PRODUCTS: Except when authorized by the Director of the Purchasing Division pursuant to W. Va. Code § 5A-3-56, no contractor may use or supply steel products for a State Contract Project other than those steel products made in the United States. A contractor who uses steel products in violation of this section may be subject to civil penalties pursuant to W. Va. Code § 5A-3-56. As used in this section:

- a. "State Contract Project" means any erection or construction of, or any addition to, alteration of or other improvement to any building or structure, including, but not limited to, roads or highways, or the installation of any heating or cooling or ventilating plants or other equipment, or the supply of and materials for such projects, pursuant to a contract with the State of West Virginia for which bids were solicited on or after June 6, 2001.
- b. "Steel Products" means products rolled, formed, shaped, drawn, extruded, forged, cast, fabricated or otherwise similarly processed, or processed by a combination of two or more or such operations, from steel made by the open heath, basic oxygen, electric furnace, Bessemer or other steel making process.
- c. The Purchasing Division Director may, in writing, authorize the use of foreign steel products if:
 1. The cost for each contract item used does not exceed one tenth of one percent (.1%) of the total contract cost or two thousand five hundred dollars (\$2,500.00), whichever is greater. For the purposes of this section, the cost is the value of the steel product as delivered to the project; or
 2. The Director of the Purchasing Division determines that specified steel materials are not produced in the United States in sufficient quantity or otherwise are not reasonably available to meet contract requirements.

44. PROHIBITION AGAINST USED OR REFURBISHED: Unless expressly permitted in the solicitation published by the State, Vendor must provide new, unused commodities, and is prohibited from supplying used or refurbished commodities, in fulfilling its responsibilities under this Contract.

45. VOID CONTRACT CLAUSES: This Contract is subject to the provisions of West Virginia Code § 5A-3-62, which automatically voids certain contract clauses that violate State law.

46. ISRAEL BOYCOTT: Bidder understands and agrees that, pursuant to W. Va. Code § 5A-3-63, it is prohibited from engaging in a boycott of Israel during the term of this contract.

REQUEST FOR QUOTATION
Class 352 Four Wheel Drive John Deere 320 P-Tier Loader With Backhoe or Equal

SPECIFICATIONS

- 1. PURPOSE AND SCOPE:** The West Virginia Purchasing Division is soliciting bids on behalf of West Virginia Division of Highways to establish an open-end contract for a Four Wheel Drive Loader with Backhoe John Deere 320 P-Tier or equal.
- 2. DEFINITIONS:** The terms listed below shall have the meanings assigned to them below. Additional definitions can be found in section 2 of the General Terms and Conditions.
 - 2.1 "Contract Item" or "Contract Items"** means the list of items identified in Section 3.1 below and on the Pricing Pages.
 - 2.2 "Pricing Pages"** means the schedule of prices, estimated order quantity, and totals contained in wvOASIS or attached hereto as Exhibit A, and used to evaluate the Solicitation responses.
 - 2.3 "Solicitation"** means the official notice of an opportunity to supply the State with goods or services that is published by the Purchasing Division.
 - 2.4 "WVDOH"** means West Virginia Division of Highways.
 - 2.5 "4WD"** means Four Wheel Drive.
 - 2.6 "SAE"** means Society of Automotive Engineers.
 - 2.7 "MPH"** means miles per hour.
 - 2.8 "RPM"** means revolutions per minute.
 - 2.9 "GPM"** means gallons per minute.
 - 2.10 "F"** means Fahrenheit.
 - 2.11 "ROPS"** means rollover protection system.
 - 2.12 "FOPS"** means fall over protection system.
 - 2.13 "SMV"** means slow moving vehicle.
 - 2.14 "G.P."** means general purpose.
 - 2.15 "C.Y."** means cubic yard.

REQUEST FOR QUOTATION
Class 352 Four Wheel Drive John Deere 320 P-Tier Loader With Backhoe or
Equal

3. GENERAL REQUIREMENTS:

3.1 Contract Items and Mandatory Requirements: Vendor shall provide Agency with the Contract Items listed below on an open-end and continuing basis. Contract Items must meet or exceed the mandatory requirements as shown below.

3.1.1 The unit specified herein and offered shall be manufactured on or after January 1, 2023 and will be clearly identified and marked with date of manufacture.

3.1.2 Unit shall be of Manufacturers 4WD (FOUR Wheel Drive) design and shall provide engage and disengage selection accessible from operator's station. Front axle shall have remote grease bank.

3.1.3 Manufacturer shall make available for purchase factory diagnostic software to aid in machine repair.

3.1.2 ENGINE

3.1.2.1 Shall be diesel fueled, and water cooled

3.1.2.2 Shall have a minimum of four (4) cylinders.

3.1.2.3 SAE Net Horsepower shall be 107 net minimum

3.1.2.4 Engine shall be Tier 4 Final Compliant.

3.1.2.5 Engine shall be manufactured by the equipment manufacturer.

3.1.3 TRANSMISSION

3.1.3.1 Transmission speeds shall have a minimum four (4) forward fully synchronized; three (3) reverse.

3.1.3.2 Shall have minimum top travel speed up to 20 MPH.

3.1.3.3 Shall have foot operated or button, automatic release, rear axle differential lock engageable under full engine RPM required.

REQUEST FOR QUOTATION
Class 352 Four Wheel Drive John Deere 320 P-Tier Loader With Backhoe or
Equal

3.1.4 STEERING

3.1.4.1 Shall have full power steering with emergency dead engine steering capability.

3.1.5 BRAKES

3.1.5.1 Service brakes shall be 4-wheel minimum, wet disk type, sealed and fully enclosed to allow operating in water, mud, snow, and other adverse conditions without encountering brake loss or fade.

3.1.5.2 Service brakes shall be pressure lubricated and cooled.

3.1.5.3 Service brakes shall be self-adjusting type.

3.1.5.4 Service brakes shall be self-equalizing.

3.1.5.5 The parking/secondary brake system shall be independent of service brakes and hold the weight of the machine on incline.

3.1.5.6 The parking brake system shall be equipped with a warning light and/or audible alarm.

3.1.6 HYDRAULIC SYSTEM

3.1.6.1 The hydraulic system shall be the manufacturers standard. The system shall incorporate a suction strainer and a replaceable return line filter.

3.1.6.2 Hydraulic system shall provide a minimum flow of 40 GPM at a minimum of 2200 RPM to the backhoe and adequate cooling for hydraulic tools and attachments.

3.1.6.3 Backhoe stabilizer hydraulic lockouts shall be provided in both the working and transport positions.

3.1.6.4 Shall have one- and two-way flow auxiliary hydraulics with thumb operated control for operation of hydraulic driven attachments and machine mounted rock breakers, augers plumbed to the end of the dipperstick.

REQUEST FOR QUOTATION
Class 352 Four Wheel Drive John Deere 320 P-Tier Loader With Backhoe or
Equal

3.1.7 ELECTRICAL SYSTEM

3.1.7.1 Shall have Manufacturer's standard 12- or 24-volt electrical system.

3.1.7.2 Alternator shall be 145 AMPS minimum.

3.1.7.3 Shall be equipped with two batteries and shall be maintenance free type with disconnect and jump post and provide a cold-crank amps of 850 minimum each at zero degrees. Single battery units will not be accepted.

3.1.8 COOLING SYSTEM

3.1.8.1 The system shall be filled with permanent extended life anti-freeze solution rated to -30 degrees F minimum.

3.1.9 OPERATORS STATION

3.1.9.1 Cab shall be fully enclosed SAE ROPS/FOPS certified and have a factory headliner.

3.1.9.2 Cab shall be isolation mounted.

3.1.9.3 Air ride cloth seat shall be heated deluxe cushioned with swing around type operator's seat. Shall be fully adjustable, damped and must include manufacturers' seat belt with retractor feature.

3.1.9.4 Tinted safety glass shall be provided at all locations.

3.1.9.5 Cab doors shall be lockable and keyed alike.

3.1.9.6 Unit shall provide front and rear windshield wipers with washers on the front. Rear if available.

3.1.9.7 Manufacturers highest capacity heater/defroster shall be provided.

3.1.9.8 Unit shall be equipped with manufacturer air conditioning.

3.1.9.9 Unit cab shall have a maximum operating decibel level of 73

REQUEST FOR QUOTATION
Class 352 Four Wheel Drive John Deere 320 P-Tier Loader With Backhoe or
Equal

decibel.

3.1.10 INSTRUMENTS

3.1.10.1 Unit shall have lighted gauges and/or monitoring system to include:

- A. Transmission Temperature
- B. Engine Coolant Temperature
- C. Engine Oil Pressure
- D. Hydraulic Filter Restriction
- E. Air Cleaner Restriction
- F. Fuel Gauge
- G. Volt/Amp Gauge
- H. Hour Meter (shall be engine controlled, not key switch)

3.1.10.2 Engine coolant temperature and engine oil pressure and parking brake system to include audible or visual warning systems.

3.1.11 ACCESSORIES

3.1.11.1 Unit shall have a locking type toolbox shall be large enough to store standard size hand operated grease gun and any special tools required by manufacturer.

3.1.11.2 Unit shall have OSHA approved back-up alarm.

3.1.11.3 Unit shall have a horn.

3.1.11.4 Unit shall have a hand and foot-controlled throttle.

3.1.11.5 Unit shall have a muffler with rain proof exhaust.

3.1.11.6 Unit shall have lockable engine service door and keyed same as cab door(s). Hydraulic tank and fuel tank shall also be lockable.

3.1.11.7 Unit shall have a slow-moving vehicle safety triangle installed prior to delivery.

3.1.11.8 Unit shall have nonslip type mounting steps and safety handholds.

3.1.11.9 Unit shall have backhoe boom transport locks.

REQUEST FOR QUOTATION
Class 352 Four Wheel Drive John Deere 320 P-Tier Loader With Backhoe or
Equal

3.1.11.10 Unit shall have one (1) complete set of additional filter elements per unit shall be provided.

3.1.11.11 Unit must have Class 1 LED low profile rotating warning beacon.

3.1.11.12 Unit shall have left and right side and inside rear-view mirrors.

3.1.11.13 Unit shall have locking DEF and fuel covers.

3.1.11.14 Shall have heaviest duty front bumper available.

3.1.11.15 Shall have a factory AM/FM Bluetooth radio factory installed by the manufacturer at time of build.

3.1.11.16 Shall have the heaviest duty front bumper available.

3.1.12 LIGHTING

3.1.12.1 Unit shall have a minimum of four (4) front LED and four (4) rear LED work/driving lights switched and identified at operator's station.

3.1.12.2 Unit shall have two (2) combination stop/taillights.

3.1.12.3 Unit shall have two (2) side LED work lights and (1) one LED work light mounted to each side of the boom to illuminate where digging, switched and identified at operators' station.

3.1.12.4 Unit shall have two (2) front and two (2) rear turn and flashing lights.

3.1.12.5 Unit shall have Cab dome light.

3.1.12.6 Bulb swapping to LED will not be accepted.

3.1.13 TIRES

3.1.13.1 Tires shall be manufacturers recommended size radial for model bid.

REQUEST FOR QUOTATION
Class 352 Four Wheel Drive John Deere 320 P-Tier Loader With Backhoe or
Equal

3.1.14 VEHICLE FRAME

3.1.14.1 Unit shall feature a single piece weldment, full length unitized main frame.

3.1.15 LOADER

3.1.15.1 Loader shall be self-leveling with minimum 11 ft 3in full raised Bucket pin height.

3.1.15.2 Unit shall be equipped with automatic return-to-dig feature.

3.1.15.3 Unit shall provide a G.P. bucket rated at 1.3 C.Y. SAE minimum heaped capacity and a width of 92 inches minimum with bolt on cutting.

3.1.15.4 Unit shall have breakout force of 11,000 pounds minimum.

3.1.15.5 Unit shall have a loader lift rating of 7,000 pounds minimum to full height.

3.1.15.6 Unit shall have dumping clearance at full height 45 degrees, 105 inches minimum.

3.1.15.7 Bucket shall rollback at ground 35 degrees minimum.

3.1.16 BACKHOE

3.1.16.1 Unit shall have a digging depth of at least 15 feet minimum.

3.1.16.2 Backhoe lifting capacity shall be 3,500 pounds minimum to 8-foot lift height minimum through the full 180 degrees swing arc.

3.1.16.3 Shall have a backhoe bucket cylinder digging force of 14,000 pounds minimum.

3.1.16.4 Bucket shall be manufacturers 24 inches with hardened/replaceable teeth.

REQUEST FOR QUOTATION
Class 352 Four Wheel Drive John Deere 320 P-Tier Loader With Backhoe or
Equal

- 3.1.16.5** Shall have quick-coupling hydraulic couplers for tools, (i.e., road breakers, jack hammers, etc.) with multi brand tool coupler.
- 3.1.16.6** Unit shall be capable of operating backhoe and hydraulic tools simultaneously.
- 3.1.16.7** Unit shall have in-cab switchable "excavator to backhoe" control pattern change.
- 3.1.16.8** Unit shall have pilot operated backhoe controls.
- 3.1.16.9** Unit shall have flip over type rubber/steel cleated stabilizer pads.
- 3.1.16.10** Backhoe boom shall have a factory bolt on boom protection plate mounted to the underside of the backhoe boom.

3.1.17 OPERATING WEIGHT

- 3.1.17.1** Shall have an operating weight of 16,500 pounds minimum exclusive of tire ballast and/or counterweights.

3.1.18 PAINT

- 3.1.18.1** The loader shall be painted manufacturers standard.

3.1.19 Warranty

- 3.1.19.1** Unit bid shall have a minimum three-year 5000 hour parts and service warranty.

3.1.20 Operating and Service Manuals and Parts Lists:

- 3.1.20.1** An operator's manual must be included with each unit upon delivery. A "line sheet" (if applicable) and the "Equipment Preventative Maintenance Questionnaire", (Exhibit "B") must be with pilot unit upon delivery, Attn: JD Haller. There must be 12 service/shop/maintenance manuals and 14 parts manuals; USB storage drive is preferred in lieu of parts manuals. Manuals and USB storage drive shall be delivered upon completion of delivery

REQUEST FOR QUOTATION
Class 352 Four Wheel Drive John Deere 320 P-Tier Loader With Backhoe or
Equal

of total units. Failure to do so will delay payment.

3.1.21 Training:

3.1.21.1 Manufacturers and/or dealers will be required to stage a thorough seminar about Preventative Maintenance, Operator, and Mechanic training. To keep operators and mechanics updated, the successful vendor shall conduct a training session covering the operation, maintenance, troubleshooting with unit being purchased.

3.1.22 Preventative Maintenance & Operator Procedures:

3.1.22.1 Manufacturers and/or dealers will be required to submit to the Equipment Division, in addition to the operating and service manuals, booklets and pamphlets explaining the Preventative Maintenance and Operator Procedures to be used by the operators of this equipment, and must include such things as daily prestart inspection procedure, service schedule, and routine maintenance required, safety precautions, etc. The successful vendor shall furnish all training aids; i.e. videos, projectors as required in conducting the training.

4 CONTRACT AWARD:

4.1 Contract Award: The Contract is intended to provide Agencies with a purchase price for the Contract Items. The Contract shall be awarded to the Vendor that provides the Contract Items meeting the required specifications for the lowest overall total cost as shown on the Pricing Pages.

4.2 Pricing Page: Vendor should complete the Pricing Page (Exhibit A) by completing the Year, Make, Model, and inserting quoted unit price. Vendor should complete the Pricing Page in full as failure to complete the Pricing Page in its entirety may result in Vendor's bid being disqualified.

The Pricing Page contains a list of the Contract Items and purchase volume. The purchase volume for each item represents the approximate volume of anticipated purchases only. No future use of the Contract or any individual item is guaranteed or implied.

Vendor should electronically enter the information into the Pricing Page through WV OASIS, if available, or as an electronic document. In most cases, the Vendor can request an electronic copy of the Pricing Pages for bid purposes by sending an email request to the following address:

REQUEST FOR QUOTATION
Class 352 Four Wheel Drive John Deere 320 P-Tier Loader With Backhoe or
Equal

John.w.Estep@wv.gov

5 PAYMENT:

5.1 Payment: Vendor shall accept payment in accordance with the payment procedures of the State of West Virginia.

6 DELIVERY AND RETURN:

6.1 Delivery Time: A completed pilot model for inspection must be provided within 200 working day(s) after receipt of the pilot model order, by the successful vendor. Vendor shall deliver standard orders within 200 working days after orders are received Working day is defined as any week day, Monday thru Friday, excluding Federal and State Holidays. Vendor shall ship all orders until a minimum delivery quantity is met.

6.2 Late Delivery: The Agency placing the order under this Contract must be notified in writing if orders will be delayed for any reason. Any delay in delivery that could cause harm to an Agency will be grounds for cancellation of the delayed order, and/or obtaining the items ordered from a third party.

Any Agency seeking to obtain items from a third party under this provision must first obtain approval of the Purchasing Division.

6.3 Delivery Payment/Risk of Loss: Standard order delivery shall be F.O.B. Destination to the Agency's location. Vendor shall include the cost of standard order delivery charges in its bid pricing/discount and is not permitted to charge the Agency separately for such delivery. The Agency will pay delivery charges on all emergency orders provided that Vendor invoices those delivery costs as a separate charge with the original freight bill attached to the invoice.

6.4 Condition of Unit(s) Upon Delivery: All units must arrive at the prescribed delivery point having been completely pre-serviced with oil, lubricants, and coolant. All prescribed precautions pertaining to first operations and break-in of the unit are to be posted conspicuously on the unit for ready observance by the operator.

6.5 Delivery Point: Delivery point of the completed representative unit will be the WVDOH, Equipment Division, Rt. 33 and Brushy Fork Road, Buckhannon, WV 26201.

7. VENDOR DEFAULT:

REQUEST FOR QUOTATION
Class 352 Four Wheel Drive John Deere 320 P-Tier Loader With Backhoe or
Equal

7.1 The following shall be considered a vendor default under this Contract.

7.1.1 Failure to provide Contract Items in accordance with the requirements contained herein.

7.1.2 Failure to comply with other specifications and requirements contained herein.

7.1.3 Failure to comply with any laws, rules, and ordinances applicable to the Contract Services provided under this Contract.

7.1.4 Failure to remedy deficient performance upon request.

7.2 The following remedies shall be available to Agency upon default.

7.2.1 Immediate cancellation of the Contract.

7.2.2 Immediate cancellation of one or more release orders issued under this Contract.

7.2.3 Any other remedies available in law or equity.

8. MISCELLANEOUS:

8.1 No Substitutions: Vendor shall supply only Contract Items submitted in Response to the Solicitation unless a contract modification is approved in accordance with the provisions contained in this Contract.

REQUEST FOR QUOTATION
Class 352 Four Wheel Drive John Deere 320 P-Tier Loader With Backhoe or Equal

8.2 Reports: Vendor shall provide quarterly reports and annual summaries to the Agency showing the Agency's items purchased, quantities of items purchased, and total dollar value of the items purchased. Vendor shall also provide reports, upon request, showing the items purchased during the term of this Contract, the quantity purchased for each of those items, and the total value of purchases for each of those items. Failure to supply such reports may be grounds for cancellation of this Contract.

8.3 Contract Manager: During its performance of this Contract, Vendor must designate and maintain a primary contract manager responsible for overseeing Vendor's responsibilities under this Contract. The Contract manager must be available during normal business hours to address any customer service or other issues related to this Contract. Vendor should list its Contract manager and his or her contact information below.

Contract Manager: Donavan Bolland
Telephone Number: 240-446-1391
Fax Number: 856-697-4842
Email Address: donavanbolland@gtmidatlantic.com

INSTRUCTIONS TO VENDORS SUBMITTING BIDS

1. REVIEW DOCUMENTS THOROUGHLY: The attached documents contain a solicitation for bids. Please read these instructions and all documents attached in their entirety. These instructions provide critical information about requirements that if overlooked could lead to disqualification of a Vendor's bid. All bids must be submitted in accordance with the provisions contained in these instructions and the Solicitation. Failure to do so may result in disqualification of Vendor's bid.

2. MANDATORY TERMS: The Solicitation may contain mandatory provisions identified by the use of the words "must," "will," and "shall." Failure to comply with a mandatory term in the Solicitation will result in bid disqualification.

3. PREBID MEETING: The item identified below shall apply to this Solicitation.

A pre-bid meeting will not be held prior to bid opening

A MANDATORY PRE-BID meeting will be held at the following place and time:

WVDOH
Equipment Division
83 Brushy Fork Road Crossing
Buckhannon, WV 26201
* JUNE 1, 2023 @ 9:00 am *

All Vendors submitting a bid must attend the mandatory pre-bid meeting. Failure to attend the mandatory pre-bid meeting shall result in disqualification of the Vendor's bid. No one individual is permitted to represent more than one vendor at the pre-bid meeting. Any individual that does attempt to represent two or more vendors will be required to select one vendor to which the individual's attendance will be attributed. The vendors not selected will be deemed to have not attended the pre-bid meeting unless another individual attended on their behalf.

An attendance sheet provided at the pre-bid meeting shall serve as the official document verifying attendance. Any person attending the pre-bid meeting on behalf of a Vendor must list on the attendance sheet his or her name and the name of the Vendor he or she is representing.

Additionally, the person attending the pre-bid meeting should include the Vendor's E-Mail address, phone number, and Fax number on the attendance sheet. It is the Vendor's responsibility to locate the attendance sheet and provide the required information. Failure to complete the attendance sheet as required may result in disqualification of Vendor's bid.

All Vendors should arrive prior to the starting time for the pre-bid. Vendors who arrive after the starting time but prior to the end of the pre-bid will be permitted to sign in but are charged with knowing all matters discussed at the pre-bid.

Questions submitted at least five business days prior to a scheduled pre-bid will be discussed at the pre-bid meeting if possible. Any discussions or answers to questions at the pre-bid meeting are preliminary in nature and are non-binding. Official and binding answers to questions will be published in a written addendum to the Solicitation prior to bid opening.

4. VENDOR QUESTION DEADLINE: Vendors may submit questions relating to this Solicitation to the Purchasing Division. Questions must be submitted in writing. All questions must be submitted on or before the date listed below and to the address listed below to be considered. A written response will be published in a Solicitation addendum if a response is possible and appropriate. Non-written discussions, conversations, or questions and answers regarding this Solicitation are preliminary in nature and are nonbinding.

Submitted emails should have the solicitation number in the subject line.

Question Submission Deadline: June 8, 2023 by 10:00am

Submit Questions to: John Estep
2019 Washington Street, East
Charleston, WV 25305
Fax: (304) 558-3970
Email: john.w.estep@wv.gov

5. VERBAL COMMUNICATION: Any verbal communication between the Vendor and any State personnel is not binding, including verbal communication at the mandatory pre-bid conference. Only information issued in writing and added to the Solicitation by an official written addendum by the Purchasing Division is binding.

6. BID SUBMISSION: All bids must be submitted on or before the date and time of the bid opening listed in section 7 below. Vendors can submit bids electronically through wvOASIS, in paper form delivered to the Purchasing Division at the address listed below either in person or by courier, or in facsimile form by faxing to the Purchasing Division at the number listed below. Notwithstanding the foregoing, the Purchasing Division may prohibit the submission of bids electronically through wvOASIS at its sole discretion. Such a prohibition will be contained and communicated in the wvOASIS system resulting in the Vendor's inability to submit bids through wvOASIS. The Purchasing Division will not accept bids, modification of bids, or addendum acknowledgment forms via email. Bids submitted in paper or facsimile form must contain a signature. Bids submitted in wvOASIS are deemed to be electronically signed.

Any bid received by the Purchasing Division staff is considered to be in the possession of the Purchasing Division and will not be returned for any reason.

For Request for Proposal ("RFP") Responses Only: Submission of a response to a Request for Proposal is not permitted in wvOASIS. In the event that Vendor is responding to a request for proposal, the Vendor shall submit one original technical and one original cost proposal prior to the bid opening date and time identified in Section 7 below, plus _____ convenience copies of each to the Purchasing Division at the address shown below. Additionally, the Vendor should clearly identify and segregate the cost proposal from the technical proposal in a separately sealed envelope.

Bid Delivery Address and Fax Number:
Department of Administration, Purchasing Division
2019 Washington Street East
Charleston, WV 25305-0130
Fax: 304-558-3970

A bid submitted in paper or facsimile form should contain the information listed below on the face of the submission envelope or fax cover sheet. Otherwise, the bid may be rejected by the Purchasing Division.

VENDOR NAME:
BUYER: JOHN ESTEP
SOLICITATION NO.: CRFQ 0803 DOT2300000135
BID OPENING DATE: June 14, 2023
BID OPENING TIME: 1:30 PM
FAX NUMBER: 304-558-3970

7. BID OPENING: Bids submitted in response to this Solicitation will be opened at the location identified below on the date and time listed below. Delivery of a bid after the bid opening date and time will result in bid disqualification. For purposes of this Solicitation, a bid is considered delivered when confirmation of delivery is provided by wvOASIS (in the case of electronic submission) or when the bid is time stamped by the official Purchasing Division time clock (in the case of hand delivery).

Bid Opening Date and Time: June 14, 2023 @ 1:30 pm

Bid Opening Location: Department of Administration, Purchasing Division
2019 Washington Street East
Charleston, WV 25305-0130

8. ADDENDUM ACKNOWLEDGEMENT: Changes or revisions to this Solicitation will be made by an official written addendum issued by the Purchasing Division. Vendor should acknowledge receipt of all addenda issued with this Solicitation by completing an Addendum Acknowledgment Form, a copy of which is included herewith. Failure to acknowledge addenda may result in bid disqualification. The addendum acknowledgement should be submitted with the bid to expedite document processing.

9. BID FORMATTING: Vendor should type or electronically enter the information onto its bid to prevent errors in the evaluation. Failure to type or electronically enter the information may result in bid disqualification.

10. ALTERNATE MODEL OR BRAND: Unless the box below is checked, any model, brand, or specification listed in this Solicitation establishes the acceptable level of quality only and is not intended to reflect a preference for, or in any way favor, a particular brand or vendor. Vendors may bid alternates to a listed model or brand provided that the alternate is at least equal to the model or brand and complies with the required specifications. The equality of any alternate being bid shall be determined by the State at its sole discretion. Any Vendor bidding an alternate model or brand should clearly identify the alternate items in its bid and should include manufacturer's specifications, industry literature, and/or any other relevant documentation demonstrating the equality of the alternate items. Failure to provide information for alternate items may be grounds for rejection of a Vendor's bid.

This Solicitation is based upon a standardized commodity established under W. Va. Code § 5A-3-61. Vendors are expected to bid the standardized commodity identified. Failure to bid the standardized commodity will result in your firm's bid being rejected.

11. EXCEPTIONS AND CLARIFICATIONS: The Solicitation contains the specifications that shall form the basis of a contractual agreement. Vendor shall clearly mark any exceptions, clarifications, or other proposed modifications in its bid. Exceptions to, clarifications of, or modifications of a requirement or term and condition of the Solicitation may result in bid disqualification.

12. COMMUNICATION LIMITATIONS: In accordance with West Virginia Code of State Rules §148-1-6.6, communication with the State of West Virginia or any of its employees regarding this Solicitation during the solicitation, bid, evaluation or award periods, except through the Purchasing Division, is strictly prohibited without prior Purchasing Division approval. Purchasing Division approval for such communication is implied for all agency delegated and exempt purchases.

13. REGISTRATION: Prior to Contract award, the apparent successful Vendor must be properly registered with the West Virginia Purchasing Division and must have paid the \$125 fee, if applicable.

14. UNIT PRICE: Unit prices shall prevail in cases of a discrepancy in the Vendor's bid.

15. PREFERENCE: Vendor Preference may be requested in purchases of motor vehicles or construction and maintenance equipment and machinery used in highway and other infrastructure projects. Any request for preference must be submitted in writing with the bid, must specifically identify the preference requested with reference to the applicable subsection of West Virginia Code § 5A-3-37, and must include with the bid any information necessary to evaluate and confirm the applicability of the requested preference. A request form to help facilitate the request can be found at: www.state.wv.us/admin/purchase/vrc/Venpref.pdf.

15A. RECIPROCAL PREFERENCE: The State of West Virginia applies a reciprocal preference to all solicitations for commodities and printing in accordance with W. Va. Code § 5A-3-37(b). In effect, non-resident vendors receiving a preference in their home states, will see that same preference granted to West Virginia resident vendors bidding against them in West Virginia. Any request for reciprocal preference must include with the bid any information necessary to evaluate and confirm the applicability of the preference. A request form to help facilitate the request can be found at: www.state.wv.us/admin/purchase/vrc/Venpref.pdf.

16. SMALL, WOMEN-OWNED, OR MINORITY-OWNED BUSINESSES: For any solicitations publicly advertised for bid, in accordance with West Virginia Code §5A-3-37 and W. Va. CSR § 148-22-9, any non-resident vendor certified as a small, women-owned, or minority-owned business under W. Va. CSR § 148-22-9 shall be provided the same preference made available to any resident vendor. Any non-resident small, women-owned, or minority-owned business must identify itself as such in writing, must submit that writing to the Purchasing Division with its bid, and must be properly certified under W. Va. CSR § 148-22-9 prior to contract award to receive the preferences made available to resident vendors. Preference for a non-resident small, women-owned, or minority owned business shall be applied in accordance with W. Va. CSR § 148-22-9.

17. WAIVER OF MINOR IRREGULARITIES: The Director reserves the right to waive minor irregularities in bids or specifications in accordance with West Virginia Code of State Rules § 148-1-4.6.

18. ELECTRONIC FILE ACCESS RESTRICTIONS: Vendor must ensure that its submission in wvOASIS can be accessed and viewed by the Purchasing Division staff immediately upon bid opening. The Purchasing Division will consider any file that cannot be immediately accessed and viewed at the time of the bid opening (such as, encrypted files, password protected files, or incompatible files) to be blank or incomplete as context requires and are therefore unacceptable. A vendor will not be permitted to unencrypt files, remove password protections, or resubmit documents after bid opening to make a file viewable if those documents are required with the bid. A Vendor may be required to provide document passwords or remove access restrictions to allow the Purchasing Division to print or electronically save documents provided that those documents are viewable by the Purchasing Division prior to obtaining the password or removing the access restriction.

19. NON-RESPONSIBLE: The Purchasing Division Director reserves the right to reject the bid of any vendor as Non-Responsible in accordance with W. Va. Code of State Rules § 148-1-5.3, when the Director determines that the vendor submitting the bid does not have the capability to fully perform or lacks the integrity and reliability to assure good-faith performance."

20. ACCEPTANCE/REJECTION: The State may accept or reject any bid in whole, or in part in accordance with W. Va. Code of State Rules § 148-1-4.5. and § 148-1-6.4.b."

21. YOUR SUBMISSION IS A PUBLIC DOCUMENT: Vendor's entire response to the Solicitation and the resulting Contract are public documents. As public documents, they will be disclosed to the public following the bid/proposal opening or award of the contract, as required by the competitive bidding laws of West Virginia Code §§ 5A-3-1 et seq., 5-22-1 et seq., and 5G-1-1 et seq. and the Freedom of Information Act West Virginia Code §§ 29B-1-1 et seq.

DO NOT SUBMIT MATERIAL YOU CONSIDER TO BE CONFIDENTIAL, A TRADE SECRET, OR OTHERWISE NOT SUBJECT TO PUBLIC DISCLOSURE.

Submission of any bid, proposal, or other document to the Purchasing Division constitutes your explicit consent to the subsequent public disclosure of the bid, proposal, or document. The Purchasing Division will disclose any document labeled "confidential," "proprietary," "trade secret," "private," or labeled with any other claim against public disclosure of the documents, to include any "trade secrets" as defined by West Virginia Code § 47-22-1 et seq. All submissions are subject to public disclosure without notice.

22. WITH THE BID REQUIREMENTS: In instances where these specifications require documentation or other information with the bid, and a vendor fails to provide it with the bid, the Director of the Purchasing Division reserves the right to request those items after bid opening and prior to contract award pursuant to the authority to waive minor irregularities in bids or specifications under W. Va. CSR § 148-1-4.6. This authority does not apply to instances where state law mandates receipt with the bid.

23. EMAIL NOTIFICATION OF AWARD: The Purchasing Division will attempt to provide bidders with e-mail notification of contract award when a solicitation that the bidder participated in has been awarded. For notification purposes, bidders must provide the Purchasing Division with a valid email address in the bid response. Bidders may also monitor wOASIS or the Purchasing Division's website to determine when a contract has been awarded.

24. ISRAEL BOYCOTT CERTIFICATION: Vendor's act of submitting a bid in response to this solicitation shall be deemed a certification from bidder to the State that bidder is not currently engaged in, and will not for the duration of the contract, engage in a boycott of Israel. This certification is required by W. Va. Code § 5A-3-63.