

*matt.cochran@thetruckpeople.com*

**Vendor:** *Worldwide Equip* **Contact Name:** *Matt Cochran* **Email:** \_\_\_\_\_ **Phone:** *304-345-2490*

Item No.	Description:	Make/Model & Year	Estimated Unit Quantity	Unit Price	Item Total Cost
1	Complete Unit: Cab Chassis/Dump Body w/Hyd. System w/Front snow plow & 9.5 V-box spreader	<i>2018 Mack GU713 J&amp;J Body</i>	120	<i>\$ 229,774<sup>00</sup></i>	<i>\$ 27,572,880<sup>00</sup></i>
2	Complete Unit: Cab Chassis/Dump Body w/Hyd. System, w/Front snow plow & 9.5 V-box spreader, & Right front wing plow	<i>2018 Mack GU713 J&amp;J Body</i>	50	<i>\$ 244,357<sup>00</sup></i>	<i>\$ 12,217,850<sup>00</sup></i>
3	Anti-Icing Tank & Spray System	<i>J &amp; J</i>	50	<i>\$ 22,031<sup>00</sup></i>	<i>\$ 1,101,550<sup>00</sup></i>
<b>Total Bid Cost</b>					<i>\$ 40,892,280<sup>00</sup></i>

**Bid will be awarded to the lowest overall bid total for all items**

**All item numbers shall be available to purchase separately on as needed basis**

08/15/17 13:02:59  
PURCHASING DIVISION



# WORLDWIDE EQUIPMENT ENTERPRISES, INC.

## HUNTINGTON DIVISION

8/15/17

### DIVISIONS & SUBSIDIARIES

#### KENTUCKY

Lexington  
Middlesboro  
Prestonsburg  
Somerset

#### WEST VIRGINIA

Charleston  
Huntington  
Jane Lew  
Princeton

#### VIRGINIA

Abingdon

#### TENNESSEE

Chattanooga  
Knoxville

#### OHIO

Cincinnati  
Dayton

#### SOUTH CAROLINA

Columbia  
Greenville  
Charleston

WORLDWIDE  
EQUIPMENT  
LEASING, INC.

WORLDWIDE  
FABRICATING  
&  
MANUFACTURING

WV DOH/DOT:

As a result of the below mentioned requests for bid, Mack Trucks, Inc. will pass on the following price increase to Worldwide Equipment for the WV DOH/DOT Bid:

Please note below the reference control numbers, price book, and net dealer invoice price (as spec'd today) that this contract will be based off of:

2018 calendar year increases will occur for orders placed on or after October 1, 2018 (Contract extension period 1), and will be a 2% increase from 2017 reference prices.

2019 calendar year increases will occur for orders placed on or after October 1, 2019 (Contract Extension Period 2), and will be a 4% increase from 2017 reference prices.

2020 Calendar year increases will occur for orders placed on or after October 1, 2020 (Contract Extension Period 3), and will be a 6% increase from 2017 reference prices.

Terms and Conditions:

- Any other models that you may purchase under this contract will be subject to separate price negotiations.
- Any spec changes related to material shortages or surcharges by suppliers are excluded from the pricing agreement. Any changes made by Allison Transmissions will be borne by customer.
- Any changes to freight announced by Mack during course of this agreement will be added or subtracted to the invoice with accordance with the announcement.
- Any spec changes made by the customer will be added or subtracted from the price of the truck. The price adjustment will be the difference between the invoice price of the option to be deleted from the current spec and the current price of the option to be added to the spec.
- Any spec changes resulting from additional EPA regulations or Government mandates will be added or subtracted from the price of the truck. Specifically for the 2018 model year, EPA Greenhouse Gas 2017 regulations come into effect which may impact vehicle pricing will be borne by the customer.
- All price changes are exclusive of FRET. Any additional FRET resulting from model year increase or any other pricing change will be borne by the customer. Model year increases noted on page one are pre-FRET, Mack to dealer numbers.

P.O. BOX 5407 • 5650 US ROUTE 60 EAST • HUNTINGTON, WEST VIRGINIA 25703  
OFFICE (304) 736-3401 • FAX (304) 736-7539  
WWW.THETRUCKPEOPLE.COM



**WORLDWIDE  
EQUIPMENT**  
**THE TRUCK PEOPLE**



Date 8/14/2017

**In Progress**

Quote no. WE2017000095C533

Your ref.

WV DOH EQUIPMENT DIV  
BRUSH FORK RD  
BUCKHANNON 26201  
WV

**Technical Specification**

**GU713 R - 6x4 DAYCAB**      17825      lb

**CUSTOMER/VEHICLE INFO**

**Weight F/R**

2018 MODEL YEAR

AMBIENT TEMPERATURE HOT. WARMER THAN 104 F (40 C) ALLOWED UP  
TO 25 HOURS PER YEAR

GRADES <3% GREATER THAN 98% OF DRIVING DISTANCE MAX GRADE 8%

2018B Pricebook

GU713 R - 6x4 DAYCAB      5144 / 1903 lb

MUNICIPAL

ALL 50 STATES, CARB ENGINE EMISSION (US17)

WELL MAINTAINED SURFACED ROADS >95% DRIVING DISTANCE

SNOW PLOW TRUCK

100,000 LB (45 TONNES) GROSS COMBINATION WEIGHT

ON-OFF HIGHWAY, STARTING GRADES<18%

CONCRETE LOADING AND / OR UNLOADING SURFACE

CONSTRUCTION SERVICE

**ENGINE/TRANSMISSIONS**

**Weight F/R**

MP8-455M MACK 455HP @ 1500-1900 RPM (PEAK) 2100 RPM (GOV) 1760      2165 / 541 lb  
LB-FT, US'17

4500 RDS 6 SP-ALLISON RUGGED DUTY SERIES GEN 5      732 / 245 lb

W/PROGNOSTICS

ALLISON VOC PKG# 146 RDS ON-OFF HWY BASIC

ENGINE GOVERNOR TYPE MIN-MAX

BASIC, GEAR-SELECTION TUNING

**EXHAUST/EMISSIONS**

**Weight F/R**

IDLE EMISSION CERTIFICATION - CARB 08 (WITH DECAL LOCATED ON  
LOWER LH CORNER OF DRIVER DOOR

DPF COVER, STAINLESS STEEL

CLEARTECH ONE BOX E.A.T.S. RH SIDE UNDER CAB US17

9' 6" FROM GROUND

SINGLE VERTICAL RIGHT SIDE CAB MOUNTED, LOWER VENTURI      -46 / -2 lb

DIFFUSER, TURNED END

EXHAUST HEAT SHIELD

6.6 GALLON (25 L) 22" INTEGRAL TO LH FUEL TANK

SINGLE, BRIGHT FINISH HEAT SHIELD, STACK AND SCR COVER (IF

EQUIPPED)  
EMISSION OBD, DISPLAY ONLY, USA2016

**ENGINE EQUIPMENT**

Weight F/R

11" x 30" (279 mm x 762 mm) UNDER HOOD SINGLE ELEMENT DRY TYPE  
W/AIR INTAKE FROM BOTH SIDES OF HOOD  
INSIDE/OUTSIDE AIR INTAKE W/IN-CAB CONTROL FOR SNOWPLOWS 20 / 0 lb  
STAINLESS STEEL MOUNTED BEHIND GRILLE, BUG/DEBRIS SCREEN  
MERITOR/WABCO 318 18.7 CFM  
STANDARD FUEL FILTER POSITION  
DELCO 12V 130A (24SI) BRUSH-TYPE 16 / 0 lb  
(2) MACK 12V 800 CCA THREADED STUD TYPE AGM LONG LIFE 40 / 12 lb  
TEXACO EXTD LIFE COOLANT #7998 W/NITRITES (50/50 MIX) TO -34 DEG  
SPIN ON CANISTER W/O CHEMICAL FOR USE W/TEXACO EXTENDED LIFE  
COOLANT ONLY  
BEHR FAN WITH BEHR ELECTRONICALLY MODULATED FAN DRIVE  
MACK MP8 POWERLEASH  
MACK W/MANUAL DRAIN VALVE (INTEGRAL W/PRIMARY FUEL FILTER)  
(3) BATTERY MAX, MTD LHS UNDER CAB, FWD OF LH FUEL TANK  
-8 / -4 lb  
MOLDED PLASTIC BATTERY BOX COVER  
SILICONE RADIATOR & HEATER HOSES W/BREEZE CONSTANT TORQUE 3 / 0  
lb  
CLAMPS ON ALL COOLANT LINES  
12 VOLT DELCO 39MT-MXT STARTER  
OIL PAN STAINLESS STEEL OR COMPOSITE MATERIAL  
120V 1500 WATT ENGINE BLOCK HEATER 5 / 0 lb  
VEHICLE AND TRAILER (IF APPLICABLE) STOP LAMPS ACTIVATE UPON  
SERVICE BRAKE APPLICATION ONLY(3899000)

**CLUTCH/TRANS EQUIPMENT**

Weight F/R

ALLISON DASH MTD SHIFTER W/NEUTRAL TO RANGE INHIBIT (HD SERIES)  
MERITOR 18 MXL "XTENDED LUBE" 3 / 3 lb  
TRANSYND SYNTHETIC LUBE FOR ALLISON TRANS  
FURNISH FOR ALLISON TRANS. W/DIRECT MOUNT COOLER & STAINLESS STEEL  
COOLANT TUBES  
PROPELLER SHAFT MAIN, UNIVERSAL JOINT HALF-ROUND TYPE  
MERITOR 17 MXL "XTENDED LUBE"  
FURNISH TC541 FOR USE W/ALLISON (HD) SERIES WORLD  
TRANSMISSION

**FRONT AXLE EQUIPMENT**

Weight F/R

20000# (9072kg) MACK FXL20 WIDE PIVOT CENTER STRAIGHT 428 / 0 lb  
SPINDLE/UNITIZED BEARINGS  
MACK TAPERLEAF 20000# (9072kg) GROUND LOAD RATING 27 / 0 lb  
BENDIX NEXT GENERATION DRUM, HEAVY DUTY 16.5 X 6 (9.65mm thick) 34 / 0 lb  
CAST IRON BRAKEDRUM, FRONT AXLE  
FRONT BRAKE CHAMBER MANUFACTURER, MGM  
HALDEX - AUTOMATIC  
STANDARD F.A. SPINDLE NUTS  
FAG SCHAEFFLER, FRONT GREASE SEAL  
EATON ES-1100/600 BRAKE LINING  
FERROUS HUBS 157 / 0 lb  
DOUBLE ACTING TYPE  
SHEPPARD SD110 + HD94 DUAL GEAR POWER STEERING 206 / 0 lb  
PETROLEUM/SYNTHETIC (50/50) OIL FRONT AXLE



FRONT BRAKE CHAMBER 24SQ INCHES (SERVICE)  
BRAKE REGULATION, STOPPING DISTANCE 94M (310FT)

**REAR AXLE EQUIPMENT**

**Weight F/R**  
44000# (19958kg) MACK S440 (268 1004) FABRICATED STEEL HOUSING 0 / 1445 lb  
CRDP150/151  
4.19 RATIO  
SS440 MACK MULTILEAF (CAMELBACK) 44000# - STANDARD SPRING 0 / 1921 lb  
THICKNESS  
BRONZE TRUNION BUSHING 0 / 20 lb  
50" AXLE SPACING (BOGIE WHEELBASE)  
TRANSVERSE TORQUE ROD (REAR AXLE ONLY)  
BENDIX NEXT GENERATION DRUM, HEAVY DUTY 16.5 X 7 (9.65mm thick) 0 / 14 lb  
CAST IRON BRAKE DRUMS  
HALDEX – AUTOMATIC SLACK ADJUSTERS  
REAR SPRING BRAKE CHAMBERS 30/30 TYPE  
BENDIX EES-600 BRAKE LINING  
IRON PRESET REAR HUB W/INTEGRATED SPINDLE NUT 0 / 318 lb  
PREMIUM HUB OIL REAR SEAL  
POWER DIVIDER LOCKOUT, W/BUZZER & LIGHT 0 / 40 lb  
FACTORY OPTION LUBE - REAR AXLE  
RUBBER SHOCK INSULATORS  
MGM TR-T (TAMPER RESISTANT BRAKE CHAMBERS) RECLOCK INLET  
PORTS FOR OPTIMUM GROUND CLEARANCE  
SPINDLE NUTS, MAIN AXLE, INTERGRATED  
4S/4M SYSTEM REAR WHEEL END SENSORS

**FRAME EQUIPMENT/FUEL TANKS**

**Weight F/R**  
210" WHEELBASE 56 / 56 lb  
63" AFTERFRAME -11 / 195 lb  
STEEL - 300MM X 90MM X 9.5MM -- (11.81" X 3.54" X 0.37" ) 2,820,000 RBM  
Bumper Position Extended 20" (snow) 102 / -11 lb  
BASIC FUEL LEVEL SENDER MOUNTED ON L.H TANK  
FURNISH STANDARD STEEL CLOSING REAR CROSSMEMBER  
EXTENDED-SWEPT BACK-STEEL BUMPER  
BOC AND INTERMEDIATE(S) STEEL HD BACK-TO-BACK CHANNEL  
FRONT TOW HOOKS  
111 GALLON (420 L) 22" ALUMINUM, SLEEVED D-SHAPED 100 / 45 lb  
BRAIDED HOSE 5 / 3 lb  
NON-LOCKABLE FUEL TANK CAP  
STANDARD FINISH STEPS AND BRIGHT FINISH STRAPS

**AIR/BRAKE**

**Weight F/R**  
WABCO AIR DR, 1200UP W/ T CUT OFF VALVE, W COALESC OIL FILTER,  
HEATED  
MANUAL (PETCOCK) DRAIN VALVES ON ALL TANKS  
ALUMINUM, STANDARD FINISH -24 / 0 lb  
W/O PARK BRAKE ALARM  
TWO (2) VALVE DUAL BRAKE SYSTEM - TRAILER SUPPLY AND  
TRACTOR-TRAILER PARK

**ELECTRICAL**

**Weight F/R**  
CHASSIS & POWER HARNESS WITH HEAVY DUTY CASING  
DASH CTRL/PWR SUPPLY/LOCAL INST PLOW LAMPS W/LEAD FURN@

GRILL W/2W/3W WEATHER PACK CON  
FURNISH STANDARD TAIL-LIGHTS  
SIX (6) ASSIGNABLE BODYBUILDER DASH SWITCHES (5 ON-OFF, 1  
MOMENTARY)  
PARK BRAKE AND ENGINE RUNNING ACTIVATED

#### TRAILER CONNECTIONS

##### Weight F/R

GLAD HAND COUPLINGS - NORTH AMERICAN STD  
TRLR BRAKE VALVE, ELECTRONIC TRAILER BRAKE CONTROLLER  
TRAILER AIR BRAKE CONNECTIONS, END OF FRAME 23 / 23 lb  
DUAL 7 PINS STD SAE TYPE, EOF (1) FOR TRLR W/ELEC BRAKES, (1) FOR  
TRLR W/AIR BRAKES

#### PTO/SPECIALTY EQUIPMENT

##### Weight F/R

TRANSMISSION PTO SWITCH AND LIGHT WITH WIRING AND PIPING FOR 3 / 0  
lb  
LOCAL INSTALLATION  
PTO TRANSM BOTH SIDES, FREE SPACE, PTO W PUMP INTEGRATED  
BODY LINK III W/CAB PASS-THRU

#### CAB (A THRU G)

##### Weight F/R

Day Cab (No Sleeper)  
FENDER EXTENSIONS 5 / 0 lb  
(4) DOME LAMPS - DOOR AND SWITCH ACTIVATED  
CIGAR LIGHTER  
ASHTRAY  
U.S. UNITS (PREDOMINANT)  
STD PKG + ENG OIL TEMP, TRANSM OIL TEMP & EXH PYROMETER  
POLYURETHANE FLOOR MAT  
HEATED TINTED WINDSHIELD ONLY, TINTED SIDE AND REAR WINDOW  
BF EXTERIOR CAB GRAB HANDLES, BL GRAB HANDLE RH INTERIOR  
WINDSHIELD POST  
BRIGHT FINISH GRILLE W/O SURROUND RADIATOR MOUNTED  
BLEND AIR HVAC W/"ATC" TEMP REGULATION & APADS  
3 / 0 lb  
5LB (ABC RATED) MOUNTED BETWEEN DRIVER SEAT BASE AND DOOR 12 / 0 lb  
VALVE AIMED REARWARD  
HARD MOLDED STORAGE UNIT DRIVERS & RIDERS DOORS  
SPEAKER LOCATION, BEHIND DOORS, MIDDLE HIGH SIDE PANEL  
PEEP WINDOW ON RIGHT SIDE NON STG WHL POS. DEPEND

#### CAB (H THRU R)

##### Weight F/R

HOOD INSULATION  
REAR CAB SUSPENSION, AIR  
48" ANTENNA RIGHT SIDE MIRROR MOUNTED  
(2) STORAGE COMPARTMENTS AND NET RETAINERS W/CENTER  
MOUNTING FOR CB PROVISIONS  
REAR WINDOW (FIXED TYPE)  
VINYL COVERED FOAM PADDED HEADLINER  
PAINTED HOOD LATCHES  
CO-PILOT DRIVER DISPLAY, ENHANCED 4.5" DIAGONAL LCD DISPLAY  
W/4-BUTTON STALK CONTROL  
PEDIGREE SLATE GRAY

(1) MACK RECTANGULAR SINGLE TRUMPET -6 / -2 lb  
 48" ANTENNA LEFT SIDE MIRROR MOUNTED  
 SINGLE TONE  
 (5) TRUCKLITE LED CHROME BULLET TYPE LAMPS 3 / 0 lb  
 CB RADIO MOUNTING REINFORCEMENT IN HEADER CONSOLE  
 CHASSIS KEYED AT RANDOM - 2 KEYS  
 HADLEY/KAM 4-WAY W/CHROME SHELL RH/LH BOTH MOTORIZED AND 3 / 0 lb  
 HEATED  
 BRIGHT FINISH, LH & RH 8" DIA. HEATED CONVEX 3 / 0 lb  
 RECT CONVEX ABOVE RH DOOR WINDOW 3 / 0 lb  
 AM/FM PREMIUM STEREO, CD-PLAYER, MP3, WEATHERBAND,  
 HANDSFREE INTERFACE, BLUETOOTH  
 POWER LEADS (5-WAY BINDING POSTS FOR CB RADIO) IN HEADER  
 CONSOLE  
 STORAGE POUCH REAR  
 BRUSHED NICKEL DASH PANELS  
 HEATED MIRROR TIME-OUT, 60 MIN  
 REFLECTOR KIT FURNISH KIT PARALLEL TO INSIDE SURFACE OF 12 / 5 lb  
 RIDERS SEAT BASE

**CAB (S THRU Z)**

**Weight F/R**

POWER WINDOW LIFT WITH ELECTRIC DOOR LOCK, LH & RH 14 / 0 lb  
 KEY TYPE  
 TWO SPEED ELECTRIC MOTOR W/INTERMITTENT FEATURE & ARCTIC  
 WIPER BLADES  
 AIR-NATIONAL 2000 (HIGH-BACK) SINGLE CHAMBER AIR LUMBAR, 2 5 / 3 lb  
 POSITION FRONT CUSHION ADJ.  
 INBOARD MOUNTED ARM REST, DRIVER'S & RIDER'S SEAT 5 / 3 lb  
 NATIONAL 2000 (HI-BACK), SINGLE CHAMBER AIR LUMBAR, 2 POS FRONT 29 /  
 18 lb  
 CUSHION ADJ. AIR-SUSPENSION  
 CLOTH, BLACK COLOR, DRIVER & RIDER SEATS  
 LAP & SHOULDER (BOTH SEATS) CAB MTD SHOULDER BELT ADJUSTMT  
 SELF CANCELLING TURN SIGNALS  
 2 SPOKE URETHANE GRIP, CHARCOAL SPOKES, W/O SWITCHES  
 SUN VISOR - BOTH SIDES

**WHEELS & TIRES**

**Weight F/R**

BASIC ROLLING RESISTANCE  
 TWO FRONT TIRES & WHEELS  
 EIGHT REAR AXLE TIRES & WHEELS  
 315/80R22.5 L BRIDGESTONE M860A (ALL POSITIONS) 322 / 0 lb  
 TIRE SPEED LIMIT BASIC  
 22.5x9.00 ALCOA ULTRA ONE ALUM DISC 10-HP; 11.25" BC, 5.96"INSET 111 / 0 lb  
 MACHINE CLEAN BUFFED-ALL WHEELS  
 11R22.5 H BRIDGESTONE M799 (DRIVE ONLY) 0 / 988 lb  
 22.5x8.25 ALCOA LVL ONE ALUM DISC 10-HOLE HUB PILOTED (11 1/4"  
 286mm BOLT CIRCLE)  
 WHEEL NUT BASIC FINISH, REAR  
 MACHINE CLEAN BUFFED - ALL WHEELS  
 WHEEL STUDS BASIC LENGTH  
 PROTECTIVE NYLON SPACER BETWEEN DISCS WHEEL TO DRUM 0 / 3 lb  
 FURNISH PROTECTIVE NYLON SPACER BETWEEN DISCS & WHEEL TO 0 / 3 lb  
 DRUM

**COMMUNICATION SYSTEMS**

**Weight F/R**  
GUARDDOG CONNECT WITH 4G/LTE AND WLAN SYSTEM WITH  
DIAGNOSTIC SERVICES  
REMOTE SOFTWARE UPGRADE ENABLED

**VEHICLE ELECTRONICS**

**Weight F/R**  
ENG TORQUE LIMITED TO 50%, IF SPEED SENSOR TAMPER DETECTED  
ENGINE IDLE SHUTDOWN TIME OVERRIDDEN IF PTO ACTIVE  
30 SEC IDLE S/D WARNING TIME  
ENGINE IDLE COOLDOWN, DISABLE  
ELECTRONIC HAND THROTTLE, MAX ROAD SPEED, 16 KMH (10 MPH)  
ELECTRONIC HAND THROTTLE, MIN ENGINE SPEED, 700 RPM  
ELECTRONIC HAND THROTTLE, MAX ENGINE SPEED, 2100 RPM  
ELECTRONIC HAND THROTTLE, SPEED RAMP RATE, 100 RPM/SEC  
IDLE SHUTDOWN TIME 10 MIN.  
MIN CRUISE, 32 KPH (20 MPH)  
ENG BRK ENGAGE IN CRUISE, 3 MPH, ABOVE SET SPEED  
PTO 1ST, SINGLE SPEED SETTING, 1000 RPM  
1ST PTO, MAX ROAD SPEED, 10 MPH (16 KPH)  
PTO 1ST, SPEED RAMP RATE 100 RPM/SEC  
PTO 1ST, MAX ENGINE SPEED, 2100 RPM  
PTO 1ST, ROAD SPEED LIMIT, 97 KMH (60 MPH)  
PTO 1ST, MINIMUM ENGINE SPEED, 600 RPM  
PTO 1ST, AUTO SET SINGLE SPEED, DISABLE  
ENGINE IDLE DELAY TO START LOG, 2 MIN  
ENGINE OVERSPEED, FUELED, TIME LOG IF ABOVE 2100 RPM  
VEHICLE OVERSPEED, FUELED, TIME LOG IF ABOVE 70MPH (113KMH)  
ENGINE IDLE SHUTDOWN, DISABLE  
VEHICLE OVERSPEED, ALL COND, TIME LOG IF ABOVE 75MPH (121KMH)  
ENGINE OVERSPEED, ALL CONDITIONS, TIME LOG IF ABOVE 2200 RPM  
PTO 2ND, MINIMUM ENGINE SPEED, 600 RPM  
PTO 2ND, SPEED RAMP RATE 100 RPM/SEC  
2ND PTO, MAX ROAD SPEED, 10 MPH (16 KPH)  
PTO 2ND, AUTO SET SINGLE SPEED, DISABLE  
PTO 2ND, ROAD SPEED LIMIT, 97 KMH (60 MPH)  
PTO2 SINGLE SPEED SETTING, 1000 RPM  
PTO 2ND, MAX ENGINE SPEED, 2100 RPM  
105 KM/HOUR ROAD SPEED LIMITER(65 MILES/HOUR)  
MAX CRUISE, 105 KPH (65 MPH)  
ENGINE PROTECTION (SHUTDOWN)  
IDLE CONTROL, 650 RPM  
COOLANT TEMP, ENGINE SHUTDOWN  
OIL PRESSURE, ENGINE SHUTDOWN  
5 MIN. WARM UP TIME DELAY  
38C DEG (100F), WARM UP TEMP DELAY  
ENG IDLE SHUTDOWN TIME OVERRIDDEN IF TORQUE > THAN LIMIT  
DETECTION OF SPEED SENSOR TAMPERING, ENABLE  
WITH CRUISE CONTROL  
AMBIENT TEMP MIN TRESHOLD, 16 DEG C, (60 DEG F)  
AMBIENT TEMP MAX TRESHOLD, 27 DEG C, (80 DEG F)  
DISABLE POWER DIVIDER LOCK OUT (PDLO) ROAD SPEED LIMIT  
POWER DIVIDER LOCK OUT (PDLO) ROAD SPEED LIMIT 8KMH (5MPH)  
IDLE SHUTDOWN ABS TAMPER CHECK, ENABLED  
IDLE SHUTDOWN OVERRIDE UPTO 20% ENGINE LOAD THRESHOLD

ENGINE HIGH IDLE SPEED IN UPPER GEARS, DISABLED  
105 KM/H PEDAL ROAD SPEED LIMITER (65MPH)

**PAINT**

Weight F/R  
SINGLE COLOR  
YELLOW; F9885  
PAINT - CAB, URETHANE CLEAR COAT  
SAME AS FIRST COLOR - CAB  
SAME AS FIRST COLOR- HOOD  
FRAME MACK BLACK (URETHANE)  
PAINT BUMPER SAME COLOR AS CHASSIS RUNNING GEAR

**BASE WARRANTY & PURCHASED COVERAGES**

Weight F/R  
US - WARRANTY REGISTRATION LOCATION  
60 MNTH - GUARDDOG CONNECT WITH MACK OTA  
24 MNTH - ASIST AND MACK ONECALL  
HEAVY DUTY WARRANTY CLASSIFICATION  
HEAVY DUTY STANDARD BASE COVERAGE 12 MONTHS  
ENG PLAN 2: 60 MO/250K MI-EXT ENGINE COVERAGE MP7/MP8 <460HP  
US and CANADA EQUIPPED VEHICLE EMISSION COMPONENTS COVERAGE  
EATS: 60 MO/250K MI-EXHAUST AFTERTREATMENT  
ALLISON TRANSMISSIONS 36 MONTH UNLIMITED MILEAGE  
MACK CARRIER C1: 60 MO/500K MILES (HEAVY DUTY)  
AIR CONDITIONING STANDARD COVERAGE (Sealed System Only) 12  
MONTHS UNLIMITED MILEAGE  
STANDARD NORMAL / HEAVY DUTY CHASSIS TOWING 90 DAYS OR 5,000  
MILES  
STANDARD MACK ENGINE TOWING COVERAGE 24 MONTHS/250,000 MILES  
(402,000 KM)  
RADIATOR 24 MONTHS

**Local Costs**

DUMP BODY AND ALL ACCESSORIES PER BID SPECS  
STAINLESS STEEL COOLANT LINES  
NO IDLE HEAT & POWER SYSTEM  
ONE ULTRA CAPACITOR ENGINE MODULE  
STAINLESS STEEL BUG SCREEN

**THE AMERICAN TRUCK  
YOU CAN COUNT ON**



# State of West Virginia

## VENDOR PREFERENCE CERTIFICATE

Certification and application is hereby made for Preference in accordance with **West Virginia Code, §5A-3-37**. (Does not apply to construction contracts). **West Virginia Code, §5A-3-37**, provides an opportunity for qualifying vendors to request (at the time of bid) preference for their residency status. Such preference is an evaluation method only and will be applied only to the cost bid in accordance with the **West Virginia Code**. This certificate for application is to be used to request such preference. The Purchasing Division will make the determination of the Vendor Preference, if applicable.

1. **Application is made for 2.5% vendor preference for the reason checked:**  
 Bidder is an individual resident vendor and has resided continuously in West Virginia for four (4) years immediately preceding the date of this certification; **or**,  
 Bidder is a partnership, association or corporation resident vendor and has maintained its headquarters or principal place of business continuously in West Virginia for four (4) years immediately preceding the date of this certification;  
 Bidder is a resident vendor partnership, association, or corporation with at least eighty percent of ownership interest of bidder held by another entity that meets the applicable four year residency requirement; **or**,  
 Bidder is a nonresident vendor which has an affiliate or subsidiary which employs a minimum of one hundred state residents and which has maintained its headquarters or principal place of business within West Virginia continuously for the four (4) years immediately preceding the date of this certification; **or**,
2. **Application is made for 2.5% vendor preference for the reason checked:**  
 Bidder is a resident vendor who certifies that, during the life of the contract, on average at least 75% of the employees working on the project being bid are residents of West Virginia who have resided in the state continuously for the two years immediately preceding submission of this bid; **or**,
3. **Application is made for 2.5% vendor preference for the reason checked:**  
 Bidder is a nonresident vendor that employs a minimum of one hundred state residents, or a nonresident vendor which has an affiliate or subsidiary which maintains its headquarters or principal place of business within West Virginia and employs a minimum of one hundred state residents, and for purposes of producing or distributing the commodities or completing the project which is the subject of the bidder's bid and continuously over the entire term of the project, on average at least seventy-five percent of the bidder's employees or the bidder's affiliate's or subsidiary's employees are residents of West Virginia who have resided in the state continuously for the two immediately preceding years and the vendor's bid; **or**,
4. **Application is made for 5% vendor preference for the reason checked:**  
 Bidder meets either the requirement of both subdivisions (1) and (2) or subdivision (1) and (3) as stated above; **or**,
5. **Application is made for 3.5% vendor preference who is a veteran for the reason checked:**  
 Bidder is an individual resident vendor who is a veteran of the United States armed forces, the reserves or the National Guard and has resided in West Virginia continuously for the four years immediately preceding the date on which the bid is submitted; **or**,
6. **Application is made for 3.5% vendor preference who is a veteran for the reason checked:**  
 Bidder is a resident vendor who is a veteran of the United States armed forces, the reserves or the National Guard, if, for purposes of producing or distributing the commodities or completing the project which is the subject of the vendor's bid and continuously over the entire term of the project, on average at least seventy-five percent of the vendor's employees are residents of West Virginia who have resided in the state continuously for the two immediately preceding years.
7. **Application is made for preference as a non-resident small, women- and minority-owned business, in accordance with West Virginia Code §5A-3-59 and West Virginia Code of State Rules.**  
 Bidder has been or expects to be approved prior to contract award by the Purchasing Division as a certified small, women- and minority-owned business.

Bidder understands if the Secretary of Revenue determines that a Bidder receiving preference has failed to continue to meet the requirements for such preference, the Secretary may order the Director of Purchasing to: (a) rescind the contract or purchase order; or (b) assess a penalty against such Bidder in an amount not to exceed 5% of the bid amount and that such penalty will be paid to the contracting agency or deducted from any unpaid balance on the contract or purchase order.

By submission of this certificate, Bidder agrees to disclose any reasonably requested information to the Purchasing Division and authorizes the Department of Revenue to disclose to the Director of Purchasing appropriate information verifying that Bidder has paid the required business taxes, provided that such information does not contain the amounts of taxes paid nor any other information deemed by the Tax Commissioner to be confidential.

**Bidder hereby certifies that this certificate is true and accurate in all respects; and that if a contract is issued to Bidder and if anything contained within this certificate changes during the term of the contract, Bidder will notify the Purchasing Division in writing immediately.**

Bidder: Worldwide Equipment  
Date: 8-15-17

Signed: [Signature]  
Title: Regional Sales Manager

STATE OF WEST VIRGINIA  
Purchasing Division

# PURCHASING AFFIDAVIT

**MANDATE:** Under W. Va. Code §5A-3-10a, no contract or renewal of any contract may be awarded by the state or any of its political subdivisions to any vendor or prospective vendor when the vendor or prospective vendor or a related party to the vendor or prospective vendor is a debtor and: (1) the debt owed is an amount greater than one thousand dollars in the aggregate; or (2) the debtor is in employer default.

**EXCEPTION:** The prohibition listed above does not apply where a vendor has contested any tax administered pursuant to chapter eleven of the W. Va. Code, workers' compensation premium, permit fee or environmental fee or assessment and the matter has not become final or where the vendor has entered into a payment plan or agreement and the vendor is not in default of any of the provisions of such plan or agreement.

**DEFINITIONS:**

**"Debt"** means any assessment, premium, penalty, fine, tax or other amount of money owed to the state or any of its political subdivisions because of a judgment, fine, permit violation, license assessment, defaulted workers' compensation premium, penalty or other assessment presently delinquent or due and required to be paid to the state or any of its political subdivisions, including any interest or additional penalties accrued thereon.

**"Employer default"** means having an outstanding balance or liability to the old fund or to the uninsured employers' fund or being in policy default, as defined in W. Va. Code § 23-2c-2, failure to maintain mandatory workers' compensation coverage, or failure to fully meet its obligations as a workers' compensation self-insured employer. An employer is not in employer default if it has entered into a repayment agreement with the Insurance Commissioner and remains in compliance with the obligations under the repayment agreement.

**"Related party"** means a party, whether an individual, corporation, partnership, association, limited liability company or any other form or business association or other entity whatsoever, related to any vendor by blood, marriage, ownership or contract through which the party has a relationship of ownership or other interest with the vendor so that the party will actually or by effect receive or control a portion of the benefit, profit or other consideration from performance of a vendor contract with the party receiving an amount that meets or exceed five percent of the total contract amount.

**AFFIRMATION:** By signing this form, the vendor's authorized signer affirms and acknowledges under penalty of law for false swearing (W. Va. Code §61-5-3) that neither vendor nor any related party owe a debt as defined above and that neither vendor nor any related party are in employer default as defined above, unless the debt or employer default is permitted under the exception above.

**WITNESS THE FOLLOWING SIGNATURE:**

Vendor's Name: Worldwide Equipment  
Authorized Signature: [Signature] Date: 08/15/2017

State of West Virginia

County of Kanawha, to-wit:

Taken, subscribed, and sworn to before me this 15<sup>th</sup> day of August, 2017.

My Commission expires 10/23, 2020.

**AFFIX SEAL HERE**



**NOTARY PUBLIC**

[Signature]  
*Purchasing Affidavit (Revised 08/01/2015)*

**ADDENDUM ACKNOWLEDGEMENT FORM**  
**SOLICITATION NO.: CRFQ 0803 DOT1700000088**

**Instructions:** Please acknowledge receipt of all addenda issued with this solicitation by completing this addendum acknowledgment form. Check the box next to each addendum received and sign below. Failure to acknowledge addenda may result in bid disqualification.

**Acknowledgment:** I hereby acknowledge receipt of the following addenda and have made the necessary revisions to my proposal, plans and/or specification, etc.

**Addendum Numbers Received:**

(Check the box next to each addendum received)

- |  |  |
|--|--|
| <input checked="" type="checkbox"/> Addendum No. 1 | <input type="checkbox"/> Addendum No. 6  |
| <input checked="" type="checkbox"/> Addendum No. 2 | <input type="checkbox"/> Addendum No. 7  |
| <input type="checkbox"/> Addendum No. 3            | <input type="checkbox"/> Addendum No. 8  |
| <input type="checkbox"/> Addendum No. 4            | <input type="checkbox"/> Addendum No. 9  |
| <input type="checkbox"/> Addendum No. 5            | <input type="checkbox"/> Addendum No. 10 |

I understand that failure to confirm the receipt of addenda may be cause for rejection of this bid. I further understand that that any verbal representation made or assumed to be made during any oral discussion held between Vendor's representatives and any state personnel is not binding. Only the information issued in writing and added to the specifications by an official addendum is binding.

Worldwide Equipment  
Company

  
Authorized Signature

08/15/2017  
Date

NOTE: This addendum acknowledgement should be submitted with the bid to expedite document processing.





Purchasing Division  
 2019 Washington Street East  
 Post Office Box 50130  
 Charleston, WV 25305-0130

State of West Virginia  
 Request for Quotation  
 13 - Equipment

Proc Folder: 316206

Doc Description: 64,000 GVWR Tandem Axle Dump Truck w/ Hyd Sys & Accessories

Proc Type: Central Master Agreement

Date Issued	Solicitation Closes	Solicitation No	Version
2017-06-07	2017-08-03 13:30:00	CRFQ 0803 DOT1700000088	1

**BID RECEIVING LOCATION**

BID CLERK  
 DEPARTMENT OF ADMINISTRATION  
 PURCHASING DIVISION  
 2019 WASHINGTON ST E  
 CHARLESTON WV 25305  
 US

**VENDOR**

Vendor Name, Address and Telephone Number:

Worldwide Equipment  
 5650 us Route 60 East  
 Huntington, WV 25705

**FOR INFORMATION CONTACT THE BUYER**

Mark A Atkins  
 (304) 558-2307  
 mark.a.atkins@wv.gov

Signature X  FEIN # 45-1024981 DATE 08/15/2017

All offers subject to all terms and conditions contained in this solicitation

**ADDITIONAL INFORMATION:**

The West Virginia Purchasing Division is soliciting bids on behalf of the West Virginia Division of Highways (WVDOH), the West Virginia Department of Transportation (WVDOT), to establish an open-end contract for a 64,000 GVWR Tandem Axle Dump Truck with Snow Plow, V-Box Spreader and Central Hydraulic System with Stainless Steel Bed Body, Right Side Wing Plow Option, Anti-Icing Tank option, and Spray System option, per the attached documents.

**MANDATORY PRE-BID MEETING:**  
 Location: WV Division of Highways  
 Bldg 5 Training Room 855  
 1900 Kanawha Blvd East  
 Charleston, WV 25305

Time: 10:00am EST  
 Date: July 19, 2017

INVOICE TO		SHIP TO	
DIVISION OF HIGHWAYS EQUIPMENT DIVISION RT 33 83 BRUSHY ROAD CROSSING, PO BOX 610 BUCKHANNON WV26201 US		DIVISION OF HIGHWAYS EQUIPMENT DIVISION 83 BRUSHY FORK RD CROSSING BUCKHANNON WV 26201 US	

Line	Comm Ln Desc	Qty	Unit Issue	Unit Price	Total Price
1	COMPLETE UNIT: CAB CHASSIS/DUMP BODY W/HYD.	120.00000	EA		

Comm Code	Manufacturer	Specification	Model #
25101601			

**Extended Description :**  
 COMPLETE UNIT: CAB CHASSIS/DUMP BODY W/HYD. SYSTEM

INVOICE TO		SHIP TO	
DIVISION OF HIGHWAYS EQUIPMENT DIVISION RT 33 83 BRUSHY ROAD CROSSING, PO BOX 610 BUCKHANNON WV26201 US		DIVISION OF HIGHWAYS EQUIPMENT DIVISION 83 BRUSHY FORK RD CROSSING BUCKHANNON WV 26201 US	

Line	Comm Ln Desc	Qty	Unit Issue	Unit Price	Total Price
2	FRONT SNOW PLOW	120.00000	EA		

Comm Code	Manufacturer	Specification	Model #
25101926			

**Extended Description :**  
 FRONT SNOW PLOW

INVOICE TO		SHIP TO	
DIVISION OF HIGHWAYS EQUIPMENT DIVISION RT 33 83 BRUSHY ROAD CROSSING, PO BOX 610 BUCKHANNON WV26201 US		DIVISION OF HIGHWAYS EQUIPMENT DIVISION 83 BRUSHY FORK RD CROSSING BUCKHANNON WV 26201 US	

Line	Comm Ln Desc	Qty	Unit Issue	Unit Price	Total Price
3	9.5 V-BOX SPREADER	120.00000	EA		

Comm Code	Manufacturer	Specification	Model #
25101927			

**Extended Description :**  
9.5 V-BOX SPREADER

INVOICE TO		SHIP TO	
DIVISION OF HIGHWAYS EQUIPMENT DIVISION RT 33 83 BRUSHY ROAD CROSSING, PO BOX 610 BUCKHANNON WV26201 US		DIVISION OF HIGHWAYS EQUIPMENT DIVISION 83 BRUSHY FORK RD CROSSING BUCKHANNON WV 26201 US	

Line	Comm Ln Desc	Qty	Unit Issue	Unit Price	Total Price
4	RIGHT FRONT WING PLOW	20.00000	EA		

Comm Code	Manufacturer	Specification	Model #
21101522			

**Extended Description :**  
RIGHT FRONT WING PLOW

INVOICE TO		SHIP TO	
DIVISION OF HIGHWAYS EQUIPMENT DIVISION RT 33 83 BRUSHY ROAD CROSSING, PO BOX 610 BUCKHANNON WV26201 US		DIVISION OF HIGHWAYS EQUIPMENT DIVISION 83 BRUSHY FORK RD CROSSING BUCKHANNON WV 26201 US	

Line	Comm Ln Desc	Qty	Unit Issue	Unit Price	Total Price
5	Anti-icing Tank & Spray System	20.00000	EA		

<b>Comm Code</b>	<b>Manufacturer</b>	<b>Specification</b>	<b>Model #</b>
25102001			

**Extended Description :**  
Anti-icing Tank & Spray System

**SCHEDULE OF EVENTS**

<u>Line</u>	<u>Event</u>	<u>Event Date</u>
1	Mandatory Pre-Bid Meeting @ 10:00am EST	2017-07-19
2	Technical Questions due by:	2017-07-24

**SOLICITATION NUMBER: CRFQ 0803 DOT1700000088**  
**Addendum Number: 1**

---

The purpose of this addendum is to modify the solicitation identified as CRFQ 0803 DOT1700000088 ("Solicitation") to reflect the change(s) identified and described below.

**Applicable Addendum Category:**

- Modify bid opening date and time
- Modify specifications of product or service being sought
- Attachment of vendor questions and responses
- Attachment of pre-bid sign-in sheet
- Correction of error
- Other

**Description of Modification to Solicitation:**

1. To extend the bid opening date from 08/03/2017 to 08/15/2017 at 1:30pm EST.
2. To publish the pre-bid sign-in sheets.

No other changes made.

**Additional Documentation:** Documentation related to this Addendum (if any) has been included herewith as Attachment A and is specifically incorporated herein by reference.

**Terms and Conditions:**

1. All provisions of the Solicitation and other addenda not modified herein shall remain in full force and effect.
2. Vendor should acknowledge receipt of all addenda issued for this Solicitation by completing an Addendum Acknowledgment, a copy of which is included herewith. Failure to acknowledge addenda may result in bid disqualification. The addendum acknowledgement should be submitted with the bid to expedite document processing.



Purchasing Division  
 2019 Washington Street East  
 Post Office Box 50130  
 Charleston, WV 25305-0130

State of West Virginia  
 Request for Quotation  
 13 - Equipment

Proc Folder: 316206

Doc Description: ADDENDUM\_1: Tandem Axle Dump Truck w/ Hyd Sys & Accessories

Proc Type: Central Master Agreement

Date Issued	Solicitation Closes	Solicitation No	Version
2017-07-28	2017-08-15 13:30:00	CRFQ 0803 DOT1700000088	2

**BID RECEIVING LOCATION**

BID CLERK  
 DEPARTMENT OF ADMINISTRATION  
 PURCHASING DIVISION  
 2019 WASHINGTON ST E  
 CHARLESTON WV 25305  
 US

**VENDOR**

Vendor Name, Address and Telephone Number:  
 Worldwide Equipment  
 5650 US Route 60 East  
 Huntington, WV 25705  
 304-345-2490

**FOR INFORMATION CONTACT THE BUYER**

Mark A Atkins  
 (304) 558-2307  
 mark.a.atkins@wv.gov

Signature X  FEIN # 45-1024981 DATE 08/15/2017

All offers subject to all terms and conditions contained in this solicitation

**ADDITIONAL INFORMATION**

ADDENDUM 1: Is issued for the following:

1. To extend the bid opening date from 08/03/2017 to 08/15/2017 at 1:30pm EST.
2. To publish the pre-bid sign-in sheets.

No other changes made.

The West Virginia Purchasing Division is soliciting bids on behalf of the West Virginia Division of Highways (WVDOH), the West Virginia Department of Transportation (WVDOT), to establish an open-end contract for a 64,000 GVWR Tandem Axle Dump Truck with Snow Plow, V-Box Spreader and Central Hydraulic System with Stainless Steel Bed Body, Right Side Wing Plow Option, Anti-Icing Tank option, and Spray System option, per the attached documents.

**MANDATORY PRE-BID MEETING:**

Location: WV Division of Highways  
 Bldg 5 Training Room 855  
 1900 Kanawha Blvd East  
 Charleston, WV 25305

Time: 10:00am EST

Date: July 19, 2017

INVOICE TO		SHIP TO	
DIVISION OF HIGHWAYS EQUIPMENT DIVISION RT 33 83 BRUSHY ROAD CROSSING, PO BOX 610 BUCKHANNON WV26201 US		DIVISION OF HIGHWAYS EQUIPMENT DIVISION 83 BRUSHY FORK RD CROSSING BUCKHANNON WV 26201 US	

Line	Comm Ln Desc	Qty	Unit Issue	Unit Price	Total Price
1	COMPLETE UNIT: CAB CHASSIS/DUMP BODY W/HYD.	120.00000	EA		

Comm Code	Manufacturer	Specification	Model #
25101601			

Extended Description :  
 COMPLETE UNIT: CAB CHASSIS/DUMP BODY W/HYD. SYSTEM

INVOICE TO		SHIP TO	
DIVISION OF HIGHWAYS EQUIPMENT DIVISION RT 33 83 BRUSHY ROAD CROSSING, PO BOX 610 BUCKHANNON WV26201 US		DIVISION OF HIGHWAYS EQUIPMENT DIVISION 83 BRUSHY FORK RD CROSSING BUCKHANNON WV 26201 US	

Line	Comm Ln Desc	Qty	Unit Issue	Unit Price	Total Price
2	FRONT SNOW PLOW	120.00000	EA		

Comm Code	Manufacturer	Specification	Model #
25101926			

Extended Description :

FRONT SNOW PLOW

INVOICE TO	SHIP TO
DIVISION OF HIGHWAYS EQUIPMENT DIVISION RT 33 83 BRUSHY ROAD CROSSING, PO BOX 610 BUCKHANNON WV26201 US	DIVISION OF HIGHWAYS EQUIPMENT DIVISION 83 BRUSHY FORK RD CROSSING BUCKHANNON WV 26201 US

Line	Comm Ln Desc	Qty	Unit Issue	Unit Price	Total Price
3	9.5 V-BOX SPREADER	120.00000	EA		

Comm Code	Manufacturer	Specification	Model #
25101927			

Extended Description :  
9.5 V-BOX SPREADER

INVOICE TO	SHIP TO
DIVISION OF HIGHWAYS EQUIPMENT DIVISION RT 33 83 BRUSHY ROAD CROSSING, PO BOX 610 BUCKHANNON WV26201 US	DIVISION OF HIGHWAYS EQUIPMENT DIVISION 83 BRUSHY FORK RD CROSSING BUCKHANNON WV 26201 US

Line	Comm Ln Desc	Qty	Unit Issue	Unit Price	Total Price
4	RIGHT FRONT WING PLOW	20.00000	EA		

Comm Code	Manufacturer	Specification	Model #
21101522			

Extended Description :  
RIGHT FRONT WING PLOW

INVOICE TO	SHIP TO
DIVISION OF HIGHWAYS EQUIPMENT DIVISION RT 33 83 BRUSHY ROAD CROSSING, PO BOX 610 BUCKHANNON WV26201 US	DIVISION OF HIGHWAYS EQUIPMENT DIVISION 83 BRUSHY FORK RD CROSSING BUCKHANNON WV 26201 US

Line	Comm Ln Desc	Qty	Unit Issue	Unit Price	Total Price
5	Anti-icing Tank & Spray System	20.00000	EA		



Comm Code	Manufacturer	Specification	Model #
25102001			

**Extended Description :**  
 Anti-icing Tank & Spray System

**SCHEDULE OF EVENTS**

<u>Line</u>	<u>Event</u>	<u>Event Date</u>
1	Mandatory Pre-Bid Meeting @ 10:00am EST	2017-07-19
2	Technical Questions due by:	2017-07-24

# SOLICITATION NUMBER: CRFQ 0803 DOT1700000088

## Addendum Number: 2

---

The purpose of this addendum is to modify the solicitation identified as CRFQ 0803 DOT1700000088 (“Solicitation”) to reflect the change(s) identified and described below.

### Applicable Addendum Category:

- Modify bid opening date and time
- Modify specifications of product or service being sought
- Attachment of vendor questions and responses
- Attachment of pre-bid sign-in sheet
- Correction of error
- Other: To attach a revised Exhibit\_A pricing page.

### Description of Modification to Solicitation:

1. To publish the agency response to questions submitted by vendors during the Technical Questioning period.
2. To publish a revised (08/01/2017) Exhibit\_A Pricing Page.

No other changes made.

**Additional Documentation:** Documentation related to this Addendum (if any) has been included herewith as Attachment A and is specifically incorporated herein by reference.

### Terms and Conditions:

1. All provisions of the Solicitation and other addenda not modified herein shall remain in full force and effect.
2. Vendor should acknowledge receipt of all addenda issued for this Solicitation by completing an Addendum Acknowledgment, a copy of which is included herewith. Failure to acknowledge addenda may result in bid disqualification. The addendum acknowledgement should be submitted with the bid to expedite document processing.



Purchasing Division  
 2019 Washington Street East  
 Post Office Box 50130  
 Charleston, WV 25305-0130

State of West Virginia  
 Request for Quotation  
 13 - Equipment

Proc Folder: 316206

Doc Description: ADDENDUM\_2: Tandem Axle Dump Truck w/ Hyd Sys & Accessories

Proc Type: Central Master Agreement

Date Issued	Solicitation Closes	Solicitation No	Version
2017-08-01	2017-08-15 13:30:00	CRFQ 0803 DOT1700000088	3

**BID RECEIVING LOCATION:**

BID CLERK  
 DEPARTMENT OF ADMINISTRATION  
 PURCHASING DIVISION  
 2019 WASHINGTON ST E  
 CHARLESTON WV 25305  
 US

**VENDOR:**

Vendor Name, Address and Telephone Number:

Worldwide Equipment  
 5650 US Route 60 East  
 Huntington, WV 25705  
 304-345-2490

**FOR INFORMATION CONTACT THE BUYER**

Mark A Atkins  
 (304) 558-2307  
 mark.a.atkins@wv.gov

Signature X

FEIN # 45-1024981

DATE 08/15/2017

All offers subject to all terms and conditions contained in this solicitation

**ADDITIONAL INFORMATION:**

ADDENDUM 2: Is issued for the following:

1. To publish the agency response to questions submitted by vendors during the Technical Questioning period.
2. To publish a revised (08/01/2017) Exhibit\_A Pricing Page.

No other changes made.

The West Virginia Purchasing Division is soliciting bids on behalf of the West Virginia Division of Highways (WVDOH), the West Virginia Department of Transportation (WVDOT), to establish an open-end contract for a 64,000 GVWR Tandem Axle Dump Truck with Snow Plow, V-Box Spreader and Central Hydraulic System with Stainless Steel Bed Body, Right Side Wing Plow Option, Anti-Icing Tank option, and Spray System option, per the attached documents.

**MANDATORY PRE-BID MEETING:**

Location: WV Division of Highways  
 Bldg 5 Training Room 855  
 1900 Kanawha Blvd East  
 Charleston, WV 25305

Time: 10:00am EST

Date: July 19, 2017

INVOICE TO:		SHIP TO:	
DIVISION OF HIGHWAYS EQUIPMENT DIVISION RT 33 83 BRUSHY ROAD CROSSING, PO BOX 610 BUCKHANNON WV26201 US		DIVISION OF HIGHWAYS EQUIPMENT DIVISION 83 BRUSHY FORK RD CROSSING BUCKHANNON WV 26201 US	

Line	Comm Ln Desc	Qty	Unit Issue	Unit Price	Total Price
1	COMPLETE UNIT: (see Extended Description)	120.00000	EA		

Comm Code	Manufacturer	Specification	Model #
25101601			

**Extended Description :**

COMPLETE UNIT: CAB CHASSIS/DUMP BODY WITH HYDRAULIC SYSTEM, FRONT SNOW PLOW, AND 9.5 V-BOX SPREADER.

INVOICE TO:		SHIP TO:	
DIVISION OF HIGHWAYS EQUIPMENT DIVISION RT 33 83 BRUSHY ROAD CROSSING, PO BOX 610 BUCKHANNON WV26201 US		DIVISION OF HIGHWAYS EQUIPMENT DIVISION 83 BRUSHY FORK RD CROSSING BUCKHANNON WV 26201 US	

Line	Comm Ln Desc	Qty	Unit Issue	Unit Price	Total Price
2	COMPLETE UNIT: (see Extended Description)	50.00000	EA		

Comm Code	Manufacturer	Specification	Model #
25101926			

**Extended Description :**

COMPLETE UNIT: CAB CHASSIS/DUMP BODY WITH HYDRAULIC SYSTEM, FRONT SNOW PLOW, 9.5 V-BOX SPREADER, AND RIGHT FRONT WING PLOW.

INVOICE TO	SHIP TO
DIVISION OF HIGHWAYS EQUIPMENT DIVISION RT 33 83 BRUSHY ROAD CROSSING, PO BOX 610 BUCKHANNON WV26201 US	DIVISION OF HIGHWAYS EQUIPMENT DIVISION 83 BRUSHY FORK RD CROSSING BUCKHANNON WV 26201 US

Line	Comm Ln Desc	Qty	Unit Issue	Unit Price	Total Price
3	Anti-icing Tank & Spray System	50.00000	EA		

Comm Code	Manufacturer	Specification	Model #
25102001			

**Extended Description :**

Anti-icing Tank & Spray System

INVOICE TO	SHIP TO
DIVISION OF HIGHWAYS EQUIPMENT DIVISION RT 33 83 BRUSHY ROAD CROSSING, PO BOX 610 BUCKHANNON WV26201 US	DIVISION OF HIGHWAYS EQUIPMENT DIVISION 83 BRUSHY FORK RD CROSSING BUCKHANNON WV 26201 US

Line	Comm Ln Desc	Qty	Unit Issue	Unit Price	Total Price
4	inactive	0.00000	EA		

Comm Code	Manufacturer	Specification	Model #
21101522			

**Extended Description :**

inactive

INVOICE TO		BHP TO	
DIVISION OF HIGHWAYS EQUIPMENT DIVISION RT 33 83 BRUSHY ROAD CROSSING, PO BOX 610 BUCKHANNON WV26201 US		DIVISION OF HIGHWAYS EQUIPMENT DIVISION 83 BRUSHY FORK RD CROSSING BUCKHANNON WV 26201 US	

Line	Comm Ln Desc	Qty	Unit Issue	Unit Price	Total Price
5	Inactive	0.00000	EA		

Comm Code	Manufacturer	Specification	Model #
25102001			

Extended Description :  
Inactive

**SCHEDULE OF EVENTS**

Line	Event	Event Date
1	Mandatory Pre-Bid Meeting @ 10:00am EST	2017-07-19
2	Technical Questions due by:	2017-07-24

<b>DOT170000088</b>	<b>Document Phase</b> Final	<b>Document Description</b> 64,000 GVWR Tandem Axle Dump Truck w/ Hyd Sys & Accessories	<b>Page 5</b> <b>of 5</b>
---------------------	--------------------------------	---	------------------------------

**ADDITIONAL TERMS AND CONDITIONS**

See attached document(s) for additional Terms and Conditions

## INSTRUCTIONS TO VENDORS SUBMITTING BIDS

**1. REVIEW DOCUMENTS THOROUGHLY:** The attached documents contain a solicitation for bids. Please read these instructions and all documents attached in their entirety. These instructions provide critical information about requirements that if overlooked could lead to disqualification of a Vendor's bid. All bids must be submitted in accordance with the provisions contained in these instructions and the Solicitation. Failure to do so may result in disqualification of Vendor's bid.

**2. MANDATORY TERMS:** The Solicitation may contain mandatory provisions identified by the use of the words "must," "will," and "shall." Failure to comply with a mandatory term in the Solicitation will result in bid disqualification.

**3. PREBID MEETING:** The item identified below shall apply to this Solicitation.

A pre-bid meeting will not be held prior to bid opening

A **NON-MANDATORY PRE-BID** meeting will be held at the following place and time:

A **MANDATORY PRE-BID** meeting will be held at the following place and time:

WV Division of Highways  
Bldg 5 Training Room 855  
1900 Kanawha Blvd East  
Charleston, WV 25305

Time: 10:00am EST  
Date: July 19, 2017

All Vendors submitting a bid must attend the mandatory pre-bid meeting. Failure to attend the mandatory pre-bid meeting shall result in disqualification of the Vendor's bid. No one person attending the pre-bid meeting may represent more than one Vendor.

An attendance sheet provided at the pre-bid meeting shall serve as the official document verifying attendance. The State will not accept any other form of proof or documentation to verify attendance. Any person attending the pre-bid meeting on behalf of a Vendor must list on the attendance sheet his or her name and the name of the Vendor he or she is representing.



Additionally, the person attending the pre-bid meeting should include the Vendor's E-Mail address, phone number, and Fax number on the attendance sheet. It is the Vendor's responsibility to locate the attendance sheet and provide the required information. Failure to complete the attendance sheet as required may result in disqualification of Vendor's bid.

All Vendors should arrive prior to the starting time for the pre-bid. Vendors who arrive after the starting time but prior to the end of the pre-bid will be permitted to sign in, but are charged with knowing all matters discussed at the pre-bid.

Questions submitted at least five business days prior to a scheduled pre-bid will be discussed at the pre-bid meeting if possible. Any discussions or answers to questions at the pre-bid meeting are preliminary in nature and are non-binding. Official and binding answers to questions will be published in a written addendum to the Solicitation prior to bid opening.

**4. VENDOR QUESTION DEADLINE:** Vendors may submit questions relating to this Solicitation to the Purchasing Division. Questions must be submitted in writing. All questions must be submitted on or before the date listed below and to the address listed below in order to be considered. A written response will be published in a Solicitation addendum if a response is possible and appropriate. Non-written discussions, conversations, or questions and answers regarding this Solicitation are preliminary in nature and are nonbinding.

Submitted e-mails should have solicitation number in the subject line.

Question Submission Deadline: July 24, 2017

Submit Questions to: Mark Atkins, Senior Buyer  
2019 Washington Street, East  
Charleston, WV 25305  
Fax: (304) 558-4115 (Vendors should not use this fax number for bid submission)  
Email: [Mark.A.Atkins@wv.gov](mailto:Mark.A.Atkins@wv.gov)

**5. VERBAL COMMUNICATION:** Any verbal communication between the Vendor and any State personnel is not binding, including verbal communication at the mandatory pre-bid conference. Only information issued in writing and added to the Solicitation by an official written addendum by the Purchasing Division is binding.

**6. BID SUBMISSION:** All bids must be submitted electronically through wvOASIS or signed and delivered by the Vendor to the Purchasing Division at the address listed below on or before the date and time of the bid opening. Any bid received by the Purchasing Division staff is considered to be in the possession of the Purchasing Division and will not be returned for any reason. The Purchasing Division will not accept bids, modification of bids, or addendum acknowledgment forms via e-mail. Acceptable delivery methods include electronic submission via wvOASIS, hand delivery, delivery by courier, or facsimile.

The bid delivery address is:  
Department of Administration, Purchasing Division  
2019 Washington Street East  
Charleston, WV 25305-0130

A bid that is not submitted electronically through wvOASIS should contain the information listed below on the face of the envelope or the bid may be rejected by the Purchasing Division.:

SEALED BID: Tandem Truck with Accessories  
BUYER: Mark Atkins, File#33  
SOLICITATION NO.: CRFQ 0803 DOT1700000088  
BID OPENING DATE: August 03, 2017  
BID OPENING TIME: 1:30pm EST  
FAX NUMBER: 304-558-3970

The Purchasing Division may prohibit the submission of bids electronically through wvOASIS at its sole discretion. Such a prohibition will be contained and communicated in the wvOASIS system resulting in the Vendor's inability to submit bids through wvOASIS. Submission of a response to an Expression or Interest or Request for Proposal is not permitted in wvOASIS.

**For Request For Proposal ("RFP") Responses Only:** In the event that Vendor is responding to a request for proposal, the Vendor shall submit one original technical and one original cost proposal plus N/A convenience copies of each to the Purchasing Division at the address shown above. Additionally, the Vendor should identify the bid type as either a technical or cost proposal on the face of each bid envelope submitted in response to a request for proposal as follows:

BID TYPE: (This only applies to CRFP)

- Technical  
 Cost

**7. BID OPENING:** Bids submitted in response to this Solicitation will be opened at the location identified below on the date and time listed below. Delivery of a bid after the bid opening date and time will result in bid disqualification. For purposes of this Solicitation, a bid is considered delivered when confirmation of delivery is provided by wvOASIS (in the case of electronic submission) or when the bid is time stamped by the official Purchasing Division time clock (in the case of hand delivery).

Bid Opening Date and Time: August 03, 2017 @ 1:30pm EST

Bid Opening Location: Department of Administration, Purchasing Division  
2019 Washington Street East  
Charleston, WV 25305-0130

**8. ADDENDUM ACKNOWLEDGEMENT:** Changes or revisions to this Solicitation will be made by an official written addendum issued by the Purchasing Division. Vendor should acknowledge receipt of all addenda issued with this Solicitation by completing an Addendum Acknowledgment Form, a copy of which is included herewith. Failure to acknowledge addenda may result in bid disqualification. The addendum acknowledgement should be submitted with the bid to expedite document processing.

**9. BID FORMATTING:** Vendor should type or electronically enter the information onto its bid to prevent errors in the evaluation. Failure to type or electronically enter the information may result in bid disqualification.

**10. ALTERNATES:** Any model, brand, or specification listed in this Solicitation establishes the acceptable level of quality only and is not intended to reflect a preference for, or in any way favor, a particular brand or vendor. Vendors may bid alternates to a listed model or brand provided that the alternate is at least equal to the model or brand and complies with the required specifications. The equality of any alternate being bid shall be determined by the State at its sole discretion. Any Vendor bidding an alternate model or brand should clearly identify the alternate items in its bid and should include manufacturer's specifications, industry literature, and/or any other relevant documentation demonstrating the equality of the alternate items. Failure to provide information for alternate items may be grounds for rejection of a Vendor's bid.

**11. EXCEPTIONS AND CLARIFICATIONS:** The Solicitation contains the specifications that shall form the basis of a contractual agreement. Vendor shall clearly mark any exceptions, clarifications, or other proposed modifications in its bid. Exceptions to, clarifications of, or modifications of a requirement or term and condition of the Solicitation may result in bid disqualification.

**12. COMMUNICATION LIMITATIONS:** In accordance with West Virginia Code of State Rules §148-1-6.6, communication with the State of West Virginia or any of its employees regarding this Solicitation during the solicitation, bid, evaluation or award periods, except through the Purchasing Division, is strictly prohibited without prior Purchasing Division approval. Purchasing Division approval for such communication is implied for all agency delegated and exempt purchases.

**13. REGISTRATION:** Prior to Contract award, the apparent successful Vendor must be properly registered with the West Virginia Purchasing Division and must have paid the \$125 fee, if applicable.

**14. UNIT PRICE:** Unit prices shall prevail in cases of a discrepancy in the Vendor's bid.

**15. PREFERENCE:** Vendor Preference may only be granted upon written request and only in accordance with the West Virginia Code § 5A-3-37 and the West Virginia Code of State Rules. A Vendor Preference Certificate form has been attached hereto to allow Vendor to apply for the preference. Vendor's failure to submit the Vendor Preference Certificate form with its bid will result in denial of Vendor Preference. Vendor Preference does not apply to construction projects.

**16. SMALL, WOMEN-OWNED, OR MINORITY-OWNED BUSINESSES:** For any solicitations publicly advertised for bid, in accordance with West Virginia Code §5A-3-37(a)(7) and W. Va. CSR § 148-22-9, any non-resident vendor certified as a small, women-owned, or minority-owned business under W. Va. CSR § 148-22-9 shall be provided the same preference made available to any resident vendor. Any non-resident small, women-owned, or minority-owned business must identify itself as such in writing, must submit that writing to the Purchasing Division with its bid, and must be properly certified under W. Va. CSR § 148-22-9 prior to contract award to receive the preferences made available to resident vendors. Preference for a non-resident small, women-owned, or minority owned business shall be applied in accordance with W. Va. CSR § 148-22-9.

**17. WAIVER OF MINOR IRREGULARITIES:** The Director reserves the right to waive minor irregularities in bids or specifications in accordance with West Virginia Code of State Rules § 148-1-4.6.

**18. ELECTRONIC FILE ACCESS RESTRICTIONS:** Vendor must ensure that its submission in wvOASIS can be accessed and viewed by the Purchasing Division staff immediately upon bid opening. The Purchasing Division will consider any file that cannot be immediately accessed and viewed at the time of the bid opening (such as, encrypted files, password protected files, or incompatible files) to be blank or incomplete as context requires, and are therefore unacceptable. A vendor will not be permitted to unencrypt files, remove password protections, or resubmit documents after bid opening to make a file viewable if those documents are required with the bid. A Vendor may be required to provide document passwords or remove access restrictions to allow the Purchasing Division to print or electronically save documents provided that those documents are viewable by the Purchasing Division prior to obtaining the password or removing the access restriction.

**19. NON-RESPONSIBLE:** The Purchasing Division Director reserves the right to reject the bid of any vendor as Non-Responsible in accordance with W. Va. Code of State Rules § 148-1-5.3, when the Director determines that the vendor submitting the bid does not have the capability to fully perform, or lacks the integrity and reliability to assure good-faith performance.”

**20. ACCEPTANCE/REJECTION:** The State may accept or reject any bid in whole, or in part in accordance with W. Va. Code of State Rules § 148-1-4.5. and § 148-1-6.4.b.”

**21. YOUR SUBMISSION IS A PUBLIC DOCUMENT:** Vendor's entire response to the Solicitation and the resulting Contract are public documents. As public documents, they will be disclosed to the public following the bid/proposal opening or award of the contract, as required by the competitive bidding laws of West Virginia Code §§ 5A-3-1 et seq., 5-22-1 et seq., and 5G-1-1 et seq. and the Freedom of Information Act West Virginia Code §§ 29B-1-1 et seq.

**DO NOT SUBMIT MATERIAL YOU CONSIDER TO BE CONFIDENTIAL, A TRADE SECRET, OR OTHERWISE NOT SUBJECT TO PUBLIC DISCLOSURE.**

Submission of any bid, proposal, or other document to the Purchasing Division constitutes your explicit consent to the subsequent public disclosure of the bid, proposal, or document. The Purchasing Division will disclose any document labeled "confidential," "proprietary," "trade secret," "private," or labeled with any other claim against public disclosure of the documents, to include any "trade secrets" as defined by West Virginia Code § 47-22-1 et seq. All submissions are subject to public disclosure without notice.

## GENERAL TERMS AND CONDITIONS:

**1. CONTRACTUAL AGREEMENT:** Issuance of a Award Document signed by the Purchasing Division Director, or his designee, and approved as to form by the Attorney General's office constitutes acceptance of this Contract made by and between the State of West Virginia and the Vendor. Vendor's signature on its bid signifies Vendor's agreement to be bound by and accept the terms and conditions contained in this Contract.

**2. DEFINITIONS:** As used in this Solicitation/Contract, the following terms shall have the meanings attributed to them below. Additional definitions may be found in the specifications included with this Solicitation/Contract.

**2.1. "Agency" or "Agencies"** means the agency, board, commission, or other entity of the State of West Virginia that is identified on the first page of the Solicitation or any other public entity seeking to procure goods or services under this Contract.

**2.2. "Bid" or "Proposal"** means the vendors submitted response to this solicitation.

**2.3. "Contract"** means the binding agreement that is entered into between the State and the Vendor to provide the goods or services requested in the Solicitation.

**2.4. "Director"** means the Director of the West Virginia Department of Administration, Purchasing Division.

**2.5. "Purchasing Division"** means the West Virginia Department of Administration, Purchasing Division.

**2.6. "Award Document"** means the document signed by the Agency and the Purchasing Division, and approved as to form by the Attorney General, that identifies the Vendor as the contract holder.

**2.7. "Solicitation"** means the official notice of an opportunity to supply the State with goods or services that is published by the Purchasing Division.

**2.8. "State"** means the State of West Virginia and/or any of its agencies, commissions, boards, etc. as context requires.

**2.9. "Vendor" or "Vendors"** means any entity submitting a bid in response to the Solicitation, the entity that has been selected as the lowest responsible bidder, or the entity that has been awarded the Contract as context requires.

**3. CONTRACT TERM; RENEWAL; EXTENSION:** The term of this Contract shall be determined in accordance with the category that has been identified as applicable to this Contract below:

**Term Contract**

**Initial Contract Term:** This Contract becomes effective on \_\_\_\_\_ upon award \_\_\_\_\_ and extends for a period of One (1) year(s).

**Renewal Term:** This Contract may be renewed upon the mutual written consent of the Agency, and the Vendor, with approval of the Purchasing Division and the Attorney General's office (Attorney General approval is as to form only). Any request for renewal should be submitted to the Purchasing Division thirty (30) days prior to the expiration date of the initial contract term or appropriate renewal term. A Contract renewal shall be in accordance with the terms and conditions of the original contract. Renewal of this Contract is limited to three (3) successive one (1) year periods or multiple renewal periods of less than one year, provided that the multiple renewal periods do not exceed thirty-six (36) months in total. Automatic renewal of this Contract is prohibited. Notwithstanding the foregoing, Purchasing Division approval is not required on agency delegated or exempt purchases. Attorney General approval may be required for vendor terms and conditions.

**Delivery Order Limitations:** In the event that this contract permits delivery orders, a delivery order may only be issued during the time this Contract is in effect. Any delivery order issued within one year of the expiration of this Contract shall be effective for one year from the date the delivery order is issued. No delivery order may be extended beyond one year after this Contract has expired.

**Fixed Period Contract:** This Contract becomes effective upon Vendor's receipt of the notice to proceed and must be completed within \_\_\_\_\_ days.

**Fixed Period Contract with Renewals:** This Contract becomes effective upon Vendor's receipt of the notice to proceed and part of the Contract more fully described in the attached specifications must be completed within \_\_\_\_\_ days.

Upon completion, the vendor agrees that maintenance, monitoring, or warranty services will be provided for one year thereafter with an additional \_\_\_\_\_ successive one year renewal periods or multiple renewal periods of less than one year provided that the multiple renewal periods do not exceed \_\_\_\_\_ months in total. Automatic renewal of this Contract is prohibited.

**One Time Purchase:** The term of this Contract shall run from the issuance of the Award Document until all of the goods contracted for have been delivered, but in no event will this Contract extend for more than one fiscal year.

**Other:** See attached.

**4. NOTICE TO PROCEED:** Vendor shall begin performance of this Contract immediately upon receiving notice to proceed unless otherwise instructed by the Agency. Unless otherwise specified, the fully executed Award Document will be considered notice to proceed.

**5. QUANTITIES:** The quantities required under this Contract shall be determined in accordance with the category that has been identified as applicable to this Contract below.

**Open End Contract:** Quantities listed in this Solicitation are approximations only, based on estimates supplied by the Agency. It is understood and agreed that the Contract shall cover the quantities actually ordered for delivery during the term of the Contract, whether more or less than the quantities shown.

**Service:** The scope of the service to be provided will be more clearly defined in the specifications included herewith.

**Combined Service and Goods:** The scope of the service and deliverable goods to be provided will be more clearly defined in the specifications included herewith.

**One Time Purchase:** This Contract is for the purchase of a set quantity of goods that are identified in the specifications included herewith. Once those items have been delivered, no additional goods may be procured under this Contract without an appropriate change order approved by the Vendor, Agency, Purchasing Division, and Attorney General's office.

**6. EMERGENCY PURCHASES:** The Purchasing Division Director may authorize the Agency to purchase goods or services in the open market that Vendor would otherwise provide under this Contract if those goods or services are for immediate or expedited delivery in an emergency. Emergencies shall include, but are not limited to, delays in transportation or an unanticipated increase in the volume of work. An emergency purchase in the open market, approved by the Purchasing Division Director, shall not constitute of breach of this Contract and shall not entitle the Vendor to any form of compensation or damages. This provision does not excuse the State from fulfilling its obligations under a One Time Purchase contract.

**7. REQUIRED DOCUMENTS:** All of the items checked below must be provided to the Purchasing Division by the Vendor as specified below.

**BID BOND (Construction Only):** Pursuant to the requirements contained in W. Va. Code § 5-22-1(c), All Vendors submitting a bid on a construction project shall furnish a valid bid bond in the amount of five percent (5%) of the total amount of the bid protecting the State of West Virginia. The bid bond must be submitted with the bid.

**PERFORMANCE BOND:** The apparent successful Vendor shall provide a performance bond in the amount of \_\_\_\_\_. The performance bond must be received by the Purchasing Division prior to Contract award. On construction contracts, the performance bond must be 100% of the Contract value.



**LABOR/MATERIAL PAYMENT BOND:** The apparent successful Vendor shall provide a labor/material payment bond in the amount of 100% of the Contract value. The labor/material payment bond must be delivered to the Purchasing Division prior to Contract award.

In lieu of the Bid Bond, Performance Bond, and Labor/Material Payment Bond, the Vendor may provide certified checks, cashier's checks, or irrevocable letters of credit. Any certified check, cashier's check, or irrevocable letter of credit provided in lieu of a bond must be of the same amount and delivered on the same schedule as the bond it replaces. A letter of credit submitted in lieu of a performance and labor/material payment bond will only be allowed for projects under \$100,000. Personal or business checks are not acceptable. Notwithstanding the foregoing, West Virginia Code § 5-22-1 (d) mandates that a vendor provide a performance and labor/material payment bond for construction projects. Accordingly, substitutions for the performance and labor/material payment bonds for construction projects is not permitted.

**MAINTENANCE BOND:** The apparent successful Vendor shall provide a two (2) year maintenance bond covering the roofing system. The maintenance bond must be issued and delivered to the Purchasing Division prior to Contract award.

**LICENSE(S) / CERTIFICATIONS / PERMITS:** In addition to anything required under the Section entitled Licensing, of the General Terms and Conditions, the apparent successful Vendor shall furnish proof of the following licenses, certifications, and/or permits prior to Contract award, in a form acceptable to the Purchasing Division.

The apparent successful Vendor shall also furnish proof of any additional licenses or certifications contained in the specifications prior to Contract award regardless of whether or not that requirement is listed above.

**8. INSURANCE:** The apparent successful Vendor shall furnish proof of the insurance identified by a checkmark below prior to Contract award. Subsequent to contract award, and prior to the insurance expiration date, Vendor shall provide the Agency with proof that the insurance mandated herein has been continued. Vendor must also provide Agency with immediate notice of any changes in its insurance policies mandated herein, including but not limited to, policy cancelation, policy reduction, or change in insurers. The insurance coverages identified below must be maintained throughout the life of this contract. The apparent successful Vendor shall also furnish proof of any additional insurance requirements contained in the specifications prior to Contract award regardless of whether or not that insurance requirement is listed in this section.

Vendor must maintain:

**Commercial General Liability Insurance** in at least an amount of:

\_\_\_\_\_  
\_\_\_\_\_

**Automobile Liability Insurance** in at least an amount of: \_\_\_\_\_

**Professional/Malpractice/Errors and Omission Insurance** in at least an amount of:

\_\_\_\_\_

**Commercial Crime and Third Party Fidelity Insurance** in an amount of:

\_\_\_\_\_

**Cyber Liability Insurance** in an amount of: \_\_\_\_\_

**Builders Risk Insurance** in an amount equal to 100% of the amount of the Contract.

**9. WORKERS' COMPENSATION INSURANCE:** The apparent successful Vendor shall comply with laws relating to workers compensation, shall maintain workers' compensation insurance when required, and shall furnish proof of workers' compensation insurance upon request.

**10. LITIGATION BOND:** The Director reserves the right to require any Vendor that files a protest of an award to submit a litigation bond in the amount equal to one percent of the lowest bid submitted or \$5,000, whichever is greater. The entire amount of the bond shall be forfeited if the hearing officer determines that the protest was filed for frivolous or improper purpose, including but not limited to, the purpose of harassing, causing unnecessary delay, or needless expense for the Agency. All litigation bonds shall be made payable to the Purchasing Division. In lieu of a bond, the protester may submit a cashier's check or certified check payable to the Purchasing Division. Cashier's or certified checks will be deposited with and held by the State Treasurer's office. If it is determined that the protest has not been filed for frivolous or improper purpose, the bond or deposit shall be returned in its entirety.

**11. LIQUIDATED DAMAGES:** Vendor shall pay liquidated damages in the amount of n/a for n/a. This clause shall in no way be considered exclusive and shall not limit the State or Agency's right to pursue any other available remedy.

**12. ACCEPTANCE:** Vendor's signature on its bid, or on the certification and signature page, constitutes an offer to the State that cannot be unilaterally withdrawn, signifies that the product or service proposed by vendor meets the mandatory requirements contained in the Solicitation for that product or service, unless otherwise indicated, and signifies acceptance of the terms and conditions contained in the Solicitation unless otherwise indicated.

**13. PRICING:** The pricing set forth herein is firm for the life of the Contract, unless specified elsewhere within this Solicitation/Contract by the State. A Vendor's inclusion of price adjustment provisions in its bid, without an express authorization from the State in the Solicitation to do so, may result in bid disqualification.

**14. PAYMENT:** Payment in advance is prohibited under this Contract. Payment may only be made after the delivery and acceptance of goods or services. The Vendor shall submit invoices, in arrears.

**15. PURCHASING CARD ACCEPTANCE:** The State of West Virginia currently utilizes a Purchasing Card program, administered under contract by a banking institution, to process payment for goods and services. The Vendor must accept the State of West Virginia's Purchasing Card for payment of all orders under this Contract unless the box below is checked.

Vendor is not required to accept the State of West Virginia's Purchasing Card as payment for all goods and services.

**16. TAXES:** The Vendor shall pay any applicable sales, use, personal property or any other taxes arising out of this Contract and the transactions contemplated thereby. The State of West Virginia is exempt from federal and state taxes and will not pay or reimburse such taxes.

**17. ADDITIONAL FEES:** Vendor is not permitted to charge additional fees or assess additional charges that were not either expressly provided for in the solicitation published by the State of West Virginia or included in the unit price or lump sum bid amount that Vendor is required by the solicitation to provide. Including such fees or charges as notes to the solicitation may result in rejection of vendor's bid. Requesting such fees or charges be paid after the contract has been awarded may result in cancellation of the contract.

**18. FUNDING:** This Contract shall continue for the term stated herein, contingent upon funds being appropriated by the Legislature or otherwise being made available. In the event funds are not appropriated or otherwise made available, this Contract becomes void and of no effect beginning on July 1 of the fiscal year for which funding has not been appropriated or otherwise made available.

**19. CANCELLATION:** The Purchasing Division Director reserves the right to cancel this Contract immediately upon written notice to the vendor if the materials or workmanship supplied do not conform to the specifications contained in the Contract. The Purchasing Division Director may also cancel any purchase or Contract upon 30 days written notice to the Vendor in accordance with West Virginia Code of State Rules § 148-1-6.1.e.

**20. TIME:** Time is of the essence with regard to all matters of time and performance in this Contract.

**21. APPLICABLE LAW:** This Contract is governed by and interpreted under West Virginia law without giving effect to its choice of law principles. Any information provided in specification manuals, or any other source, verbal or written, which contradicts or violates the West Virginia Constitution, West Virginia Code or West Virginia Code of State Rules is void and of no effect.

**22. COMPLIANCE:** Vendor shall comply with all applicable federal, state, and local laws, regulations and ordinances. By submitting a bid, Vendor acknowledges that it has reviewed, understands, and will comply with all applicable laws, regulations, and ordinances.

**23. ARBITRATION:** Any references made to arbitration contained in this Contract, Vendor's bid, or in any American Institute of Architects documents pertaining to this Contract are hereby deleted, void, and of no effect.

**24. MODIFICATIONS:** This writing is the parties' final expression of intent. Notwithstanding anything contained in this Contract to the contrary no modification of this Contract shall be binding without mutual written consent of the Agency, and the Vendor, with approval of the Purchasing Division and the Attorney General's office (Attorney General approval is as to form only). Any change to existing contracts that adds work or changes contract cost, and were not included in the original contract, must be approved by the Purchasing Division and the Attorney General's Office (as to form) prior to the implementation of the change or commencement of work affected by the change.

Revised 04/07/2017

**25. WAIVER:** The failure of either party to insist upon a strict performance of any of the terms or provision of this Contract, or to exercise any option, right, or remedy herein contained, shall not be construed as a waiver or a relinquishment for the future of such term, provision, option, right, or remedy, but the same shall continue in full force and effect. Any waiver must be expressly stated in writing and signed by the waiving party.

**26. SUBSEQUENT FORMS:** The terms and conditions contained in this Contract shall supersede any and all subsequent terms and conditions which may appear on any form documents submitted by Vendor to the Agency or Purchasing Division such as price lists, order forms, invoices, sales agreements, or maintenance agreements, and includes internet websites or other electronic documents. Acceptance or use of Vendor's forms does not constitute acceptance of the terms and conditions contained thereon.

**27. ASSIGNMENT:** Neither this Contract nor any monies due, or to become due hereunder, may be assigned by the Vendor without the express written consent of the Agency, the Purchasing Division, the Attorney General's office (as to form only), and any other government agency or office that may be required to approve such assignments. Notwithstanding the foregoing, Purchasing Division approval may or may not be required on certain agency delegated or exempt purchases.

**28. WARRANTY:** The Vendor expressly warrants that the goods and/or services covered by this Contract will: (a) conform to the specifications, drawings, samples, or other description furnished or specified by the Agency; (b) be merchantable and fit for the purpose intended; and (c) be free from defect in material and workmanship.

**29. STATE EMPLOYEES:** State employees are not permitted to utilize this Contract for personal use and the Vendor is prohibited from permitting or facilitating the same.

**30. BANKRUPTCY:** In the event the Vendor files for bankruptcy protection, the State of West Virginia may deem this Contract null and void, and terminate this Contract without notice.

**31. PRIVACY, SECURITY, AND CONFIDENTIALITY:** The Vendor agrees that it will not disclose to anyone, directly or indirectly, any such personally identifiable information or other confidential information gained from the Agency, unless the individual who is the subject of the information consents to the disclosure in writing or the disclosure is made pursuant to the Agency's policies, procedures, and rules. Vendor further agrees to comply with the Confidentiality Policies and Information Security Accountability Requirements, set forth in <http://www.state.wv.us/admin/purchase/privacy/default.html>.

**32. YOUR SUBMISSION IS A PUBLIC DOCUMENT:** Vendor's entire response to the Solicitation and the resulting Contract are public documents. As public documents, they will be disclosed to the public following the bid/proposal opening or award of the contract, as required by the competitive bidding laws of West Virginia Code §§ 5A-3-1 et seq., 5-22-1 et seq., and 5G-1-1 et seq. and the Freedom of Information Act West Virginia Code §§ 29B-1-1 et seq.

**DO NOT SUBMIT MATERIAL YOU CONSIDER TO BE CONFIDENTIAL, A TRADE SECRET, OR OTHERWISE NOT SUBJECT TO PUBLIC DISCLOSURE.**

Submission of any bid, proposal, or other document to the Purchasing Division constitutes your explicit consent to the subsequent public disclosure of the bid, proposal, or document. The Purchasing Division will disclose any document labeled "confidential," "proprietary," "trade secret," "private," or labeled with any other claim against public disclosure of the documents, to include any "trade secrets" as defined by West Virginia Code § 47-22-1 et seq. All submissions are subject to public disclosure without notice.

**33. LICENSING:** In accordance with West Virginia Code of State Rules § 148-1-6.1.e, Vendor must be licensed and in good standing in accordance with any and all state and local laws and requirements by any state or local agency of West Virginia, including, but not limited to, the West Virginia Secretary of State's Office, the West Virginia Tax Department, West Virginia Insurance Commission, or any other state agency or political subdivision. Upon request, the Vendor must provide all necessary releases to obtain information to enable the Purchasing Division Director or the Agency to verify that the Vendor is licensed and in good standing with the above entities.

**34. ANTITRUST:** In submitting a bid to, signing a contract with, or accepting a Award Document from any agency of the State of West Virginia, the Vendor agrees to convey, sell, assign, or transfer to the State of West Virginia all rights, title, and interest in and to all causes of action it may now or hereafter acquire under the antitrust laws of the United States and the State of West Virginia for price fixing and/or unreasonable restraints of trade relating to the particular commodities or services purchased or acquired by the State of West Virginia. Such assignment shall be made and become effective at the time the purchasing agency tenders the initial payment to Vendor.

**35. VENDOR CERTIFICATIONS:** By signing its bid or entering into this Contract, Vendor certifies (1) that its bid or offer was made without prior understanding, agreement, or connection with any corporation, firm, limited liability company, partnership, person or entity submitting a bid or offer for the same material, supplies, equipment or services; (2) that its bid or offer is in all respects fair and without collusion or fraud; (3) that this Contract is accepted or entered into without any prior understanding, agreement, or connection to any other entity that could be considered a violation of law; and (4) that it has reviewed this Solicitation in its entirety; understands the requirements, terms and conditions, and other information contained herein.

Vendor's signature on its bid or offer also affirms that neither it nor its representatives have any interest, nor shall acquire any interest, direct or indirect, which would compromise the performance of its services hereunder. Any such interests shall be promptly presented in detail to the Agency. The individual signing this bid or offer on behalf of Vendor certifies that he or she is authorized by the Vendor to execute this bid or offer or any documents related thereto on Vendor's behalf; that he or she is authorized to bind the Vendor in a contractual relationship; and that, to the best of his or her knowledge, the Vendor has properly registered with any State agency that may require registration.

**36. VENDOR RELATIONSHIP:** The relationship of the Vendor to the State shall be that of an independent contractor and no principal-agent relationship or employer-employee relationship is contemplated or created by this Contract. The Vendor as an independent contractor is solely liable for the acts and omissions of its employees and agents. Vendor shall be responsible for selecting, supervising, and compensating any and all individuals employed pursuant to the terms of this Solicitation and resulting contract. Neither the Vendor, nor any employees or subcontractors of the Vendor, shall be deemed to be employees of the State for any purpose whatsoever. Vendor shall be exclusively responsible for payment of employees and contractors for all wages and salaries, taxes, withholding payments, penalties, fees, fringe benefits, professional liability insurance premiums, contributions to insurance and pension, or other deferred compensation plans, including but not limited to, Workers' Compensation and Social Security obligations, licensing fees, etc. and the filing of all necessary documents, forms, and returns pertinent to all of the foregoing.

Vendor shall hold harmless the State, and shall provide the State and Agency with a defense against any and all claims including, but not limited to, the foregoing payments, withholdings, contributions, taxes, Social Security taxes, and employer income tax returns.

**37. INDEMNIFICATION:** The Vendor agrees to indemnify, defend, and hold harmless the State and the Agency, their officers, and employees from and against: (1) Any claims or losses for services rendered by any subcontractor, person, or firm performing or supplying services, materials, or supplies in connection with the performance of the Contract; (2) Any claims or losses resulting to any person or entity injured or damaged by the Vendor, its officers, employees, or subcontractors by the publication, translation, reproduction, delivery, performance, use, or disposition of any data used under the Contract in a manner not authorized by the Contract, or by Federal or State statutes or regulations; and (3) Any failure of the Vendor, its officers, employees, or subcontractors to observe State and Federal laws including, but not limited to, labor and wage and hour laws.

**38. PURCHASING AFFIDAVIT:** In accordance with West Virginia Code § 5A-3-10a, all Vendors are required to sign, notarize, and submit the Purchasing Affidavit stating that neither the Vendor nor a related party owe a debt to the State in excess of \$1,000. The affidavit must be submitted prior to award, but should be submitted with the Vendor's bid. A copy of the Purchasing Affidavit is included herewith.

**39. ADDITIONAL AGENCY AND LOCAL GOVERNMENT USE:** This Contract may be utilized by other agencies, spending units, and political subdivisions of the State of West Virginia; county, municipal, and other local government bodies; and school districts ("Other Government Entities"). Any extension of this Contract to the aforementioned Other Government Entities must be on the same prices, terms, and conditions as those offered and agreed to in this Contract, provided that such extension is in compliance with the applicable laws, rules, and ordinances of the Other Government Entity. If the Vendor does not wish to extend the prices, terms, and conditions of its bid and subsequent contract to the Other Government Entities, the Vendor must clearly indicate such refusal in its bid. A refusal to extend this Contract to the Other Government Entities shall not impact or influence the award of this Contract in any manner.

**40. CONFLICT OF INTEREST:** Vendor, its officers or members or employees, shall not presently have or acquire an interest, direct or indirect, which would conflict with or compromise the performance of its obligations hereunder. Vendor shall periodically inquire of its officers, members and employees to ensure that a conflict of interest does not arise. Any conflict of interest discovered shall be promptly presented in detail to the Agency.

**41. REPORTS:** Vendor shall provide the Agency and/or the Purchasing Division with the following reports identified by a checked box below:

Such reports as the Agency and/or the Purchasing Division may request. Requested reports may include, but are not limited to, quantities purchased, agencies utilizing the contract, total contract expenditures by agency, etc.

Quarterly reports detailing the total quantity of purchases in units and dollars, along with a listing of purchases by agency. Quarterly reports should be delivered to the Purchasing Division via email at [purchasing.requisitions@wv.gov](mailto:purchasing.requisitions@wv.gov).

**42. BACKGROUND CHECK:** In accordance with W. Va. Code § 15-2D-3, the Director of the Division of Protective Services shall require any service provider whose employees are regularly employed on the grounds or in the buildings of the Capitol complex or who have access to sensitive or critical information to submit to a fingerprint-based state and federal background inquiry through the state repository. The service provider is responsible for any costs associated with the fingerprint-based state and federal background inquiry.

After the contract for such services has been approved, but before any such employees are permitted to be on the grounds or in the buildings of the Capitol complex or have access to sensitive or critical information, the service provider shall submit a list of all persons who will be physically present and working at the Capitol complex to the Director of the Division of Protective Services for purposes of verifying compliance with this provision. The State reserves the right to prohibit a service provider's employees from accessing sensitive or critical information or to be present at the Capitol complex based upon results addressed from a criminal background check.

Service providers should contact the West Virginia Division of Protective Services by phone at (304) 558-9911 for more information.



**43. PREFERENCE FOR USE OF DOMESTIC STEEL PRODUCTS:** Except when authorized by the Director of the Purchasing Division pursuant to W. Va. Code § 5A-3-56, no contractor may use or supply steel products for a State Contract Project other than those steel products made in the United States. A contractor who uses steel products in violation of this section may be subject to civil penalties pursuant to W. Va. Code § 5A-3-56. As used in this section:

a. "State Contract Project" means any erection or construction of, or any addition to, alteration of or other improvement to any building or structure, including, but not limited to, roads or highways, or the installation of any heating or cooling or ventilating plants or other equipment, or the supply of and materials for such projects, pursuant to a contract with the State of West Virginia for which bids were solicited on or after June 6, 2001.

b. "Steel Products" means products rolled, formed, shaped, drawn, extruded, forged, cast, fabricated or otherwise similarly processed, or processed by a combination of two or more or such operations, from steel made by the open heath, basic oxygen, electric furnace, Bessemer or other steel making process. The Purchasing Division Director may, in writing, authorize the use of foreign steel products if:

c. The cost for each contract item used does not exceed one tenth of one percent (.1%) of the total contract cost or two thousand five hundred dollars (\$2,500.00), whichever is greater. For the purposes of this section, the cost is the value of the steel product as delivered to the project; or

d. The Director of the Purchasing Division determines that specified steel materials are not produced in the United States in sufficient quantity or otherwise are not reasonably available to meet contract requirements.

**44. PREFERENCE FOR USE OF DOMESTIC ALUMINUM, GLASS, AND STEEL:** In Accordance with W. Va. Code § 5-19-1 et seq., and W. Va. CSR § 148-10-1 et seq., for every contract or subcontract, subject to the limitations contained herein, for the construction, reconstruction, alteration, repair, improvement or maintenance of public works or for the purchase of any item of machinery or equipment to be used at sites of public works, only domestic aluminum, glass or steel products shall be supplied unless the spending officer determines, in writing, after the receipt of offers or bids, (1) that the cost of domestic aluminum, glass or steel products is unreasonable or inconsistent with the public interest of the State of West Virginia, (2) that domestic aluminum, glass or steel products are not produced in sufficient quantities to meet the contract requirements, or (3) the available domestic aluminum, glass, or steel do not meet the contract specifications. This provision only applies to public works contracts awarded in an amount more than fifty thousand dollars (\$50,000) or public works contracts that require more than ten thousand pounds of steel products.

The cost of domestic aluminum, glass, or steel products may be unreasonable if the cost is more than twenty percent (20%) of the bid or offered price for foreign made aluminum, glass, or steel products. If the domestic aluminum, glass or steel products to be supplied or produced in a "substantial labor surplus area", as defined by the United States Department of Labor, the cost of domestic aluminum, glass, or steel products may be unreasonable if the cost is more than thirty percent (30%) of the bid or offered price for foreign made aluminum, glass, or steel products. This preference shall be applied to an item of machinery or equipment, as indicated above, when the item is a single unit of equipment or machinery manufactured primarily of aluminum, glass or steel, is part of a public works contract and has the sole purpose or of being a permanent part of a single public works project. This provision does not apply to equipment or machinery purchased by a spending unit for use by that spending unit and not as part of a single public works project.

All bids and offers including domestic aluminum, glass or steel products that exceed bid or offer prices including foreign aluminum, glass or steel products after application of the preferences provided in this provision may be reduced to a price equal to or lower than the lowest bid or offer price for foreign aluminum, glass or steel products plus the applicable preference. If the reduced bid or offer prices are made in writing and supersede the prior bid or offer prices, all bids or offers, including the reduced bid or offer prices, will be reevaluated in accordance with this rule.

**DESIGNATED CONTACT:** Vendor appoints the individual identified in this Section as the Contract Administrator and the initial point of contact for matters relating to this Contract.

Matt Cochran Reg. Sales Mgr.  
(Name, Title)

Matt Cochran, Regional Sales Manager  
(Printed Name and Title)

5050 US Route 60 East, Huntington, WV 25705  
(Address)

304-345-2490 office, 304-208-2542 cell, 304-759-9807 Fax  
(Phone Number) / (Fax Number)

Matt.Cochran@thetruckpeople.com  
(email address)

**CERTIFICATION AND SIGNATURE:** By signing below, or submitting documentation through wvOASIS, I certify that I have reviewed this Solicitation in its entirety; that I understand the requirements, terms and conditions, and other information contained herein; that this bid, offer or proposal constitutes an offer to the State that cannot be unilaterally withdrawn; that the product or service proposed meets the mandatory requirements contained in the Solicitation for that product or service, unless otherwise stated herein; that the Vendor accepts the terms and conditions contained in the Solicitation, unless otherwise stated herein; that I am submitting this bid, offer or proposal for review and consideration; that I am authorized by the vendor to execute and submit this bid, offer, or proposal, or any documents related thereto on vendor's behalf; that I am authorized to bind the vendor in a contractual relationship; and that to the best of my knowledge, the vendor has properly registered with any State agency that may require registration.

Worldwide Equipment  
(Company)

Matt Cochran Regional Sales Mgr.  
(Authorized Signature) (Representative Name, Title)

Matt Cochran, Regional Sales Manager  
(Printed Name and Title of Authorized Representative)

08/15/2017  
(Date)

304-345-2490 office, 304-208-2542 cell, 304-759-9807 Fax  
(Phone Number) (Fax Number)

CRFQ 0803 DOT1700000088  
REQUEST FOR QUOTATION  
**64,000 GVWR Tandem Axle Dump Truck**  
**w/Front Snow Plow, V-Box Spreader, with Optional Right Front Wing Plow and Anti-Icing Tank & Spray System**

---

**SPECIFICATIONS**

1. **PURPOSE AND SCOPE:** The West Virginia Purchasing Division is soliciting bids on behalf of the West Virginia Division of Highways, Department of Transportation to establish an open-end contract for a 64,000 GVWR Tandem Axle Dump Truck with Snow Plow, Spreader and Central Hydraulic System with Stainless Steel Bed Body, Right Side Wing Plow Option, Anti-Icing Tank option, and Spray System option.
  
2. **DEFINITIONS:** The terms listed below shall have the meanings assigned to them below. Additional definitions can be found in section 2 of the General Terms and Conditions.
  - 2.1 **“Contract Item” or “Contract Items”** means the list of items identified in Section 3.1, below and on the Pricing Pages.
  - 2.2 **“Pricing Pages”** means the schedule of prices, estimated order quantity, and totals contained in wvOASIS or attached hereto as **Exhibit A**, and used to evaluate the Solicitation response.
  - 2.3 **“Solicitation”** means the official notice of an opportunity to supply the State with goods or services that is published by the Purchasing Division.
  - 2.4 **“G.V.W.”** means gross vehicle weight.
  - 2.5 **“G.V.W.R”** means gross vehicle weight rating.
  - 2.6 **“Lbs.”** means pounds.
  - 2.7 **“BBC”** means Bumper to back of cab.
  - 2.8 **“PSI”** means pounds per square inch.
  - 2.9 **“WVDOH”** means West Virginia Division of Highways.
  - 2.10 **“R.B.M.”** means Resisting Bending Moment.
  - 2.11 **“PTO”** means power take off.
  - 2.12 **“RPM”** means revolutions per minute.
  - 2.13 **“APADS”** means Air conditioning protection and diagnostic system.
  - 2.14 **“HP”** means horse power.

CRFQ 0803 DOT1700000088  
REQUEST FOR QUOTATION  
**64,000 GVWR Tandem Axle Dump Truck**  
**w/Front Snow Plow, V-Box Spreader, with Optional Right Front Wing Plow and Anti-  
Icing Tank & Spray System**

---

- 2.15 “F” means Fahrenheit.
- 2.16 “FMVSS” means Federal Motor Vehicle Safety Standards. [www.fmvss.com](http://www.fmvss.com)
- 2.17 “CCA” means cold cranking amps.
- 2.18 “SAE” means Society of Automotive Engineers.
- 2.19 “ABS” means Antilock Braking System.
- 2.20 “ATC” means Automatic Traction Control
- 2.21 “MPH” means miles per hour.
- 2.22 “cu. ft.” means cubic feet.
- 2.23 “mm” means millimeter.
- 2.24 “cu. yd.” means cubic yard.
- 2.25 “I.D.” means inner diameter.
- 2.26 “GPM” means gallons per minute.
- 2.27 “LED” means light emitting diode.
- 2.28 “UV” means ultra violet.
- 2.29 “C” means celsius.
- 2.30 “N.T.E.A” means National Truck Equipment Association. [www.ntea.com](http://www.ntea.com)
- 2.31 “ISO” means International Standards Organization.
- 2.32 “SO” means Standard Oil Resistant.
- 2.33 “NEMA” means National Electrical Manufacturer’s Association.
- 2.34 “dba” means decibels.
- 2.35 “PWM” means pulse-width modulated.
- 2.36 “NPT” means National Pipe Thread.

CRFQ 0803 DOT1700000088  
REQUEST FOR QUOTATION  
**64,000 GVWR Tandem Axle Dump Truck**  
**w/Front Snow Plow, V-Box Spreader, with Optional Right Front Wing Plow and Anti-Icing Tank & Spray System**

---

2.37 “TRT” means tamper resistant.

2.38 “cc” means close-coupled.

2.39 “CAN” means control area network.

2.40 “CIR” means Cubic Inches revolution.

2.41 “SS” means Stainless Steel

2.42 “OD” means Outside Diameter

2.43 “JIC” means Joint Industry Council

2.44 “mA” means milliamps

2.45 “AASHTO” means American Association of State Highway and Transportation.  
[www.transportation.org](http://www.transportation.org)

2.46 “CA” means cab to axle.

2.47 “CT” means cab to trunnion.

2.48 “12 VDC” means 12 volt direct current.

2.49 “OEM” means Original Equipment Manufacturer.

2.50 “BTU” means British Thermal Unit.

2.51 “USB” means Universal Serial Bus.

2.52 “WC” means tungsten carbide.

### 3. GENERAL REQUIREMENTS:

**3.1 Contract Items and Mandatory Requirements:** Vendor shall provide Agency with the Contract Items listed below on an open-end and continuing basis. Contract Items must meet or exceed the mandatory requirements as shown below.

#### 3.1.1 Cab and Chassis:

3.1.1.1 The GVWR rating shall be 64,000 Lbs., minimum rating.

CRFQ 0803 DOT1700000088  
REQUEST FOR QUOTATION  
**64,000 GVWR Tandem Axle Dump Truck**  
**w/Front Snow Plow, V-Box Spreader, with Optional Right Front Wing Plow and Anti-Icing Tank & Spray System**

---

- 3.1.1.2 Cab to Axle Dimension: Shall be 116 inches minimum usable. (Back of cab to centerline of trunnion).
- 3.1.1.3 The after-frame length shall be 60 inches minimum. (Centerline of trunnion to back of frame).
- 3.1.1.4 The unit specified herein and offered shall be manufactured on or after January 1, 2017 and will be clearly identified and marked with date of manufacture.
- 3.1.1.5 The unit offered must meet or exceed the “Occupational Safety and Health Act of 1970” or subsequent changes that are in effect at the time of manufacture of the unit. See **Exhibit C** OSHA Act of 1970.

**3.1.2 Wheelbase:**

- 3.1.2.1 Shall be 202 inches minimum, and shall be set forward axle design for snowplow applications.
- 3.1.2.2 Wheelbase and Cab dimension shall be adjusted to provide legal weight distribution.
  - 3.1.2.2.1 Chassis OEM and body company are responsible for coordinating the correct CA/CT calculations.
    - 3.1.2.2.1.1 This will be discussed at Pre-Build Meeting.
- 3.1.2.3. BBC (Bumper to Back of Cab) shall be 111 inches minimum to 120 inches maximum dimension excluding frame extension.

**3.1.3 Frame:**

- 3.1.3.1 The manufacturer shall provide a frame that meets or exceeds all Federal requirements for G.V.W.R. specified that extends forward beyond the grille a minimum of 14 inches.
- 3.1.3.2 Frame material shall be single frame minimum 120,000 PSI yield strength. Frame extension shall be “parent rail” material. Bolt on extension not acceptable.
- 3.1.3.3 R.B.M: Minimum 2,820,000 Ins./Lb. per rail. An integral frame and frame extension is mandatory.
- 3.1.3.4 Frame shall have two (2) front frame mounted tow hooks.

CRFQ 0803 DOT1700000088  
REQUEST FOR QUOTATION  
**64,000 GVWR Tandem Axle Dump Truck**  
**w/Front Snow Plow, V-Box Spreader, with Optional Right Front Wing Plow and Anti-  
Icing Tank & Spray System**

---

**3.1.3.5** Front bumper shall be formed out of ¼ inch minimum roll steel front bumper with swept back ends.

**3.1.3.6** Bumper shall be painted black in color, paint type base coat clear urethane.

**3.1.3.7** Bumper shall not interfere with factory headlights.

**3.1.3.8** Bumper shall have mesh type aluminum tread plate between bumper and fender.

**3.1.3.9** Bumper shall have cutouts to access front tow hooks.

**3.1.4 Cab:**

**3.1.4.1** The cab shall be manufacturers' galvanized steel, galvanized steel or aluminum.

**3.1.4.2** Hood shall be fiberglass, one piece tilting hood, fenders shall be part of tilting hood.

**3.1.4.3** Hood shall have a minimum front slope of 20 degrees for snow plowing visibility.

**3.1.4.4** Front fenders shall have extensions to cover the width of the front tires.

**3.1.4.5** Grille shall be fixed.

**3.1.4.6** Hood shall not come in contact with plow frame or wing plow frames.

**3.1.4.7** Must allow access to engine with hood open.

**3.1.4.7.1** Access to front-end hood tilt handle shall not be blocked.

**3.1.4.8** Cab shall have rear air bag suspension, factory installed.

**3.1.4.9** Cab shall have air ride high back seats with folding armrest, black cloth, with lumbar, with integrated cushion extensions, with forward and rear cushion tilt – Driver and Passenger side.

**3.1.4.10** Cab Interior Floor Mat shall have rubber floor mat throughout cab area with non-absorbent backing under the mat.

**3.1.4.11** Cab shall have highest output available by manufacturers, Air Conditioning with/integral heater and defroster and minimum of one (1) replaceable fresh air filter with APADS.

**3.1.4.12** Windshield Wipers shall be winter blade type with heaviest arms, linkages and motor available by manufacture.

**3.1.4.13** Wipers shall be minimum of 2 speeds, electric with intermittent feature.



CRFQ 0803 DOT1700000088  
REQUEST FOR QUOTATION  
**64,000 GVWR Tandem Axle Dump Truck**  
**w/Front Snow Plow, V-Box Spreader, with Optional Right Front Wing Plow and Anti-  
Icing Tank & Spray System**

---

**3.1.4.14** Washer system shall be electric with largest capacity reservoir available by manufacturer.

**3.1.5 Instruments: The following instruments shall be contained in the truck cab.**

- 3.1.5.1** Coolant gauge and oil pressure gauge shall have both dial type readout and either an audible or visual alarm to warn operator when safe operating conditions are exceeded.
- 3.1.5.2** Voltmeter or Ammeter gauge.
- 3.1.5.3** Engine RPM Tachometer.
- 3.1.5.4** Speedometer with odometer and a dual speedometer lead to interface with the ground speed spreader control system.
- 3.1.5.5** Primary Air Pressure Gauge/Auxiliary Air Pressure Gauge.
- 3.1.5.6** If unit is equipped with front air intake, it shall be operated by a cable, air or electrical control valve to enable operator to divert air intake to engine compartment during plowing application shall be provided.
- 3.1.5.7** Air filter restriction indicator gauge.
- 3.1.5.8** Engine hour meter (Controlled by engine operation, not by key switch).
- 3.1.5.9** Must have Fuel level gauge and diesel exhaust fluid gauge.
- 3.1.5.10** Manufacturers best sound/weather insulation package for proposed cab.
- 3.1.5.11** Cab shall have transmission temperature gauge.

**3.1.6 Accessories: The following accessories must be included with the truck cab & chassis:**

- 3.1.6.1** Cab shall have minimum of one air horn cab mounted with snow shield.
- 3.1.6.2** Right side and left side cab mirrors: Cab mirrors shall be west coast type 7 inches wide minimum x 16 inches high minimum, power adjustable with fore and after breakaway arms. 8 inches minimum convex spot mirror. Both mirrors must be heated type with all arms, hardware and fasteners stainless steel.
- 3.1.6.3** Shall have down view mirror, right hand side only.
- 3.1.6.4** Grab handles shall be supplied on all cab entry locations. Three points of contact shall be achievable at all cab entry locations.

CRFQ 0803 DOT1700000088  
REQUEST FOR QUOTATION  
**64,000 GVWR Tandem Axle Dump Truck**  
**w/Front Snow Plow, V-Box Spreader, with Optional Right Front Wing Plow and Anti-  
Icing Tank & Spray System**

---

- 3.1.6.5** The cab shall have the manufacturer's standard tinted safety glass installed throughout the front, sides and rear.
- 3.1.6.6** The front windshield shall be heated.
- 3.1.6.7** The cab shall have dual power windows.
  
- 3.1.6.8** The cab shall have manufacturer's standard AM/FM/Weather Band/Clock with wireless connectivity.
- 3.1.6.9** CB mounting provisions on top of dash and/or overhead console with power and ground.
- 3.1.6.10** CB antenna mounted and wired.
- 3.1.6.11** Radio antenna shall be separate from CB antenna.
- 3.1.6.12** Mud flaps shall be provided and installed on the cab behind the left and right front tires.
- 3.1.6.13** Cab shall contain a DOT approved emergency triangle warning kit.
- 3.1.6.14** The cab shall have a mounted 5 lbs. maximum fire extinguisher with A, B and C rating.
- 3.1.6.15** Cab shall have clear or smoked hood mounted air deflector, manufacturer's full width for truck model.
- 3.1.6.16** Cab shall have six (6) additional switches.
- 3.1.6.17** Cab shall have OEM PTO switch.
- 3.1.6.18** Accessories not indicated above, but are included in the manufacturer's standard model bid must be provided.

**3.1.7 Engine:**

- 3.1.7.1** The engine shall be a diesel powered.
  - 3.1.7.1.1** 12.8-liter minimum.
  - 3.1.7.1.2** 6-cylinder minimum.
  - 3.1.7.1.3** peak HP, 455 @ 1500-1700 RPM minimum.
  - 3.1.7.1.4** torque 1700 LB/FT @ 1300 RPM minimum.
  - 3.1.7.1.5** Engine must meet US 17 emissions.
- 3.1.7.2** Engine Compression Brake: Must be full engine compression brake minimum 2 stages with selector switch and on/off power switch and shall be dash mounted.
- 3.1.7.3** Engine oil pan must be stainless steel installed with stainless steel hardware.
- 3.1.7.4** Air filter shall be largest volume available offered by manufacturer for severe duty conditions.

CRFQ 0803 DOT1700000088  
REQUEST FOR QUOTATION  
**64,000 GVWR Tandem Axle Dump Truck**  
**w/Front Snow Plow, V-Box Spreader, with Optional Right Front Wing Plow and Anti-Icing Tank & Spray System**

---

**3.1.8 Exhaust System:**

- 3.1.8.1 Manufacturers standard side of cab exhaust for model bid.
- 3.1.8.2 Exhaust system shall not interfere with the dump body or equipment.
- 3.1.8.3 Exhaust shall be stainless steel with all clamps and fasteners being stainless steel.
- 3.1.8.4 Muffler and tailpipe shall be shielded to protect personnel when entering and exiting the cab.
- 3.1.8.5 The shield shall be 180 degrees to 360 degrees and shall be of non-rustable material such as stainless steel or aluminum.

**3.1.9 Cooling System:**

- 3.1.9.1 The largest available engine cooling capacity, factory compatible with engine and transmission referenced for continuous high engine output under extreme temperatures and/or operating conditions due to prolonged snow plowing operations in low gear.
- 3.1.9.2 Cooling system shall be fitted with provisions for visually monitoring coolant without necessitating removal of the cap from the radiator or expansion tank.
- 3.1.9.3 Antifreeze shall be extended life with a minimum of -34 degrees and shall meet all applicable Environmental Protection Agency (EPA) requirements.
- 3.1.9.4 A non-charged spin-on coolant filter shall be installed if required by engine manufacturer.
- 3.1.9.5 Radiator shall have stainless steel screen guard to protect radiator from foreign objects.
- 3.1.9.6 All coolant piping must be stainless steel.
- 3.1.9.7 All coolant hoses shall be silicone base hoses.
- 3.1.9.8 All hose clamps shall be stainless steel.

**3.1.10 Fuel Tanks:**

- 3.1.10.1 Fuel Tanks must comply with FMVSS.
- 3.1.10.2 Single aluminum 110-gallon minimum fuel tank, shall be mounted left side, under cab, frame-mounted with stainless steel mounting straps.

CRFQ 0803 DOT1700000088  
REQUEST FOR QUOTATION  
**64,000 GVWR Tandem Axle Dump Truck**  
**w/Front Snow Plow, V-Box Spreader, with Optional Right Front Wing Plow and Anti-  
Icing Tank & Spray System**

---

**3.1.10.3** Must have driver and passenger entrance steps, stainless steel or aluminum grated self-cleaning safety steps.

**3.1.11 Transmission:**

**3.1.11.1** Transmission shall be fully automatic, wide ratio with torque converter, minimum of 6 forward gears and 1 reverse gear.

**3.1.11.2** Transmission shall have provision for PTO.

**3.1.11.3** Shall have a transmission shift pad, with oil life monitor; filter life monitor and transmission health monitor, lighted and dash or console mounted in cab.

**3.1.11.4** Transmission shall have largest available approved transmission cooler for transmission provided.

**3.1.11.4.1** All cooler hard lines must be stainless steel.

**3.1.12 Driveline:**

**3.1.12.1** Driveline must be compatible to engine, drivetrain and transmission torque. If required by manufacturer, driveline shall have center carrier bearing.

**3.1.13 Rear Axle:**

**3.1.13.1** Shall be dual reduction with a power divider lockout, dashed controlled, minimum rating of 44,000 lbs.

**3.1.13.2** Rear axle housing shall be heaviest available steel housing manufacturer offers with magnetic drain plug.

**3.1.13.3** All rear axles shall have an extended breather tube to prevent buildup from entering axle housing.

**3.1.13.4** Axle ratio and top MPH parameters to be determined at pre-build meeting.

**3.1.14 Rear Suspension:**

**3.1.14.1** Shall have multi-leaf spring type rated for 44,000 lb. minimum capacity.

**3.1.14.2** Must have greasable pins and must have greasable bronze bushing at trunnion.

CRFQ 0803 DOT1700000088  
REQUEST FOR QUOTATION  
**64,000 GVWR Tandem Axle Dump Truck**  
**w/Front Snow Plow, V-Box Spreader, with Optional Right Front Wing Plow and Anti-Icing Tank & Spray System**

---

**3.1.15 Front Axle:**

**3.1.15.1** Shall have minimum capacity of 20,000 lbs.

**3.1.15.2** The front axle, drag links and tie rod ends shall have threaded grease zerks installed.

**3.1.15.3** Shall have right and left shock absorbers rated for 20,000 lb. minimum, axle.

**3.1.16 Front Suspension:**

**3.1.16.1** Shall have 10,000 lb. minimum capacity at ground on each front spring, total spring capacity 20,000 lb. minimum.

**3.1.16.2** The front spring pins or bearing/bushings shall be furnished with 360-degree grease grooves to insure adequate lubricant penetration. (Rubber is not acceptable).

**3.1.16.3** Spring hangers shall be heaviest available by manufacturer.

**3.1.17 Steering:**

**3.1.17.1** Shall have right and left steering gear dual power which meets or exceeds a 20,000-lb. front axle.

**3.1.17.2** Steering column shall be tilt and/telescopic.

**3.1.18 Brakes and Air System:**

**3.1.18.1** Brakes shall be full air, with manufacturer's ABS.

**3.1.18.2** Compressor shall be manufacturer's largest for model bid.

**3.1.18.2.1** Shall have air dryer compatible with heater and spin on cartridge filter.

**3.1.18.3** Rear parking brakes shall be spring loaded.

**3.1.18.4** Rear service brake chambers and spring brake chambers shall be mounted to provide clearance for tire chains and backing into bituminous paving machines.

**3.1.18.4.1** Factory installation only.

**3.1.18.5** Air tanks shall be frame mounted aluminum or stainless steel with drain valve.

CRFQ 0803 DOT1700000088  
REQUEST FOR QUOTATION  
**64,000 GVWR Tandem Axle Dump Truck**  
**w/Front Snow Plow, V-Box Spreader, with Optional Right Front Wing Plow and Anti-Icing Tank & Spray System**

---

**3.1.18.6** Unit shall be equipped with hand control valve, tractor protection valve, with swivel glad hands at rear of truck to enable unit to pull air operated equipment trailer.

**3.1.18.7** Shall have low warning air pressure warning light and buzzer.

**3.1.18.8** Front brakes: shall be full air powered disc brakes.

**3.1.18.9** Rear brakes shoes shall be full air self-adjusting cam brakes.

**3.1.18.10** Rear brakes shall have automatic slack adjuster with stainless steel yoke pins.

**3.1.19 Trailer Tow Package shall include the following:**

**3.1.19.1** A 49,000 LB. minimum capacity pintle hook shall be installed at 32 inches maximum above ground on a  $\frac{3}{4}$  inch thick minimum pintle plate properly supported to frame and cross members.

**3.1.19.1.1** Shall include two one inch D-rings.

**3.1.19.2** The truck shall be equipped with a full trailer air brake package.

**3.1.19.2.1** The glad hand connections shall be located at the rear of truck and located with red (emergency) on driver's side and blue (service) on passenger side.

**3.1.19.2.2** Glad hands shall be swivel design.

**3.1.19.3** Truck shall be equipped with air actuated electric trailer brake controller, mounted in cab.

**3.1.19.4** There shall be two 7-poll female trailer connectors with round brass inserts mounted in a corrosion resistant housing.

**3.1.19.4.1** One shall be for trailer lighting with electric brakes and one for trailer lighting with air brakes.

**3.1.19.4.2** Both connectors shall be permanently labeled.

**3.1.20 Tires and Wheels:**

**3.1.20.1** The truck shall be equipped with hub piloted satin aluminum disc wheels for tubeless tires.

CRFQ 0803 DOT1700000088  
REQUEST FOR QUOTATION  
**64,000 GVWR Tandem Axle Dump Truck**  
**w/Front Snow Plow, V-Box Spreader, with Optional Right Front Wing Plow and Anti-  
Icing Tank & Spray System**

---

- 3.1.20.2** Front Steer Tires: must be size 315/80/R22.5 load range L 20 ply tubeless minimum, and have a 10,000 lb. minimum weight rating per tire.
- 3.1.20.3** Front Wheels: must be 22.5 x 9.0, 10 hole, 15 degree, hub piloted, tubeless, satin finish aluminum wheel, rated at 10,000 lb. at maximum tire pressure of 130 PSI. Wheel must be resistant to common chemicals used in de-icing road surface such as salt, calcium chloride and brine.
- 3.1.20.4** Rear Drive Tires: must be mud and snow tread, size 11R/22.5 minimum load range H, 14 ply tubeless. Minimum load limit dual 5840 lbs per tire.
- 3.1.20.5** Rear Wheels: must be 22.5 x 8.25, 10 hole, tubeless, satin aluminum disc wheel rated at 7,500 lbs. at a maximum inflation pressure of 130 PSI. Wheels must be resistant to common chemicals used in de-icing road surfaces such as salt, calcium chloride and brine.
- 3.1.20.6** The dual rear wheel/tire assembly shall have clearance between the tires, which permits the use of dual tire chain.
- 3.1.20.7** Wheel guard separators shall be installed between wheels and wheel hub front and rear.
- 3.1.20.8** All tires shall be radials.

**3.1.21 Electrical System & Lighting:**

- 3.1.21.1** Shall have manufacturer's 12 volt negative ground system with manufacturer's radio interference suppression.
- 3.1.21.2** Batteries:
  - A.** Shall have minimum of two 12 volt All Glass Mat (AGM) deep cycle batteries stainless steel stud type, with a battery reserve of 200 amp-hours minimum.
  - B.** Shall have one minimum, ultra-capacitor engine module for class 8 trucks, shall be group 31 size, stainless steel stud type, minimum 1800 CCA.
  - C.** See No Idle Heat and Power System Section 3.1.23 for explanation of battery section.
- 3.1.21.3** Alternator capacity shall be 160 AMPS minimum with internal regulator.

CRFQ 0803 DOT1700000088  
REQUEST FOR QUOTATION  
**64,000 GVWR Tandem Axle Dump Truck**  
**w/Front Snow Plow, V-Box Spreader, with Optional Right Front Wing Plow and Anti-  
Icing Tank & Spray System**

---

**3.1.21.4** Cab and chassis must have best available wiring shield available by manufacturer.

**3.1.21.5** The cab and chassis shall have:

- A. Day time running lights.
- B. LED cab marker lights.
- C. Halogen head lamps.
- D. Park and turn signals

**3.1.21.6** Salt spreader lighting package:

Successful vendor shall supply in the left rear corner of the cab exterior for manufacturers approved wiring and weather proof disconnect 7-pole disconnect plug to operate the following lights on truck mounted chemical spreader:

- A. Two (2) sealed beam flood lights.
- B. Left and right combination brake/turn and tail lights LED.
- C. Two LED strobe warning light.

**3.1.21.7** Snowplow headlights with park and turn signal and driving lights for snowplowing application shall be shock mounted on fender of truck with stainless steel brackets.

**3.1.22 Paint, Decals and Logos:**

**3.1.22.1** The cab exterior and interior paint shall be base coat clear coat urethane paint yellow/gold, DuPont F9885, Sherwin Williams 73266, Sikkens 4017, PPG 85246 or Napa 73266 shade only.

**3.1.22.2** The cab grill shall be manufacturer's standard stainless steel.

**3.1.22.3** The cab shall not be painted over top another finished color.

**3.1.22.4** Chassis paint shall be urethane base, chassis color black.

**3.1.23 No Idle Heat and Power System:**



CRFQ 0803 DOT1700000088  
REQUEST FOR QUOTATION  
**64,000 GVWR Tandem Axle Dump Truck**  
**w/Front Snow Plow, V-Box Spreader, with Optional Right Front Wing Plow and Anti-  
Icing Tank & Spray System**

---

**3.1.23.1** The No Idle heat and Power System shall do and include the following:

- A.** The system shall be controlled by a factory dash on/off switch and be properly labeled.
- B.** The system shall provide a dash display of battery voltage and an audible alert when battery voltage needs to be replenished, and automatically disconnect the loads at a predetermined low voltage setting with use of a low voltage disconnect.
- C.** Shall power loads during no-idle conditions with deep cycle AGM batteries for a minimum of 6 hours.
- D.** Shall provide a minimum of 17,000 BTUs of heat for cab and engine.
- E.** Shall provide electrical power to heater blower motor and controls, parking lights, AM/FM radio weather band with wireless connectivity, WVDOH state 2way radio and emergency/ strobe lighting with key in auxiliary position.
- F.** Truck shall use electric start module for engine starting.
- G.** All AGM batteries and electronic start module shall be group 31 and fit in the OEM battery tray without modifications.

**3.2 Dump Body:**

**3.2.1 Stainless Steel Dump Body:** Dump Body to be minimum 201 stainless steel cross memberless. Smooth under side type, suitable for use by WVDOH in severe duty street and highway maintenance including snow and ice control with external mounted cylinder.

**3.2.1.1** Dump Body inside minimum length 168 inches.

**3.2.1.2** Dump Body inside minimum width 86 inches, outside maximum width 96 inches.

**3.2.1.3** Dump Body side height (from bottom of floor to top of top rail) minimum 44 inches high.

**3.2.1.4** Tailgate to be 52" high minimum.

**3.2.1.5** Head sheet to be minimum 64" high.

**3.2.1.6** Sides, head sheet and tailgate to be 7 gauge minimum Type 201 Stainless steel.

**3.2.1.7** Floor shall be minimum one-piece 1/4" thick abrasion resistant with a minimum tensile of 180,000, minimum yield 145,000 and minimum Brinell of 400, with both side radiuses built into the

CRFQ 0803 DOT1700000088  
REQUEST FOR QUOTATION  
**64,000 GVWR Tandem Axle Dump Truck**  
**w/Front Snow Plow, V-Box Spreader, with Optional Right Front Wing Plow and Anti-  
Icing Tank & Spray System**

---

floor.

- 3.2.1.8 Bed sides to be 7 gauge minimum, 201 stainless steel.
- 3.2.1.9 Top rails are to be 4" x 5" minimum seamless, sloping (dirt/salt shedding) and boxed for added strength.
- 3.2.1.10 Bottom rails are to be seamless and sloping (dirt/salt shedding).
- 3.2.1.11 Long sills are to be formed trapezoidal ¼" minimum 201 stainless steel.
  
- 3.2.1.12 Rear apron to be ¼" minimum 8" formed channel.
- 3.2.1.13 There are to be no cross members. Floor to be skip welded to formed stainless steel sills.

**3.2.2 Rear Corner Post, Cab Shield and Sides:**

- 3.2.2.1 To be 1/4" minimum 201 Stainless Steel.
- 3.2.2.2 Top of corner post to be dirt shedding. A 14-1/2" one-piece 7-gauge minimum stainless steel shall be break formed front to back at 5-1/2" and a downward slope remaining at 9".
- 3.2.2.3 The top of post shall house two (2) ½" minimum stainless steel plate brackets to house the top pivot point.
- 3.2.2.4 Tailgate reinforcement plate around the tailgate latch assembly must be ¼" minimum thick.
- 3.2.2.5 Reinforcement plate outside must be 16" tall minimum.
- 3.2.2.6 Reinforcement plate bottom must be 8-3/4" long minimum.
- 3.2.2.7 Reinforcement plate inside bottom height shall be 7-3/8" minimum to the floor.
- 3.2.2.8 Reinforcement plate top shall be 4-1/4" minimum from outside to top of floor sheet.
  - 3.2.2.8.1 All to be continuously welded.
- 3.2.2.9 Three (3) oval factory cut outs for Stop, tail and turn signals, backup, and amber strobe.
- 3.2.2.10 No front corner posts. Head sheet to have mirrored image of three (3) weld on full length horizontal side brace each side and to be continuously welded to side brace, each side.
- 3.2.2.11 Two (2) Intermediate fully welded horizontal side brace, full-length both sides.
- 3.2.2.12 30"x 90" wide cabshield to have Four (4) oval cut out with grommet mounts: Each side, each front corner.
- 3.2.2.13 All Back side of lights must be boxed in with stainless steel.
- 3.2.2.14 Stainless steel tubing shall be used to protect electrical wires between lights.
- 3.2.2.15 Cabshield must be 201 stainless steel minimum.
- 3.2.2.16 There are to be 3" x 8" minimum hard wood sideboards painted black.

CRFQ 0803 DOT1700000088  
REQUEST FOR QUOTATION  
**64,000 GVWR Tandem Axle Dump Truck**  
**w/Front Snow Plow, V-Box Spreader, with Optional Right Front Wing Plow and Anti-Icing Tank & Spray System**

---

**3.2.2.17** The one piece external side sheet must be break formed and wrap under the body floor no less than 10" extended under the body with a continuous welded seam to floor sheet.

**3.2.3 Tailgate Design:**

**3.2.3.1** Shall be double-acting heavy duty tailgate.

**3.2.3.2** Bracing to be full perimeter box type, minimum 6" top and bottom and 4" sides.

**3.2.3.3** There is to be four (4) horizontal brace, mid-section.

**3.2.3.4** Top, bottom, and intermediate horizontal braces to be sloped (dirt/salt shedding).

**3.2.3.5** Top and bottom tailgate pins to be 1-1/2" minimum diameter 201 stainless steel.

**3.2.3.6** Minimum 3/8" stainless steel coil chains to be long enough to hold tailgate in horizontal position if necessary.

**3.2.3.7** Heavy nylon mesh sleeves to be installed over tailgate chains to protect body finish.

**3.2.3.8** Lower latch hooks shall be flame cut from 3/4" minimum 201 stainless Steel minimum plate to secure against two (2) 3/8" minimum 201 stainless steel minimum, corner post mounted latch plates, one (1) set each side of the 3/4" minimum latch hook per side.

**3.2.3.9** There is to be a full width 1" 201 minimum stainless steel diameter (minimum) tailgate release rod at rear of body.

**3.2.3.10** Air tailgate release with spring parking brake chamber mounted center rear of body with dash control.

**3.2.3.11** All tailgate hardware shall be 201 stainless steel minimum.

**3.2.3.12** One (1) Stainless Steel d-ring lift hook mounted on top of tailgate.

**3.2.3.13** Continuous welded body shell (except long sills to floor sheet that are skip welded), cab protector & tailgate.

**3.2.3.14** Stationary 2-1/2" x 20" minimum long grip strut stainless steel steps (two steps) mounted to the front driver's side as far forward as possible on the horizontal side braces.

**3.2.3.14.1** Pull out stainless steel ladder to be mounted below.

**3.2.3.15** Full length 2-1/2" minimum grip strut stainless steel walk rail to be mounted full length on bottom rub rails, both sides.

**3.2.3.16** Full length 1/4" x 1-1/2" minimum flat stock tarp stock mounted to top horizontal side brace, both sides.

**3.2.3.17** One (1) one-piece stainless steel rod grab handles must be mounted on each side of the 20" step.

**3.2.3.18** Front corner of bottom rub rail must be capped with 7GA

CRFQ 0803 DOT1700000088  
REQUEST FOR QUOTATION  
**64,000 GVWR Tandem Axle Dump Truck**  
**w/Front Snow Plow, V-Box Spreader, with Optional Right Front Wing Plow and Anti-  
Icing Tank & Spray System**

---

minimum stainless steel and be on an approximate 60 degree angle.

**3.2.4 Hoist and Rear Hinge Assembly:**

- 3.2.4.1** Heavy duty front telescopic type hoist suitable for use with a Dump body on a road and highway maintenance truck used for snow and ice control, externally mounted of head-sheet.
- 3.2.4.2** Hoist shall be NTEA rated Class 90 No exceptions.
- 3.2.4.3** Forty three thousand pound (43,000 LB.) capacity minimum @ 2000 PSI.
- 3.2.4.4** Hoist shall be double-acting (power up and down full length of stroke).
- 3.2.4.5** Hoist largest diameter stage must be at bottom.
  - 3.2.4.5.1** Inverted cylinder is not acceptable.
- 3.2.4.6** 5.5" inside diameter cylinder base tube (minimum).
- 3.2.4.7** 140" stroke (minimum).
- 3.2.4.8** All cylinder stages to be nitrated for corrosion resistance and wear resistance.
- 3.2.4.9** Internal bore seal design so no packing adjustment or bleeding is required.
- 3.2.4.10** Hoist cylinder to be mounted inside pivoting, trunnion mounted cylinder cover tube.
- 3.2.4.11** Shall have standard heavy duty hoist cradle for trunnion mounted telescopic hoist.
- 3.2.4.12** Mounting height shall not exceed 8" from the top of chassis frame to dump body floor.
- 3.2.4.13** 6" x 8" x 1/2" x 38" minimum long formed angle with 2" minimum 303 stainless steel minimum pins with greaseable pins.
  - 3.2.4.13.1** Each pin is secured by nut/bolt.
- 3.2.4.14** Each pin mounts into two (2) 1/2" minimum plates mounted on two sides to the 6" x 8" x 1/2" minimum formed angle.
  - 3.2.4.14.1** Outside plate for each set must be 1.125" minimum from end angle with pin centers at 32" minimum.
- 3.2.4.15** Each rear hinge block must be a 2-1/2" minimum wide and 3.25" minimum tall plate steel with 5.88" minimum length mounting surface of body to top of block.

CRFQ 0803 DOT1700000088  
REQUEST FOR QUOTATION  
**64,000 GVWR Tandem Axle Dump Truck**  
**w/Front Snow Plow, V-Box Spreader, with Optional Right Front Wing Plow and Anti-Icing Tank & Spray System**

---

**3.2.4.15.1** Each block must accept a 2" minimum dumping stainless steel pivot pin.

**3.2.4.16** Overhang from the center of the rear pivot is to be 18.5" minimum to the end of the floor plate.

**3.2.5 The following bed features shall be included:**

**3.2.5.1** Warning light (bed raised) dash or console mounted.

**3.2.5.2** Mud guards, 10 gauge minimum, 201 stainless steel x 24 inches x 30 inches minimum, permanently attached in front of rear wheel and mounted by stainless steel bracket.

**3.2.5.3** Rear mud flaps: Black, 24" x 36" x 1/2" thick minimum, tire cord reinforced construction with rubber nipples molded into the backside of the guard and mounted by stainless steel brackets with removable connecting rod.

**3.2.5.4** Air operated tailgate shall be "pancake-type" tailgate release valve.

**3.2.5.4.1** The air chamber shall be anchor lock with a spring-over-center latch.

**3.2.5.4.2** Pivot points must include greasable stainless steel bushings to reduce seizing.

**3.2.5.5** OSHA approved corrosion resistant backup alarm, electronic ambient, adjusts to background noise, 112 dba minimum, shock mounted at rear.

**3.2.5.6** Shall have bed body support, both sides.

**3.2.5.7** Dump body shall have a stainless-steel bolt on full width asphalt plate minimum 12" long.

**3.2.6 Bed Body Lighting:**

**3.2.6.1** All bed body wiring must be uninterrupted and complete with no splices.

**3.2.6.2** All wire terminal ends (spade, ring, etc.) shall be: crimped soldered to the wires and heat shrink, or weatherproof connectors.

**3.2.6.2.1** Quick fasteners and/or crimp butt connectors are not acceptable for any connections.

**3.2.6.3** All electrical connections shall be protected with dielectric silicone grease.

CRFQ 0803 DOT1700000088  
REQUEST FOR QUOTATION  
**64,000 GVWR Tandem Axle Dump Truck**  
**w/Front Snow Plow, V-Box Spreader, with Optional Right Front Wing Plow and Anti-  
Icing Tank & Spray System**

---

**3.2.6.4** All body lights shall be connected to chassis through a waterproof junction box located at rear of truck.

**3.2.6.5** All body lighting – stop, tail, turn, marker lights and reverse lights shall be LED type with sealed weatherproof wiring.

**3.2.6.6** Rear lights shall be shock mounted, recessed oval stop, tail, turn, and recessed oval back up lights shall be mounted in back post.

**3.2.6.7** Bed shall have center three (3) light cluster located in truck chassis.

**3.2.6.8** Two (2) amber oval LED strobe lights shall be mounted at the front corners of the cab protector and two (2) amber oval LED strobe lights mounted at each outside corner of cab protector.

**3.2.6.8.1** Strobe lights shall be marked and switched at dash board location.

**3.2.6.8.2** Oval cutouts shall be precut by dump body manufacturer.

**3.2.6.9** Two (2) oval amber LED strobe lights mounted at top of rear corner posts right and left sides and shall be switched in combination with cab protector strobe.

**3.2.6.9.1** Oval cutouts shall be precut by dump body manufacturer.

**3.2.6.10** Lighted license plate bracket.

**3.2.6.11** Bed shall have LED marker lights on bed corners.

**3.2.7 Under Body Tool Box:**

**3.2.7.1** One (1) stainless steel tool box shall be mounted under body on right side frame rail.

**3.2.7.2** Tool box shall be 18" H x 24" W x 18" D minimum cradled by a structural angle stainless steel frame attached to the truck frame.

**3.2.7.3** Tool box shall have a keyed latch of corrosion resistant hardware, automotive style weather stripping, and a drip rail over the door opening.

**3.2.8 Load Covering System:**

**3.2.8.1** Shall be electrically controlled.

**3.2.8.2** Electric motor assembly shall include 12 volt sealed direct drive motor with forward and reverse action, cab mounted control switch, with resettable circuit breaker.

CRFQ 0803 DOT1700000088  
REQUEST FOR QUOTATION  
**64,000 GVWR Tandem Axle Dump Truck**  
**w/Front Snow Plow, V-Box Spreader, with Optional Right Front Wing Plow and Anti-Icing Tank & Spray System**

---

- 3.2.8.3 Pivot arm assembly shall be constructed in a two (2) piece bent arm configuration of 1 ¼ inch minimum 14 gauge minimum stainless steel or aluminum tubing.
- 3.2.8.4 Bent arm extensions shall be constructed of minimum one (1) inch 14gauge, stainless steel or aluminum tubing.
- 3.2.8.5 Rear cross shall be constructed of minimum 1 ¼ inch 14 gauge stainless steel or aluminum tubing.
- 3.2.8.6 Stainless steel pivot armrests shall be included.
- 3.2.8.7 Underbody spring shall be extension spring minimum 12 inches in length attached to base of pivot arm and of body with articulating spring mounting bracket.
- 3.2.8.8 Load covering system shall be provided with minimum of 18 oz. black asphalt rated tarp to fit dump body with brass or stainless steel eyelets every 2' foot.

### **3.3 FRONT SNOW PLOW:**

**3.3.1 Moldboard** - The following are mandatory requirements for the moldboard.

- 3.3.1.1 Moldboard Construction shall be 10 gauge minimum 201 Stainless Steel and rolled to give the snow a free rolling action. Break formed will not be acceptable.
- 3.3.1.2 Overall width shall be a minimum of 11 foot.
- 3.3.1.3 Overall height shall be a maximum of 36 inches.
- 3.3.1.4 Plow Weight shall be 1815 pounds minimum.
- 3.3.1.5 Moldboard shall be reinforced at the top and bottom edges.
  - A. Top of moldboard shall be reinforced with an integrally structural channel 3-1/2 inch x 2-1/2 x 3/8 inch minimum.
  - B. Bottom angle shall be minimum of 4 inch x 4 inch x ¾ inch angle gusseted.
- 3.3.1.6 Moldboard shall have a cutting-edge attack angle with minimum of three (3) different adjustments from 5 degree, 10 degree, and 20 degree vertical measurement from ground using ¾ inch plus.
- 3.3.1.7 Shall have a travel arc of thirty- five degrees (35°) minimum each way; total seventy degrees (70°).
- 3.3.1.8 Shall be minimum of eight (8) vertical ribs, ½ inch by 3-1/2 inch formed steel.

CRFQ 0803 DOT1700000088  
REQUEST FOR QUOTATION  
**64,000 GVWR Tandem Axle Dump Truck**  
**w/Front Snow Plow, V-Box Spreader, with Optional Right Front Wing Plow and Anti-Icing Tank & Spray System**

---

**3.3.1.9** Shall be continuously welded ribs, moldboard, and angles.

**3.3.1.10** An additional rubber snow shield shall be provided. It shall be minimum 5/16 inch x 12 inch belting and run the entire length of plow.

**3.3.1.10.1** It shall be mounted in a manner as not to add to overall plow height.

**3.3.1.10.2** Mounted with a stainless steel cover plate.

**3.3.2 Cutting Edges** – The following are mandatory requirements related to the cutting edges.

**3.3.2.1** Cutting edge shall be sectioned, standard AASHTO punched, in three (3) foot and four (4) foot lengths.

**3.3.3 Blade Section:**

**3.3.3.1** Shall be minimum ½ inch thick by six 6 inches wide, having a GRADE WC cemented tungsten carbide insert of 88 Rockwell A scale hardness.

**3.3.3.2** The insert shall be silver soldered on all sides of a milled slot near the center of the working edge.

**3.3.3.3** The braze joint shall have a transverse rupture strength of 345,000 PSI minimum.

**3.3.3.4** Blade section shall be identifiable by manufacturer, name and part number stamped on the reverse side of each section.

**3.3.3.5** Wrap around curb guards shall be mounted right and left side of plow.

**3.3.3.6** Curb guards shall be minimum of 5/8 inch thick, maximum 6 inches high and minimum 8 inches long.

**3.3.4 Safety Trip Mechanism** – The following are mandatory requirements related to the safety trip mechanism.

**3.3.4.1** Tripping mechanism shall be attached to semi-circle and moldboard ribs, and shall use minimum of two (2) compression springs.

**3.3.4.2** The trip mechanism shall hold the plow rigid in the plowing position and trip automatically when cutting edge comes in contact with obstruction then returns to normal plowing position.



CRFQ 0803 DOT1700000088  
REQUEST FOR QUOTATION  
**64,000 GVWR Tandem Axle Dump Truck**  
**w/Front Snow Plow, V-Box Spreader, with Optional Right Front Wing Plow and Anti-  
Icing Tank & Spray System**

---

**3.3.5 Push Frame** - The following are mandatory requirements related to the push frame.

**3.3.5.1** Push frame shall be of all welded construction designed per manufacturer's heaviest rated specifications.

**3.3.5.1.1** Push frame shall be 132 inches in length for 11-foot plow made of 4 inch x 4 inch x 3/8 inch minimum structural tube.

**3.3.5.2** Moldboard to push frame connection shall be by a minimum of seven (7) hinges with each hinge having a fully welded in bushing to house pin.

**3.3.5.2.1** Bushing shall be 1-1/4 inches mounted to two (2) 5/8 inch mounting ears for total bearing surface per bushing of 2 - 1/2 inches.

**3.3.5.3** The A- frame shall be equipped with an oscillating center pin of plow portion hitch of 2 inch with push plate being 1 inch x 33 inch x 5 inches feature to permit the plow to follow uneven road surfaces.

**3.3.5.3.1** Semi-Circle shall be 3-1/2 inches x 3-1/2 inches x 1/2 inch.

**3.3.6 Hydraulic Power Reversing Mechanism:**

**3.3.6.1** Shall be minimum of two (2) double acting 4 inch x 2 inch x 10 inch stroke power reversing nitride hydraulic, cylinders fitted with the fixed base end near the center of the push frame.

**3.3.6.1.1** Cylinders shall be mounted above the semi-circle.

**3.3.6.2** Hydraulic power reverse mechanism shall include a dual cross-over relief cushion valve rated at a minimum of 40 G.P.M.

**3.3.6.3** The "A" frame shall be minimum 4 inch channel with 2.5 inch flanges supporting a 2 inch center reversing pin mounted in a 3 inch, 1/2 inch wall tube and having a grease fitting.

**3.3.6.3.1** The push ends are welded to a 1 inch x 33 inches x 5 inch base plate having a 2 inch pivot hole for the oscillator bar to attach to.

CRFQ 0803 DOT1700000088  
REQUEST FOR QUOTATION  
**64,000 GVWR Tandem Axle Dump Truck**  
**w/Front Snow Plow, V-Box Spreader, with Optional Right Front Wing Plow and Anti-Icing Tank & Spray System**

---

**3.3.7 Skid Shoes:**

- 3.3.7.1 Skid Shoes shall be Caster mounted carbide mushroom type shoes, one (1) on each side shall be provided with manual hand crank assembly.
- 3.3.7.2 Manufacturer's standard adjusting mechanism shall be included.

**3.3.8 Snow Plow Cushion Valve:**

- 3.3.8.1 A double relief cushion valve must be installed for the plow angle and scraper left/right.
- 3.3.8.2 The valve shall be set at 2000 PSI maximum.
- 3.3.8.3 The valve shall be constructed of a high-tensile cast iron body with ball and spring style relief that has hardened seat.
  - 3.3.8.3.1 The valve shall be plumbed at the front of the truck for snowplow angle.

**3.3.9 FRONT SNOW PLOW HITCH** – The following are mandatory requirements related to the hitch.

- 3.3.9.1 Shall be designed as a universal heaviest rating type unit to carry plows of weight specified.
- 3.3.9.2 The hitch shall be a frame type mount adaptable to any conventional truck and shall accommodate the tilt front end on the carrier.
- 3.3.9.3 The hitch shall be attached to truck's frame rails behind front bumper.
- 3.3.9.4 Hitch shall include a lift system designed at a rated capacity of 8,000 lbs. minimum.
  - 3.3.9.4.1 Lift cylinder must be same size as plows reversing cylinder for WVDOH's interchangeability.
- 3.3.9.5 Truck front plow hitch shall be a WVDOH plow quick hitch Design See attached: **EXHIBIT D**
- 3.3.9.6 Hitch frame height shall be approximately 33 inches and hitch width shall be approximately 26 inches.
  - 3.3.9.6.1 Will be determined at pre-build meeting.
- 3.3.9.7 Hitch frame members shall be ½ inches x 4 inches x 4 inches minimum structural angle or tubing.

CRFQ 0803 DOT1700000088  
REQUEST FOR QUOTATION  
**64,000 GVWR Tandem Axle Dump Truck**  
**w/Front Snow Plow, V-Box Spreader, with Optional Right Front Wing Plow and Anti-Icing Tank & Spray System**

---

- 3.3.9.7.1** This hitch is low profile for access to the truck's engine compartment.
- 3.3.9.8** The lift arm and lift frame shall be designed to accept a 4 inch lift cylinder with nitride cylinder tube.
  - 3.3.9.8.1** Cylinder pins shall be 1 inch cold rolled steel.
- 3.3.9.9** Shall have a self-storing lift arm, accomplished by pulling one (1) 1 inch pin and folding the cylinder up, allows you to re-pin to store.
- 3.3.9.10** The telescopic lift arm shall be manufactured of 4 inch x 4 inch x 3/8 inch minimum square outer tubing and 3 inch x 3 inch x 3/8 inch minimum square inner tubing.
- 3.3.9.11** The lifting plate shall be 3/8 inch x 4 inch minimum flat material and have two (2) banjo-type chain eyes able to accept 1/2 inch minimum chain as well as the weight of the plow.
- 3.3.9.12** Shall also have two (2) stabilizer arms mounted to receiver tube of telescoping arm and outside pivot of hitch.
- 3.3.9.13** Shall provide custom 1/2 inch Grade 50 minimum cheek plates which shall be bolted welded or bolted to main hitch and to allow for bolting to truck's frame rail.

**3.3.10 Plow Hydraulic System** – The following are mandatory requirements related to the hydraulic system.

- 3.3.10.1** Hydraulic pressure shall be supplied from the truck central hydraulic system through a lift valve and reversing valve (main bank valve) to the plow lift and reversing cylinders.
- 3.3.10.2** The vendor shall be required to supply the following hydraulic components:
  - a.** One (1) 4 inch lift cylinder with 10 inch stroke double-acting hydraulic lift cylinder (even if we only use one (1) line fitting in upper end with breather), clevis pinned top and bottom.
  - b.** Two (2) 4 inch double acting nitride hydraulic reversing cylinders.
  - c.** Plow reversing and plow truck portion lift cylinders must be the same size for interchangeability, standardization and one part number cylinder.

CRFQ 0803 DOT1700000088  
REQUEST FOR QUOTATION  
**64,000 GVWR Tandem Axle Dump Truck**  
**w/Front Snow Plow, V-Box Spreader, with Optional Right Front Wing Plow and Anti-Icing Tank & Spray System**

---

**3.3.11 Paint** – The following are mandatory items related to the paint color.

**3.3.11.1** Unit shall be painted with urethane paint black in color paint code M6388G or equal shade only.

**3.3.11.1.1** Stainless plow face not to be painted.

**3.4 Plow Option: Right Front Wing Plow -Front Mounted Patrol Wing System :**

This specification is to describe a full floating patrol wing with full tripping action and hydraulic telescoping action mechanism with the capability to lower the assembly to the travel position for visibility purpose. The plow shall be a current model under standard production by the manufacturer, with not less than two years of production and field use.

**3.4.1 MOLDBOARD:**

**3.4.1.1** Moldboard height shall be 32 inch minimum at toe 39 inch maximum at discharge.

**3.4.1.2** 11ft x 5/8" x 6" minimum three piece carbide cutting edge.

**3.4.1.3** Moldboard shall be 10GA minimum 201 stainless steel with minimum 6 ribs by 1/2" thick.

**3.4.1.4** Continuous welded one-piece moldboard.

**3.4.1.5** Reinforced 4" x 4" x 3/4" minimum bottom angle with 1/4" x 4" minimum plate braces.

**3.4.1.6** 2" x 2" x 3/16" minimum angle horizontal stiffeners for added rigidity.

**3.4.1.7** 2" x 2" x 3/16" minimum boxed top angle with ends capped.

**3.4.1.8** Push arm mounting points shall be 3/8" minimum plate.

**3.4.1.9** Full moldboard trip with trip dee block assembly.

**3.4.2 Front Wing Post:**

**3.4.2.1** Wing post attaches to front mount plow hitch for ease of removal.

**3.4.2.2** Post is fabricated from minimum 8" Tab & Slot 1/2" fabricated I-beam.

**3.4.2.3** Toe cylinder is double acting 3" x 52" stroke with nitrided 2" rod minimum.

**3.4.2.4** Slide plate shall be minimum of 3/4" thick steel and allow 8" of mechanical moldboard float.

CRFQ 0803 DOT1700000088  
REQUEST FOR QUOTATION  
**64,000 GVWR Tandem Axle Dump Truck**  
**w/Front Snow Plow, V-Box Spreader, with Optional Right Front Wing Plow and Anti-Icing Tank & Spray System**

---

**3.4.2.5** The slide plate shall be retained by 1/2" x 1" minimum bar stock welded and gusseted to front post.

**3.4.2.6** 48" minimum moldboard ground clearance for benching purposes.

**3.4.2.7** Moldboard attaches to slide plate through a pivot assembly.

**3.4.3 Rear Wing Support and Push Arm Assembly:**

**3.4.3.1** Push arm frame is designed to mount under truck frame rails to allow minimum cab to body clearance.

**3.4.3.2** Wing arm attachment face plate shall be removable with a two pin Design.

**3.4.3.3** One (1) hydraulically adjustable length push arm assembly shall be required. Outer structure tube shall be 3-1/4" x 1/4" wall and inner shall be 2-3/4" x 1/4" wall.

**3.4.3.3.1** Spring cushion to be mounted on end of arm closest to rear wing support assembly.

**3.4.3.4** Heel lift cylinder to be a minimum 2" nitrided rod x 3" x 29".

**3.4.3.5** Extendable wing brace to be minimum 2" nitride rod x 3-1/2" x 26".

**3.4.3.6** Seven (7) mounting hole locations to be 23-1/4" wide.

**3.4.4 Miscellaneous items for wing plow:**

**3.4.4.1** Three (3) valve sections to be added to hydraulic stack section to operate wing functionally per manufacturer's recommendations.

**3.4.4.2** Wing function to be operated by two additional electric over hydraulic joysticks.

**3.4.4.3** Two (2) LED work lights to be provided on one (1) rocker switch on chassis dash provided switch. One (1) mounted on rear wing support and mounted on front wing post.

**3.5 V-BOX SPREADER 2-in-1 V-Box, Prewetting/Slurry system:**

**3.5.1 Heavy Duty 201 Stainless Steel V-Box Dual Auger Salt Spreader with Storage Stand.**

**3.5.1.1** Capacity to be 9.5 yard minimum struck capacity.

**3.5.1.2** Inside length to be 14 feet maximum and maximum height of 56".

**3.5.1.3** Inside top width to be maximum 83-3/4".

**3.5.1.4** Side slope to be 45 degree minimum.

**3.5.1.5** Front & rear panels slope; minimum rear 9 degree, minimum front

CRFQ 0803 DOT1700000088  
REQUEST FOR QUOTATION  
**64,000 GVWR Tandem Axle Dump Truck**  
**w/Front Snow Plow, V-Box Spreader, with Optional Right Front Wing Plow and Anti-Icing Tank & Spray System**

---

18 degree.

- 3.5.1.6** Hopper seams to be continuous welded on inside.
- 3.5.1.7** Sides, ends, & side supports to be 10 gauge minimum 201 SS.
- 3.5.1.8** Top edge of hopper is formed "J" channel minimum 2" x 7/8".
- 3.5.1.9** Dual auger trough is to be 7 gauge minimum 201 SS.
- 3.5.1.10** Long sills to be 7 gauge minimum 201 SS continuous welded to side sheet.
- 3.5.1.11** Cross sills to be formed 7 gauge minimum 201 SS welded to side supports.
- 3.5.1.12** Spreader shall have a 7 gauge minimum 201 SS inverted vee mounted over the dual augers with frame work for stability.
- 3.5.1.13** Lift hooks on each corner are 1/4" x 2" minimum formed 201 SS plate.
- 3.5.1.14** All hardware shall be 201 SS minimum.
- 3.5.1.15** Hydraulic inter-lock auger shut-off system to shut augers down when cover grates are opened—interlock plumbed at factory.
- 3.5.1.16** 3/8" rod on 3/8" rod Stainless steel top grate screens with anti-freeze hinges are required equipment with auger conveyor v-box units.
- 3.5.1.17** Full width 201SS minimum metal spill shield mounted at front of hopper on top rail with slope facing forward at 45 degree.
- 3.5.1.18** A full width rear 201 SS minimum light bar shall be mounted with nine (9) LED lights.
  - 3.5.1.18.1** Shall include stop, tail, turn, three (3) bar light, two (2) amber LED strobes and two (2) rear work lights.
  - 3.5.1.18.2** Shall have weatherproof junction box and 7 wire corrosion resistant plug to reach rear of cab.
- 3.5.1.19** One (1) stainless steel fold up ladder mounted at the rear of spreader on right side allowing access from ground to top of spreader.
  - 3.5.1.19.1** One (1) grip strut step mounted on top of rear spinner housing frame above rear baffle and full width of spinner housing.
- 3.5.1.20** The V-box spreader shall include a stainless steel leg stand assembly.
- 3.5.1.21** The stand shall be capable of sliding into an 84" wide dump body with a 9" radius between the sides and floor.
  - 3.5.1.21.1** The base in contact with the dump floor shall not exceed 65"

CRFQ 0803 DOT1700000088  
REQUEST FOR QUOTATION  
**64,000 GVWR Tandem Axle Dump Truck**  
**w/Front Snow Plow, V-Box Spreader, with Optional Right Front Wing Plow and Anti-  
Icing Tank & Spray System**

---

width. The spreader stand/leg assembly shall be designed to support an empty spreader hopper.

**3.5.1.22** The spreader frame assembly shall be constructed from 201 grade stainless steel minimum.

**3.5.1.23** The spreader frame shall contain two formed members, full length of the spreader unit on each side.

**3.5.1.24** The two main longitudinal frame members shall be fabricated hat channel design, manufactured from a minimum of 7 gauge 201 grade stainless steel.

**3.5.1.24.1** They shall measure 6" minimum on the inside width and 7.5" minimum in height.

**3.5.1.24.2** The frame shall be open on the bottom side and closed on the top side.

**3.5.1.24.3** The front end of the main longitudinal members shall each include a 6" minimum solid heavy duty poly nylatron wheel.

**3.5.1.24.4** The nylatron wheel shall be 4,000lb minimum rated without bearings.

**3.5.1.24.5** No steel bushings of bearing are permitted.

**3.5.1.24.6** The rollers will allow the spreader to roll into the dump body of the truck. The through roller shaft hardware shall be stainless steel.

**3.5.1.25** Located between the main longitudinal frame members shall be cross braces manufactured from minimum 7 gauge 201 grade stainless steel fabricated channel.

**3.5.1.25.1** These channels shall be 5" minimum wide x 4" minimum deep, open to the bottom as to prevent material hold.

**3.5.1.25.2** These supports shall be located on 24" minimum centers.

**3.5.1.25.3** The clearance between the dump body bed and the underside of the cross bracing shall be minimum of 1-1/2".

**3.5.1.26** The rear upper leg frame shall be an offset design located between the main frame rails and the rear lengths.

**3.5.1.26.1** The structure shall be fabricated boxed tube construction, minimum of 7 gauge 201 grade stainless steel.

CRFQ 0803 DOT1700000088  
REQUEST FOR QUOTATION  
**64,000 GVWR Tandem Axle Dump Truck**  
**w/Front Snow Plow, V-Box Spreader, with Optional Right Front Wing Plow and Anti-Icing Tank & Spray System**

---

- 3.5.1.26.2** The frame members shall have a sloping angle of 30 degrees minimum down from the frame rail attachment point.
- 3.5.1.26.3** The upper leg frame shall have a series of (5) holes to allow for height adjustment of the lower leg.
- 3.5.1.27** The rear legs shall be manufactured from fabricated  $\frac{1}{4}$ " minimum 201 grade stainless steel tube.
- 3.5.1.27.1** The tubes shall be 5" minimum deep x 2" minimum wide.
- 3.5.1.27.2** The legs shall be adjustable within the upper leg frame by means of (5) minimum available height adjustment holes.
- 3.5.1.27.3** The rear legs shall be sloped a minimum of 15 degrees from vertical with the lower part of the leg angles away from the spreader body and towards the rear direction.
- 3.5.1.27.4** The rear legs shall pin to the upper leg frame with a handle type 1" minimum zinc plated pin.
- 3.5.1.27.5** The rear leg shall have a pivoting foot which shall measure a minimum of 10" in length x 2" minimum in width.
- 3.5.1.27.6** The foot shall include an integrated handle.
- 3.5.1.27.7** The foot shall be fabricated from a minimum of 7 gauge 201 grade stainless steel, and include a minimum of (5)  $\frac{1}{4}$ " x 2" studs on the bottom side to reduce surface slippage.
- 3.5.1.28** The front legs shall be set back from the frames front roller wheels to allow the roller wheels to contact the dump body floor prior to contacting the front legs.
- 3.5.1.28.1** The front legs shall be a tube in tube design, slanted forward at an angle of a minimum of 95 degrees.
- 3.5.1.28.1.1** Also, the legs shall slant to the sides a minimum of 8 degrees.
- 3.5.1.28.2** The upper portion of the front legs shall be constructed from a minimum of 4" x 4" x 7 gauge 201 grade stainless steel fabricated square tube.



CRFQ 0803 DOT1700000088  
REQUEST FOR QUOTATION  
**64,000 GVWR Tandem Axle Dump Truck**  
**w/Front Snow Plow, V-Box Spreader, with Optional Right Front Wing Plow and Anti-  
Icing Tank & Spray System**

---

- 3.5.1.28.3** The upper legs shall have a series of (3) holes to allow for height adjustment.
  - 3.5.1.28.4** The lower inner leg shall be fabricated from 3.5" x 3.5" x 3/16" minimum structural stainless steel tube.
  - 3.5.1.28.5** The lower legs shall have a series of 6 holes to allow for height adjustment.
  - 3.5.1.28.6** The front leg bottom base shall have a pivoting foot pad, a minimum of 4" wide x 5" deep.
  - 3.5.1.28.7** The front legs shall manually actuate into the main frame members when the spreader is installed into a dump body.
  - 3.5.1.28.8** When the spreader is to be stored, the legs shall be pinned into the locked position with a 1.25" pin minimum.
- 
- 3.5.1.29** The stand assembly shall include trunnion tailgate latches to allow the spreader/stand to be secured into the dump body latch fingers. The trunnion bar assembly shall consist of all stainless steel components/hardware and tailgate latch pins.
  - 3.5.1.30** The stand shall include side guide wheels to assist in the loading/unloading of the spreader system. The guide wheels shall be adjustable and designed to ride along the side of the dump body.
  - 3.5.1.31** The complete assembly shall be high pressure cleaned and SS etched to remove weld slag, splatter, and oils. All stainless steel shall remain in natural stainless steel finish.

**3.5.2 Minimum Auger Requirements:**

- 3.5.2.1** Dual 7" minimum diameter variable pitch auger conveying system. The augers must be counter rotating to help prevent bridging of material. Dual augers extend 2 feet past end of hopper to allow discharge into spinner chute.
- 3.5.2.2** Each auger is driven at the rear by a 24.7 CIR hydraulic motor which is directly coupled to a 3.6:1 planetary gear case with 2.5 inch diameter shaft coupled to the end of the auger shaft with a 7/8" cross bolt.
- 3.5.2.3** Gear case is directly coupled to end of auger shaft.
- 3.5.2.4** Auger shaft connects at front with a 2" 2 bolt flange bearing.
- 3.5.2.5** Rear auger drive motors to have motor guards.

CRFQ 0803 DOT1700000088  
REQUEST FOR QUOTATION  
**64,000 GVWR Tandem Axle Dump Truck**  
**w/Front Snow Plow, V-Box Spreader, with Optional Right Front Wing Plow and Anti-  
Icing Tank & Spray System**

---

**3.5.3 Reservoir Tanks:**

- 3.5.3.1(2) 400-gallon minimum rotation molded medium density .375" polyethylene tank with 5" diameter cap. Includes sump for complete drainage.
- 3.5.3.2 Replaceable screen line strainer.
- 3.5.3.3 Corrosion resistant shut off valves.
- 3.5.3.4 Reservoir tank is angle formed to allow for mounting on the side of a slip-in v-box utilizing 201 stainless steel minimum mounting brackets and hardware.
- 3.5.3.5 Supplied with bulk tank fill quick couplings. Internal baffle.
- 3.5.3.6 Banjo brand fittings must be provided to allow for filling/unloading.

**3.5.4 Spinner Assembly:**

- 3.5.4.1 10 gauge 201stainless steel minimum enclosed design.
- 3.5.4.2 Spinner assembly shall have a (4) position telescopic adjustment below mounting surface.
- 3.5.4.3 Two (2) baffles shall be positioned at the bottom of the spinner chute to direct flow of materials onto spinner disc for directional spread pattern adjustment.
- 3.5.4.4 The two (2) spread pattern adjustment baffles shall each have 5 (five) positions of adjustment without the use of tools.
  - 3.5.4.4.1 The baffle(s) shall utilize a 304SS notched bar that pins into position for a positive lock.
- 3.5.4.5 Four (4) bottom spinner deflectors shall be over-lapping to prevent loss of granular material when the deflectors are raised.
  - 3.5.4.5.1 Front deflector is fixed.
- 3.5.4.6 The bottom over-lapping spinner deflectors shall have four (4) positions of rod and pin adjustment without tools.
  - 3.5.4.6.1 Chain adjustable deflectors are not acceptable.
- 3.5.4.7 The bottom over-lapping spinner deflectors shall have the capability to be removed and/or replaced without tools.
- 3.5.4.8 Poly 20" diameter spinner disc to have replaceable machined hub.
- 3.5.4.9 Poly spinner disc shall have minimum of six (6) built in spinner vanes.
- 3.5.4.10 Spinner hydraulic motor shall mount directly on top of spinner disc.

CRFQ 0803 DOT1700000088  
REQUEST FOR QUOTATION  
**64,000 GVWR Tandem Axle Dump Truck**  
**w/Front Snow Plow, V-Box Spreader, with Optional Right Front Wing Plow and Anti-Icing Tank & Spray System**

---

- 3.5.4.11** The top mounted spinner motor shall be enclosed in the spinner chute to maximize granular material flow to the spinner disc.
  - 3.5.4.11.1** For serviceability, the spinner chute shall have open access to the spinner motor.
- 3.5.4.12** A spinner bypass chute shall be provided that allows for the stationary unloading of granular material.
  - 3.5.4.12.1** When in the pivoted “down” position, the chute shall provide complete bypass of the spinner and bottom deflectors.
  - 3.5.4.12.2** When in the “up” position, the chute shall become part of the enclosed spinner chute providing granular material flow to the spinner.
  - 3.5.4.12.3** The bypass chute shall have a quick latch system pinning into position without the use of tools.

**3.5.5 Metering Orifice and Slurry Tube:**

- 3.5.5.1** Metering Orifice and Slurry Tube shall be bolt-on brackets, with all stainless steel hardware, and fittings supplied.
- 3.5.5.2** Variable displacement orifice provides an extended range of material outputs located in spinner chute.
- 3.5.5.3** Variable displacement orifice 22" wide minimum, vented internal at top of spinner chute.
- 3.5.5.4** Spreader shall have a stainless steel liquid injection tube 1" OD which shall be located on the underside of the inverted vee. The injection tube will provide liquid which will be agitated by the spreader augers to create a salt slurry mixture. The liquid for the slurry generation process shall come from the liquid pre-wet system. There shall be a manual ball valve to control flow from the pre-wet to either the slurry injection line or to the spinner pre-wet nozzles (variable displacement).

**3.5.6 Hydraulic Pre-Wet System:**

- 3.5.6.1** Liquid pumping system shall come complete with all plumbing, pumps with an enclosure, and mounting hardware.
- 3.5.6.2** The spray system shall be completely controlled by the ground speed spreader control.

CRFQ 0803 DOT1700000088  
REQUEST FOR QUOTATION  
**64,000 GVWR Tandem Axle Dump Truck**  
**w/Front Snow Plow, V-Box Spreader, with Optional Right Front Wing Plow and Anti-  
Icing Tank & Spray System**

---

- 3.5.6.3 System shall run off a section in valve stack.
- 3.5.6.4 Pump housings and gears are made of top quality bronze and corrosion resistant.
- 3.5.6.5 Pump shall be self-priming, pulse free positive displacement design.
- 3.5.6.6 Unit shall come with a precision-machined minimum 303 stainless steel shaft.
- 3.5.6.7 Bearings are designed of high performance carbon graphite material selected for wear resistance and long service life, O-ring cover seal for maximum leak protection.
- 3.5.6.8 Pump shall come with a built in relief valve set at 45 PSI maximum to protect against over-pressurization.
- 3.5.6.9 Pump shall have a continuous duty rating of 125 PSI maximum.
- 3.5.6.10 Pump shall be plumbed through a minimum 0-15 maximum GPM flow meter, made of a non- corrosive material.
- 3.5.6.11 Pump shall be capable of 8 GPM minimum at 40 PSI maximum.
- 3.5.6.12 Hydraulic motor must be a 12.5cc minimum and mount directly to the pump and have a machined aluminum mounting bracket.
- 3.5.6.13 Hydraulic connections shall be bulkhead style mounted in bottom of enclosure.
- 3.5.6.14 All hydraulics inside enclosure shall be hard plumbed.
- 3.5.6.15 Pumps shall be mounted in a Nema 4x style weather tight enclosure.
- 3.5.6.16 All plumbing shall be included for a 4 nozzle system with check valves.
- 3.5.6.17 There shall be (4) 2 GPM brass nozzles with quick connect caps. Check valves 5 minimum and 20 maximum PSI for auto nozzle selection via pressure.
- 3.5.6.18 There shall be a ¾" strainer with stainless steel maximum 20 mesh screen, and a poly 3-way ball valve for flushing pump.
  - 3.5.6.18.1 Must be mounted on Vee-Box Spreader on passenger side rear.

### **3.6 Tank Option - ANTI-ICING TANK AND SPRAY SYSTEM**

#### **3.6.1 Polyurethane Tank Spray System:**

- 3.6.1.1 System shall be capable of dispensing liquid De-Icer on three lanes at a maximum rate of 60 gallons per lane mile at 60 mph.
- 3.6.1.2 The liquid Anti-Icing tank shall have a minimum capacity of 2000

CRFQ 0803 DOT1700000088  
REQUEST FOR QUOTATION  
**64,000 GVWR Tandem Axle Dump Truck**  
**w/Front Snow Plow, V-Box Spreader, with Optional Right Front Wing Plow and Anti-Icing Tank & Spray System**

---

gallons and to be constructed out of polyurethane.

**3.6.1.3** Tank shall include maximum amount of baffle balls for tank capacity.

**3.6.1.4** A 16" minimum manhole with lid shall be provided in the top of the tank.

**3.6.1.5** The tanker rear bumper shall also provide for the mounting of the pump, valves, and spray bars.

**3.6.1.6** Load and unload connection will be a part of the rear bumper assembly, an adjustable 304 stainless steel minimum center spray bar with a minimum of 8 solid stream non-adjustable nozzles shall be provided; the spray bar assembly must be adjustable from 14 minimum to 20 maximum inches off the road surface.

**3.6.1.7** Mounting of unit to stainless steel adjustable leg stand kit for loading and unloading with tank empty and for empty storage.

**3.6.1.7.1** Overall width, not including rollers and spray booms, shall be 75.36 inches maximum. Overall length, not including rollers, shall be 172.25" maximum.

**3.6.1.7.2** Must have minimum four (4) stainless steel cross member supports. Rear frame height to be maximum of 40.37".

**3.6.1.8** A spray bar for the left and right lane shall be provided, the bar shall have 4 adjustable solid stream nozzles, and shall be placed no higher than 14 inches minimum to 20 inches maximum off the road surface.

**3.6.1.8.1** 1-½ inch stainless steel trunnion style ball with poly housing valve shall be provided for activation and de-activation of the selected spray bar.

**3.6.1.9** Stainless steel nozzles to be rated at minimum 32 gallons per lane mile.

**3.6.1.10** All mounting brackets and hardware to attach plumbing and spray bar assemblies shall be minimum of 304 stainless steel.

**3.6.1.11** The liquid chemical pump must be a 190 GPM minimum centrifugal pump with a 2" suction and 1-1/2" pressure ports and be constructed of stainless steel.

**3.6.1.12** The hydraulic motor shall be integral with the liquid pump.

**3.6.1.12.1** The hydraulic motor will require a maximum of 12 GPM @ 2100 psi, and must be capable of working on fixed gear pump systems or load sensing systems.

**3.6.1.13** A filter will be installed after the pump to protect the flow meter, nozzles and valves.

CRFQ 0803 DOT1700000088  
REQUEST FOR QUOTATION  
**64,000 GVWR Tandem Axle Dump Truck**  
**w/Front Snow Plow, V-Box Spreader, with Optional Right Front Wing Plow and Anti-Icing Tank & Spray System**

---

- 3.6.1.14 Hydraulics for the pump/valves will be controlled electronically, definite in above hydraulics section.
- 3.6.1.15 All wiring and hydraulic hoses shall be routed away from pinch points, sharp corners and heat sources. 1 1/2" plumbing shall be provided for all liquid De-Icer pressure lines.
- 3.6.1.16 The system will be capable of self-loading liquids from a ground based tank or mobile nurse tank.
- 3.6.1.17 All fittings must be glass filled polypropylene, capable of adaptations.
- 3.6.1.18 Two (2) yellow clearance lights; four (4) red reflectors; one (1) 3-light cluster.
  - 3.6.1.18.1 All LED type.
- 3.6.1.19 Check valves shall be installed at boom to minimize run-on and improve start up response.
- 3.6.1.20 Tank shall have rear mounted stainless steel ladder.
- 3.6.1.21 System shall be capable of spraying Herbicide for weed control.

**3.7 CENTRAL HYDRAULIC SYSTEM-** The Central Hydraulic System shall be completely adjusted to proper pressures. Spreader controls shall be calibrated and ready for use when delivered. Plow Balance system shall be adjusted and ready for use.

**3.7.1 Power Take Off:**

- 3.7.1.1 Power take off shall be made of cast iron.
- 3.7.1.2 Unit shall be capable of mounting to fully automatic style transmission.
- 3.7.1.3 PTO shall be of the Hot Shift design and have a rotatable direct mount cast iron flange for the hydraulic pump to mate to. Shall be of the Wet Spline design, PTO/pump shafts are bathed in oil.
- 3.7.1.4 PTO to engine speed shall be in the maximum range of 116% to 120%.
- 3.7.1.5 Unit shall have in internal solenoid shifting coil no external shifting is acceptable.
- 3.7.1.6 PTO must have automatic shutdown with override switch for low oil and hot oil conditions.
- 3.7.1.7 PTO must have continuous torque rating of 390lb. ft. maximum.

**3.7.2 Hydraulic Pump:**

- 3.7.2.1 The hydraulic pump shall have a minimum displacement of 75cc.
- 3.7.2.2 The hydraulic pump shall be direct flange mount to PTO.

CRFQ 0803 DOT1700000088  
REQUEST FOR QUOTATION  
**64,000 GVWR Tandem Axle Dump Truck**  
**w/Front Snow Plow, V-Box Spreader, with Optional Right Front Wing Plow and Anti-Icing Tank & Spray System**

---

- 3.7.2.3 The piston pump (load sensing type) must be capable of 48 GPM minimum and a minimum of 3000 PSI at 2500 RPM.
- 3.7.2.4 Pump must have rear ports to avoid multiple 90-degree bends in suction line.
- 3.7.2.5 The case drain must be positioned as high as possible and directed back to the reservoir without passing through the return line filter.
- 3.7.2.6 Pump must have #24 minimum size O-ring port with 2" minimum barb fitting, for suction port and 1" minimum O-ring pressure port.
- 3.7.2.7 Pump must be all cast iron design.
- 3.7.2.8 The pump must have internal bleed down compensator option.
- 3.7.2.9 Compensator shall have 2 ports to choose from for the load sense line for ease of installation.

**3.7.3 Hydraulic Stack Valve:**

- 3.7.3.1 The valve shall be of a mobile stackable design load sensing type.
- 3.7.3.2 The valve shall be all cast iron design and all sections must be of the same valve series.
- 3.7.3.3 The valve shall be capable of a nominal 35 GPM minimum with published flow curves to 40 GPM maximum.
- 3.7.3.4 The valve must be pressure and flow compensated.
- 3.7.3.5 Inlet and outlet ports to be 1" O-ring, all working ports shall be 5/8" O-ring minimum.
- 3.7.3.6 Valve to be arranged as follows:

A. Inlet cap with top ported pressure and tank, load sense and drain ports, must also have pressure core blocking to help coupler dis-connect.

B. Double acting cylinder spool for hoist 0 minimum-32 maximum GPM, proportional 12VDC operated, with spring return to neutral. Section shall have manual handle overrides with stroke limiters and 500 PSI minimum down side load sense relief.

C. Double acting cylinder spool for plow lift, proportional 12VDC operated with spring return to neutral. Pressure compensated 0 minimum-10 maximum GPM main spool. Section shall have manual handle overrides and stroke limiters.

D. Double acting cylinder spool for plow angle, proportional 12VDC operated with spring return to neutral. Pressure compensated 0 minimum – 15 maximum GPM main spool. Section shall have manual handle overrides and stroke limiters.

CRFQ 0803 DOT1700000088  
REQUEST FOR QUOTATION  
**64,000 GVWR Tandem Axle Dump Truck**  
**w/Front Snow Plow, V-Box Spreader, with Optional Right Front Wing Plow and Anti-  
Icing Tank & Spray System**

---

**E.** Single acting 0 minimum – 15 maximum GPM spool for feeder, proportional 12VDC spring to center with manual override.

**F.** Single acting 0 minimum -7 maximum GPM spool for spinner, proportional 12VDC spring to center with manual override.

**G.** Single acting 0 minimum -7 maximum GPM spool for pre-wet, proportional 12VDC spring to center with manual override.

**H.** Single acting 0 minimum – 15 maximum GPM spool for Anti-Ice, proportional 12VDC spring to center with manual override.

**3.7.3.7** Spreader and pre-wet sections shall be part of a manifold assembly that has a bleed orifice and bolts to the valve sections.

**3.7.3.7.1** Aluminum single block manifold valves and sub-plate mounted valves will not be accepted.

**3.7.4. CONTROLS FOR DUMP BODY HOIST and SNOW PLOW and SPREADER:**

**3.7.4.1** Shall be a one piece modular control arm design for a variety of joystick controls, control and switch configurations.

**3.7.4.2** Unit shall come with 2 fully proportional joysticks for hoist and plow.

**3.7.4.3** Shall have a single axis control with dead man switch for hoist.

**3.7.4.4** Shall have a dual axis “+” design for snowplow and wing up/down, and left/right control.

**3.7.4.5** CAN based wiring for ease of installation.

**3.7.4.6** Joysticks can be trimmed for minimum and maximum speed on screen.

**3.7.4.7** Armrest style console shall be fully adjustable to accommodate automatic transmissions, and mount close to drivers seat right hand side.

**3.7.4.8** Control unit shall be fully adjustable and swivel left to right.

**3.7.4.9** Display messages for: Low Oil, Body Up, Change Filter, Plow Float and lane selection.

**3.7.4.10** All messages shall be displayed on the display and show the actual name of the message.

**3.7.4.11** Console shall have 3 on/off rocker switches in the arm for left, center, and right lane for anti-icing.

**3.7.4.12** Console shall have a PTO switch for on/off, Plow balance switch for on/off and a momentary position for low oil override.



CRFQ 0803 DOT1700000088  
REQUEST FOR QUOTATION  
**64,000 GVWR Tandem Axle Dump Truck**  
**w/Front Snow Plow, V-Box Spreader, with Optional Right Front Wing Plow and Anti-Icing Tank & Spray System**

---

- 3.7.4.13 Shall be full closed loop operation for auger, pre-wet and anti-ice functions.
- 3.7.4.14 Closed loop on the auger shall be with the sensor built into the motor and shall be a M12 connection.
- 3.7.4.15 Unit shall have a surface patrol air/temp sensor and must be on display.
- 3.7.4.16 Unit shall come with full schematic documentation.

**3.8 SPREADER CONTROLLER-** The intent of this specification is to describe a complete control system that operates on a CAN-Bus. The system communicates over a CANOpen bus system using CANOpen protocol.

**3.8.1 The System:**

- 3.8.1.1 The system shall consist of four primary modules that reside on the CAN bus and allow flexibility in mounting configurations. The system is completely expandable and allows for additional modules to be added to the CAN bus. All four primary components of the system are software upgradeable. The configuration file of a calibrated system can be saved for transfer to other systems or as a backup providing the ability to use a specific configuration for varying vehicle use or operator skill level.
  - 3.8.1.1.1 The configuration file will be accessible by a USB port located in the display.
  - 3.8.1.1.2 The original configuration is maintained at the factory as a secondary backup and is traceable by part number.
- 3.8.1.2 The in-cab axis controls must be placed on the CAN Open bus by utilizing an encoder module which has (5) 0-5v analog inputs and (14) PnP Digital Inputs.
  - 3.8.1.2.1 The Encoder module will use a circuit board that has been conformal coated to provide moisture and shock resistance.
  - 3.8.1.2.2 The system will support up to (2) Joystick encoder modules and be able to support 10 physical joystick axes maximum and 10 virtual axes maximum.
- 3.8.1.3 The display can be attached to the system panel or remote mounted. Joystick function will be clearly labeled on a graphic overlay providing basic operator instruction.
  - 3.8.1.3.1 The system panel can be positioned over a 360 degree rotation and 4 inches minimum of vertical travel on its mounting tube.
  - 3.8.1.3.2 The optional Touch-guard panel can be remote mounted, mounted in the system panel, or armrest.

CRFQ 0803 DOT1700000088  
REQUEST FOR QUOTATION  
**64,000 GVWR Tandem Axle Dump Truck**  
**w/Front Snow Plow, V-Box Spreader, with Optional Right Front Wing Plow and Anti-  
Icing Tank & Spray System**

---

**3.8.1.3.3** Up to (4) Touch-guard systems can be associated on the same CAN bus.

**3.8.1.4** The system must boot in 35 seconds or less and must not consume power when the ignition key is turned off.

**3.8.1.4.1** Systems that draw power in the “off mode” to manage system boot time between ignition cycles are not acceptable.

**3.8.2 The Display:**

**3.8.2.1** The Display will include a 7 inch minimum, color touchscreen enclosed within aluminum housing. (1) USB port and (4) Digital outputs capable to 400 mA minimum.

**3.8.2.2** The display will include a well-designed User Interface (UI) that allows the user to navigate within the system software. The UI will include a self-guided tutorial for setup and calibration. Context appropriate help menus will also be available within individual setup screens.

**3.8.2.2.1** The display must use a panel layout design which can be customized by the end user by changing the location, size, and color of the panels.

**3.8.2.2.2** Display shall have a USB drive for firmware updates, configurations, and calibrations saving and uploading.

**3.8.2.2.3** The complete configuration and calibration values shall also be in a spread sheet format when downloaded.

**3.8.2.2.4** The operator shall be able to make changes to the rate, lane, pre-wet, and anti-ice functions using the operator panel or the touchscreen.

**3.8.2.3** The screen layout will be user defined to optimize functions as well as to view and interact with the system within a 4x5 inch minimum grid layout.

**3.8.2.3.1** Users may combine or separate grid location boxes in order to view system information in the combination and shape of their choosing.

**3.8.2.3.2** Users will be able to reconfigure the system for rapid transition between winter and summer operations with unique layouts and system configurations.

**3.8.2.4** System information on the screen may include, but is not limited to:

**3.8.2.4.1** granular rates, pre-wet and anti-ice rates, lane indication, road/air temperature, hydraulic pressure, system status, error messages, plow float indication, auto/manual mode indication and material currently being used.

**3.8.2.4.2** Active functions that are not in use shall show “off” and the graphic be “grayed out” for ease of operator interpretation.

**3.8.2.4.3** Tile color assignments may be customized by the user.

CRFQ 0803 DOT1700000088  
REQUEST FOR QUOTATION  
**64,000 GVWR Tandem Axle Dump Truck**  
**w/Front Snow Plow, V-Box Spreader, with Optional Right Front Wing Plow and Anti-  
Icing Tank & Spray System**

---

**3.8.2.5** The display will provide a built in diagnostic feature allowing technicians to view all input signals in real time.

**3.8.2.5.1** The display will also provide error logging and system status change logging for reviewing operator inputs.

**3.8.3 The Software:**

**3.8.3.1** The system shall incorporate three levels of security and access that is password protected and defined by the user.

**3.8.3.1.1** The three levels of access called “user”, “technician” and “admin” shall give the user varying levels of access to the system setup, data, configuration fields and parameters based upon access given.

**3.8.3.1.2** The “administrator” shall have full access to all menus in the system and have the ability to make system configuration changes as well as system parameter changes.

**3.8.3.2** Spreader and liquid functions must have the ability to be controlled utilizing closed loop feedback.

**3.8.3.2.1** The system will automatically default to open loop operation in the event of a sensor failure or loss of input.

**3.8.3.2.2** The system will alert the operator and log the error.

**3.8.3.2.3** The system shall have “over speed” protection for the liquid functions that will alert the operator and shut down the liquid function when the driver has exceeded a user defined speed.

**3.8.3.3** Non-critical alerts such as sensor faults must not create alarms that distract the driver by requiring action to clear or stop the audible alarm.

**3.8.3.3.1** When a sensor fault is detected, materiel application will continue in open loop mode.

**3.8.3.4** The software shall include as a baked in safety feature the ability to configure a “Panic mode” where momentary operation of a switch in the console starts a timed cycle which automatically retracts user specified functions at a predetermined trim value.

**3.8.3.4.1** After the cycle times out the system shall return to normal operation.

**3.8.3.5** The software shall incorporate a “test speed” mode for use in testing the system safely without requiring the truck to be moving or the drive axles engaged.

**3.8.3.6** The system must be able to independently operate a second spreader (such as a tow plow) that includes liquid or granular application without the installation of multiple control systems.

CRFQ 0803 DOT1700000088  
REQUEST FOR QUOTATION  
**64,000 GVWR Tandem Axle Dump Truck**  
**w/Front Snow Plow, V-Box Spreader, with Optional Right Front Wing Plow and Anti-  
Icing Tank & Spray System**

---

- 3.8.3.6.1** Rate information must be able to be displayed on a single display screen for both the main unit and the towed equipment.
- 3.8.3.6.2** Both must be controlled from one operator panel.
- 3.8.3.6.3** Application rates may run independently or be slaved to the main unit.
- 3.8.3.6.4** The system will also be capable of dynamic variable gate control and cross conveyor support.

**3.8.4 The Valve driver module:**

- 3.8.4.1** IP68 compliant (dust, submersible and water type) sealed assembly shall be mounted to the valve enclosure providing both interior and exterior electrical connections.
  - 3.8.4.1.1** The valve driver module drives maximum of (14) 6 amp PWM channels, accepts 4 – 20mA input, 4 closed loop feedback signals, and multiple digital inputs.
    - 3.8.4.1.1.1** All PWM outputs are software configurable and can be controlled by closed loop operation, proportional input devices, or digital input devices.
  - 3.8.4.1.2** The module includes: over temperature shutdown, over current shutdown, and low voltage shutdown.
  - 3.8.4.1.3** All electrical connections are IP68 sealed when mated, utilizing threaded connections for positive retention.

**3.8.5 The Operator panel:**

- 3.8.5.1** The operator panel shall be enclosed in an aluminum housing which includes crash bars to protect the buttons and rotary encoders.
  - 3.8.5.1.1** It will include a silicone keypad with conductive carbon contacts and (3) rotary encoders that are individually repairable.
    - 3.8.5.1.1.1** These encoders will have detent positions that will be user programmable as to the value of each increment in the setup menu.
  - 3.8.5.2** The operator panel provides input capabilities to support RS232, RS422, truck speed input, and multiple digital input/output.
  - 3.8.5.3** The panel shall have surface patrol air temperature sending unit.
  - 3.8.5.4** The panel has built in LED backlighting that dims with the display for night viewing.

CRFQ 0803 DOT1700000088  
REQUEST FOR QUOTATION  
**64,000 GVWR Tandem Axle Dump Truck**  
**w/Front Snow Plow, V-Box Spreader, with Optional Right Front Wing Plow and Anti-**  
**Icing Tank & Spray System**

---

**3.8.5.5** The panel shall incorporate button labeled: Blast, Pause, Liquid, Spreader, Mode, Product, and Select.

**3.8.6 “TPE” Thermoplastic Elastomer Wiring Specification:**

**3.8.6.1** The system must make heavy use of electrical connections and cables that resist corrosion and contaminant ingress in all areas exposed to the elements.

**3.8.6.2** Wiring and harness system shall meet ISO rating IP68 and NEMA 6.

**3.8.6.3** The connectors shall be stainless steel or nickel plated brass.

**3.8.6.3.1** Each shall have three sealing points: the lock ring itself, a raised portion of the molded plastic around each pin, and a Viton O-ring that seals the entire connector.

**3.8.6.4** The cable jacket shall be TPE- thermoplastic elastomer, and molded to the connectors.

**3.8.6.5** Connectors and harness shall be rated and tested for a temperature range from – 30C to + 70C.

**3.8.6.6** Cabling shall be rated excellent in low temperature flexibility and in its resistance to oxidation, heat, oil, weather, sun, ozone, abrasion, electrical priorities, flame, water, acid, alkali, gasoline, benzol, toluol, degreaser solvents, alcohol, and weld slag.

**3.8.7 Reservoir/Valve Compartment:**

**3.8.7.1** Shall have one (1) 30 gallon all-welded 7 gauge minimum 201 stainless steel hydraulic oil reservoir/valve compartment frame mounted.

**3.8.7.1.1** Shall be mounted in a manner not to transmit any truck torsional loads thru the tank.

**3.8.7.1.2** Valve component shall be accessible with bed body down.

**3.8.7.2** Hydraulic Tank shall be internally baffled and must have oil level site glass with thermometer.

**3.8.7.3** Valve enclosure shall be protected from both road and pressure washer spray and shall accommodate valve stack and plow balance valve.

**3.8.7.4** A 2 inch full flow brass ball valve shall be plumbed at the suction port of the tank.

**3.8.7.5** Hydraulic oil filter shall be mounted in the reservoir.

**3.8.7.5.1** Hydraulic filter shall be a 10-micron minimum with a bypass and replaceable cartridge.

**3.8.7.5.2** Filter shall be capable of 80 GPM minimum flow capacity.

**3.8.7.6** Tank shall be equipped with a 10 micron minimum filler/breather cap with removable 500 micron minimum stainless steel strainer.

CRFQ 0803 DOT1700000088  
REQUEST FOR QUOTATION  
**64,000 GVWR Tandem Axle Dump Truck**  
**w/Front Snow Plow, V-Box Spreader, with Optional Right Front Wing Plow and Anti-**  
**Icing Tank & Spray System**

---

**3.8.7.7** Tank shall include low oil, filter and temperature sensors.

**3.8.8 Hydraulic Lines and Fittings:**

- 3.8.8.1** Stainless steel tubing to be used under body and cab in lieu of hosing.
  - 3.8.8.1.1** Only hosing to be used is at the ends of the stainless steel tubing to each function's quick couplers or connection.
  - 3.8.8.1.2** Tubing shall be seamless #201 minimum stainless steel construction with a minimum wall thickness of 0.065".
    - 3.8.8.1.2.1** The ends must be flared to accommodate a 37 degree JIC fitting.
    - 3.8.8.1.2.2** The use of compression fittings is not acceptable.
    - 3.8.8.1.2.3** Spacing of ½ inch minimum of each tube to allow for material to fall between each tube.
- 3.8.8.2** All stainless tubing must be mounted in polyurethane poly green tube clamps.
- 3.8.8.3** All hoses shall be wire braid reinforced with swaged on high pressure JIC 37 degree tapered seat end fittings.
- 3.8.8.4** All fittings & adapters shall be forged steel (No tapered pipe fittings except on suction hose).
- 3.8.8.5** Spreader stainless steel hose couplers shall be mounted on either Frame rail or pintle plate under dump body at rear.
- 3.8.8.6** Shall have polymer dust plugs or caps on all couplers with retainer straps.
- 3.8.8.7** All hoses shall be routed away from chassis exhaust whenever possible to protect against heat deterioration.
- 3.8.8.8** All hoses shall be properly rated for pressure of hydraulic system.
- 3.8.8.9** All hose ends connecting to valve assembly shall be 90-degree female JIC swivel.
- 3.8.8.10** Suction Hose shall be 2" ID SAE 100R4 style or equal, connecting the pump and reservoir with a king nipples, with both ends being double clamped with T-bolt style stainless steel super clamps.
- 3.8.8.11** Pressure hose shall be 1" ID minimum 2000 PSI rated with female JIC swivels at both ends.
- 3.8.8.12** Return line shall be 1 ¼" ID SAE 100R4 style or equal with female JIC swivels at both ends.
- 3.8.8.13** Hoist raise line shall be ¾" ID, lower line ½", minimum 2250 PSI rated with female JIC swivels at both ends.

CRFQ 0803 DOT1700000088  
REQUEST FOR QUOTATION  
**64,000 GVWR Tandem Axle Dump Truck**  
**w/Front Snow Plow, V-Box Spreader, with Optional Right Front Wing Plow and Anti-  
Icing Tank & Spray System**

---

- 3.8.8.14** Plow and wing lines shall be 1/2" ID minimum 2250 PSI rated, ran to front of truck with female JIC swivels at both ends.
- 3.8.8.15** Auger and anti-ice line shall be 3/4" ID minimum 2250 PSI rated and have female JIC swivels at both ends.
- 3.8.8.16** Spinner line shall be 1/2" ID minimum 2250 PSI rated and have female JIC swivels at both ends.
- 3.8.8.17** Spreader return line shall be 1" ID SAE 100R4 style or equal with female JIC swivels at both ends.
- 3.8.8.18** Pump case drain shall be 3/4" ID minimum 2250 PSI rated and have female JIC swivels at both ends.
- 3.8.8.19** Load sense line shall be 3/8" ID 2250 PSI minimum rated and have female JIC swivels at both ends.

### **3.8.9 PLOW BALANCE VALVE**

- 3.8.9.1** System to be supplied with a plow balance valve.
  - 3.8.9.1.1** Valve to be designed to offset a specific (adjustable) plow weight when activated.
  - 3.8.9.1.2** Valve to be of cartridge and manifold design, and electrically activated.
  - 3.8.9.1.3** In the case of a load sense hydraulic system, the valve shall be activated by a single solenoid.
  - 3.8.9.1.4** In the case of an open center system, the valve is to be activated by two solenoids- one for the plow offset and one for an integral unloader.
- 3.8.9.2** The plow balance system must not alter the operation of any other hydraulic function on the vehicle or effect the performance of other hydraulically operated equipment including wing plow, body hoist, and plow hoist or angle, or spreader functions.
  - 3.8.9.2.1** Operation of any electrical switches beyond the normal up/down command to raise or lower the plow is not acceptable.
- 3.8.9.3** The plow balance system will remain electrically activated when lifting the plow from the road surface.
  - 3.8.9.3.1** Plow lift must be immediate.
    - 3.8.9.3.1.1** It is not necessary to turn off the system for plow lift.
    - 3.8.9.3.2** Plow lowering and return to balance mode must be done by activating the plow lever or switch to the lower mode.
- 3.8.9.4** The plow balance system must be able to hold the plow in the up position indefinitely.

CRFQ 0803 DOT1700000088  
REQUEST FOR QUOTATION  
**64,000 GVWR Tandem Axle Dump Truck**  
**w/Front Snow Plow, V-Box Spreader, with Optional Right Front Wing Plow and Anti-Icing Tank & Spray System**

---

- 3.8.9.5 The plow balance manifold shall be of cartridge style valve utilizing “floating” style cartridge valves.
- 3.8.9.6 The valve body must be constructed of aluminum and have minimum construction whole plugs.
- 3.8.9.7 All solenoid valve coils shall have manual override capabilities.
- 3.8.9.8 Manifold must include a pressure test point for use when checking balance pressures.
  - 3.8.9.8.1 The pressure test point must be capable of taping into the system at pressures of up to 5000 PSI.
- 3.8.9.9 The plow balance valve must be installed in the valve/tank combination.

**3.8.10 Hydraulic Test and Inspection:**

- 3.8.10.1 Any items not specifically stated herein, but necessary for proper system operation, shall comply with recommended hydraulic industry standards.
- 3.8.10.2 The vendor shall be responsible for pre-testing of hydraulic system which shall include the following:
  - 3.8.10.2.1 A startup and initial high pressure run of all hydraulic system components shall be done to check for leaks, heat buildup, system efficiency, pressure settings, etc.
- 3.8.10.3 Vendor will be responsible for initial test of spreader and all plow circuits including wing plow and wet tank if equipped.
- 3.8.10.4 After complete testing of hydraulic system, hydraulic filter must be changed.

**3.8.11 Miscellaneous Information:**

- 3.8.11.1 The vendor is responsible to furnish a truck that is properly engineered and that confirms to all and any laws governing such equipment.

**3.8.12 Unspecified Accessories & Features:**

- 3.8.12.1 All parts, equipment, accessories, materials, design and performance characteristics not specified herein, but which are necessary to provide a complete unit, must be furnished with each unit and required to conform to strength, quality of material, and quality of workmanship to those which are advertised and provided to the market in general by the unit Industry.



CRFQ 0803 DOT1700000088  
REQUEST FOR QUOTATION  
**64,000 GVWR Tandem Axle Dump Truck**  
**w/Front Snow Plow, V-Box Spreader, with Optional Right Front Wing Plow and Anti-  
Icing Tank & Spray System**

---

**3.8.12.2** All parts and accessories advertised and regularly supplied as standard shall be included, except those which would represent duplication of these specified and except those which, by specification, are not to be furnished.

**3.8.12.3** All standard safety features, required by Federal and State Law, shall be included.

**3.8.13 Pre Build Meeting:**

**3.8.13.1** After award of contract there will be a mandatory pre-build meeting with successful vendor, manufacturers and up fitters at:

The WVDOT/Equipment Division,  
83 Brushy Fork Rd. Crossing,  
Buckhannon WV.

**3.8.14 Advertising:**

**3.8.14.1** No visible decals or name plates or painted on names representing the manufacturer or model number or trademark shall appear on the exterior surface of the unit.

**3.8.14.1.1** Such logos created through the stamping or casting process of manufacture are accepted.

**4. CONTRACT AWARD:**

**4.1 Contract Award:** The Contract is intended to provide Agencies with a purchase price on all Contract Items. The Contract shall be awarded to the Vendor that provides all the Contract Items meeting the required specifications for the lowest overall total cost as shown on the Pricing Pages.

**4.2 Pricing Pages:** Vendor must complete and submit the Pricing Pages (**Exhibit A**) by completing the Year, Make, Model and inserting quoted Unit Price. Vendor shall take estimated Quantity and multiply by unit price to get grand total. Vendor should complete the **Exhibit A** Pricing Pages in their entirety as failure to do so may result in Vendor's bids being disqualified.

The Pricing Pages contain a list of the Contract Items and estimated purchase volume. The estimated purchase volume for each item represents the approximate volume of anticipated purchases only. No future use of the Contract or any individual item is guaranteed or implied.

CRFQ 0803 DOT1700000088  
REQUEST FOR QUOTATION  
**64,000 GVWR Tandem Axle Dump Truck**  
**w/Front Snow Plow, V-Box Spreader, with Optional Right Front Wing Plow and Anti-  
Icing Tank & Spray System**

---

Vendor should electronically enter the information into the Pricing Pages through wvOASIS, if available, or as an electronic document. In most cases, the Vendor can request an electronic copy of the Pricing Pages for bid purposes by sending an email request to the following address: [mark.a.atkins@wv.gov](mailto:mark.a.atkins@wv.gov)

**5. ORDERING AND PAYMENT:**

**5.1 Ordering:** Vendor shall accept orders through wvOASIS, regular mail, facsimile, e-mail, or any other written form of communication. Vendor may, but is not required to, accept on-line orders through a secure internet ordering portal/website. If Vendor has the ability to accept on-line orders, it should include in its response a brief description of how Agencies may utilize the on-line ordering system. Vendor shall ensure that its on-line ordering system is properly secured prior to processing Agency orders on-line.

**5.2 Payment:** Vendor shall accept payment in accordance with the payment procedures of the State of West Virginia.

**6. DELIVERY AND RETURN:**

**6.1 Delivery Time:** Vendor shall deliver standard orders within **180** working days after orders are received. Vendor shall ship all orders in accordance with the above schedule and shall not hold orders until a minimum delivery quantity is met. A completed pilot model for inspection must be provided within 120 working day(s) after receipt of the purchase agreement by the successful vendor. Working day is defined as any week day, Monday thru Friday, excluding Federal and State Holidays.

**6.2 Late Delivery:** The Agency placing the order under this Contract must be notified in writing if orders will be delayed for any reason. Any delay in delivery that could cause harm to an Agency will be grounds for cancellation of the delayed order, and/or obtaining the items ordered from a third party.

Any Agency seeking to obtain items from a third party under this provision must first obtain approval of the Purchasing Division.

**6.3 Delivery Payment/Risk of Loss:** Standard order delivery shall be F.O.B. destination to the Agency's location. Vendor shall include the cost of standard order delivery charges in its bid pricing/discount and is not permitted to charge the Agency separately for such delivery.

CRFQ 0803 DOT1700000088  
REQUEST FOR QUOTATION  
**64,000 GVWR Tandem Axle Dump Truck**  
**w/Front Snow Plow, V-Box Spreader, with Optional Right Front Wing Plow and Anti-Icing Tank & Spray System**

---

**6.4 Representative Unit for Test:** The successful vendor must (if specified) provide the DOH one (1) completed represented unit to be observed and evaluated on each order to insure compliance with specification. If requested, the time period for testing and evaluation shall be seven (7) working days following receipt of the unit. DOH will incur no obligation for deterioration of surfaces, finishes, seals, and mechanical or electrical parts on the unit resulting from operation and testing within the limits of these specifications; nor will DOH incur obligation for damage to the unit resulting from failure to meet specifications when due care and attention is given by DOH and testing is done within the limits of these specifications. Failure of the pilot unit to satisfactorily meet specifications as bid may be cause for cancellation of the purchase order, and return of the delivered unit along with all associated equipment to the vendor at the vendor's expense.

**6.5 Condition of Unit(s) Upon Delivery:** All units must arrive at the prescribed delivery point having been completely pre-serviced with oil, lubricants, and coolant. All prescribed precautions pertaining to first operations and break-in of the unit are to be posted conspicuously on the unit for ready observance by the operator.

**6.6 Delivery Point:** Delivery point of the completed representative unit will be the WVDOH, Equipment Division, 83 Brushy Fork Crossing, Buckhannon, WV 26201.

**7. VENDOR DEFAULT:**

**7.1**The following shall be considered a vendor default under this Contract.

**7.1.1** Failure to provide Contract Items in accordance with the requirements contained herein.

**7.1.2** Failure to comply with other specifications and requirements contained herein.

**7.1.3** Failure to comply with any laws, rules, and ordinances applicable to the Contract Services provided under this Contract.

**7.1.4** Failure to remedy deficient performance upon request.

CRFQ 0803 DOT1700000088  
REQUEST FOR QUOTATION  
**64,000 GVWR Tandem Axle Dump Truck**  
**w/Front Snow Plow, V-Box Spreader, with Optional Right Front Wing Plow and Anti-Icing Tank & Spray System**

---

7.2 The following remedies shall be available to Agency upon default.

7.2.1 Immediate cancellation of the Contract.

7.2.2 Immediate cancellation of one or more release orders issued under this Contract.

7.2.3 Any other remedies available in law or equity.

**8. MISCELLANEOUS:**

**8.1 No Substitutions:** Vendor shall supply only Contract Items submitted in response to RFQ unless a contract modification is approved in accordance with the provisions contained in this contract.

**8.2 Reports:** Vendor shall provide quarterly reports and annual summaries to the Agency showing the Agency's items purchased, quantities of items purchased, and total dollar value of the items purchased. Vendor shall also provide reports, upon request, showing the items purchased during the term of this Contract, the quantity purchased for each of those items, and the total value of purchases for each of those items. Failure to supply such reports may be grounds for cancellation of this Contract.

**8.3 Contract Manager:** During its performance of this Contract, Vendor must designate and maintain a primary contract manager responsible for overseeing Vendor's responsibilities under this Contract. The Contract manager must be available during normal business hours to address any customer service or other issues related to this Contract. Vendor should list its Contract manager and his or her contact information below.

Contract Manager: Matt Cochran  
Telephone Number: 304-208-2542  
Fax Number: 304-759-9807  
Email Address: Matt.Cochran@thstruckpeople.com

**8.4 Operating and Service Manuals and Parts Lists:** An operator's manual must be included with each unit upon delivery. A "line sheet" (if applicable) and the "Equipment Preventative Maintenance Questionnaire", (**Exhibit "B"**) must be with pilot unit upon delivery, Attn: Marcia Lee. There must be 12 service/shop/maintenance manuals and 14 parts manuals; CD-ROM is preferred in lieu of parts manuals. Manuals shall be delivered upon completion of delivery of total units. Failure to do so will delay payment.

CRFQ 0803 DOT1700000088  
REQUEST FOR QUOTATION  
**64,000 GVWR Tandem Axle Dump Truck**  
**w/Front Snow Plow, V-Box Spreader, with Optional Right Front Wing Plow and Anti-Icing Tank & Spray System**

---

**8.5 Training:** Manufacturers and/or dealers will be required to stage a thorough seminar on the subjects of Preventative Maintenance, Operator, and Mechanic Training. In order to keep operators and mechanics updated, the successful vendor shall conduct training sessions covering the operation, maintenance, trouble-shooting with each purchase order against this open end contract. Manufacturers and/or dealers shall be required to furnish the Training Academy with one (1) Operator's Manual to be shipped direct to

**WVDOH**  
Training Academy  
P.O. Box 610  
Buckhannon, West Virginia 26201

after receiving the pilot unit. Training seminar to be held at the WVDOT, Equipment Division, Buckhannon, WV, after receiving the pilot unit.

**8.6 Preventative Maintenance & Operator Procedures:** Manufacturers and/or dealers will be required to submit to the Equipment Division, in addition to the operating and service manuals, booklets and pamphlets explaining the Preventative Maintenance and Operator Procedures to be used by the operators of this equipment, and must include such things as daily prestart inspection procedure, service schedule, and routine maintenance required, safety precautions, etc. The successful vendor shall furnish all training aids; i.e. videos, projectors as required in conducting the training.

**8.7 Warranty:**

**8.7.1 Bumper to Bumper:**

1 year warranty shall start on the final date of acceptance for the entire order.

**8.7.2 Engine Warranty:**

100% Parts and Labor for 60 months 150,000 Mile Engine Warranty, 5500 hours. Engine block shall be warranted against external perforation from corrosion for 60 months 100% parts and labor.

**8.7.3 Emissions Warranty:**

CRFQ 0803 DOT1700000088  
REQUEST FOR QUOTATION  
**64,000 GVWR Tandem Axle Dump Truck**  
**w/Front Snow Plow, V-Box Spreader, with Optional Right Front Wing Plow and Anti-Icing Tank & Spray System**

---

100% Parts and Labor for all emission related components to include the DPF for 60 Months 150,000 miles or 5500 engine hours. Shall be warranted against corrosion, rust, rust thru etc. regardless of atmospheric conditions.

**8.7.4 Transmission Warranty:**

100% Parts and Labor for 2 years unlimited mileage and hours. The transmission shall include all internal and external components related to the automatic transmission. This warranty shall also include, but not limited to, the transmission cooler, cooler hoses or lines, and all electrical transmission controls, harnesses, connections and modules regardless of atmospheric conditions.

**8.7.5 Radiator Warranty:**

100% for parts and labor for 2 years, regardless of atmospheric conditions.

**8.7.6 Differential/Axle Warranty:**

Shall be 36 months/350,000 miles, Parts and Labor

**8.7.7 Dump Body Warranty:**

Constructability and durability shall be guaranteed for 5 years parts and labor. Body hoist assembly 3 years parts and labor. Air Tailgate latch system, 3 years parts and labor. All body wiring and lighting shall be warranted for 5 years parts and labor.

**8.7.8 Central Hydraulic System Warranty:**

Complete Central Hydraulic System and components shall be warranted for 2 years 100% parts and labor. All wiring on system shall be warranted for 5 years 100% parts and labor. Hydraulic pump shall be 3 years 100% parts and labor.

**8.7.9 Front Plow and Wing Plow Warranty:**

Complete Plow warranty shall be 2years 100% parts and labor.

**8.7.10 V-Box Spreader and Wet Tank with Spraybar Warranty:**

2 years, 100 % parts and labor.

CRFQ 0803 DOT1700000088  
REQUEST FOR QUOTATION  
**64,000 GVWR Tandem Axle Dump Truck  
w/Front Snow Plow, V-Box Spreader, with Optional Right Front Wing Plow and Anti-  
Icing Tank & Spray System**

---

**8.7.11 Cab, Cab Structure, Frame Rails and Crossmembers Warranty:**

Cab, Cab Structure, Frame Rails and Crossmembers shall be warranty for corrosion for 5 years unlimited mileage 100% parts and labor.



# Construction

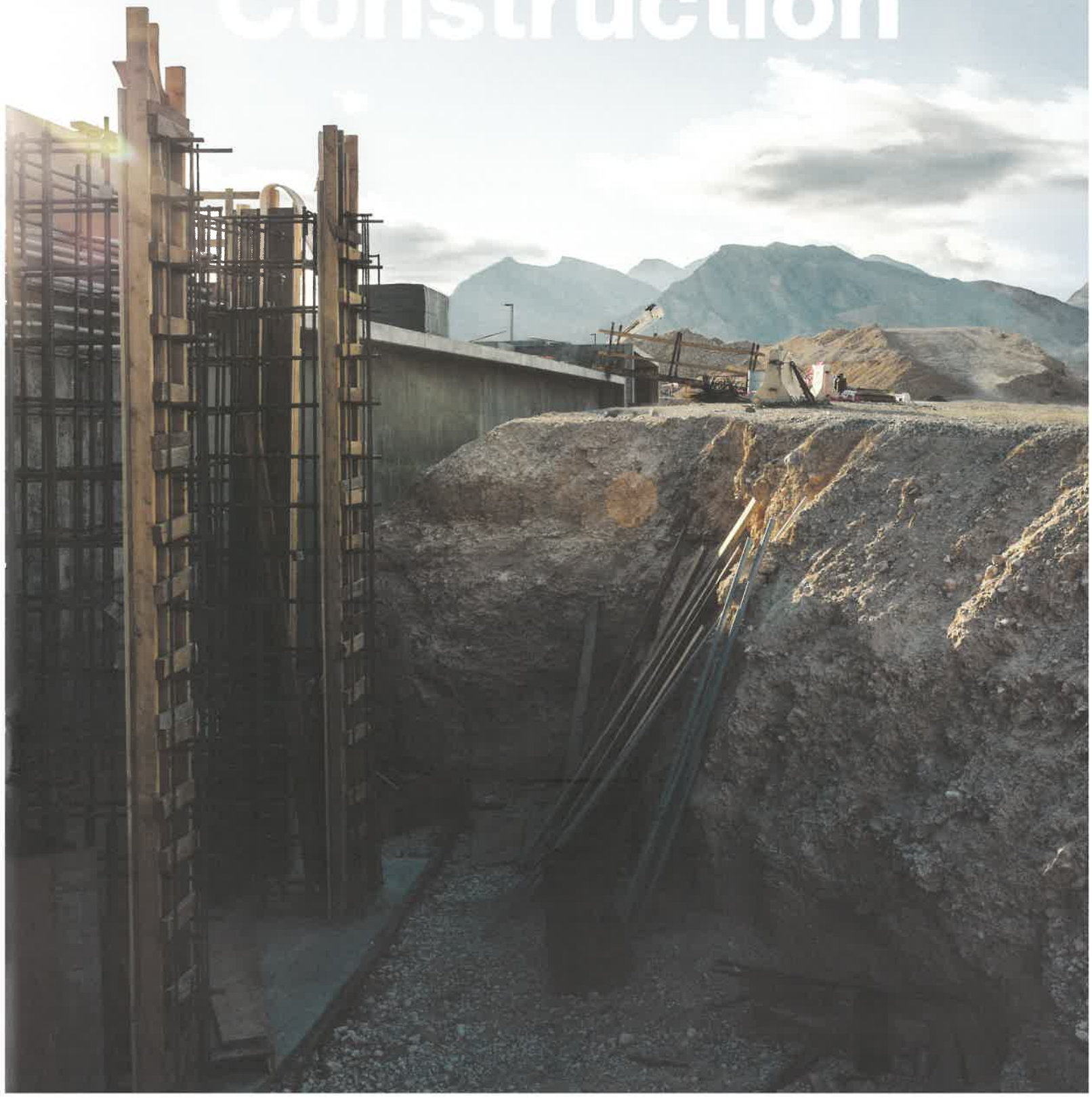



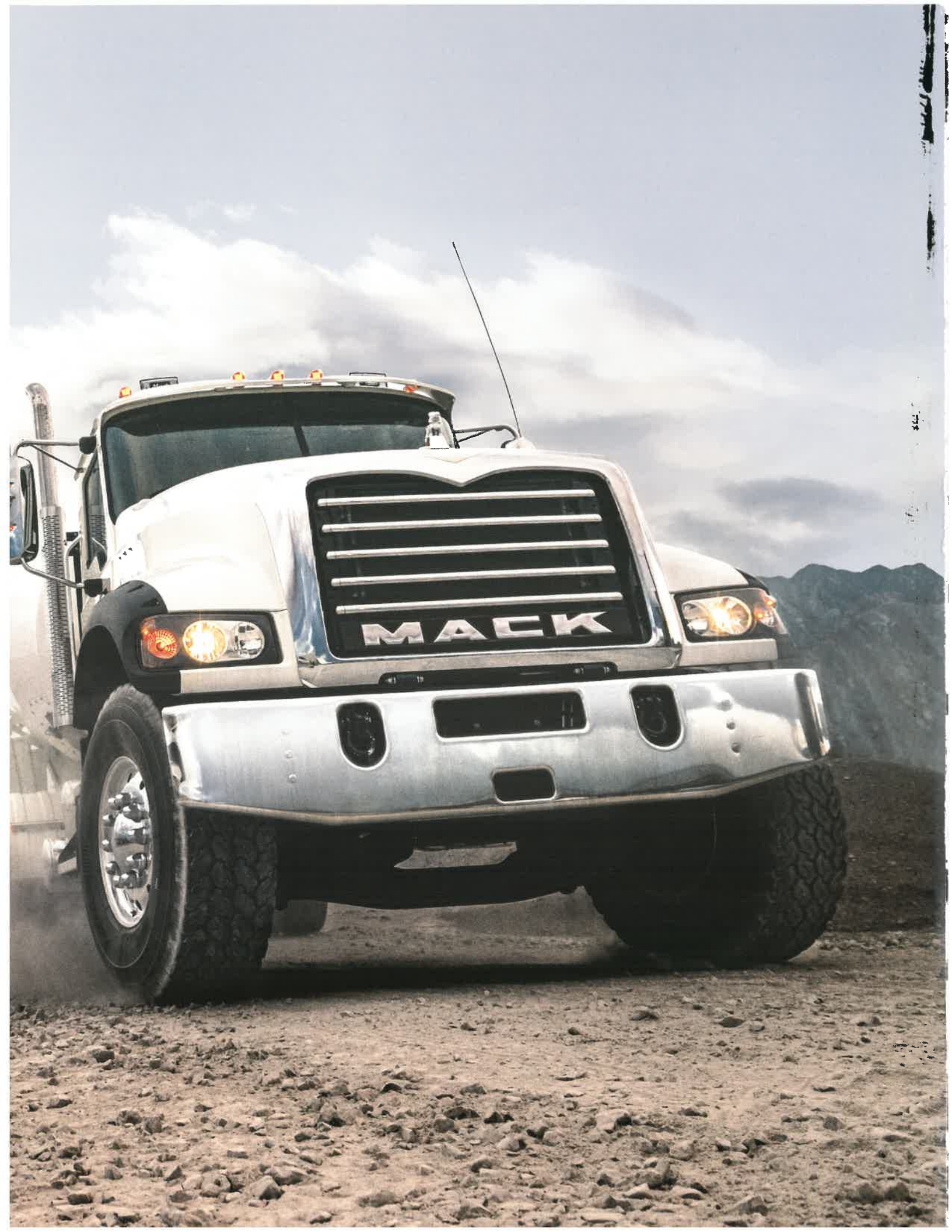

**OUT HERE,  
TRUCKS  
ARE BORN.  
AND LEGENDS  
MADE.**





# **IN CONSTRUCTION, IT'S ALL OR NOTHING.**

Constructed with purpose. Prepared for anything. Mack® trucks are designed to match the demands of your most severe sites. Because we didn't just build America, we built a reputation as the leaders in construction.





### Concrete Pump

Kick mediocrity to the curb. These trucks come equipped with both the power and precision to successfully complete any concrete job.



### Dump

Welcome complete control. Our highly customizable dump trucks put you in the driver's seat to tackle each day on your terms.



### Mixer

Push productivity forward. These lightweight trucks move more without sacrificing durability.



### Service/Utility

Combine power and the right-sized components, and you have the strength to handle heavy-duty jobs.



### Severe Duty

Rest is for the weak. From start to finish, these trucks are prepared to deliver no-compromise performance for the heaviest of your heavy hauls.



### Tractor

Any site, any time. Mack tractors are ready to tackle mean streets or no streets.

Granite®



**WE BUILD THE  
TRUCKS THAT BUILD  
EVERYTHING ELSE.**

Titan by Mack







TerraPro™

These are the leaders of the construction world. The team of trucks that have defined the industry for generations—and continue to push it forward. Engineered with renowned Mack reliability, we deliver the durable, modern day machines that allow you to deliver on the jobsite.



Granite® MHD

# Granite

Mack® Granite® is the unyielding foundation of any jobsite. One of the most popular and proven trucks on the road, Granite has the brains to boost your bottom line and the brawn to get the job done right.

## MP® engines

The 11-liter MP7® and 13-liter MP8® top out at 405 and 505 HP respectively giving you the muscle to shoulder heavy loads.

## Cornerstone™ chassis

The *Cornerstone's* frame system gives you the versatility to choose the right thickness and strength for your demanding applications.

## Unimax® axles

These maintenance-free axles give drivers exceptional front wheel cuts, clearance and turning radius.

## Optimized driveline angle

Mack's top-mounted rear axle carriers ensure an optimized driveline angle for longer component life and a smoother operation.

## Built for your application

Granite delivers across the board. This truck can be optimized to crush any job.

## Axle Configurations

Available in single, tandem and tri-drive configurations, Granite can be customized with multiple steering, drive and auxiliary axle combinations.

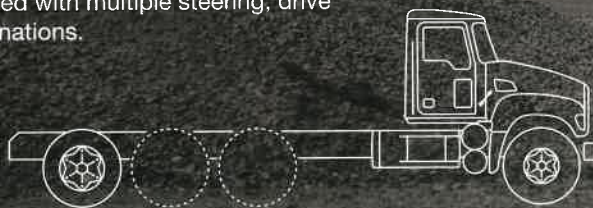







# Granite Mixer



# Mack® Granite® mixers haul heavier loads and keep America moving forward.

## Weight savings

Its weight-saving design and productivity-boosting components make for greater payload.

## Optimization

We match the exact mix of Mack components to your job.

## Safety

Our roll stability advantage and exceptional brakes keep you from turning over while tackling rugged terrain. Plus, we offer outstanding visibility to make sure your Mack meets no surprises on-site.





# Granite Dump



Mack® Granite® dump trucks shrug off the abuse of the jobsite so you can focus on your job.

**Weight savings**

Lightweight components and options such as lift axles help maximize hauling capacity and productivity.

**“D”-shaped fuel tank**

Options like the “D”-shaped fuel tank save you critical weight and space.

**Custom frame rails**

No matter what your load, Mack offers customizable frame rails to fit your construction needs.





# Granite MHD

Get nothing but rock-solid performance out of the Mack<sup>®</sup> Granite<sup>®</sup> MHD. Ideally configured for shorter runs and lighter-duty cycles, this truck cuts weight without sacrificing durability.

## 9-liter engine

MHD's lightweight, dependable 9-liter Cummins ISL engine reaches 345 HP with maximum torque rating of 1,150 lb.-ft.

## Cornerstone<sup>™</sup> chassis

Built with the MHD in mind, the 7-mm steel alloy frame rail is durable and reliable.

## "D"-shaped fuel tank

This unique design allows you to hold more fuel without sacrificing space.

## Unimax<sup>®</sup> axles

Featuring outstanding wheel cuts, front-end swing clearance and exceptional turning radius, the 16,000-lb. axle capacity is a great choice for the MHD.

## Galvanized steel cab

Mounted on airbags and shocks, our durable galvanized steel cab soaks up the rough stuff, so you ride in comfort.

## Axle Configurations

Granite MHD is available in single and tandem axle configurations.







# TerraPro

Meet the truck designed for best-in-industry packaging for concrete boom pumps. It has up to 505 HP with great ergonomics and visibility.

## MP<sup>®</sup> engine series

Combine fuel-efficient engines with low-end torque, and you get the MP Engine Series: the heartbeat of the Mack TerraPro.

## ClearTech<sup>™</sup> emissions control system

Mack delivers ultra low emissions while maximizing space on chassis and frame.

## Durable chassis

Built to adapt to customer needs, TerraPro's chassis is optimized to tackle big-time construction jobs.

## Exceptional visibility

The large windshield, low-profile dash, side and rear mirrors and ergonomic seat position provide drivers with superior visibility.

## Axle Configurations

Available in single, tandem and tri-drive configurations, TerraPro can be customized with multiple steering, drive and auxiliary axle combinations.

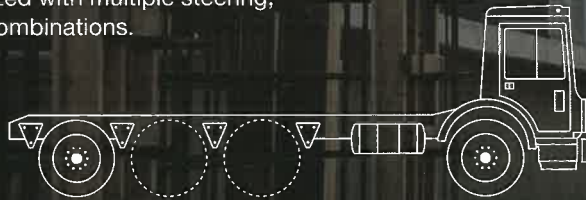







# Titan by Mack

This colossal feat of engineering refuses to be ignored. The truck houses Mack's largest-ever engine with up to 605 HP, with 2,060 lb.-ft. Because when it comes to Titan, it's all about power.

## Cornerstone™ chassis

A strong frame, impressive handling and great ground clearance make this sturdy chassis ideal for punishing off-road applications.

## MP10® engine

Made for heavy transport, Titan's engine is in a league of its own boasting a best-in-class torque rating of 2,060 lb.-ft. at 1,200 RPMs.

## Application excellence

Titan's high capacity cooling package is built for handling heavy loads.

## Fuel efficiency

Intelligent fuel injectors, sophisticated software and improved air management systems provide Titan with optimum fuel efficiency.

## Decreased downtime

The 30,000-mile oil drain intervals and hassle-free servicing work as hard as you do to reduce costs and maintenance.

## Axle Configurations

Available in tandem and tri-drive configurations, Titan can be customized with multiple steering, drive and auxiliary axle combinations.

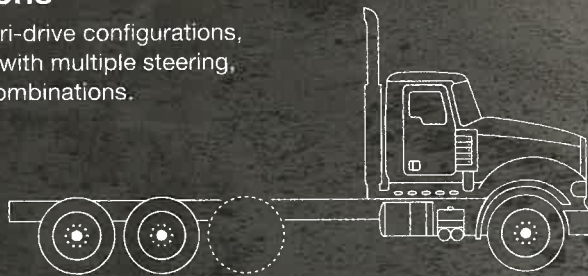





# Integrated powertrain? Try integrated everything.

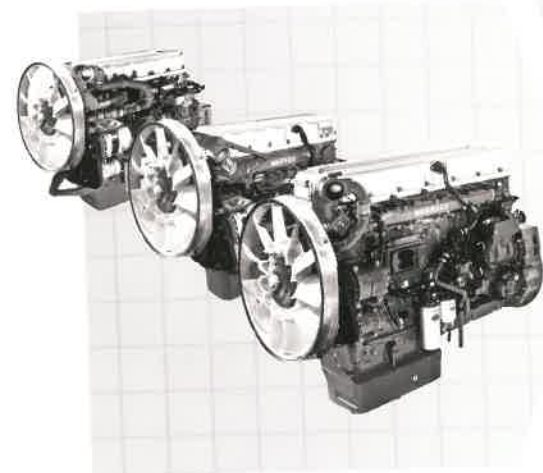

## MP<sup>®</sup> Engine Series

With muscle, torque and great fuel economy, Mack MP engines conquer the workday, mile after mile.



## Mack<sup>®</sup> Transmissions

Mack's transmissions are designed and built to perform at the highest level in the most demanding conditions, just like the rest of the truck.

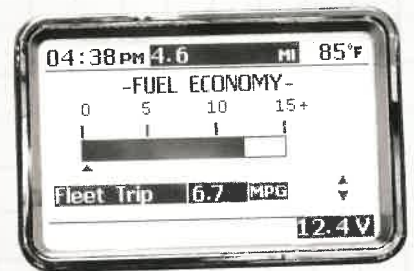

## Mack<sup>®</sup> Electronics

Featuring proven V-MAC<sup>®</sup> IV electronics, Mack makes it easier to work the way you want. Effortlessly manage your truck and engine, so you save on fuel and boost your bottom line.



It's one thing to invent the integrated powertrain. We did that more than 100 years ago, and today our revolutionary Pedigree™ Powertrain sets the gold standard.

Now, we've gone ahead and integrated the whole truck operating experience. From financing to service to 24/7 support, Mack has taken uptime and productivity to a whole new level.



### **Mack® Axles**

Mack axles and carriers are engineered to handle the relentless punishment of heavy-duty construction applications.

### **Mack® Suspensions**

We've engineered Mack suspensions for reliability and outstanding performance, no matter where they go. Which, with a Mack truck, can be almost anywhere.

### **Pedigree Uptime Protection**

We work to deliver legendary Mack parts and services with our Pedigree Uptime Protection platform. Spend less time in the shop and more time on-site.

### **The integrated leader**

In 1914 we started this journey. A journey toward fully integrated trucking that's become a century of improving everything that makes your Mack a Mack.

**Powertrains that  
pack a punch.**

Drive an integrated powertrain from the company that invented it. Equipped with dominant Mack® engines and transmissions, you increase efficiency without sacrificing power.

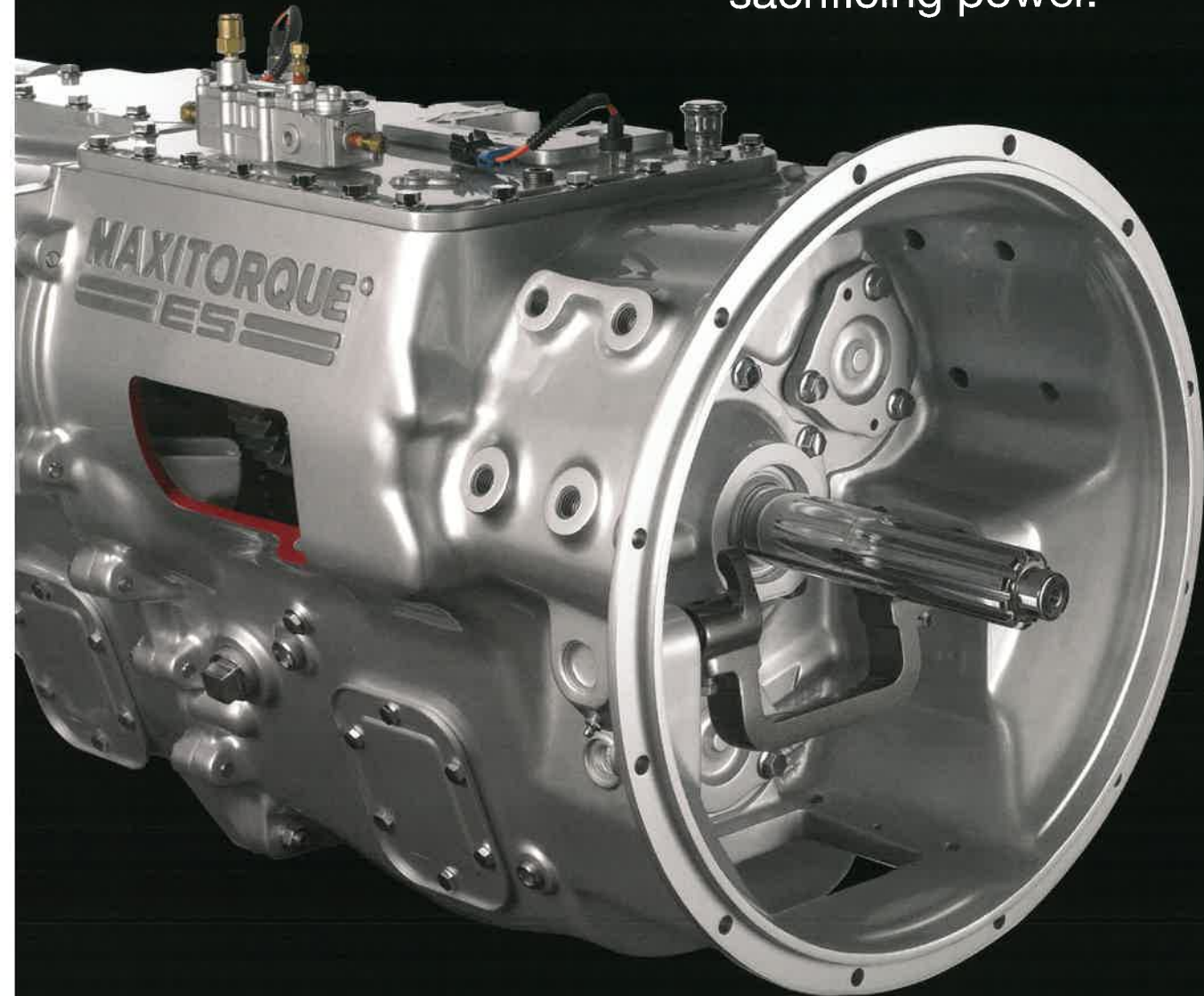

---

### **MACK® MAXITORQUE® TRANSMISSION**

The powerful Mack Maxitorque transmission is available in nine to 18 speeds. It features the industry's only triple-countershaft design and easy shifting for increased durability and smooth gear transitions. Maxitorque has seven PTO positions to help you master your application's demands.

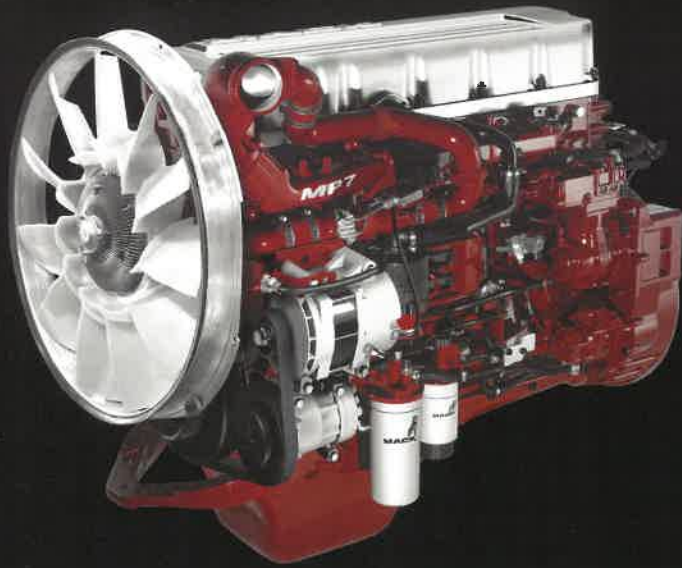

---

## MACK® MP7® ENGINE

The 11-liter MP7 engine is built for optimal fuel-efficiency. Available in Mack® Granite® and TerraPro® models, this lightweight engine has a HP range from 325 HP to 405 HP and torque ratings from 1,200–1,560 lb.-ft.

---

## MACK® MP8® ENGINE

The MP8 blends fuel economy, power and increased uptime. Offered on Granite and TerraPro models, its 13-liter engine has an optimal HP range from 415 HP to 505 HP with torque from 1,570–1,760 lb.-ft.

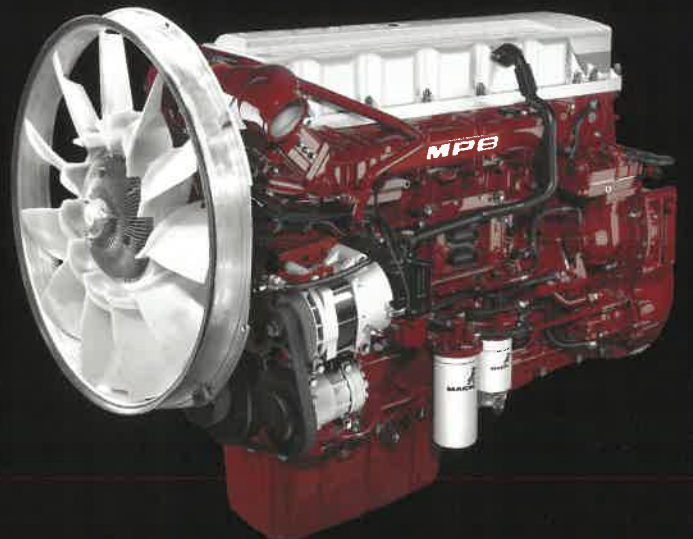

---

## MACK® MP10® ENGINE

Built exclusively for Titan, the MP10 is Mack's largest-ever engine. It forcibly delivers up to 605 HP and torque ratings of 2,060 lb.-ft. at 1,200 RPMs when you need the strength to move mountains.

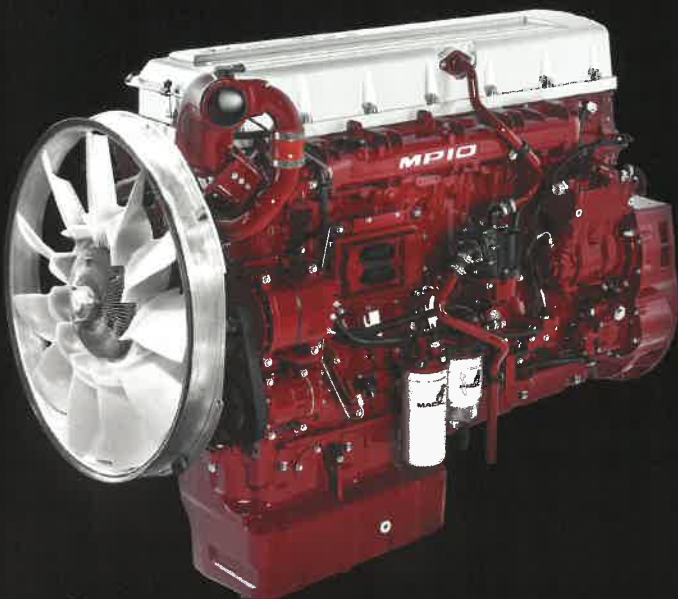



Axles and suspensions provide the foundation for Mack's reputation of rugged reliability. They offer increased durability for a smoother ride, because the only thing you should feel on the job is complete control.

**Rough work  
requires a  
smooth ride.**



---

### **MACK® AXLES**

Proprietary Mack Axles provide greater articulation on the most demanding construction sites. Our C150/151 top-mounted carriers deliver more efficient power to the wheels with less parasitic loss than with front-mounted carriers.

Mack® suspensions offer improved stability, smoother ride and greater return on investment than the competition. Through integrated design and engineering, Mack continues to raise the performance bar for construction trucks with its *mRIDE* and Camelback suspensions.

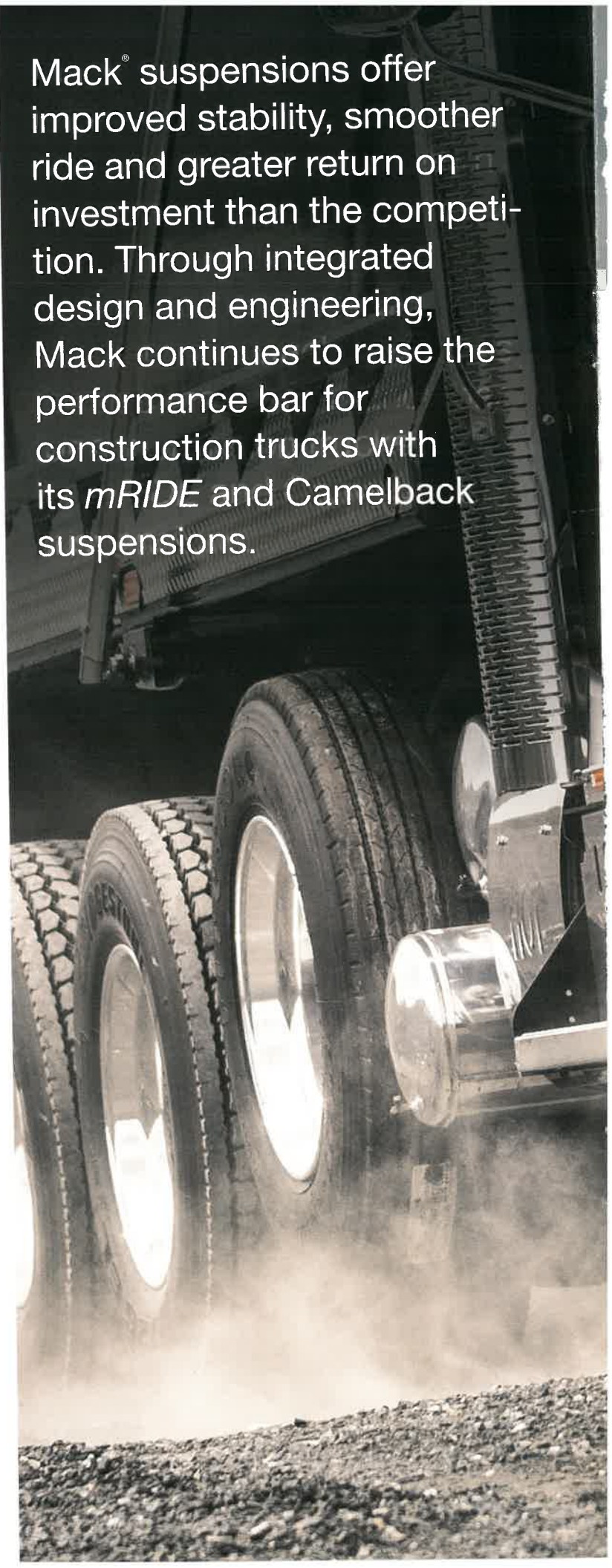

---

## MACK® CAMELBACK

The Camelback suspension is built with increased stability to handle the stress of off-road and severe duty trucking. This tried-and-true suspension allows for better steering and reduced tire wear. Camelback is available from 38,000- to 65,000-lb. ratings.



---

## MACK® mRIDE

With *mRIDE*, Mack delivers the next generation in spring suspensions to ease the workload for construction trucks. This suspension's extreme articulation and constant ground contact for all wheels maximizes traction and improves stability. Driver comfort takes front seat in this design, so your ride isn't as rough as your workload. Mack *mRIDE* is available in 40,000-, 46,000- and 52,000-lb. ratings.







# Take control of quality and keep your truck running strong with Pedigree Uptime Protection.

This integrated platform keeps your Mack operating at peak performance and benefits your bottom line. It's just another way Mack's got your back.

---

## **BULLDOG® PARTS PURCHASING**

We make it easy to keep your truck ready for the road with Mack Genuine Parts. All you need is the internet. You have full 24/7 access to pricing inquiry and over 500,000 vendor brand parts. And we don't offer just any parts and pricing. Our VIN-specific parts catalogue and price verification allow you to locate everything you need to make it a perfect fit.

---

## **BULLDOG® SERVICE MANAGEMENT**

We're dedicated to serving you and your truck. That's why, with the help of MACK ASIST, we provide a full-service communication and support center for fleets and owner-operators in the United States and Canada. This web-based tool partners with Mack OneCall® to increase uptime by offering multiple language breakdown support, arranging towing services and delivering real-time online case tracking.

---

## **BULLDOG® ASSET PROTECTION**

Stop truck maintenance problems before they start. Mack offers a variety of programs—including electronic CSA inspections—made to keep your engine, transmission and chassis working up to tough Mack standards.

---

## **BULLDOG® FINANCING**

Drive on your terms. No two businesses are alike, so Mack offers financing to meet your specific needs with specialized loans, leases and payment plans. From short-term rental agreements to operating and full-service leases, when you're in a Mack you're sure to be the envy of the jobsite.

---

## **MACK® GENUINE PARTS**

We've built our name around Mack Genuine Parts. They're engineered to provide dependability, peak performance and retain the purity of your truck. Mack's balanced design principles keep each part of your integrated system of components performing seamlessly together.





---

## COAST TO COAST SERVICE

Every truck is supported by more than 500 authorized dealers and parts and service locations coast to coast, and Mack's network of qualified service facilities includes more than 5,000 locations. When you need assistance, Mack's extended network is ready to deliver.

---

## GUARDDOG<sup>®</sup> CONNECT

GuardDog Connect is Mack's telematics-based system that unites your truck with a 24/7 network of support staff and repair centers. If something happens to your truck on the job, GuardDog Connect detects the problem instantly—usually before you know anything's wrong. This increases uptime, eliminates maintenance surprises, joins you to a live service network and provides you with peace of mind.

---

## ONECALL<sup>™</sup> COMPLETE CARE

OneCall picks up where GuardDog leaves off. If GuardDog sniffs out trouble, OneCall communicates the issue to dealers who offer round-the-clock jobsite assistance anywhere in the United States and Canada.

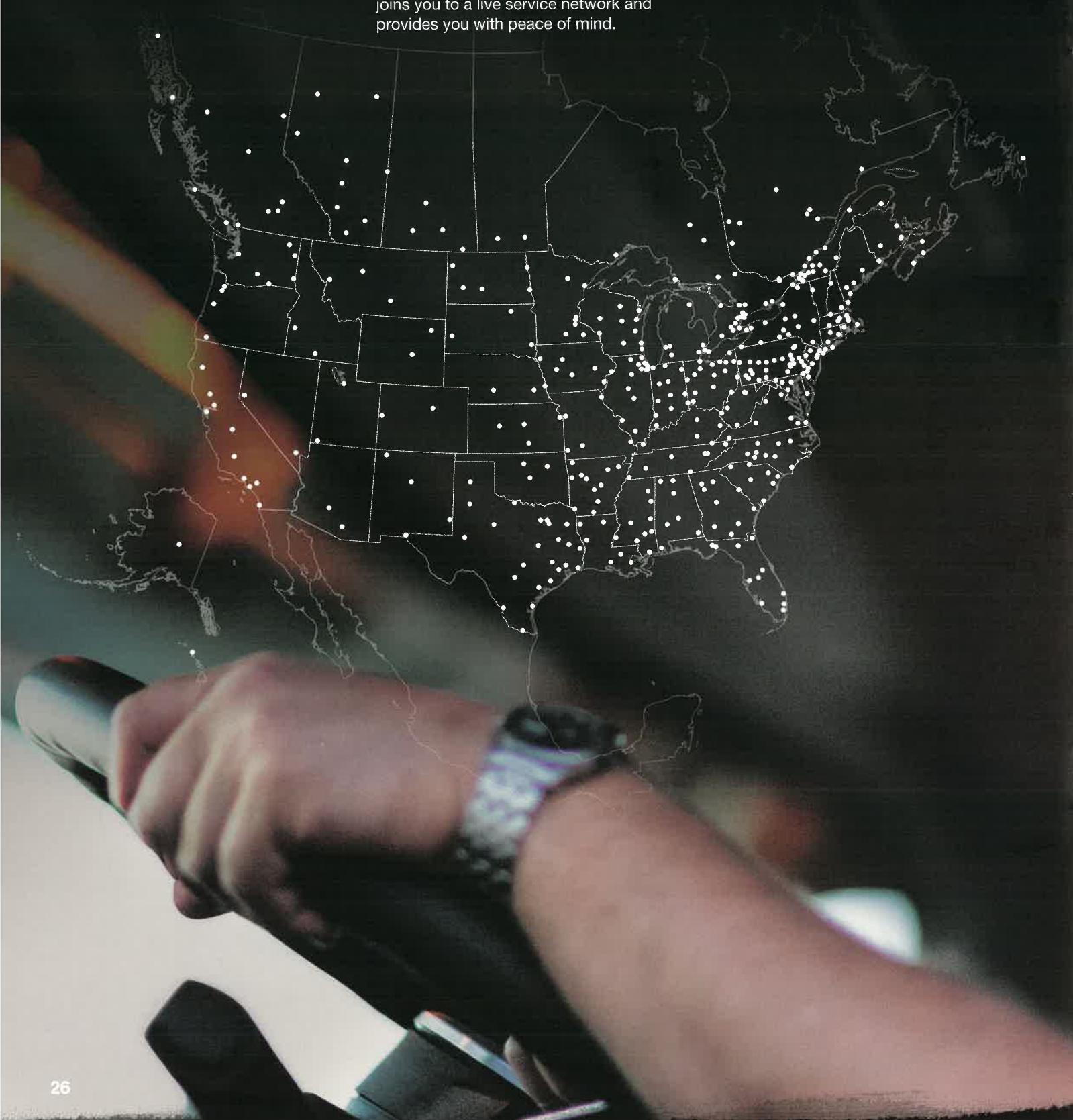

**Everything your Mack needs.  
Every place you need it.  
America's truck knows no boundaries.**

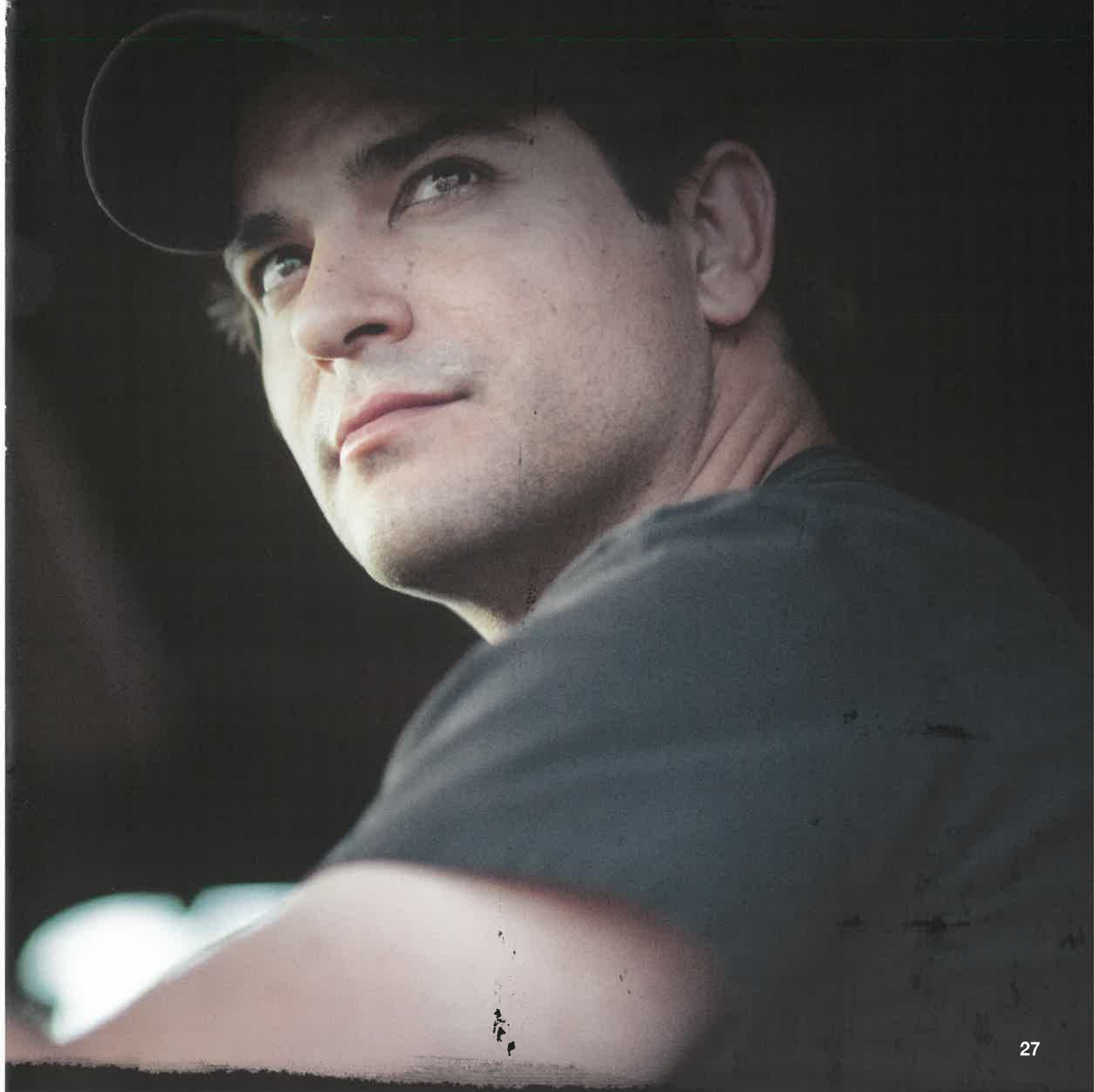

**MACK<sup>®</sup>  
TRUCKS  
ARE BUILT  
TO BUILD.**





**1-800-922-MACK**  
**MackTrucks.com**

©2014 Mack Trucks, Inc. All rights reserved. Mack, Mack and the Bulldog design, Bulldog and all other marks contained herein are registered trademarks of Mack Trucks, Inc. and/or Mack Trucks, Inc. affiliated companies. All other marks contained herein are the property of their respective owners.

BRO-CONSTR-0214-VSA-13M