



Purchasing Division  
 2019 Washington Street East  
 Post Office Box 50130  
 Charleston, WV 25305-0130

State of West Virginia  
 Request for Quotation  
 04 - Audio/Video

Proc Folder: 184004

Doc Description: ONE TIME PURCHASE AND COMPLETE INSTALLATION OF A CCTV SYSTEM

Proc Type: Central Purchase Order

Date Issued	Solicitation Closes	Solicitation No	Version
2016-07-15	2016-08-16 13:30:00	CRFQ 0506 WSH1700000001	1

BID CLERK  
 DEPARTMENT OF ADMINISTRATION  
 PURCHASING DIVISION  
 2019 WASHINGTON ST E  
 CHARLESTON WV 25305  
 US

Vendor Name, Address and Telephone Number:

Pomeroy IT Solutions  
 500 Westmoreland Office Park  
 Dunbar, WV 25064  
 (304) 746-4434

08/15/16 13:25:04  
 WV Purchasing Division

FOR INFORMATION CONTACT THE BUYER

April Battle  
 (304) 558-0067  
 april.e.battle@wv.gov

Signature X

FEIN #

61-1352158

DATE

08-16-16

All offers subject to all terms and conditions contained in this solicitation

The West Virginia Purchasing Division for the Agency, The West Virginia Department of Health and Human Resources, Bureau for Behavioral Health and Health Facilities is soliciting bids from qualified vendors to establish a "One-Time" contract for the purchase and installation of a closed circuit television system expansion for William R. Sharpe, Jr. Hospital and Transitional Living Facility per the Specifications, Terms & Conditions and bid requirements as attached.

PROCUREMENT OFFICER - 304-269-1210 HEALTH AND HUMAN RESOURCES WILLIAM R SHARPE JR HOSPITAL 936 SHARPE HOSPITAL RD WESTON WV26452 US	PROCUREMENT OFFICER - 304-269-1210 HEALTH AND HUMAN RESOURCES WILLIAM R SHARPE JR HOSPITAL 936 SHARPE HOSPITAL RD WESTON WV 26452 US
--	---

Line	Comm Ln Desc	Qty	Unit Issue	Unit Price	Total Price
1	Forty-Three (43) Indoor Internet Protocol (IP) Cameras	43.00000	EA	\$157.00	\$6,751.00

Comm Code	Manufacturer	Specification	Model #
46171610			DS-2CD2512F-i

**Extended Description :**

Section 4.1.1 - Forty-Three (43) Indoor IP Cameras - minimum of 1 megapixel 1280x720

PROCUREMENT OFFICER - 304-269-1210 HEALTH AND HUMAN RESOURCES WILLIAM R SHARPE JR HOSPITAL 936 SHARPE HOSPITAL RD WESTON WV26452 US	PROCUREMENT OFFICER - 304-269-1210 HEALTH AND HUMAN RESOURCES WILLIAM R SHARPE JR HOSPITAL 936 SHARPE HOSPITAL RD WESTON WV 26452 US
--	---

Line	Comm Ln Desc	Qty	Unit Issue	Unit Price	Total Price
2	Ten (10) Outdoor IP Cameras	10.00000	EA	\$157.00	\$1,570.00

Comm Code	Manufacturer	Specification	Model #
46171610			DS-2CD2132F-i

**Extended Description :**

Section 4.1.2 - Ten (10) Outdoor IP Cameras - minimum of 3 megapixels 1280x720

PROCUREMENT OFFICER - 304-269-1210 HEALTH AND HUMAN RESOURCES WILLIAM R SHARPE JR HOSPITAL 936 SHARPE HOSPITAL RD WESTON WV26452 US	PROCUREMENT OFFICER - 304-269-1210 HEALTH AND HUMAN RESOURCES WILLIAM R SHARPE JR HOSPITAL 936 SHARPE HOSPITAL RD WESTON WV 26452 US
--	---

Line	Comm Ln Desc	Qty	Unit Issue	Unit Price	Total Price
3	Two (2) Network Video Recorder(s) (NVRs)	2.00000	EA	\$3,637.00	\$7,274.00

Comm Code	Manufacturer	Specification	Model #
46171610			DSS-9664-ST-32T

**Extended Description :**

Section - 4.1.3 Two (2) Network Video Recorder - include viewing software and able to accommodate the 129 cameras

PROCUREMENT OFFICER - 304-269-1210 HEALTH AND HUMAN RESOURCES WILLIAM R SHARPE JR HOSPITAL 936 SHARPE HOSPITAL RD WESTON WV26452 US	PROCUREMENT OFFICER - 304-269-1210 HEALTH AND HUMAN RESOURCES WILLIAM R SHARPE JR HOSPITAL 936 SHARPE HOSPITAL RD WESTON WV 26452 US
--	---

Line	Comm Ln Desc	Qty	Unit Issue	Unit Price	Total Price
4	Five (5) Network Switches	5.00000	EA	\$494.00	\$2,470.00

Comm Code	Manufacturer	Specification	Model #
46171610			DGS-1210-28P

**Extended Description :**

Section 4.1.4 - Five (5) Network Switches - 24 port switch with Power over Ethernet, 1 gigabit (10/100/1000)

PROCUREMENT OFFICER - 304-269-1210 HEALTH AND HUMAN RESOURCES WILLIAM R SHARPE JR HOSPITAL 936 SHARPE HOSPITAL RD WESTON WV26452 US	PROCUREMENT OFFICER - 304-269-1210 HEALTH AND HUMAN RESOURCES WILLIAM R SHARPE JR HOSPITAL 936 SHARPE HOSPITAL RD WESTON WV 26452 US
--	---

Line	Comm Ln Desc	Qty	Unit Issue	Unit Price	Total Price
5	Networking	1.00000	EA	\$750.00	\$750.00

Comm Code	Manufacturer	Specification	Model #
46171610			

**Extended Description :**

Section 4.1.5 - Miscellaneous installation materials and accessories needed to install, commission, and operate equipment

PROCUREMENT OFFICER - 304-269-1210 HEALTH AND HUMAN RESOURCES WILLIAM R SHARPE JR HOSPITAL 936 SHARPE HOSPITAL RD WESTON WV26452 US	PROCUREMENT OFFICER - 304-269-1210 HEALTH AND HUMAN RESOURCES WILLIAM R SHARPE JR HOSPITAL 936 SHARPE HOSPITAL RD WESTON WV 26452 US
--	---

Line	Comm Ln Desc	Qty	Unit Issue	Unit Price	Total Price
6	Labor	1.00000	EA	23,983.52	23,983.52

Comm Code	Manufacturer	Specification	Model #
46171610			

**Extended Description :**

Section 4.1.6 - Labor - Installation and labor to install and program CCTV system. Set up workstations and system to operate and function correctly

PROCUREMENT OFFICER - 304-269-1210 HEALTH AND HUMAN RESOURCES WILLIAM R SHARPE JR HOSPITAL 936 SHARPE HOSPITAL RD WESTON WV26452 US	PROCUREMENT OFFICER - 304-269-1210 HEALTH AND HUMAN RESOURCES WILLIAM R SHARPE JR HOSPITAL 936 SHARPE HOSPITAL RD WESTON WV 26452 US
--	---

Line	Comm Ln Desc	Qty	Unit Issue	Unit Price	Total Price
7	One (1) year materials and labor warranty	1.00000	EA	∅	∅

Comm Code	Manufacturer	Specification	Model #
46171610			

**Extended Description :**

Section 4.1.7 - One (1) year materials and labor warranty

Line	Event	Event Date
1	Question Deadline 3:00 p.m.	2016-07-29

WSH1700000001	<b>Document Phase</b> Final	<b>Document Description</b> ONE TIME PURCHASE AND COMPLETE INSTALLATION OF A CCTV SYSTEM	<b>Page 5</b> <b>of 5</b>
---------------	--------------------------------	--	------------------------------

**ADDITIONAL TERMS AND CONDITIONS**

See attached document(s) for additional Terms and Conditions

Total: \$ 42,798.52

**DESIGNATED CONTACT:** Vendor appoints the individual identified in this Section as the Contract Administrator and the initial point of contact for matters relating to this Contract.

James Stewart - Technology Solutions Executive  
(Name, Title)  
James Stewart - Technology Solutions Executive  
(Printed Name and Title)  
500 Westmoreland Office Park, Dunbar, WV 25064  
(Address)  
(304) 746-4434 / (800) 650-1703  
(Phone Number) / (Fax Number)  
james.stewart@pomeroy.com  
(email address)

**CERTIFICATION AND SIGNATURE:** By signing below, or submitting documentation through wvOASIS, I certify that I have reviewed this Solicitation in its entirety; that I understand the requirements, terms and conditions, and other information contained herein; that this bid, offer or proposal constitutes an offer to the State that cannot be unilaterally withdrawn; that the product or service proposed meets the mandatory requirements contained in the Solicitation for that product or service, unless otherwise stated herein; that the Vendor accepts the terms and conditions contained in the Solicitation, unless otherwise stated herein; that I am submitting this bid, offer or proposal for review and consideration; that I am authorized by the vendor to execute and submit this bid, offer, or proposal, or any documents related thereto on vendor's behalf; that I am authorized to bind the vendor in a contractual relationship; and that to the best of my knowledge, the vendor has properly registered with any State agency that may require registration.

Pomeroy IT Solutions  
(Company)  
James Stewart - Technology Solutions Executive  
(Authorized Signature) (Representative Name, Title)  
James Stewart - Technology Solutions Executive  
(Printed Name and Title of Authorized Representative)  
08-16-16  
(Date)  
(304) 746-4434 / (800) 650-1703  
(Phone Number) (Fax Number)

ADDENDUM ACKNOWLEDGEMENT FORM  
SOLICITATION NO.:

Instructions: Please acknowledge receipt of all addenda issued with this solicitation by completing this addendum acknowledgment form. Check the box next to each addendum received and sign below. Failure to acknowledge addenda may result in bid disqualification.

Acknowledgment: I hereby acknowledge receipt of the following addenda and have made the necessary revisions to my proposal, plans and/or specification, etc.

Addendum Numbers Received:

(Check the box next to each addendum received)

- |   |  |
|---|--|
| <input type="checkbox"/> Addendum No. 1 | <input type="checkbox"/> Addendum No. 6  |
| <input type="checkbox"/> Addendum No. 2 | <input type="checkbox"/> Addendum No. 7  |
| <input type="checkbox"/> Addendum No. 3 | <input type="checkbox"/> Addendum No. 8  |
| <input type="checkbox"/> Addendum No. 4 | <input type="checkbox"/> Addendum No. 9  |
| <input type="checkbox"/> Addendum No. 5 | <input type="checkbox"/> Addendum No. 10 |

I understand that failure to confirm the receipt of addenda may be cause for rejection of this bid. I further understand that any verbal representation made or assumed to be made during any oral discussion held between Vendor's representatives and any state personnel is not binding. Only the information issued in writing and added to the specifications by an official addendum is binding.

Pomeroy IT Solutions  
Company

James Stewart  
Authorized Signature

08-16-16  
Date

NOTE: This addendum acknowledgement should be submitted with the bid to expedite document processing.

\* No addendum issued.

JS-08.16.16

REQUEST FOR QUOTATION  
Closed Circuit Television System Expansion

---

10.1.4. Failure to remedy deficient performance upon request.

10.2. The following remedies shall be available to Agency upon default.

10.2.1. Cancellation of the Contract.

10.2.2. Cancellation of one or more release orders issued under this Contract.

10.2.3. Any other remedies available in law or equity.

**11. MISCELLANEOUS:**

**11.1. Contract Manager:** During its performance of this Contract, Vendor must designate and maintain a primary contract manager responsible for overseeing Vendor's responsibilities under this Contract. The Contract manager must be available during normal business hours to address any customer service or other issues related to this Contract. Vendor should list its Contract manager and his or her contact information below.

Contract Manager: James Stewart  
Telephone Number: (304) 746-4434  
Fax Number: (505) 650-1703  
Email Address: james.stewart@pomeroy.com



Exhibit A - Pricing Page - CRFQ WSH1700000001

Item Number	Quantity	Description	Unit Cost	Extended Cost
4.1.1	43	Indoor IP Cameras - minimum of 1 megapixel 1280x720	\$157.00	\$6,751.00
4.1.2	10	Outdoor IP Cameras - minimum of 3 megapixels 1280x720	\$157.00	\$1,570.00
4.1.3	2	Network Video Recorder - include viewing software and able to accommodate the 129 cameras	\$3,637.00	\$7,274.00
4.1.4	5	Network Switches - 24 port switch with Power over Ethernet, 1 gigabit (10/100/1000)	\$494.00	\$2,470.00
4.1.5	1	Miscellaneous installation materials and accessories needed to install, commission, and operate equipment	\$750.00	\$750.00
4.1.6	1	Labor - Installation and labor to install and program CCTV system. Set up workstations and system to operate and function correctly	\$23,983.52	\$23,983.52
4.1.7	1	One year warranty on all material and labor	Ø	Ø
<b>TOTAL COST</b>				\$42,798.52

Vendor Name: Pomeroy IT Solutions

Vendor Address: 500 Westmoreland Office Park  
Dunbar, WV 25064

Vendor Phone/Fax Numbers: (304) 746-4434 / (800) 650-1703

Vendor Email: james.stewart@pomeroy.com

Vendor Authorized Representative: James Stewart  
(Please Print)

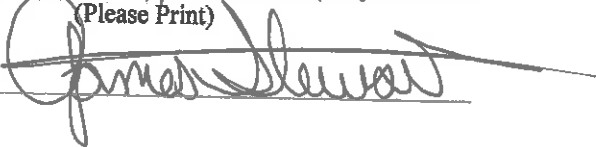
Vendor Authorized Representative Signature: 



State of West Virginia  
DRUG FREE WORKPLACE CONFORMANCE AFFIDAVIT  
West Virginia Code §21-1D-5

STATE OF WEST VIRGINIA,

COUNTY OF \_\_\_\_\_, TO-WIT:

I, Becky Houston, after being first duly sworn, depose and state as follows:

1. I am an employee of Pomeroy; and,  
(Company Name)
2. I do hereby attest that Pomeroy  
(Company Name)

maintains a written plan for a drug-free workplace policy and that such plan and policy are in compliance with **West Virginia Code §21-1D**.

The above statements are sworn to under the penalty of perjury.

Printed Name: Becky Houston  
 Signature: Becky Houston  
 Title: Employee Relations Manager  
 Company Name: Pomeroy  
 Date: 8/11/16

Taken, subscribed and sworn to before me this 12<sup>th</sup> day of August, 2016  
 By Commission expires 11/27/16

(Seal) HEATHER R. SCRIST  
 Notary Public-State at Large  
 KENTUCKY - Notary ID # 479063  
 My Commission Expires November 27, 2016

Heather R. Scrist  
 (Notary Public)

**THIS AFFIDAVIT MUST BE SUBMITTED WITH THE BID IN ORDER TO COMPLY WITH WV CODE PROVISIONS. FAILURE TO INCLUDE THE AFFIDAVIT WITH THE BID SHALL RESULT IN DISQUALIFICATION OF THE BID.**

<u>Name</u>	<u>Initiated</u>	<u>Completed/Results</u>
Harold Callihan <a href="mailto:Harold.Callihan@pomeroy.com">Harold.Callihan@pomeroy.com</a>	X	Clear
Russel Hall II <a href="mailto:Russel.HallII@pomeroy.com">Russel.HallII@pomeroy.com</a>	X	Clear
Joshua Budd <a href="mailto:Joshua.Budd@pomeroy.com">Joshua.Budd@pomeroy.com</a>	X	Clear
Luke Evans <a href="mailto:Luke.Evans@pomeroy.com">Luke.Evans@pomeroy.com</a>	X	Clear
Russ Lavender <a href="mailto:Rusty.Lavender@pomeroy.com">Rusty.Lavender@pomeroy.com</a>	X	Clear
Scott Hougland <a href="mailto:Scott.Hougland@pomeroy.com">Scott.Hougland@pomeroy.com</a>	X	Clear
Todd Bailey <a href="mailto:Todd.Bailey@pomeroy.com">Todd.Bailey@pomeroy.com</a>	X	Clear
TRACE Marion <a href="mailto:Phillip.Marion@pomeroy.com">Phillip.Marion@pomeroy.com</a>	X	Clear
Charles Guy <a href="mailto:Charles.Guy@pomeroy.com">Charles.Guy@pomeroy.com</a>	X	Clear
Earl Carey <a href="mailto:Earl.Carey@pomeroy.com">Earl.Carey@pomeroy.com</a>	X	Clear
Jason Songer <a href="mailto:Jason.Songer@pomeroy.com">Jason.Songer@pomeroy.com</a>	X	Clear
Timothy Silman <a href="mailto:Timothy.Silman@pomeroy.com">Timothy.Silman@pomeroy.com</a>	X	Clear
Alex Volpenhein <a href="mailto:Alexander.Volpenhein@pomeroy.com">Alexander.Volpenhein@pomeroy.com</a>	X	Clear
Chip Terry <a href="mailto:Gary.Terry@pomeroy.com">Gary.Terry@pomeroy.com</a>	X	Clear
Billy Singer <a href="mailto:Billy.Singer@pomeroy.com">Billy.Singer@pomeroy.com</a>	X	Clear
Justin Matney <a href="mailto:Justin.Matney@pomeroy.com">Justin.Matney@pomeroy.com</a>	X	Clear
Marvin Carey <a href="mailto:earl.carey2@pomeroy.com">earl.carey2@pomeroy.com</a>	X	Clear
Andrew Patrick <a href="mailto:Andrew.Patrick@pomeroy.com">Andrew.Patrick@pomeroy.com</a>	X	Clear
Dale Liles <a href="mailto:Dale.Liles@pomeroy.com">Dale.Liles@pomeroy.com</a>	X	Clear
Jac Jensen <a href="mailto:Jac.Jensen@pomeroy.com">Jac.Jensen@pomeroy.com</a>	X	Clear
Jonathan Lacy <a href="mailto:Jonathon.Lacy@pomeroy.com">Jonathon.Lacy@pomeroy.com</a>	X	Clear
James Dickess <a href="mailto:James.Dickess@pomeroy.com">James.Dickess@pomeroy.com</a>	X	Clear
Larry Arthur <a href="mailto:Larry.Arthur@pomeroy.com">Larry.Arthur@pomeroy.com</a>	X	Clear
Gabriel Richmond <a href="mailto:Gabriel.Richmond@pomeroy.com">Gabriel.Richmond@pomeroy.com</a>	X	Clear
Ryan Lacy <a href="mailto:Joseph.Lacy@pomeroy.com">Joseph.Lacy@pomeroy.com</a>	X	Clear

Concentra Medical Centers

Average Construction Employees : 25

<b>Alcohol and Drug-Free Workplace</b>			
<b>CORPORATE POLICY</b>	<b>Origination Date:</b> 2006	<b>Revision Date:</b> July 2011	<b>Effective Date:</b> April 2011

### **Purpose**

The purpose of this policy is to maintain safe, healthy, and efficient working conditions for its employees and for protecting the safety and security of the Company's products, property, and facilities.

### **Scope**

This policy outlines the safety threats and consequences of substance abuse.

### **Policy**

Being under the influence of any drug or alcohol on the job may pose a serious safety and health risk not only to the user, but to all those who work with the user. The possession, use, or sale of an illegal drug or alcohol in the workplace also poses unacceptable risks for safe and efficient operations. Controlled substances include, but are not limited to, the following: Narcotics (heroin, morphine, etc.); Cannabis (marijuana, hashish); Stimulants (cocaine, amphetamines, etc.); Depressants (tranquilizers); and Hallucinogens (PCP, LSD, etc.).

With these basic objectives in mind Pomeroy has established the following policy with regard to the use, possession, and/or sale of alcohol or drugs.

#### **On-the-Job Use, Possession or Sales of Alcohol or Drugs**

**Alcohol:** Being under the influence of alcohol while performing Company business or while in a Company facility is prohibited. Consumption on Company property is prohibited except as permitted by management.

**Legal Drugs** (those prescribed by a licensed medical provider for the user or over the counter medications): For certain job positions, an employee's use of a legal drug can pose a significant risk to the safety of the employee or others. Employees who feel or have been informed that the use of such a drug may present a safety risk are to report such drug use to Human Resources by calling (800) 846-8727. A determination shall be made with regard to job-related consequences. Supervisors who are aware of such a situation are to instruct the employee to report to the Human Resources Department.

**Illegal Drugs** (those not prescribed for the user or obtained over the counter): The use, sale, purchase, transfer, possession, or being under the influence of an illegal drug by an employee while in a Company facility or while performing Company business is prohibited.

State of West Virginia  
Purchasing Division

---

## CERTIFIED DRUG-FREE WORKPLACE REPORT COVERSHEET

---

In accordance with *West Virginia Code* § 21-1D-7b, no less than once per year, or upon completion of the project, every contractor shall provide a certified report to the public authority which let the contract. That report must include each of the items identified below in the Required Report Content section.

**Instructions:** Vendor should complete this coversheet, attach it to the required report, and submit it to the appropriate location as follows: For contracts more than \$25,000, the report should be mailed to the West Virginia Purchasing Division at 2019 Washington Street East, Charleston, WV 25305. For contracts of \$25,000 or less, the vendor should mail the report to the public authority issuing the contract.

**Contract Identification:**

Contract Number: WSH1700000001  
Contract Purpose: Purchase and install of CCTV system  
Agency Requesting Work: WVDHHR - William R. Sharpe Jr Hospital

**Required Report Content:** The attached report must include each of the items listed below. The vendor should check each box as an indication that the required information has been included in the attached report.

- Information indicating the education and training service to the requirements of *West Virginia Code* § 21-1D-5 was provided;
- Name of the laboratory certified by the United States Department of Health and Human Services or its successor that performs the drug tests; Concentra Medical Centers
- Average number of employees in connection with the construction on the public improvement; 25
- Drug test results for the following categories including the number of positive tests and the number of negative tests: (A) Pre-employment and new hires; (B) Reasonable suspicion; (C) Post-accident; and (D) Random.

**Vendor Contact Information:**

Vendor Name: Pomeroy  
Vendor Address: 1020 Petersburg Road  
Hebron, Kentucky 41048  
Vendor Telephone: 859-657-2100  
Vendor Fax: 1-800-443-2703  
Vendor E-Mail: Becky.Houston@Pomeroy



# CERTIFICATE OF LIABILITY INSURANCE

DATE (MM/DD/YYYY)  
8/9/2016

THIS CERTIFICATE IS ISSUED AS A MATTER OF INFORMATION ONLY AND CONFERS NO RIGHTS UPON THE CERTIFICATE HOLDER. THIS CERTIFICATE DOES NOT AFFIRMATIVELY OR NEGATIVELY AMEND, EXTEND OR ALTER THE COVERAGE AFFORDED BY THE POLICIES BELOW. THIS CERTIFICATE OF INSURANCE DOES NOT CONSTITUTE A CONTRACT BETWEEN THE ISSUING INSURER(S), AUTHORIZED REPRESENTATIVE OR PRODUCER, AND THE CERTIFICATE HOLDER.

**IMPORTANT:** If the certificate holder is an ADDITIONAL INSURED, the policy(ies) must be endorsed. If SUBROGATION IS WAIVED, subject to the terms and conditions of the policy, certain policies may require an endorsement. A statement on this certificate does not confer rights to the certificate holder in lieu of such endorsement(s).

<b>PRODUCER</b> The Hauser Group 6280 Northcreek Drive, Suite 200 Cincinnati OH 45236	<b>CONTACT NAME:</b> Michelle Davis <b>PHONE (A/C, No. Ext.):</b> 513-745-8200 <b>E-MAIL ADDRESS:</b> mdavis@thehausergroup.com		<b>FAX (A/C, No.):</b> 513-745-8219
	<b>INSURER(S) AFFORDING COVERAGE</b>		
<b>INSURED</b> POMER-1 Pomeroy IT Solutions Sales Company, Inc. 1020 Petersburg Road Hebron KY 41048	<b>INSURER A:</b> Great Northern Insurance Co.		<b>NAIC #</b> 20303
	<b>INSURER B:</b> Federal Insurance Company		20281
	<b>INSURER C:</b> Columbia Casualty Company		31127
	<b>INSURER D:</b> Valley Forge Insurance Co.		20508
	<b>INSURER E:</b> Continental Insurance Co.		35289
	<b>INSURER F:</b>		

**COVERAGES** **CERTIFICATE NUMBER: 785351296** **REVISION NUMBER:**

THIS IS TO CERTIFY THAT THE POLICIES OF INSURANCE LISTED BELOW HAVE BEEN ISSUED TO THE INSURED NAMED ABOVE FOR THE POLICY PERIOD INDICATED. NOTWITHSTANDING ANY REQUIREMENT, TERM OR CONDITION OF ANY CONTRACT OR OTHER DOCUMENT WITH RESPECT TO WHICH THIS CERTIFICATE MAY BE ISSUED OR MAY PERTAIN, THE INSURANCE AFFORDED BY THE POLICIES DESCRIBED HEREIN IS SUBJECT TO ALL THE TERMS, EXCLUSIONS AND CONDITIONS OF SUCH POLICIES. LIMITS SHOWN MAY HAVE BEEN REDUCED BY PAID CLAIMS.

INER LTR	TYPE OF INSURANCE	ADDL. INSD	SUBR. WVD	POLICY NUMBER	POLICY EFF (MM/DD/YYYY)	POLICY EXP (MM/DD/YYYY)	LIMITS
A	<input checked="" type="checkbox"/> COMMERCIAL GENERAL LIABILITY <input type="checkbox"/> CLAIMS-MADE <input checked="" type="checkbox"/> OCCUR  GEN'L AGGREGATE LIMIT APPLIES PER: <input type="checkbox"/> POLICY <input checked="" type="checkbox"/> PRO.JECT <input type="checkbox"/> LOC OTHER:			36033892	1/18/2016	1/31/2017	EACH OCCURRENCE \$1,000,000 DAMAGE TO RENTED PREMISES (Ea occurrence) \$1,000,000 MED EXP (Any one person) \$10,000 PERSONAL & ADV INJURY \$1,000,000 GENERAL AGGREGATE \$2,000,000 PRODUCTS - COMP/OP AGG \$2,000,000 Employee Benefits \$1,000,000
A	<input checked="" type="checkbox"/> AUTOMOBILE LIABILITY <input checked="" type="checkbox"/> ANY AUTO <input type="checkbox"/> ALL OWNED AUTOS <input type="checkbox"/> SCHEDULED AUTOS <input checked="" type="checkbox"/> HIRED AUTOS <input checked="" type="checkbox"/> NON-OWNED AUTOS			73591878	1/18/2016	1/31/2017	COMBINED SINGLE LIMIT (Ea accident) \$1,000,000 BODILY INJURY (Per person) \$ BODILY INJURY (Per accident) \$ PROPERTY DAMAGE (Per accident) \$ \$
B	<input checked="" type="checkbox"/> UMBRELLA LIAB <input checked="" type="checkbox"/> OCCUR <input type="checkbox"/> EXCESS LIAB <input type="checkbox"/> CLAIMS-MADE DED RETENTION \$			78894106	1/18/2016	1/31/2017	EACH OCCURRENCE \$25,000,000 AGGREGATE \$25,000,000 \$
D E D	WORKERS COMPENSATION AND EMPLOYERS' LIABILITY ANY PROPRIETOR/PARTNER/EXECUTIVE OFFICER/MEMBER EXCLUDED? (Mandatory in NH) If yes, describe under DESCRIPTION OF OPERATIONS below		Y/N	5098732385 8023681819 8023681838	1/18/2016 1/18/2016 1/18/2016	1/31/2017 1/31/2017 1/31/2017	<input checked="" type="checkbox"/> PER STATUTE <input type="checkbox"/> OTHER E.L. EACH ACCIDENT \$1,000,000 E.L. DISEASE - EA EMPLOYEE \$1,000,000 E.L. DISEASE - POLICY LIMIT \$1,000,000
C	Technology E&O			596650123	1/18/2016	1/31/2017	Limit \$10,000,000 Retention \$250,000

DESCRIPTION OF OPERATIONS / LOCATIONS / VEHICLES (ACORD 101, Additional Remarks Schedule, may be attached if more space is required)

## CERTIFICATE HOLDER

## CANCELLATION

For Information Purposes Only

SHOULD ANY OF THE ABOVE DESCRIBED POLICIES BE CANCELLED BEFORE THE EXPIRATION DATE THEREOF, NOTICE WILL BE DELIVERED IN ACCORDANCE WITH THE POLICY PROVISIONS.

AUTHORIZED REPRESENTATIVE

*J. M. Worrall*

Fill in

Agency WV DHHR  
REQ.P.# WSH170000001

**BID BOND**

KNOW ALL MEN BY THESE PRESENTS, That we, the undersigned, Pomeroy IT Solutions Sales Co., Inc.  
of Hebron Kentucky as Principal, and Fidelity & Deposit Company of Maryland  
of Schaumburg Illinois, a corporation organized and existing under the laws of the State of Maryland  
with its principal office in the City of Schaumburg, as Surety, are held and firmly bound unto the State  
of West Virginia, as Obligees, in the penal sum of Five Percent of Bid (\$ 5% of bid) for the payment of which,  
well and truly to be made, we jointly and severally bind ourselves, our heirs, administrators, executors, successors and assigns.

The Condition of the above obligation is such that whereas the Principal has submitted to the Purchasing Section of the  
Department of Administration a certain bid or proposal, attached hereto and made a part hereof, to enter into a contract in writing for  
Contract for the purchase and installation of a closed circuit Television System  
for William R. Sharpe, Jr. Hospital and Transitional Living Facility

**NOW THEREFORE,**

- (a) If said bid shall be rejected, or
- (b) If said bid shall be accepted and the Principal shall enter into a contract in accordance with the bid or proposal attached hereto and shall furnish any other bonds and insurance required by the bid or proposal, and shall in all other respects perform the agreement created by the acceptance of said bid, then this obligation shall be null and void, otherwise this obligation shall remain in full force and effect. It is expressly understood and agreed that the liability of the Surety for any and all claims hereunder shall, in no event, exceed the penal amount of this obligation as herein stated.

The Surety, for the value received, hereby stipulates and agrees that the obligations of said Surety and its bond shall be in no way impaired or affected by any extension of the time within which the Obligees may accept such bid, and said Surety does hereby waive notice of any such extension.

WITNESS, the following signatures and seals of Principal and Surety, executed and sealed by a proper officer of Principal and Surety, or by Principal individually if Principal is an individual, this 10th day of August, 20 16

Principal Seal

[Signature]  
(Name of Principal)

By [Signature]  
(Must be President, Vice President, or  
Duty Authorized Agent)

General Counsel  
(Title) CAO

Surety Seal

Fidelity & Deposit Company of Maryland  
(Name of Surety)

[Signature]  
Joseph M. Worrall  
Attorney-in-Fact

**IMPORTANT** - Surety executing bonds must be licensed in West Virginia to transact surety insurance, must affix its seal, and must attach a power of attorney with its seal affixed.

**ZURICH AMERICAN INSURANCE COMPANY  
COLONIAL AMERICAN CASUALTY AND SURETY COMPANY  
FIDELITY AND DEPOSIT COMPANY OF MARYLAND  
POWER OF ATTORNEY**

KNOW ALL MEN BY THESE PRESENTS: That the ZURICH AMERICAN INSURANCE COMPANY, a corporation of the State of New York, the COLONIAL AMERICAN CASUALTY AND SURETY COMPANY, a corporation of the State of Maryland, and the FIDELITY AND DEPOSIT COMPANY OF MARYLAND a corporation of the State of Maryland (herein collectively called the "Companies"), by THOMAS O. MCCLELLAN, Vice President, in pursuance of authority granted by Article V, Section 8, of the By-Laws of said Companies, which are set forth on the reverse side hereof and are hereby certified to be in full force and effect on the date hereof, do hereby nominate, constitute, and appoint Jennifer GERHARDT, Candice J. VOGEL, William E. CARLIN, Joseph WOKRALL, Debra K. POLLINO and Julie E. CHRISMAN, all of Cincinnati, Ohio, EACH its true and lawful agent and Attorney-in-Fact, to make, execute, seal and deliver, for, and on its behalf as surety, and as its act and deed: any and all bonds and undertakings, and the execution of such bonds or undertakings in pursuance of these presents, shall be as binding upon said Companies, as fully and amply, to all intents and purposes, as if they had been duly executed and acknowledged by the regularly elected officers of the ZURICH AMERICAN INSURANCE COMPANY at its office in New York, New York, the regularly elected officers of the COLONIAL AMERICAN CASUALTY AND SURETY COMPANY at its office in Owings Mills, Maryland, and the regularly elected officers of the FIDELITY AND DEPOSIT COMPANY OF MARYLAND at its office in Owings Mills, Maryland, in their own proper persons.

The said Vice President does hereby certify that the extract set forth on the reverse side hereof is a true copy of Article V, Section 8, of the By-Laws of said Companies, and is now in force.

IN WITNESS WHEREOF, the said Vice-President has hereunto subscribed his/her names and affixed the Corporate Seals of the said ZURICH AMERICAN INSURANCE COMPANY, COLONIAL AMERICAN CASUALTY AND SURETY COMPANY, and FIDELITY AND DEPOSIT COMPANY OF MARYLAND, this 27th day of March, A.D. 2015.

ATTEST:

**ZURICH AMERICAN INSURANCE COMPANY  
COLONIAL AMERICAN CASUALTY AND SURETY COMPANY  
FIDELITY AND DEPOSIT COMPANY OF MARYLAND**



By: Eric D. Barnes  
Secretary  
Eric D. Barnes

Thomas O. McClellan  
Vice President  
Thomas O. McClellan

State of Maryland  
County of Baltimore

On this 27th day of March, A.D. 2015, before the subscriber, a Notary Public of the State of Maryland, duly commissioned and qualified, THOMAS O. MCCLELLAN, Vice President, and ERIC D. BARNES, Secretary, of the Companies, to me personally known to be the individuals and officers described in and who executed the preceding instrument, and acknowledged the execution of same, and being by me duly sworn, deposed and saith, that he/she is the said officer of the Company aforesaid, and that the seals affixed to the preceding instrument are the Corporate Seals of said Companies, and that the said Corporate Seals and the signature as such officer were duly affixed and subscribed to the said instrument by the authority and direction of the said Corporations.

IN TESTIMONY WHEREOF, I have hereunto set my hand and affixed my Official Seal the day and year first above written.

Maria D. Adamski



Maria D. Adamski, Notary Public  
My Commission Expires: July 8, 2015



**EXTRACT FROM BY-LAWS OF THE COMPANIES**

"Article V, Section 8, Attorneys-in-Fact. The Chief Executive Officer, the President, or any Executive Vice President or Vice President may, by written instrument under the attested corporate seal, appoint attorneys-in-fact with authority to execute bonds, policies, recognizances, stipulations, undertakings, or other like instruments on behalf of the Company, and may authorize any officer or any such attorney-in-fact to affix the corporate seal thereto; and may with or without cause modify or revoke any such appointment or authority at any time."

**CERTIFICATE**

I, the undersigned, Vice President of the ZURICH AMERICAN INSURANCE COMPANY, the COLONIAL AMERICAN CASUALTY AND SURETY COMPANY, and the FIDELITY AND DEPOSIT COMPANY OF MARYLAND, do hereby certify that the foregoing Power of Attorney is still in full force and effect on the date of this certificate; and I do further certify that Article V, Section 8, of the By-Laws of the Companies is still in force.

This Power of Attorney and Certificate may be signed by facsimile under and by authority of the following resolution of the Board of Directors of the ZURICH AMERICAN INSURANCE COMPANY at a meeting duly called and held on the 15th day of December 1998.

RESOLVED: "That the signature of the President or a Vice President and the attesting signature of a Secretary or an Assistant Secretary and the Seal of the Company may be affixed by facsimile on any Power of Attorney...Any such Power or any certificate thereof bearing such facsimile signature and seal shall be valid and binding on the Company."

This Power of Attorney and Certificate may be signed by facsimile under and by authority of the following resolution of the Board of Directors of the COLONIAL AMERICAN CASUALTY AND SURETY COMPANY at a meeting duly called and held on the 5th day of May, 1994, and the following resolution of the Board of Directors of the FIDELITY AND DEPOSIT COMPANY OF MARYLAND at a meeting duly called and held on the 10th day of May, 1990.

RESOLVED: "That the facsimile or mechanically reproduced seal of the company and facsimile or mechanically reproduced signature of any Vice-President, Secretary, or Assistant Secretary of the Company, whether made heretofore or hereafter, wherever appearing upon a certified copy of any power of attorney issued by the Company, shall be valid and binding upon the Company with the same force and effect as though manually affixed.

IN TESTIMONY WHEREOF, I have hereunto subscribed my name and affixed the corporate seals of the said Companies,

this 10<sup>th</sup> day of August, 2014



*Geoffrey Delisio*

Geoffrey Delisio, Vice President

# CONTRACTOR LICENSE

Authorized by the

**West Virginia Contractor Licensing Board**

**Number:**

WV034855

**Classification:**

SPECIALTY  
LOW VOLTAGE SYSTEMS

POMEROY IT SOLUTIONS SALES COM INC  
DBA POMEROY IT SOLUTIONS SALES COM INC  
500 WESTMORELAND OFFICE PARK  
DUNBAR, WV 25064

**Date Issued**

JUNE 07, 2016

**Expiration Date**

JUNE 07, 2017

**WEST VIRGINIA  
CONTRACTOR  
LICENSING  
BOARD**

*Charles W. King*  
Authorized Company Signature

*Michael A. Carl*  
Chair, West Virginia Contractor  
Licensing Board

This license, or a copy thereof, must be posted in a conspicuous place at every construction site where work is being performed. This license number must appear in all advertisements, on all bid submissions and on all fully executed and binding contracts. This license cannot be assigned or transferred by licensee. Issued under provisions of West Virginia Code, Chapter 21, Article 11.

STATE OF WEST VIRGINIA  
Purchasing Division  
**PURCHASING AFFIDAVIT**

**MANDATE:** Under W. Va. Code §5A-3-10a, no contract or renewal of any contract may be awarded by the state or any of its political subdivisions to any vendor or prospective vendor when the vendor or prospective vendor or a related party to the vendor or prospective vendor is a debtor and: (1) the debt owed is an amount greater than one thousand dollars in the aggregate; or (2) the debtor is in employer default.

**EXCEPTION:** The prohibition listed above does not apply where a vendor has contested any tax administered pursuant to chapter eleven of the W. Va. Code, workers' compensation premium, permit fee or environmental fee or assessment and the matter has not become final or where the vendor has entered into a payment plan or agreement and the vendor is not in default of any of the provisions of such plan or agreement.

**DEFINITIONS:**

"Debt" means any assessment, premium, penalty, fine, tax or other amount of money owed to the state or any of its political subdivisions because of a judgment, fine, permit violation, license assessment, defaulted workers' compensation premium, penalty or other assessment presently delinquent or due and required to be paid to the state or any of its political subdivisions, including any interest or additional penalties accrued thereon.

"Employer default" means having an outstanding balance or liability to the old fund or to the uninsured employers' fund or being in policy default, as defined in W. Va. Code § 23-2c-2, failure to maintain mandatory workers' compensation coverage, or failure to fully meet its obligations as a workers' compensation self-insured employer. An employer is not in employer default if it has entered into a repayment agreement with the Insurance Commissioner and remains in compliance with the obligations under the repayment agreement.

"Related party" means a party, whether an individual, corporation, partnership, association, limited liability company or any other form or business association or other entity whatsoever, related to any vendor by blood, marriage, ownership or contract through which the party has a relationship of ownership or other interest with the vendor so that the party will actually or by effect receive or control a portion of the benefit, profit or other consideration from performance of a vendor contract with the party receiving an amount that meets or exceeds five percent of the total contract amount.

**AFFIRMATION:** By signing this form, the vendor's authorized signer affirms and acknowledges under penalty of law for false swearing (W. Va. Code §61-5-3) that neither vendor nor any related party owe a debt as defined above and that neither vendor nor any related party are in employer default as defined above, unless the debt or employer default is permitted under the exception above.

**WITNESS THE FOLLOWING SIGNATURE:**

Vendor's Name: Pomeroy IT Solutions Sales Co.  
Authorized Signature: Connie White Date: 08-16-16

State of West Virginia  
County of Morgan, to-wit:

Taken, subscribed, and sworn to before me this 16<sup>th</sup> day of August, 2016  
My Commission expires Aug 22, 2016

**AFFIX SEAL HERE**



OFFICIAL SEAL  
NOTARY PUBLIC  
STATE OF WEST VIRGINIA  
Judith A. Snodgrass  
48 Snodgrass Lane  
P.O. Box 336  
Comfort, WV 25049  
My Commission Expires Aug. 22, 2016

NOTARY PUBLIC Judith A. Snodgrass  
Purchasing Affidavit (Revised 08/01/2015)

AGREEMENT ADDENDUM

In the event of conflict between this addendum and the agreement, this addendum shall control:

1. **DISPUTES** - Any references in the agreement to arbitration or to the jurisdiction of any court are hereby deleted. Disputes arising out of the agreement shall be presented to the West Virginia Court of Claims.
2. **HOLD HARMLESS** - Any provision requiring the Agency to indemnify or hold harmless any party is hereby deleted in its entirety.
3. **GOVERNING LAW** - The agreement shall be governed by the laws of the State of West Virginia. This provision replaces any references to any other State's governing law.
4. **TAXES** - Provisions in the agreement requiring the Agency to pay taxes are deleted. As a State entity, the Agency is exempt from Federal, State, and local taxes and will not pay taxes for any Vendor including individuals, nor will the Agency file any tax returns or reports on behalf of Vendor or any other party.
5. **PAYMENT** - Any references to prepayment are deleted. Payment will be in arrears.
6. **INTEREST** - Any provision for interest or charges on late payments is deleted. The Agency has no statutory authority to pay interest or late fees.
7. **NO WAIVER** - Any language in the agreement requiring the Agency to waive any rights, claims or defenses is hereby deleted.
8. **FISCAL YEAR FUNDING** - Service performed under the agreement may be continued in succeeding fiscal years for the term of the agreement, contingent upon funds being appropriated by the Legislature or otherwise being available for this service. In the event funds are not appropriated or otherwise available for this service, the agreement shall terminate without penalty on June 30. After that date, the agreement becomes of no effect and is null and void. However, the Agency agrees to use its best efforts to have the amounts contemplated under the agreement included in its budget. Non-appropriation or non-funding shall not be considered an event of default.
9. **STATUTE OF LIMITATION** - Any clauses limiting the time in which the Agency may bring suit against the Vendor, lessor, individual, or any other party are deleted.
10. **SIMILAR SERVICES** - Any provisions limiting the Agency's right to obtain similar services or equipment in the event of default or non-funding during the term of the agreement are hereby deleted.
11. **FEES OR COSTS** - The Agency recognizes an obligation to pay attorney's fees or costs only when assessed by a court of competent jurisdiction. Any other provision is invalid and considered null and void.
12. **ASSIGNMENT** - Notwithstanding any clause to the contrary, the Agency reserves the right to assign the agreement to another State of West Virginia agency, board or commission upon thirty (30) days written notice to the Vendor and Vendor shall obtain the written consent of Agency prior to assigning the agreement.
13. **LIMITATION OF LIABILITY** - The Agency, as a State entity, cannot agree to assume the potential liability of a Vendor. Accordingly, any provision limiting the Vendor's liability for direct damages to a certain dollar amount or to the amount of the agreement is hereby deleted. Limitations on special, incidental or consequential damages are acceptable. In addition, any limitation is null and void to the extent that it precludes any action for injury to persons or for damages to personal property.
14. **RIGHT TO TERMINATE** - Agency shall have the right to terminate the agreement upon thirty (30) days written notice to Vendor. Agency agrees to pay Vendor for services rendered or goods received prior to the effective date of termination.
15. **TERMINATION CHARGES** - Any provision requiring the Agency to pay a fixed amount or liquidated damages upon termination of the agreement is hereby deleted. The Agency may only agree to reimburse a Vendor for actual costs incurred or losses sustained during the current fiscal year due to wrongful termination by the Agency prior to the end of any current agreement term.
16. **RENEWAL** - Any reference to automatic renewal is deleted. The agreement may be renewed only upon mutual written agreement of the parties.
17. **INSURANCE** - Any provision requiring the Agency to purchase insurance for Vendor's property is deleted. The State of West Virginia is insured through the Board of Risk and Insurance Management, and will provide a certificate of property insurance upon request.
18. **RIGHT TO NOTICE** - Any provision for repossession of equipment without notice is hereby deleted. However, the Agency does recognize a right of repossession with notice.
19. **ACCELERATION** - Any reference to acceleration of payments in the event of default or non-funding is hereby deleted.
20. **CONFIDENTIALITY** - Any provision regarding confidentiality of the terms and conditions of the agreement is hereby deleted. State contracts are public records under the West Virginia Freedom of Information Act.
21. **AMENDMENTS** - All amendments, modifications, alterations or changes to the agreement shall be in writing and signed by both parties. No amendment, modification, alteration or change may be made to this addendum without the express written approval of the Purchasing Division and the Attorney General.

ACCEPTED BY:

STATE OF WEST VIRGINIA

Spending Unit: \_\_\_\_\_  
 Signed: \_\_\_\_\_  
 Title: \_\_\_\_\_  
 Date: \_\_\_\_\_

VENDOR

Company Name: Pomeroy IT Solutions  
 Signed: [Signature]  
 Title: Technology Solutions Executive  
 Date: 08-16-16

## DS-2CD2132F-I(W)(S)



### Key Features

- Up to 3 megapixel (2048 × 1536) resolution
- Standard video compression with high compression ratio, ROI (region of interest) encoding
- Progressive scan CMOS, capture motion video without incised margin
- Support dual stream, and the sub-stream for mobile surveillance
- High-performance and long service life infrared LED, Approx. 10 to 30 meters IR range
- Two-way audio(-S)
- Audio I/O(-S)
- Support Wi-Fi(-W)
- IR cut filter with auto switch
- PoE (Power over Ethernet)
- Built-in Micro SD/SDHC/SDXC card slot, up to 128 GB
- Ingress Protection level: IP66
- Impact Protection: IEC60068-2-75 test, Eh, 20J; EN50102, up to IK10
- Other functions: rotate mode, alarm, mirror, reset button, etc
- Support intrusion detection and line crossing detection
- Support VCA, which is compatible with NVR for the second time of video searching and analysing

### Specification

Model	DS-2CD2132F-I(W)(S)
Parameter	3 Megapixel CMOS Vandal-proof Network Dome Camera
Image Sensor	1/3" Progressive Scan CMOS
Min. Illumination	0.07Lux @ (F1.2, AGC ON) ,0 Lux with IR 0.19 Lux @ (F2.0, AGC ON) ,0 Lux with IR
Shutter Speed	1/3 s to 1/100,000 s
Lens	4mm@ F2.0 (2.8mm, 6mm optional) Angle of view: 98.5°(2.8mm), 79°(4mm) , 49°(6mm)

Lens Mount	M12
Day & Night	IR cut filter with auto switch
Digital Noise Reduction	3D DNR
Wide Dynamic Range	Digital WDR
Angle Adjustment	Pan:0° - 355°, Tilt: 0° - 75°, Rotation: 0-355°
<b>Compression Standard</b>	
Video Compression	H.264/ MJPEG
H.264 Type	Main Profile
Video Bit Rate	32 Kbps – 12 Mbps
Dual Stream	Yes
Audio Compression(-S)	G.711/G.722.1/G.726/MP2L2
Audio Bit Rate(-S)	64Kbps(G.711) /16Kbps(G.722.1)/16Kbps(G.726) /32-128Kbps(MP2L2)
<b>Image</b>	
Max. Resolution	2048 × 1536
Frame Rate	50Hz: 20fps(2048 × 1536), 25fps(1920 × 1080), 25fps (1280 × 720) 60Hz: 20fps(2048 × 1536), 30fps(1920 × 1080), 30fps (1280 × 720)
Image Settings	Rotate mode, Saturation, Brightness, Contrast adjustable by client software or web browser
Backlight compensation	Yes, zone optional
ROI	Support
<b>Network</b>	
Network Storage	Local storage: Built-in Micro SD/SDHC/SDXC card slot, up to 128 GB. NAS (Support NFS,SMB/CIFS)
Alarm Trigger	Intrusion detection, Line crossing detection, Motion detection, Dynamic Analysis, Tampering alarm, Network disconnect, IP address conflict, Storage full, Storage error
Protocols	TCP/IP,ICMP,HTTP,HTTPS,FTP,DHCP,DNS,DDNS,RTP,RTSP,RTCP, PPPoE,NTP,UPnP,SMTP,SNMP,IGMP,802.1X,QoS,IPv6,Bonjour
Security	User Authentication, Watermark
Standard	ONVIF, PSIA, CGI, ISAPI
<b>Interface</b>	
Communication Interface	1 RJ45 10M/100M Ethernet interface
Alarm interface	-S: 1 alarm I/O
Audio interface	-S: 1 audio I/O
<b>Wi-Fi Specification (Only for the products with Wi-Fi module built-in)</b>	
Wireless Standards	IEEE802.11b, 802.11g, 802.11n
Frequency Range	2.4 GHz ~ 2.4835 GHz

Channel Bandwidth	20/40MHz Support
Protocols	802.11b: CCK, QPSK, BPSK 802.11g/n: OFDM
Security	64/128-bit WEP, WPA/WPA2, WPA-PSK/WPA2-PSK, WPS
Transmit Output Power	11b: 17±1.5dBm @ 11Mbps 11g: 14±1.5dBm @ 54Mbps 11n: 12.5±1.5dBm
Receive Sensitivity	11b: -90dBm @ 11Mbps (Typical) 11g: -75dBm @ 54Mbps (Typical) 11n: -74dBm (Typical)
Transfer Rates	11b: 11Mbps 11g: 54Mbps 11n: up to 150Mbps
Wireless Range	50m(depend on environment)
Wireless Standards	IEEE802.11b, 802.11g, 802.11n
<b>General</b>	
Operating Conditions	-30 °C – 60 °C (-22 °F – 140 °F) Humidity 95% or less (non-condensing)
Power Supply	12 V DC ± 10% PoE (802.3af)
Power Consumption	Max. 5W
Ingress Protection level	IP66
IR Range	30 meters
Impact Protection	IEC60068-2-75Eh, 20J; EN50102, up to IK10
Dimensions	Φ111 × 82 (4.4" × 3.2")
Weight	500g (1.1 lb)

\* "-W" series support Wi-Fi (802.11b/g/n) and the modules with Wi-Fi function don't support the 802.1X protocol.

## Order Models

DS-2CD2132F-I, DS-2CD2132F-IW, DS-2CD2132F-IS, DS-2CD2132F-IWS

## Dimensions

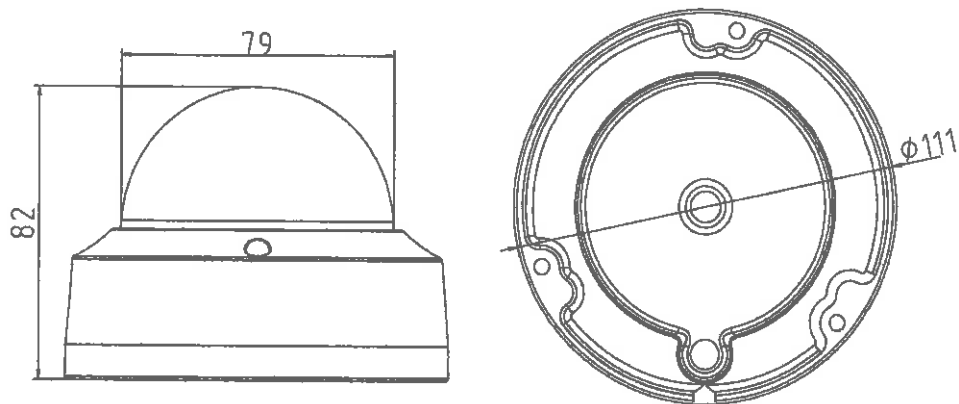

## Accessories



Inclined ceiling mount  
DS-1259ZJ



Wall mount  
DS-1272ZJ-110



## DS-2CD2512F-I (S)(1.3MP)/DS-2CD2532F-I (S)(3MP) IR Mini Dome Network Camera



### Key features

- 1.3MP / 3MP high resolution
- HD real-time video
- -I: IR LEDs (up to 10m)
- DWDR & 3D DNR & BLC
- Onboard storage (up to 64GB)
- -S: Audio/Alarm I/O
- IP66 protection

### Dimensions

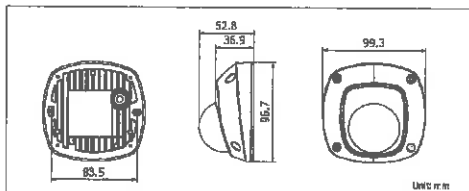

### Accessories



DS-1272ZJ-120  
Indoor/Outdoor wall mount

### Available models

DS-2CD2512F-I, DS-2CD2512F-IS  
DS-2CD2532F-I, DS-2CD2532F-IS

\* -S: Audio/Alarm IO

	DS-2CD2512F-I(S)	DS-2CD2532F-I(S)
<b>Camera</b>		
Image sensor	1/3" progressive scan CMOS	
Min. illumination	0.01 lux @ F1.2, AGC ON, 0 lux with IR	0.07 lux @ F1.2, AGC ON, 0 lux with IR
Shutter time	1/25s ~ 1/100,000s	
Lens	4mm @ F2.0 (2.8mm, 6mm optional)	4mm @ F2.0 (2.8mm, 6mm optional)
	Angle of view: 92.5°(2.8mm), 73.1°(4mm), 46°(6mm)	2048 × 1536: Angle of view: 86°(4mm), 70°(4mm), 43.3°(6mm) 1920 × 1080: Angle of view: 98.5°(4mm), 79°(4mm), 49°(6mm)
Lens mount	M12	
Day & night	-I: IR cut filter with auto switch	
Adjustment angle	Pan: -30°-30°, Tilt: 0-75°, Rotation: 0-360°	
Digital noise reduction	3D DNR	
Wide dynamic range	Digital WDR	
Backlight compensation	Yes, zone configurable	
<b>Compression Standard</b>		
Video compression	H.264 / MJPEG	
H.264 codec profile	Main profile	
Bit rate	32 Kbps ~ 16 Mbps	
Audio compression(-s)	G.711/G.726/MP2L2	
Audio bit rate(-s)	64Kbps(G.711) / 16Kbps(G.726) / 32-128Kbps(MP2L2)	
<b>Image</b>		
Max. Image Resolution	1280 × 800	2048 × 1536
Frame rate	50 Hz: 25 fps (1280 × 960), 25 fps (1280 × 720), 25 fps (704 × 576), 25 fps (640 × 480)	50Hz: 20fps (2048 × 1536), 25fps (1920 × 1080), 25fps (1280 × 720)
	60 Hz: 30 fps (1280 × 960), 30 fps (1280 × 720), 30 fps (704 × 576), 30 fps (640 × 480)	60Hz: 20fps (2048 × 1536), 30fps (1920 × 1080), 30fps (1280 × 720)
Image settings	Rotate mode, Saturation, brightness, contrast, sharpness adjustable through client software or web browser	
ROI	Yes, up to 4 configurable areas	
<b>Network</b>		
Network storage	Local storage: Built-in Micro SD/SDHC/SDXC card slot, up to 64 GB. NAS	
Alarm trigger	Motion detection, tampering alarm, network disconnect, IP address conflict, storage exception, storage error	
Protocols	TCP/IP, ICMP, HTTP, HTTPS, FTP, DHCP, DNS, DDNS, RTP, RTSP, RTCP, PPPoE, NTP, UPnP, SMTP, SNMP, IGMP, 802.1X, QoS, IPv6, Bonjour	
System compatibility	ONVIF, PSIA, CGI, ISAPI	
General functionalities	Flickerless, dual stream, heartbeat, mirror, user authentication, video mask, watermark	
<b>Interface</b>		
Communication interface	1 RJ45 10M / 100M ethernet port	
On-board storage	Built-in Micro SD/SDHC/SDXC card slot, up to 64 GB	
Alarm interface	-S: 1/1 alarm I/O	
<b>General</b>		
Operating conditions	-30 °C ~ 60 °C (-22°F ~ 140 °F) humidity 95% or less (non-condensing)	
Power supply	12 VDC ± 10% , PoE (802.3af)	
Power consumption	Max. 5W	
Protect level	IP66	
Impact Protection	IEC60068-275Eh, 50J; EN50102, up to IK08	
IR range	-I: 10 meters	
Dimensions (mm)	99.3×96.7×52.8mm	
Weight	600 g (1.32 lbs)	

## DS-9600NI-ST Series NVR



### Introduction:

DS-9600NI-ST series NVR (Network Video Recorder) is a new generation recorder developed by Hikvision independently. Combined with multiple advanced technologies, such as audio and video decoding technology, embedded system technology, storage technology, network technology and intelligent technology, it can both work alone as a recorder and cooperate with other device to build a comprehensive surveillance system.

The DS-9600NI-ST series NVR can be widely applied in the areas of finance, public security, military, communication, transportation, education, etc..

### Available Models:

DS-9608NI-ST, DS-9616NI-ST, DS-9632NI-ST, and DS-9664NI-ST.

### Main Features:

- Connectable to the third-party network cameras like ACTI, Arecont, AXIS, Bosch, Brickcom, Canon, PANASONIC, Pelco, SAMSUNG, SANYO, SONY, Vivotek and ZAVIO, and cameras that adopt ONVIF or PSIA protocol.
- Up to 64 network cameras can be connected
- Support live view, storage, and playback of the connected camera at up to 6 megapixels resolution.
- Simultaneous HDMI, VGA and CVBS outputs; and respective live view and playback via VGA and HDMI outputs.
- New GUI and support starting record with one key;
- Redundant recording, holiday recording and capture schedule configuration;
- Up to 16-ch synchronous playback at 720P resolution.
- Smart playback to quick get through the less effective information.
- Connectable to the smart IP cameras from Hikvision, and VCA functions can be realized.
- Customization of tags, searching, and playing back by tags.
- Locking and unlocking record files.
- Support HDD quota and group modes; different capacity can be assigned to different channel.
- Up to 8 SATA hard disks and 1 eSATA disk can be connected, for both recording and backup.
- Hot-swappable HDD supporting RAID0, RAID1, RAID5, RAID10 storage scheme. And 8 arrays can be configured.
- Either normal or hot spare working mode is configurable to constitute an N+1 hot spare system.
- 2 self-adaptive 10M/100M/1000M network interfaces, with working modes configurable: multi-address, load balance, network fault tolerance, etc.
- Support Hikvision DDNS (Dynamic Domain Name System);
- Support Channel-zero encoding, which enables you to get a view in the remote client or web browser of 16 channels in one screen.
- Support network detection, including network delay, packet loss, etc.
- Adopt pioneering dual-OS design to ensure the security of system running.
- Support VCA alarm for up to 16 VCA detections.
- Support VCA search for behavior search, face search, people counting, heat map and plate search.
- Support enabling H.264+ to ensure high video quality with lowered bitrate.

### Physical Interfaces:

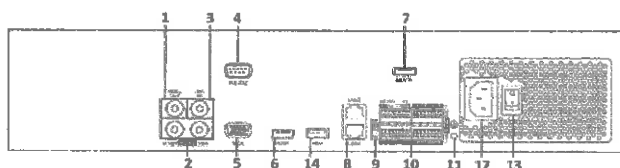

Index	Name
1	VIDEO OUT
2	CVBS AUDIO OUT and VGA AUDIO OUT
3	LINE IN
4	RS-232 Serial Interface
5	VGA Interface
6	HDMI Interface
7	eSATA Interfaces
8	LAN1, LAN2 Network Interface
9	Termination Switch
10	RS-485 Serial Interface, Keyboard Interface, ALARM IN and ALARM OUT
11	GND
12	100~240VAC Power Input
13	Power Switch
14	USB Interface

### Typical Application:

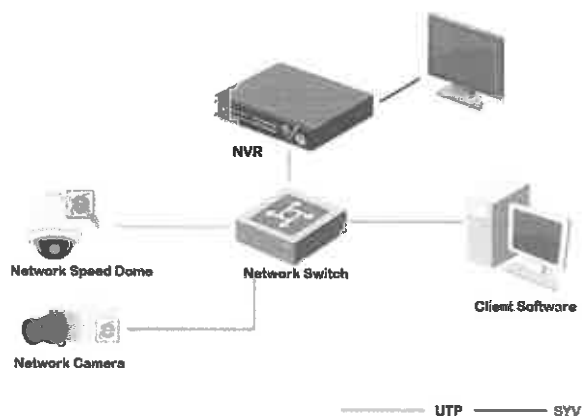

## Specifications:

Model		DS-9608NI-ST	DS-9616NI-ST	DS-9632NI-ST	DS-9664NI-ST
Video/Audio input	IP video input	8-ch	16-ch	32-ch	64-ch
	Two-way audio	1-ch, BNC (2.0 Vp-p, 1kΩ)			
Network	Incoming bandwidth	50Mbps	100Mbps	200Mbps	200Mbps
		50Mbps (when RAID is enabled)	100Mbps (when RAID is enabled)		
	Outgoing bandwidth	240Mbps	240Mbps	160Mbps	160Mbps
		100Mbps (when RAID is enabled)			
Remote Connection	128				
Video/Audio output	Recording resolution	6MP /5MP /3MP /1080P /UXGA /720P /VGA /4CIF /DCIF /2CIF /CIF /QCIF			
	CVBS output	1-ch, BNC (1.0 Vp-p, 75 Ω) Resolution: 704 × 576 (PAL); 704 × 480 (NTSC)			
	HDMI output	1-ch, resolution: 1920 × 1080P /60Hz, 1920×1080P /50Hz, 1600 × 1200/60Hz, 1280 × 1024 /60Hz, 1280 × 720 /60Hz, 1024 × 768 /60Hz			
	VGA output	1-ch, resolution: 1920 × 1080P /60Hz, 1600 × 1200 /60Hz, 1280 × 1024 /60Hz, 1280 × 720 /60Hz, 1024 × 768 /60Hz			
	Audio output	2-ch, BNC (Linear, 600Ω)			
Decoding	Live view / Playback resolution	6MP /5MP /3MP /1080P /UXGA /720P /VGA /4CIF /DCIF /2CIF /CIF /QCIF			
	Capability	10-ch@720P, 5-ch@1080P	10-ch@720P, 5-ch@1080P	16-ch@720P, 8-ch@1080P	16-ch@720P, 8-ch@1080P
Hard disk	SATA	8 SATA interfaces for 4 HDDs + 1 DVD-R/W (default), or 8HDDs			
	eSATA	1 eSATA interface			
	Capacity	Up to 4TB capacity for each HDD			
Disk array	Array type	RAID0, RAID1, RAID5, RAID10			
	Number of array	8			
External interface	Network interface	2 RJ-45 10 /100 /1000 Mbps self-adaptive Ethernet interfaces			
	Serial interface	RS-232; RS-485; Keyboard;			
	USB interface	3 × USB 2.0			
	Alarm in/out	16/4			
Others	Power supply	100 ~ 240 VAC, 6.3 A, 50 ~ 60 Hz			
	Consumption (without hard disk or DVD-R/W)	≤ 35 W	≤ 40 W	≤ 45 W	≤ 45 W
	Working temperature	-10 °C ~ +55 °C (14°F ~ 131°F)			
	Working humidity	10 % ~ 90 %			
	Chassis	19-inch rack-mounted 2U chassis			
	Dimensions (W × D × H)	445 × 470 ×90 mm (17.5" ×18.5"× 3.5")			
	Weight (without hard disk or DVD-R/W)	≤ 8 Kg (17.64 lb)			

*Note:*

The formula to calculate the incoming bandwidth and the IP camera connected is:  $A = B/(C+D)$ .

A refers to the number of IP camera you connected.

B refers to the value of the incoming bandwidth.

C refers to the bitrate value of the main stream of the connected IP camera.

And D refers to the bitrate value of the sub-stream of the connected IP camera.

*Example:* The incoming bandwidth of DS-9632NI-ST NVR is 200Mbps and the IP camera to connect is with resolution of 1080P (1920\*1080) / 25 (30) fps. The bitrate for the main stream and sub-stream of the IP camera is set as 6Mbps and 1Mbps respectively.

In this example,  $B=200\text{Mbps}$ ,  $C=6\text{Mbps}$ ,  $D=1\text{Mbps}$  and  $A = B/(C+D) = 200 / (6+1) \approx 28$ . So the number of IP cameras can be connected with is 28.



## Product Highlights

### Flexible Connectivity Options

- 8, 16, 24 or 48 10/100/1000BASE-T ports
- 2 or 4 Gigabit SFP ports
- PoE+ (802.3at) support on select models

### Traffic Prioritization for Voice and Video

- Auto Surveillance VLAN (ASV) and Auto Voice VLAN ensure security and telephone systems have highest priority

### IPv6 Support

- Fully IPv6 compatible and ready for enterprise deployment

### Energy Efficient Technology

- IEEE 802.3az EEE and D-Link Green 3.0 technology help reduce energy use and operating costs

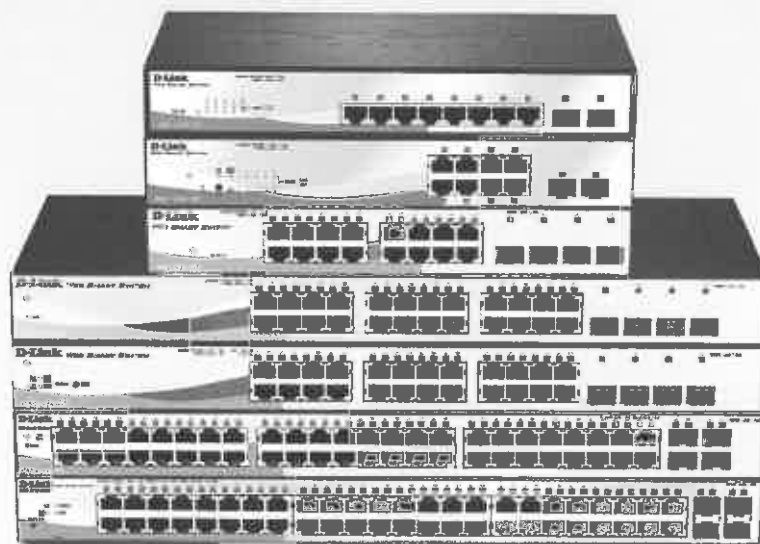

Lifetime  
Warranty

## DGS-1210 Series

# Gigabit Web Smart Switches

## Features

### Security

- Access Control List
- D-Link Safeguard Engine®
- Port Security
- ARP Spoofing Prevention
- Smart IP-MAC-Port Binding
- DHCP Server Screening

### Management

- Web GUI
- D-Link Network Assistant Utility
- Simplified CLI through Telnet
- SNMP and RMON
- IPv4/ IPv6 Dual Stack

### QoS

- Supports IEEE 802.1p Quality of Service
- Supports DSCP

### Advanced Features

- Auto Surveillance VLAN
- Auto Voice VLAN
- Port or VLAN-based Loopback Detection
- Cable Diagnostics
- LLDP/LLDP-MED

## Overview

The DGS-1210 Series is the latest generation of D-Link® Gigabit Web Smart Switches featuring D-Link Green 3.0 technology. The switches comply with the IEEE 802.3az Energy Efficient Ethernet standard. Support for IPv6 management and configuration features ensures your network remains protected after an upgrade from IPv4 to IPv6. By offering multiple management options, these switches allow quick deployment, infrastructure expansion, and seamless upgrades. Targeting small and medium sized businesses, the DGS-1210 Web Smart switches provide functionality, security, and manageability for a fraction of the standard cost of ownership.

The DGS-1210 Series switches support 8, 16, 24, or 48 10/100/1000BASE-T ports. In addition, each switch supports 2 or 4 Gigabit SFP ports for optical connections using multimode or singlemode SFP transceivers.

## PoE Support

Several models in the DGS-1210 series family support Power-over-Ethernet capabilities, simplifying deployments with IP cameras, VoIP phones, wireless access points, and other powered devices. These models include the DGS-1210-10P, DGS-1210-28P and DGS-1210-52MP. Using the switch's management interface, an administrator can control various PoE functions, such as remotely rebooting cameras or access points, from anywhere on the network, including over the Internet. The switches also support time-based PoE – an option that allows administrators to set a time window that determines when each port's PoE power is turned on and off.



## DGS-1210 Series Gigabit Web Smart Switches

### Energy Saving

The DGS-1210 Series Switches are capable of conserving power without sacrificing operational performance or functionality by using D-Link Green 3.0 technology. Using the Energy Efficient Ethernet standard, the network will automatically decrease the power usage when traffic is low. For environments not fully supporting the standard, these switches offer advanced power-saving settings including port shutoff, LED shutoff, and system hibernation based on custom time profiles. The time profiles can also be applied to the PoE switches so that unnecessary power consumption can be saved during off hours.

### Easy Management

The D-Link Web Smart Switch series is designed for easy management. All configuration can be performed through an intuitive browser-based Graphical User Interface regardless of the host PC's operating system. The DGS-1210 Series switches also support a D-Link Network Assistant Utility that enables administrators to remotely control their network down to the port level. This utility allows customers to easily discover multiple D-Link Web Smart Switches within the same L2 network segment. With this utility, users do not need to change the IP address of their PC. It also simplifies the initial setup by taking switches, within the same L2 network segment, that are connected to the user's PC, and displaying them on screen for instant access. This allows extensive switch configuration and basic setup of discovered devices, including password changes and firmware upgrades. In addition, the DGS-1210 Series supports D-View® 6.0 and Compact Command Line Interface (CLI) through Telnet. D-View 6.0 is a network management system that allows for the central management of critical network characteristics such as availability, reliability, resilience, and security.



### Auto Surveillance VLAN and Voice VLAN

The D-Link Web Smart series automates the process of setting up IP surveillance and VoIP devices on a network. Auto Surveillance VLAN consolidates data and surveillance video transmission through the network, sparing businesses the expense of maintaining dedicated facilities. ASV also protects the quality of real-time video by grouping IP surveillance devices on a single high priority VLAN.

This ensures that surveillance video streams will not be affected when ordinary data traffic is at a high level. Similarly, the Auto Voice VLAN guarantees clear quality and efficient transmission for all voice communication.

### Extensive Layer 2 Features

Equipped with a complete lineup of L2 features, these switches include IGMP Snooping, Port Mirroring, Spanning Tree, and Link Aggregation Control Protocol (LACP). The IEEE 802.3x Flow Control function allows servers to directly connect to the switch for fast, reliable data transfer. At 2000 Mbps Full Duplex, the Gigabit ports provide high-speed data pipes to servers with minimum data transfer loss. Network maintenance features include Loopback Detection and Cable Diagnostics. Loopback Detection is used to detect loops created by a specific port and automatically shut down the affected port. The Cable Diagnostic feature designed primarily for administrators and customer service representatives, can rapidly discover the type of error and determine the cable quality.

### Secure your Network

D-Link's innovative Safeguard Engine protects the switches against traffic flooding caused by virus attacks. The switches also support 802.1X port-based authentication, allowing the network clients to be authenticated through external RADIUS servers. In addition, the Access Control List (ACL) feature enhances network security and protects the network by screening traffic from illegal MAC or IP addresses. ARP Spoofing Prevention prevents malicious intruders from sending massive fake ARP messages through a manipulated source. This protects important data from being stolen by Man-in-the-Middle attacks, and prevents wasting CPU cycles on these packets. For added security, the DHCP Server Screening feature blocks rogue DHCP server packets from user ports to prevent unauthorized IP assignment.

### Limited Lifetime Warranty

D-Link offers a Limited Lifetime Warranty on the DGS-1210 Series Web Smart switches to further its commitment to product quality and long-term customer confidence.



Technical Specifications	DGS-1210-10	DGS-1210-20	DGS-1210-28	DGS-1210-52
<b>General</b>				
Port Standards & Functions	<ul style="list-style-type: none"> <li>• IEEE 802.3 10BASE-T Ethernet</li> <li>• IEEE 802.3u 100BASE-TX (Fast Ethernet)</li> <li>• IEEE 802.3ab 1000BASE-T (Gigabit Ethernet)</li> <li>• IEEE 802.3x Flow Control for Full-Duplex Mode</li> <li>• Auto-negotiation</li> </ul>			
Number of Ports	• 8 10/100/1000 Mbps • 2 SFP	• 16 10/100/1000 Mbps • 4 SFP	• 24 10/100/1000 Mbps • 4 SFP	• 48 10/100/1000 Mbps • 4 SFP
Network Cables	<ul style="list-style-type: none"> <li>• UTP Cat. 5, Cat. 5e (100 m max.)</li> <li>• EIA/TIA-568 100-ohm STP (100 m max.)</li> </ul>			
Full/Half Duplex	<ul style="list-style-type: none"> <li>• Full/half duplex for 10/100 Mbps speeds</li> <li>• Full duplex for Gigabit speed</li> </ul>			
Media Interface Exchange	Auto or configurable MDI/MDIX			
<b>Performance</b>				
Switching Capacity	20 Gbps	40 Gbps	56 Gbps	104 Gbps
Transmission Method	Store-and-forward			
MAC Address Table	16,000 entries per device			
MAC Address Update	<ul style="list-style-type: none"> <li>• Up to 256 static MAC entries</li> <li>• Enable/disable auto-learning of MAC addresses</li> </ul>			
Maximum 64 bytes packet forwarding rate	14.88 Mpps	29.8 Mpps	41.7 Mpps	77.4 Mpps
Packet Buffer Memory	15 MB	15 MB	15 MB	30 MB
<b>Physical &amp; Environment</b>				
AC Input	100 to 240 VAC 50/60 Hz internal universal power supply			
Maximum Power Consumption	13.59 W	16.09 W	22.45 W	38.27 W
Standby Power Consumption	9.3 W/110 V, 9.4 W/240 V	8.59 W/110 V, 8.80 W/240 V	17.65 W/110 V, 17.84 W/240 V	29.44 W/110 V, 29.49 W/240 V
Fan Quantity	0	0	0	Two smart fans
Acoustics	0 dB(A)	0 dB(A)	0 dB(A)	Low speed: 39.8 dB(A) High speed: 49.2 dB(A)
Heat Dissipation	46.37 BTU/hr	54.91 BTU/hr	76.55 BTU/hr	130.58 BTU/hr
Operating Temperature	23 to 122 °F (-5 to 50 °C)			
Storage Temperature	-4 to 158 °F (-20 to 70 °C)			
Operating Humidity	0% to 95% non-condensing			
Storage Humidity	0% to 95% non-condensing			

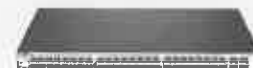
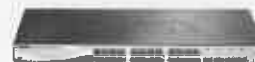
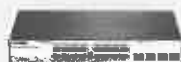

Dimensions	<ul style="list-style-type: none"> <li>• 11.02 x 4.96 x 1.73 inches (280 x 126 x 44 mm)</li> <li>• 19" standard rack mounting width, 1U height</li> </ul>	<ul style="list-style-type: none"> <li>• 11.02 x 7.09 x 1.73 inches (280 x 180 x 44 mm)</li> <li>• 19" standard rack mounting width, 1U height</li> </ul>	<ul style="list-style-type: none"> <li>• 17.32 x 5.51 x 1.73 inches (440 x 140 x 44 mm)</li> <li>• 19" standard rack mounting width, 1U height</li> </ul>	<ul style="list-style-type: none"> <li>• 17.32 x 8.27 x 1.73 inches (440 x 210 x 44 mm)</li> <li>• 19" standard rack mounting width, 1U height</li> </ul>
Weight	3.39 lbs (1.54 kg)	2.82 lbs (1.28 kg)	3.68 lbs (1.67 kg)	5.69 lbs (2.58 kg)
Diagnostic LEDs	<ul style="list-style-type: none"> <li>• Power (per device)</li> <li>• Link/Activity/Speed (per 10/100/1000 Mbps port)</li> <li>• Link/Activity/Speed (per SFP port)</li> </ul>	<ul style="list-style-type: none"> <li>• Power (per device)</li> <li>• Link/Activity/Speed (per 10/100/1000 Mbps port)</li> <li>• Link/Activity/Speed (per SFP port)</li> </ul>	<ul style="list-style-type: none"> <li>• Power (per device)</li> <li>• Link/Activity/Speed (per 10/100/1000 Mbps port)</li> <li>• Link/Activity/Speed (per SFP port)</li> </ul>	<ul style="list-style-type: none"> <li>• Power (per device)</li> <li>• Link/Activity/Speed (per 10/100/1000 Mbps port)</li> <li>• Link/Activity/Speed (per SFP port)</li> <li>• Fan (per device)</li> </ul>
MTBF	360,844 hours	317,412 hours	540,000 hours	481,624 hours
Certifications	<ul style="list-style-type: none"> <li>• FCC Class A</li> <li>• CE Class A</li> <li>• ICES-003</li> <li>• VCCI Class A</li> <li>• C-Tick</li> <li>• BSMI</li> </ul>			
Safety	<ul style="list-style-type: none"> <li>• cUL</li> <li>• CE LVD</li> </ul>			





Technical Specifications	DGS-1210-10P	DGS-1210-28P	DGS-1210-52MP
<b>General</b>			
Port Standards & Functions	<ul style="list-style-type: none"> <li>• IEEE 802.3 10BASE-T Ethernet</li> <li>• IEEE 802.3u 100BASE-TX (Fast Ethernet)</li> <li>• IEEE 802.3ab 1000BASE-T (Gigabit Ethernet)</li> <li>• IEEE 802.3x Flow Control for Full-Duplex Mode               <ul style="list-style-type: none"> <li>• IEEE 802.3af compliance</li> <li>• IEEE 802.3at compliance</li> <li>• Auto-negotiation</li> </ul> </li> </ul>		
Number of Ports	• 8 10/100/1000 Mbps PoE • 2 SFP	• 24 10/100/1000 Mbps PoE • 4 SFP	• 48 10/100/1000 Mbps PoE • 4 SFP
Network Cables	<ul style="list-style-type: none"> <li>• UTP Cat. 5, Cat. 5e, Cat. 6 (100 m max.)</li> <li>• EIA/TIA-568 100-ohm STP (100 m max.)</li> </ul>		
Full/Half Duplex	<ul style="list-style-type: none"> <li>• Full/half duplex for 10/100 Mbps speeds</li> <li>• Full duplex for Gigabit speed</li> </ul>		
Media Interface Exchange	Auto or configurable MDI/MDIX		
<b>Performance</b>			
Switching Capacity	40 Gbps	56 Gbps	104 Gbps
Transmission Method	Store-and-forward		
MAC Address Table	16,000 entries per device		
MAC Address Update	<ul style="list-style-type: none"> <li>• Up to 256 static MAC entries</li> <li>• Enable/disable auto-learning of MAC addresses</li> </ul>		
Maximum 64 bytes packet forwarding rate	14.88 Mpps	41.7 Mpps	77.4 Mpps
Packet Buffer Memory	1.5 MB	1.5 MB	3.0 MB
<b>PoE</b>			
PoE Standard	IEEE 802.3af and IEEE 802.3at		
PoE Capable Ports	• Ports 1 to 8: Up to 30 W	• Ports 1 to 4: Up to 30 W • Ports 5 to 24: Up to 15.4 W	• Ports 1 to 8: Up to 30 W • Ports 9 to 48: Up to 15.4 W
PoE Power Budget	Max. 78 W	Max. 193 W	Max. 370 W



Physical & Environment			
AC Input	100 to 240 VAC 50/60Hz internal power supply		
Maximum Power Consumption	103.4 W (PoE on), 17.9 W (PoE off)	251.3 W (PoE on), 21.9 W (PoE off)	483.1 W (PoE on), 48.9 W (PoE off)
Standby Power Consumption	10.3 W/110V, 11.1 W/240V	24 W/110V, 21.9 W/240V	29.5 W/110V, 27.5 W/240V
Fan Quantity	0	Two smart fans	Three smart fans
Acoustics	0 dB(A)	Low speed: 47 dB(A) High speed: 52.4 dB(A)	Low speed: 40.4 dB(A) High speed: 50.1 dB(A)
Heat Dissipation	352.63 BTU/hr	840.89 BTU/hr	1648.23 BTU/hr
Operating Temperature	23 to 122 °F (-5 to 50 °C)		
Storage Temperature	-4 to 158 °F (-20 to 70 °C)		
Operating Humidity	0% to 95% non-condensing		
Storage Humidity	0% to 95% non-condensing		
Dimensions	• 11.02 x 7.08 x 1.73 inches (280 x 180 x 44 mm) • 19" standard rack mounting width, 1U height	• 17.32 x 8.27 x 1.73 inches (440 x 210 x 44 mm) • 19" standard rack mounting width, 1U height	• 17.32 x 16.9 x 1.73 inches (440 x 430 x 44 mm) • 19" standard rack mounting width, 1U height
Weight	3.1 lbs (1.41 kg)	5.60 lbs (2.54 kg)	12.74 lbs (5.78 kg)
Diagnostic LEDs	<ul style="list-style-type: none"> <li>• Power (per device)</li> <li>• PoE Max (per Device)</li> <li>• Link/Activity/Speed (per 10/100/1000Base-T port)</li> <li>• Link/Activity/Speed (per SFP port)</li> <li>• Fan (per device)</li> <li>• Button to switch LED display mode between PoE and Link/Activity</li> </ul>		
MTBF	315,336 hours	239,236 hours	318,616 hours
Certifications	<ul style="list-style-type: none"> <li>• FCC Class A</li> <li>• CE Class A</li> <li>• ICES-003</li> <li>• VCCI Class A</li> <li>• C-Tick</li> <li>• BSMI</li> </ul>		
Safety	<ul style="list-style-type: none"> <li>• cUL</li> <li>• CE LVD</li> </ul>		

Software Features		
L2 Features	<ul style="list-style-type: none"> <li>• MAC Address Table               <ul style="list-style-type: none"> <li>• 16K entries</li> </ul> </li> <li>• IGMP Snooping               <ul style="list-style-type: none"> <li>• IGMP v1/v2 Snooping</li> <li>• Supports 256 IGMP groups</li> <li>• Supports at least 64 static multicast addresses</li> <li>• IGMP per VLAN</li> <li>• Supports IGMP Snooping Querier</li> </ul> </li> <li>• Loopback Detection</li> <li>• 802.3ad Link Aggregation:               <ul style="list-style-type: none"> <li>• DGS-1210 28/28P: Maximum of 14 groups/8 ports per group</li> <li>• DGS-1210 52/52MP: Maximum of 26 groups/8 ports per group</li> <li>• DGS-1210 -10/10P: Maximum of 5 groups/8 ports per group</li> </ul> </li> <li>• LLDP</li> <li>• LLDP-MED</li> <li>• Jumbo Frame               <ul style="list-style-type: none"> <li>• Up to 9,216 bytes</li> </ul> </li> </ul>	<ul style="list-style-type: none"> <li>• Spanning Tree Protocol               <ul style="list-style-type: none"> <li>• 802.1D STP</li> <li>• 802.1w RSTP</li> </ul> </li> <li>• Flow Control               <ul style="list-style-type: none"> <li>• 802.3x Flow Control</li> </ul> </li> <li>• HOL Blocking Prevention</li> <li>• Port Mirroring               <ul style="list-style-type: none"> <li>• One-to-One</li> <li>• Many-to-One</li> </ul> </li> <li>• Supports Mirroring for Tx/Rx/Both</li> <li>• Multicast Filtering               <ul style="list-style-type: none"> <li>• Forwards all unregistered groups</li> <li>• Filters all unregistered groups</li> </ul> </li> <li>• Configurable MDI/MDIX               <ul style="list-style-type: none"> <li>• MLD snooping v1/v2 (256 groups)</li> </ul> </li> </ul>
VLAN	<ul style="list-style-type: none"> <li>• 802.1Q</li> <li>• VLAN Group               <ul style="list-style-type: none"> <li>• Max. 256 static VLAN groups</li> </ul> </li> <li>• Configurable VID from 1 - 4094</li> <li>• Asymmetric VLAN</li> </ul>	<ul style="list-style-type: none"> <li>• Auto Voice VLAN               <ul style="list-style-type: none"> <li>• Max. 10 user-defined OUI</li> <li>• Max. 8 default OUI</li> </ul> </li> <li>• Auto Surveillance VLAN</li> </ul>
QoS (Quality of Service)	<ul style="list-style-type: none"> <li>• 802.1p Quality of Service</li> <li>• 8 queues per port</li> <li>• Queue Handling               <ul style="list-style-type: none"> <li>• Strict</li> <li>• Weighted Round Robin (WRR)</li> </ul> </li> <li>• Bandwidth Control               <ul style="list-style-type: none"> <li>• Port-based (Ingress/Egress, min granularity 10/100/1000 is 64 Kbps)</li> </ul> </li> </ul>	<ul style="list-style-type: none"> <li>• QoS based on:               <ul style="list-style-type: none"> <li>• 802.1p Priority Queues</li> <li>• DSCP</li> <li>• ToS</li> <li>• IPv6 Traffic Class</li> <li>• TCP/UDP port</li> </ul> </li> </ul>
L3 Features	<ul style="list-style-type: none"> <li>• IP Interface               <ul style="list-style-type: none"> <li>• Supports 1 interface</li> </ul> </li> </ul>	<ul style="list-style-type: none"> <li>• IPv6 Neighbor Discovery (ND)</li> </ul>
Access Control List (ACL)	<ul style="list-style-type: none"> <li>• Max. 50 access list</li> <li>• Max. 768 rules shared by IPv4, MAC and IPv6</li> <li>• Each rule can only be associated with a single port</li> <li>• ACL based on               <ul style="list-style-type: none"> <li>• 802.1p priority</li> <li>• VLAN</li> <li>• MAC address</li> </ul> </li> </ul>	<ul style="list-style-type: none"> <li>• Ether type</li> <li>• IP address</li> <li>• DSCP</li> <li>• Protocol type</li> <li>• TCP/UDP port number</li> <li>• IPv6 Traffic Class</li> </ul>
Security	<ul style="list-style-type: none"> <li>• Broadcast/Multicast/Unicast Storm Control</li> <li>• D-Link Safeguard Engine</li> <li>• DHCP Server Screening</li> <li>• IP-MAC-Port Binding (Smart Binding)               <ul style="list-style-type: none"> <li>• Supports 512 address binding entries</li> </ul> </li> <li>• ARP Inspection               <ul style="list-style-type: none"> <li>• ARP + IP Inspection</li> </ul> </li> <li>• Supports DHCP Snooping</li> <li>• 802.1X Port-based Access Control</li> </ul>	<ul style="list-style-type: none"> <li>• ARP Spoofing Prevention               <ul style="list-style-type: none"> <li>• Max. 64 entries</li> </ul> </li> <li>• Traffic Segmentation</li> <li>• SSH v2</li> <li>• SSL               <ul style="list-style-type: none"> <li>• Supports v1/v2/v3</li> </ul> </li> <li>• Port Security               <ul style="list-style-type: none"> <li>• Supports up to 64 MAC addresses per port</li> </ul> </li> <li>• Duplicate address detection</li> </ul>
AAA	<ul style="list-style-type: none"> <li>• 802.1X Authentication               <ul style="list-style-type: none"> <li>• Supports local/RADIUS database</li> <li>• Supports port-based access control</li> <li>• Supports EAP, OTP, TLS, TTLS, PEAP</li> </ul> </li> </ul>	<ul style="list-style-type: none"> <li>• IPv6 RADIUS Server</li> <li>• Support MD5 authentication</li> </ul>

<b>MIB/RFC Standards</b>	<ul style="list-style-type: none"> <li>• RFC 783 TFTP</li> <li>• RFC 951 BootP/DHCP Client</li> <li>• RFC 1157 SNMP v1, v2, v3</li> <li>• RFC 1213 MIB II</li> <li>• RFC 1215 MIB Traps Convention</li> <li>• RFC 1350 TFTP</li> <li>• RFC 1493 Bridge MIB</li> <li>• RFC 1769 SNMP</li> <li>• RFC 1542 BootP/DHCP Client</li> <li>• RFC 1901 SNMP v1, v2, v3</li> <li>• RFC 1907 SNMP v2 MIB</li> <li>• RFC 1908 SNMP v1, v2, v3</li> <li>• RFC 2131 BootP/DHCP Client</li> <li>• RFC 2138 RADIUS Authentication</li> <li>• RFC 2139 RADIUS Authentication</li> <li>• RFC 2233 Interface Group MIB</li> </ul>	<ul style="list-style-type: none"> <li>• RFC-2246 SSL</li> <li>• RFC 2475</li> <li>• RFC 2570 SNMP v1, v2, v3</li> <li>• RFC 2575 SNMP v1, v2, v3</li> <li>• RFC 2598 CoS</li> <li>• RFC 2618 RADIUS Authentication</li> <li>• RFC 2819 RMON v1</li> <li>• RFC 2865 RADIUS Authentication</li> <li>• RFC 3164 System Log</li> <li>• RFC 3195 System Log</li> <li>• RFC 3411-17 SNMP</li> <li>• D-Link Private MIB</li> <li>• LLDP MIB</li> <li>• Zone Defense MIB</li> <li>• 2233 Interface Group MIB</li> </ul>
<b>OAM</b>	<ul style="list-style-type: none"> <li>• Cable Diagnostics</li> </ul>	<ul style="list-style-type: none"> <li>• Factory Reset</li> </ul>
<b>Management</b>	<ul style="list-style-type: none"> <li>• Web-based GUI</li> <li>• D-Link Network Assistant Utility</li> <li>• Compact CLI</li> <li>• Telnet Server</li> <li>• TFTP Client</li> <li>• Configurable MDI/MDIX</li> <li>• SNMP               <ul style="list-style-type: none"> <li>• Supports v1/v2c/v3</li> </ul> </li> <li>• SNMP Trap</li> <li>• Backup/Upgrade firmware</li> <li>• Smart Wizard</li> <li>• Upload/Download Configuration file</li> </ul>	<ul style="list-style-type: none"> <li>• System Log               <ul style="list-style-type: none"> <li>• Max. 500 log entries</li> </ul> </li> <li>• BootP/DHCP Client</li> <li>• SNMP</li> <li>• ICMP v6</li> <li>• IPv4/v6 Dual Stack</li> <li>• DHCP Auto Configuration</li> <li>• Time Setting               <ul style="list-style-type: none"> <li>• SNTP</li> </ul> </li> <li>• RMONv1</li> <li>• Trusted Host</li> </ul>
<b>D-Link Green 3.0 Technology</b>	<ul style="list-style-type: none"> <li>• Power Saving by:               <ul style="list-style-type: none"> <li>• Link Status</li> <li>• Time-based PoE: PoE ports can be turned on/off by port or system through schedule</li> </ul> </li> </ul>	<ul style="list-style-type: none"> <li>• LED Shutoff</li> <li>• System Hibernation</li> <li>• Port Shutoff</li> </ul>

## DGS-1210-Series Web Smart Switch

Warranty Information	
Warranty	Limited Lifetime <sup>1</sup>
Ordering Information	
Part Number	Description
DGS-1210-10	10-Port Gigabit Web Smart Switch including 2 Gigabit SFP ports
DGS-1210-10P	10-Port Gigabit Web Smart PoE+ Switch including 2 Gigabit SFP ports
DGS-1210-20	20-Port Gigabit Web Smart Switch including 4 Gigabit SFP ports
DGS-1210-28	28-Port Gigabit Web Smart Switch including 4 Gigabit SFP ports
DGS-1210-28P	28-Port Gigabit Web Smart PoE+ Switch including 4 Gigabit SFP ports
DGS-1210-52	52-Port Gigabit Web Smart Switch including 4 Gigabit SFP ports
DGS-1210-52MP	52-Port Gigabit Web Smart PoE+ Switch including 4 Gigabit SFP ports
Optional SFP Transceivers	
DGS-712	1000BASE-T Copper SFP Transceiver
DEM-310GT	1000BASE-LX Single-mode, SFP Transceiver up to 10 km
DEM-311GT	1000BASE-SX Multi-mode, SFP Transceiver up to 550 km
Optional Software	
DV-600S	D-View 6.0 Network Management System (Standard Edition)
DV-600P	D-View 6.0 Network Management System (Professional Edition)

<sup>1</sup> Limited lifetime warranty available only in the U.S.A.

Last updated: 01/29/2015 Hardware REV C.

U.S.A. | 17595 Mt. Herrmann Street | Fountain Valley, CA 92708 | 800.326.1688 | [dlink.com](http://dlink.com)

©2015 D-Link Corporation/D-Link Systems, Inc. All rights reserved. D-Link and the D-Link logo are registered trademarks of D-Link Corporation or its subsidiaries in the United States and/or other countries. Other trademarks or registered trademarks are the property of their respective owners.

Visit [www.dlink.com](http://www.dlink.com) for more details.

**D-Link**<sup>®</sup>  
Building Networks for People



### Features:

- + Small Form-factor Pluggable (SFP)
- + IEEE 802.3u 100Base-FX Standard
- + 2km Multi-mode Fiber
- + Hot-Swappable
- + FDA, CDRH, TUV Laser Eye Safety Certified
- + 200Mbps Full Duplex Data Transfer Rate

## 100BASE-FX Multimode LC SFP Transceiver, Up to 2km

### Overview

D-Link's DEM-211 100BASE-FX Multimode LC SFP Transceiver provides a high performance solution for serial optical data communication applications. The DEM-211 has a duplex LC connector and provides an IEEE 802.3u compliant link for up to 100Mbps in half duplex mode (200Mbps full-duplex mode) for fiber cable applications.

without degradation. The high performance DEM-211 enables reliable data transfer in short, intermediate, and long distances for building, factory, campus, and metropolitan networking applications. When two switches are connected together using a DEM-211 transceiver on both ends, link speeds of up to 155Mbps can be attained. The DEM-211 allows you to provide 100BASE-FX SFP fiber optic connectivity on Gigabit combo SFP ports for D-Link switches<sup>1</sup>.

D-Link's highly integrated transceivers offer low jitter performance for extended optical link support

## Technical Specifications

### Product/Performance Specifications

Compatible with	DES-1228, DES-1228P, DES-3252P, DES-3228PA, DES-1252, DGS-3612G
Capacity	100Mbps half-duplex (200Mbps full-duplex)
Fiber Type	62.5/125um Multi-mode
Maximum Cable Distance	2km
Wave Length	1310nm

### Network Protocols & Standards

IEEE	802.3u 100BASE-FX
Emissions	FCC Class B, CE, ICES-003, VCCI
Safety	FDA/CDRH, TUV, UL, RoHS

### Physical & Environmental

Dimensions (L x W x H)	0.5in x 2.28in x 0.3in
Weight	0.03lbs
Temperature	Operating: 32°F to 158°F (0°C to 70°C) Storage: -40°F to 185°F (-40°C to 85°C)
Humidity	Operating: 10% to 90% Non-condensing Storage: 5% to 90% Non-condensing
Power Budget	13dB
Power Voltage	3.3V
Output Optical Power	Max.-14dBm, Min.-19dBm

### Warranty

Warranty	2-Year Limited
----------	----------------

<sup>1</sup>This transceiver connects with supported compatible switches including the DES-1228, DES-1228P, DES-3252P, DES-3228PA, DES-1252, and DGS-3612G. Please visit [support.dlink.com](http://support.dlink.com) for an updated list of compatible D-Link devices.