



Purchasing Division  
 2019 Washington Street East  
 Post Office Box 50130  
 Charleston, WV 25305-0130

State of West Virginia  
 Request for Quotation  
 13 – Equipment

Proc Folder: 133732

Doc Description: ADDENDUM NO. 1 - VENDOR QUESTIONS AND EXTEND BID OPENING

Proc Type: Central Master Agreement

Date Issued	Solicitation Closes	Solicitation No	Version
2015-09-14	2015-09-22 13:30:00	CRFQ 0803 DOT1600000015	2

**BID RECEIVING LOCATION**

BID CLERK  
 DEPARTMENT OF ADMINISTRATION  
 PURCHASING DIVISION  
 2019 WASHINGTON ST E  
 CHARLESTON WV 25305  
 US

**VENDOR**

Vendor Name, Address and Telephone Number:

09/22/15 12:49:30  
 WV Purchasing Division

**FOR INFORMATION CONTACT THE BUYER**

Sheila L Hannah  
 (304) 558-4317  
 sheila.l.hannah@wv.gov

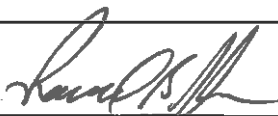
Signature X  FEIN # 61044-5955 DATE 9/22/15

All offers subject to all terms and conditions contained in this solicitation

INVOICE TO		SHIP TO	
DIVISION OF HIGHWAYS EQUIPMENT DIVISION RT 33 83 BRUSHY FORK RD CROSSING BUCKHANNON WV26201 US		DIVISION OF HIGHWAYS EQUIPMENT DIVISION 33 BRUSHY FORK RD CROSSING BUCKHANNON WV 26201 US	

Line	Comm Ln Desc	Qty	Unit Issue	Unit Price	Total Price
1	CLASS 591 - DOUBLE DRUM VIBRATORY ROLLER/COMPACTOR	10.00000	EA	\$31,594	\$315,940.00

Comm Code	Manufacturer	Specification	Model #
24101723	VOLVO	VIBRATORY ROLLER/COMPACTOR	DD25B

**Extended Description :**

CLASS 591 - DOUBLE DRUM VIBRATORY ROLLER/COMPACTOR

<b>DOT1600000015</b>	<b>Document Phase</b> Final	<b>Document Description</b> ADDENDUM NO. 1 - VENDOR QUESTI ONS AND EXTEND BID OPENING	<b>Page 3</b> <b>of 3</b>
----------------------	--------------------------------	---	------------------------------

**ADDITIONAL TERMS AND CONDITIONS**

See attached document(s) for additional Terms and Conditions

## INSTRUCTIONS TO VENDORS SUBMITTING BIDS

1. **REVIEW DOCUMENTS THOROUGHLY:** The attached documents contain a solicitation for bids. Please read these instructions and all documents attached in their entirety. These instructions provide critical information about requirements that if overlooked could lead to disqualification of a Vendor's bid. All bids must be submitted in accordance with the provisions contained in these instructions and the Solicitation. Failure to do so may result in disqualification of Vendor's bid.
2. **MANDATORY TERMS:** The Solicitation may contain mandatory provisions identified by the use of the words "must," "will," and "shall." Failure to comply with a mandatory term in the Solicitation will result in bid disqualification.
3. **PREBID MEETING:** The item identified below shall apply to this Solicitation.

A pre-bid meeting will not be held prior to bid opening.

A **NON-MANDATORY PRE-BID** meeting will be held at the following place and time:

A **MANDATORY PRE-BID** meeting will be held at the following place and time:

August 26, 2015 at 10:30 am  
WV division of Highways  
Equipment Division  
83 Brushy Fork Rd Crossing  
Buckhannon, WV 26201

All Vendors submitting a bid must attend the mandatory pre-bid meeting. Failure to attend the mandatory pre-bid meeting shall result in disqualification of the Vendor's bid. No one person attending the pre-bid meeting may represent more than one Vendor.

An attendance sheet provided at the pre-bid meeting shall serve as the official document verifying attendance. The State will not accept any other form of proof or documentation to verify attendance. Any person attending the pre-bid meeting on behalf of a Vendor must list on the attendance sheet his or her name and the name of the Vendor he or she is representing. Additionally, the person attending the pre-bid meeting should include the Vendor's E-Mail address, phone number, and Fax number on the attendance sheet. It is the Vendor's responsibility to locate the attendance sheet and provide the required information. Failure to complete the attendance sheet as required may result in disqualification of Vendor's bid.

All Vendors should arrive prior to the starting time for the pre-bid. Vendors who arrive after the starting time but prior to the end of the pre-bid will be permitted to sign in, but are charged with knowing all matters discussed at the pre-bid.

Questions submitted at least five business days prior to a scheduled pre-bid will be discussed at the pre-bid meeting if possible. Any discussions or answers to questions at the pre-bid meeting are preliminary in nature and are non-binding. Official and binding answers to questions will be published in a written addendum to the Solicitation prior to bid opening.

4. **VENDOR QUESTION DEADLINE:** Vendors may submit questions relating to this Solicitation to the Purchasing Division. Questions must be submitted in writing. All questions must be submitted on or before the date listed below and to the address listed below in order to be considered. A written response will be published in a Solicitation addendum if a response is possible and appropriate. Non-written discussions, conversations, or questions and answers regarding this Solicitation are preliminary in nature and are non-binding. Submitted e-mails should have solicitation number in the subject line.

Question Submission Deadline: September 2, 2015

Submit Questions to: Sheila L. Hannah  
2019 Washington Street, East  
Charleston, WV 25305  
Fax: (304) 558-4115 (Vendors should not use this fax number for bid submission)  
Email: sheila.l.hannah@wv.gov

5. **VERBAL COMMUNICATION:** Any verbal communication between the Vendor and any State personnel is not binding, including verbal communication at the mandatory pre-bid conference. Only information issued in writing and added to the Solicitation by an official written addendum by the Purchasing Division is binding.
6. **BID SUBMISSION:** All bids must be submitted electronically through wvOASIS or signed and delivered by the Vendor to the Purchasing Division at the address listed below on or before the date and time of the bid opening. Any bid received by the Purchasing Division staff is considered to be in the possession of the Purchasing Division and will not be returned for any reason. The Purchasing Division will not accept bids, modification of bids, or addendum acknowledgment forms via e-mail. Acceptable delivery methods include electronic submission via wvOASIS, hand delivery, delivery by courier, or facsimile. The bid delivery address is:

Department of Administration, Purchasing Division  
2019 Washington Street East  
Charleston, WV 25305-0130

A bid that is not submitted electronically through wvOASIS should contain the information listed below on the face of the envelope or the bid may be rejected by the Purchasing Division.:

**SEALED BID:**

**BUYER:** Shella L. Hannah

**SOLICITATION NO.:** CRFQ DOT1600000015

**BID OPENING DATE:** September 16, 2015

**BID OPENING TIME:** 1:30 PM, EST

**FAX NUMBER:** 304-558-3970

In the event that Vendor is responding to a request for proposal, and chooses to respond in a manner other than by electronic submission through wvOASIS, the Vendor shall submit one original technical and one original cost proposal plus convenience copies of each to the Purchasing Division at the address shown above. Additionally, if Vendor does not submit its bid through wvOASIS, the Vendor should identify the bid type as either a technical or cost proposal on the face of each bid envelope submitted in response to a request for proposal as follows:

**BID TYPE:** (This only applies to CRFP)

Technical

Cost

- BID OPENING:** Bids submitted in response to this Solicitation will be opened at the location identified below on the date and time listed below. Delivery of a bid after the bid opening date and time will result in bid disqualification. For purposes of this Solicitation, a bid is considered delivered when confirmation of delivery is provided by wvOASIS (in the case of electronic submission) or when the bid is time stamped by the official Purchasing Division time clock (in the case of hand delivery).

**Bid Opening Date and Time:** September 16, 2015 1:30 PM EST  
**Bid Opening Location:** Department of Administration, Purchasing Division  
2019 Washington Street East  
Charleston, WV 25305-0130

- ADDENDUM ACKNOWLEDGEMENT:** Changes or revisions to this Solicitation will be made by an official written addendum issued by the Purchasing Division. Vendor should acknowledge receipt of all addenda issued with this Solicitation by completing an Addendum Acknowledgment Form, a copy of which is included herewith. Failure to acknowledge addenda may result in bid disqualification. The addendum acknowledgement should be submitted with the bid to expedite document processing.

9. **BID FORMATTING:** Vendor should type or electronically enter the information onto its bid to prevent errors in the evaluation. Failure to type or electronically enter the information may result in bid disqualification.
10. **ALTERNATES:** Any model, brand, or specification listed in this Solicitation establishes the acceptable level of quality only and is not intended to reflect a preference for, or in any way favor, a particular brand or vendor. Vendors may bid alternates to a listed model or brand provided that the alternate is at least equal to the model or brand and complies with the required specifications. The equality of any alternate being bid shall be determined by the State at its sole discretion. Any Vendor bidding an alternate model or brand should clearly identify the alternate items in its bid and should include manufacturer's specifications, industry literature, and/or any other relevant documentation demonstrating the equality of the alternate items. Failure to provide information for alternate items may be grounds for rejection of a Vendor's bid.
11. **EXCEPTIONS AND CLARIFICATIONS:** The Solicitation contains the specifications that shall form the basis of a contractual agreement. Vendor shall clearly mark any exceptions, clarifications, or other proposed modifications in its bid. Exceptions to, clarifications of, or modifications of a requirement or term and condition of the Solicitation may result in bid disqualification.
12. **COMMUNICATION LIMITATIONS:** In accordance with West Virginia Code of State Rules §148-1-6.6, communication with the State of West Virginia or any of its employees regarding this Solicitation during the solicitation, bid, evaluation or award periods, except through the Purchasing Division, is strictly prohibited without prior Purchasing Division approval. Purchasing Division approval for such communication is implied for all agency delegated and exempt purchases.
13. **REGISTRATION:** Prior to Contract award, the apparent successful Vendor must be properly registered with the West Virginia Purchasing Division and must have paid the \$125 fee, if applicable.
14. **UNIT PRICE:** Unit prices shall prevail in cases of a discrepancy in the Vendor's bid.
15. **PREFERENCE:** Vendor Preference may only be granted upon written request and only in accordance with the West Virginia Code § 5A-3-37 and the West Virginia Code of State Rules. A Vendor Preference Certificate form has been attached hereto to allow Vendor to apply for the preference. Vendor's failure to submit the Vendor Preference Certificate form with its bid will result in denial of Vendor Preference. Vendor Preference does not apply to construction projects.
16. **SMALL, WOMEN-OWNED, OR MINORITY-OWNED BUSINESSES:** For any solicitations publicly advertised for bid, in accordance with West Virginia Code §5A-3-37(a)(7) and W. Va. CSR § 148-22-9, any non-resident vendor certified as a small, women-owned, or minority-owned business under W. Va. CSR § 148-22-9 shall be provided the

same preference made available to any resident vendor. Any non-resident small, women-owned, or minority-owned business must identify itself as such in writing, must submit that writing to the Purchasing Division with its bid, and must be properly certified under W. Va. CSR § 148-22-9 prior to contract award to receive the preferences made available to resident vendors. Preference for a non-resident small, women-owned, or minority owned business shall be applied in accordance with W. Va. CSR § 148-22-9.

**17. WAIVER OF MINOR IRREGULARITIES:** The Director reserves the right to waive minor irregularities in bids or specifications in accordance with West Virginia Code of State Rules § 148-1-4.6.

**18. ELECTRONIC FILE ACCESS RESTRICTIONS:** Vendor must ensure that its submission in wvOASIS can be accessed by the Purchasing Division staff immediately upon bid opening. The Purchasing Division will consider any file that cannot be immediately opened and/or viewed at the time of the bid opening (such as, encrypted files, password protected files, or incompatible files) to be blank or incomplete as context requires, and are therefore unacceptable. A vendor will not be permitted to unencrypt files, remove password protections, or resubmit documents after bid opening if those documents are required with the bid.



## GENERAL TERMS AND CONDITIONS:

1. **CONTRACTUAL AGREEMENT:** Issuance of a Award Document signed by the Purchasing Division Director, or his designee, and approved as to form by the Attorney General's office constitutes acceptance of this Contract made by and between the State of West Virginia and the Vendor. Vendor's signature on its bid signifies Vendor's agreement to be bound by and accept the terms and conditions contained in this Contract.
  
2. **DEFINITIONS:** As used in this Solicitation/Contract, the following terms shall have the meanings attributed to them below. Additional definitions may be found in the specifications included with this Solicitation/Contract.
  - 2.1. **"Agency" or "Agencies"** means the agency, board, commission, or other entity of the State of West Virginia that is identified on the first page of the Solicitation or any other public entity seeking to procure goods or services under this Contract.
  - 2.2. **"Contract"** means the binding agreement that is entered into between the State and the Vendor to provide the goods or services requested in the Solicitation.
  - 2.3. **"Director"** means the Director of the West Virginia Department of Administration, Purchasing Division.
  - 2.4. **"Purchasing Division"** means the West Virginia Department of Administration, Purchasing Division.
  - 2.5. **"Award Document"** means the document signed by the Agency and the Purchasing Division, and approved as to form by the Attorney General, that identifies the Vendor as the contract holder.
  - 2.6. **"Solicitation"** means the official notice of an opportunity to supply the State with goods or services that is published by the Purchasing Division.
  - 2.7. **"State"** means the State of West Virginia and/or any of its agencies, commissions, boards, etc. as context requires.
  - 2.8. **"Vendor" or "Vendors"** means any entity submitting a bid in response to the Solicitation, the entity that has been selected as the lowest responsible bidder, or the entity that has been awarded the Contract as context requires.

3. **CONTRACT TERM; RENEWAL; EXTENSION:** The term of this Contract shall be determined in accordance with the category that has been identified as applicable to this Contract below:

**Term Contract**

**Initial Contract Term:** This Contract becomes effective on Award and extends for a period of 1 year(s).

**Renewal Term:** This Contract may be renewed upon the mutual written consent of the Agency, and the Vendor, with approval of the Purchasing Division and the Attorney General's office (Attorney General approval is as to form only). Any request for renewal should be submitted to the Purchasing Division thirty (30) days prior to the expiration date of the initial contract term or appropriate renewal term. A Contract renewal shall be in accordance with the terms and conditions of the original contract. Renewal of this Contract is limited to <sup>3</sup> successive one (1) year periods or multiple renewal periods of less than one year, provided that the multiple renewal periods do not exceed <sup>36</sup> months in total. Automatic renewal of this Contract is prohibited. Notwithstanding the foregoing, Purchasing Division approval is not required on agency delegated or exempt purchases. Attorney General approval may be required for vendor terms and conditions.

**Delivery Order Limitations:** In the event that this contract permits delivery orders, a delivery order may only be issued during the time this Contract is in effect. Any delivery order issued within one year of the expiration of this Contract shall be effective for one year from the date the delivery order is issued. No delivery order may be extended beyond one year after this Contract has expired.

**Fixed Period Contract:** This Contract becomes effective upon Vendor's receipt of the notice to proceed and must be completed within \_\_\_\_\_ days.

**Fixed Period Contract with Renewals:** This Contract becomes effective upon Vendor's receipt of the notice to proceed and part of the Contract more fully described in the attached specifications must be completed within \_\_\_\_\_ days. Upon completion, the vendor agrees that maintenance, monitoring, or warranty services will be provided for one year thereafter with an additional \_\_\_\_\_ successive one year renewal periods or multiple renewal periods of less than one year provided that the multiple renewal periods do not exceed \_\_\_\_\_ months in total. Automatic renewal of this Contract is prohibited.

**One Time Purchase:** The term of this Contract shall run from the issuance of the Award Document until all of the goods contracted for have been delivered, but in no event will this Contract extend for more than one fiscal year.

**Other:** See attached.

4. **NOTICE TO PROCEED:** Vendor shall begin performance of this Contract immediately upon receiving notice to proceed unless otherwise instructed by the Agency. Unless otherwise specified, the fully executed Award Document will be considered notice to proceed.
5. **QUANTITIES:** The quantities required under this Contract shall be determined in accordance with the category that has been identified as applicable to this Contract below.
- Open End Contract:** Quantities listed in this Solicitation are approximations only, based on estimates supplied by the Agency. It is understood and agreed that the Contract shall cover the quantities actually ordered for delivery during the term of the Contract, whether more or less than the quantities shown.
- Service:** The scope of the service to be provided will be more clearly defined in the specifications included herewith.
- Combined Service and Goods:** The scope of the service and deliverable goods to be provided will be more clearly defined in the specifications included herewith.
- One Time Purchase:** This Contract is for the purchase of a set quantity of goods that are identified in the specifications included herewith. Once those items have been delivered, no additional goods may be procured under this Contract without an appropriate change order approved by the Vendor, Agency, Purchasing Division, and Attorney General's office.
6. **PRICING:** The pricing set forth herein is firm for the life of the Contract, unless specified elsewhere within this Solicitation/Contract by the State. A Vendor's inclusion of price adjustment provisions in its bid, without an express authorization from the State in the Solicitation to do so, may result in bid disqualification.
7. **EMERGENCY PURCHASES:** The Purchasing Division Director may authorize the Agency to purchase goods or services in the open market that Vendor would otherwise provide under this Contract if those goods or services are for immediate or expedited delivery in an emergency. Emergencies shall include, but are not limited to, delays in transportation or an unanticipated increase in the volume of work. An emergency purchase in the open market, approved by the Purchasing Division Director, shall not constitute a breach of this Contract and shall not entitle the Vendor to any form of compensation or damages. This provision does not excuse the State from fulfilling its obligations under a One Time Purchase contract.
8. **REQUIRED DOCUMENTS:** All of the items checked below must be provided to the Purchasing Division by the Vendor as specified below.

**BID BOND:** All Vendors shall furnish a bid bond in the amount of five percent (5%) of the total amount of the bid protecting the State of West Virginia. The bid bond must be submitted with the bid.

**PERFORMANCE BOND:** The apparent successful Vendor shall provide a performance bond in the amount of \_\_\_\_\_. The performance bond must be received by the Purchasing Division prior to Contract award. On construction contracts, the performance bond must be 100% of the Contract value.

**LABOR/MATERIAL PAYMENT BOND:** The apparent successful Vendor shall provide a labor/material payment bond in the amount of 100% of the Contract value. The labor/material payment bond must be delivered to the Purchasing Division prior to Contract award.

In lieu of the Bid Bond, Performance Bond, and Labor/Material Payment Bond, the Vendor may provide certified checks, cashier's checks, or irrevocable letters of credit. Any certified check, cashier's check, or irrevocable letter of credit provided in lieu of a bond must be of the same amount and delivered on the same schedule as the bond it replaces. A letter of credit submitted in lieu of a performance and labor/material payment bond will only be allowed for projects under \$100,000. Personal or business checks are not acceptable.

**MAINTENANCE BOND:** The apparent successful Vendor shall provide a two (2) year maintenance bond covering the roofing system. The maintenance bond must be issued and delivered to the Purchasing Division prior to Contract award.

**INSURANCE:** The apparent successful Vendor shall furnish proof of the following insurance prior to Contract award and shall list the state as a certificate holder:

**Commercial General Liability Insurance:** In the amount of \_\_\_\_\_ or more.

**Builders Risk Insurance:** In an amount equal to 100% of the amount of the Contract.

The apparent successful Vendor shall also furnish proof of any additional insurance requirements contained in the specifications prior to Contract award regardless of whether or not that insurance requirement is listed above.

**LICENSE(S) / CERTIFICATIONS / PERMITS:** In addition to anything required under the Section entitled Licensing, of the General Terms and Conditions, the apparent successful Vendor shall furnish proof of the following licenses, certifications, and/or permits prior to Contract award, in a form acceptable to the Purchasing Division.

The apparent successful Vendor shall also furnish proof of any additional licenses or certifications contained in the specifications prior to Contract award regardless of whether or not that requirement is listed above.

**9. WORKERS' COMPENSATION INSURANCE:** The apparent successful Vendor shall comply with laws relating to workers compensation, shall maintain workers' compensation insurance when required, and shall furnish proof of workers' compensation insurance upon request.

**10. LITIGATION BOND:** The Director reserves the right to require any Vendor that files a protest of an award to submit a litigation bond in the amount equal to one percent of the lowest bid submitted or \$5,000, whichever is greater. The entire amount of the bond shall be forfeited if the hearing officer determines that the protest was filed for frivolous or improper purpose, including but not limited to, the purpose of harassing, causing unnecessary delay, or needless expense for the Agency. All litigation bonds shall be made payable to the Purchasing Division. In lieu of a bond, the protester may submit a cashier's check or certified check payable to the Purchasing Division. Cashier's or certified checks will be deposited with and held by the State Treasurer's office. If it is determined that the protest has not been filed for frivolous or improper purpose, the bond or deposit shall be returned in its entirety.

**11. LIQUIDATED DAMAGES:** Vendor shall pay liquidated damages in the amount of \_\_\_\_\_ for \_\_\_\_\_.  
This clause shall in no way be considered exclusive and shall not limit the State or Agency's right to pursue any other available remedy.

- 12. ACCEPTANCE/REJECTION:** The State may accept or reject any bid in whole, or in part. Vendor's signature on its bid signifies acceptance of the terms and conditions contained in the Solicitation and Vendor agrees to be bound by the terms of the Contract, as reflected in the Award Document, upon receipt.
- 13. FUNDING:** This Contract shall continue for the term stated herein, contingent upon funds being appropriated by the Legislature or otherwise being made available. In the event funds are not appropriated or otherwise made available, this Contract becomes void and of no effect beginning on July 1 of the fiscal year for which funding has not been appropriated or otherwise made available.
- 14. PAYMENT:** Payment in advance is prohibited under this Contract. Payment may only be made after the delivery and acceptance of goods or services. The Vendor shall submit invoices, in arrears.
- 15. TAXES:** The Vendor shall pay any applicable sales, use, personal property or any other taxes arising out of this Contract and the transactions contemplated thereby. The State of West Virginia is exempt from federal and state taxes and will not pay or reimburse such taxes.
- 16. CANCELLATION:** The Purchasing Division Director reserves the right to cancel this Contract immediately upon written notice to the vendor if the materials or workmanship supplied do not conform to the specifications contained in the Contract. The Purchasing Division Director may also cancel any purchase or Contract upon 30 days written notice to the Vendor in accordance with West Virginia Code of State Rules § 148-1-7.16.2.
- 17. TIME:** Time is of the essence with regard to all matters of time and performance in this Contract.
- 18. APPLICABLE LAW:** This Contract is governed by and interpreted under West Virginia law without giving effect to its choice of law principles. Any information provided in specification manuals, or any other source, verbal or written, which contradicts or violates the West Virginia Constitution, West Virginia Code or West Virginia Code of State Rules is void and of no effect.
- 19. COMPLIANCE:** Vendor shall comply with all applicable federal, state, and local laws, regulations and ordinances. By submitting a bid, Vendor acknowledges that it has reviewed, understands, and will comply with all applicable law.
- 20. PREVAILING WAGE:** On any contract for the construction of a public improvement whose cost at the time the contract is awarded will be paid with public money in an amount greater than \$500,000. Vendor and any subcontractors utilized by Vendor shall pay a rate or rates of wages which shall not be less than the fair minimum rate or rates of wages (prevailing wage), as established under West Virginia Code §§ 21-5A-1 et seq. Vendor shall

be responsible for ensuring compliance with prevailing wage requirements and determining when prevailing wage requirements are applicable.

- 21. ARBITRATION:** Any references made to arbitration contained in this Contract, Vendor's bid, or in any American Institute of Architects documents pertaining to this Contract are hereby deleted, void, and of no effect.
- 22. MODIFICATIONS:** This writing is the parties' final expression of intent. Notwithstanding anything contained in this Contract to the contrary, no modification of this Contract shall be binding without mutual written consent of the Agency, and the Vendor, with approval of the Purchasing Division and the Attorney General's office (Attorney General approval is as to form only). No Change shall be implemented by the Vendor until such time as the Vendor receives an approved written change order from the Purchasing Division.
- 23. WAIVER:** The failure of either party to insist upon a strict performance of any of the terms or provision of this Contract, or to exercise any option, right, or remedy herein contained, shall not be construed as a waiver or a relinquishment for the future of such term, provision, option, right, or remedy, but the same shall continue in full force and effect. Any waiver must be expressly stated in writing and signed by the waiving party.
- 24. SUBSEQUENT FORMS:** The terms and conditions contained in this Contract shall supersede any and all subsequent terms and conditions which may appear on any form documents submitted by Vendor to the Agency or Purchasing Division such as price lists, order forms, invoices, sales agreements, or maintenance agreements, and includes internet websites or other electronic documents. Acceptance or use of Vendor's forms does not constitute acceptance of the terms and conditions contained thereon.
- 25. ASSIGNMENT:** Neither this Contract nor any monies due, or to become due hereunder, may be assigned by the Vendor without the express written consent of the Agency, the Purchasing Division, the Attorney General's office (as to form only), and any other government agency or office that may be required to approve such assignments. Notwithstanding the foregoing, Purchasing Division approval may or may not be required on certain agency delegated or exempt purchases.
- 26. WARRANTY:** The Vendor expressly warrants that the goods and/or services covered by this Contract will: (a) conform to the specifications, drawings, samples, or other description furnished or specified by the Agency; (b) be merchantable and fit for the purpose intended; and (c) be free from defect in material and workmanship.
- 27. STATE EMPLOYEES:** State employees are not permitted to utilize this Contract for personal use and the Vendor is prohibited from permitting or facilitating the same.
- 28. BANKRUPTCY:** In the event the Vendor files for bankruptcy protection, the State of West Virginia may deem this Contract null and void, and terminate this Contract without notice.

**29. CONFIDENTIALITY:** The Vendor agrees that it will not disclose to anyone, directly or indirectly, any such personally identifiable information or other confidential information gained from the Agency, unless the individual who is the subject of the information consents to the disclosure in writing or the disclosure is made pursuant to the Agency's policies, procedures, and rules. Vendor further agrees to comply with the Confidentiality Policies and Information Security Accountability Requirements, set forth in <http://www.state.wv.us/admin/purchase/privacy/default.html>.

**30. DISCLOSURE:** Vendor's response to the Solicitation and the resulting Contract are considered public documents and will be disclosed to the public in accordance with the laws, rules, and policies governing the West Virginia Purchasing Division. Those laws include, but are not limited to, the Freedom of Information Act found in West Virginia Code §§ 29B-1-1 et seq. and the competitive bidding laws found West Virginia Code §§ 5A-3-1 et seq., 5-22-1 et seq., and 5G-1-1 et seq.

If a Vendor considers any part of its bid to be exempt from public disclosure, Vendor must so indicate by specifically identifying the exempt information, identifying the exemption that applies, providing a detailed justification for the exemption, segregating the exempt information from the general bid information, and submitting the exempt information as part of its bid but in a segregated and clearly identifiable format. Failure to comply with the foregoing requirements will result in public disclosure of the Vendor's bid without further notice. A Vendor's act of marking all or nearly all of its bid as exempt is not sufficient to avoid disclosure and WILL NOT BE HONORED. Vendor's act of marking a bid or any part thereof as "confidential" or "proprietary" is not sufficient to avoid disclosure and WILL NOT BE HONORED. A legend or other statement indicating that all or substantially all of the bid is exempt from disclosure is not sufficient to avoid disclosure and WILL NOT BE HONORED. Additionally, pricing or cost information will not be considered exempt from disclosure and requests to withhold publication of pricing or cost information WILL NOT BE HONORED.

Vendor will be required to defend any claimed exemption for nondisclosure in the event of an administrative or judicial challenge to the State's nondisclosure. Vendor must indemnify the State for any costs incurred related to any exemptions claimed by Vendor. Any questions regarding the applicability of the various public records laws should be addressed to your own legal counsel prior to bid submission.

**31. LICENSING:** In accordance with West Virginia Code of State Rules §148-1-6.1.7, Vendor must be licensed and in good standing in accordance with any and all state and local laws and requirements by any state or local agency of West Virginia, including, but not limited to, the West Virginia Secretary of State's Office, the West Virginia Tax Department, West Virginia Insurance Commission, or any other state agency or political subdivision. Upon request, the Vendor must provide all necessary releases to obtain information to enable the Purchasing Division Director or the Agency to verify that the Vendor is licensed and in good standing with the above entities.



**32. ANTITRUST:** In submitting a bid to, signing a contract with, or accepting a Award Document from any agency of the State of West Virginia, the Vendor agrees to convey, sell, assign, or transfer to the State of West Virginia all rights, title, and interest in and to all causes of action it may now or hereafter acquire under the antitrust laws of the United States and the State of West Virginia for price fixing and/or unreasonable restraints of trade relating to the particular commodities or services purchased or acquired by the State of West Virginia. Such assignment shall be made and become effective at the time the purchasing agency tenders the initial payment to Vendor.

**33. VENDOR CERTIFICATIONS:** By signing its bid or entering into this Contract, Vendor certifies (1) that its bid or offer was made without prior understanding, agreement, or connection with any corporation, firm, limited liability company, partnership, person or entity submitting a bid or offer for the same material, supplies, equipment or services; (2) that its bid or offer is in all respects fair and without collusion or fraud; (3) that this Contract is accepted or entered into without any prior understanding, agreement, or connection to any other entity that could be considered a violation of law; and (4) that it has reviewed this Solicitation in its entirety; understands the requirements, terms and conditions, and other information contained herein. Vendor's signature on its bid or offer also affirms that neither it nor its representatives have any interest, nor shall acquire any interest, direct or indirect, which would compromise the performance of its services hereunder. Any such interests shall be promptly presented in detail to the Agency. The individual signing this bid or offer on behalf of Vendor certifies that he or she is authorized by the Vendor to execute this bid or offer or any documents related thereto on Vendor's behalf; that he or she is authorized to bind the Vendor in a contractual relationship; and that, to the best of his or her knowledge, the Vendor has properly registered with any State agency that may require registration.

**34. PURCHASING CARD ACCEPTANCE:** The State of West Virginia currently utilizes a Purchasing Card program, administered under contract by a banking institution, to process payment for goods and services. The Vendor must accept the State of West Virginia's Purchasing Card for payment of all orders under this Contract unless the box below is checked.

Vendor is not required to accept the State of West Virginia's Purchasing Card as payment for all goods and services.

**35. VENDOR RELATIONSHIP:** The relationship of the Vendor to the State shall be that of an independent contractor and no principal-agent relationship or employer-employee relationship is contemplated or created by this Contract. The Vendor as an independent contractor is solely liable for the acts and omissions of its employees and agents. Vendor shall be responsible for selecting, supervising, and compensating any and all individuals employed pursuant to the terms of this Solicitation and resulting contract. Neither the Vendor, nor any employees or subcontractors of the Vendor, shall be deemed to be employees of the State for any purpose whatsoever. Vendor shall be exclusively responsible for payment of employees and contractors for all wages and salaries, taxes, withholding payments, penalties, fees, fringe benefits, professional liability insurance premiums, contributions to insurance and pension, or other deferred compensation plans, including but

not limited to, Workers' Compensation and Social Security obligations, licensing fees, etc. and the filing of all necessary documents, forms, and returns pertinent to all of the foregoing. Vendor shall hold harmless the State, and shall provide the State and Agency with a defense against any and all claims including, but not limited to, the foregoing payments, withholdings, contributions, taxes, Social Security taxes, and employer income tax returns.

- 36. INDEMNIFICATION:** The Vendor agrees to indemnify, defend, and hold harmless the State and the Agency, their officers, and employees from and against: (1) Any claims or losses for services rendered by any subcontractor, person, or firm performing or supplying services, materials, or supplies in connection with the performance of the Contract; (2) Any claims or losses resulting to any person or entity injured or damaged by the Vendor, its officers, employees, or subcontractors by the publication, translation, reproduction, delivery, performance, use, or disposition of any data used under the Contract in a manner not authorized by the Contract, or by Federal or State statutes or regulations; and (3) Any failure of the Vendor, its officers, employees, or subcontractors to observe State and Federal laws including, but not limited to, labor and wage and hour laws.
- 37. PURCHASING AFFIDAVIT:** In accordance with West Virginia Code § 5A-3-10a, all Vendors are required to sign, notarize, and submit the Purchasing Affidavit stating that neither the Vendor nor a related party owe a debt to the State in excess of \$1,000. The affidavit must be submitted prior to award, but should be submitted with the Vendor's bid. A copy of the Purchasing Affidavit is included herewith.
- 38. ADDITIONAL AGENCY AND LOCAL GOVERNMENT USE:** This Contract may be utilized by and extends to other agencies, spending units, and political subdivisions of the State of West Virginia; county, municipal, and other local government bodies; and school districts ("Other Government Entities"). This Contract shall be extended to the aforementioned Other Government Entities on the same prices, terms, and conditions as those offered and agreed to in this Contract. If the Vendor does not wish to extend the prices, terms, and conditions of its bid and subsequent contract to the Other Government Entities, the Vendor must clearly indicate such refusal in its bid. A refusal to extend this Contract to the Other Government Entities shall not impact or influence the award of this Contract in any manner.
- 39. CONFLICT OF INTEREST:** Vendor, its officers or members or employees, shall not presently have or acquire an interest, direct or indirect, which would conflict with or compromise the performance of its obligations hereunder. Vendor shall periodically inquire of its officers, members and employees to ensure that a conflict of interest does not arise. Any conflict of interest discovered shall be promptly presented in detail to the Agency.
- 40. REPORTS:** Vendor shall provide the Agency and/or the Purchasing Division with the following reports identified by a checked box below:
- Such reports as the Agency and/or the Purchasing Division may request. Requested reports may include, but are not limited to, quantities purchased, agencies utilizing the contract, total contract expenditures by agency, etc.

- Quarterly reports detailing the total quantity of purchases in units and dollars, along with a listing of purchases by agency. Quarterly reports should be delivered to the Purchasing Division via email at [purchasing.requisitions@wv.gov](mailto:purchasing.requisitions@wv.gov).

**41. BACKGROUND CHECK:** In accordance with W. Va. Code § 15-2D-3, the Director of the Division of Protective Services shall require any service provider whose employees are regularly employed on the grounds or in the buildings of the Capitol complex or who have access to sensitive or critical information to submit to a fingerprint-based state and federal background inquiry through the state repository. The service provider is responsible for any costs associated with the fingerprint-based state and federal background inquiry.

After the contract for such services has been approved, but before any such employees are permitted to be on the grounds or in the buildings of the Capitol complex or have access to sensitive or critical information, the service provider shall submit a list of all persons who will be physically present and working at the Capitol complex to the Director of the Division of Protective Services for purposes of verifying compliance with this provision.

The State reserves the right to prohibit a service provider's employees from accessing sensitive or critical information or to be present at the Capitol complex based upon results addressed from a criminal background check.

Service providers should contact the West Virginia Division of Protective Services by phone at (304) 558-9911 for more information.

**42. PREFERENCE FOR USE OF DOMESTIC STEEL PRODUCTS:** Except when authorized by the Director of the Purchasing Division pursuant to W. Va. Code § 5A-3-56, no contractor may use or supply steel products for a State Contract Project other than those steel products made in the United States. A contractor who uses steel products in violation of this section may be subject to civil penalties pursuant to W. Va. Code § 5A-3-56. As used in this section:

- a. "State Contract Project" means any erection or construction of, or any addition to, alteration of or other improvement to any building or structure, including, but not limited to, roads or highways, or the installation of any heating or cooling or ventilating plants or other equipment, or the supply of and materials for such projects, pursuant to a contract with the State of West Virginia for which bids were solicited on or after June 6, 2001.
- b. "Steel Products" means products rolled, formed, shaped, drawn, extruded, forged, cast, fabricated or otherwise similarly processed, or processed by a combination of two or more or such operations, from steel made by the open heath, basic oxygen, electric furnace, Bessemer or other steel making process. The Purchasing Division Director may, in writing, authorize the use of foreign steel products if:
- c. The cost for each contract item used does not exceed one tenth of one percent (.1%) of the total contract cost or two thousand five hundred dollars (\$2,500.00), whichever is greater.

For the purposes of this section, the cost is the value of the steel product as delivered to the project; or

- d. The Director of the Purchasing Division determines that specified steel materials are not produced in the United States in sufficient quantity or otherwise are not reasonably available to meet contract requirements.

**43. PREFERENCE FOR USE OF DOMESTIC ALUMINUM, GLASS, AND STEEL:** In Accordance with W. Va. Code § 5-19-1 et seq., and W. Va. CSR § 148-10-1 et seq., for every contract or subcontract, subject to the limitations contained herein, for the construction, reconstruction, alteration, repair, improvement or maintenance of public works or for the purchase of any item of machinery or equipment to be used at sites of public works, only domestic aluminum, glass or steel products shall be supplied unless the spending officer determines, in writing, after the receipt of offers or bids, (1) that the cost of domestic aluminum, glass or steel products is unreasonable or inconsistent with the public interest of the State of West Virginia, (2) that domestic aluminum, glass or steel products are not produced in sufficient quantities to meet the contract requirements, or (3) the available domestic aluminum, glass, or steel do not meet the contract specifications. This provision only applies to public works contracts awarded in an amount more than fifty thousand dollars (\$50,000) or public works contracts that require more than ten thousand pounds of steel products.

The cost of domestic aluminum, glass, or steel products may be unreasonable if the cost is more than twenty percent (20%) of the bid or offered price for foreign made aluminum, glass, or steel products. If the domestic aluminum, glass or steel products to be supplied or produced in a “substantial labor surplus area”, as defined by the United States Department of Labor, the cost of domestic aluminum, glass, or steel products may be unreasonable if the cost is more than thirty percent (30%) of the bid or offered price for foreign made aluminum, glass, or steel products.

This preference shall be applied to an item of machinery or equipment, as indicated above, when the item is a single unit of equipment or machinery manufactured primarily of aluminum, glass or steel, is part of a public works contract and has the sole purpose or of being a permanent part of a single public works project. This provision does not apply to equipment or machinery purchased by a spending unit for use by that spending unit and not as part of a single public works project.

All bids and offers including domestic aluminum, glass or steel products that exceed bid or offer prices including foreign aluminum, glass or steel products after application of the preferences provided in this provision may be reduced to a price equal to or lower than the lowest bid or offer price for foreign aluminum, glass or steel products plus the applicable preference. If the reduced bid or offer prices are made in writing and supersede the prior bid or offer prices, all bids or offers, including the reduced bid or offer prices, will be reevaluated in accordance with this rule.

**CERTIFICATION AND SIGNATURE PAGE**

By signing below, or submitting documentation through wvOASIS, I certify that I have reviewed this Solicitation in its entirety; understand the requirements, terms and conditions, and other information contained herein; that I am submitting this bid, offer or proposal for review and consideration; that I am authorized by the vendor to execute and submit this bid, offer, or proposal, or any documents related thereto on vendor's behalf; that I am authorized to bind the vendor in a contractual relationship; and that to the best of my knowledge, the vendor has properly registered with any State agency that may require registration.

Rudd Equipment Company  
(Company)

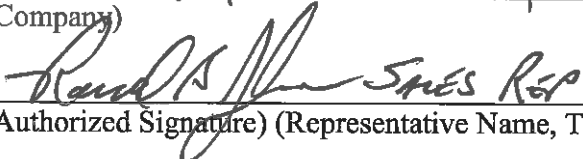
 SMITH REP  
(Authorized Signature) (Representative Name, Title)

304-755-7788  
(Phone Number) (Fax Number) (Date)

REQUEST FOR QUOTATION  
CLASS 591 DOUBLE DRUM VIBRATORY ROLLER/COMPACTOR

---

SPECIFICATIONS

1. **PURPOSE AND SCOPE:** The West Virginia Purchasing Division is soliciting bids On behalf of the West Virginia Division of Highways, Department of Transportation to establish an open-end contract for a Double Drum Vibratory Roller/Compactor. Mower
2. **DEFINITIONS:** The terms listed below shall have the meanings assigned to them below. Additional definitions can be found in section 2 of the General Terms and Conditions.
  - 2.1 **“Contract Item”** or **“Contract Items”** means the list of items identified in Section 3, Subsection 1 below.
  - 2.2 **“Pricing Pages”** means the schedule of prices, estimated order quantity, and totals contained in wvOASIS or attached hereto as Exhibit A, and used to evaluate the Solicitation responses.
  - 2.3 **“Solicitation”** means the official notice of an opportunity to supply the State with goods or services that is published by the Purchasing Division.
  - 2.4 **“WVDOH”** means West Virginia Division of Highways.
  - 2.5 **“MPH”** means miles per hour.
  - 2.6 **“ROPS”** means Roll-over Protection Structures.
  - 2.7 **“CCA”** means cold cranking amps.
  - 2.8 **“OSHA”** means Occupational Safety and Health Act.
  - 2.9 **“FOPS”** means Falling Object Protective Structure.
3. **GENERAL REQUIREMENTS:**
  - 3.1 **Contract Items and Mandatory Requirements:** Vendor shall provide Agency with the Contract Items listed below on an open-end and continuing basis. Contract items must meet or exceed the mandatory requirements as shown below.
    - 3.1.1 **General – Double Drum Vibratory Roller/Compactor**
      - 3.1.1.1 Unit shall be of a low profile design.

**REQUEST FOR QUOTATION**  
**CLASS 591 DOUBLE DRUM VIBRATORY ROLLER/COMPACTOR**

---

3.1.1.2 Unit weight shall be minimum 5700 pounds.

3.1.1.3 Wheel Base shall be minimum 64 inches.

3.1.1.4 Unit shall travel 0 to 6 M.P.H. forward and reverse minimum.

3.1.1.5 Roller(s) shall be equipped with ROPS and Level 1 FOPS canopy.

3.1.1.6 Vendor must certify that unit offered will meet or exceed the "Occupational Safety and Health Act of 1970" or subsequent changes that are in effect at the time of manufacture of the unit.

3.1.1.7 The unit specified herein and offered shall be manufactured on or after January 1, 2015 and will be clearly identified and marked with date of manufacture.

**3.1.2 Vandalism Package:**

3.1.2.1 Unit shall have manufacturer's standard vandalism package.

**3.1.3 Engine:**

3.1.3.1 Engine shall be manufacturers water/air cooled diesel powered and shall provide a minimum of 28 horsepower and sufficient torque to operate machine and hydraulic system at maximum efficiency.

3.1.3.2 Engine shall have manufacturer's heaviest duty dual fuel filtering system offered.

3.1.3.3 Shall have full pressure lubrication with oil filter and oil by-pass system.

3.1.3.4 Shall have manufacturers standard governor with key shut off, wire sealed by manufacturer.

3.1.3.5 Cooling system shall be filled with permanent type Dex-Cool extended life (or equal) anti-freeze protected to a point of -34° F if unit is water cooled.

3.1.3.6 Shall be Manufacturers standard governor with engine key shut off, wire sealed by Manufacturer.

REQUEST FOR QUOTATION  
CLASS 591 DOUBLE DRUM VIBRATORY ROLLER/COMPACTOR

---

**3.1.4 Steering System:**

3.1.4.1 Steering system shall be of hydraulic, full power, articulated design.

**3.1.5 Brakes:**

3.1.5.1 Service brake shall be through hydrostatic propulsion system.

3.1.5.2 Parking brake shall be of spring-applied, hydraulically released on each drum drive.

**3.1.6 Drums:**

3.1.6.1 Roller shall have dual drum drive with hydrostatic propulsion.

3.1.6.2 Drums shall be of manufacturer's heavy duty design.

3.1.6.3 Drum width shall be minimum 47 inches.

3.1.6.4 Drum diameter shall be minimum 27 inches.

3.1.6.5 Wiper bars shall be mounted front and rear of each drum.

3.1.6.6 Wiper bars shall be spring loaded, self - adjusting.

3.1.6.7 Wiper bars shall have replaceable rubber/neoprene drum cleaners.

3.1.6.8 Front and rear drums shall be of vibratory compaction type.

3.1.6.9 Vibrating parts must be isolated from rest of roller.

3.1.6.10 Vibrating system isolators shall be replaceable.

3.1.6.11 Unit must be equipped with automatic vibration switch.

**3.1.7 Electrical System:**

3.1.7.1 Electrical system shall be manufacturer's heavy duty 12 volt D.C. negative ground.

3.1.7.2 Manufacturers recommended heavy duty maintenance free battery shall be provided.



REQUEST FOR QUOTATION  
**CLASS 591 DOUBLE DRUM VIBRATORY ROLLER/COMPACTOR**

---

3.1.7.3 Battery shall be CCA 500 minimum.

3.1.7.4 Alternator shall be 60 AMP minimum with internal regulator.

**3.1.8 Gauges:**

3.1.8.1 Gauges shall be illuminated and must be equipped with visual or audible warning that will advise operator when manufacturer recommended safe operating ranges are exceeded.

3.1.8.2 Shall have ignition switch water sealed.

3.1.8.3 Shall have fuel gauge.

3.1.8.4 Operators station shall have manufacturer's adjustable isolation mounted seat with seat belt.

3.1.8.5 OSHA approved back-up alarm shall be provided and installed by manufacturer.

3.1.8.6 Unit shall have a parking brake "on" indicator.

3.1.8.7 A neutral start safety switch shall be provided.

3.1.8.8 Shall have volt/Amp meter gauge or light.

3.1.8.9 Shall have oil pressure gauge or light.

3.1.8.10 Shall have engine temperature gauge or light.

**3.1.9 Water System:**

3.1.9.1 Tank capacity shall be 40 gallon minimum.

3.1.9.2 Water system shall be pressurized.

3.1.9.3 Water flow must be variable.

3.1.9.4 Water filter(s) shall be provided.

3.1.9.5 One (1) complete set of replacement filters shall be provided with each unit upon delivery.

REQUEST FOR QUOTATION  
**CLASS 591 DOUBLE DRUM VIBRATORY ROLLER/COMPACTOR**

---

3.1.9.6 Shall have screened back nozzle type sprayers for drums.

3.1.9.7 Water pump shall be capable of “Run Dry” situation without damage to pump or components.

3.1.9.8 Water tank and complete water system shall be constructed of rust proof materials.

3.1.9.9 Water tank shall have drain plug.

**3.1.10 Lighting:**

3.1.10.1 Unit shall be equipped with flashers visible from front and rear of roller.

3.1.10.2 Work lights shall be installed front and rear of roller. Two (2) front and two (2) rear.

3.1.10.3 Low profile high intensity dual flash strobe light shall be mounted on top of cab/canopy. Aero Flash Model number M420 or equivalent. (Amber in color).

3.1.10.4 Work lights shall be installed front and rear of roller. Two (2) front and two (2) rear.

3.1.10.5 Low profile high intensity dual flash strobe light shall be mounted on top of cab/canopy. Aero Flash Model number M420 or equivalent. (Amber in color).

**3.1.11 Advertisement:**

3.1.11.1 Advertisement is limited to one (1) manufacturer name plate, which must include model number, may appear on exterior of unit. Logos created through the stamping or casting process of manufacturer are also acceptable. No logo will interfere with the Department’s striping and logo.

**3.1.12 Paint:**

3.1.12.1 Manufacturer’s standard paint

REQUEST FOR QUOTATION  
CLASS 591 DOUBLE DRUM VIBRATORY ROLLER/COMPACTOR

---

**3.1.13 Miscellaneous:**

3.1.13.1 Unit shall be delivered to WVDOH with all manufacturers recommended safety related decals and safety features intact.

**4. CONTRACT AWARD:**

**4.1 Contract Award:** The Contract is intended to provide Agencies with a purchase price on all Contract Items. The Contract shall be awarded to Vendor that provides the Contract Items meeting the required specifications for the lowest overall total cost as shown on the Pricing Pages.

**4.2 Pricing Pages:** Vendor should complete the Pricing Pages (Exhibit A) by completing the Year, Make, Model, and inserting quoted unit price. Vendor should take estimated Quantity and multiply by unit price to get grand total. Vendor should complete the pricing pages in their entirety as failure to do so may result in Vendor's bids being disqualified.

The Pricing Page contains a list of the Contract Items and estimated purchase volume. The estimated purchase volume for each item represents the approximate volume of anticipated purchases only. No future use of the Contract or any individual item is guaranteed or implied.

Vendor should electronically enter the information into the Pricing Pages through wvOASIS, if available, or as an electronic document. In most cases, the Vendor can request an electronic copy of the Pricing Pages for bid purposes by sending an email request to the following address:  
Sheila.l.Hannah@wv.gov.

**5. ORDERING AND PAYMENT:**

**5.1 Ordering:** Vendor shall accept orders through wvOASIS, regular mail, facsimile, e-mail, or any other written forms of communication. Vendor may, but is not required to accept on-line orders through a secure internet ordering portal/website. If Vendor has the ability to accept on-line orders, it should include in its response a brief description of how Agencies may utilize the on-line ordering system. Vendor shall ensure that its on-line ordering system is properly secured prior to processing Agency orders on-line.

**5.2 Payment:** Vendor shall accept payment in accordance with the payment procedures of the State of West Virginia.

REQUEST FOR QUOTATION  
CLASS 591 DOUBLE DRUM VIBRATORY ROLLER/COMPACTOR

---

**6. DELIVERY AND RETURN:**

**6.1 Delivery Time:** Vendor shall deliver standard orders within 180 working days after orders are received. Vendor shall ship all orders in accordance with the above schedule and shall not hold orders until a minimum delivery quantity is met. A completed pilot model for inspection must be provided within 45 working day(s) after receipt of the purchase agreement by the successful vendor. Working day is defined as any week day, Monday thru Friday, excluding Federal and State Holidays. Vendor shall ship all orders in accordance with the above schedule and shall not hold orders until a minimum delivery quantity is met.

**6.2 Late Delivery:** The Agency placing the order under this Contract must be notified in writing if orders will be delayed for any reason. Any delay in delivery that could cause harm to an Agency will be grounds for cancellation of the delayed order, and/or obtaining the items ordered from a third party.

Any Agency seeking to obtain items from a third party under this provision must first obtain approval of the Purchasing Division.

**6.3 Delivery Payment/Risk of Loss:** Standard order delivery shall be F.O.B. Destination to the Agency's location. Vendor shall include the cost of standard order delivery charges in its bid pricing/discount and is not permitted to charge the Agency separately for such delivery. The Agency will pay delivery charges on all emergency orders provided that Vendor invoices those delivery costs as a separate charge with the original freight bill attached to the invoice.

**6.4 Representative Unit for Test:** The successful vendor must (if specified) provide the DOH one (1) completed representative unit to be observed and evaluated on each order to insure compliance with specification. If requested, the time period for testing and evaluation shall be seven (7) working days following receipt of the unit. DOH will incur no obligation for deterioration of surfaces, finishes, seals, and mechanical or electrical parts on the unit resulting from operation and testing within the limits of these specifications; nor will DOH incur obligation for damage to the unit resulting from failure to meet specifications when due care and attention is given by DOH and testing is done within the limits of these specifications. Failure of the pilot unit to satisfactorily meet specifications as bid may be cause for cancellation of the purchase order, and return of the delivered unit along with all associated equipment to the vendor at the vendor's expense.

**6.5 Condition of Unit(s) Upon Delivery:** All units must arrive at the prescribed delivery point having been completely pre-serviced with oil, lubricants, and coolant. All prescribed precautions pertaining to first operations and break-in of the unit are to be posted conspicuously on the unit for ready observance by the operator.

REQUEST FOR QUOTATION  
CLASS 591 DOUBLE DRUM VIBRATORY ROLLER/COMPACTOR

---

- 6.6 **Delivery Point:** Delivery point of the completed representative unit will be the WVDOH, Equipment Division, 83 Brushy Fork Road Crossing, Buckhannon, WV 26201.

**7. MISCELLANEOUS:**

- 7.1 **No Substitutions:** Vendor shall supply only Contract Items submitted in Response to the Solicitation unless a contract modification is approved in accordance with the provisions contained in this Contract.

- 7.2 **Reports:** Vendor shall provide quarterly reports and annual summaries to the Agency showing the Agency's items purchased, quantities of items purchased, and total dollar value of the items purchased. Vendor shall also provide reports, upon request, showing the items purchased during the term of this Contract, the quantity purchased for each of those items, and the total value of purchases for each of those items. Failure to supply such reports may be grounds for cancellation of this Contract.

- 7.3 **Contract Manager:** During its performance of this Contract, Vendor must designate and maintain a primary contract manager responsible for overseeing Vendor's responsibilities under this Contract. The Contract manager must be available during normal business hours to address any customer service or other issues related to this Contract. Vendor should list its Contract manager and his or her contact information below.

Contract Manager: Ron Jacobs  
Telephone Number: 304-765-7788  
Fax Number: 304-765-7990  
Email Address: rcjacob@csadequipment.com

- 7.4 **Operating and Service Manuals and Parts Lists:** An operator's manual must be included with each unit upon delivery. A "line sheet" (if applicable) and the "Equipment Preventative Maintenance Questionnaire", (Exhibit "B") must be with pilot unit upon delivery, Attn: Marcia Lee. There must be 12 service/shop/maintenance manuals and 14 parts manuals; CD-ROM is preferred in lieu of parts manuals. Manuals shall be delivered upon completion of delivery of total units. Failure to do so will delay payment.

- 7.5 **Training:** Manufacturers and/or dealers will be required to stage a thorough seminar on the subjects of Preventative Maintenance, Operator, and Mechanic

REQUEST FOR QUOTATION  
**CLASS 591 DOUBLE DRUM VIBRATORY ROLLER/COMPACTOR**

---

Training. In order to keep operators and mechanics updated, the successful vendor shall conduct training sessions covering the operation, maintenance, trouble shooting with each purchase order against this open end contract.

Manufacturers and/or dealers shall be required to furnish the Training Academy with one (1) Operator's Manual to be shipped direct to

**WVDOH**  
Training Academy  
P.O. Box 610  
Buckhannon, West Virginia 26201

Prior to delivery of the pilot unit. Training seminar to be held at the WVDOT, Equipment Division, Buckhannon, WV.

- 7.6 Preventative Maintenance & Operator Procedures:** Manufacturers and/or dealers will be required to submit to the Equipment Division, in addition to the operating and service manuals, booklets and pamphlets explaining the Preventative Maintenance and Operator Procedures to be used by the operators of this equipment, and must include such things as daily prestart inspection procedure, service schedule, and routine maintenance required, safety precautions, etc. The successful vendor shall furnish all training aids; i.e. videos, projectors as required in conducting the training.
- 7.7 Warranty and Service Policy:** The unit must be accompanied upon delivery by the unit's manufacturers executed warranty and service policy.
- 7.8 Unspecified Accessories & Features:** All parts, equipment, accessories, Material, design and performance characteristics not specified herein, but which are necessary to provide a complete unit, must be furnished with each unit and required to conform to strength, quality of material, and quality of workmanship to those which are advertised and provided to the market in general by the unit industry. All parts and accessories advertised and regularly supplied as standard shall be included, except those which would represent duplication of these specified and except those which, by specification, are not to be furnished. All standard safety features, required by Federal and State Law, shall be included.

**8. VENDOR DEFAULT:**

- 8.1** The following shall be considered a vendor default under this Contract.

REQUEST FOR QUOTATION  
**CLASS 591 DOUBLE DRUM VIBRATORY ROLLER/COMPACTOR**

---

8.1.1 Failure to provide Contract Items in accordance with the requirements contained herein.

8.1.2 Failure to comply with other specifications and requirements contained herein.

8.1.3 Failure to comply with any laws, rules, and ordinances applicable to the Contract Services provided under this Contract.

8.1.4 Failure to remedy deficient performance upon request.

**8.2** The following remedy shall be available to Agency upon default.

8.2.1 Immediate cancellation of the contract.

8.2.2 Immediate cancellation of one or more release orders issued under this Contract.

8.2.3 Any other remedies available in law or equity.

Exhibit A

**Pricing Sheet**

**RFQ 7016EC07**

1	10	Each	One complete unit: Double Drum Vibratory Roller/Compactor		\$31,594.00
				Grand Total	\$315,940.00

Vendor should also supply the year, make, and model of the following:

Double Drum Vibratory Roller/Compactor

2015 VOLVO DD25B



**ADDENDUM ACKNOWLEDGEMENT FORM**  
**SOLICITATION NO.: CRFQ DOT160000015**

Instructions: Please acknowledge receipt of all addenda issued with this solicitation by completing this addendum acknowledgment form. Check the box next to each addendum received and sign below. Failure to acknowledge addenda may result in bid disqualification.

Acknowledgment: I hereby acknowledge receipt of the following addenda and have made the necessary revisions to my proposal, plans and/or specification, etc.

Addendum Numbers Received:  
(Check the box next to each addendum received)

- |  |  |
|--|--|
| <input checked="" type="checkbox"/> Addendum No. 1 | <input type="checkbox"/> Addendum No. 6  |
| <input type="checkbox"/> Addendum No. 2            | <input type="checkbox"/> Addendum No. 7  |
| <input type="checkbox"/> Addendum No. 3            | <input type="checkbox"/> Addendum No. 8  |
| <input type="checkbox"/> Addendum No. 4            | <input type="checkbox"/> Addendum No. 9  |
| <input type="checkbox"/> Addendum No. 5            | <input type="checkbox"/> Addendum No. 10 |

I understand that failure to confirm the receipt of addenda may be cause for rejection of this bid. I further understand that any verbal representation made or assumed to be made during any oral discussion held between Vendor's representatives and any state personnel is not binding. Only the information issued in writing and added to the specifications by an official addendum is binding.

Rudd Equipment Company  
Company

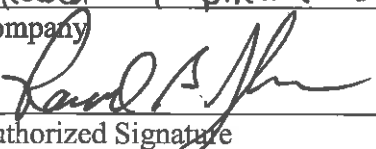
  
Authorized Signature

9/22/15  
Date

NOTE: This addendum acknowledgment should be submitted with the bid to expedite document processing.

**SOLICITATION NUMBER: CRFQ – DOT1600000015**  
**Addendum Number: 1**

---

The purpose of this addendum is to modify the solicitation identified as CRFQ DOT1600000015 (“Solicitation”) to reflect the change(s) identified and described below.

**Applicable Addendum Category:**

- Modify bid opening date and time
- Modify specifications of product or service being sought
- Attachment of vendor questions and responses
- Attachment of pre-bid sign-in sheet
- Correction of error
- Other

**Description of Modification to Solicitation:**

1. Responses to vendor questions attached.
2. Pre-bid sign in sheets attached.
3. The bid opening has moved from 09/16/2015 to 09/22/2015.

**Additional Documentation:** Documentation related to this Addendum (if any) has been included herewith as Attachment A and is specifically incorporated herein by reference.

**Terms and Conditions:**

1. All provisions of the Solicitation and other addenda not modified herein shall remain in full force and effect.
2. Vendor should acknowledge receipt of all addenda issued for this Solicitation by completing an Addendum Acknowledgment, a copy of which is included herewith. Failure to acknowledge addenda may result in bid disqualification. The addendum acknowledgement should be submitted with the bid to expedite document processing.

**ADDENDUM FOR PRE-BID**

**CRFQ 0803 DOT1600000015**

**CLASS 591 DOUBLE DRUM VIBRATORY ROLLER/COMPACTOR**

The original language in contract will be listed first with question and answer to follow below.

1. **3.1.1.2 Unit weight shall be minimum 5700 pounds.**

**Question 1: Our weight is 5511 pounds, will you accept?**

**Answer: Yes, we will revise this to read: 3.1.1.2 Unit weight shall be minimum 5500 pounds.**

2. **3.1.1.5 Roller(s) shall be equipped with ROPS and Level 1 FOPS canopy.**

**Question: Could we get a little more of an explanation as what this is and what is meant by Level 1?**

**Answer: Level 1 protection is designed to protect against falling bricks, tools etc...**

3. **3.1.2 Vandalism Package**

**Question: What is meant by this?**

**Answer: Your manufacturer's standard vandalism package is what we require.**

4. **3.1.3.1 Engine shall be manufacturer's water/air cooled diesel powered and shall provide a minimum of 28 horsepower and sufficient torque to operate machine and hydraulic system at maximum efficiency.**

**Question: 2 vendors are asking: Ours is 25 horsepower, will you accept?**

**Answer: Yes, we will revise engine horsepower, this shall now read: 3.1.3.1 Engine shall be manufacturer's water/air cooled diesel powered and shall provide a minimum of 25 horsepower and sufficient torque to operate machine and hydraulic system at maximum efficiency.**

5. **Question: Is this a Tier 4 final engine?**

**Answer: Yes, we will add this to spec. under 3.1.3.7 Engine shall be Tier 4 Final compliant.**

6. **6.1 Delivery of pilot model is 45 working days**

**Question # 1: Can you change this to read 90 working days?**

**Answer: Yes, we will extend pilot to 90 working days.**

**Question # 2: We would like this changed to 120 working days?**

**Answer: No, we will extend to 90 working days.**

**PRE-BID CONFERENCE  
SIGN IN SHEET**

Request for Quotation Number: CRFG 0803DOT1600000015 Date: 8/26/15

Project Description: CLASS 591 Double Drum Vibratory Roller / Compactor

**PLEASE PRINT LEGIBLY. THIS INFORMATION IS ESSENTIAL TO CONTACT THE ATTENDEES IN A TIMELY MANNER. FAILURE TO DO SO MAY RESULT IN DELAYS IN YOUR COMPANY GETTING IMPORTANT BID INFORMATION.**

Firm Name:	<u>Rudd Equipment Company</u>
Firm Address:	<u>509 River Road</u> <u>Altoona WV 25143</u>
Representative Attending:	<u>Ron Jacobs</u>
Phone Number:	<u>304-546-5253 Cell</u>
Fax Number:	<u>304-755-7990</u>
Email Address:	<u>RJACOBS@RuddEquipment-Com</u>

Firm Name:	<u>Best Line Equipment</u>
Firm Address:	<u>2582 Gateway Dr.</u> <u>State College PA 16801</u>
Representative Attending:	<u>Jim Cheunes</u>
Phone Number:	<u>570-279-6708</u>
Fax Number:	<u>570-</u>
Email Address:	<u>jcheunes@bestline.com</u>

Firm Name:	<u>VOLVO CONSTRUCTION EQUIPMENT</u>
Firm Address:	<u>312 VOLVO WAY</u> <u>SHIPPENSBURG PA 17057</u>
Representative Attending:	<u>CRAIG WOLFORD</u>
Phone Number:	<u>717 418 0514</u>
Fax Number:	
Email Address:	<u>craig.wolford@volvo.com</u>

Firm Name:	
Firm Address:	
Representative Attending:	
Phone Number:	
Fax Number:	
Email Address:	

Firm Name:	<u>WEST VIRGINIA TRACTOR</u>
Firm Address:	<u>P.O. BOX 473</u> <u>CHARLESTON WV 25322</u>
Representative Attending:	<u>GARY BRADY</u>
Phone Number:	<u>304-346-5301</u>
Fax Number:	<u>304-346-5305</u>
Email Address:	<u>wvtractor@msn.com</u>

Firm Name:	
Firm Address:	
Representative Attending:	
Phone Number:	
Fax Number:	
Email Address:	

**PRE-BID CONFERENCE  
SIGN IN SHEET**

Request for Quotation Number: CRFQ 0803DOT1600000015 Date: 8/26/15

Project Description: CLASS 591 Double Drum Vibratory Roller / Compactor

**PLEASE PRINT LEGIBLY. THIS INFORMATION IS ESSENTIAL TO CONTACT THE ATTENDEES IN A TIMELY MANNER. FAILURE TO DO SO MAY RESULT IN DELAYS IN YOUR COMPANY GETTING IMPORTANT BID INFORMATION.**

Firm Name:	<u>State Equipment Inc</u>
Firm Address:	<u>560 New Goss Mt. Rd</u> <u>Crosslones WV 25313</u>
Representative Attending:	<u>Justin Phillipis</u>
Phone Number:	<u>304-775-4405</u>
Fax Number:	<u>304-592-0499</u>
Email Address:	<u>JPhillips@stateequipment.com</u>

Firm Name:	<u>Pish Equipment Company</u>
Firm Address:	<u>100 Kelpout Loop Rd.</u> <u>Bridgeport WV 26330</u>
Representative Attending:	<u>Mike Blickerhoff</u>
Phone Number:	<u>304-842-3511</u>
Fax Number:	<u>304-842-6126</u>
Email Address:	<u>mblickerhoff@rsh.com</u>

Firm Name:	<u>Leslie Equipment Co.</u>
Firm Address:	<u>19 Goff Crossing Dr.</u> <u>Cross Lones WV 25317</u>
Representative Attending:	<u>Eric Brakes</u>
Phone Number:	<u>304 204 1818</u>
Fax Number:	<u>304 204 1811</u>
Email Address:	<u>Brakeseric@lecl.com</u>

Firm Name:	
Firm Address:	
Representative Attending:	
Phone Number:	
Fax Number:	
Email Address:	

Firm Name:	<u>WALKER MACHINERY Co</u>
Firm Address:	<u>P.O. Box 2427</u> <u>CHARLESTON, WV 25329</u>
Representative Attending:	<u>Matt Conner</u>
Phone Number:	<u>(304) 543-5406</u>
Fax Number:	<u>(304) 759-6404</u>
Email Address:	<u>mconner@walker-cat.com</u>

Firm Name:	
Firm Address:	
Representative Attending:	
Phone Number:	
Fax Number:	
Email Address:	

PRE-BID CONFERENCE  
SIGN IN SHEET

Request for Quotation Number: CRF0 0803DOT1600000015 Date: 8/26/15

Project Description: CLASS 591 Double Drum Vibratory Roller / Compactor

PLEASE PRINT LEGIBLY. THIS INFORMATION IS ESSENTIAL TO CONTACT THE ATTENDEES IN A TIMELY MANNER. FAILURE TO DO SO MAY RESULT IN DELAYS IN YOUR COMPANY GETTING IMPORTANT BID INFORMATION.

Firm Name:	<u>PAM HALL</u>
Firm Address:	<u>WV DOH</u>
Representative Attending:	
Phone Number:	
Fax Number:	
Email Address:	

Firm Name:	<u>MARITA LEE</u>
Firm Address:	<u>DOH</u>
Representative Attending:	
Phone Number:	
Fax Number:	
Email Address:	

Firm Name:	<u>Angie Woberman</u>
Firm Address:	<u>WV DOH</u>
Representative Attending:	
Phone Number:	
Fax Number:	
Email Address:	

Firm Name:	
Firm Address:	
Representative Attending:	
Phone Number:	
Fax Number:	
Email Address:	

Firm Name:	<u>Todd Campbell</u>
Firm Address:	<u>WV DOH</u>
Representative Attending:	
Phone Number:	
Fax Number:	
Email Address:	

Firm Name:	
Firm Address:	
Representative Attending:	
Phone Number:	
Fax Number:	
Email Address:	

**ADDENDUM ACKNOWLEDGEMENT FORM**  
**SOLICITATION NO.: DOT1600000015**

**Instructions:** Please acknowledge receipt of all addenda issued with this solicitation by completing this addendum acknowledgment form. Check the box next to each addendum received and sign below. Failure to acknowledge addenda may result in bid disqualification.

**Acknowledgment:** I hereby acknowledge receipt of the following addenda and have made the necessary revisions to my proposal, plans and/or specification, etc.

**Addendum Numbers Received:**

(Check the box next to each addendum received)

- |  |  |
|--|--|
| <input checked="" type="checkbox"/> Addendum No. 1 | <input type="checkbox"/> Addendum No. 6  |
| <input type="checkbox"/> Addendum No. 2            | <input type="checkbox"/> Addendum No. 7  |
| <input type="checkbox"/> Addendum No. 3            | <input type="checkbox"/> Addendum No. 8  |
| <input type="checkbox"/> Addendum No. 4            | <input type="checkbox"/> Addendum No. 9  |
| <input type="checkbox"/> Addendum No. 5            | <input type="checkbox"/> Addendum No. 10 |

I understand that failure to confirm the receipt of addenda may be cause for rejection of this bid. I further understand that that any verbal representation made or assumed to be made during any oral discussion held between Vendor's representatives and any state personnel is not binding. Only the information issued in writing and added to the specifications by an official addendum is binding.

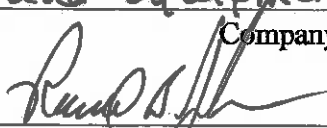
Rudd Equipment Company  
Company  
  
Authorized Signature  
9/22/15  
Date

**NOTE:** This addendum acknowledgment should be submitted with the bid to expedite document processing.

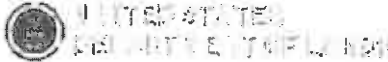

SEARCH

A to Z Index | En español | Contact Us | FAQs | About OSHA

OSHA

OSHA QuickTakes

Newsletter

RSS Feeds

Print This Page

Text Size

Was this page helpful?

Occupational Safety & Health Administration We Can Help

What's New | Offices

- Home Workers Regulations Enforcement Data & Statistics Training Publications Newsroom Small Business OSHA

OSH Act of 1970 - Table of Contents

Public Law 91-596
84 STAT. 1590
91st Congress, S.2193
December 29, 1970,
as amended through January 1, 2004. (1)

An Act

To assure safe and healthful working conditions for working men and women; by authorizing enforcement of the standards developed under the Act; by assisting and encouraging the States in their efforts to assure safe and healthful working conditions; by providing for research, information, education, and training in the field of occupational safety and health; and for other purposes.

Be it enacted by the Senate and House of Representatives of the United States of America in Congress assembled, That this Act may be cited as the "Occupational Safety and Health Act of 1970."

Footnote (1) See Historical notes at the end of this document for changes and amendments affecting the OSH Act since its passage in 1970 through January 1, 2004.

SEC. 2. Congressional Findings and Purpose

(a) The Congress finds that personal injuries and illnesses arising out of work situations impose a substantial burden upon, and are a hindrance to, interstate commerce in terms of lost production, wage loss, medical expenses, and disability compensation payments. 29 USC 651

(b) The Congress declares it to be its purpose and policy, through the exercise of its powers to regulate commerce among the several States and with foreign nations and to provide for the general welfare, to assure so far as possible every working man and woman in the Nation safe and healthful working conditions and to preserve our human resources --

(1) by encouraging employers and employees in their efforts to reduce the number of occupational safety and health hazards at their places of employment, and to stimulate employers and employees to institute new and to perfect existing programs for providing safe and healthful working conditions; (2) by providing that employers and employees have separate but dependent responsibilities and rights with respect to achieving safe and healthful working conditions;

(3) by authorizing the Secretary of Labor to set mandatory occupational safety and health standards applicable to businesses affecting interstate commerce, and by creating an Occupational Safety and Health Review Commission for carrying out adjudicatory functions under the Act;

(4) by building upon advances already made through employer and employee initiative for providing safe and healthful working conditions;

(5) by providing for research in the field of occupational safety and health, including the psychological factors involved, and by developing innovative methods, techniques, and approaches for dealing with occupational safety and health problems;

(6) by exploring ways to discover latent diseases, establishing causal connections between diseases and work in environmental conditions, and conducting other research relating to health problems, in recognition of the fact that occupational health standards present problems often different from those involved in occupational safety;

(7) by providing medical criteria which will assure insofar as practicable that no employee will suffer diminished health, functional capacity, or life expectancy as a result of his work experience;

(8) by providing for training programs to increase the number and competence of personnel engaged in the field of occupational safety and health; affecting the OSH Act since its passage in 1970 through January 1, 2004.

(9) by providing for the development and promulgation of occupational safety and health standards;

(10) by providing an effective enforcement program which shall include a prohibition against giving advance notice of any inspection and sanctions for any individual violating this prohibition;

(11) by encouraging the States to assume the fullest responsibility for the administration and enforcement of their occupational safety and health laws by providing grants to the



States to assist in identifying their needs and responsibilities in the area of occupational safety and health, to develop plans in accordance with the provisions of this Act, to improve the administration and enforcement of State occupational safety and health laws, and to conduct experimental and demonstration projects in connection therewith;

(12) by providing for appropriate reporting procedures with respect to occupational safety and health which procedures will help achieve the objectives of this Act and accurately describe the nature of the occupational safety and health problem;

(13) by encouraging joint labor-management efforts to reduce injuries and disease arising out of employment.

**SEC. 3. Definitions**

For the purposes of this Act —

29 USC 652

(1) The term "Secretary" means the Secretary of Labor.

(2) The term "Commission" means the Occupational Safety and Health Review Commission established under this Act.

(3) The term "commerce" means trade, traffic, commerce, transportation, or communication among the several States, or between a State and any place outside thereof, or within the District of Columbia, or a possession of the United States (other than the Trust Territory of the Pacific Islands), or between points in the same State but through a point outside thereof.

For Trust Territory coverage, including the Northern Mariana Islands, see *Historical notes*

(4) The term "person" means one or more individuals, partnerships, associations, corporations, business trusts, legal representatives, or any organized group of persons.

Pub. L. 105-241 United States Postal Service is an employer subject to the Act. See *Historical notes*.

(5) The term "employer" means a person engaged in a business affecting commerce who has employees, but does not include the United States (not including the United States Postal Service) or any State or political subdivision of a State.

(6) The term "employee" means an employee of an employer who is employed in a business of his employer which affects commerce.

(7) The term "State" includes a State of the United States, the District of Columbia, Puerto Rico, the Virgin Islands, American Samoa, Guam, and the Trust Territory of the Pacific Islands.

(8) The term "occupational safety and health standard" means a standard which requires conditions, or the adoption or use of one or more practices, means, methods, operations, or processes, reasonably necessary or appropriate to provide safe or healthful employment and places of employment.

(9) The term "national consensus standard" means any occupational safety and health standard or modification thereof which (1), has been adopted and promulgated by a nationally recognized standards-producing organization under procedures whereby it can be determined by the Secretary that persons interested and affected by the scope or provisions of the standard have reached substantial agreement on its adoption, (2) was formulated in a manner which afforded an opportunity for diverse views to be considered and (3) has been designated as such a standard by the Secretary, after consultation with other appropriate Federal agencies.

(10) The term "established Federal standard" means any operative occupational safety and health standard established by any agency of the United States and presently in effect, or contained in any Act of Congress in force on the date of enactment of this Act.

(11) The term "Committee" means the National Advisory Committee on Occupational Safety and Health established under this Act.

(12) The term "Director" means the Director of the National Institute for Occupational Safety and Health.

(13) The term "Institute" means the National Institute for Occupational Safety and Health established under this Act.

(14) The term "Workmen's Compensation Commission" means the National Commission on State Workmen's Compensation Laws established under this Act.

**SEC. 4. Applicability of This Act**

(a) This Act shall apply with respect to employment performed in a workplace in a State, the District of Columbia, the Commonwealth of Puerto Rico, the Virgin Islands, American Samoa, Guam, the Trust Territory of the Pacific Islands, Wake Island, Outer Continental Shelf Lands defined in the Outer Continental Shelf Lands Act, Johnston Island, and the Canal Zone. The Secretary of the Interior shall, by regulation, provide for judicial enforcement of this Act by the courts established for areas in which there are no United States district courts having jurisdiction.

29 USC 653

For Canal Zone and Trust Territory coverage, including the Northern Mariana Islands, see *Historical notes*.

(b) (1) Nothing in this Act shall apply to working conditions of employees with respect to which other Federal agencies, and State agencies acting under section 274 of the Atomic Energy Act of 1954, as amended (42 U.S.C. 2021), exercise statutory authority to prescribe or enforce standards or regulations affecting occupational safety or health.

(2) The safety and health standards promulgated under the Act of June 30, 1936, commonly known as the Walsh-Healey Act (41 U.S.C. 35 et seq.), the Service Contract Act of 1965 (41 U.S.C. 351 et seq.), Public Law 91-54, Act of August 9, 1969 (40 U.S.C. 333), Public Law 85-742, Act of August 23, 1958 (33 U.S.C. 941), and the National Foundation on Arts and Humanities Act (20 U.S.C. 951 et seq.) are superseded on the effective date of corresponding standards, promulgated under this Act, which are determined by the Secretary to be more effective. Standards issued under the laws listed in this paragraph and in effect on or after the effective date of this Act shall be deemed to be occupational safety and health standards issued under this Act, as well as under such other Acts.

(3) The Secretary shall, within three years after the effective date of this Act, report to the Congress his recommendations for legislation to avoid unnecessary duplication and to achieve coordination between this Act and other Federal laws.

(4) Nothing in this Act shall be construed to supersede or in any manner affect any workmen's compensation law or to enlarge or diminish or affect in any other manner the common law or statutory rights, duties, or liabilities of employers and employees under any law with respect to injuries, diseases, or death of employees arising out of, or in the course of, employment.

#### SEC. 5. Duties

(a) Each employer --

(1) shall furnish to each of his employees employment and a place of employment which are free from recognized hazards that are causing or are likely to cause death or serious physical harm to his employees; 29 USC 654

(2) shall comply with occupational safety and health standards promulgated under this Act.

(b) Each employee shall comply with occupational safety and health standards and all rules, regulations, and orders issued pursuant to this Act which are applicable to his own actions and conduct.

#### 6. Occupational Safety and Health Standards

(a) Without regard to chapter 5 of title 5, United States Code, or to the other subsections of this section, the Secretary shall, as soon as practicable during the period beginning with the effective date of this Act and ending two years after such date, by rule promulgate as an occupational safety or health standard any national consensus standard, and any established Federal standard, unless he determines that the promulgation of such a standard would not result in improved safety or health for specifically designated employees. In the event of conflict among any such standards, the Secretary shall promulgate the standard which assures the greatest protection of the safety or health of the affected employees. 29 USC 655

(b) The Secretary may by rule promulgate, modify, or revoke any occupational safety or health standard in the following manner:

(1) Whenever the Secretary, upon the basis of information submitted to him in writing by an interested person, a representative of any organization of employers or employees, a nationally recognized standards-producing organization, the Secretary of Health and Human Services, the National Institute for Occupational Safety and Health, or a State or political subdivision, or on the basis of information developed by the Secretary or otherwise available to him, determines that a rule should be promulgated in order to serve the objectives of this Act, the Secretary may request the recommendations of an advisory committee appointed under section 7 of this Act. The Secretary shall provide such an advisory committee with any proposals of his own or of the Secretary of Health and Human Services, together with all pertinent factual information developed by the Secretary or the Secretary of Health and Human Services, or otherwise available, including the results of research, demonstrations, and experiments. An advisory committee shall submit to the Secretary its recommendations regarding the rule to be promulgated within ninety days from the date of its appointment or within such longer or shorter period as may be prescribed by the Secretary, but in no event for a period which is longer than two hundred and seventy days.

(2) The Secretary shall publish a proposed rule promulgating, modifying, or revoking an occupational safety or health standard in the Federal Register and shall afford interested persons a period of thirty days after publication to submit written data or comments. Where an advisory committee is appointed and the Secretary determines that a rule should be issued, he shall publish the proposed rule within sixty days after the submission of the advisory committee's recommendations or the expiration of the period prescribed by the Secretary for such submission.

(3) On or before the last day of the period provided for the submission of written data or comments under paragraph (2), any interested person may file with the Secretary written objections to the proposed rule, stating the grounds therefor and requesting a public hearing on such objections. Within thirty days after the last day for filing such objections, the Secretary shall publish in the Federal Register a notice specifying the occupational safety or health standard to which objections have been filed and a hearing requested, and specifying a time and place for such hearing.

(4) Within sixty days after the expiration of the period provided for the submission of

written data or comments under paragraph (2), or within sixty days after the completion of any hearing held under paragraph (3), the Secretary shall issue a rule promulgating, modifying, or revoking an occupational safety or health standard or make a determination that a rule should not be issued. Such a rule may contain a provision delaying its effective date for such period (not in excess of ninety days) as the Secretary determines may be necessary to insure that affected employers and employees will be informed of the existence of the standard and of its terms and that employers affected are given an opportunity to familiarize themselves and their employees with the existence of the requirements of the standard.

(5) The Secretary, in promulgating standards dealing with toxic materials or harmful physical agents under this subsection, shall set the standard which most adequately assures, to the extent feasible, on the basis of the best available evidence, that no employee will suffer material impairment of health or functional capacity even if such employee has regular exposure to the hazard dealt with by such standard for the period of his working life. Development of standards under this subsection shall be based upon research, demonstrations, experiments, and such other information as may be appropriate. In addition to the attainment of the highest degree of health and safety protection for the employee, other considerations shall be the latest available scientific data in the field, the feasibility of the standards, and experience gained under this and other health and safety laws. Whenever practicable, the standard promulgated shall be expressed in terms of objective criteria and of the performance desired.

(6) (A) Any employer may apply to the Secretary for a temporary order granting a variance from a standard or any provision thereof promulgated under this section. Such temporary order shall be granted only if the employer files an application which meets the requirements of clause (B) and establishes

that --

(i) he is unable to comply with a standard by its effective date because of unavailability of professional or technical personnel or of materials and equipment needed to come into compliance with the standard or because necessary construction or alteration of facilities cannot be completed by the effective date,

(ii) he is taking all available steps to safeguard his employees against the hazards covered by the standard, and

(iii) he has an effective program for coming into compliance with the standard as quickly as practicable.

Any temporary order issued under this paragraph shall prescribe the practices, means, methods, operations, and processes which the employer must adopt and use while the order is in effect and state in detail his program for coming into compliance with the standard. Such a temporary order may be granted only after notice to employees and an opportunity for a hearing: *Provided*, That the Secretary may issue one interim order to be effective until a decision is made on the basis of the hearing. No temporary order may be in effect for longer than the period needed by the employer to achieve compliance with the standard or one year, whichever is shorter, except that such an order may be renewed not more than twice (1) so long as the requirements of this paragraph are met and (II) if an application for renewal is filed at least 90 days prior to the expiration date of the order. No interim renewal of an order may remain in effect for longer than 180 days.

(B) An application for temporary order under this paragraph (6) shall contain:

(i) a specification of the standard or portion thereof from which the employer seeks a variance,

(ii) a representation by the employer, supported by representations from qualified persons having firsthand knowledge of the facts represented, that he is unable to comply with the standard or portion thereof and a detailed statement of the reasons therefor,

(iii) a statement of the steps he has taken and will take (with specific dates) to protect employees against the hazard covered by the standard,

(iv) a statement of when he expects to be able to comply with the standard and what steps he has taken and what steps he will take (with dates specified) to come into compliance with the standard, and

(v) a certification that he has informed his employees of the application by giving a copy thereof to their authorized representative, posting a statement giving a summary of the application and specifying where a copy may be examined at the place or places where notices to employees are normally posted, and by other appropriate means.

A description of how employees have been informed shall be contained in the certification. The information to employees shall also inform them of their right to petition the Secretary for a hearing.

(C) The Secretary is authorized to grant a variance from any standard or portion thereof whenever he determines, or the Secretary of Health and Human Services certifies, that such variance is necessary to permit an employer to participate in an experiment approved by him or the Secretary of Health and Human Services designed to demonstrate or validate new and improved techniques to safeguard the health or safety of workers.

(7) Any standard promulgated under this subsection shall prescribe the use of labels or other appropriate forms of warning as are necessary to insure that employees are apprised of all hazards to which they are exposed, relevant symptoms and appropriate emergency

treatment, and proper conditions and precautions of safe use or exposure. Where appropriate, such standard shall also prescribe suitable protective equipment and control or technological procedures to be used in connection with such hazards and shall provide for monitoring or measuring employee exposure at such locations and intervals, and in such manner as may be necessary for the protection of employees. In addition, where appropriate, any such standard shall prescribe the type and frequency of medical examinations or other tests which shall be made available, by the employer or at his cost, to employees exposed to such hazards in order to most effectively determine whether the health of such employees is adversely affected by such exposure. In the event such medical examinations are in the nature of research, as determined by the Secretary of Health and Human Services, such examinations may be furnished at the expense of the Secretary of Health and Human Services. The results of such examinations or tests shall be furnished only to the Secretary or the Secretary of Health and Human Services, and, at the request of the employee, to his physician. The Secretary, in consultation with the Secretary of Health and Human Services, may by rule promulgated pursuant to section 553 of title 5, United States Code, make appropriate modifications in the foregoing requirements relating to the use of labels or other forms of warning, monitoring or measuring, and medical examinations, as may be warranted by experience, information, or medical or technological developments acquired subsequent to the promulgation of the relevant standard.

(8) Whenever a rule promulgated by the Secretary differs substantially from an existing national consensus standard, the Secretary shall, at the same time, publish in the Federal Register a statement of the reasons why the rule as adopted will better effectuate the purposes of this Act than the national consensus standard.

(c) (1) The Secretary shall provide, without regard to the requirements of chapter 5, title 5, United States Code, for an emergency temporary standard to take immediate effect upon publication in the Federal Register if he determines --

(A) that employees are exposed to grave danger from exposure to substances or agents determined to be toxic or physically harmful or from new hazards, and

(B) that such emergency standard is necessary to protect employees from such danger.

(2) Such standard shall be effective until superseded by a standard promulgated in accordance with the procedures prescribed in paragraph (3) of this subsection.

(3) Upon publication of such standard in the Federal Register the Secretary shall commence a proceeding in accordance with section 6 (b) of this Act, and the standard as published shall also serve as a proposed rule for the proceeding. The Secretary shall promulgate a standard under this paragraph no later than six months after publication of the emergency standard as provided in paragraph (2) of this subsection.

(d) Any affected employer may apply to the Secretary for a rule or order for a variance from a standard promulgated under this section. Affected employees shall be given notice of each such application and an opportunity to participate in a hearing. The Secretary shall issue such rule or order if he determines on the record, after opportunity for an inspection where appropriate and a hearing, that the proponent of the variance has demonstrated by a preponderance of the evidence that the conditions, practices, means, methods, operations, or processes used or proposed to be used by an employer will provide employment and places of employment to his employees which are as safe and healthful as those which would prevail if he complied with the standard. The rule or order so issued shall prescribe the conditions the employer must maintain, and the practices, means, methods, operations, and processes which he must adopt and utilize to the extent they differ from the standard in question. Such a rule or order may be modified or revoked upon application by an employer, employees, or by the Secretary on his own motion, in the manner prescribed for its issuance under this subsection at any time after six months from its issuance.

(e) Whenever the Secretary promulgates any standard, makes any rule, order, or decision, grants any exemption or extension of time, or compromises, mitigates, or settles any penalty assessed under this Act, he shall include a statement of the reasons for such action, which shall be published in the Federal Register.

(f) Any person who may be adversely affected by a standard issued under this section may at any time prior to the sixtieth day after such standard is promulgated file a petition challenging the validity of such standard with the United States court of appeals for the circuit wherein such person resides or has his principal place of business, for a judicial review of such standard. A copy of the petition shall be forthwith transmitted by the clerk of the court to the Secretary. The filing of such petition shall not, unless otherwise ordered by the court, operate as a stay of the standard. The determinations of the Secretary shall be conclusive if supported by substantial evidence in the record considered as a whole.

(g) In determining the priority for establishing standards under this section, the Secretary shall give due regard to the urgency of the need for mandatory safety and health standards for particular industries, trades, crafts, occupations, businesses, workplaces or work environments. The Secretary shall also give due regard to the recommendations of the Secretary of Health and Human Services regarding the need for mandatory standards in determining the priority for establishing such standards.

---

#### SEC. 7. Advisory Committees; Administration

(a) (1) There is hereby established a National Advisory Committee on Occupational Safety and Health consisting of twelve members appointed by the Secretary, four of whom are to be designated by the Secretary of Health and Human Services, without regard to the provisions

29 USC 656

of title 5, United States Code, governing appointments in the competitive service, and composed of representatives of management, labor, occupational safety and occupational health professions, and of the public. The Secretary shall designate one of the public members as Chairman. The members shall be selected upon the basis of their experience and competence in the field of occupational safety and health.

(2) The Committee shall advise, consult with, and make recommendations to the Secretary and the Secretary of Health and Human Services on matters relating to the administration of the Act. The Committee shall hold no fewer than two meetings during each calendar year. All meetings of the Committee shall be open to the public and a transcript shall be kept and made available for public inspection.

(3) The members of the Committee shall be compensated in accordance with the provisions of section 3109 of title 5, United States Code.

(4) The Secretary shall furnish to the Committee an executive secretary and such secretarial, clerical, and other services as are deemed necessary to the conduct of its business.

(b) An advisory committee may be appointed by the Secretary to assist him in his standard-setting functions under section 6 of this Act. Each such committee shall consist of not more than fifteen members and shall include as a member one or more designees of the Secretary of Health and Human Services, and shall include among its members an equal number of persons qualified by experience and affiliation to present the viewpoint of the employers involved, and of persons similarly qualified to present the viewpoint of the workers involved, as well as one or more representatives of health and safety agencies of the States. An advisory committee may also include such other persons as the Secretary may appoint who are qualified by knowledge and experience to make a useful contribution to the work of such committee, including one or more representatives of professional organizations of technicians or professionals specializing in occupational safety or health, and one or more representatives of nationally recognized standards producing organizations, but the number of persons so appointed to any such advisory committee shall not exceed the number appointed to such committee as representatives of Federal and State agencies. Persons appointed to advisory committees from private life shall be compensated in the same manner as consultants or experts under section 3109 of title 5, United States Code. The Secretary shall pay to any State which is the employer of a member of such a committee who is a representative of the health or safety agency of that State, reimbursement sufficient to cover the actual cost to the State resulting from such representative's membership on such committee. Any meeting of such committee shall be open to the public and an accurate record shall be kept and made available to the public. No member of such committee (other than representatives of employers and employees) shall have an economic interest in any proposed rule.

(c) In carrying out his responsibilities under this Act, the Secretary is authorized

to --

(1) use, with the consent of any Federal agency, the services, facilities, and personnel of such agency, with or without reimbursement, and with the consent of any State or political subdivision thereof, accept and use the services, facilities, and personnel of any agency of such State or subdivision with reimbursement; and

(2) employ experts and consultants or organizations thereof as authorized by section 3109 of title 5, United States Code, except that contracts for such employment may be renewed annually; compensate individuals so employed at rates not in excess of the rate specified at the time of service for grade GS-18 under section 5332 of title 5, United States Code, including travel time, and allow them while away from their homes or regular places of business, travel expenses (including per diem in lieu of subsistence) as authorized by section 5703 of title 5, United States Code, for persons in the Government service employed intermittently, while so employed.

#### **SEC. 8. Inspections, Investigations, and Recordkeeping**

(a) In order to carry out the purposes of this Act, the Secretary, upon presenting appropriate credentials to the owner, operator, or agent in charge, is authorized -- 29 USC 657

(1) to enter without delay and at reasonable times any factory, plant, establishment, construction site, or other area, workplace or environment where work is performed by an employee of an employer; and

(2) to inspect and investigate during regular working hours and at other reasonable times, and within reasonable limits and in a reasonable manner, any such place of employment and all pertinent conditions, structures, machines, apparatus, devices, equipment, and materials therein, and to question privately any such employer, owner, operator, agent or employee.

(b) In making his inspections and investigations under this Act the Secretary may require the attendance and testimony of witnesses and the production of evidence under oath. Witnesses shall be paid the same fees and mileage that are paid witnesses in the courts of the United States. In case of a contumacy, failure, or refusal of any person to obey such an order, any district court of the United States or the United States courts of any territory or possession, within the jurisdiction of which such person is found, or resides or transacts business, upon the application by the Secretary, shall have jurisdiction to issue to such person an order requiring such person to appear to produce evidence if, as, and when so ordered, and to give testimony relating to the matter under investigation or in question, and any failure to obey such order of the court may be

punished by said court as a contempt thereof.

(c) (1) Each employer shall make, keep and preserve, and make available to the Secretary or the Secretary of Health and Human Services, such records regarding his activities relating to this Act as the Secretary, in cooperation with the Secretary of Health and Human Services, may prescribe by regulation as necessary or appropriate for the enforcement of this Act or for developing information regarding the causes and prevention of occupational accidents and illnesses. In order to carry out the provisions of this paragraph such regulations may include provisions requiring employers to conduct periodic inspections. The Secretary shall also issue regulations requiring that employers, through posting of notices or other appropriate means, keep their employees informed of their protections and obligations under this Act, including the provisions of applicable standards.

(2) The Secretary, in cooperation with the Secretary of Health and Human Services, shall prescribe regulations requiring employers to maintain accurate records of, and to make periodic reports on, work-related deaths, injuries and illnesses other than minor injuries requiring only first aid treatment and which do not involve medical treatment, loss of consciousness, restriction of work or motion, or transfer to another job.

(3) The Secretary, in cooperation with the Secretary of Health and Human Services, shall issue regulations requiring employers to maintain accurate records of employee exposures to potentially toxic materials or harmful physical agents which are required to be monitored or measured under section 6. Such regulations shall provide employees or their representatives with an opportunity to observe such monitoring or measuring, and to have access to the records thereof. Such regulations shall also make appropriate provision for each employee or former employee to have access to such records as will indicate his own exposure to toxic materials or harmful physical agents. Each employer shall promptly notify any employee who has been or is being exposed to toxic materials or harmful physical agents in concentrations or at levels which exceed those prescribed by an applicable occupational safety and health standard promulgated under section 6, and shall inform any employee who is being thus exposed of the corrective action being taken.

(d) Any information obtained by the Secretary, the Secretary of Health and Human Services, or a State agency under this Act shall be obtained with a minimum burden upon employers, especially those operating small businesses. Unnecessary duplication of efforts in obtaining information shall be reduced to the maximum extent feasible.

(e) Subject to regulations issued by the Secretary, a representative of the employer and a representative authorized by his employees shall be given an opportunity to accompany the Secretary or his authorized representative during the physical inspection of any workplace under subsection (a) for the purpose of aiding such inspection. Where there is no authorized employee representative, the Secretary or his authorized representative shall consult with a reasonable number of employees concerning matters of health and safety in the workplace.

(f) (1) Any employees or representative of employees who believe that a violation of a safety or health standard exists that threatens physical harm, or that an imminent danger exists, may request an inspection by giving notice to the Secretary or his authorized representative of such violation or danger. Any such notice shall be reduced to writing, shall set forth with reasonable particularity the grounds for the notice, and shall be signed by the employees or representative of employees, and a copy shall be provided the employer or his agent no later than at the time of inspection, except that, upon the request of the person giving such notice, his name and the names of individual employees referred to therein shall not appear in such copy or on any record published, released, or made available pursuant to subsection (g) of this section. If upon receipt of such notification the Secretary determines there are reasonable grounds to believe that such violation or danger exists, he shall make a special inspection in accordance with the provisions of this section as soon as practicable, to determine if such violation or danger exists. If the Secretary determines there are no reasonable grounds to believe that a violation or danger exists he shall notify the employees or representative of the employees in writing of such determination.

(2) Prior to or during any inspection of a workplace, any employees or representative of employees employed in such workplace may notify the Secretary or any representative of the Secretary responsible for conducting the inspection, in writing, of any violation of this Act which they have reason to believe exists in such workplace. The Secretary shall, by regulation, establish procedures for informal review of any refusal by a representative of the Secretary to issue a citation with respect to any such alleged violation and shall furnish the employees or representative of employees requesting such review a written statement of the reasons for the Secretary's final disposition of the case.

(g) (1) The Secretary and Secretary of Health and Human Services are authorized to compile, analyze, and publish, either in summary or detailed form, all reports or information obtained under this section.

(2) The Secretary and the Secretary of Health and Human Services shall each prescribe such rules and regulations as he may deem necessary to carry out their responsibilities under this Act, including rules and regulations dealing with the inspection of an employer's establishment.

(h) The Secretary shall not use the results of enforcement activities, such as the number of citations issued or penalties assessed, to evaluate employees directly involved in enforcement activities under this Act or to impose quotas or goals with regard to the results of such activities.

Pub. L. 105-196 added subsection (h).

**SEC. 9. Citations**

29 USC 658

(a) If, upon inspection or investigation, the Secretary or his authorized representative believes that an employer has violated a requirement of section 5 of this Act, of any standard, rule or order promulgated pursuant to section 6 of this Act, or of any regulations

prescribed pursuant to this Act, he shall with reasonable promptness issue a citation to the employer. Each citation shall be in writing and shall describe with particularity the nature of the violation, including a reference to the provision of the Act, standard, rule, regulation, or order alleged to have been violated. In addition, the citation shall fix a reasonable time for the abatement of the violation. The Secretary may prescribe procedures for the issuance of a notice in lieu of a citation with respect to de minimis violations which have no direct or immediate relationship to safety or health.

(b) Each citation issued under this section, or a copy or copies thereof, shall be prominently posted, as prescribed in regulations issued by the Secretary, at or near each place a violation referred to in the citation occurred.

(c) No citation may be issued under this section after the expiration of six months following the occurrence of any violation.

---

#### SEC. 10. Procedure for Enforcement

(a) If, after an inspection or investigation, the Secretary issues a citation under section 9(a), he shall, within a reasonable time after the termination of such inspection or investigation, notify the employer by certified mail of the penalty, if any, proposed to be assessed under section 17 and that the employer has fifteen working days within which to notify the Secretary that he wishes to contest the citation or proposed assessment of penalty. If, within fifteen working days from the receipt of the notice issued by the Secretary the employer fails to notify the Secretary that he intends to contest the citation or proposed assessment of penalty, and no notice is filed by any employee or representative of employees under subsection (c) within such time, the citation and the assessment, as proposed, shall be deemed a final order of the Commission and not subject to review by any court or agency. 29 USC 659

(b) If the Secretary has reason to believe that an employer has failed to correct a violation for which a citation has been issued within the period permitted for its correction (which period shall not begin to run until the entry of a final order by the Commission in the case of any review proceedings under this section initiated by the employer in good faith and not solely for delay or avoidance of penalties), the Secretary shall notify the employer by certified mail of such failure and of the penalty proposed to be assessed under section 17 by reason of such failure, and that the employer has fifteen working days within which to notify the Secretary that he wishes to contest the Secretary's notification or the proposed assessment of penalty. If, within fifteen working days from the receipt of notification issued by the Secretary, the employer fails to notify the Secretary that he intends to contest the notification or proposed assessment of penalty, the notification and assessment, as proposed, shall be deemed a final order of the Commission and not subject to review by any court or agency.

(c) If an employer notifies the Secretary that he intends to contest a citation issued under section 9(a) or notification issued under subsection (a) or (b) of this section, or if, within fifteen working days of the issuance of a citation under section 9(a), any employee or representative of employees files a notice with the Secretary alleging that the period of time fixed in the citation for the abatement of the violation is unreasonable, the Secretary shall immediately advise the Commission of such notification, and the Commission shall afford an opportunity for a hearing (in accordance with section 554 of title 5, United States Code, but without regard to subsection (a)(3) of such section). The Commission shall thereafter issue an order, based on findings of fact, affirming, modifying, or vacating the Secretary's citation or proposed penalty, or directing other appropriate relief, and such order shall become final thirty days after its issuance. Upon a showing by an employer of a good faith effort to comply with the abatement requirements of a citation, and that abatement has not been completed because of factors beyond his reasonable control, the Secretary, after an opportunity for a hearing as provided in this subsection, shall issue an order affirming or modifying the abatement requirements in such citation. The rules of procedure prescribed by the Commission shall provide affected employees or representatives of affected employees an opportunity to participate as parties to hearings under this subsection.

---

#### SEC. 11. Judicial Review

(a) Any person adversely affected or aggrieved by an order of the Commission issued under subsection (c) of section 10 may obtain a review of such order in any United States court of appeals for the circuit in which the violation is alleged to have occurred or where the employer has its principal office, or in the Court of Appeals for the District of Columbia Circuit, by filing in such court within sixty days following the issuance of such order a written petition praying that the order be modified or set aside. A copy of such petition shall be forthwith transmitted by the clerk of the court to the Commission and to the other parties, and thereupon the Commission shall file in the court the record in the proceeding as provided in section 2112 of title 28, United States Code. Upon such filing, the court shall have jurisdiction of the proceeding and of the question determined therein, and shall have power to grant such temporary relief or restraining order as it deems just and proper, and to make and enter upon the pleadings, testimony, and proceedings set forth in such record a decree affirming, modifying, or setting aside in whole or in part, the order of the Commission and enforcing the same to the extent that such order is affirmed or modified. The commencement of proceedings under this subsection shall not, unless ordered by the court, operate as a stay of the order of the Commission. No objection that has not been urged before the Commission shall be considered by the court, unless the failure or neglect to urge such objection shall be excused because of extraordinary circumstances. The findings of the Commission with respect to questions of fact, if supported by substantial evidence on the record considered as a whole, shall be conclusive. If any party shall apply to the court for leave to adduce additional evidence and shall show to the satisfaction of the court that such additional evidence is material and that there were reasonable grounds for the failure to adduce such evidence in the hearing before the Commission, the court may order such additional evidence to be taken before the Commission and to be made a part of the record. 29 USC 660

The Commission may modify its findings as to the facts, or make new findings, by reason of additional evidence so taken and filed, and it shall file such modified or new findings, which findings with respect to questions of fact, if supported by substantial evidence on the record considered as a whole, shall be conclusive, and its recommendations, if any, for the modification or setting aside of its original order. Upon the filing of the record with it, the jurisdiction of the court shall be exclusive and its judgment and decree shall be final, except that the same shall be subject to review by the Supreme Court of the United States, as provided in section 1254 of title 28, United States Code.

(b) The Secretary may also obtain review or enforcement of any final order of the Commission by filing a petition for such relief in the United States court of appeals for the circuit in which the alleged violation occurred or in which the employer has its principal office, and the provisions of subsection (a) shall govern such proceedings to the extent applicable. If no petition for review, as provided in subsection (a), is filed within sixty days after service of the Commission's order, the Commission's findings of fact and order shall be conclusive in connection with any petition for enforcement which is filed by the Secretary after the expiration of such sixty-day period. In any such case, as well as in the case of a noncontested citation or notification by the Secretary which has become a final order of the Commission under subsection (a) or (b) of section 10, the clerk of the court, unless otherwise ordered by the court, shall forthwith enter a decree enforcing the order and shall transmit a copy of such decree to the Secretary and the employer named in the petition. In any contempt proceeding brought to enforce a decree of a court of appeals entered pursuant to this subsection or subsection (a), the court of appeals may assess the penalties provided in section 17, in addition to invoking any other available remedies.

Pub. L. 98-620

(c) (1) No person shall discharge or in any manner discriminate against any employee because such employee has filed any complaint or instituted or caused to be instituted any proceeding under or related to this Act or has testified or is about to testify in any such proceeding or because of the exercise by such employee on behalf of himself or others of any right afforded by this Act.

(2) Any employee who believes that he has been discharged or otherwise discriminated against by any person in violation of this subsection may, within thirty days after such violation occurs, file a complaint with the Secretary alleging such discrimination. Upon receipt of such complaint, the Secretary shall cause such investigation to be made as he deems appropriate. If upon such investigation, the Secretary determines that the provisions of this subsection have been violated, he shall bring an action in any appropriate United States district court against such person. In any such action the United States district courts shall have jurisdiction, for cause shown to restrain violations of paragraph (1) of this subsection and order all appropriate relief including rehiring or reinstatement of the employee to his former position with back pay.

(3) Within 90 days of the receipt of a complaint filed under this subsection the Secretary shall notify the complainant of his determination under paragraph 2 of this subsection.

#### SEC. 12. The Occupational Safety and Health Review Commission

(a) The Occupational Safety and Health Review Commission is hereby established. The Commission shall be composed of three members who shall be appointed by the President, by and with the advice and consent of the Senate, from among persons who by reason of training, education, or experience are qualified to carry out the functions of the Commission under this Act. The President shall designate one of the members of the Commission to serve as Chairman.

29 USC 661

(b) The terms of members of the Commission shall be six years except that

(1) the members of the Commission first taking office shall serve, as designated by the President at the time of appointment, one for a term of two years, one for a term of four years, and one for a term of six years; and

(2) a vacancy caused by the death, resignation, or removal of a member prior to the expiration of the term for which he was appointed shall be filled only for the remainder of such unexpired term.

A member of the Commission may be removed by the President for inefficiency, neglect of duty, or malfeasance in office.

(c) (Text omitted.)

*See notes on omitted text.*

(d) The principal office of the Commission shall be in the District of Columbia. Whenever the Commission deems that the convenience of the public or of the parties may be promoted, or delay or expense may be minimized, it may hold hearings or conduct other proceedings at any other place.

Pub. L. 95-251

(e) The Chairman shall be responsible on behalf of the Commission for the administrative operations of the Commission and shall appoint such administrative law judges and other employees as he deems necessary to assist in the performance of the Commission's functions and to fix their compensation in accordance with the provisions of chapter 51 and subchapter III of chapter 53 of title 5, United States Code, relating to classification and General Schedule pay rates: *Provided*, That assignment, removal and compensation of administrative law judges shall be in accordance with sections 3105, 3344, 5372, and 7521 of title 5, United States Code.

(f) For the purpose of carrying out its functions under this Act, two members of the Commission shall constitute a quorum and official action can be taken only on the affirmative



vote of at least two members.

(g) Every official act of the Commission shall be entered of record, and its hearings and records shall be open to the public. The Commission is authorized to make such rules as are necessary for the orderly transaction of its proceedings. Unless the Commission has adopted a different rule, its proceedings shall be in accordance with the Federal Rules of Civil Procedure.

(h) The Commission may order testimony to be taken by deposition in any proceedings pending before it at any state of such proceeding. Any person may be compelled to appear and depose, and to produce books, papers, or documents, in the same manner as witnesses may be compelled to appear and testify and produce like documentary evidence before the Commission. Witnesses whose depositions are taken under this subsection, and the persons taking such depositions, shall be entitled to the same fees as are paid for like services in the courts of the United States.

(i) For the purpose of any proceeding before the Commission, the provisions of section 11 of the National Labor Relations Act (29 U.S.C. 161) are hereby made applicable to the jurisdiction and powers of the Commission.

(j) An administrative law judge appointed by the Commission shall hear, and make a determination upon, any proceeding instituted before the Commission and any motion in connection therewith, assigned to such administrative law judge by the Chairman of the Commission, and shall make a report of any such determination which constitutes his final disposition of the proceedings. The report of the administrative law judge shall become the final order of the Commission within thirty days after such report by the administrative law judge, unless within such period any Commission member has directed that such report shall be reviewed by the Commission.

(k) Except as otherwise provided in this Act, the administrative law judges shall be subject to the laws governing employees in the classified civil service, except that appointments shall be made without regard to section 5108 of title 5, United States Code. Each administrative law judge shall receive compensation at a rate not less than that prescribed for GS-16 under section 5332 of title 5, United States Code.

**SEC. 13. Procedures to Counteract Imminent Dangers**

(a) The United States district courts shall have jurisdiction, upon petition of the Secretary, to restrain any conditions or practices in any place of employment which are such that a danger exists which could reasonably be expected to cause death or serious physical harm immediately or before the imminence of such danger can be eliminated through the enforcement procedures otherwise provided by this Act. Any order issued under this section may require such steps to be taken as may be necessary to avoid, correct, or remove such imminent danger and prohibit the employment or presence of any individual in locations or under conditions where such imminent danger exists, except individuals whose presence is necessary to avoid, correct, or remove such imminent danger or to maintain the capacity of a continuous process operation to resume normal operations without a complete cessation of operations, or where a cessation of operations is necessary, to permit such to be accomplished in a safe and orderly manner.

29 USC 662

(b) Upon the filing of any such petition the district court shall have jurisdiction to grant such injunctive relief or temporary restraining order pending the outcome of an enforcement proceeding pursuant to this Act. The proceeding shall be as provided by Rule 65 of the Federal Rules, Civil Procedure, except that no temporary restraining order issued without notice shall be effective for a period longer than five days.

(c) Whenever and as soon as an inspector concludes that conditions or practices described in subsection (a) exist in any place of employment, he shall inform the affected employees and employers of the danger and that he is recommending to the Secretary that relief be sought.

(d) If the Secretary arbitrarily or capriciously fails to seek relief under this section, any employee who may be injured by reason of such failure, or the representative of such employees, might bring an action against the Secretary in the United States district court for the district in which the imminent danger is alleged to exist or the employer has its principal office, or for the District of Columbia, for a writ of mandamus to compel the Secretary to seek such an order and for such further relief as may be appropriate.

**SEC. 14. Representation in Civil Litigation**

Except as provided in section 518(a) of title 28, United States Code, relating to litigation before the Supreme Court, the Solicitor of Labor may appear for and represent the Secretary in any civil litigation brought under this Act but all such litigation shall be subject to the direction and control of the Attorney General.

29 USC 663

**SEC. 15. Confidentiality of Trade Secrets**

All information reported to or otherwise obtained by the Secretary or his representative in connection with any inspection or proceeding under this Act which contains or which might reveal a trade secret referred to in section 1905 of title 18 of the United States Code shall be considered confidential for the purpose of that section, except that such information may be disclosed to other officers or employees concerned with carrying out this Act or when relevant in any proceeding under this Act. In any such proceeding the Secretary, the Commission, or the court shall issue such orders as may be appropriate to protect the

29 USC 664

confidentiality of trade secrets.

**16. Variations, Tolerances, and Exemptions**

The Secretary, on the record, after notice and opportunity for a hearing may provide such reasonable limitations and may make such rules and regulations allowing reasonable variations, tolerances, and exemptions to and from any or all provisions of this Act as he may find necessary and proper to avoid serious impairment of the national defense. Such action shall not be in effect for more than six months without notification to affected employees and an opportunity being afforded for a hearing. 29 USC 665

**SEC. 17. Penalties**

(a) Any employer who willfully or repeatedly violates the requirements of section 5 of this Act, any standard, rule, or order promulgated pursuant to section 6 of this Act, or regulations prescribed pursuant to this Act, may be assessed a civil penalty of not more than \$70,000 for each violation, but not less than \$5,000 for each willful violation. 29 USC 666

Pub. L. 101-508 increased the civil penalties in subsections (a)-(d) & (f). See Historical notes.

(b) Any employer who has received a citation for a serious violation of the requirements of section 5 of this Act, of any standard, rule, or order promulgated pursuant to section 6 of this Act, or of any regulations prescribed pursuant to this Act, shall be assessed a civil penalty of up to \$7,000 for each such violation.

(c) Any employer who has received a citation for a violation of the requirements of section 5 of this Act, of any standard, rule, or order promulgated pursuant to section 6 of this Act, or of regulations prescribed pursuant to this Act, and such violation is specifically determined not to be of a serious nature, may be assessed a civil penalty of up to \$7,000 for each violation.

(d) Any employer who fails to correct a violation for which a citation has been issued under section 9(a) within the period permitted for its correction (which period shall not begin to run until the date of the final order of the Commission in the case of any review proceeding under section 10 initiated by the employer in good faith and not solely for delay or avoidance of penalties), may be assessed a civil penalty of not more than \$7,000 for each day during which such failure or violation continues.

(e) Any employer who willfully violates any standard, rule, or order promulgated pursuant to section 6 of this Act, or of any regulations prescribed pursuant to this Act, and that violation caused death to any employee, shall, upon conviction, be punished by a fine of not more than \$10,000 or by imprisonment for not more than six months, or by both; except that if the conviction is for a violation committed after a first conviction of such person, punishment shall be by a fine of not more than \$20,000 or by imprisonment for not more than one year, or by both. Pub. L. 98-473 Maximum criminal fines are increased by the Sentencing Reform Act of 1984, 18 USC § 3551 et seq. See Historical notes.

(f) Any person who gives advance notice of any inspection to be conducted under this Act, without authority from the Secretary or his designees, shall, upon conviction, be punished by a fine of not more than \$1,000 or by imprisonment for not more than six months, or by both. See historical notes.

(g) Whoever knowingly makes any false statement, representation, or certification in any application, record, report, plan, or other document filed or required to be maintained pursuant to this Act shall, upon conviction, be punished by a fine of not more than \$10,000, or by imprisonment for not more than six months, or by both.

(h) (1) Section 1114 of title 18, United States Code, is hereby amended by striking out "designated by the Secretary of Health and Human Services to conduct investigations, or inspections under the Federal Food, Drug, and Cosmetic Act" and inserting in lieu thereof "or of the Department of Labor assigned to perform investigative, inspection, or law enforcement functions".

(2) Notwithstanding the provisions of sections 1111 and 1114 of title 18, United States Code, whoever, in violation of the provisions of section 1114 of such title, kills a person while engaged in or on account of the performance of investigative, inspection, or law enforcement functions added to such section 1114 by paragraph (1) of this subsection, and who would otherwise be subject to the penalty provisions of such section 1111, shall be punished by imprisonment for any term of years or for life.

(i) Any employer who violates any of the posting requirements, as prescribed under the provisions of this Act, shall be assessed a civil penalty of up to \$7,000 for each violation.

(j) The Commission shall have authority to assess all civil penalties provided in this section, giving due consideration to the appropriateness of the penalty with respect to the size of the business of the employer being charged, the gravity of the violation, the good faith of the employer, and the history of previous violations.

(k) For purposes of this section, a serious violation shall be deemed to exist in a place of employment if there is a substantial probability that death or serious physical harm could result from a condition which exists, or from one or more practices, means, methods, operations, or processes which have been adopted or are in use, in such place of employment unless the employer did not, and could not with the exercise of reasonable diligence, know of the presence of the violation.

(l) Civil penalties owed under this Act shall be paid to the Secretary for deposit into the Treasury of the United States and shall accrue to the United States and may be recovered in

a civil action in the name of the United States brought in the United States district court for the district where the violation is alleged to have occurred or where the employer has its principal office.

#### SEC. 18. State Jurisdiction and State Plans

(a) Nothing in this Act shall prevent any State agency or court from asserting jurisdiction under State law over any occupational safety or health issue with respect to which no standard is in effect under section 6. 29 USC 667

(b) Any State which, at any time, desires to assume responsibility for development and enforcement therein of occupational safety and health standards relating to any occupational safety or health issue with respect to which a Federal standard has been promulgated under section 6 shall submit a State plan for the development of such standards and their enforcement.

(c) The Secretary shall approve the plan submitted by a State under subsection (b), or any modification thereof, if such plan in his judgement --

- (1) designates a State agency or agencies as the agency or agencies responsible for administering the plan throughout the State,
- (2) provides for the development and enforcement of safety and health standards relating to one or more safety or health issues, which standards (and the enforcement of which standards) are or will be at least as effective in providing safe and healthful employment and places of employment as the standards promulgated under section 6 which relate to the same issues, and which standards, when applicable to products which are distributed or used in interstate commerce, are required by compelling local conditions and do not unduly burden interstate commerce,
- (3) provides for a right of entry and inspection of all workplaces subject to the Act which is at least as effective as that provided in section 8, and includes a prohibition on advance notice of inspections,
- (4) contains satisfactory assurances that such agency or agencies have or will have the legal authority and qualified personnel necessary for the enforcement of such standards,
- (5) gives satisfactory assurances that such State will devote adequate funds to the administration and enforcement of such standards,
- (6) contains satisfactory assurances that such State will, to the extent permitted by its law, establish and maintain an effective and comprehensive occupational safety and health program applicable to all employees of public agencies of the State and its political subdivisions, which program is as effective as the standards contained in an approved plan,
- (7) requires employers in the State to make reports to the Secretary in the same manner and to the same extent as if the plan were not in effect, and
- (8) provides that the State agency will make such reports to the Secretary in such form and containing such information, as the Secretary shall from time to time require.

(d) If the Secretary rejects a plan submitted under subsection (b), he shall afford the State submitting the plan due notice and opportunity for a hearing before so doing.

(e) After the Secretary approves a State plan submitted under subsection (b), he may, but shall not be required to, exercise his authority under sections 8, 9, 10, 13, and 17 with respect to comparable standards promulgated under section 6, for the period specified in the next sentence. The Secretary may exercise the authority referred to above until he determines, on the basis of actual operations under the State plan, that the criteria set forth in subsection (c) are being applied, but he shall not make such determination for at least three years after the plan's approval under subsection (c). Upon making the determination referred to in the preceding sentence, the provisions of sections 5(a)(2), 8 (except for the purpose of carrying out subsection (f) of this section), 9, 10, 13, and 17, and standards promulgated under section 6 of this Act, shall not apply with respect to any occupational safety or health issues covered under the plan, but the Secretary may retain jurisdiction under the above provisions in any proceeding commenced under section 9 or 10 before the date of determination.

(f) The Secretary shall, on the basis of reports submitted by the State agency and his own inspections make a continuing evaluation of the manner in which each State having a plan approved under this section is carrying out such plan. Whenever the Secretary finds, after affording due notice and opportunity for a hearing, that in the administration of the State plan there is a failure to comply substantially with any provision of the State plan (or any assurance contained therein), he shall notify the State agency of his withdrawal of approval of such plan and upon receipt of such notice such plan shall cease to be in effect, but the State may retain jurisdiction in any case commenced before the withdrawal of the plan in order to enforce standards under the plan whenever the issues involved do not relate to the reasons for the withdrawal of the plan.

(g) The State may obtain a review of a decision of the Secretary withdrawing approval of or rejecting its plan by the United States court of appeals for the circuit in which the State is located by filing in such court within thirty days following receipt of notice of such decision a petition to modify or set aside in whole or in part the action of the Secretary. A copy of such petition shall forthwith be served upon the Secretary, and thereupon the Secretary shall

certify and file in the court the record upon which the decision complained of was issued as provided in section 2112 of title 28, United States Code. Unless the court finds that the Secretary's decision in rejecting a proposed State plan or withdrawing his approval of such a plan is not supported by substantial evidence the court shall affirm the Secretary's decision. The judgment of the court shall be subject to review by the Supreme Court of the United States upon certiorari or certification as provided in section 1254 of title 28, United States Code.

(h) The Secretary may enter into an agreement with a State under which the State will be permitted to continue to enforce one or more occupational health and safety standards in effect in such State until final action is taken by the Secretary with respect to a plan submitted by a State under subsection (b) of this section, or two years from the date of enactment of this Act, whichever is earlier.

**SEC. 19. Federal Agency Safety Programs and Responsibilities**

(a) It shall be the responsibility of the head of each Federal agency (not including the United States Postal Service) to establish and maintain an effective and comprehensive occupational safety and health program which is consistent with the standards promulgated under section 6. The head of each agency shall (after consultation with representatives of the employees thereof) --

29 USC 668

- (1) provide safe and healthful places and conditions of employment, consistent with the standards set under section 6; Pub. L. 50-241
- (2) acquire, maintain, and require the use of safety equipment, personal protective equipment, and devices reasonably necessary to protect employees;
- (3) keep adequate records of all occupational accidents and illnesses for proper evaluation and necessary corrective action;
- (4) consult with the Secretary with regard to the adequacy as to form and content of records kept pursuant to subsection (a)(3) of this section; and
- (5) make an annual report to the Secretary with respect to occupational accidents and injuries and the agency's program under this section. Such report shall include any report submitted under section 7902(e)(2) of title 5, United States Code.

(b) The Secretary shall report to the President a summary or digest of reports submitted to him under subsection (a)(5) of this section, together with his evaluations of and recommendations derived from such reports. Pub. L. 97-375

(c) Section 7902(c)(1) of title 5, United States Code, is amended by inserting after "agencies" the following: "and of labor organizations representing employees".

(d) The Secretary shall have access to records and reports kept and filed by Federal agencies pursuant to subsections (a)(3) and (5) of this section unless those records and reports are specifically required by Executive order to be kept secret in the interest of the national defense or foreign policy, in which case the Secretary shall have access to such information as will not jeopardize national defense or foreign policy.

**SEC. 20. Research and Related Activities**

(a) (1) The Secretary of Health and Human Services, after consultation with the Secretary and with other appropriate Federal departments or agencies, shall conduct (directly or by grants or contracts) research, experiments, and demonstrations relating to occupational safety and health, including studies of psychological factors involved, and relating to innovative methods, techniques, and approaches for dealing with occupational safety and health problems. 29 USC 669

(2) The Secretary of Health and Human Services shall from time to time consult with the Secretary in order to develop specific plans for such research, demonstrations, and experiments as are necessary to produce criteria, including criteria identifying toxic substances, enabling the Secretary to meet his responsibility for the formulation of safety and health standards under this Act; and the Secretary of Health and Human Services, on the basis of such research, demonstrations, and experiments and any other information available to him, shall develop and publish at least annually such criteria as will effectuate the purposes of this Act.

(3) The Secretary of Health and Human Services, on the basis of such research, demonstrations, and experiments, and any other information available to him, shall develop criteria dealing with toxic materials and harmful physical agents and substances which will describe exposure levels that are safe for various periods of employment, including but not limited to the exposure levels at which no employee will suffer impaired health or functional capacities or diminished life expectancy as a result of his work experience.

(4) The Secretary of Health and Human Services shall also conduct special research, experiments, and demonstrations relating to occupational safety and health as are necessary to explore new problems, including those created by new technology in occupational safety and health, which may require ameliorative action beyond that which is otherwise provided for in the operating provisions of this Act. The Secretary of Health and Human Services shall also conduct research into the motivational and behavioral factors relating to the field of occupational safety and health.

(5) The Secretary of Health and Human Services, in order to comply with his responsibilities under paragraph (2), and in order to develop needed information regarding potentially toxic substances or harmful physical agents, may prescribe regulations requiring employers to measure, record, and make reports on the exposure of employees to substances or physical agents which the Secretary of Health and Human Services reasonably believes may endanger the health or safety of employees. The Secretary of Health and Human Services also is authorized to establish such programs of medical examinations and tests as may be necessary for determining the incidence of occupational illnesses and the susceptibility of employees to such illnesses. Nothing in this or any other provision of this Act shall be deemed to authorize or require medical examination, immunization, or treatment for those who object thereto on religious grounds, except where such is necessary for the protection of the health or safety of others. Upon the request of any employer who is required to measure and record exposure of employees to substances or physical agents as provided under this subsection, the Secretary of Health and Human Services shall furnish full financial or other assistance to such employer for the purpose of defraying any additional expense incurred by him in carrying out the measuring and recording as provided in this subsection.

(6) The Secretary of Health and Human Services shall publish within six months of enactment of this Act and thereafter as needed but at least annually a list of all known toxic substances by generic family or other useful grouping, and the concentrations at which such toxicity is known to occur. He shall determine following a written request by any employer or authorized representative of employees, specifying with reasonable particularity the grounds on which the request is made, whether any substance normally found in the place of employment has potentially toxic effects in such concentrations as used or found; and shall submit such determination both to employers and affected employees as soon as possible. If the Secretary of Health and Human Services determines that any substance is potentially toxic at the concentrations in which it is used or found in a place of employment, and such substance is not covered by an occupational safety or health standard promulgated under section 6, the Secretary of Health and Human Services shall immediately submit such determination to the Secretary, together with all pertinent criteria.

(7) Within two years of enactment of the Act, and annually thereafter the Secretary of Health and Human Services shall conduct and publish industry wide studies of the effect of chronic or low-level exposure to industrial materials, processes, and stresses on the potential for illness, disease, or loss of functional capacity in aging adults.

(b) The Secretary of Health and Human Services is authorized to make inspections and question employers and employees as provided in section 8 of this Act in order to carry out his functions and responsibilities under this section.

(c) The Secretary is authorized to enter into contracts, agreements, or other arrangements with appropriate public agencies or private organizations for the purpose of conducting studies relating to his responsibilities under this Act. In carrying out his responsibilities under this subsection, the Secretary shall cooperate with the Secretary of Health and Human Services in order to avoid any duplication of efforts under this section.

(d) Information obtained by the Secretary and the Secretary of Health and Human Services under this section shall be disseminated by the Secretary to employers and employees and organizations thereof.

(e) The functions of the Secretary of Health and Human Services under this Act shall, to the extent feasible, be delegated to the Director of the National Institute for Occupational Safety and Health established by section 22 of this Act.

**EXPANDED RESEARCH ON WORKER SAFETY AND HEALTH**

The Secretary of Health and Human Services (referred to in this section as the "Secretary"), acting through the Director of the National Institute of Occupational Safety and Health, shall enhance and expand research as deemed appropriate on the health and safety of workers who are at risk for bioterrorist threats or attacks in the workplace, including research on the health effects of measures taken to treat or protect such workers for diseases or disorders resulting from a bioterrorist threat or attack. Nothing in this section may be construed as establishing new regulatory authority for the Secretary or the Director to issue or modify any occupational safety and health rule or regulation.

29 USC 669a

Pub. L. 107-188,  
Title I, § 153 added  
this text.

**SEC. 21. Training and Employee Education**

(a) The Secretary of Health and Human Services, after consultation with the Secretary and with other appropriate Federal departments and agencies, shall conduct, directly or by grants or contracts --

29 USC 670

(1) education programs to provide an adequate supply of qualified personnel to carry out the purposes of this Act, and

(2) informational programs on the importance of and proper use of adequate safety and health equipment.

(b) The Secretary is also authorized to conduct, directly or by grants or contracts, short-term training of personnel engaged in work related to his responsibilities under this Act.

(c) The Secretary, in consultation with the Secretary of Health and Human

Services, shall --

- (1) provide for the establishment and supervision of programs for the education and training of employers and employees in the recognition, avoidance, and prevention of unsafe or unhealthful working conditions in employments covered by this Act; and
- (2) consult with and advise employers and employees, and organizations representing employers and employees as to effective means of preventing occupational injuries and illnesses.

Pub. L. 105-97,  
§2 added  
subsection (d).  
*See Historical  
notes.*

(d) (1) The Secretary shall establish and support cooperative agreements with the States under which employers subject to this Act may consult with State personnel with respect to --

- (A) the application of occupational safety and health requirements under this Act or under State plans approved under section 18; and
- (B) voluntary efforts that employers may undertake to establish and maintain safe and healthful employment and places of employment. Such agreements may provide, as a condition of receiving funds under such agreements, for contributions by States towards meeting the costs of such agreements.

(2) Pursuant to such agreements the State shall provide on-site consultation at the employer's worksite to employers who request such assistance. The State may also provide other education and training programs for employers and employees in the State. The State shall ensure that on-site consultations conducted pursuant to such agreements include provision for the participation by employees.

(3) Activities under this subsection shall be conducted independently of any enforcement activity. If an employer fails to take immediate action to eliminate employee exposure to an imminent danger identified in a consultation or fails to correct a serious hazard so identified within a reasonable time, a report shall be made to the appropriate enforcement authority for such action as is appropriate.

(4) The Secretary shall, by regulation after notice and opportunity for comment, establish rules under which an employer --

- (A) which requests and undergoes an on-site consultative visit provided under this subsection;
- (B) which corrects the hazards that have been identified during the visit within the time frames established by the State and agrees to request a subsequent consultative visit if major changes in working conditions or work processes occur which introduce new hazards in the workplace; and
- (C) which is implementing procedures for regularly identifying and preventing hazards regulated under this Act and maintains appropriate involvement of, and training for, management and non-management employees in achieving safe and healthful working conditions, may be exempt from an inspection (except an inspection requested under section 8(f) or an inspection to determine the cause of a workplace accident which resulted in the death of one or more employees or hospitalization for three or more employees) for a period of 1 year from the closing of the consultative visit.

(5) A State shall provide worksite consultations under paragraph (2) at the request of an employer. Priority in scheduling such consultations shall be assigned to requests from small businesses which are in higher hazard industries or have the most hazardous conditions at issue in the request.

**SEC. 22. National Institute for Occupational Safety and Health**

(a) It is the purpose of this section to establish a National Institute for Occupational Safety and Health in the Department of Health and Human Services in order to carry out the policy set forth in section 2 of this Act and to perform the functions of the Secretary of Health and Human Services under sections 20 and 21 of this Act.

29 USC 671

(b) There is hereby established in the Department of Health and Human Services a National Institute for Occupational Safety and Health. The Institute shall be headed by a Director who shall be appointed by the Secretary of Health and Human Services, and who shall serve for a term of six years unless previously removed by the Secretary of Health and Human Services.

(c) The Institute is authorized to --

- (1) develop and establish recommended occupational safety and health standards; and
- (2) perform all functions of the Secretary of Health and Human Services under sections 20 and 21 of this Act.

(d) Upon his own initiative, or upon the request of the Secretary of Health and Human Services, the Director is authorized (1) to conduct such research and experimental programs as he determines are necessary for the development of criteria for new and improved occupational safety and health standards, and (2) after consideration of the results of such research and experimental programs make recommendations concerning new or improved occupational safety and health standards. Any occupational safety and health standard recommended pursuant to this section shall immediately be forwarded to the Secretary of Labor, and to the Secretary of Health and Human Services.

(e) In addition to any authority vested in the Institute by other provisions of this section, the Director, in carrying out the functions of the Institute, is authorized to --

- (1) prescribe such regulations as he deems necessary governing the manner in which its functions shall be carried out;
- (2) receive money and other property donated, bequeathed, or devised, without condition or restriction other than that it be used for the purposes of the Institute and to use, sell, or otherwise dispose of such property for the purpose of carrying out its functions;
- (3) receive (and use, sell, or otherwise dispose of, in accordance with paragraph (2)), money and other property donated, bequeathed, or devised to the Institute with a condition or restriction, including a condition that the Institute use other funds of the Institute for the purposes of the gift;
- (4) in accordance with the civil service laws, appoint and fix the compensation of such personnel as may be necessary to carry out the provisions of this section;
- (5) obtain the services of experts and consultants in accordance with the provisions of section 3109 of title 5, United States Code;
- (6) accept and utilize the services of voluntary and noncompensated personnel and reimburse them for travel expenses, including per diem, as authorized by section 5703 of title 5, United States Code;
- (7) enter into contracts, grants or other arrangements, or modifications thereof to carry out the provisions of this section, and such contracts or modifications thereof may be entered into without performance or other bonds, and without regard to section 3709 of the Revised Statutes, as amended (41 U.S.C. 5), or any other provision of law relating to competitive bidding;
- (8) make advance, progress, and other payments which the Director deems necessary under this title without regard to the provisions of section 3324 (a) and (b) of Title 31; and
- (9) make other necessary expenditures.

Pub. L. 97-258

(f) The Director shall submit to the Secretary of Health and Human Services, to the President, and to the Congress an annual report of the operations of the Institute under this Act, which shall include a detailed statement of all private and public funds received and expended by it, and such recommendations as he deems appropriate.

Pub. L. 102-550  
added subsection  
(g).

(g) Lead-Based Paint Activities.

(1) Training Grant Program.

(A) The Institute, in conjunction with the Administrator of the Environmental Protection Agency, may make grants for the training and education of workers and supervisors who are or may be directly engaged in lead-based paint activities.

(B) Grants referred to in subparagraph (A) shall be awarded to nonprofit organizations (including colleges and universities, joint labor-management trust funds, States, and nonprofit government employee organizations) --

(i) which are engaged in the training and education of workers and supervisors who are or who may be directly engaged in lead-based paint activities (as defined in Title IV of the Toxic Substances Control Act),

(ii) which have demonstrated experience in implementing and operating health and safety training and education programs, and

(iii) with a demonstrated ability to reach, and involve in lead-based paint training programs, target populations of individuals who are or will be engaged in lead-based paint activities. Grants under this subsection shall be awarded only to those organizations that fund at least 30 percent of their lead-based paint activities training programs from non-Federal sources, excluding in-kind contributions. Grants may also be made to local governments to carry out such training and education for their employees.

(C) There are authorized to be appropriated, a minimum, \$10,000,000 to the Institute for each of the fiscal years 1994 through 1997 to make grants under this paragraph.

(2) Evaluation of Programs. The Institute shall conduct periodic and comprehensive assessments of the efficacy of the worker and supervisor training programs developed and offered by those receiving grants under this section. The Director shall prepare reports on the results of these assessments addressed to the Administrator of the Environmental Protection Agency to include recommendations as may be appropriate for the revision of these programs. The sum of \$500,000 is authorized to be appropriated to the Institute for each of the fiscal years 1994 through 1997 to carry out this paragraph.

**WORKERS' FAMILY PROTECTION**

(a) Short title

This section may be cited as the "Workers' Family Protection Act".

29 USC 671a

(b) Findings and purpose

(1) Findings  
Congress finds that--

Pub. L. 102-522,  
Title II, §209  
added this text.

- (A) hazardous chemicals and substances that can threaten the health and safety of workers are being transported out of industries on workers' clothing and persons;
- (B) these chemicals and substances have the potential to pose an additional threat to the health and welfare of workers and their families;
- (C) additional information is needed concerning issues related to employee transported contaminant releases; and
- (D) additional regulations may be needed to prevent future releases of this type.

(2) Purpose  
It is the purpose of this section to--

- (A) increase understanding and awareness concerning the extent and possible health impacts of the problems and incidents described in paragraph (1);
- (B) prevent or mitigate future incidents of home contamination that could adversely affect the health and safety of workers and their families;
- (C) clarify regulatory authority for preventing and responding to such incidents; and
- (D) assist workers in redressing and responding to such incidents when they occur.

(c) Evaluation of employee transported contaminant releases

(1) Study

(A) In general  
Not later than 18 months after October 26, 1992, the Director of the National Institute for Occupational Safety and Health (hereafter in this section referred to as the "Director"), in cooperation with the Secretary of Labor, the Administrator of the Environmental Protection Agency, the Administrator of the Agency for Toxic Substances and Disease Registry, and the heads of other Federal Government agencies as determined to be appropriate by the Director, shall conduct a study to evaluate the potential for, the prevalence of, and the issues related to the contamination of workers' homes with hazardous chemicals and substances, including infectious agents, transported from the workplaces of such workers.

(B) Matters to be evaluated  
In conducting the study and evaluation under subparagraph (A), the Director shall--

(i) conduct a review of past incidents of home contamination through the utilization of literature and of records concerning past investigations and enforcement actions undertaken by--

- (I) the National Institute for Occupational Safety and Health;
- (II) the Secretary of Labor to enforce the Occupational Safety and Health Act of 1970 (29 U.S.C. 651 et seq.);
- (III) States to enforce occupational safety and health standards in accordance with section 18 of such Act (29 U.S.C. 667); and
- (IV) other government agencies (including the Department of Energy and the Environmental Protection Agency), as the Director may determine to be appropriate;
- (ii) evaluate current statutory, regulatory, and voluntary industrial hygiene or other measures used by small, medium and large employers to prevent or remediate home contamination;
- (iii) compile a summary of the existing research and case histories conducted on incidents of employee transported contaminant releases, including--

- (I) the effectiveness of workplace housekeeping practices and personal protective equipment in preventing such incidents;
- (II) the health effects, if any, of the resulting exposure on workers and their families;
- (III) the effectiveness of normal house cleaning and laundry procedures for removing hazardous materials and agents from workers' homes and personal clothing;
- (IV) indoor air quality, as the research concerning such pertains to the fate of chemicals transported from a workplace into the home environment; and



(v) methods for differentiating exposure health effects and relative risks associated with specific agents from other sources of exposure inside and outside the home;

(iv) identify the role of Federal and State agencies in responding to incidents of home contamination;

(v) prepare and submit to the Task Force established under paragraph (2) and to the appropriate committees of Congress, a report concerning the results of the matters studied or evaluated under clauses (i) through (iv); and

(vi) study home contamination incidents and issues and worker and family protection policies and practices related to the special circumstances of firefighters and prepare and submit to the appropriate committees of Congress a report concerning the findings with respect to such study.

(2) Development of investigative strategy

(A) Task Force

Not later than 12 months after October 26, 1992, the Director shall establish a working group, to be known as the "Workers' Family Protection Task Force". The Task Force shall--

(i) be composed of not more than 15 individuals to be appointed by the Director from among individuals who are representative of workers, industry, scientists, industrial hygienists, the National Research Council, and government agencies, except that not more than one such individual shall be from each appropriate government agency and the number of individuals appointed to represent industry and workers shall be equal in number;

(ii) review the report submitted under paragraph (1)(B)(v);

(iii) determine, with respect to such report, the additional data needs, if any, and the need for additional evaluation of the scientific issues related to and the feasibility of developing such additional data; and

(iv) if additional data are determined by the Task Force to be needed, develop a recommended investigative strategy for use in obtaining such information.

(B) Investigative strategy

(i) Content

The investigative strategy developed under subparagraph (A)(iv) shall identify data gaps that can and cannot be filled, assumptions and uncertainties associated with various components of such strategy, a timetable for the implementation of such strategy, and methodologies used to gather any required data.

(ii) Peer review

The Director shall publish the proposed investigative strategy under subparagraph (A)(iv) for public comment and utilize other methods, including technical conferences or seminars, for the purpose of obtaining comments concerning the proposed strategy.

(iii) Final strategy

After the peer review and public comment is conducted under clause (ii), the Director, in consultation with the heads of other government agencies, shall propose a final strategy for investigating issues related to home contamination that shall be implemented by the National Institute for Occupational Safety and Health and other Federal agencies for the period of time necessary to enable such agencies to obtain the information identified under subparagraph (A)(ii).

(C) Construction

Nothing in this section shall be construed as precluding any government agency from investigating issues related to home contamination using existing procedures until such time as a final strategy is developed or from taking actions in addition to those proposed in the strategy after its completion.

(3) Implementation of investigative strategy

Upon completion of the investigative strategy under subparagraph (B)(iii), each Federal agency or department shall fulfill the role assigned to it by the strategy.

(d) Regulations

(1) In general

Not later than 4 years after October 26, 1992, and periodically thereafter, the Secretary of Labor, based on the information developed under subsection (c) of this section and on other information available to the Secretary, shall--

(A) determine if additional education about, emphasis on, or enforcement of existing regulations or standards is needed and will be sufficient, or if additional regulations or standards are needed with regard to employee transported releases of hazardous materials; and

(8) prepare and submit to the appropriate committees of Congress a report concerning the result of such determination.

(2) Additional regulations or standards If the Secretary of Labor determines that additional regulations or standards are needed under paragraph (1), the Secretary shall promulgate, pursuant to the Secretary's authority under the Occupational Safety and Health Act of 1970 (29 U.S.C. 651 et seq.), such regulations or standards as determined to be appropriate not later than 3 years after such determination.

(e) Authorization of appropriations There are authorized to be appropriated from sums otherwise authorized to be appropriated, for each fiscal year such sums as may be necessary to carry out this section.

**SEC. 23. Grants to the States**

(a) The Secretary is authorized, during the fiscal year ending June 30, 1971, and the two succeeding fiscal years, to make grants to the States which have designated a State agency under section 18 to assist them -- 29 USC 672

- (1) in identifying their needs and responsibilities in the area of occupational safety and health,
- (2) in developing State plans under section 18, or
- (3) in developing plans for --
  - (A) establishing systems for the collection of information concerning the nature and frequency of occupational injuries and diseases;
  - (B) increasing the expertise and enforcement capabilities of their personnel engaged in occupational safety and health programs; or
  - (C) otherwise improving the administration and enforcement of State occupational safety and health laws, including standards thereunder, consistent with the objectives of this Act.

(b) The Secretary is authorized, during the fiscal year ending June 30, 1971, and the two succeeding fiscal years, to make grants to the States for experimental and demonstration projects consistent with the objectives set forth in subsection (a) of this section.

(c) The Governor of the State shall designate the appropriate State agency for receipt of any grant made by the Secretary under this section.

(d) Any State agency designated by the Governor of the State desiring a grant under this section shall submit an application therefor to the Secretary.

(e) The Secretary shall review the application, and shall, after consultation with the Secretary of Health and Human Services, approve or reject such application.

(f) The Federal share for each State grant under subsection (a) or (b) of this section may not exceed 90 per centum of the total cost of the application. In the event the Federal share for all States under either such subsection is not the same, the differences among the States shall be established on the basis of objective criteria.

(g) The Secretary is authorized to make grants to the States to assist them in administering and enforcing programs for occupational safety and health contained in State plans approved by the Secretary pursuant to section 18 of this Act. The Federal share for each State grant under this subsection may not exceed 50 per centum of the total cost to the State of such a program. The last sentence of subsection (f) shall be applicable in determining the Federal share under this subsection.

(h) Prior to June 30, 1973, the Secretary shall, after consultation with the Secretary of Health and Human Services, transmit a report to the President and to the Congress, describing the experience under the grant programs authorized by this section and making any recommendations he may deem appropriate.

**SEC. 24. Statistics**

(a) In order to further the purposes of this Act, the Secretary, in consultation with the Secretary of Health and Human Services, shall develop and maintain an effective program of collection, compilation, and analysis of occupational safety and health statistics. Such program may cover all employments whether or not subject to any other provisions of this Act but shall not cover employments excluded by section 4 of the Act. The Secretary shall compile accurate statistics on work injuries and illnesses which shall include all disabling, serious, or significant injuries and illnesses, whether or not involving loss of time from work, other than minor injuries requiring only first aid treatment and which do not involve medical treatment, loss of consciousness, restriction of work or motion, or transfer to another job. 29 USC 673

(b) To carry out his duties under subsection (a) of this section, the Secretary may --

- (1) promote, encourage, or directly engage in programs of studies, information and communication concerning occupational safety and health statistics;

(2) make grants to States or political subdivisions thereof in order to assist them in developing and administering programs dealing with occupational safety and health statistics; and

(3) arrange, through grants or contracts, for the conduct of such research and investigations as give promise of furthering the objectives of this section.

(c) The Federal share for each grant under subsection (b) of this section may be up to 50 per centum of the State's total cost.

(d) The Secretary may, with the consent of any State or political subdivision thereof, accept and use the services, facilities, and employees of the agencies of such State or political subdivision, with or without reimbursement, in order to assist him in carrying out his functions under this section.

(e) On the basis of the records made and kept pursuant to section 8(c) of this Act, employers shall file such reports with the Secretary as he shall prescribe by regulation, as necessary to carry out his functions under this Act.

(f) Agreements between the Department of Labor and States pertaining to the collection of occupational safety and health statistics already in effect on the effective date of this Act shall remain in effect until superseded by grants or contracts made under this Act.

**SEC. 25. Audits**

(a) Each recipient of a grant under this Act shall keep such records as the Secretary or the Secretary of Health and Human Services shall prescribe, including records which fully disclose the amount and disposition by such recipient of the proceeds of such grant, the total cost of the project or undertaking in connection with which such grant is made or used, and the amount of that portion of the cost of the project or undertaking supplied by other sources, and such other records as will facilitate an effective audit. 29 USC 674

(b) The Secretary or the Secretary of Health and Human Services, and the Comptroller General of the United States, or any of their duly authorized representatives, shall have access for the purpose of audit and examination to any books, documents, papers, and records of the recipients of any grant under this Act that are pertinent to any such grant.

**SEC. 26. Annual Report**

Within one hundred and twenty days following the convening of each regular session of each Congress, the Secretary and the Secretary of Health and Human Services shall each prepare and submit to the President for transmittal to the Congress a report upon the subject matter of this Act, the progress toward achievement of the purpose of this Act, the needs and requirements in the field of occupational safety and health, and any other relevant information. Such reports shall include information regarding occupational safety and health standards, and criteria for such standards, developed during the preceding year; evaluation of standards and criteria previously developed under this Act, defining areas of emphasis for new criteria and standards; an evaluation of the degree of observance of applicable occupational safety and health standards, and a summary of inspection and enforcement activity undertaken; analysis and evaluation of research activities for which results have been obtained under governmental and nongovernmental sponsorship; an analysis of major occupational diseases; evaluation of available control and measurement technology for hazards for which standards or criteria have been developed during the preceding year; description of cooperative efforts undertaken between Government agencies and other interested parties in the implementation of this Act during the preceding year; a progress report on the development of an adequate supply of trained manpower in the field of occupational safety and health, including estimates of future needs and the efforts being made by Government and others to meet those needs; listing of all toxic substances in industrial usage for which labeling requirements, criteria, or standards have not yet been established; and such recommendations for additional legislation as are deemed necessary to protect the safety and health of the worker and improve the administration of this Act. 29 USC 675 Pub. L. 104-66 §3003 terminated provision relating to transmittal of report to Congress.

**SEC. 27. National Commission on State Workmen's Compensation Laws**

(Text omitted.) 29 USC 676

**SEC. 28. Economic Assistance to Small Businesses**

(Text omitted.) See notes on omitted text.

**SEC. 29. Additional Assistant Secretary of Labor**

(Text omitted.) See notes on omitted text.

**SEC. 30. Additional Positions**

(Text omitted.) See notes on omitted text.

**SEC. 31. Emergency Locator Beacons**

(Text omitted.) See notes on omitted text.

**SEC. 32. Separability**

If any provision of this Act, or the application of such provision to any person or circumstance, shall be held invalid, the remainder of this Act, or the application of such provision to persons or circumstances other than those as to which it is held invalid, shall not be affected thereby. 29 USC 677

**SEC. 33. Appropriations**

There are authorized to be appropriated to carry out this Act for each fiscal year such sums as the Congress shall deem necessary. 29 USC 678

**SEC. 34. Effective Date**

This Act shall take effect one hundred and twenty days after the date of its enactment.

Approved December 29, 1970.

As amended through January 1, 2004.

**HISTORICAL NOTES**

This reprint generally retains the section numbers originally created by Congress in the Occupational Safety and Health (OSH) Act of 1970, Pub. L. 91-596, 84 Stat 1590. This document includes some editorial changes, such as changing the format to make it easier to read, correcting typographical errors, and updating some of the margin notes. Because Congress enacted amendments to the Act since 1970, this version differs from the original version of the OSH Act. It also differs slightly from the version published in the United States Code at 29 U.S.C. 661 *et seq.* For example, this reprint refers to the statute as the "Act" rather than the "chapter."

This reprint reflects the provisions of the OSH Act that are in effect as of January 1, 2004. Citations to Public Laws which made important amendments to the OSH Act since 1970 are set forth in the margins and explanatory notes are included below.

NOTE: Some provisions of the OSH Act may be affected by the enactment of, or amendments to, other statutes. Section 17(h)(1), 29 U.S.C. 666, is an example. The original provision amended section 1114 of title 18 of the United States Code to include employees of "the Department of Labor assigned to perform investigative, inspection, or law enforcement functions" within the list of persons protected by the provisions to allow prosecution of persons who have killed or attempted to kill an officer or employee of the U.S. government while performing official duties. This reprint sets forth the text of section 17(h) as enacted in 1970. However, since 1970, Congress has enacted multiple amendments to 18 U.S.C. 1114. The current version does not specifically include the Department of Labor in a list; rather it states that "Whoever kills or attempts to kill any officer or employee of the United States or of any agency in any branch of the United States Government (including any member of the uniformed services) while such officer or employee is engaged in or on account of the performance of official duties, or any person assisting such an officer or employee in the performance of such duties or on account of that assistance shall be punished . . ." as provided by the statute. Readers are reminded that the official version of statutes can be found in the current volumes of the United States Code, and more extensive historical notes can be found in the current volumes of the United States Code Annotated.

**Amendments**

On January 2, 1974, section 2(c) of Pub. L. 93-237 replaced the phrase "7(b)(6)" in section 28(d) of the OSH Act with "7(b)(5)". 87 Stat. 1023. Note: The text of Section 28 (Economic Assistance to Small Business) amended Sections 7(b) and Section 4(c)(1) of the Small Business Act. Because these amendments are no longer current, the text of section 28 is omitted in this reprint. For the current version, see 15 U.S.C. 636.

In 1977, the U.S. entered into the Panama Canal Treaty of 1977, Sept. 7, 1977, U.S.-Panama, T.I.A.S. 10030, 33 U.S.T. 39. In 1979, Congress enacted implementing legislation, Panama Canal Act of 1979, Pub. L. 96-70, 93 Stat. 452 (1979). Although no corresponding amendment to the OSH Act was enacted, the Canal Zone ceased to exist in 1979. The U.S. continued to manage, operate and facilitate the transit of ships through the Canal under the authority of the Panama Canal Treaty until December 31, 1999, at which time authority over the Canal was transferred to the Republic of Panama.

On March 27, 1976, Pub. L. 95-251, 92 Stat. 183, replaced the term "hearing examiner(s)" with "administrative law judge(s)" in all Federal laws, including sections 12(e), 12(j), and 12(k) of the OSH Act, 29 U.S.C. 661.

On October 13, 1978, Pub. L. 95-454, 92 Stat. 1111, 1221, which redesignated section numbers concerning personnel matters and compensation, resulted in the substitution of section 5372 of Title 5 for section 5362 in section 12(e) of the OSH Act, 29 U.S.C. 661.

On October 17, 1979, Pub. L. 96-88, Title V, section 509(b), 93 Stat. 668, 695, redesignated references to the Department of Health, Education, and Welfare to the Department of Health and Human Services and redesignated references to the Secretary of Health, Education, and Welfare to the Secretary of Health and Human Services.

On September 13, 1982, Pub. L. 97-258, 54(b), 96 Stat. 877, 1067, effectively substituted "Section 3324(a) and (b) of Title 31" for "Section 3648 of the Revised Statutes, as amended (31 U.S.C. 529)" in section 22 (e)(8), 29 U.S.C. 671, relating to NIOSH procurement authority.

On December 21, 1982, Pub. L. 97-375, 96 Stat. 1819, deleted the sentence in section 19(b) of the Act, 29 U.S.C. 668, that directed the President of the United States to transmit annual reports of the activities of federal agencies to the House of Representatives and the Senate.

On October 12, 1984, Pub. L. 98-473, Chapter II, 98 Stat. 1837, 1987, (commonly referred to as the "Sentencing Reform Act of 1984") instituted a classification system for criminal offenses punishable under the United States Code. Under this system, an offense with imprisonment terms of "six months or less but more than thirty days,"

such as that found in 29 U.S.C. 666(e) for a willful violation of the OSH Act, is classified as a criminal "Class B misdemeanor." 18 U.S.C. 3559(a)(7).

The criminal code increases the monetary penalties for criminal misdemeanors beyond what is provided for in the OSH Act: a fine for a Class B misdemeanor resulting in death, for example, is not more than \$250,000 for an individual, and is not more than \$500,000 for an organization. 18 U.S.C. 3571(b)(4), (c)(4). The criminal code also provides for authorized terms of probation for both individuals and organizations. 18 U.S.C. 3551, 3561. The term of imprisonment for individuals is the same as that authorized by the OSH Act. 18 U.S.C. 3581(b)(7).

On November 8, 1984, Pub. L. 98-620, 98 Stat. 3335, deleted the last sentence in section 11(a) of the Act, 29 U.S.C. 660, that required petitions filed under the subsection to be heard expeditiously.

On November 5, 1990, Pub. L. 101-508, 104 Stat. 1388, amended section 17 of the Act, 29 U.S.C. 666, by increasing the penalties in section 17(a) from \$10,000 for each violation to "\$70,000 for each violation, but not less than \$5,000 for each willful violation," and increased the limitation on penalties in sections (b), (c), (d), and (f) from \$1,000 to \$7,000.

On October 26, 1992, Pub. L. 102-522, 106 Stat. 3410, 3420, added to Title 29, section 671a "Workers' Family Protection" to grant authority to the Director of NIOSH to evaluate, investigate and if necessary, for the Secretary of Labor to regulate employee transported releases of hazardous material that result from contamination on the employee's clothing or person and may adversely affect the health and safety of workers and their families. Note: section 671a was enacted as section 209 of the Fire Administration Authorization Act of 1992, but it is reprinted here because it is codified within the chapter that comprises the OSH Act.

On October 28, 1992, the Housing and Community Development Act of 1992, Pub. L. 102-550, 106 Stat. 3672, 3924, amended section 22 of the Act, 29 U.S.C. 671, by adding subsection (g), which requires NIOSH to institute a training grant program for lead-based paint activities.

On July 5, 1994, section 7(b) of Pub. L. 103-272, 108 Stat. 745, repealed section 31 of the OSH Act, "Emergency Locator Beacons." Section 1(e) of the same Public Law, however, enacted a modified version of section 31 of the OSH Act. This provision, titled "Emergency Locator Transmitters," is codified at 49 U.S.C. 44712.

On December 21, 1995, Section 3003 of Pub. L. 104-66, 109 Stat. 707, as amended, effective May 15, 2000, terminated the provisions relating to the transmittal to Congress of reports under section 26 of the OSH Act, 29 U.S.C. 675.

On July 16, 1998, Pub. L. 105-197, 112 Stat. 638, amended section 21 of the Act, 29 U.S.C. 670, by adding subsection (d), which required the Secretary to establish a compliance assistance program by which employers can consult with state personnel regarding the application of and compliance with OSHA standards.

On July 16, 1998, Pub. L. 105-198, 112 Stat. 640, amended section 8 of the Act, 29 U.S.C. 657, by adding subsection (h), which forbids the Secretary to use the results of enforcement activities to evaluate the employees involved in such enforcement or to impose quotas or goals.

On September 29, 1998, Pub. L. 105-241, 112 Stat. 1572, amended sections 3(5) and 19(a) of the Act, 29 U.S.C. 652 and 668, to include the United States Postal Service as an "employer" subject to OSHA enforcement.

On June 12, 2002, Pub. L. 107-188, Title I, Section 153, 116 Stat. 631, Congress enacted 29 U.S.C. 669a, to expand research on the "health and safety of workers who are at risk for bioterrorist threats or attacks in the workplace."

#### Jurisdictional Note

Although no corresponding amendments to the OSH Act have been made, OSHA no longer exercises jurisdiction over the entity formerly known as the Trust Territory of the Pacific Islands. The Trust Territory, which consisted of the former

Japanese Mandated Islands, was established in 1947 by the Security Council of the United Nations, and administered by the United States. *Trusteeship Agreement for the Former Japanese Mandated Islands*, Apr. 2- July 18, 1947, 61 Stat. 3301, T.I.A.S. 1665, 8 U.N.T.S. 189.

From 1947 to 1994, the people of these Islands exercised the right of self-determination conveyed by the Trusteeship four times, resulting in the division of the Trust Territory into four separate entities. Three entities: the Republic of Palau, the Federated States of Micronesia, and the Republic of the Marshall Islands, became "Freely Associated States," to which U.S. Federal Law does not apply. Since the OSH Act is a generally applicable law that applies to Guam, it applies to the Commonwealth of Northern Mariana Islands, which elected to become a "Flag Territory" of the United States. See *Covenant to Establish a Commonwealth of the Northern Mariana Islands in Political Union with the United States of America*, Article V, section 502(a) as contained in Pub. L. 94-24, 90 Stat. 263 (Mar. 24, 1976) [citations to amendments omitted]; 48 U.S.C. 1801 and note (1976); see also *Saipan Stevedore Co., Inc. v. Director, Office of Workers' Compensation Programs*, 133 F.3d 717, 722 (9th Cir. 1998) (Longshore and Harbor Workers' Compensation Act applies to the Commonwealth of Northern Mariana Islands pursuant to section 502(a) of the Covenant because the Act has general application to the states and to Guam). For up-to-date information on the legal status of these freely associated states and territories, contact the Office of Insular Affairs of the Department of the Interior. (Web address: <http://www.doi.gov/oia/>)

**Omitted Text.** Reasons for textual deletions vary. Some deletions may result from amendments to the OSH Act; others to subsequent amendments to other statutes which the original provisions of the OSH Act may have amended in 1970. In some instances, the original provision of the OSH Act was date-limited and is no longer operative.

The text of section 12(c), 29 U.S.C. 661, is omitted. Subsection (c) amended sections 5314 and 5315 of Title 5, United States Code, to add the positions of Chairman and members of the Occupational Safety and Health Review Commission.

The text of section 27, 29 U.S.C. 676, is omitted. Section 27 listed Congressional findings on workers' compensation and established the National Commission on State Workmen's Compensation Laws, which ceased to exist ninety days after the submission of its final report, which was due no later than July 31, 1972.

The text of section 28 (Economic Assistance to Small Business) amended sections 7(b) and section 4(c)(1) of the Small Business Act to allow for small business loans in order to comply with applicable standards. Because these amendments are no longer current, the text is omitted here. For the current version see 15 U.S.C. 636.

The text of section 29, (Additional Assistant Secretary of Labor), created an Assistant Secretary for Occupational Safety and Health, and section 30 (Additional Positions) created additional positions within the Department of Labor and the Occupational Safety and Health Review Commission in order to carry out the provisions of the OSH Act. The text of these sections is omitted here because it no longer reflects the current statutory provisions for staffing and pay. For current provisions, see 29 U.S.C. 553 and 5 U.S.C. 5108 (c).

Section 31 of the original OSH Act amended 49 U.S.C. 1421 by inserting a section entitled "Emergency Locator Beacons." The text of that section is omitted in this reprint because Pub. L. 103-272, 108 Stat.745, (July 5, 1994), repealed the text of section 31 and enacted a modified version of the provision, entitled "Emergency Locator Transmitters," which is codified at 49 U.S.C. 44712.

**Notes on other legislation affecting the administration of the Occupational Safety and Health Act.** Sometimes legislation does not directly amend the OSH Act, but does place requirements on the Secretary of Labor either to act or to refrain from acting under the authority of the OSH Act. Included below are some examples of such legislation. Please note that this is not intended to be a comprehensive list.

**STANDARDS PROMULGATION.**

For example, legislation may require the Secretary to promulgate specific standards pursuant to authority under section 6 of the OSH Act, 29 U.S.C. 655. Some examples include the following:

*Hazardous Waste Operations.* Pub. L. 99-499, Title I, section 126(a)-(f), 100 Stat. 1613 (1986), as amended by Pub. L. 100-202, section 101(f), Title II, section 201, 101 Stat. 1329 (1987), required the Secretary of Labor to promulgate standards concerning hazardous waste operations.

*Chemical Process Safety Management.* Pub. L. 101-549, Title III, section 304, 104 Stat. 2399 (1990), required the Secretary of Labor, in coordination with the Administrator of the Environmental Protection Agency, to promulgate a chemical process safety standard.

*Hazardous Materials.* Pub. L. 101-615, section 29, 104 Stat. 3244 (1990), required the Secretary of Labor, in consultation with the Secretaries of Transportation and Treasury, to issue specific standards concerning the handling of hazardous materials.

*Bloodborne Pathogens Standard.* Pub. L. 102-170, Title I, section 100, 105 Stat. 1107 (1991), required the Secretary of Labor to promulgate a final Bloodborne Pathogens standard.

*Lead Standard.* The Housing and Community Development Act of 1992, Pub. L. 102-550, Title X, sections 1031 and 1032, 106 Stat. 3672 (1992), required the Secretary of Labor to issue an interim final lead standard.

**EXTENSION OF COVERAGE.**

Sometimes a statute may make some OSH Act provisions applicable to certain entities that are not subject to those provisions by the terms of the OSH Act. For example, the Congressional Accountability Act of 1995, Pub. L. 104-1, 109 Stat. 3, (1995), extended certain OSH Act coverage, such as the duty to comply with Section 5 of the OSH Act, to the Legislative Branch. Among other provisions, this legislation authorizes the General Counsel of the Office of Compliance within the Legislative Branch to exercise the authority granted to the Secretary of Labor in the OSH Act to inspect places of employment and issue a citation or notice to correct the violation found. This statute does not make all the provisions of the OSH Act applicable to the Legislative Branch. Another example is the Medicare Prescription Drug, Improvement, and Modernization Act of 2003, Title IX, Section 947, Pub. L. 108-173, 117 Stat. 2066 (2003), which requires public hospitals not otherwise subject to the OSH Act to comply with OSHA's Bloodborne Pathogens standard, 29 CFR 1910.1030. This statute provides for the imposition and collection of civil money penalties by the Department of Health and Human Services in the event that a hospital fails to comply with OSHA's Bloodborne Pathogens standard.

**PROGRAM CHANGES ENACTED THROUGH APPROPRIATIONS LEGISLATION.**

Sometimes an appropriations statute may allow or restrict certain substantive actions by OSHA or the Secretary of Labor. For example, sometimes an appropriations statute may restrict the use of money appropriated to run the Occupational Safety and Health Administration or the Department of Labor. One example of such a restriction, that has been included in OSHA's appropriation for many years, limits the applicability of OSHA requirements with respect to farming operations that employ ten or fewer workers and do not maintain a temporary labor camp. Another example is a restriction that limits OSHA's authority to conduct certain enforcement activity with respect to employers of ten or fewer employees in low hazard industries. See Consolidated Appropriations Act, 2004, Pub. L. 108-199, Div. E – Labor, Health and Human Services, and Education, and Related Agencies Appropriations, 2004, Title I – Department of Labor, 118 Stat. 3 (2004). Sometimes an appropriations statute may allow OSHA to retain some money collected to use for occupational safety and health training or grants. For example, the Consolidated Appropriations Act, 2004, Div. E, Title I, cited above, allows OSHA to retain up to \$750,000 of training institute course tuition fees per fiscal year for such uses. For the statutory text of currently applicable appropriations provisions, consult the OSHA appropriations statute for the fiscal year in question.

[OSHA Act of 1970 - Table of Contents](#)

[Freedom of Information Act](#) | [Privacy & Security Statement](#) | [Disclaimers](#) | [Important Web Site Notices](#) | [International](#) | [Contact Us](#)

U.S. Department of Labor | Occupational Safety & Health Administration | 200 Constitution Ave., NW, Washington, DC 20210  
Telephone: 800-321-OSHA (6742) | TTY: 877-889-5627

[www.OSHA.gov](http://www.OSHA.gov)

VOLVO DOUBLE DRUM COMPACTORS

**DD25B**

2.6 t 25 hp





PERFORMANCE YOU CAN COUNT ON.

VOLVO

DD25B

VOLVO



**360° visibility**

With an optimally positioned sliding seat, angled drum mounts and a sloping hood design, the DD25B provides industry-leading, all-around visibility. Whether rolling forwards or in reverse, the operator has a clear view of the drum edges and surroundings – delivering precise compaction and improved safety.



Introducing the DD25B, a highly efficient double drum compactor designed to increase performance and reduce fuel consumption on small scale compaction projects. Featuring the new Volvo D1.7A engine, this machine meets the strict Stage IV/ Tier 4 Final emissions regulations without adding an exhaust after-treatment system. Experience increased machine performance and enhanced productivity with Volvo.



**High performance**

With Volvo's high frequency compaction, the DD25B can travel faster while still maintaining the correct impact spacing necessary for high productivity and a smooth finish. The frequency can be adjusted from 3,300 vpm to 4,000 vpm to cater for different applications



**Optimized for efficiency**

The new Volvo D1.7A (18.5 kW/25 hp) engine effectively meets the stringent Stage IV/ Tier 4 Final emissions regulations without the cost or complexity of an exhaust after-treatment system. The optimized eccentric system ensures a powerful performance – equivalent to machines fitted with a bigger engine.

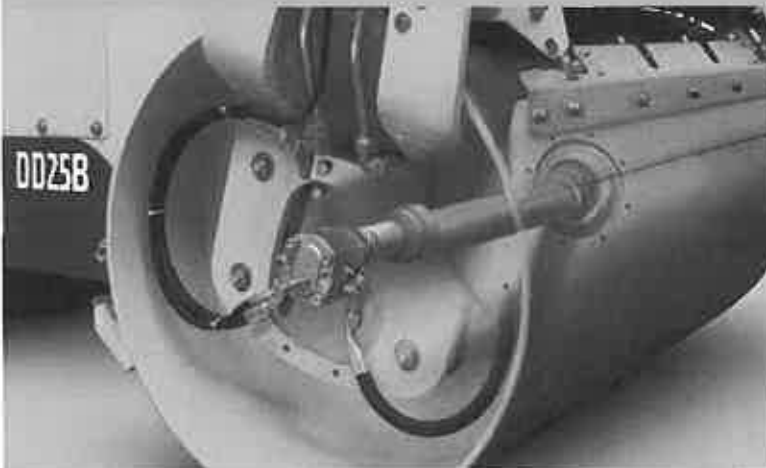

**Pressurized water system**

The DD25B boasts an industry-leading water tank capacity. A rust-proof, pressurized water system provides consistent flow to the front and rear drum surfaces – eliminating asphalt pick-up. Fine filters behind each of the eight spray nozzles minimize clogging and ensure correct fan spray coverage – providing ideal wetting of the drum surface.



**Reduced fuel consumption**

The Volvo D1.7A engine is perfectly matched to the DD25B's hydraulic system – delivering high performance and a 7% reduction in fuel consumption

# THE VOLVO EXPERIENCE.

## Engine compartment

For easy maintenance access, the hinged engine hood tilts forward – providing wide access to the engine and hydraulic components at ground level.

## Water level indicator

The operator can easily monitor the water tank level from the seat.

## Intermittent water spray

The DD25B boasts an industry-leading water tank capacity. The operator can adjust the time between water sprays to the drums to conserve water and reduce refilling downtime.



## Optimized for efficiency

The new Volvo D1.7A engine delivers high performance while meeting the stringent Stage IV/ Tier 4 Final emissions regulations without an exhaust after-treatment system.

## Urethane drum wipers

Front and rear drum wipers are made of urethane – increasing effectiveness and component lifetime as well as reducing maintenance requirements.

## Auto start vibration

Vibration engages automatically when the FSR lever is moved out of neutral and disengages when the lever is put in the stop position. This eliminates the risk of accidental damage to the mat.



## Reduced fuel consumption

The Volvo D1.7A engine is perfectly matched to the DD25B's hydraulic system – delivering high performance and a 7% reduction in fuel consumption.





#### **Machined drums**

Machined drums with chamfered edges are perfectly round in order to produce a smooth, mark-free mat.



#### **360° visibility**

With an optimally positioned sliding seat and a sloping engine hood design, the operator will experience industry-leading, all-around visibility.



#### **High performance**

With Volvo's high frequency compaction, the DD25B can travel faster while still maintaining the correct impact spacing necessary for high productivity and a smooth finish.

#### **Quick removal of nozzles**

Water nozzles can be quickly removed without the need for tools – increasing machine uptime and water system performance.

#### **Maintenance-free bearings**

Maintenance-free eccentric bearings are lubricated for life and built to tolerate high temperatures and rotation speeds.



#### **Pressurized water system**

A rust-proof, pressurized water system provides consistent flow to the drum surfaces – eliminating asphalt pick-up.

# MAINTAIN YOUR PRODUCTIVITY.

Volvo machines are built to last. That's why all service points on the DD25B are easy to access for fast maintenance and reduced downtime. The lightweight engine hood opens effortlessly for daily inspection. Combined with Volvo's excellent service support, your DD25B will keep you rolling longer.



## Easy-access engine compartment

The engine hood can be easily opened for daily maintenance and inspection. The hinged engine hood design is lightweight and tilts forward with the aid of two gas struts giving wide access to the engine and hydraulic components.

## Dealer support comes standard

Your local Volvo dealer backs you and your operation with a ready supply of genuine Volvo parts that are perfectly matched to your machine. Your dealer is also ready to help you stay working with expert, trained service and support.

# SPECIFICATIONS.

Model	DD25B Narrow Drum				DD25B Wide Drum			
<b>Machine weights (w/ ROPS)</b>								
Operating weight	kg	lb	2 515	5,545	2 620	5,776		
Weight @ front drum	kg	lb	1 211	2,670	1 270	2,800		
Weight @ rear drum	kg	lb	1 304	2,875	1 360	2,998		
Shipping weight	kg	lb	2 359	5,201	2 470	5,445		
<b>Drum</b>								
Width	mm	in	1 000	39.4	1 200	47.2		
Diameter	mm	in	700	27.5	700	27.5		
Shell thickness	mm	in	13	0.51	13	0.51		
Finish	Machined							
<b>Vibration</b>								
Frequency	Hz	vpm	55/66.7	3,300/4,000	55/66.7	3,300/4,000		
Nominal amplitude	mm	in	0.54	0.0210	0.5	0.0197		
Centrifugal force	high	kN	37.5	8,430	40.6	9,127		
	low		25.5	5,732	27.7	6,227		
<b>Propulsion</b>								
Type	Closed-loop hydrostatic							
Drum drive	Radial piston							
Travel speed	km/h	mph	0 - 103	0 - 64	0 - 103	0 - 64		
<b>Engine</b>								
Make / model	Engine Tier 4 Final - Volvo D1.7A							
Engine type	3-cylinder diesel							
Rated power @ installed speed	kW	hp	184 @ 2,200 rpm	25 @ 2,200 rpm	184 @ 2,200 rpm	25 @ 2,200 rpm		
Electrical	12 volts, 70 A alternator							
<b>Brakes</b>								
Service	Hydrostatic							
Parking secondary	Spring-applied, hydraulic release on each drum							
<b>Water system</b>								
Type	Pressurized							
Nozzles	4 per drum							
Filtration	Inlet and nozzle filtration							
Drum wipers	Spring-loaded, self-adjusting urethane wipers							
Water tank capacity	l	gal	260	69	260	69		
<b>Miscellaneous</b>								
Articulation angle					+ / - 30			
Oscillation angle					+ / - 10			
Inside turning radius (to drum edge)	mm	in	2 800	110	2 800	110		
Fuel tank capacity	l	gal	40	10.6	40	10.6		
Hydraulic oil capacity	l	gal	27	7.2	27	7.2		
Gradeability (theoretical)					30			

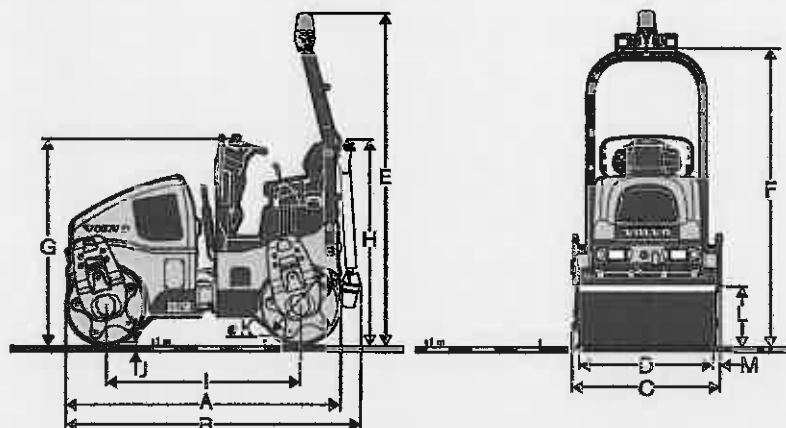

DIMENSIONS	DD25B Narrow Drum		DD25B Wide Drum	
	mm	in	mm	in
A	2 420	95.3	2 420	95.3
B	2 540	100.0	2 540	100.0
C	1 090	42.9	1 290	50.8
D	1 000	39.4	1 200	47.2
E	2 955	116.3	2 955	116.3
F	2 650	104.3	2 650	104.3
G	1 870	73.6	1 870	73.6
H	2 020	79.5	2 020	79.5
I	1 720	67.7	1 720	67.7
J	13	0.5	13	0.5
K	700	27.6	700	27.6
L	490	19.3	490	19.3
M	45	1.8	45	1.8

## VOLVO CONSTRUCTION EQUIPMENT

Volvo Construction Equipment is different. Our machines are designed, built and supported in a different way. That difference comes from an engineering heritage of over 160 years. A heritage of thinking first about the people who actually use the machines. About how to help them be safer, more comfortable, more productive. About the environment we all share. The result of that thinking is a growing range of machines and a global support network dedicated to helping you do more. People around the world are proud to use Volvo.

Not all products are available in all markets. Under our policy of continuous improvement, we reserve the right to change specifications and design without prior notice. The illustrations do not necessarily show the standard version of the machine.

# **VOLVO**

**Volvo Construction Equipment**  
[www.volvoce.com](http://www.volvoce.com)

Ref. No. VCE2210009320  
Printed in USA, 01/2014  
Volvo, Shippensburg  
Copyright © 2014 Volvo

English-22  
USA

State of West Virginia  
**VENDOR PREFERENCE CERTIFICATE**

Certification and application is hereby made for Preference in accordance with **West Virginia Code**, §5A-3-37. (Does not apply to construction contracts). **West Virginia Code**, §5A-3-37, provides an opportunity for qualifying vendors to request (at the time of bid) preference for their residency status. Such preference is an evaluation method only and will be applied only to the cost bid in accordance with the **West Virginia Code**. This certificate for application is to be used to request such preference. The Purchasing Division will make the determination of the Vendor Preference, if applicable.

1.  **Application is made for 2.5% vendor preference for the reason checked:**  
 Bidder is an individual resident vendor and has resided continuously in West Virginia for four (4) years immediately preceding the date of this certification; **or,**  
 Bidder is a partnership, association or corporation resident vendor and has maintained its headquarters or principal place of business continuously in West Virginia for four (4) years immediately preceding the date of this certification; or 80% of the ownership interest of Bidder is held by another individual, partnership, association or corporation resident vendor who has maintained its headquarters or principal place of business continuously in West Virginia for four (4) years immediately preceding the date of this certification; **or,**  
 Bidder is a nonresident vendor which has an affiliate or subsidiary which employs a minimum of one hundred state residents and which has maintained its headquarters or principal place of business within West Virginia continuously for the four (4) years immediately preceding the date of this certification; **or,**
2.  **Application is made for 2.5% vendor preference for the reason checked:**  
 Bidder is a resident vendor who certifies that, during the life of the contract, on average at least 75% of the employees working on the project being bid are residents of West Virginia who have resided in the state continuously for the two years immediately preceding submission of this bid; **or,**
3.  **Application is made for 2.5% vendor preference for the reason checked:**  
 Bidder is a nonresident vendor employing a minimum of one hundred state residents or is a nonresident vendor with an affiliate or subsidiary which maintains its headquarters or principal place of business within West Virginia employing a minimum of one hundred state residents who certifies that, during the life of the contract, on average at least 75% of the employees or Bidder's affiliate's or subsidiary's employees are residents of West Virginia who have resided in the state continuously for the two years immediately preceding submission of this bid; **or,**
4.  **Application is made for 5% vendor preference for the reason checked:**  
 Bidder meets either the requirement of both subdivisions (1) and (2) or subdivision (1) and (3) as stated above; **or,**
5.  **Application is made for 3.5% vendor preference who is a veteran for the reason checked:**  
 Bidder is an individual resident vendor who is a veteran of the United States armed forces, the reserves or the National Guard and has resided in West Virginia continuously for the four years immediately preceding the date on which the bid is submitted; **or,**
6.  **Application is made for 3.5% vendor preference who is a veteran for the reason checked:**  
 Bidder is a resident vendor who is a veteran of the United States armed forces, the reserves or the National Guard, if, for purposes of producing or distributing the commodities or completing the project which is the subject of the vendor's bid and continuously over the entire term of the project, on average at least seventy-five percent of the vendor's employees are residents of West Virginia who have resided in the state continuously for the two immediately preceding years.
7.  **Application is made for preference as a non-resident small, women- and minority-owned business, in accordance with West Virginia Code §5A-3-59 and West Virginia Code of State Rules.**  
 Bidder has been or expects to be approved prior to contract award by the Purchasing Division as a certified small, women- and minority-owned business.

Bidder understands if the Secretary of Revenue determines that a Bidder receiving preference has failed to continue to meet the requirements for such preference, the Secretary may order the Director of Purchasing to: (a) reject the bid; or (b) assess a penalty against such Bidder in an amount not to exceed 5% of the bid amount and that such penalty will be paid to the contracting agency or deducted from any unpaid balance on the contract or purchase order.

By submission of this certificate, Bidder agrees to disclose any reasonably requested information to the Purchasing Division and authorizes the Department of Revenue to disclose to the Director of Purchasing appropriate information verifying that Bidder has paid the required business taxes, provided that such information does not contain the amounts of taxes paid nor any other information deemed by the Tax Commissioner to be confidential.

**Under penalty of law for false swearing (West Virginia Code, §61-5-3), Bidder hereby certifies that this certificate is true and accurate in all respects; and that if a contract is issued to Bidder and if anything contained within this certificate changes during the term of the contract, Bidder will notify the Purchasing Division in writing immediately.**

Bidder: Rudd Equipment Company

Signed: [Signature]

Date: 9/22/15

Title: Sales Rep



STATE OF WEST VIRGINIA  
Purchasing Division

**PURCHASING AFFIDAVIT**

**MANDATE:** Under W. Va. Code §5A-3-10a, no contract or renewal of any contract may be awarded by the state or any of its political subdivisions to any vendor or prospective vendor when the vendor or prospective vendor or a related party to the vendor or prospective vendor is a debtor and: (1) the debt owed is an amount greater than one thousand dollars in the aggregate; or (2) the debtor is in employer default.

**EXCEPTION:** The prohibition listed above does not apply where a vendor has contested any tax administered pursuant to chapter eleven of the W. Va. Code, workers' compensation premium, permit fee or environmental fee or assessment and the matter has not become final or where the vendor has entered into a payment plan or agreement and the vendor is not in default of any of the provisions of such plan or agreement.

**DEFINITIONS:**

**"Debt"** means any assessment, premium, penalty, fine, tax or other amount of money owed to the state or any of its political subdivisions because of a judgment, fine, permit violation, license assessment, defaulted workers' compensation premium, penalty or other assessment presently delinquent or due and required to be paid to the state or any of its political subdivisions, including any interest or additional penalties accrued thereon.

**"Employer default"** means having an outstanding balance or liability to the old fund or to the uninsured employers' fund or being in policy default, as defined in W. Va. Code § 23-2c-2, failure to maintain mandatory workers' compensation coverage, or failure to fully meet its obligations as a workers' compensation self-insured employer. An employer is not in employer default if it has entered into a repayment agreement with the Insurance Commissioner and remains in compliance with the obligations under the repayment agreement.

**"Related party"** means a party, whether an individual, corporation, partnership, association, limited liability company or any other form or business association or other entity whatsoever, related to any vendor by blood, marriage, ownership or contract through which the party has a relationship of ownership or other interest with the vendor so that the party will actually or by effect receive or control a portion of the benefit, profit or other consideration from performance of a vendor contract with the party receiving an amount that meets or exceeds five percent of the total contract amount.

**AFFIRMATION:** By signing this form, the vendor's authorized signer affirms and acknowledges under penalty of law for false swearing (W. Va. Code §61-5-3) that neither vendor nor any related party owe a debt as defined above and that neither vendor nor any related party are in employer default as defined above, unless the debt or employer default is permitted under the exception above.

**WITNESS THE FOLLOWING SIGNATURE:**

Vendor's Name: Rudd Equipment Company

Authorized Signature: [Signature] Date: 9/22/15

State of WV

County of Kanawha, to-wit:

Taken, subscribed, and sworn to before me this 22nd day of Sept., 2015

My Commission expires 05/02, 2023

AFFIX SEAL HERE

NOTARY PUBLIC [Signature]  
Purchasing Affidavit (Revised 08/01/2015)

