



Purchasing Division
 2019 Washington Street East
 Post Office Box 50130
 Charleston, WV 25305-0130

**State of West Virginia
 Request for Quotation**

Proc Folder: 107449

Doc Description: OPEN-END CONTRACT FOR HVAC PARTS

Proc Type: Central Master Agreement

Date Issued	Solicitation Closes	Solicitation No	Version
2015-07-29	2015-09-02 13:30:00	CRFQ 0211 GSD1600000006	1

BID RECEIVING LOCATION
 BID CLERK
 DEPARTMENT OF ADMINISTRATION
 PURCHASING DIVISION
 2019 WASHINGTON ST E
 CHARLESTON WV 25305
 US

VENDOR
 Vendor Name, Address and Telephone Number:

09/01/15 14:09:11
 WV Purchasing Division

FOR INFORMATION CONTACT THE BUYER

Laura E Hooper
 (304) 558-0468
 laura.e.hooper@wv.gov

Signature X

FEIN #

DATE

All offers subject to all terms and conditions contained in this solicitation

INVOICE TO		SHIP TO	
DEPARTMENT OF ADMINISTRATION GENERAL SERVICES DIVISION 1900 KANAWHA BLVD E, BLDG 1, RM MB-68 CHARLESTON WV25305 US		DEPARTMENT OF ADMINISTRATION GENERAL SERVICES DIVISION 1900 KANAWHA BLVD E, BLDG 1 RM MB12 CHARLESTON WV 25305 US	

Line	Comm Ln Desc	Qty	Unit Issue	Unit Price	Total Price
1	HVAC parts	1.00000	EA		

Comm Code	Manufacturer	Specification	Model #
40100000			

Extended Description :
HVAC PARTS - SEE ATTACHED EXHIBIT A FOR ELIGIBLE CATALOG CONTRACT ITEMS' PRICING PAGE

THE WEST VIRGINIA PURCHASING DIVISION IS SOLICITING BIDS ON BEHALF OF THE WEST VIRGINIA DEPARTMENT OF ADMINISTRATION, GENERAL SERVICES DIVISION, TO ESTABLISH AN OPEN-END CONTRACT FOR THE PURCHASE OF VARIOUS MANUFACTURERS OF ORIGINAL EQUIPMENT MANUFACTURER (OEM) HVAC PARTS OR EQUAL.

GSD1600000006	Document Phase Final	Document Description OPEN-END CONTRACT FOR HVAC PAR TS	Page 3 of 3
----------------------	--------------------------------	---	------------------------------

ADDITIONAL TERMS AND CONDITIONS

See attached document(s) for additional Terms and Conditions

REQUEST FOR QUOTATION
CRFQ_GSD1600000006 - HVAC PARTS

29

8.1.4 Failure to remedy deficient performance upon request.

8.2 The following remedies shall be available to Agency upon default.

8.2.1 Immediate cancellation of the Contract.

8.2.2 Immediate cancellation of one or more release orders issued under this Contract.

8.2.3 Any other remedies available in law or equity.

9. MISCELLANEOUS:

9.1 **No Substitutions:** Vendor shall supply only Eligible Items contained in its Catalog submitted in response to the Solicitation or an updated Catalog approved by the Purchasing Division as described above. Vendor shall not supply substitute items.

9.2 **Vendor Supply:** Vendor must carry sufficient inventory of the Eligible Items being offered to fulfill its obligations under this Contract. By signing its bid, Vendor certifies that it can supply the Eligible Items contained in its bid response.

9.3 **Reports:** Vendor shall provide quarterly reports and annual summaries to the Agency showing the Agency's items purchased, quantities of items purchased, and total dollar value of the items purchased. Vendor shall also provide reports, upon request, showing the items purchased during the term of this Contract, the quantity purchased for each of those items, and the total value of purchases for each of those items. Failure to supply such reports may be grounds for cancellation of this Contract.

9.4 **Contract Manager:** During its performance of this Contract, Vendor must designate and maintain a primary contract manager responsible for overseeing Vendor's responsibilities under this Contract. The Contract manager must be available during normal business hours to address any customer service or other issues related to this Contract. Vendor should list its Contract manager and his or her contact information below.

Contract Manager: Jon Dickson
Vendor's Address: 101 1st Ave
South Charleston, WV
25303
Telephone Number: 304-744-2665

Fax Number: 304-744-7999
Email Address: jon.dickson@johnstoneSupply.com

CERTIFICATION AND SIGNATURE PAGE

By signing below, or submitting documentation through wvOASIS, I certify that I have reviewed this Solicitation in its entirety; understand the requirements, terms and conditions, and other information contained herein; that I am submitting this bid, offer or proposal for review and consideration; that I am authorized by the vendor to execute and submit this bid, offer, or proposal, or any documents related thereto on vendor's behalf; that I am authorized to bind the vendor in a contractual relationship; and that to the best of my knowledge, the vendor has properly registered with any State agency that may require registration.

Johnstone Supply
(Company)

Jon Dickson - Customer Solutions Mgr. - Territory Sales
(Authorized Signature) (Representative Name, Title)

P(304)744-2665 / F-304-744-7999 / 9/1/15
(Phone Number) (Fax Number) (Date)

ADDENDUM ACKNOWLEDGEMENT FORM
SOLICITATION NO.: CRFQ_GSD 1600000006

Instructions: Please acknowledge receipt of all addenda issued with this solicitation by completing this addendum acknowledgment form. Check the box next to each addendum received and sign below. Failure to acknowledge addenda may result in bid disqualification.

Acknowledgment: I hereby acknowledge receipt of the following addenda and have made the necessary revisions to my proposal, plans and/or specification, etc.

Addendum Numbers Received:
(Check the box next to each addendum received)

- | | |
|---|--|
| <input type="checkbox"/> Addendum No. 1 | <input type="checkbox"/> Addendum No. 6 |
| <input type="checkbox"/> Addendum No. 2 | <input type="checkbox"/> Addendum No. 7 |
| <input type="checkbox"/> Addendum No. 3 | <input type="checkbox"/> Addendum No. 8 |
| <input type="checkbox"/> Addendum No. 4 | <input type="checkbox"/> Addendum No. 9 |
| <input type="checkbox"/> Addendum No. 5 | <input type="checkbox"/> Addendum No. 10 |

I understand that failure to confirm the receipt of addenda may be cause for rejection of this bid. I further understand that any verbal representation made or assumed to be made during any oral discussion held between Vendor's representatives and any state personnel is not binding. Only the information issued in writing and added to the specifications by an official addendum is binding.

Johnstone Supply
Company

[Signature]
Authorized Signature

9/1/15
Date

NOTE: This addendum acknowledgement should be submitted with the bid to expedite document processing.

HVAC PARTS- PRICING PAGE

EXHIBIT A

NOTE: VENDORS SHOULD COMPLETE ALL COLUMNS (Please fill in Single Percentage Discount in the bottom of this document prior to calculation, this will auto-populate prices if using the electronic spreadsheet)

Pricing Page Eligible Item Description					Discounted Unit Price Calculation					Bid Total Calculation				WHERE TO BRING PRODUCT FROM
Product Category	Description	Equal To (Part Number)	Manufacturer	Part Number / Johnstone #	Catalogue Price	Units Provided for Catalogue Price	Unit Price	Discount Percentage	Discounted Unit Price	Unit (For Calculation Purposes)	Estimated Unit Qty	Discounted Unit Price	Item Total Cost	
All references to brand names are for illustration purposes only and vendors may bid the brand listed or an equal product.														
I				YELLOW = DATA SHEET										
X	Heat Sink Fans	3AUJA000006978				EACH		0%	\$0.00	1 pc.	12.00	\$0.00	\$0.00	
X	Frequency Drive Unit	2134402549				EACH		0%	\$0.00	1 pc.	4.00	\$0.00	\$0.00	
	Capacitor	Z5053715MOIN	PACKALD	TRCFD305 / G38-C30	\$25.49	EACH	\$11.98	0%	\$11.98	1 pc.	24.00	\$11.98	\$287.52	JOHNSTONE
	HVAC Filter Dryer	BFK-1635	FMTROON	38E-1638 / B17-225	\$65.00	EACH	\$17.59	0%	\$17.59	1 pc.	12.00	\$17.59	\$211.08	JOHNSTONE
X	HVAC Compressor	Com10042				EACH		0%	\$0.00	1 pc.	18.00	\$0.00	\$0.00	
	Compressor	SSF061A48PZ	COPELAND	TRB1K0ETFD690	\$1,899.00	EACH	\$925.93	0%	\$925.93	1 pc.	18.00	\$925.93	\$16,866.74	NEUCO
X	RTU Heat Control Board	13130453-01				EACH		0%	\$0.00	1 pc.	24.00	\$0.00	\$0.00	
X	RTU Board	6400-1079				EACH		0%	\$0.00	1 pc.	24.00	\$0.00	\$0.00	
X	Circuit Board	Z21291068-83-129A				EACH		0%	\$0.00	1 pc.	18.00	\$0.00	\$0.00	
	Freeze Stat	1171252	HELL QUAKER	1171252	\$95.00	EACH	\$22.47	0%	\$22.47	1 pc.	20.00	\$22.47	\$449.40	NEUCO
X	Circuit Balancing Valve	CBVDN20				EACH		0%	\$0.00	1 pc.	24.00	\$0.00	\$0.00	
	Supply Circulating Pump	S-45 AB	ARMSTRONG	174095-113	\$2,145.00	EACH	\$850.31	0%	\$850.31	1 pc.	6.00	\$850.31	\$5,101.86	NEUCO
	Refrigerant Switch	A30-262	ROBERT SHAW	A30-262 / B10-361	\$159.00	EACH	\$80.63	0%	\$80.63	1 pc.	12.00	\$80.63	\$727.56	JOHNSTONE
X	Humidifier Pump	MP16				EACH		0%	\$0.00	1 pc.	6.00	\$0.00	\$0.00	
	Steam Cylinder	BL081F00H2	GENERAL FILTER	20-14 / 915-375	\$275.00	EACH	\$129.25	0%	\$129.25	1 pc.	6.00	\$129.25	\$775.50	JOHNSTONE
X	Spray Nozzle	S-PRK0819				EACH		0%	\$0.00	1 pc.	12.00	\$0.00	\$0.00	
	Return Water Pump	VEDMM2513T	NIDEC	D13P2D / 891-624	\$1,745.00	EACH	\$820.15	0%	\$820.15	1 pc.	4.00	\$820.15	\$3,280.60	JOHNSTONE
	Motor AHU - 1,2,3,4,5	EHM3313T	NIDEC	D10P2D / 891-523	\$1,345.00	EACH	\$496.12	0%	\$496.12	1 pc.	12.00	\$496.12	\$5,953.44	JOHNSTONE
	Transformer	X13550266	IRANU	TRR0826	\$183.06	EACH	\$68.65	0%	\$68.65	1 pc.	12.00	\$68.65	\$823.80	NEUCO
	Actuator Valve	F7250HS + SY4-110	BELIMO	F7250HD-SY4-110	\$7,825.72	EACH	\$4,603.86	0%	\$4,603.86	1 pc.	3.00	\$4,603.86	\$13,811.58	NEUCO
	Actuators	LMB24-MFTIN-LB/5NM	BEIMO	LBM24-MFT	\$375.00	EACH	\$200.00	0%	\$200.00	1 pc.	12.00	\$200.00	\$2,400.00	NEUCO
	Seal Kit	185055 / F98	BELL & GOSSETT	185055	\$5,050.00	EACH	\$3,250.94	0%	\$3,250.94	1 pc.	12.00	\$3,250.94	\$39,011.28	BELL & GOSSETT
	Seal Kit	186827	BELL & GOSSETT	186827	\$555.00	EACH	\$357.29	0%	\$357.29	1 pc.	12.00	\$357.29	\$4,287.48	BELL & GOSSETT
X	Condenser Water Pump	4AC				EACH		0%	\$0.00	1 pc.	12.00	\$0.00	\$0.00	
	Booster Pump	PL-36B	BELL & GOSSETT	PL-36B / L80-534	\$1,099.00	EACH	\$418.31	0%	\$418.31	1 pc.	4.00	\$418.31	\$1,673.24	BELL & GOSSETT
X	600VAC Terminal Block	16220-3				EACH		0%	\$0.00	1 pc.	4.00	\$0.00	\$0.00	
X	Igniter	EF32CW193A				EACH		0%	\$0.00	1 pc.	8.00	\$0.00	\$0.00	
	Gas Valve	36C76 EF32CW193A	HONEYWELL	VR8316Q468C / L11-895	\$345.00	EACH	\$118.16	0%	\$118.16	1 pc.	8.00	\$118.16	\$708.96	JOHNSTONE
	Pressure Switch	DFS-221	CLEVELAND CONTROLS	DFS-221	\$79.20	EACH	\$31.68	0%	\$31.68	1 pc.	6.00	\$31.68	\$190.08	NEUCO
X	Compressor	SCA2-900E-FWD-200				EACH		0%	\$0.00	1 pc.	12.00	\$0.00	\$0.00	
	Compressor	R12MSE-TWD-961	COPELAND	ZL12M48E-TWD-961 / B72-597	\$4,499.00	EACH	\$1,870.67	0%	\$1,870.67	1 pc.	12.00	\$1,870.67	\$22,448.04	JOHNSTONE

HVAC PARTS- PRICING PAGE

EXHIBIT A

NOTE: VENDORS SHOULD COMPLETE ALL COLUMNS (Please fill in Single Percentage Discount in the bottom of this document prior to calculation, this will auto-populate prices if using the electronic spreadsheet)

Pricing Page Eligible Item Description					Discounted Unit Price Calculation					Bid Total Calculation				WHERE TO BRING PRODUCT FROM
Product Category	Description	Equal To (Part Number)	Manufacturer	Part Number / Johnstone #	Catalogue Price	Units Provided for Catalogue Price	Unit Price	Discount Percentage	Discounted Unit Price	Unit (For Calculation Purposes)	Estimated Unit Qty	Discounted Unit Price	Item Total Cost	
	Compressor	ZP4K3E-TFD-230	COPLAND	ZP42KSETPC900 / B74-037	\$1,699.00	EACH	\$688.51	0%	\$688.51	1 pc.	12.00	\$688.51	\$8,262.12	JOHNSTONE
	Base Auxiliary Contracts	C320KGS31	LITTON	C320KGS31	\$295.00	EACH	\$66.96	0%	\$66.96	1 pc.	4.00	\$66.96	\$267.84	NEUCO
	Compressor	HLM075T4LC6	DANFOSS	HLM075T4LC6 / B88-111	\$1,845.00	EACH	\$719.21	0%	\$719.21	1 pc.	4.00	\$719.21	\$2,876.84	JOHNSTONE
	Contractor	4SCA20AG318R	EATON	C25CAN0230B / 1.36-818	\$65.00	EACH	\$30.55	0%	\$30.55	1 pc.	12.00	\$30.55	\$366.60	JOHNSTONE
	0.5 Capacitor	E136401	PACKARD	POC7.5 / G71-89C	\$6.25	EACH	\$2.94	0%	\$2.94	1 pc.	12.00	\$2.94	\$35.28	JOHNSTONE
	Cell Assembly	2A203	OPENSUN CONTROLS	A19BUC-2	\$865.00	EACH	\$384.40	0%	\$384.40	1 pc.	12.00	\$384.40	\$4,812.80	NEUCO
X	1/4 hp Motor	4MT05				EACH		0%	\$0.00	1 pc.	4.00	\$0.00	\$0.00	
	Direct Drive Blower Motor	3LU831	NIDEC	5840 / S87-818	\$305.00	EACH	\$105.13	0%	\$105.13	1 pc.	3.00	\$105.13	\$315.39	JOHNSTONE
	Motor Run Capacitor 7.5 mfd	39121521	PACKARD	POC7.5 / G71-89C	\$6.25	EACH	\$2.94	0%	\$2.94	1 pc.	6.00	\$2.94	\$17.64	JOHNSTONE
	3ph Cont. Duty 3 hp Motor	3N658A	NIDEC	G3P2B / S81-520	\$849.00	EACH	\$319.99	0%	\$319.99	1 pc.	6.00	\$319.99	\$1,919.94	JOHNSTONE
X	1ph 1/25 hp Motor	JB2P078				EACH		0%	\$0.00	1 pc.	6.00	\$0.00	\$0.00	
	1/3 hp 1ph Motor	3K384	NIDEC	8100 / S87-828	\$235.00	EACH	\$82.25	0%	\$82.25	1 pc.	6.00	\$82.25	\$493.50	JOHNSTONE
X	Condenser Fan Motor	2X774Y2				EACH		0%	\$0.00	1 pc.	6.00	\$0.00	\$0.00	
	25MFD Capacitor	2MECS	PACKARD	TRCF25 / G36-304	\$13.49	EACH	\$6.34	0%	\$6.34	1 pc.	12.00	\$6.34	\$76.08	JOHNSTONE
	12.5MFD Capacitor	2MDV8A	PACKARD	TOC12.5 / G22-710	\$9.49	EACH	\$4.46	0%	\$4.46	1 pc.	12.00	\$4.46	\$53.52	JOHNSTONE
	35+5MFD Capacitor	2MEESA	PACKARD	TRCF35 / G36-304	\$18.99	EACH	\$8.93	0%	\$8.93	1 pc.	12.00	\$8.93	\$107.16	JOHNSTONE
	Capacitor 25 MFD 370 VAC	2MDW5	PACKARD	TRCF25 / G36-304	\$16.99	EACH	\$7.99	0%	\$7.99	1 pc.	12.00	\$7.99	\$95.88	JOHNSTONE
	Capacitor 25 MFD 370 VAC	2MDW3	PACKARD	TRCF25 / G36-304	\$13.49	EACH	\$6.34	0%	\$6.34	1 pc.	12.00	\$6.34	\$76.08	JOHNSTONE
II														
	Starter Capacitor	25UF	PACKARD	TRCF25 / G36-304	\$13.49	EACH	\$6.34	0%	\$6.34	1 pc.	12.00	\$6.34	\$76.08	JOHNSTONE
	Blower Motor	B123	AO SMITH	B123	\$528.28	EACH	\$236.80	0%	\$236.80	1 pc.	4.00	\$236.80	\$947.20	A O SMITH / REGAL
	Unit Heater	3UF80	RAYWALL	P3P510ECA1N / X90-173	\$1,445.00	EACH	\$543.71	0%	\$543.71	1 pc.	24.00	\$543.71	\$13,049.04	JOHNSTONE
X	Unloader Motor	6K197BB				EACH		0%	\$0.00	1 pc.	4.00	\$0.00	\$0.00	
X	Fan Motor	4GZC7				EACH		0%	\$0.00	1 pc.	12.00	\$0.00	\$0.00	
X	Thermostat	ORWH-SS-124D				EACH		0%	\$0.00	1 pc.	36.00	\$0.00	\$0.00	
X	Fresh Air Shutter Control	BS142B2				EACH		0%	\$0.00	1 pc.	2.00	\$0.00	\$0.00	
X	Contractor	20545-82				EACH		0%	\$0.00	1 pc.	12.00	\$0.00	\$0.00	
X	Condensate Pump	DP22T				EACH		0%	\$0.00	1 pc.	12.00	\$0.00	\$0.00	
X	Compressor Contactor	RP66NNZ7-45				EACH		0%	\$0.00	1 pc.	12.00	\$0.00	\$0.00	
X	3ph Cont. Duty 2hp Motor	B088768 / BW02				EACH		0%	\$0.00	1 pc.	4.00	\$0.00	\$0.00	
X	Pump	UW162AM9				EACH		0%	\$0.00	1 pc.	4.00	\$0.00	\$0.00	
	HVAC Blower Motor	K55HDHTK8877	NIDEC	5482H / S81-288	\$345.00	EACH	\$120.13	0%	\$120.13	1 pc.	4.00	\$120.13	\$480.52	JOHNSTONE

HVAC PARTS- PRICING PAGE

EXHIBIT A

NOTE: VENDORS SHOULD COMPLETE ALL COLUMNS (Please fill in Single Percentage Discount in the bottom of this document prior to calculation, this will auto-populate prices if using the electronic spreadsheet)

Pricing Page Eligible Item Description					Discounted Unit Price Calculation					Bid Total Calculation				WHERE TO BRING PRODUCT FROM
Product Category	Description	Equal To (Part Number)	Manufacturer	Part Number / Johnstone #	Catalogue Price	Units Provided for Catalogue Price	Unit Price	Discount Percentage	Discounted Unit Price	Unit (For Calculation Purpose)	Estimated Unit Qty	Discounted Unit Price	Item Total Cost	
	HVAC Blower Motor	K52HXJKR916	NIDEC	3742 / S89-627	\$525.00	EACH	\$192.87	0%	\$192.87	1 pc.	4.00	\$192.87	\$771.48	JOHNSTONE
	Liquid Filter	EK-1645	ALCO	EK1645 / B12-268	\$109.00	EACH	\$19.81	0%	\$19.81	1 pc.	12.00	\$19.81	\$237.72	JOHNSTONE
	Igniter	PLT3460	SIC	DB00/KJ / L46-114	\$58.00	EACH	\$22.13	0%	\$22.13	1 pc.	12.00	\$22.13	\$265.56	JOHNSTONE
	Liquid Filter	C-1638	ALCO	EK1638 / B12-268	\$105.00	EACH	\$19.25	0%	\$19.25	1 pc.	12.00	\$19.25	\$231.00	JOHNSTONE
	Induction Path Motor	X38040310-D1	FASCO	A275 / X82-149	\$889.00	EACH	\$336.89	0%	\$336.89	1 pc.	12.00	\$336.89	\$4,042.68	JOHNSTONE
	1hp Blower Motor	7126-5129	CLIMATE MASTER	14B0095N02	\$783.48	EACH	\$391.73	0%	\$391.73	1 pc.	12.00	\$391.73	\$4,700.76	NEUCO
X	HVAC Blower Motor	CPNX07670703				EACH		0%	\$0.00	1 pc.	12.00	\$0.00	\$0.00	
X	VSD	6LJ112301QX1B1				EACH		0%	\$0.00	1 pc.	12.00	\$0.00	\$0.00	
X	AF300 p11	6KP112301QX1B1				EACH		0%	\$0.00	1 pc.	8.00	\$0.00	\$0.00	
	HVAC Blower Motor	60961801	MCQUAY	30961801 / S80-037	\$400.00	EACH	\$197.27	0%	\$197.27	1 pc.	12.00	\$197.27	\$2,367.24	JOHNSTONE
	HVAC Blower Motor	5K48MN425BX9	TRANE	MOT7813	\$1,200.00	EACH	\$687.47	0%	\$687.47	1 pc.	18.00	\$687.47	\$12,374.46	NEUCO
	HVAC Blower Motor	4LX07G	NIDEC	D3E1DHZ / 571-127	\$729.00	EACH	\$275.99	0%	\$275.99	1 pc.	12.00	\$275.99	\$3,311.88	JOHNSTONE
X	Motor	5KCP39RG1723AS				EACH		0%	\$0.00	1 pc.	12.00	\$0.00	\$0.00	
	Condenser Fan Motor	MOT09192	FASCO	L2831 / S81-311	\$685.00	EACH	\$241.03	0%	\$241.03	1 pc.	12.00	\$241.03	\$2,892.36	JOHNSTONE
III														
	25 UF Capacitor	97F9633	PACKARD	TRCF25 / G96-304	\$13.49	EACH	\$6.34	0%	\$6.34	1 pc.	12.00	\$6.34	\$76.08	JOHNSTONE
	1/2 hp Blower Motor	5KCP39MG P5218	AO SMITH	390 / S89-858	\$385.00	EACH	\$127.19	0%	\$127.19	1 pc.	6.00	\$127.19	\$763.14	JOHNSTONE
	Defrost Board	PCBDM1018	GOODMAN	PCBDM1018 / B12-368	\$115.00	EACH	\$31.91	0%	\$31.91	1 pc.	12.00	\$31.91	\$382.92	JOHNSTONE
X	Reversing Valve	0210R058				EACH		0%	\$0.00	1 pc.	12.00	\$0.00	\$0.00	
	Condenser	CPKJ36-1AB	GOODMAN	VSZ110381 / E76-830	\$2,799.00	EACH	\$1,107.44	0%	\$1,107.44	1 pc.	8.00	\$1,107.44	\$8,859.52	JOHNSTONE
	Air Handler	AR42-1	GOODMAN	VRJFA3C14 / L8C-332	\$1,400.00	EACH	\$613.36	0%	\$613.36	1 pc.	2.00	\$613.36	\$1,226.72	JOHNSTONE
	Heat Kit	HKR-10C	GOODMAN	19R-10C / L86-305	\$175.00	EACH	\$84.18	0%	\$84.18	1 pc.	12.00	\$84.18	\$1,010.16	JOHNSTONE
	Exhaust Fan Motor	GB-200-T-X	FLOAIRE	BDXR20	\$1,500.00	EACH	\$719.33	0%	\$719.33	1 pc.	24.00	\$719.33	\$17,263.92	FLOAIRE
	Digital Thermostat	TH5220D	HONEYWELL	TH5220D1003 / L40-704	\$139.00	EACH	\$54.02	0%	\$54.02	1 pc.	24.00	\$54.02	\$1,296.48	JOHNSTONE
	Thermostat - Non Programmable	YTH5320R1025	HONEYWELL	YTH5320R1025 / L44-839	\$355.00	EACH	\$152.85	0%	\$152.85	1 pc.	24.00	\$152.85	\$3,668.60	JOHNSTONE
X	Fan Motor	10016056P				EACH		0%	\$0.00	1 pc.	12.00	\$0.00	\$0.00	
	T-Stats	T4054	JOHNSON CONTROLS	T-4054-1	\$300.00	EACH	\$127.41	0%	\$127.41	1 pc.	12.00	\$127.41	\$1,848.92	NEUCO
IV														
	T-Stats	T4051A	HONEYWELL	T6051A1016	\$250.00	EACH	\$111.84	0%	\$111.84	1 pc.	12.00	\$111.84	\$1,342.08	NEUCO
X	HVAC Compressor	60517				EACH		0%	\$0.00	1 pc.	12.00	\$0.00	\$0.00	
	Temperature Control Reset	A70HA-1C	JOHNSON CONTROLS	A70HA-1C / L39-491	\$575.00	EACH	\$159.92	0%	\$159.92	1 pc.	12.00	\$159.92	\$1,919.04	JOHNSTONE
	Close High Temp Control	A70AA-18C	JOHNSON CONTROLS	A70AA-18	\$400.00	EACH	\$116.00	0%	\$116.00	1 pc.	12.00	\$116.00	\$1,392.00	NEUCO
V														

HVAC PARTS- PRICING PAGE

EXHIBIT A

NOTE: VENDORS SHOULD COMPLETE ALL COLUMNS (Please fill in Single Percentage Discount in the bottom of this document prior to calculation, this will auto-populate prices if using the electronic spreadsheet)

Pricing Page Eligible Item Description					Discounted Unit Price Calculation					Bld Total Calculation				WHERE TO BRING PRODUCT FROM
Product Category	Description	Equal To (Part Number)	Manufacturer	Part Number / Johnstone #	Catalogue Price	Units Provided for Catalogue Price	Unit Price	Discount Percentage	Discounted Unit Price	Unit (For Calculation Purposes)	Estimated Unit Qty	Discounted Unit Price	Item Total Cost	
	Hi-Pressure Switch	P70KA	JOHNSON CONTROLS	P70KA-1	\$425.00	EACH	\$145.93	0%	\$145.93	1 pc.	12.00	\$145.93	\$1,751.16	NEUCO
	HVAC Condensate Pump	VCMA-20ULS	LITTLE GIANT	VCMA-20ULS / B81-120	\$105.00	EACH	\$49.35	0%	\$49.35	1 pc.	12.00	\$49.35	\$592.20	JOHNSTONE
	Condensate Pump	VCMA-15UL	LITTLE GIANT	VCMA-15UL / B81-119	\$85.00	EACH	\$39.95	0%	\$39.95	1 pc.	12.00	\$39.95	\$479.40	JOHNSTONE
VI														
X	S-Flex Coupling	3LZ65468514436848				EACH		0%	\$0.00	1 pc.	12.00	\$0.00	\$0.00	
X	HVAC Blower Motor	AQL56T17DS847A				EACH		0%	\$0.00	1 pc.	12.00	\$0.00	\$0.00	
X	Electric Duct Heater	3HF20				EACH		0%	\$0.00	1 pc.	6.00	\$0.00	\$0.00	
VII														
	Float Switch	FS4-3	MCDONNELL MILLER	FS4-3 / L37-352	\$235.00	EACH	\$110.45	0%	\$110.45	1 pc.	12.00	\$110.45	\$1,325.40	JOHNSTONE
	Fan Motor	910101195	MCQUAY	910101195	\$400.00	EACH	\$184.57	0%	\$184.57	1 pc.	24.00	\$184.57	\$4,429.68	NEUCO
	Control Board	668105601	MCQUAY	668105601	\$325.00	EACH	\$120.39	0%	\$120.39	1 pc.	24.00	\$120.39	\$2,889.36	NEUCO
X	HVAC Reversing Valve	CC4036AMFE				EACH		0%	\$0.00	1 pc.	24.00	\$0.00	\$0.00	
	C230A Contractor	L45-035	PACKARD	L45-035	\$23.99	EACH	\$11.28	0%	\$11.28	1 pc.	8.00	\$11.28	\$90.24	JOHNSTONE
X	Single Pole Thermostat	EFFT1				EACH		0%	\$0.00	1 pc.	24.00	\$0.00	\$0.00	
	18" 27 Deg Pitch Fan	XW1803-27-L	PACKARD	R31810 / W80-002	\$145.00	EACH	\$47.93	0%	\$47.93	1 pc.	6.00	\$47.93	\$287.58	JOHNSTONE
	2 hd Stage Colling Control	RIBTW2401B-LN	FUNCTIONAL DEVICES	RIBTW2401B-LN	\$225.00	EACH	\$113.65	0%	\$113.65	1 pc.	12.00	\$113.65	\$1,363.80	NEUCO
	Transformer	TR75VA005	FUNCTIONAL DEVICES	TR75VA005	\$60.00	EACH	\$27.76	0%	\$27.76	1 pc.	12.00	\$27.76	\$333.12	NEUCO
X	Control Module	149710				EACH		0%	\$0.00	1 pc.	12.00	\$0.00	\$0.00	
	Igniter Kit	KIT03033	SIC	DS010K1 / L46-113	\$115.00	EACH	\$27.28	0%	\$27.28	1 pc.	24.00	\$27.28	\$654.72	JOHNSTONE
	V-Belt Idler Pulley	SHED1565	TRANE	S-4E6354	\$58.00	EACH	\$23.36	0%	\$23.36	1 pc.	24.00	\$23.36	\$560.64	NEUCO
X	Silencid Valve	VAL3218				EACH		0%	\$0.00	1 pc.	24.00	\$0.00	\$0.00	
	Ball Bearing Unit	BRG00648	TRANE	BRG0648	\$350.00	EACH	\$204.49	0%	\$204.49	1 pc.	12.00	\$204.49	\$2,453.88	NEUCO
X	Float	SA51-30				EACH		0%	\$0.00	1 pc.	12.00	\$0.00	\$0.00	
	Float Switch	FS4-3	MCDONNELL MILLER	FS4-3 / L37-352	\$235.00	EACH	\$110.45	0%	\$110.45	1 pc.	12.00	\$110.45	\$1,325.40	JOHNSTONE
	Fan Motor	910101195	MCQUAY	910101195	\$400.00	EACH	\$184.57	0%	\$184.57	1 pc.	24.00	\$184.57	\$4,429.68	NEUCO
	Control Board	668105601	MCQUAY	668105601	\$325.00	EACH	\$120.39	0%	\$120.39	1 pc.	24.00	\$120.39	\$2,889.36	NEUCO
X	HVAC Reversing Valve	CC4036AMFE				EACH		0%	\$0.00	1 pc.	24.00	\$0.00	\$0.00	
	C230A Contractor	L45-035	PACKARD	L45-035	\$23.99	EACH	\$11.28	0%	\$11.28	1 pc.	8.00	\$11.28	\$90.24	JOHNSTONE
X	Single Pole Thermostat	EFFT1				EACH		0%	\$0.00	1 pc.	24.00	\$0.00	\$0.00	
	18" 27 Deg Pitch Fan	XW1803-27-L	PACKARD	R31810 / W80-002	\$145.00	EACH	\$47.93	0%	\$47.93	1 pc.	6.00	\$47.93	\$287.58	JOHNSTONE
	2 hd Stage Colling Control	RIBTW2401B-LN	FUNCTIONAL DEVICES	RIBTW2401B-LN	\$225.00	EACH	\$113.65	0%	\$113.65	1 pc.	12.00	\$113.65	\$1,363.80	NEUCO
	Transformer	TR75VA005	FUNCTIONAL DEVICES	TR75VA005	\$60.00	EACH	\$27.76	0%	\$27.76	1 pc.	12.00	\$27.76	\$333.12	NEUCO
X	Control Module	149710				EACH		0%	\$0.00	1 pc.	12.00	\$0.00	\$0.00	

HVAC PARTS- PRICING PAGE

EXHIBIT A

NOTE: VENDORS SHOULD COMPLETE ALL COLUMNS (Please fill in Single Percentage Discount in the bottom of this document prior to calculation, this will auto-populate prices if using the electronic spreadsheet)

Pricing Page Eligible Item Description					Discounted Unit Price Calculation					Bid Total Calculation				WHERE TO BRING PRODUCT FROM
Product Category	Description	Equal To (Part Number)	Manufacturer	Part Number / Johnstone #	Catalogue Price	Units Provided for Catalogue Price	Unit Price	Discount Percentage	Discounted Unit Price	Unit (For Calculation Purposes)	Estimated Unit Qty	Discounted Unit Price	Item Total Cost	
	Igniter Kit	KIT03033	SIC	DS010KJ / LV6-113	\$115.00	EACH	\$27.28	0%	\$27.28	1 pc.	24.00	\$27.28	\$654.72	JOHNSTONE
	V-Belt Idler Pulley	SHE01565	TRANE	SHE3354	\$58.00	EACH	\$23.36	0%	\$23.36	1 pc.	24.00	\$23.36	\$560.64	NEUCO
X	Silcock Valve	VAL3218				EACH		0%	\$0.00	1 pc.	24.00	\$0.00	\$0.00	
	Ball Bearing Unit	BRG00648	TRANE	BR30848	\$350.00	EACH	\$204.49	0%	\$204.49	1 pc.	12.00	\$204.49	\$2,453.88	NEUCO
	Suction Line Dryer	C-304-S	ALCO	EK-304S / B12-274	\$135.00	EACH	\$38.15	0%	\$38.15	1 pc.	20.00	\$38.15	\$763.00	JOHNSTONE
X	3/4 hp 3ph Motor	242411005				EACH		0%	\$0.00	1 pc.	12.00	\$0.00	\$0.00	
	Suction Line Filter	C-083-S-T-1HI	SFORLAN	109436	\$125.00	EACH	\$33.93	0%	\$33.93	1 pc.	12.00	\$33.93	\$407.16	NEUCO
	Hermetic Line Filter	SI-FD163S	EMERSON	85B-163S / E17-225	\$65.00	EACH	\$17.58	0%	\$17.58	1 pc.	12.00	\$17.58	\$210.96	JOHNSTONE
	Contractor	8910DPA33V14	PACKARD	L45-049	\$55.00	EACH	\$13.90	0%	\$13.90	1 pc.	10.00	\$13.90	\$139.00	JOHNSTONE
	Contractor	8910DP42V14	PACKARD	L45-038	\$49.50	EACH	\$13.86	0%	\$13.86	1 pc.	24.00	\$13.86	\$332.64	JOHNSTONE
X	3ph Magnetic Motor Starter	284102				EACH		0%	\$0.00	1 pc.	10.00	\$0.00	\$0.00	
	Vac Pump	502194	ROBINAIR	H65-445	\$505.00	EACH	\$179.99	0%	\$179.99	1 pc.	24.00	\$179.99	\$4,319.76	JOHNSTONE
X	Condensate Pump	P4RNDZEB7Z				EACH		0%	\$0.00	1 pc.	12.00	\$0.00	\$0.00	
X	Condensate Pump Motor / Pump Assembly	CR5-4				EACH		0%	\$0.00	1 pc.	12.00	\$0.00	\$0.00	
	Starter / Hard Start Capacitor	4E240A	SUPCO	SPP6 / 311-519	\$85.00	EACH	\$7.99	0%	\$7.99	1 pc.	12.00	\$7.99	\$95.88	JOHNSTONE
	Zone Sensors	X1379049201	TRANE	SEN1384	\$300.00	EACH	\$137.93	0%	\$137.93	1 pc.	72.00	\$137.93	\$9,930.96	NEUCO
X	Programmable Controllers	CNT-FRC002-EN				EACH		0%	\$0.00	1 pc.	12.00	\$0.00	\$0.00	
X	Tracer Loop Controller WMCA	WMCA000BADA				EACH		0%	\$0.00	1 pc.	12.00	\$0.00	\$0.00	
X	Tracer Zone Controller	ZN-511				EACH		0%	\$0.00	1 pc.	12.00	\$0.00	\$0.00	
X	Tracer Unitary Controller	ZN517				EACH		0%	\$0.00	1 pc.	12.00	\$0.00	\$0.00	
X	Tracer Multi-Purpose Controller	MP501				EACH		0%	\$0.00	1 pc.	12.00	\$0.00	\$0.00	
X	Tracer Input / Output Module	MP503				EACH		0%	\$0.00	1 pc.	12.00	\$0.00	\$0.00	
X	Air Handling Unit Controller	AH540/541				EACH		0%	\$0.00	1 pc.	12.00	\$0.00	\$0.00	
X	Refrigerant Monitor	RMWE-10M-1				EACH		0%	\$0.00	1 pc.	12.00	\$0.00	\$0.00	
	Comm / Link Board	X13650464	TRANE	BRD2893	\$500.00	EACH	\$231.61	0%	\$231.61	1 pc.	24.00	\$231.61	\$5,568.64	NEUCO
	Transformer	X13560074-01	TRANE	TRR0984	\$650.00	EACH	\$327.59	0%	\$327.59	1 pc.	24.00	\$327.59	\$7,862.16	NEUCO
X	Compressor	CSHX100K0A0C				EACH		0%	\$0.00	1 pc.	24.00	\$0.00	\$0.00	
	Liquid Line Filter Dryer	DHY01307	TRANE	LV11470	\$100.00	EACH	\$44.72	0%	\$44.72	1 pc.	24.00	\$44.72	\$1,073.28	NEUCO
	Wall Thermostat	X13790886-01REV SEN1599	TRANE	SEN2076	\$325.00	EACH	\$173.44	0%	\$173.44	1 pc.	72.00	\$173.44	\$12,487.68	NEUCO
X	Tracer Summit BCU	BMT6001AAB001				EACH		0%	\$0.00	1 pc.	6.00	\$0.00	\$0.00	
	Thermostat	X13790866-01REV SEN1599	TRANE	SEN2076	\$325.00	EACH	\$173.44	0%	\$173.44	1 pc.	72.00	\$173.44	\$12,487.68	NEUCO
X	Trane Board	49500569				EACH		0%	\$0.00	1 pc.	72.00	\$0.00	\$0.00	

HVAC PARTS- PRICING PAGE

EXHIBIT A

NOTE: VENDORS SHOULD COMPLETE ALL COLUMNS (Please fill in Single Percentage Discount in the bottom of this document prior to calculation, this will auto-populate prices if using the electronic spreadsheet)

Pricing Page Eligible Item Description					Discounted Unit Price Calculation					Bid Total Calculation				WHERE TO BRING PRODUCT FROM
Product Category	Description	Equal To (Part Number)	Manufacturer	Part Number / Johnstone #	Catalogue Price	Units Provided for Catalogue Price	Unit Price	Discount Percentage	Discounted Unit Price	Unit (For Calculation Purposes)	Estimated Unit Qty	Discounted Unit Price	Item Total Cost	
All references to brand names are for illustration purposes only and vendors may bid the brand listed or an equal product.														
	Control Board	X13650882-01	TRANE	MOD138C	\$250.00	EACH	\$104.96	0%	\$104.96	1 pc.	72.00	\$104.96	\$7,557.12	NEUCO
X	RTU Board	LCIR				EACH		0%	\$0.00	1 pc.	72.00	\$0.00	\$0.00	
X	Air Handler AHU - 1,2,3,4,5	CSAA017VAC00				EACH		0%	\$0.00	1 pc.	72.00	\$0.00	\$0.00	
X	Actuator AHU - 1,2,3,4,5	X13610447-06				EACH		0%	\$0.00	1 pc.	72.00	\$0.00	\$0.00	
	T Sists	X13511527-01 REVA 1042CT	TRANE	SEN1417	\$275.00	EACH	\$136.64	0%	\$136.64	1 pc.	72.00	\$136.64	\$9,838.08	NEUCO
X	VFD AHU - 1,2,3,4,5	VFD AHU - 1,2,3,4,5				EACH		0%	\$0.00	1 pc.	4.00	\$0.00	\$0.00	
X	B-1 Trap	CB3-5				EACH		0%	\$0.00	1 pc.	4.00	\$0.00	\$0.00	
X	B-3 Trap	2899				EACH		0%	\$0.00	1 pc.	4.00	\$0.00	\$0.00	
	T-Stat	SEN01599	TRANE	SEN207a	\$325.00	EACH	\$173.44	0%	\$173.44	1 pc.	4.00	\$173.44	\$683.76	NEUCO
X	Transducer	PWA-2T-C				EACH		0%	\$0.00	1 pc.	4.00	\$0.00	\$0.00	
X	Receiver	X13790854-01				EACH		0%	\$0.00	1 pc.	4.00	\$0.00	\$0.00	
	Motor 115 V	MoK13589	FASCO	01989	\$425.00	EACH	\$170.40	0%	\$170.40	1 pc.	4.00	\$170.40	\$681.60	NEUCO
	Motor 115 V	MoK3590	TRANE	MOT126G1	\$825.00	EACH	\$441.67	0%	\$441.67	1 pc.	4.00	\$441.67	\$1,766.68	NEUCO
	Freestat	X13790886-01 REV SEN01599	TRANE	SEN207b	\$325.00	EACH	\$173.44	0%	\$173.44	1 pc.	12.00	\$173.44	\$2,081.28	NEUCO
X	RTU Main Board	6400-1352-01				EACH		0%	\$0.00	1 pc.	12.00	\$0.00	\$0.00	
	Capacitor 370 Volt	7.5UF	PACKARD	POCT 5 / G 21-933	\$6.25	EACH	\$2.94	0%	\$2.94	1 pc.	12.00	\$2.94	\$35.28	JOHNSTONE
	Digital Fan Wireless Thermostat	VT7305F5000W	SCHNEIDER ELECTRIC	V17309F5000W	\$674.00	EACH	\$231.41	0%	\$231.41	1 pc.	12.00	\$231.41	\$2,776.92	SCHNEIDER ELEC
X	Condenser Fan Motor	1008317550				EACH		0%	\$0.00	1 pc.	12.00	\$0.00	\$0.00	
	Transformer	90-T75C3	PACKARD	PF42440 / G22-336	\$27.99	EACH	\$13.16	0%	\$13.16	1 pc.	12.00	\$13.16	\$157.92	JOHNSTONE
X	Strainer	FNPTXFNPT				EACH		0%	\$0.00	1 pc.	12.00	\$0.00	\$0.00	
	Bearing	6212-ZZ-C3	T B WOODS	6212ZZ	\$125.00	EACH	\$53.51	0%	\$53.51	1 pc.	12.00	\$53.51	\$642.12	NEUCO
Total Bid Price												\$338,476.55		

SINGLE PERCENTAGE DISCOUNT FOR ALL PRODUCT CATEGORIES

HVAC PARTS- PRICING PAGE

EXHIBIT A

NOTE: VENDORS SHOULD COMPLETE ALL COLUMNS (Please fill in Single Percentage Discount in the bottom of this document prior to calculation, this will auto-populate prices if using the electronic spreadsheet)

Pricing Page Eligible Item Description					Discounted Unit Price Calculation					Bid Total Calculation			
All references to brand names are for illustration purposes only and vendors may bid the brand listed or an equal product.													
Product Category	Description	Equal To (Part Number)	Manufacturer	Part Number / Johnstone #	Catalogue Price	Units Provided for Catalogue Price	Unit Price	Discount Percentage	Discounted Unit Price	Unit (For Calculation Purpose)	Estimated Unit Qty	Discounted Unit Price	Item Total Cost

WHERE TO
BRING
PRODUCT
FROM

Vendors should complete the contract coordinator information below:

VENDOR: JOHNSTONE SUPPLY PHONE: 304-744-2665
 NAME: _____
 CONTRACT MANAGER: JON DICKSON FAX: 304-744-7888

 (Please print)
 VENDOR ADDRESS: 101 1ST AVE EMAIL: jon.dickson@johnstonesupply.com

SOUTH CHARLESTON, WV 25303

 AUTHORIZED REPRESENTATIVE: _____ (Date)
 _____ (Signature)
 AUTHORIZED REPRESENTATIVE: _____ (Print)

Quotation

Johnstone South Charleston
101 1st Avenue
SOUTH CHARLESTON, WV 25303

EXPIRATION DATE	QUOTE NUMBER
09/19/2015	212-100742326
PAGE NO	
1 of 9	

QUOTE TO:

SHIP TO:

WV DEPT OF ADMINISTRATION
 GENERAL SERVICES DIVISON
 BLDG 1 RM MB 60
 CHARLESTON, WV 25305

WV DEPT OF ADMINISTRATION
 GENERAL SERVICES DIVISON
 BLDG 1 RM MB 60
 CHARLESTON, WV 25305
 304-957-7144

CUSTOMER NUMBER	CUSTOMER PO NUMBER	JOB NAME / RELEASE NUMBER	SALESPERSON		
2900	gsd1600000006	HVAC PARTS BID	Jon Dickson		
WRITER		SHIP VIA	TERMS	SHIP DATE	FREIGHT ALLOWED
Jon Dickson		WILL CALL	NET 30 DAYS	08/05/2015	No
ORDER QTY	DESCRIPTION		UNIT PRICE	EXT PRICE	
1ea	G36-330 TRCFD505 50/5 MFD 440/370V ROUND		11.980/ea	11.98	
1ea	B17-225 BSB-163S 066131 BI FLOW		17.587/ea	17.59	
1ea	ZR61K3ETFD930 COMPRESSOR NONSTOCK**NONRETURNABLE**NO CANCEL*		925.930/ea	925.93	
1ea	1171252 FREEZE STAT (HEIL) NONSTOCK**NONRETURNABLE**NO CANCEL*		22.470/ea	22.47	
1ea	174036-113 S45BF 1/4HP CI BDY/NFI PUMP ARMSTRONG NONSTOCK**NONRETURNABLE**NO CANCEL*		850.310/ea	850.31	
1ea	B10-361 A30-262 REFRIGERATION CONTROL NONSTOCK**NONRETURNABLE**NO CANCEL*		60.630/ea	60.63	
1ea	B15-325 20-14 REPL CYLNR FOR DS20/RS20 NONSTOCK**NONRETURNABLE**NO CANCEL*		129.250/ea	129.25	
1ea	S91-524 D15P2D MOTOR 254T 15HP NONSTOCK**NONRETURNABLE**NO CANCEL*		820.150/ea	820.15	
1ea	S91-523 D10P2D MOTOR 215T 10HP NONSTOCK**NONRETURNABLE**NO CANCEL*		496.120/ea	496.12	
1ea	TRR0826 460-575V-PRI 24V-SEC 75VA TRAN NONSTOCK**NONRETURNABLE**NO CANCEL*		68.650/ea	68.65	
** Continued on Next Page *			Subtotal		
			S&H Charges		
			Sales Tax		
			Amount Due		

Quotation

Johnstone South Charleston
101 1st Avenue
SOUTH CHARLESTON, WV 25303

EXPIRATION DATE	QUOTE NUMBER
09/19/2015	212-100742326
PAGE NO	
2 of 9	

Johnstone South Charleston
 101 1st Avenue
 SOUTH CHARLESTON, WV 25303

QUOTE TO:

SHIP TO:

WV DEPT OF ADMINISTRATION
 GENERAL SERVICES DIVISON
 BLDG 1 RM MB 60
 CHARLESTON, WV 25305

WV DEPT OF ADMINISTRATION
 GENERAL SERVICES DIVISON
 BLDG 1 RM MB 60
 CHARLESTON, WV 25305
 304-957-7144

CUSTOMER NUMBER	CUSTOMER PO NUMBER	JOB NAME / RELEASE NUMBER	SALESPERSON		
2900	gsd1600000006	HVAC PARTS BID	Jon Dickson		
WRITER		SHIP VIA	TERMS	SHIP DATE	FREIGHT ALLOWED
Jon Dickson		WILL CALL	NET 30 DAYS	08/05/2015	No
ORDER QTY	DESCRIPTION		UNIT PRICE	EXT PRICE	
1ea	F7250HD+SY4-110 10"BflyVlv 3Way SS w/120vAct NONSTOCK**NONRETURNABLE**NO CANCEL*		4603.860/ea	4603.86	
1ea	LMB24-MFT 24v 45inlb NSR 2-10vdc NONSTOCK**NONRETURNABLE**NO CANCEL*		200.000/ea	200.00	
1ea	185055 SEAL KIT (B&G) NONSTOCK**NONRETURNABLE**NO CANCEL*		2889.720/ea	2889.72	
1ea	186827 SEAL KIT (B&G) NONSTOCK**NONRETURNABLE**NO CANCEL*		357.290/ea	357.29	
1ea	L80-534 1BL003LF BRONZE CIRCULATOR NONSTOCK**NONRETURNABLE**NO CANCEL*		418.307/ea	418.31	
1ea	L41-695 VR8345Q4563 UNIV. GAS VALVE 3/4x3/4 NONSTOCK**NONRETURNABLE**NO CANCEL*		118.160/ea	118.16	
1ea	DFS-221 SwitchSet@.05"WC, ComprssnFttnng NONSTOCK**NONRETURNABLE**NO CANCEL*		31.680/ea	31.68	
1ea	B73-597 ZR12M3E-TWD-961 460-3 10T POE SCROLL NONSTOCK**NONRETURNABLE**NO CANCEL*		1870.671/ea	1870.67	
1ea	B74-037 ZP42K5E-TFD-800 R410A SCROLL COMP NONSTOCK**NONRETURNABLE**NO CANCEL* * Sub for: B90-419 ZP44K3E-TFD-930 3		688.507/ea	688.51	
** Continued on Next Page *			Subtotal		
			S&H Charges		
			Sales Tax		
			Amount Due		

Quotation

Johnstone South Charleston
101 1st Avenue
SOUTH CHARLESTON, WV 25303

EXPIRATION DATE	QUOTE NUMBER
09/19/2015	212-100742326
PAGE NO	
3 of 9	

Johnstone South Charleston
 101 1st Avenue
 SOUTH CHARLESTON, WV 25303

QUOTE TO:

SHIP TO:

WV DEPT OF ADMINISTRATION
 GENERAL SERVICES DIVISON
 BLDG 1 RM MB 60
 CHARLESTON, WV 25305

WV DEPT OF ADMINISTRATION
 GENERAL SERVICES DIVISON
 BLDG 1 RM MB 60
 CHARLESTON, WV 25305
 304-957-7144

CUSTOMER NUMBER	CUSTOMER PO NUMBER	JOB NAME / RELEASE NUMBER	SALESPERSON		
2900	gsd1600000006	HVAC PARTS BID	Jon Dickson		
WRITER		SHIP VIA	TERMS	SHIP DATE	FREIGHT ALLOWED
Jon Dickson		WILL CALL	NET 30 DAYS	08/05/2015	No
ORDER QTY	DESCRIPTION		UNIT PRICE	EXT PRICE	
1ea	C320KGS31 1 N/O Aux For Conatctor NONSTOCK**NONRETURNABLE**NO CANCEL*		66.960/ea	66.96	
1ea	B98-411 HLM075T4LC6 6T 460/3 SCROLL COMP NONSTOCK**NONRETURNABLE**NO CANCEL*		719.212/ea	719.21	
1ea	L36-818 C25DND230B 2P,30AMP,DP CONT. NONSTOCK**NONRETURNABLE**NO CANCEL*		30.550/ea	30.55	
1ea	G21-933 POC7.5 TOC7.5 7.5M370V RUN CAPACITOR		2.938/ea	2.94	
1ea	A19BUC-2C 20/80F X-PRF SPDT, COILED-BULB NONSTOCK**NONRETURNABLE**NO CANCEL*		384.400/ea	384.40	
1ea	S87-818 5840 1/2HP4SP115V,OEM DD MOTOR NONSTOCK**NONRETURNABLE**NO CANCEL*		105.129/ea	105.13	
1ea	G21-933 POC7.5 TOC7.5 7.5M370V RUN CAPACITOR		2.938/ea	2.94	
1ea	S91-520 D3P2D MOTOR 182T 3HP NONSTOCK**NONRETURNABLE**NO CANCEL*		319.990/ea	319.99	
1ea	S87-628 8100 1/3HP,115V,BD MOTOR		82.250/ea	82.25	
1ea	G36-304 TRCF25 25 MFD 440/370V ROUND		6.340/ea	6.34	
1ea	G22-730 TOC12.5 POC12.5 12.5M370V RUN CAPACITOR		4.460/ea	4.46	
** Continued on Next Page *			Subtotal		
			S&H Charges		
			Sales Tax		
			Amount Due		

Quotation

Johnstone South Charleston
101 1st Avenue
SOUTH CHARLESTON, WV 25303

EXPIRATION DATE	QUOTE NUMBER
09/19/2015	212-100742326
PAGE NO	
4 of 9	

QUOTE TO:

SHIP TO:

WV DEPT OF ADMINISTRATION
 GENERAL SERVICES DIVISON
 BLDG 1 RM MB 60
 CHARLESTON, WV 25305

WV DEPT OF ADMINISTRATION
 GENERAL SERVICES DIVISON
 BLDG 1 RM MB 60
 CHARLESTON, WV 25305
 304-957-7144

CUSTOMER NUMBER	CUSTOMER PO NUMBER	JOB NAME / RELEASE NUMBER	SALESPERSON		
2900	gsd1600000006	HVAC PARTS BID	Jon Dickson		
WRITER		SHIP VIA	TERMS	SHIP DATE	FREIGHT ALLOWED
Jon Dickson		WILL CALL	NET 30 DAYS	08/05/2015	No
ORDER QTY	DESCRIPTION		UNIT PRICE	EXT PRICE	
1ea	G36-322 TRCFD355 35/5 MFD 440/370V ROUND		8.925/ea	8.93	
1ea	G36-306 TRCF35 35 MFD 440/370V ROUND		7.985/ea	7.99	
1ea	B123 Pool Motor PSC 56C 1.5hp 3450rpm 1speed 230/115v 1phase NONSTOCK**NONRETURNABLE**NO CANCEL*		236.800/ea	236.80	
1ea	X90-473 P3P5105CA1N 480V UNIT HEATER NONSTOCK**NONRETURNABLE**NO CANCEL*		543.714/ea	543.71	
1ea	S81-268 5482H 3/4-1/4HP 208-230 70C MTR NONSTOCK**NONRETURNABLE**NO CANCEL*		120.129/ea	120.13	
1ea	S89-637 3742 3/4HP, 1075RPM, 460V TENV NONSTOCK**NONRETURNABLE**NO CANCEL*		192.871/ea	192.87	
1ea	B12-268 EK-164S 1/2 ODF LIQUID DRIER		19.814/ea	19.81	
1ea	L46-114 DS007KJ DS007 LOCHINVAR PLT#3400 NONSTOCK**NONRETURNABLE**NO CANCEL*		22.133/ea	22.13	
1ea	B12-266 EK-163S 047614 3/8 ODF LIQUID DRIER NONSTOCK**NONRETURNABLE**NO CANCEL*		19.250/ea	19.25	
** Continued on Next Page *			Subtotal		
			S&H Charges		
			Sales Tax		
			Amount Due		

Quotation

Johnstone South Charleston
101 1st Avenue
SOUTH CHARLESTON, WV 25303

EXPIRATION DATE	QUOTE NUMBER
09/19/2015	212-100742326
PAGE NO.	
5 of 9	

QUOTE TO:

SHIP TO:

WV DEPT OF ADMINISTRATION
 GENERAL SERVICES DIVISON
 BLDG 1 RM MB 60
 CHARLESTON, WV 25305

WV DEPT OF ADMINISTRATION
 GENERAL SERVICES DIVISON
 BLDG 1 RM MB 60
 CHARLESTON, WV 25305
 304-957-7144

CUSTOMER NUMBER	CUSTOMER PO NUMBER	JOB NAME / RELEASE NUMBER	SALESPERSON		
2900	gsd1600000006	HVAC PARTS BID	Jon Dickson		
WRITER		SHIP VIA	TERMS	SHIP DATE	FREIGHT ALLOWED
Jon Dickson		WILL CALL	NET 30 DAYS	08/05/2015	No
ORDER QTY	DESCRIPTION		UNIT PRICE	EXT PRICE	
1ea	X82-149 A273 70625784 1/8 HP BLOWER NONSTOCK**NONRETURNABLE**NO CANCEL*		336.886/ea	336.89	
1ea	14B0025N02 460v1ph 3/4&1/2HP 3SPD MOTOR NONSTOCK**NONRETURNABLE**NO CANCEL*		391.740/ea	391.74	
1ea	S80-037 060961801 MTR 1/3HP 900-1100RPM NONSTOCK**NONRETURNABLE**NO CANCEL*		197.267/ea	197.27	
1ea	MOT2913 1HP 208-230/460V 1725RPM Trane Motor NONSTOCK**NONRETURNABLE**NO CANCEL*		687.470/ea	687.47	
1ea	S81-127 D3E2DHZ 3HP 208-230V/460 56HZ NONSTOCK**NONRETURNABLE**NO CANCEL*		275.986/ea	275.99	
1ea	S81-341 D2851 1HP,208-230/460V,MTR NONSTOCK**NONRETURNABLE**NO CANCEL*		241.027/ea	241.03	
1ea	G36-304 TRCF25 25 MFD 440/370V ROUND		6.340/ea	6.34	
1ea	S89-856 390 390 1/4 1050(3) REV MTR NONSTOCK**NONRETURNABLE**NO CANCEL*		127.186/ea	127.19	
1ea	B12-388 PCBDM130S PCBDM101S HEAT PUMP DEF TIMR W/FUSE		31.907/ea	31.91	
1ea	B75-930 VSZ140361 HEAT PUMP 14S 3T		1107.435/ea	1107.44	
1ea	L93-332 ARUF43C14 AIR HANDLER 3.5T 21IN		613.365/ea	613.36	
** Continued on Next Page *			Subtotal		
			S&H Charges		
			Sales Tax		
			Amount Due		

Quotation

Johnstone South Charleston
101 1st Avenue
SOUTH CHARLESTON, WV 25303

EXPIRATION DATE	QUOTE NUMBER
09/19/2015	212-100742326
PAGE NO	
6 of 9	

Johnstone South Charleston
 101 1st Avenue
 SOUTH CHARLESTON, WV 25303

QUOTE TO:

SHIP TO:

WV DEPT OF ADMINISTRATION
 GENERAL SERVICES DIVISON
 BLDG 1 RM MB 60
 CHARLESTON, WV 25305

WV DEPT OF ADMINISTRATION
 GENERAL SERVICES DIVISON
 BLDG 1 RM MB 60
 CHARLESTON, WV 25305
 304-957-7144

CUSTOMER NUMBER	CUSTOMER PO NUMBER	JOB NAME / RELEASE NUMBER	SALESPERSON	
2900	gsd1600000006	HVAC PARTS BID	Jon Dickson	
WRITER	SHIP VIA	TERMS	SHIP DATE	FREIGHT ALLOWED
Jon Dickson	WILL CALL	NET 30 DAYS	08/05/2015	No
ORDER QTY	DESCRIPTION	UNIT PRICE	EXT PRICE	
1ea	L86-505 HKR-10C 10KW ELECTRIC HEAT KIT	84.180/ea	84.18	
1ea	BDCR20 Centrifugal Downblast Belt Drive Exhaust Fan (FLOAIRE) NONSTOCK**NONRETURNABLE**NO CANCEL*	719.330/ea	719.33	
1ea	L40-704 TH5220D1003 2H/2C STD NON-PROG TSTAT	54.015/ea	54.02	
1ea	L44-539 YTH5320R1025 WIRELESS ZONE ADPT KIT NP NONSTOCK**NONRETURNABLE**NO CANCEL*	152.650/ea	152.65	
1ea	T-4054-1 D/A HEAT/COOL ROOM STAT (NEUCO) NONSTOCK**NONRETURNABLE**NO CANCEL*	137.410/ea	137.41	
1ea	T6051A1016 HONEYWELL THERMOSTAT NONSTOCK**NONRETURNABLE**NO CANCEL*	111.840/ea	111.84	
1ea	L39-491 A70HA-1C TEMPERATURE CONTROL NONSTOCK**NONRETURNABLE**NO CANCEL*	159.920/ea	159.92	
1ea	A70AA-18 TEMP CONTROL 35/80F 6"CAP, OPEN LO, 3/8"X3" NONSTOCK**NONRETURNABLE**NO CANCEL*	116.000/ea	116.00	
1ea	P70KA-1 JOHNSON PRESSURE CONTROL NONSTOCK**NONRETURNABLE**NO CANCEL*	145.930/ea	145.93	
1ea	B81-120 VCMA-20ULS/115V 115V, 20'CONDENSATE PUMP	49.350/ea	49.35	
** Continued on Next Page *		Subtotal		
		S&H Charges		
		Sales Tax		
		Amount Due		

Quotation

Johnstone South Charleston
101 1st Avenue
SOUTH CHARLESTON, WV 25303

EXPIRATION DATE	QUOTE NUMBER
09/19/2015	212-100742326
PAGE NO	
7 of 9	

QUOTE TO:

SHIP TO:

WV DEPT OF ADMINISTRATION
 GENERAL SERVICES DIVISON
 BLDG 1 RM MB 60
 CHARLESTON, WV 25305

WV DEPT OF ADMINISTRATION
 GENERAL SERVICES DIVISON
 BLDG 1 RM MB 60
 CHARLESTON, WV 25305
 304-957-7144

CUSTOMER NUMBER	CUSTOMER PO NUMBER	JOB NAME / RELEASE NUMBER	SALESPERSON	
2900	gsd1600000006	HVAC PARTS BID	Jon Dickson	
WRITER	SHIP VIA	TERMS	SHIP DATE	FREIGHT ALLOWED
Jon Dickson	WILL CALL	NET 30 DAYS	08/05/2015	No
ORDER QTY	DESCRIPTION	UNIT PRICE	EXT PRICE	
1ea	B81-119 VCMA-15ULS 554405 115V 15' CONDENSATE PUMP	39.950/ea	39.95	
1ea	L37-332 120611 150PSI,300F, FLOW SWITCH	110.450/ea	110.45	
1ea	910101195 460v 1ph 3/4hp 850rpm motor (MCQUAY) NONSTOCK**NONRETURNABLE**NO CANCEL*	184.570/ea	184.57	
1ea	668105601 MicroTech III Control Board (NEUCO/MCQUAY) NONSTOCK**NONRETURNABLE**NO CANCEL*	120.390/ea	120.39	
1ea	L45-035 C230A 2P/30A/24V, DP Cont	11.275/ea	11.28	
1ea	W80-002 R31810 18 IN CCW ROT 27DEG NONSTOCK**NONRETURNABLE**NO CANCEL*	47.933/ea	47.93	
1ea	RIBTW2401B-LN SPDT LON Works Power Relay (NEUCO) NONSTOCK**NONRETURNABLE**NO CANCEL*	113.650/ea	113.65	
1ea	TR75VA005 480/240/208/120-24V 75VA Xfrmr NONSTOCK**NONRETURNABLE**NO CANCEL*	27.760/ea	27.76	
1ea	L46-113 DS010KJ DS010 TRANE KIT#03033	27.283/ea	27.28	
1ea	SHE6354 V-Belt Idler Pulley; 3/8" Bore NONSTOCK**NONRETURNABLE**NO CANCEL*	23.360/ea	23.36	

** Continued on Next Page *

Subtotal	
S&H Charges	
Sales Tax	
Amount Due	

Quotation

Johnstone South Charleston
101 1st Avenue
SOUTH CHARLESTON, WV 25303

EXPIRATION DATE	QUOTE NUMBER
09/19/2015	212-100742326
PAGE NO	
8 of 9	

QUOTE TO:

SHIP TO:

WV DEPT OF ADMINISTRATION
 GENERAL SERVICES DIVISON
 BLDG 1 RM MB 60
 CHARLESTON, WV 25305

WV DEPT OF ADMINISTRATION
 GENERAL SERVICES DIVISON
 BLDG 1 RM MB 60
 CHARLESTON, WV 25305
 304-957-7144

CUSTOMER NUMBER	CUSTOMER PO NUMBER	JOB NAME / RELEASE NUMBER	SALESPERSON		
2900	gsd1600000006	HVAC PARTS BID	Jon Dickson		
WRITER		SHIP VIA	TERMS	SHIP DATE	FREIGHT ALLOWED
Jon Dickson		WILL CALL	NET 30 DAYS	08/05/2015	No
ORDER QTY	DESCRIPTION		UNIT PRICE	EXT PRICE	
1ea	BRG0648 2Bolt Flg Bearing 1-7/16 Bore (TRANE) NONSTOCK**NONRETURNABLE**NO CANCEL*		204.490/ea	204.49	
1ea	B12-274 EK-304S 1/2 ODF LIQUID DRIER		38.150/ea	38.15	
1ea	400436 3/8"ODF W/ACCESS PORT DRIER (NEUCO) NONSTOCK**NONRETURNABLE**NO CANCEL*		33.930/ea	33.93	
1ea	B17-225 BSB-163S 066131 BI FLOW		17.580/ea	17.58	
1ea	L45-049 C330A 3P/30A/24V,DP Cont		13.900/ea	13.90	
1ea	L45-038 C240A 2P/40A/24V,DP Cont		13.860/ea	13.86	
1ea	H85-445 15500 5 CFM VACUUM PUMP		179.990/ea	179.99	
1ea	B11-519 SPP6 HARDSTART RELAY		7.990/ea	7.99	
1ea	SEN1364 THERMOSTAT (TRANE) NONSTOCK**NONRETURNABLE**NO CANCEL*		137.930/ea	137.93	
1ea	BRD2893 TCI Control Board Kit (TRANE/NEUCO) NONSTOCK**NONRETURNABLE**NO CANCEL*		231.610/ea	231.61	
1ea	TRR0664 460/575-115/230V 350VA Xformer (TRANE/NEUCO) NONSTOCK**NONRETURNABLE**NO CANCEL*		327.590/ea	327.59	
1ea	DHY1470 5/8x1/2 16CuIn Filter Drier (TRANE/NEUCO) NONSTOCK**NONRETURNABLE**NO CANCEL*		44.720/ea	44.72	
** Continued on Next Page *			Subtotal		
			S&H Charges		
			Sales Tax		
			Amount Due		

Quotation

Johnstone South Charleston
101 1st Avenue
SOUTH CHARLESTON, WV 25303

EXPIRATION DATE	QUOTE NUMBER
09/19/2015	212-100742326
PAGE NO	
9 of 9	

QUOTE TO:

SHIP TO:

WV DEPT OF ADMINISTRATION
 GENERAL SERVICES DIVISON
 BLDG 1 RM MB 60
 CHARLESTON, WV 25305

WV DEPT OF ADMINISTRATION
 GENERAL SERVICES DIVISON
 BLDG 1 RM MB 60
 CHARLESTON, WV 25305
 304-957-7144

CUSTOMER NUMBER	CUSTOMER PO NUMBER	JOB NAME / RELEASE NUMBER	SALESPERSON	
2900	gsd1600000006	HVAC PARTS BID	Jon Dickson	
WRITER	SHIP VIA	TERMS	SHIP DATE	FREIGHT ALLOWED
Jon Dickson	WILL CALL	NET 30 DAYS	08/05/2015	No
ORDER QTY	DESCRIPTION	UNIT PRICE	EXT PRICE	
1ea	SEN2076 TEMPERATURE SENSOR W/DISPLAY NONSTOCK**NONRETURNABLE**NO CANCEL*	173.440/ea	173.44	
1ea	MOD1393 TRANE CONTROLL BOARD NONSTOCK**NONRETURNABLE**NO CANCEL*	104.960/ea	104.96	
1ea	SEN1447 10K OHM WIRED ZONE SENSOR W/DIAL NONSTOCK**NONRETURNABLE**NO CANCEL*	136.640/ea	136.64	
1ea	D1089 FASCO BLOWER MOTOR 1/16 HP 115V 850 RPM (TRANE) NONSTOCK**NONRETURNABLE**NO CANCEL*	170.400/ea	170.40	
1ea	MOT13651 1/10HP 115V 810/675/500RPM Mtr (TRANE/NEUCO) NONSTOCK**NONRETURNABLE**NO CANCEL*	441.670/ea	441.67	
1ea	G21-933 POC7.5 TOC7.5 7.5M370V RUN CAPACITOR	2.938/ea	2.94	
1ea	G22-336 PF42440 40 VA TRANSFORMER	13.155/ea	13.16	
1ea	6212ZZ 2 Shield Bearing (NEUCO) NONSTOCK**NONRETURNABLE**NO CANCEL*	53.510/ea	53.51	

PRICES SUBJECT TO CHANGE WITHOUT NOTICE

Subtotal	26280.41
S&H Charges	0.00
Sales Tax	0.00
Amount Due	26280.41

*Cross Reference
Items*

Johnstone Supply Products

List all Johnstone Products



[Enlarge Image](#)

Brand Name:	Titan
Product:	G36-330
<u>Product Image</u>	
Mfg. #:	TRCFD505
User Desc:	CAPACITOR 50/5MFD 440V RD
Display Name:	Dual Rated Motor Run Capacitors Round

Vendor

Marketing

Price

Misc

Specs

Product

Product:	G36-330
Product Group:	Dual Rated Motor Run Capacitors
Body Copy:	60,000 hour reliability Dual 440/370 volt design Meets EIA-456A, IEC 60252-1:2001, and UL 810 industry standards Heat Tolerant Metalized polypropylene film Proprietary Epoxidized Soybean Oil (ESO) 50/60 Hz, UL and CUL -40° C to 70° C operating temperature Round Aluminum case 50+5 MFD
Discontinued Ind:	No
Hazardous:	N
Cube:	36.06
Country of Origin:	CN - CHINA
Department:	P - Motors & Components

SEARCH

Johnstone Supply Products

[List all Johnstone Products](#)



[Enlarge Image](#)

Brand Name:	Emerson Flow Controls
Product:	B17-225
<u>Product Image</u>	
Mfg. #:	BSB-163S
User Desc:	DRIER BIFLOW 3/8ODF 16CU
Display Name:	BSB Bi-Flow Filter-Drier

Vendor

Marketing

Price

Misc

Specs

Product

Product:	B17-225
Product Group:	BSB Bi-Flow Filter-Drier
Body Copy:	Economical liquid line drier for air conditioning applications Filtration to 40 microns Solid copper connections Capacity ratings listed are nominal system tonnage
Discontinued Ind:	No
Hazardous:	N
Cube:	66.64
Country of Origin:	MX - MEXICO
Department:	R - Refrigeration
Details:	Conn. Size: 3/8" ODF; Cubic Inches: 16; Length: 6.08"; R22/R410A Capacity: 5.0;
Johnstone Stock#:	B17225

Part Number: ZR61K3E-TFD-930



Manufacturer

Copeland Compressor

Description

460v3ph 61000btuR22 Compressor

Accessories (Not Included)

Replacement Parts

918-0043-00

240V 70W Crank Case Heater

527-0116-00

Vibration Absorber Grommet

918-0043-01

480V 70W Crankcase Heater

918-0043-02

575V 70W Crankcase Heater

Part Number: 174036-113



Manufacturer
Description

Armstrong Fluid Technology
S45BF 1/4HP CI BDY/NFI PUMP

Accessories (Not Included)

105188-011
3" 4-BOLT FLANGE, 1 PC, IRON

105189-011
2 1/2" 4-BOLT FLANGE, 1 PC, C.I.

805201-000
FLANGE GASKET SET

Replacement Parts

106050-000
4.75" BODY GASKET

116975-000
SEALS

806168-001
CAST IRON COUPLER

Johnstone Supply Products

List all Johnstone Products



 [Enlarge Image](#)

Brand Name:	US Motors
Product:	S91-524
<u>Product Image</u>	
Mfg. #:	D15P2D
User Desc:	MOTOR 15HP 208-230/460V
Display Name:	Three-Phase Open Drip-proof Motor NEMA Premium Efficiency Motor

Vendor

Marketing

Price

Misc

Specs

Product

Product:	S91-524
Product Group:	Three-Phase Open Drip-proof Motor
Body Copy:	1.15 Service Factor, open drip-proof construction, rigid base, 50-60 Hz Class F insulation, Class B rise at Service Factor (140 frame and larger) Rolled steel frame 56-320, cast iron frame 280-440 40°C ambient, NEMA design B Performance Regreasable bearings on 440T and larger Suitable for Wye-Delta Start 250T and larger All motors are tested and designed to be 100% variable frequency drives (VFDs) compatible
Applications:	Designed for pumps, fans, compressors and other general purpose applications where contaminants are minimal
Features:	1.15 Service Factor, open drip-proof construction, rigid base, 50-60 Hz Class F insulation, Class B rise at Service Factor (140 frame and larger) Rolled steel frame 56-320, cast iron frame 280-440 40°C ambient, NEMA design B Performance Regreasable bearings on 440T and larger Suitable for Wye-Delta Start 250T and larger All motors are tested and designed to be 100% variable frequency drives (VFDs) compatible No thermal protection

Johnstone Supply Products

List all Johnstone Products



[Enlarge Image](#)

Brand Name:	US Motors
Product:	S91-523
<u>Product Image</u>	
Mfg. #:	D10P2D
User Desc:	MOTOR 10HP 208-230/460V
Display Name:	Three-Phase Open Dripproof Motor NEMA Premium Efficiency Motor

Vendor

Marketing

Price

Misc

Specs

Product

Product: S91-523

Product Group: Three-Phase Open Dripproof Motor

Body Copy: 1.15 Service Factor, open dripproof construction, rigid base, 50-60 Hz|Class F insulation, Class B rise at Service Factor (140 frame and larger)|Rolled steel frame 56-320, cast iron frame 280-440|40°C ambient, NEMA design B Performance|Regreasable bearings on 440T and larger|Suitable for Wye-Delta Start 250T and larger|All motors are tested and designed to be 100% variable frequency drives (VFDs) compatible

Applications: Designed for pumps, fans, compressors and other general purpose applications where contaminants are minimal

Features: 1.15 Service Factor, open dripproof construction, rigid base, 50-60 Hz|Class F insulation, Class B rise at Service Factor (140 frame and larger)|Rolled steel frame 56-320, cast iron frame 280-440|40°C ambient, NEMA design B Performance|Regreasable bearings on 440T and larger|Suitable for Wye-Delta Start 250T and larger|All motors are tested and designed to be 100% variable frequency drives (VFDs) compatible |No thermal protection

Part Number: TRR0826

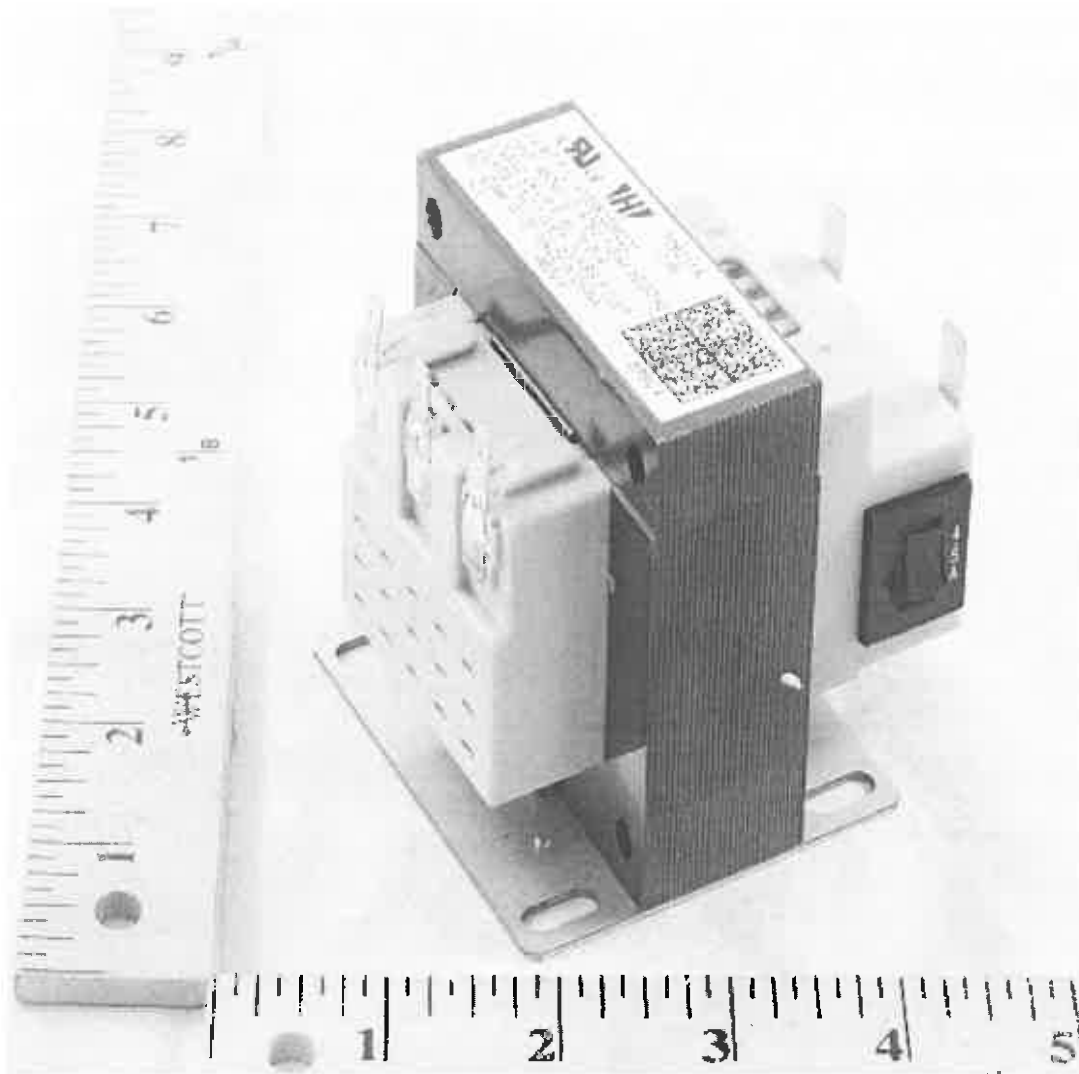

Manufacturer

Trane

Description

460-575V-PRI 24V-SEC 75VA TRAN

Accessories (Not Included)

Replacement Parts

[PRINT](#)

Johnstone Supply Products

List all Johnstone Products



 [Enlarge Image](#)

Brand Name:	Honeywell
Product:	L41-695
<u>Product Image</u>	
Mfg. #:	VR8345Q4563
User Desc:	VALVE GAS
Display Name:	Universal Electronic Ignition Combination Gas Control

Vendor

Marketing

Price

Misc

Specs

Product

Product:	L41-695
Product Group:	Universal Electronic Ignition Combination Gas Control
Body Copy:	Wide-capacity control for almost any IP, HSI or DSI gas-fired appliances
Discontinued Ind:	No
Hazardous:	N
Cube:	127.05
Country of Origin:	MX - MEXICO
Department:	L - Controls & Hydronics
Details:	BtuH Capacity: 300,000; Inlet Conn.: 3/4"; Opening Style: 2-Stage; Outlet Conn.: 3/4"; Volts: 24;

Johnstone Supply Products

List all Johnstone Products



[Enlarge Image](#)

Brand Name:	Packard
Product:	G21-933
<u>Product Image</u>	
User Desc:	CAPACITOR 7.5MFD 370V OV
Display Name:	Motor Run Capacitor Oval

Vendor

Marketing

Price

Misc

Specs

Product

Product:	G21-933
Product Group:	Motor Run Capacitor
Body Copy:	Non-PCB dielectric fluid Pressure-activated circuit interrupter virtually eliminates case rupture at end of life For continuous heavy-duty application such as air conditioning, refrigeration, business machines, fans, light ballasts, etc. Seamless steel cases 1/4", four-blade quick disconnect terminal with phenolic insulated caps Dimensions may vary due to manufacturing changes; dimensions shown are for reference only
Discontinued Ind:	No
Hazardous:	N
Cube:	8.29
Country of Origin:	CN - CHINA
Department:	P - Motors & Components

Part Number: A19BUC-2

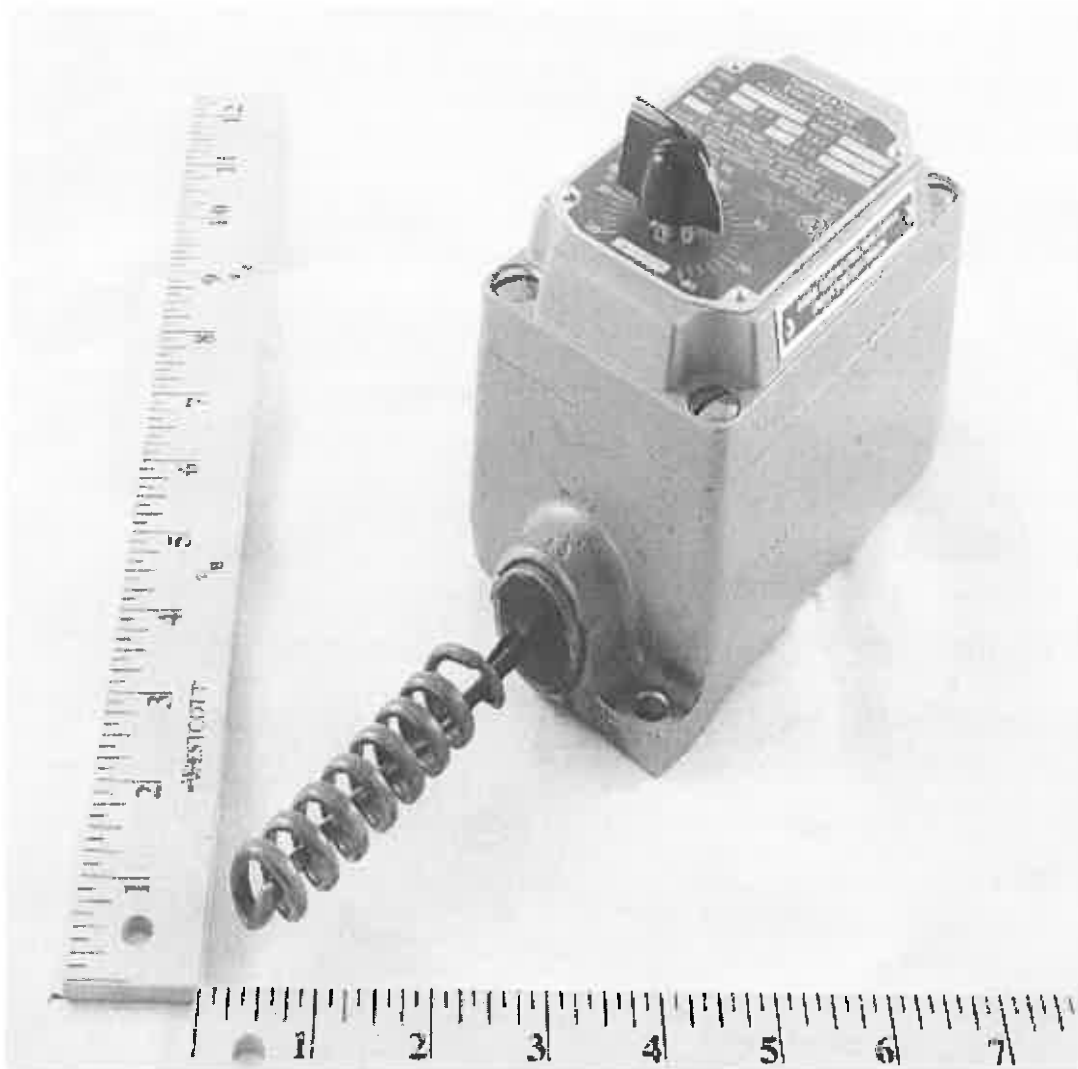

Manufacturer

Johnson Controls

Description

20/80F X-PRF SPDT, COILED-BULB

Accessories (Not Included)

Replacement Parts

[PRINT](#)

SEARCH

Johnstone Supply Products

List all Johnstone Products



[Enlarge Image](#)

Brand Name:	US Motors
Product:	S87-818
<u>Product Image</u>	
Mfg. #:	5840
User Desc:	MOTOR OEM 1/2HP 115V 4S
Display Name:	Lennox Furnace Blower Motor

Vendor	Marketing	Price	Misc	Specs
AddOn				

Product

Product: S87-818

Product Group: Lennox Furnace Blower Motor

Body Copy: Direct replacement PSC motors for Lennox furnace blower motors [Thermally protected | Fits various other Lennox furnace blower applications

Discontinued Ind: No

Hazardous: N

Cube: 766.76

Country of Origin: MX - MEXICO

Department: P - Motors & Components

Note: S88-259 is not UL recognized

Details: A: 5-1/8"; Agency Certification: UR/CSA; Ambient Operating Temp. (Celsius): 40; Bearing Type: SAB; Capacitor to Match: G21-933; Diameter: 5-5/8"; Efficiency: 65.0%; Enclosure: OAO; F/L

Johnstone Supply Products

List all Johnstone Products



 [Enlarge Image](#)

Brand Name:	US Motors
Product:	S91-520
<u>Product Image</u>	
Mfg. #:	D3P2D
User Desc:	MOTOR 3HP 208-230/460V
Display Name:	Three-Phase Open Dripproof Motor NEMA Premium Efficiency Motor

Vendor

Marketing

Price

Misc

Specs

Product

Product:	S91-520
Product Group:	Three-Phase Open Dripproof Motor
Body Copy:	1.15 Service Factor Open dripproof 50-60 Hz Class F insulation, Class B rise at Service Factor Rigid base, rolled steel frame 40°C ambient, NEMA design B Performance 100% variable frequency drives (VFDs) compatible
Applications:	Designed for pumps, fans, compressors and other general purpose applications where contaminants are minimal
Features:	1.15 Service Factor, open dripproof construction, rigid base, 50-60 Hz Class F insulation, Class B rise at Service Factor (140 frame and larger) Rolled steel frame 56-320, cast iron frame 280-440 40°C ambient, NEMA design B Performance Regreasable bearings on 440T and larger Suitable for Wye-Delta Start 250T and larger All motors are tested and designed to be 100% variable frequency drives (VFDs) compatible No thermal protection
Discontinued Ind:	No

Johnstone Supply Products

List all Johnstone Products



 [Enlarge Image](#)

Brand Name:	US Motors
Product:	S87-628
<u>Product Image</u>	
Mfg. #:	8100
User Desc:	MOTOR BD 1/3HP 115V
Display Name:	Belt Drive Fan Motor

Vendor

Marketing

Price

Misc

Specs

Product

Product:	S87-628
Product Group:	Belt Drive Fan Motor
Body Copy:	Combination mounting holes for NEMA 48 and 56 frame dimensions, complete with resilient base Not recommended where automatic reset creates a hazard
Applications:	Sleeve bearing motor replacements for furnace blowers, belt driven fans, air coolers and similar applications with moderate torque requirements
Features:	Automatic thermal protection Continuous duty All-angle mounting 40°C rise Reversible rotation Resilient base included Not recommended where automatic reset creates a hazard
Discontinued Ind:	No
Hazardous:	N
Cube:	1173.25
Country of Origin:	MX - MEXICO



SEARCH

Johnstone Supply Products

List all Johnstone Products



[Enlarge Image](#)

Brand Name:	Titan
Product:	G36-304
<u>Product Image</u>	
Mfg. #:	TRCF25
User Desc:	CAPACITOR 25MFD 440V RD
Display Name:	Dual Rated Motor Run Capacitors Round

Vendor

Marketing

Price

Misc

Specs

Product

Product:	G36-304
Product Group:	Dual Rated Motor Run Capacitors
Body Copy:	60,000 hour reliability Dual 440/370 volt design Meets EIA-456A, IEC 60252-1:2001, and UL 810 industry standards Heat Tolerant Metalized polypropylene film Proprietary Epoxidized Soybean Oil (ESO) 50/60 Hz, UL and CUL -40° C to 70° C operating temperature Round Aluminum case 25 MFD
Discontinued Ind:	No
Hazardous:	N
Cube:	14.44
Country of Origin:	CN - CHINA
Department:	P - Motors & Components



SEARCH

Johnstone Supply Products

List all Johnstone Products

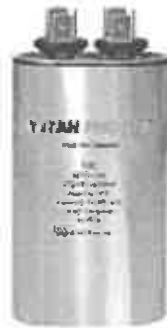

[Enlarge Image](#)

Brand Name:	Packard
Product:	G22-730
<u>Product Image</u>	
User Desc:	CAPACITOR 12.5MFD 370V OV
Display Name:	Motor Run Capacitor Oval

Vendor

Marketing

Price

Misc

Specs

Product

Product:	G22-730
Product Group:	Motor Run Capacitor
Body Copy:	Non-PCB dielectric fluid Pressure-activated circuit interrupter virtually eliminates case rupture at end of life For continuous heavy-duty application such as air conditioning, refrigeration, business machines, fans, light ballasts, etc. Seamless steel cases 1/4", four-blade quick disconnect terminal with phenolic insulated caps Dimensions may vary due to manufacturing changes; dimensions shown are for reference only
Discontinued Ind:	No
Hazardous:	N
Cube:	11.55
Country of Origin:	CN - CHINA
Department:	P - Motors & Components

Johnstone Supply Products

List all Johnstone Products



[Enlarge Image](#)

Brand Name:	Titan
Product:	G36-322
<u>Product Image</u>	
Mfg. #:	TRCFD355
User Desc:	CAPACITOR 35/5MFD 440V RD
Display Name:	Dual Rated Motor Run Capacitors Round

Vendor

Marketing

Price

Misc

Specs

Product

Product:	G36-322
Product Group:	Dual Rated Motor Run Capacitors
Body Copy:	60,000 hour reliability Dual 440/370 volt design Meets EIA-456A, IEC 60252-1:2001, and UL 810 industry standards Heat Tolerant Metalized polypropylene film Proprietary Epoxidized Soybean Oil (ESO) 50/60 Hz, UL and CUL -40° C to 70° C operating temperature Round Aluminum case 35+5 MFD
Discontinued Ind:	No
Hazardous:	N
Cube:	22.18
Country of Origin:	CN - CHINA
Department:	P - Motors & Components

Johnstone Supply Products

List all Johnstone Products



 [Enlarge Image](#)

Brand Name:	Titan
Product:	G36-306
Product Image	
Mfg. #:	TRCF35
User Desc:	CAPACITOR 35MFD 440V RD
Display Name:	Dual Rated Motor Run Capacitors Round

Vendor

Marketing

Price

Misc

Specs

Product

Product:	G36-306
Product Group:	Dual Rated Motor Run Capacitors
Body Copy:	60,000 hour reliability Dual 440/370 volt design Meets EIA-456A, IEC 60252-1:2001, and UL 810 industry standards Heat Tolerant Metalized polypropylene film Proprietary Epoxidized Soybean Oil (ESO) 50/60 Hz, UL and CUL -40° C to 70° C operating temperature Round Aluminum case 35 MFD
Discontinued Ind:	No
Hazardous:	N
Cube:	20.81
Country of Origin:	CN - CHINA
Department:	P - Motors & Components



SEARCH

Johnstone Supply Products

List all Johnstone Products



[Enlarge Image](#)

Brand Name:	TPI
Product:	X90-473
<u>Product Image</u>	
Mfg. #:	P3P5105CA1N
User Desc:	480V UNIT HEATER
Display Name:	Raywall 5100 Series Heavy-Duty Unit Heater Electric, Forced Air

Vendor

Marketing

Price

Misc

Specs

Product

Product:	X90-473
Product Group:	Raywall 5100 Series Heavy-Duty Unit Heater
Body Copy:	For commercial and industrial use Can be mounted for vertical or horizontal operation Adjustable louvers Heavy gauge welded steel cabinet with powder coat finish Hinged and latched access door simplifies wiring, installation and maintenance
Discontinued Ind:	No
Hazardous:	N
Cube:	4608.33
Country of Origin:	US - UNITED STATES
Department:	A - Commercial & Specialty Equipment
Details:	Amps: 6.1; BtuH: 17,100; kW: 5.0; Phase: 3; Volts: 480; Wt. Lbs.:

Johnstone Supply Products

List all Johnstone Products



 [Enlarge Image](#)

Brand Name:	US Motors
Product:	S81-268
<u>Product Image</u>	
Mfg. #:	5482H
User Desc:	MOTOR COND 3/4-1/4HP 208V
Display Name:	RESCUE® Series Condenser Fan Motor

Vendor

Marketing

Price

Misc

Specs

Product

Product:	S81-268
Product Group:	RESCUE® Series Condenser Fan Motor
Body Copy:	Built to withstand extreme temperature conditions Class F insulation — thermal endurance to over 300°F Ball bearings 48" leads Special corrosion protection Reversible rotation
Applications:	Residential and commercial condensing unit fan motors in extreme temperature locations
Features:	Automatic thermal protection Ball bearings 48" leads Special corrosion protection Reversible rotation
Discontinued Ind:	No
Hazardous:	N
Cube:	759.5
Country of Origin:	MX - MEXICO
Department:	P - Motors & Components

Johnstone Supply Products

List all Johnstone Products



[Enlarge Image](#)

Brand Name:	US Motors
Product:	S89-637
<u>Product Image</u>	
Mfg. #:	3742
User Desc:	MOTOR COND 3/4HP 460V
Display Name:	Condenser Fan Motor

Vendor	Marketing	Price	Misc	Specs
AddOn				

Product

Product:	S89-637
Product Group:	Condenser Fan Motor
Body Copy:	48 frame, 1 speed, 1075 RPM, sleeve bearings, all-angle mounting
Applications:	Designed for all-angle mounting
Features:	Electrically reversible 48 frame motors feature flat end bell opposite shaft end with 1" long #8-32 extended studs to mount to bulk heads in shaft down applications Single-speed 24" power leads, 4" capacitor leads Class B insulation Water slinger included, capacitors not included; order separately
Discontinued Ind:	No
Hazardous:	N
Cube:	791.28
Country of Origin:	MX - MEXICO
Department:	P - Motors & Components



SEARCH

Johnstone Supply Products

List all Johnstone Products



Brand Name:	Surface Igniter
Product:	L46-114
Product Image	
Mfg. #:	DS007KJ
User Desc:	IGNITOR HOT SURFACE
Display Name:	Hot Surface Ignitor

Vendor

Marketing

Price

Misc

Specs

Product

Product:	L46-114
Product Group:	Hot Surface Ignitor
Body Copy:	11" lead length 120 VAC Designed to reach ignition temperature within 17 seconds 18-gauge nickel chrome lead wires Includes mounting adapter
Discontinued Ind:	No
Hazardous:	N
Cube:	61.5
Country of Origin:	CN - CHINA
Department:	L - Controls & Hydronics
Details:	Lead Length: 11";
Johnstone Stock#:	L46114

Johnstone Supply Products

List all Johnstone Products



 [Enlarge Image](#)

Brand Name:	Emerson Flow Controls
Product:	B12-266
<u>Product Image</u>	
Mfg. #:	EK-163S
User Desc:	DRIER LIQUID 3/8ODF 16CU
Display Name:	EK Series Liquid Line Filter-Drier

Vendor

Marketing

Price

Misc

Specs

Product

Product:	B12-266
Product Group:	EK Series Liquid Line Filter-Drier
Body Copy:	3/8" ODF connections R22/R410A Capacity: 5.0 Tons
Discontinued Ind:	No
Hazardous:	N
Cube:	67.7
Country of Origin:	MX - MEXICO
Department:	R - Refrigeration
Details:	Conn. Size: 3/8" ODF; Cubic Inches: 16; Length: 6.25"; R12/R134a Capacity: 4.0; R22/R410A Capacity: 5.0; R404A/R507 Capacity: 3.0;
Johnstone Stock#:	B12266



SEARCH

Johnstone Supply Products

List all Johnstone Products



[Enlarge Image](#)

Brand Name:	Fasco
Product:	X82-149
<u>Product Image</u>	
Mfg. #:	A273
User Desc:	BLOWER MOTOR 1/8HP
Display Name:	Trane Draft Inducer Blowers Direct Replacement for Trane

Vendor

Marketing

Price

Misc

Specs

Product

Product:	X82-149
Product Group:	Trane Draft Inducer Blowers
Body Copy:	Replaces 7062-3972
Discontinued Ind:	No
Hazardous:	N
Cube:	2985.84
Country of Origin:	US - UNITED STATES
Department:	P - Motors & Components
Note:	X89-695 is not UL approved.
Details:	Bearing Type: Ball; F/L Amps: 0.62; HP: 1/8; Replaces: 7062-3972; Rot.: CW; RPM: 3500; Safety Switch: No; Volts: 208-230; Wt.

Part Number: 14B0025N02



Manufacturer

ClimateMaster

Description

460v 1ph 3/4&1/2HP 3SPD MOTOR

Accessories (Not Included)

Replacement Parts

[PRINT](#)

Part Number: MOT2913



Manufacturer
Description

Trane
1HP 208-230/460V 1725RPM Motor

Accessories (Not Included)

Replacement Parts

PRINT

Johnstone Supply Products

List all Johnstone Products



[Enlarge Image](#)

Brand Name:	US Motors
Product:	S81-127
<u>Product Image</u>	
Mfg. #:	D3E2DHZ
User Desc:	MOTOR 3HP 208-230/460V
Display Name:	Three-Phase General Purpose Motor Rigid-Base, Open Dripproof

Vendor

Marketing

Price

Misc

Specs

Product

Product:	S81-127
Product Group:	Three-Phase General Purpose Motor
Body Copy:	Ball bearing, continuous duty 40°C ambient Reversible rotation Energy efficient motor
Applications:	Fans, blowers, ventilators and pumps requiring three-phase power
Features:	Rigid base Ball bearing, continuous duty 40°C ambient Reversible rotation No thermal protection
Discontinued Ind:	No
Hazardous:	N
Cube:	1717.03
Country of Origin:	MX - MEXICO
Department:	P - Motors & Components
Details:	Agency Certification: UR/CSA; Ambient Operating Temp.

Johnstone Supply Products

List all Johnstone Products

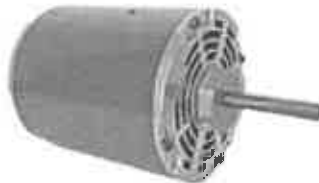

[Enlarge Image](#)

Brand Name:	Fasco
Product:	S81-341
Product Image	
Mfg. #:	D2851
User Desc:	MOTOR OEM 1HP 230/460V
Display Name:	Trane Commercial Condenser Fan Motor

Vendor

Marketing

Price

Misc

Specs

Product

Product:	S81-341
Product Group:	Trane Commercial Condenser Fan Motor
Body Copy:	Single-speed, 50/60 Hz Sealed ball bearings; open drip-proof Automatic thermal protection; Class B insul., 40°C ambient Has a keyed shaft Rain shields available in Motor Accessories section under Motor Mounting Parts
Applications:	S81-340 is a suitable replacement for the following Trane and GE models: X70670706010, X70671180017, MOT3771, MOT5717, 5KCP39SFL19KS, 5KCP39SFL153DS S81-341 is a suitable replacement for the following Trane and Fasco models: X70671653-01,X70671656-01, X70671654, X70671652-01, MOT9192, MOT9188, 7126-4088, 7126-4089, 7126-4090, 7126-4299
Features:	Single-speed, 50/60 Hz Sealed ball bearings; open drip-proof Automatic thermal protection; Class B insul., 40°C ambient S81-341 has a keyed shaft Rain shields available in Motor Accessories section under Motor Mounting Parts
Discontinued Ind:	No
Hazardous:	N

Johnstone Supply Products

List all Johnstone Products



[Enlarge Image](#)

Brand Name:	Century Motors
Product:	S89-856
<u>Product Image</u>	
Mfg. #:	390
User Desc:	1/4HP MOTOR
Display Name:	Single Shaft Open Fan/Blower Motor For Furnaces, Air Handlers, Fan Coils and Air Conditioning

Vendor

Marketing

Price

Misc

Specs

Product

Product:	S89-856
Product Group:	Single Shaft Open Fan/Blower Motor
Body Copy:	Auto protection Continuous air over Open construction PSC 1/2" diameter flatted shaft 42 frame Sleeve bearing Reversing plug Extended thru bolts, shaft end
Applications:	Direct drive furnace blowers, shaft mounted fans, unit heaters or any continuous duty application where the motor is located in the airstream
Features:	Automatic reset thermal protectors All motors have 30" leads S88-272 has extended mounting studs on the shaft extension end of the motor S89-772 capacitor is included
Discontinued Ind:	No
Hazardous:	N
Cube:	683.76



VSZ14

ENERGY-EFFICIENT

SPLIT SYSTEM HEAT PUMP

UP TO 15 SEER & 9.0 HSPF

1½ TO 5 TONS

COOLING CAPACITY: 18,000 TO 60,000 BTU/H

HEATING CAPACITY: 18,000 TO 60,000 BTU/H



Contents

Nomenclature.....	2
Product Specifications.....	3
Expanded Cooling Data.....	4
Expanded Heating Data.....	20
Performance Data.....	22
AHRi Ratings.....	24
Wiring Diagram.....	41
Dimensions.....	40
Accessories.....	40

Standard Features

- High-efficiency compressor
- Time-delay technology to ensure quiet reliable defrost
- Factory-installed bi-flow liquid line filter drier
- Factory-installed suction line accumulator
- Factory-installed compressor crankcase heater
- Factory-installed high-capacity muffler
- High- and low-pressure switches
- Service valves with sweat connections and easy access to gauge ports
- Copper tube/enhanced aluminum fin coil
- Fully charged for 15' of tubing length
- AHRI Certified; ETL Listed

Cabinet Features

- Grille-style sound control top design
- Attractive Bahama Beige powder-paint finish
- 500-hour salt-spray tested
- Wire fan discharge grille
- Steel louver coil guard
- Rust-resistant screws
- Top and side maintenance access
- Single-panel access to controls with space provided for field-installed accessories
- When properly anchored, meets the 2010 Florida Building Code unit integrity requirements for hurricane-type winds (Anchor bracket kits available.)



* Complete warranty details available from your local dealer or at www.goodmanmfg.com/gmc. To receive the 10-Year Parts Limited Warranty, online registration must be completed within 60 days of installation. Online registration is not required in California or Quebec.

	V	S	Z	14	036	1	A	A
	1	2	3	4,5	6,7,8	9	10	11
Brand V GMC Product Family							Engineering * Minor Revision	
Product Category S Split System							Engineering * Major Revision	
Unit Type C Condenser R-22 X Condenser R-410A H Heat Pump R-22 Z Heat Pump R-410A							<p>* Neither used for order entry or inventory management.</p> <p>Electrical</p> <p>1 208/230 V, 1 Phase, 60 Hz 2 220/240 V, 1 Phase, 50 Hz 3 208/230 V, 3 Phase, 60 Hz 4 460 V, 3 Phase, 60 Hz</p>	
Efficiency 13 13 SEER 14 14 SEER							<p>Nominal Capacity</p> <p>018 1½ Tons 042 3½ Tons 024 2 Tons 048 4 Tons 030 2½ Tons 049 4 Tons 036 3 Tons 060 5 Tons</p>	

	VSZ14 0181A*	VSZ14 0241A*	VSZ14 0301A*	VSZ14 0361A*	VSZ14 0421A*	VSZ14 0481A*	VSZ14 0491A*	VSZ14 0601A*
NOMINAL CAPACITIES								
Cooling (BTU/h)	18,000	24,000	30,000	36,000	42,000	48,000	48,000	60,000
Heating (BTU/h)	18,000	24,000	30,000	36,000	42,000	48,000	48,000	60,000
SEER / EER	14/11.5	14/11.5	14/11.5	14/11.5	14/11.5	14/11.5	14/11.5	14/11.5
Decibels	72	72	74	74	75	75	76	76
COMPRESSOR								
RLA	9.0	10.9	13.5	15.4	16.7	18.5	19.9	26.4
LRA	47.5	62.9	72.5	83.9	109.0	124.0	109.0	134.0
Type	Scroll	Scroll	Scroll	Scroll	Scroll	Scroll	Scroll	Scroll
CONDENSER FAN MOTOR								
Horsepower	1/6	1/6	1/6	1/6	1/6	1/4	1/4	1/4
FLA	1.1	1.1	1.1	1.1	1.1	1.5	1.5	1.5
REFRIGERATION SYSTEM								
Refrigerant Line Size ¹								
Liquid Line Size ("O.D.)	3/8"	3/8"	3/8"	3/8"	3/8"	3/8"	3/8"	3/8"
Suction Line Size ("O.D.)	3/4"	3/4"	3/4"	7/8"	1 1/8"	1 1/8"	1 1/8"	1 1/8"
Refrigerant Connection Size								
Liquid Valve Size ("O.D.)	3/8"	3/8"	3/8"	3/8"	3/8"	3/8"	3/8"	3/8"
Suction Valve Size ("O.D.)	3/4"	3/4"	3/4"	3/4"	7/8"	3/4"	7/8"	7/8"
Valve Connection Type	Sweat	Sweat	Sweat	Sweat	Sweat	Sweat	Sweat	Sweat
Refrigerant Charge	125	125	125	134	158	168	215	214
ELECTRICAL DATA								
Volts/Phase (60 Hz)	208-230/1	208-230/1	208-230/1	208-230/1	208-230/1	208-230/1	208-230/1	208-230/1
Minimum Circuit Ampacity ²	12.4	14.7	17.9	20.4	22.0	24.6	26.4	34.5
Max. Overcurrent Protection ³	20	25	30	35	35	40	45	60
Min / Max Volts	197 / 253	197 / 253	197 / 253	197 / 253	197 / 253	197 / 253	197 / 253	197 / 253
Electrical Conduit Size	1/2" or 3/4"	1/2" or 3/4"	1/2" or 3/4"	1/2" or 3/4"	1/2" or 3/4"	1/2" or 3/4"	1/2" or 3/4"	1/2" or 3/4"
EQUIPMENT WEIGHT (LBS)	143	143	171	173	191	226	273	277
SHIP WEIGHT (LBS)	154	154	182	184	207	237	288	292

¹ Tested and rated in accordance with ARI Standard 210/240

² Wire size should be determined in accordance with National Electrical Codes; extensive wire runs will require larger wire sizes

³ Must use time-delay fuses or HACR-type circuit breakers of the same size as noted.

NOTES

- Always check the S&R plate for electrical data on the unit being installed.
- Installer will need to supply 3/8" to 1 1/8" adapters for suction line connections.
- Unit is charged with refrigerant for 15' of 3/8" liquid line. System charge must be adjusted per Installation Instructions Final Charge Procedure.
- Installation of these units requires the specified TXV Kit to be installed on the indoor coil.
THE SPECIFIED TXV IS DETERMINED BY THE OUTDOOR UNIT NOT THE INDOOR COIL.

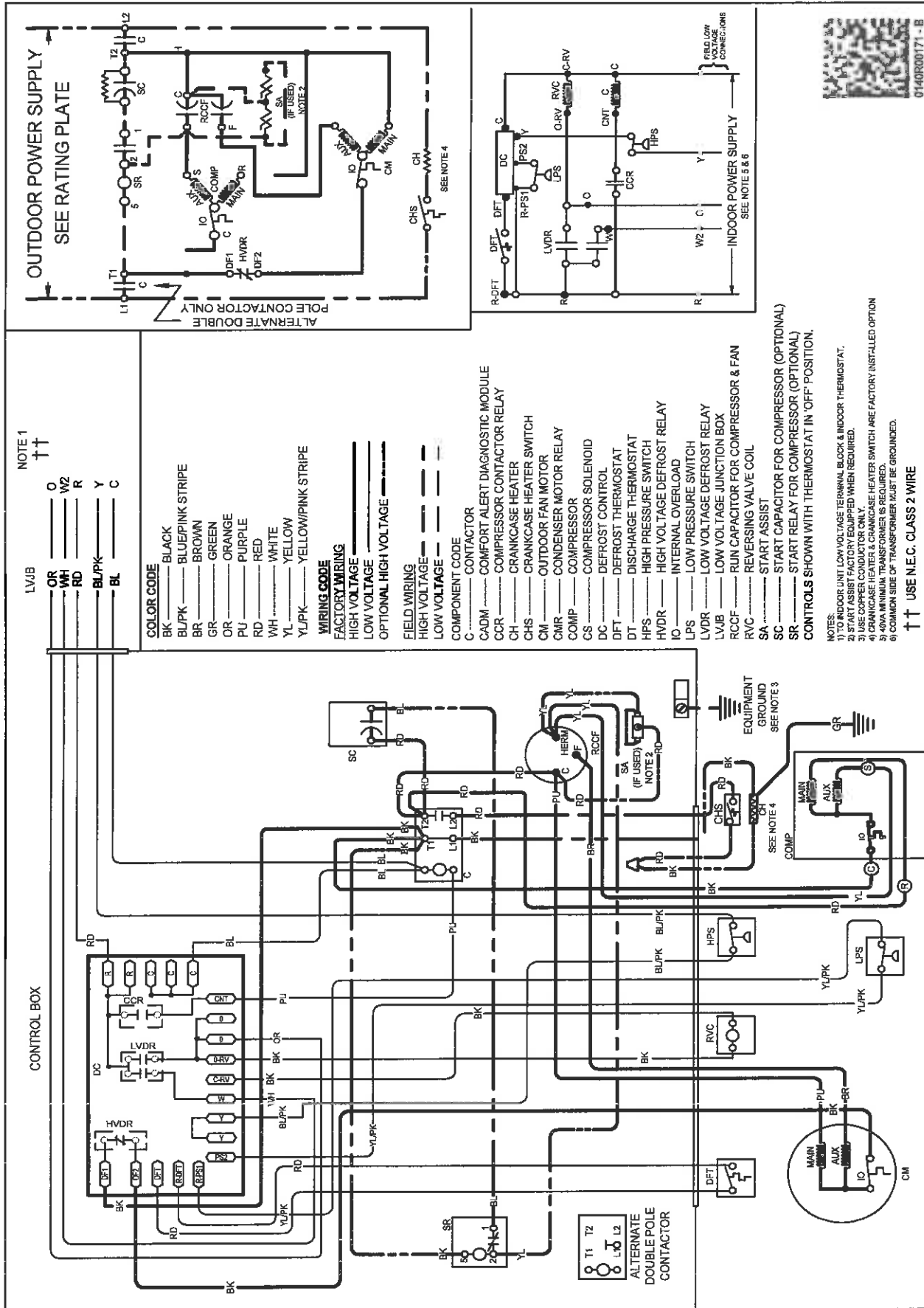

0140R00171-B

WARNING

High Voltage: Disconnect all power before servicing or installing this unit. Multiple power sources may be present. Failure to do so may cause property damage, personal injury, or death.

Wiring is subject to change. Always refer to the wiring diagram or the unit for the most up-to-date wiring.

DIMENSIONS

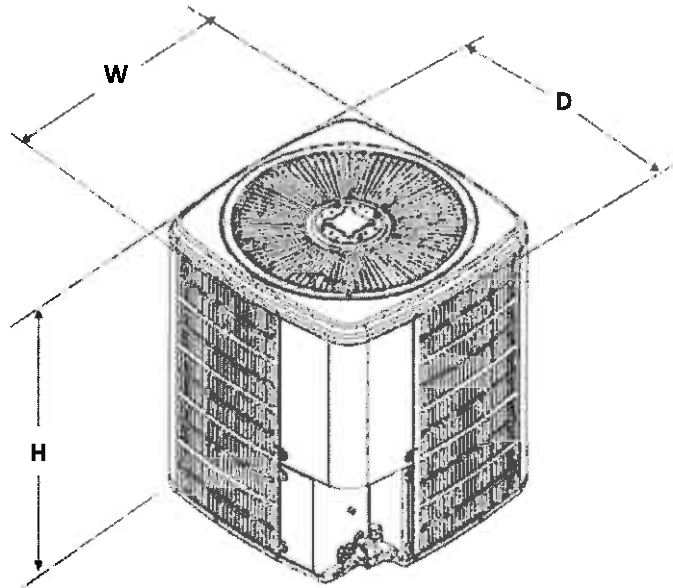

MODEL	DIMENSIONS		
	W"	D"	H"
VSZ140181A*	29	29	34½
VSZ140241A*	29	29	34½
VSZ140301A*	29	29	36½
VSZ140361A*	29	29	36½
VSZ140421A*	35½	35½	39½
VSZ140481A*	29	29	36½
VSZ140491A*	35½	35½	34½
VSZ140601A*	35½	35½	34½

ACCESSORIES

MODEL #	DESCRIPTION	VSZ14 018	VSZ14 024	VSZ14 030	VSZ14 036	VSZ14 042	VSZ14 048/049	VSZ14 060
0130R000005	Low-pressure Switch Kit	X	X	X	X	X	X	X
ABK-20	Anchor Bracket Kit ⁹	X	X	X	X	X	X	X
ASC-01	Anti-Short Cycle Kit	X	X	X	X	X	X	X
AFE18-60A	All-fuel Kit	X	X	X	X	X	X	X
CSR-U-1	Hard-start Kit	X	X	X	X	X	X	X
FSK01A ¹	Freeze Protection Kit	X	X	X	X	X	X	X
OT18-60A ²	Outdoor Thermostat	X	X	X	X	X	X	X
OT/EHR18-60	Emergency Heat Relay kit	X	X	X	X	X	X	X
TX2N4A ³	TXV Kit	X	X					
TX3N4 ³	TXV Kit			X	X			
TX5N4 ³	TXV Kit					X	X	X

⁹ Contains 20 brackets; four brackets needed to anchor unit to pad

¹ Installed on indoor coil

² Required for heat pump applications where ambient temperatures fall below 0°F with 50% or higher relative humidity.

³ Condensing units and heat pumps with reciprocating compressors require the use of start-assist components when used in conjunction with an indoor coil using a non-bleed thermal expansion valve refrigerant metering device or liquid line solenoid kit. The TXV should always be sized based on the tonnage of the outdoor unit.



Air Conditioning & Heating

ARUF SERIES

MULTI-POSITION MULTI-SPEED PSC MOTOR AIR HANDLER

1½ TO 5 TONS



Product Features

- Check flowrator for cooling and heat pump applications
- Direct drive, multi-speed PSC blower motor
- All-aluminum evaporator coil
- Coil mounting track for quick repositioning
- Optimized for use with R-410A refrigerant
- Cabinet air leakage less than 2.0% at 1.0 inch H₂O when tested in accordance with ASHRAE standard 193
- Cabinet air leakage less than 1.4% at 0.5 inch H₂O when tested in accordance with ASHRAE standard 193
- 3 kW – 25 kW electric heater kits
- Horizontal or vertical configuration capabilities
- Rigid SmartFrame™ cabinet
- 21" depth for easier attic access
- DecaBDE-free thermoplastic drain pan with secondary drain connections
- Screw-less sides and back helps to reduce condensation when installed in humid locations
- Foil-faced insulation covers the internal casing to reduce cabinet condensation
- Galvanized, leather grain-embossed finish
- Glue-less cabinet insulation retention
- Tool-less filter access
- AHRI certified; ETL listed

Contents

Nomenclature	2
Heater Kit Nomenclature	2
Product Specifications	3
Dimensions	4
Airflow Data	5
Heat Kit Data	6
Wiring Diagram	8
Accessories	10



* Complete warranty details available from your local dealer or at www.goodmanmfg.com. To receive the 10-Year Parts Limited Warranty, online registration must be completed within 60 days of installation. Online registration is not required in California or Québec.

NOMENCLATURE

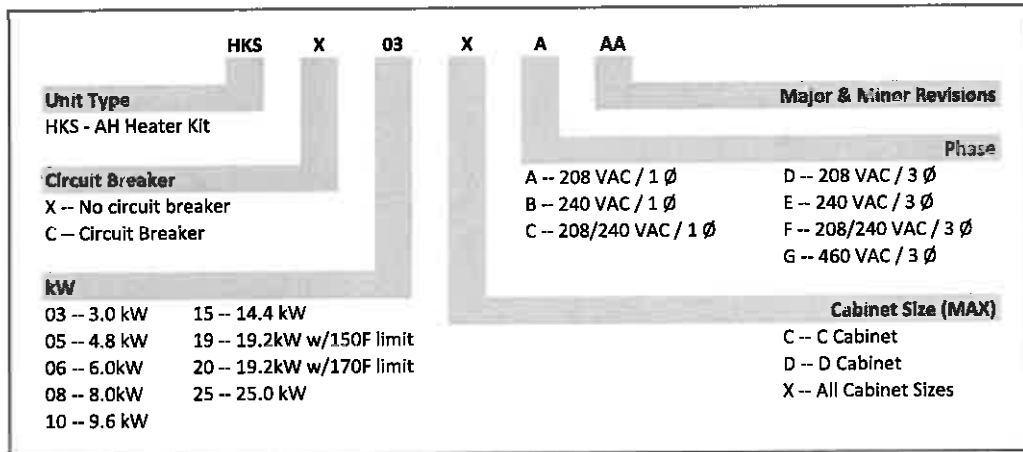
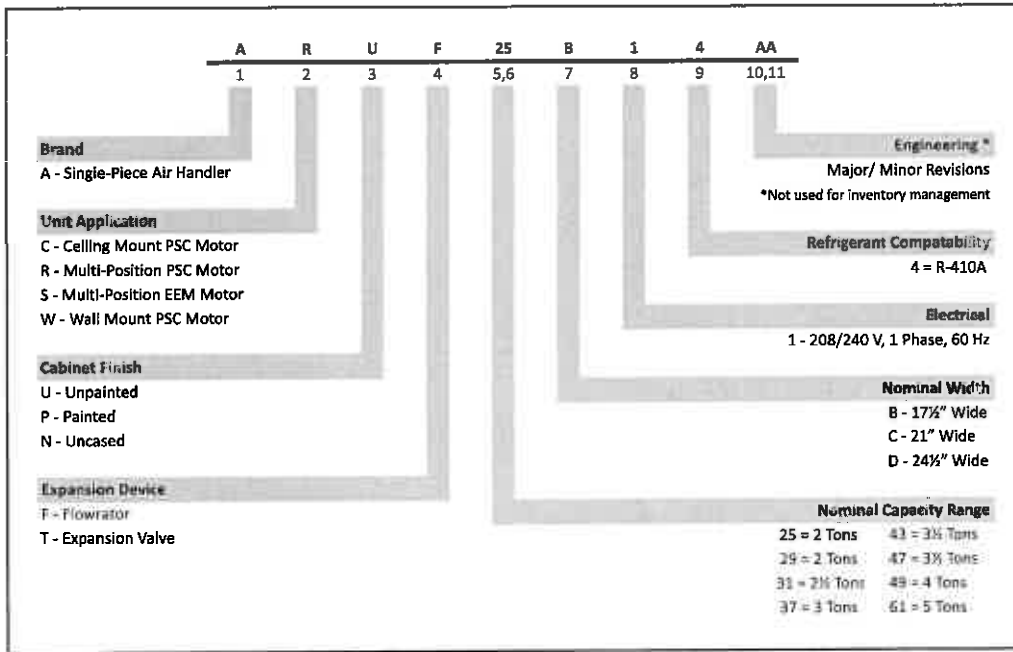

HEATING KW CORRECTION FACTOR

SUPPLY VOLTAGE	240	230	220	210	208
CORRECTION FACTOR	1.00	0.92	0.84	0.77	0.75

Multiply the 240-volt heating capacity by correction factors.

SPECIFICATIONS

	ARUF 25B14*	ARUF 29B14*	ARUF 31B14*	ARUF 37C14*	ARUF 43C14*	ARUF 49C14*	ARUF 37D14*	ARUF 43D14*	ARUF 47D14*	ARUF 49D14*	ARUF 61D14*
NOMINAL RATINGS											
Cooling (Btu/h)	24,000	25,000	30,000	36,000	42,000	48,000	36,000	42,000	43,000	48,000	60,000
Piston Size	0.051	0.057	0.065	0.072	0.076	0.080	0.072	0.076	0.076	0.080	0.080
BLOWER											
Diameter	9½"	9½"	9½"	10½"	10½"	10½"	10½"	10½"	10½"	10½"	11 ¹⁵ / ₁₆ "
Width	6"	6"	6"	8"	8"	10½"	10½"	10½"	10½"	10½"	10½"
COIL CONNECTIONS											
Liquid	⅜"	⅜"	⅜"	⅜"	⅜"	⅜"	⅜"	⅜"	⅜"	⅜"	⅜"
Suction	¾"	¾"	⅞"	⅞"	⅞"	⅞"	⅞"	⅞"	⅞"	⅞"	⅞"
Coil Drain Connect (FPT)	¾"	¾"	¾"	¾"	¾"	¾"	¾"	¾"	¾"	¾"	¾"
ELECTRICAL DATA											
Voltage	208/230	208/230	208/230	208/230	208/230	208/230	208/230	208/230	208/230	208/230	208/230
Min Circuit Ampacity	2.4/2.4	2.4/2.4	2.4/2.4	4/4	4/4	4/4	4/4	4/4	4/4	4/4	6/6
Max. Overcurrent Device (Amps)	15/15	15/15	15/15	15/15	15/15	15/15	15/15	15/15	15/15	15/15	15/15
Minimum VAC	197	197	197	197	197	197	197	197	197	197	197
Maximum VAC	253	253	253	253	253	253	253	253	253	253	253
Blower Motor											
Full Load Amps (FLA)	1.9	1.9	1.9	3.0	3.0	3.1	3.0	3.5	3.5	3.5	4.6
Horsepower (HP)	⅓	⅓	⅓	⅓	⅓	½	⅓	½	½	½	¾
SHIP WEIGHT (LBS.)											
	100	100	110	130	130	135	140	145	150	145	155

Note: For a properly matched system and piston sizing information, refer to Amana piston kit chart of the corresponding Goodman outdoor unit. Minimum Circuit Ampacity (MCA) and Maximum Overcurrent Protection (MOP) for blower without supplemental heat installed. Refer to unit nameplate and/or Heat Kit Data for specification with approved accessory heaters installed.

DIMENSIONS

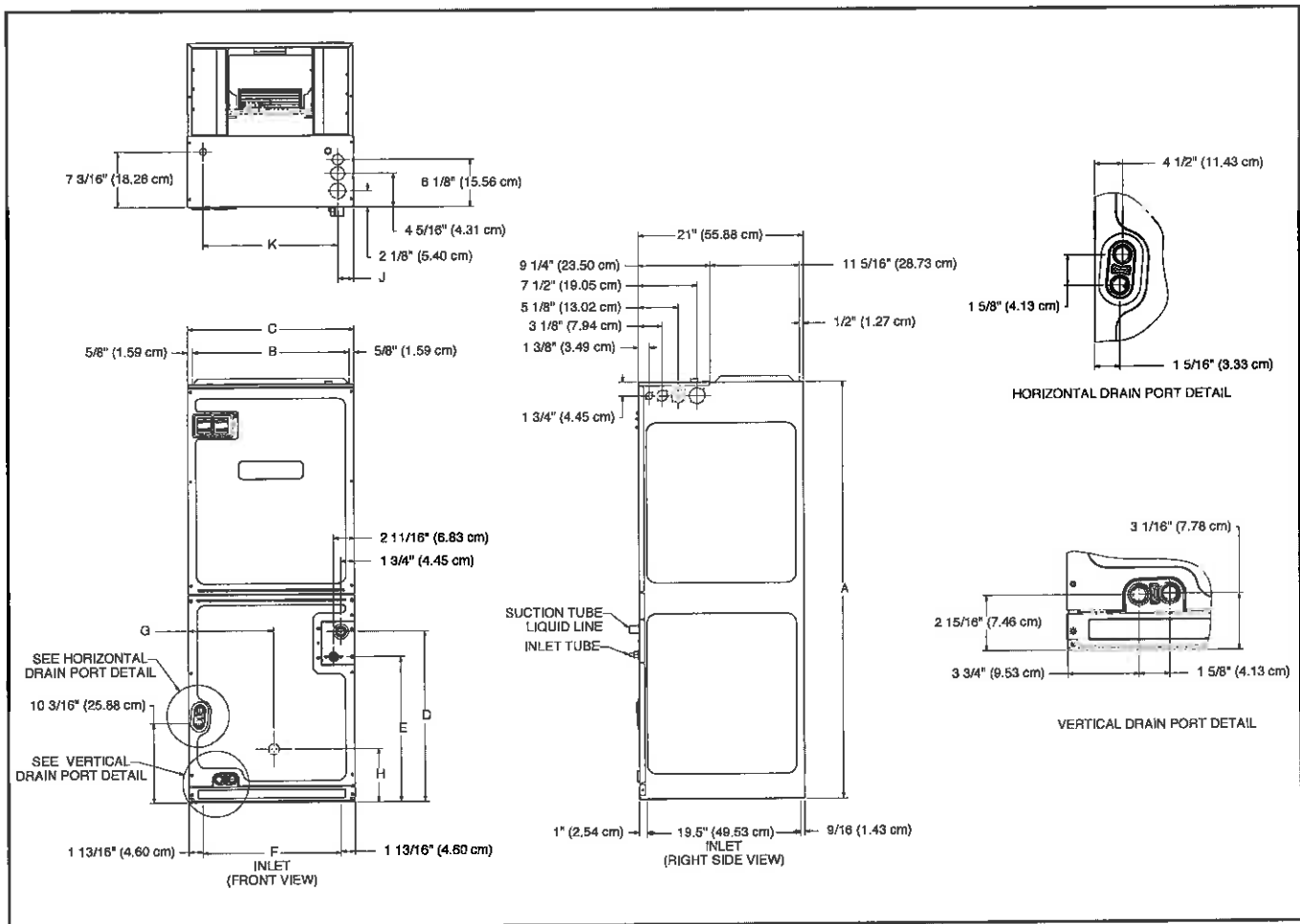

MODEL	A"	B"	C"	D"	E"	F"	G"	H"
ARUF25B14*	45	16 3/8	17 1/2	15 3/4	12	14 3/8	9 3/8	11 3/8
ARUF29B14*	45	16 3/8	17 1/2	15 3/4	12	14 3/8	9 3/8	12 3/8
ARUF31B14*	53 7/16	16 3/8	17 1/2	23 11/16	20 1/2	14 3/8	9 3/8	7 3/8
ARUF37C14*	53 7/16	19 3/8	21	21 13/16	18 3/8	17 11/16	10 13/16	6 13/16
ARUF43C14*	53 7/16	19 3/8	21	21 13/16	18 3/8	17 11/16	10 13/16	6 13/16
ARUF49C14*	53 7/16	19 3/8	21	21 13/16	18 3/8	17 11/16	10 13/16	6 13/16
ARUF37D14*	53 7/16	23 5/16	24 1/2	21 1/2	18 5/16	21 3/16	12 3/8	6 3/8
ARUF43D14*	53 7/16	23 5/16	24 1/2	21 1/2	18 5/16	21 3/16	12 3/8	6 3/8
ARUF47D14*	58	23 5/16	24 1/2	26 3/8	22 3/8	21 3/16	12 3/8	25 2/16
ARUF49D14*	53 7/16	23 5/16	24 1/2	21 1/2	18 5/16	21 3/16	12 3/8	6 3/8
ARUF61D14*	58	23 5/16	24 1/2	26 3/8	22 3/8	21 3/16	12 3/8	25 2/16

WIRING DIAGRAM – AIR HANDLER

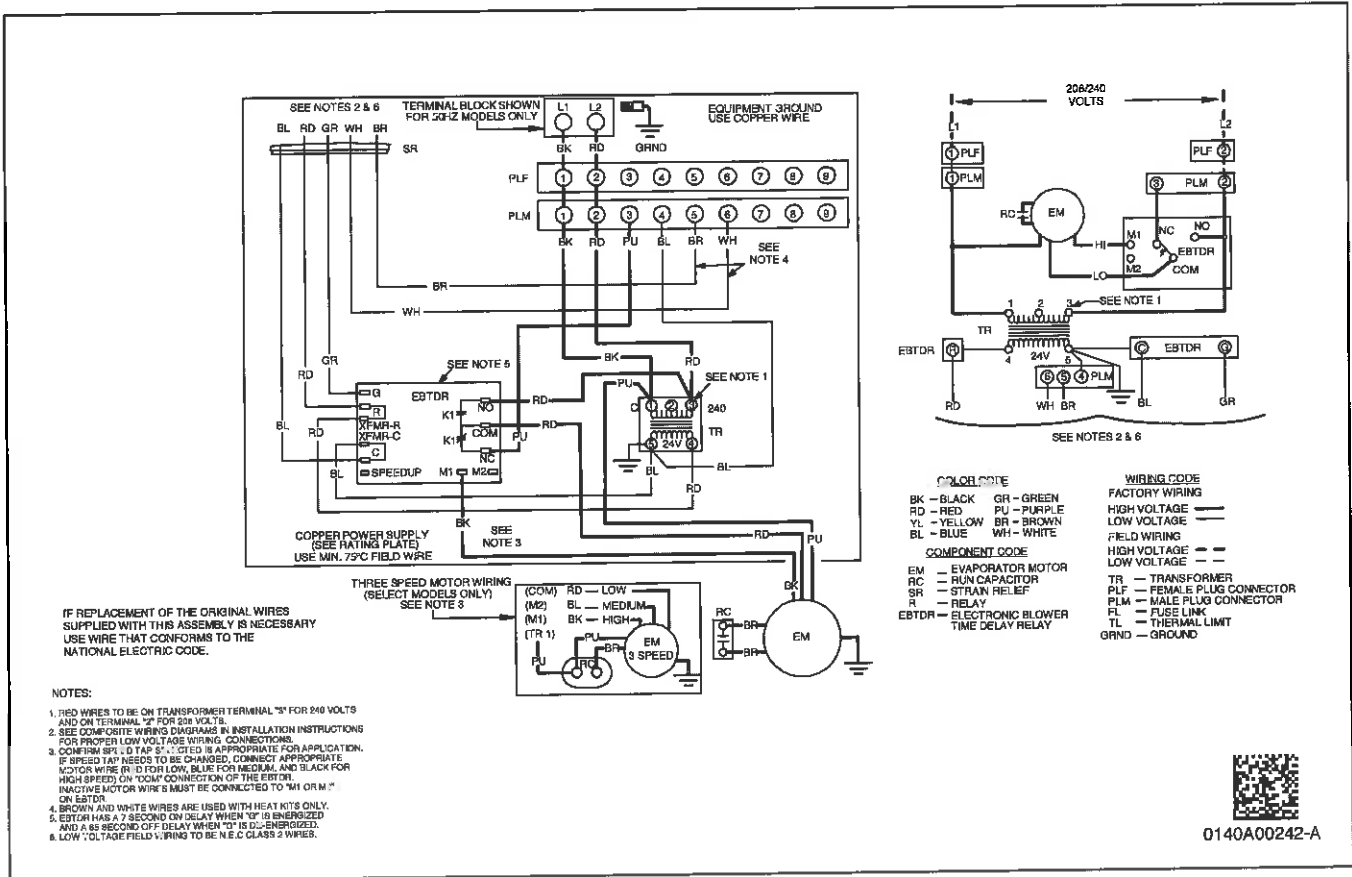

Wiring is subject to change. Always refer to the wiring diagram on the unit for the most up-to-date wiring.

WARNING High Voltage: Disconnect all power before servicing or installing this unit. Multiple power sources may be present. Failure to do so may cause property damage, personal injury, or death.

FAN #1 BDCR20 - EXHAUST FAN

EXHAUST FAN INFORMATION - Job#2417313

FAN UNIT NO.	TAG	FAN UNIT MODEL #	CFM	ESP.	RPM	H.P.	B.H.P.	Ø	VOLT	FLA	WEIGHT (LBS.)	SONES
1		BDCR20	4759	0.001	830	0.750	0.6270	1	115	11.0	146	13.6

- FEATURES:**
- ROOF MOUNTED FANS
 - UL705
 - AMCA SOUND AND AIR CERTIFIED
 - WIRING FROM MOTOR TO DISCONNECT SWITCH
 - DISCONNECT SWITCH
 - STANDARD BIRD SCREEN

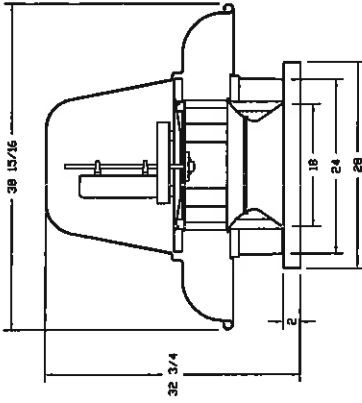

JOB: Jon-Charleston, WV	
LOCATION: CHARLESTON, WV, 25303	JOB # 2417313
DATE: 8/24/2015	DRAWN BY: courtneyh
DWG # 1	REV. 3/8" = 1'-0"

FloAire



Exhaust Fan Wiring

JOB 2417313 - Jon-Charleston, WV

DRAWING NUMBER EXH2417313-1

SHIP DATE 8/24/2015

MODEL BDCR20

1
2
3
4
5
6
7
8
9
10
11
12
13
14
15
16
17
18
19
20
21
22
23



Installed Options

Component Identification

Label	Description	Location
MT-01	Fan Motor	[2]
SW-01	Main disconnect switch	[2]

MOTOR INFO	
EXHAUST	0.75HP-115V-1P-11.0FLA

ELECTRICAL INFORMATION	
MOTOR/CTRL	MCA: 13.8A
MOTOR/CTRL	MOP: 20A

NOTES
 - - - - DENOTES FIELD WIRING
 _____ DENOTES INTERNAL WIRING

WIRE COLOR	
BK - BLACK	YW - YELLOW
BL - BLUE	GR - GREEN
BR - BROWN	GY - GRAY
OR - ORANGE	PR - PURPLE
RD - RED	PK - PINK
WH - WHITE	

Part Number: T6051A1016



Manufacturer

Honeywell

Description

TSTAT 46/84F LINE VOLT HVY
DTY

Accessories (Not Included)

Replacement Parts

135652AA
BLANK FACEPLATE FOR T6051

135499
KNOB FOR T6051/T6052

138541A
T6051 BASEPLATE FOR STAT
GUARD

199923AA
CVR PLSTC W/TRERM
F'T6051/6052

Johnstone Supply Products

List all Johnstone Products



 [Enlarge Image](#)

Brand Name:	Revcor
Product:	W80-002
<u>Product Image</u>	
Mfg. #:	R31810
User Desc:	FAN BLADE 18IN CCW
Display Name:	Revcor Fan Blade

Vendor

Marketing

Price

Misc

Specs

Product

Product:	W80-002
Product Group:	Revcor Fan Blade
Body Copy:	3-Blade
Applications:	Unitary condenser, heat pump,s unit heaters, ventilators and exhaust fans
Discontinued Ind:	No
Hazardous:	N
Cube:	2709
Country of Origin:	US - UNITED STATES
Department:	P - Motors & Components
Details:	Blades: 3; Hub Location: Intake; Pitch: 27°; Rot.: CCW; Size: 18";

 SEARCH

Johnstone Supply Products

List all Johnstone Products



[Enlarge Image](#)

Brand Name:	Surface Igniter
Product:	L46-113
<u>Product Image</u>	
Mfg. #:	DS010KJ
User Desc:	IGNITOR HOT SURFACE
Display Name:	Hot Surface Ignitor

Vendor

Marketing

Price

Misc

Specs

Product

Product:	L46-113
Product Group:	Hot Surface Ignitor
Body Copy:	5.25" lead length 120 VAC Designed to reach ignition temperature within 17 seconds 18-gauge nickel chrome lead wires Includes mounting adapter
Discontinued Ind:	No
Hazardous:	N
Cube:	60.17
Country of Origin:	CN - CHINA
Department:	L - Controls & Hydronics
Details:	Lead Length: 5-1/4";
Johnstone Stock#:	L46113

Part Number: SHE6354



Manufacturer
Description

Trane
V-Belt Idler Pulley; 3/8" Bore

Accessories (Not Included)

Replacement Parts

PRINT

Part Number: BRG0648



Manufacturer

Trane

Description

2Bolt Flg Bearing 1-7/16 Bore

Accessories (Not Included)

Replacement Parts

[PRINT](#)

Johnstone Supply Products

List all Johnstone Products



 [Enlarge Image](#)

Brand Name:	Emerson Flow Controls
Product:	B12-274
<u>Product Image</u>	
Mfg. #:	EK-304S
User Desc:	DRIER LIQUID 1/2ODF 30CU
Display Name:	EK Series Liquid Line Filter-Drier

Vendor

Marketing

Price

Misc

Specs

Product

Product:	B12-274
Product Group:	EK Series Liquid Line Filter-Drier
Body Copy:	Filtration first, for more effective use of desiccant surface area Specially formulated desiccant blend for maximum removal of acid and moisture Process-controlled fiberglass network for premium filtration Compatible with CFC, HCFC and HFC refrigerants Capacity ratings listed below are nominal system tonnage
Discontinued Ind:	No
Hazardous:	N
Cube:	130.88
Country of Origin:	MX - MEXICO
Department:	R - Refrigeration
Details:	Conn. Size: 1/2" ODF; Cubic Inches: 30; Length: 9.13"; R12/R134a Capacity: 7.5; R22/R410A Capacity: 10.0; R404A/R507 Capacity: 4.0;

SEARCH

Johnstone Supply Products

List all Johnstone Products

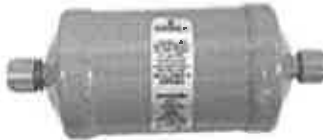

[Enlarge Image](#)

Brand Name:	Emerson Flow Controls
Product:	B17-225
<u>Product Image</u>	
Mfg. #:	BSB-163S
User Desc:	DRIER BIFLOW 3/8ODF 16CU
Display Name:	BSB Bi-Flow Filter-Drier

Vendor Marketing Price Misc Specs

Product

Product:	B17-225
Product Group:	BSB Bi-Flow Filter-Drier
Body Copy:	Economical liquid line drier for air conditioning applications Filtration to 40 microns Solid copper connections Capacity ratings listed are nominal system tonnage
Discontinued Ind:	No
Hazardous:	N
Cube:	66.64
Country of Origin:	MX - MEXICO
Department:	R - Refrigeration
Details:	Conn. Size: 3/8" ODF; Cubic Inches: 16; Length: 6.08"; R22/R410A Capacity: 5.0;
Johnstone Stock#:	B17225

Johnstone Supply Products

List all Johnstone Products



[Enlarge Image](#)

Brand Name:	Packard
Product:	L45-049
Product Image	
User Desc:	CONTACTOR 3P 30A 24V
Display Name:	Definite Purpose Contactor 3-Pole

Vendor

Marketing

Price

Misc

Specs

Product

Product:	L45-049
Product Group:	Definite Purpose Contactor
Body Copy:	In accordance with UL Bulletin No. 508 "Industrial Control Equipment," contactor meet specifications for devices up to 600 VAC Silver plated contact with cover Box lugs and spade terminals standard on all sizes Class B coil insulation UL and cUL recognized Auxiliary switch and replacement coil available 50/60 Hertz 3 Pole 30 F/L inductive Amps 40 Resistive Amps 24 coil voltage
Discontinued Ind:	No
Hazardous:	N
Cube:	32.02
Country of Origin:	CN - CHINA
Department:	P - Motors & Components

Johnstone Supply Products

List all Johnstone Products



[Enlarge Image](#)

Brand Name:	Packard
Product:	L45-038
<u>Product Image</u>	
User Desc:	CONTACTOR 2P 40A 24V
Display Name:	Definite Purpose Contactor 2-Pole

Vendor

Marketing

Price

Misc

Specs

Product

Product:	L45-038
Product Group:	Definite Purpose Contactor
Body Copy:	In accordance with UL Bulletin No. 508 "Industrial Control Equipment," contactor meet specifications for devices up to 600 VAC Silver plated contact with cover Box lugs and spade terminals standard on all sizes Class B coil insulation UL and cUL recognized Auxiliary switch and replacement coil available 50/60 Hertz 2 Pole 40 F/L inductive Amps 50 Resistive Amps 24 coil voltage
Discontinued Ind:	No
Hazardous:	N
Cube:	23.34
Country of Origin:	CN - CHINA
Department:	P - Motors & Components

Johnstone Supply Products

List all Johnstone Products



 [Enlarge Image](#)

Brand Name:	Robinair
Product:	H85-445
<u>Product Image</u>	
Mfg. #:	15500
User Desc:	VACUUM PUMP 5CFM
Display Name:	5 CFM VacuMaster® Vacuum Pump

Vendor

Marketing

Price

Misc

Specs

Product

Product:	H85-445
Product Group:	5 CFM VacuMaster® Vacuum Pump
Body Copy:	2-stage pump rated at 40 microns Compact and lightweight
Specifications:	Factory rating: 40 microns Voltage: 110V, 60 Hz
Discontinued Ind:	No
Hazardous:	N
Cube:	1366.25
Country of Origin:	CN - CHINA
Department:	H - Tools
Details:	CFM: 5; Conn. Size: 1/4" & 3/8" Male Flare; Height: 10"; Length: 13"; Motor HP: 1/3; Oil Cap.: 9.5 Oz.; Width: 5"; Wt. Lbs.: 21;
Johnstone Stock#:	H85445

 SEARCH

Johnstone Supply Products

List all Johnstone Products



[Enlarge Image](#)

Brand Name:	Supco
Product:	B11-519
<u>Product Image</u>	
Mfg. #:	SPP6
User Desc:	HARD START SUPER BOOST
Display Name:	Starter Pow-R-Pak

Vendor

Marketing

Price

Misc

Specs

Product

Product:	B11-519
Product Group:	Starter Pow-R-Pak
Body Copy:	Combination relay and start capacitor Gives up to 500% additional starting torque to single-phase 120/288VAC units from 4,000 to 120,000 BtuH Two-wire connection to existing run capacitor for easy installation UR recognized
Discontinued Ind:	No
Hazardous:	N
Cube:	65.47
Country of Origin:	CN - CHINA
Department:	R - Refrigeration
Details:	Starting Torque: Up to 500%;

Part Number: SEN1364

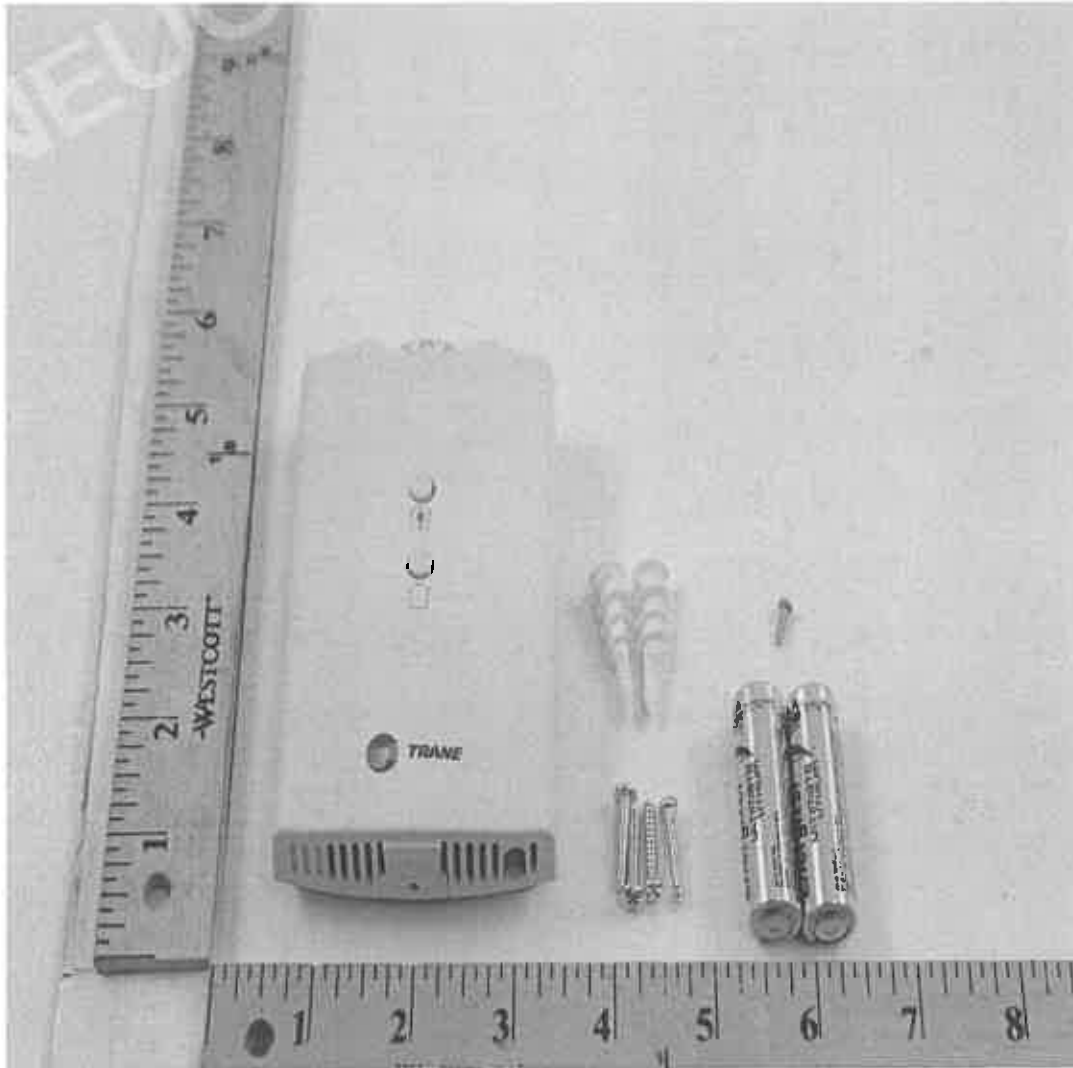

Manufacturer
Description

Trane
T-STAT

Accessories (Not Included)

Replacement Parts

[PRINT](#)

Part Number: BRD2893

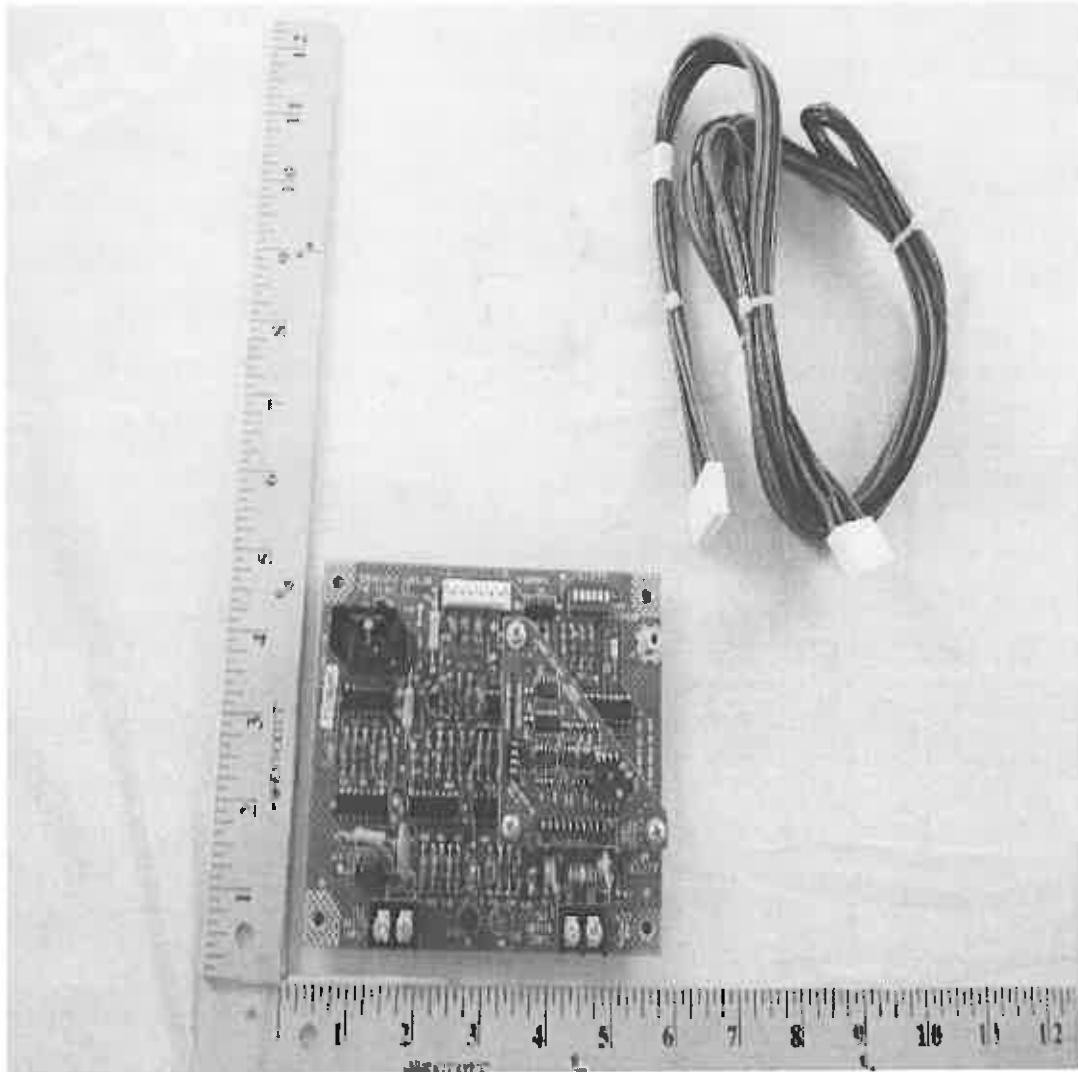

Manufacturer
Description

Trane
TCI Control Board Kit

Accessories (Not Included)

Replacement Parts

[PRINT](#)

Part Number: TRR0664



Manufacturer

Trane

Description

460/575-115/230V 350VA Xformer

Accessories (Not Included)

Replacement Parts

[PRINT](#)

Part Number: DHY1470



Manufacturer

Trane

Description

5/8x1/2 16CuIn Filter Drier

Accessories (Not Included)

Replacement Parts

[PRINT](#)

Part Number: SEN2076



Manufacturer

Trane

Description

Temperature Sensor W/Display

Accessories (Not Included)

Replacement Parts

[PRINT](#)

Part Number: MOD1393

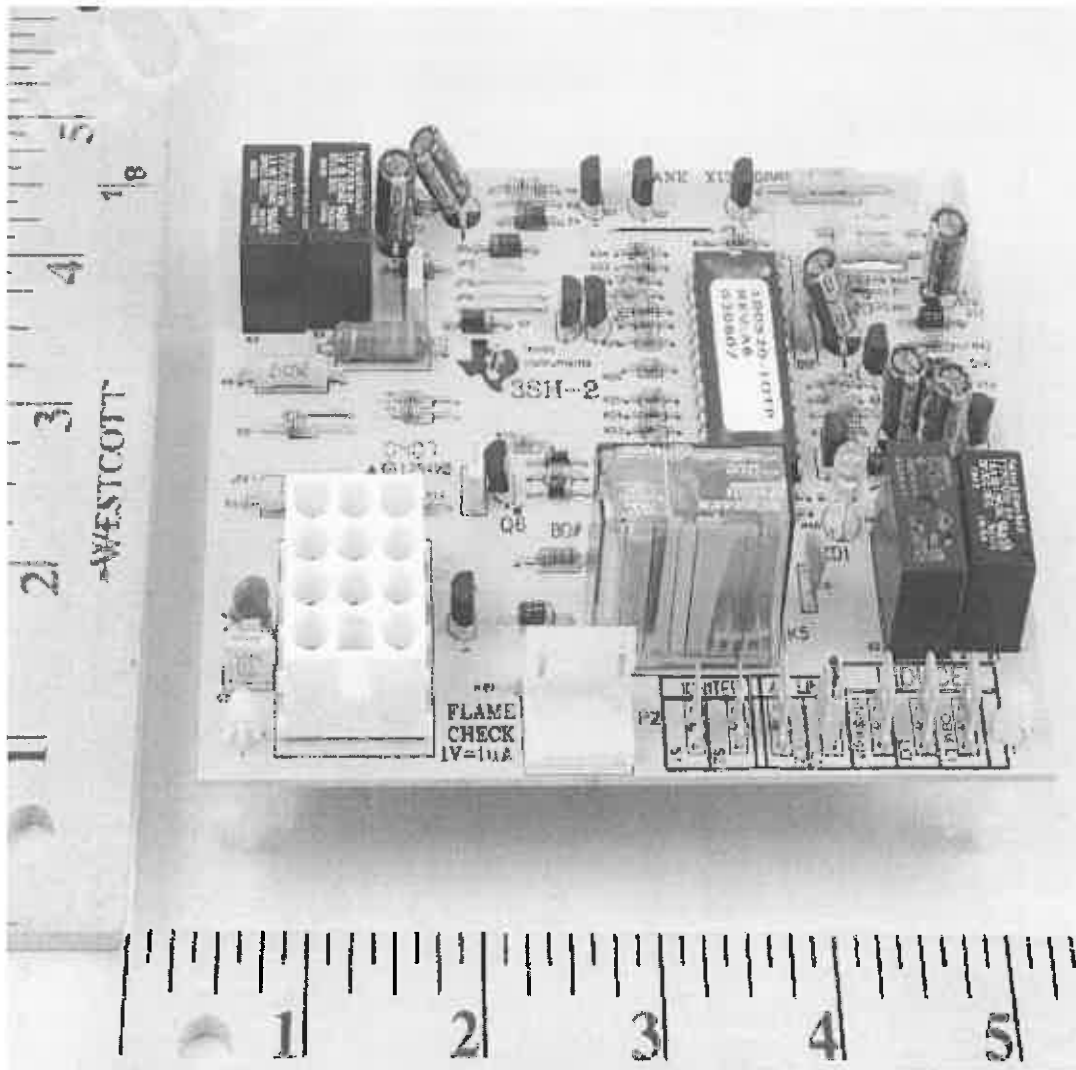

Manufacturer
Description

Trane
Ignition Module

Accessories (Not Included)

Replacement Parts

[PRINT](#)

Part Number: SEN1447

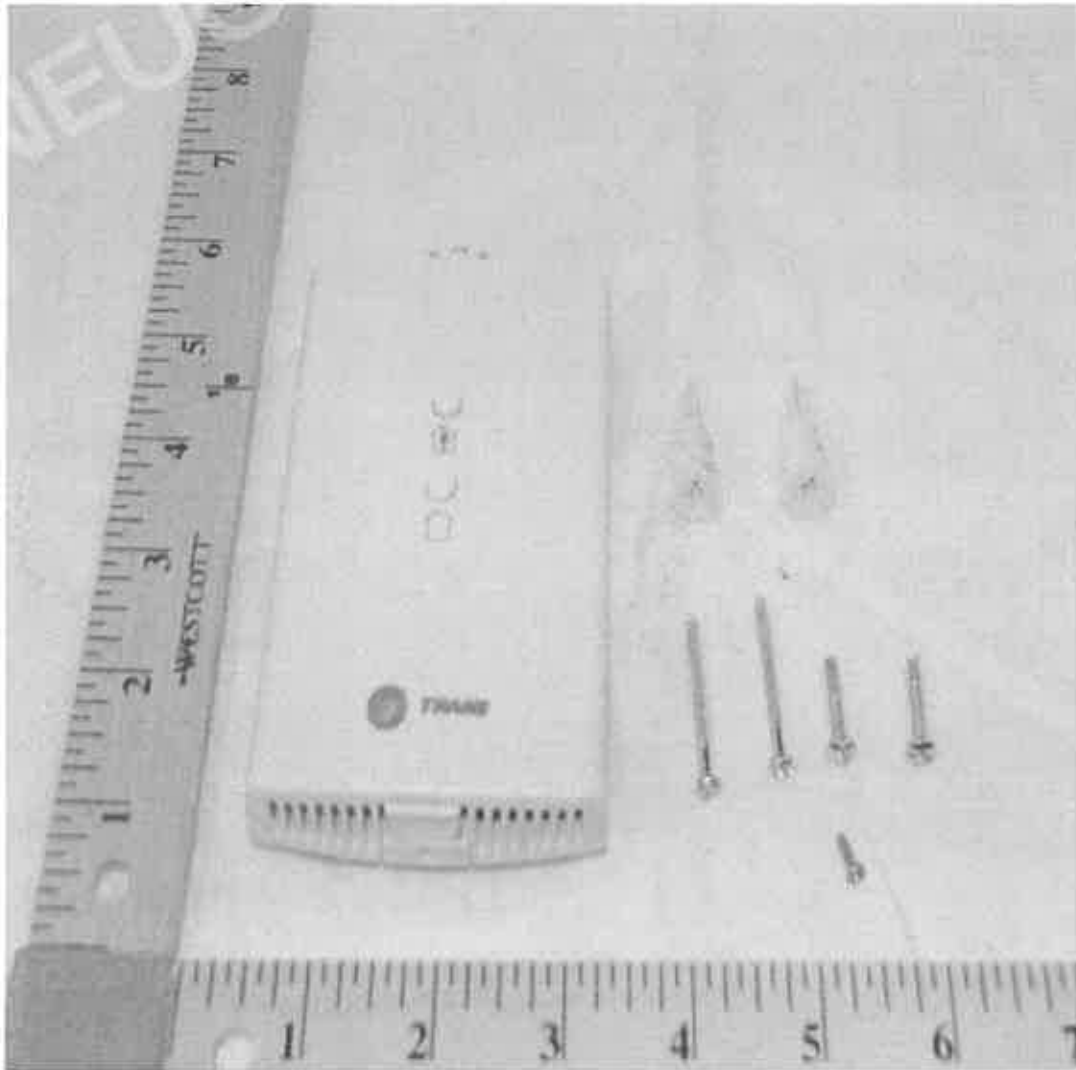

Manufacturer

Trane

Description

10K Ohm Wired Zone Snsr W/Dial

Accessories (Not Included)

Replacement Parts

CON1313

Communication Module Connector

KNB0182

HOT/COLD THUMBWHEEL KNOB

Part Number: D1089



Manufacturer
Description

Fasco Motors
115V 1/15HP 850RPM Motor

Accessories (Not Included)

Replacement Parts

[PRINT](#)

Part Number: MOT13651



Manufacturer
Description

Trane Parts
1/10HP 115V 810/675/500RPM Mtr

Accessories (Not Included)

Replacement Parts

CPT0072
5MFD 370V Oval Run Capacitor

PRINT

Johnstone Supply Products

List all Johnstone Products

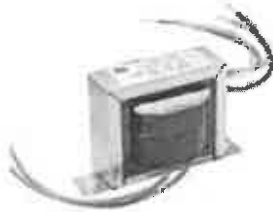

[Enlarge Image](#)

Brand Name:	Packard
Product:	G22-336
<u>Product Image</u>	
Mfg. #:	PF42440
User Desc:	CONTROL TRANSFORMER 40VA
Display Name:	Control Transformer Class II Foot Mount Transformers

Vendor

Marketing

Price

Misc

Specs

Product

Product:	G22-336
Product Group:	Control Transformer
Body Copy:	120/208-240 Primary Voltage 24 Secondary Voltage Class 2 rated, easily mounts for use on low voltage control circuits Designed for over 60,000 hours of continuous use under normal load conditions 40 VA output Option Wire Lead Connection Foot Mount Replaces Jard 4031F and UET 115
Discontinued Ind:	No
Hazardous:	N
Cube:	30.24
Country of Origin:	CN - CHINA
Department:	P - Motors & Components
Details:	Mounting Configuration: 2 Foot; Primary Voltage: 120/208/240; Secondary Voltage: 24; VA Rating: 40;

Part Number: 6212ZZ



Manufacturer	T.B. WOODS, BEARINGS, PULLEYS & ACCESSORIES
Description	2 Shield Bearing
Accessories (Not Included)	Replacement Parts

PRINT

State of West Virginia

VENDOR PREFERENCE CERTIFICATE

Certification and application is hereby made for Preference in accordance with *West Virginia Code*, §5A-3-37. (Does not apply to construction contracts). *West Virginia Code*, §5A-3-37, provides an opportunity for qualifying vendors to request (at the time of bid) preference for their residency status. Such preference is an evaluation method only and will be applied only to the cost bid in accordance with the *West Virginia Code*. This certificate for application is to be used to request such preference. The Purchasing Division will make the determination of the Vendor Preference, if applicable.

1. **Application is made for 2.5% vendor preference for the reason checked:**
Bidder is an individual resident vendor and has resided continuously in West Virginia for four (4) years immediately preceding the date of this certification; or,
 Bidder is a partnership, association or corporation resident vendor and has maintained its headquarters or principal place of business continuously in West Virginia for four (4) years immediately preceding the date of this certification; or 80% of the ownership interest of Bidder is held by another individual, partnership, association or corporation resident vendor who has maintained its headquarters or principal place of business continuously in West Virginia for four (4) years immediately preceding the date of this certification; or,
 Bidder is a nonresident vendor which has an affiliate or subsidiary which employs a minimum of one hundred state residents and which has maintained its headquarters or principal place of business within West Virginia continuously for the four (4) years immediately preceding the date of this certification; or,
2. **Application is made for 2.5% vendor preference for the reason checked:**
Bidder is a resident vendor who certifies that, during the life of the contract, on average at least 75% of the employees working on the project being bid are residents of West Virginia who have resided in the state continuously for the two years immediately preceding submission of this bid; or,
3. **Application is made for 2.5% vendor preference for the reason checked:**
Bidder is a nonresident vendor employing a minimum of one hundred state residents or is a nonresident vendor with an affiliate or subsidiary which maintains its headquarters or principal place of business within West Virginia employing a minimum of one hundred state residents who certifies that, during the life of the contract, on average at least 75% of the employees or Bidder's affiliate's or subsidiary's employees are residents of West Virginia who have resided in the state continuously for the two years immediately preceding submission of this bid; or,
4. **Application is made for 5% vendor preference for the reason checked:**
Bidder meets either the requirement of both subdivisions (1) and (2) or subdivision (1) and (3) as stated above; or,
5. **Application is made for 3.5% vendor preference who is a veteran for the reason checked:**
Bidder is an individual resident vendor who is a veteran of the United States armed forces, the reserves or the National Guard and has resided in West Virginia continuously for the four years immediately preceding the date on which the bid is submitted; or,
6. **Application is made for 3.5% vendor preference who is a veteran for the reason checked:**
Bidder is a resident vendor who is a veteran of the United States armed forces, the reserves or the National Guard, if, for purposes of producing or distributing the commodities or completing the project which is the subject of the vendor's bid and continuously over the entire term of the project, on average at least seventy-five percent of the vendor's employees are residents of West Virginia who have resided in the state continuously for the two immediately preceding years.
7. **Application is made for preference as a non-resident small, women- and minority-owned business, in accordance with *West Virginia Code* §5A-3-59 and *West Virginia Code of State Rules*.**
Bidder has been or expects to be approved prior to contract award by the Purchasing Division as a certified small, women- and minority-owned business.

Bidder understands if the Secretary of Revenue determines that a Bidder receiving preference has failed to continue to meet the requirements for such preference, the Secretary may order the Director of Purchasing to: (a) reject the bid; or (b) assess a penalty against such Bidder in an amount not to exceed 5% of the bid amount and that such penalty will be paid to the contracting agency or deducted from any unpaid balance on the contract or purchase order.

By submission of this certificate, Bidder agrees to disclose any reasonably requested information to the Purchasing Division and authorizes the Department of Revenue to disclose to the Director of Purchasing appropriate information verifying that Bidder has paid the required business taxes, provided that such information does not contain the amounts of taxes paid nor any other information deemed by the Tax Commissioner to be confidential.

Under penalty of law for false swearing (*West Virginia Code*, §61-5-3), Bidder hereby certifies that this certificate is true and accurate in all respects; and that if a contract is issued to Bidder and if anything contained within this certificate changes during the term of the contract, Bidder will notify the Purchasing Division in writing immediately.

Bidder: Johnstone Supply
Date: 9/1/15

Signed: [Signature]
Title: Customer Solutions Mgr. - Territory Sales

STATE OF WEST VIRGINIA
Purchasing Division

PURCHASING AFFIDAVIT

MANDATE: Under W. Va. Code §5A-3-10a, no contract or renewal of any contract may be awarded by the state or any of its political subdivisions to any vendor or prospective vendor when the vendor or prospective vendor or a related party to the vendor or prospective vendor is a debtor and: (1) the debt owed is an amount greater than one thousand dollars in the aggregate; or (2) the debtor is in employer default.

EXCEPTION: The prohibition listed above does not apply where a vendor has contested any tax administered pursuant to chapter eleven of the W. Va. Code, workers' compensation premium, permit fee or environmental fee or assessment and the matter has not become final or where the vendor has entered into a payment plan or agreement and the vendor is not in default of any of the provisions of such plan or agreement.

DEFINITIONS:

"Debt" means any assessment, premium, penalty, fine, tax or other amount of money owed to the state or any of its political subdivisions because of a judgment, fine, permit violation, license assessment, defaulted workers' compensation premium, penalty or other assessment presently delinquent or due and required to be paid to the state or any of its political subdivisions, including any interest or additional penalties accrued thereon.

"Employer default" means having an outstanding balance or liability to the old fund or to the uninsured employers' fund or being in policy default, as defined in W. Va. Code § 23-2c-2, failure to maintain mandatory workers' compensation coverage, or failure to fully meet its obligations as a workers' compensation self-insured employer. An employer is not in employer default if it has entered into a repayment agreement with the Insurance Commissioner and remains in compliance with the obligations under the repayment agreement.

"Related party" means a party, whether an individual, corporation, partnership, association, limited liability company or any other form or business association or other entity whatsoever, related to any vendor by blood, marriage, ownership or contract through which the party has a relationship of ownership or other interest with the vendor so that the party will actually or by effect receive or control a portion of the benefit, profit or other consideration from performance of a vendor contract with the party receiving an amount that meets or exceeds five percent of the total contract amount.

AFFIRMATION: By signing this form, the vendor's authorized signer affirms and acknowledges under penalty of law for false swearing (W. Va. Code §61-5-3) that neither vendor nor any related party owe a debt as defined above and that neither vendor nor any related party are in employer default as defined above, unless the debt or employer default is permitted under the exception above.

WITNESS THE FOLLOWING SIGNATURE:

Vendor's Name: Johnstone Supply

Authorized Signature: [Signature] Date: 9/1/15

State of West Virginia

County of KANAWHA, to-wit:

Taken, subscribed, and sworn to before me this 1st day of Sept, 2015.

My Commission expires August 19, 2018

AFFIX SEAL HERE

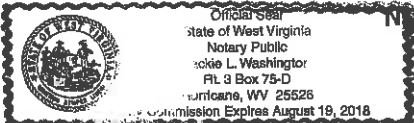

NOTARY PUBLIC

[Signature]
Purchasing Affidavit (Revised 08/01/2015)