



Purchasing Division
 2019 Washington Street East
 Post Office Box 50130
 Charleston, WV 25305-0130

State of West Virginia
 Request for Quotation

Proc Folder: 90401

Doc Description: STRUCTURAL BEAMS

Proc Type: Central Purchase Order

Date Issued	Solicitation Closes	Solicitation No	Version
2015-04-14	2015-05-12 13:30:00	CRFQ 0803 DOT1500000086	1

BID RECEIVING LOCATION

BID CLERK
 DEPARTMENT OF ADMINISTRATION
 PURCHASING DIVISION
 2019 WASHINGTON ST E
 CHARLESTON WV 25305
 US

VENDOR

Vendor Name, Address and Telephone Number:

Buildog Rack Co.
 200 Fort Stephens RD
 Weirton WV 26062
 304-479-3364 cell office 304-748 6401

05/12/15 10:05:15
 WV Purchasing Division

FOR INFORMATION CONTACT THE BUYER

Misty DeLong
 (304) 558-8802
 misty.m.delong@wv.gov

Signature X

FEIN # 000000 114027

DATE 5-11-15

All offers subject to all terms and conditions contained in this solicitation

INVOICE TO		SHIP TO	
DIVISION OF HIGHWAYS DISTRICT SEVEN DRAWER 1228 WESTON WV26452 US		DIVISION OF HIGHWAYS DISTRICT SEVEN STORAGE YARD 1205 US HWY 19 SOUTH WESTON WV 26452 US	

Line	Comm Ln Desc	Qty	Unit Issue	Unit Price	Total Price
1	HP 10 X 42 STEEL	275520.00000	LB	.4310	118,749. ¹²

Comm Code	Manufacturer	Specification	Model #
30101704			

Extended Description :
 275,520 POUNDS HP 10 X 42
 144 PIECES - 30 FEET LONG
 56 PIECES - 40 FEET LONG

INVOICE TO		SHIP TO	
DIVISION OF HIGHWAYS DISTRICT SEVEN DRAWER 1228 WESTON WV26452 US		DIVISION OF HIGHWAYS DISTRICT SEVEN STORAGE YARD 1205 US HWY 19 SOUTH WESTON WV 26452 US	

Line	Comm Ln Desc	Qty	Unit Issue	Unit Price	Total Price
2	W 8 X 21 STEEL	21000.00000	LB	.4070	8547. ⁰⁰

Comm Code	Manufacturer	Specification	Model #
30101704			

Extended Description :
 21,000 POUNDS HP 8 X 21
 50 PIECES - 20 FEET LONG

DOT1500000086	Document Phase Draft	Document Description STRUCTURAL BEAMS	Page 3 of 3
---------------	--------------------------------	---	-----------------------

ADDITIONAL TERMS AND CONDITIONS

See attached document(s) for additional Terms and Conditions

INSTRUCTIONS TO VENDORS SUBMITTING BIDS

1. **REVIEW DOCUMENTS THOROUGHLY:** The attached documents contain a solicitation for bids. Please read these instructions and all documents attached in their entirety. These instructions provide critical information about requirements that if overlooked could lead to disqualification of a Vendor's bid. All bids must be submitted in accordance with the provisions contained in these instructions and the Solicitation. Failure to do so may result in disqualification of Vendor's bid.
2. **MANDATORY TERMS:** The Solicitation may contain mandatory provisions identified by the use of the words "must," "will," and "shall." Failure to comply with a mandatory term in the Solicitation will result in bid disqualification.
3. **PREBID MEETING:** The item identified below shall apply to this Solicitation.

A pre-bid meeting will not be held prior to bid opening.

A NON-MANDATORY PRE-BID meeting will be held at the following place and time:

A MANDATORY PRE-BID meeting will be held at the following place and time:

All Vendors submitting a bid must attend the mandatory pre-bid meeting. Failure to attend the mandatory pre-bid meeting shall result in disqualification of the Vendor's bid. No one person attending the pre-bid meeting may represent more than one Vendor.

An attendance sheet provided at the pre-bid meeting shall serve as the official document verifying attendance. The State will not accept any other form of proof or documentation to verify attendance. Any person attending the pre-bid meeting on behalf of a Vendor must list on the attendance sheet his or her name and the name of the Vendor he or she is representing. Additionally, the person attending the pre-bid meeting should include the Vendor's E-Mail address, phone number, and Fax number on the attendance sheet. It is the Vendor's responsibility to locate the attendance sheet and provide the required information. Failure to complete the attendance sheet as required may result in disqualification of Vendor's bid.

All Vendors should arrive prior to the starting time for the pre-bid. Vendors who arrive after the starting time but prior to the end of the pre-bid will be permitted to sign in, but are charged with knowing all matters discussed at the pre-bid.

Questions submitted at least five business days prior to a scheduled pre-bid will be discussed at the pre-bid meeting if possible. Any discussions or answers to questions at the pre-bid meeting are preliminary in nature and are non-binding. Official and binding answers to questions will be published in a written addendum to the Solicitation prior to bid opening.

4. **VENDOR QUESTION DEADLINE:** Vendors may submit questions relating to this Solicitation to the Purchasing Division. Questions must be submitted in writing. All questions must be submitted on or before the date listed below and to the address listed below in order to be considered. A written response will be published in a Solicitation addendum if a response is possible and appropriate. Non-written discussions, conversations, or questions and answers regarding this Solicitation are preliminary in nature and are non-binding. Submitted e-mails should have solicitation number in the subject line.

Question Submission Deadline: April 24, 2015

Submit Questions to: Misty Delong
2019 Washington Street, East
Charleston, WV 25305
Fax: (304) 558-4115 (Vendors should not use this fax number for bid submission)
Email: Misty.M.Delong@wv.gov

5. **VERBAL COMMUNICATION:** Any verbal communication between the Vendor and any State personnel is not binding, including verbal communication at the mandatory pre-bid conference. Only information issued in writing and added to the Solicitation by an official written addendum by the Purchasing Division is binding.
6. **BID SUBMISSION:** All bids must be submitted electronically through wvOASIS or signed and delivered by the Vendor to the Purchasing Division at the address listed below on or before the date and time of the bid opening. Any bid received by the Purchasing Division staff is considered to be in the possession of the Purchasing Division and will not be returned for any reason. The Purchasing Division will not accept bids, modification of bids, or addendum acknowledgment forms via e-mail. Acceptable delivery methods include electronic submission via wvOASIS, hand delivery, delivery by courier, or facsimile. The bid delivery address is:

Department of Administration, Purchasing Division
2019 Washington Street East
Charleston, WV 25305-0130

A bid that is not submitted electronically through wvOASIS should contain the information listed below on the face of the envelope or the bid may be rejected by the Purchasing Division.:

SEALED BID:

BUYER: Misty DeLong

SOLICITATION NO.: CRFQ DOT1500000086

BID OPENING DATE: May 12, 2015

BID OPENING TIME: 1:30 PM, EST.

FAX NUMBER: 304-558-3970

In the event that Vendor is responding to a request for proposal, and chooses to respond in a manner other than by electronic submission through wvOASIS, the Vendor shall submit one original technical and one original cost proposal plus NA convenience copies of each to the Purchasing Division at the address shown above. Additionally, if Vendor does not submit its bid through wvOASIS, the Vendor should identify the bid type as either a technical or cost proposal on the face of each bid envelope submitted in response to a request for proposal as follows:

BID TYPE: (This only applies to CRFP)

Technical

Cost

7. **BID OPENING:** Bids submitted in response to this Solicitation will be opened at the location identified below on the date and time listed below. Delivery of a bid after the bid opening date and time will result in bid disqualification. For purposes of this Solicitation, a bid is considered delivered when confirmation of delivery is provided by wvOASIS (in the case of electronic submission) or when the bid is time stamped by the official Purchasing Division time clock (in the case of hand delivery).

Bid Opening Date and Time: May 12, 2015 at 1:30 PM, EST.

Bid Opening Location: Department of Administration, Purchasing Division
2019 Washington Street East
Charleston, WV 25305-0130

8. **ADDENDUM ACKNOWLEDGEMENT:** Changes or revisions to this Solicitation will be made by an official written addendum issued by the Purchasing Division. Vendor should acknowledge receipt of all addenda issued with this Solicitation by completing an Addendum Acknowledgment Form, a copy of which is included herewith. Failure to acknowledge addenda may result in bid disqualification. The addendum acknowledgement should be submitted with the bid to expedite document processing.

9. **BID FORMATTING:** Vendor should type or electronically enter the information onto its bid to prevent errors in the evaluation. Failure to type or electronically enter the information may result in bid disqualification.
10. **ALTERNATES:** Any model, brand, or specification listed in this Solicitation establishes the acceptable level of quality only and is not intended to reflect a preference for, or in any way favor, a particular brand or vendor. Vendors may bid alternates to a listed model or brand provided that the alternate is at least equal to the model or brand and complies with the required specifications. The equality of any alternate being bid shall be determined by the State at its sole discretion. Any Vendor bidding an alternate model or brand should clearly identify the alternate items in its bid and should include manufacturer's specifications, industry literature, and/or any other relevant documentation demonstrating the equality of the alternate items. Failure to provide information for alternate items may be grounds for rejection of a Vendor's bid.
11. **EXCEPTIONS AND CLARIFICATIONS:** The Solicitation contains the specifications that shall form the basis of a contractual agreement. Vendor shall clearly mark any exceptions, clarifications, or other proposed modifications in its bid. Exceptions to, clarifications of, or modifications of a requirement or term and condition of the Solicitation may result in bid disqualification.
12. **COMMUNICATION LIMITATIONS:** In accordance with West Virginia Code of State Rules §148-1-6.6, communication with the State of West Virginia or any of its employees regarding this Solicitation during the solicitation, bid, evaluation or award periods, except through the Purchasing Division, is strictly prohibited without prior Purchasing Division approval. Purchasing Division approval for such communication is implied for all agency delegated and exempt purchases.
13. **REGISTRATION:** Prior to Contract award, the apparent successful Vendor must be properly registered with the West Virginia Purchasing Division and must have paid the \$125 fee, if applicable.
14. **UNIT PRICE:** Unit prices shall prevail in cases of a discrepancy in the Vendor's bid.
15. **PREFERENCE:** Vendor Preference may only be granted upon written request and only in accordance with the West Virginia Code § 5A-3-37 and the West Virginia Code of State Rules. A Vendor Preference Certificate form has been attached hereto to allow Vendor to apply for the preference. Vendor's failure to submit the Vendor Preference Certificate form with its bid will result in denial of Vendor Preference. Vendor Preference does not apply to construction projects.
16. **SMALL, WOMEN-OWNED, OR MINORITY-OWNED BUSINESSES:** For any solicitations publicly advertised for bid, in accordance with West Virginia Code §5A-3-37(a)(7) and W. Va. CSR § 148-22-9, any non-resident vendor certified as a small, women-owned, or minority-owned business under W. Va. CSR § 148-22-9 shall be provided the

same preference made available to any resident vendor. Any non-resident small, women-owned, or minority-owned business must identify itself as such in writing, must submit that writing to the Purchasing Division with its bid, and must be properly certified under W. Va. CSR § 148-22-9 prior to contract award to receive the preferences made available to resident vendors. Preference for a non-resident small, women-owned, or minority owned business shall be applied in accordance with W. Va. CSR § 148-22-9.

17. WAIVER OF MINOR IRREGULARITIES: The Director reserves the right to waive minor irregularities in bids or specifications in accordance with West Virginia Code of State Rules § 148-1-4.6.

18. ELECTRONIC FILE ACCESS RESTRICTIONS: Vendor must ensure that its submission in wvOASIS can be accessed by the Purchasing Division staff immediately upon bid opening. The Purchasing Division will consider any file that cannot be immediately opened and/or viewed at the time of the bid opening (such as, encrypted files, password protected files, or incompatible files) to be blank or incomplete as context requires, and are therefore unacceptable. A vendor will not be permitted to unencrypt files, remove password protections, or resubmit documents after bid opening if those documents are required with the bid.

GENERAL TERMS AND CONDITIONS:

1. **CONTRACTUAL AGREEMENT:** Issuance of a Award Document signed by the Purchasing Division Director, or his designee, and approved as to form by the Attorney General's office constitutes acceptance of this Contract made by and between the State of West Virginia and the Vendor. Vendor's signature on its bid signifies Vendor's agreement to be bound by and accept the terms and conditions contained in this Contract.

2. **DEFINITIONS:** As used in this Solicitation/Contract, the following terms shall have the meanings attributed to them below. Additional definitions may be found in the specifications included with this Solicitation/Contract.
 - 2.1. **"Agency" or "Agencies"** means the agency, board, commission, or other entity of the State of West Virginia that is identified on the first page of the Solicitation or any other public entity seeking to procure goods or services under this Contract.
 - 2.2. **"Contract"** means the binding agreement that is entered into between the State and the Vendor to provide the goods or services requested in the Solicitation.
 - 2.3. **"Director"** means the Director of the West Virginia Department of Administration, Purchasing Division.
 - 2.4. **"Purchasing Division"** means the West Virginia Department of Administration, Purchasing Division.
 - 2.5. **"Award Document"** means the document signed by the Agency and the Purchasing Division, and approved as to form by the Attorney General, that identifies the Vendor as the contract holder.
 - 2.6. **"Solicitation"** means the official notice of an opportunity to supply the State with goods or services that is published by the Purchasing Division.
 - 2.7. **"State"** means the State of West Virginia and/or any of its agencies, commissions, boards, etc. as context requires.
 - 2.8. **"Vendor" or "Vendors"** means any entity submitting a bid in response to the Solicitation, the entity that has been selected as the lowest responsible bidder, or the entity that has been awarded the Contract as context requires.

3. **CONTRACT TERM; RENEWAL; EXTENSION:** The term of this Contract shall be determined in accordance with the category that has been identified as applicable to this Contract below:

Term Contract

Initial Contract Term: This Contract becomes effective on _____ and extends for a period of _____ year(s).

Renewal Term: This Contract may be renewed upon the mutual written consent of the Agency, and the Vendor, with approval of the Purchasing Division and the Attorney General's office (Attorney General approval is as to form only). Any request for renewal should be submitted to the Purchasing Division thirty (30) days prior to the expiration date of the initial contract term or appropriate renewal term. A Contract renewal shall be in accordance with the terms and conditions of the original contract. Renewal of this Contract is limited to _____ successive one (1) year periods or multiple renewal periods of less than one year, provided that the multiple renewal periods do not exceed _____ months in total. Automatic renewal of this Contract is prohibited. Notwithstanding the foregoing, Purchasing Division approval is not required on agency delegated or exempt purchases. Attorney General approval may be required for vendor terms and conditions.

Delivery Order Limitations: In the event that this contract permits delivery orders, a delivery order may only be issued during the time this Contract is in effect. Any delivery order issued within one year of the expiration of this Contract shall be effective for one year from the date the delivery order is issued. No delivery order may be extended beyond one year after this Contract has expired.

Fixed Period Contract: This Contract becomes effective upon Vendor's receipt of the notice to proceed and must be completed within _____ days.

Fixed Period Contract with Renewals: This Contract becomes effective upon Vendor's receipt of the notice to proceed and part of the Contract more fully described in the attached specifications must be completed within _____ days. Upon completion, the vendor agrees that maintenance, monitoring, or warranty services will be provided for one year thereafter with an additional _____ successive one year renewal periods or multiple renewal periods of less than one year provided that the multiple renewal periods do not exceed _____ months in total. Automatic renewal of this Contract is prohibited.

One Time Purchase: The term of this Contract shall run from the issuance of the Award Document until all of the goods contracted for have been delivered, but in no event will this Contract extend for more than one fiscal year.

Other: See attached.

4. **NOTICE TO PROCEED:** Vendor shall begin performance of this Contract immediately upon receiving notice to proceed unless otherwise instructed by the Agency. Unless otherwise specified, the fully executed Award Document will be considered notice to proceed.
5. **QUANTITIES:** The quantities required under this Contract shall be determined in accordance with the category that has been identified as applicable to this Contract below.
- Open End Contract:** Quantities listed in this Solicitation are approximations only, based on estimates supplied by the Agency. It is understood and agreed that the Contract shall cover the quantities actually ordered for delivery during the term of the Contract, whether more or less than the quantities shown.
- Service:** The scope of the service to be provided will be more clearly defined in the specifications included herewith.
- Combined Service and Goods:** The scope of the service and deliverable goods to be provided will be more clearly defined in the specifications included herewith.
- One Time Purchase:** This Contract is for the purchase of a set quantity of goods that are identified in the specifications included herewith. Once those items have been delivered, no additional goods may be procured under this Contract without an appropriate change order approved by the Vendor, Agency, Purchasing Division, and Attorney General's office.
6. **PRICING:** The pricing set forth herein is firm for the life of the Contract, unless specified elsewhere within this Solicitation/Contract by the State. A Vendor's inclusion of price adjustment provisions in its bid, without an express authorization from the State in the Solicitation to do so, may result in bid disqualification.
7. **EMERGENCY PURCHASES:** The Purchasing Division Director may authorize the Agency to purchase goods or services in the open market that Vendor would otherwise provide under this Contract if those goods or services are for immediate or expedited delivery in an emergency. Emergencies shall include, but are not limited to, delays in transportation or an unanticipated increase in the volume of work. An emergency purchase in the open market, approved by the Purchasing Division Director, shall not constitute of breach of this Contract and shall not entitle the Vendor to any form of compensation or damages. This provision does not excuse the State from fulfilling its obligations under a One Time Purchase contract.
8. **REQUIRED DOCUMENTS:** All of the items checked below must be provided to the Purchasing Division by the Vendor as specified below.

BID BOND: All Vendors shall furnish a bid bond in the amount of five percent (5%) of the total amount of the bid protecting the State of West Virginia. The bid bond must be submitted with the bid.

PERFORMANCE BOND: The apparent successful Vendor shall provide a performance bond in the amount of _____. The performance bond must be received by the Purchasing Division prior to Contract award. On construction contracts, the performance bond must be 100% of the Contract value.

LABOR/MATERIAL PAYMENT BOND: The apparent successful Vendor shall provide a labor/material payment bond in the amount of 100% of the Contract value. The labor/material payment bond must be delivered to the Purchasing Division prior to Contract award.

In lieu of the Bid Bond, Performance Bond, and Labor/Material Payment Bond, the Vendor may provide certified checks, cashier's checks, or irrevocable letters of credit. Any certified check, cashier's check, or irrevocable letter of credit provided in lieu of a bond must be of the same amount and delivered on the same schedule as the bond it replaces. A letter of credit submitted in lieu of a performance and labor/material payment bond will only be allowed for projects under \$100,000. Personal or business checks are not acceptable.

MAINTENANCE BOND: The apparent successful Vendor shall provide a two (2) year maintenance bond covering the roofing system. The maintenance bond must be issued and delivered to the Purchasing Division prior to Contract award.

INSURANCE: The apparent successful Vendor shall furnish proof of the following insurance prior to Contract award and shall list the state as a certificate holder:

Commercial General Liability Insurance: In the amount of _____ or more.

Builders Risk Insurance: In an amount equal to 100% of the amount of the Contract.

The apparent successful Vendor shall also furnish proof of any additional insurance requirements contained in the specifications prior to Contract award regardless of whether or not that insurance requirement is listed above.

LICENSE(S) / CERTIFICATIONS / PERMITS: In addition to anything required under the Section entitled Licensing, of the General Terms and Conditions, the apparent successful Vendor shall furnish proof of the following licenses, certifications, and/or permits prior to Contract award, in a form acceptable to the Purchasing Division.

The apparent successful Vendor shall also furnish proof of any additional licenses or certifications contained in the specifications prior to Contract award regardless of whether or not that requirement is listed above.

9. WORKERS' COMPENSATION INSURANCE: The apparent successful Vendor shall comply with laws relating to workers compensation, shall maintain workers' compensation insurance when required, and shall furnish proof of workers' compensation insurance upon request.

10. LITIGATION BOND: The Director reserves the right to require any Vendor that files a protest of an award to submit a litigation bond in the amount equal to one percent of the lowest bid submitted or \$5,000, whichever is greater. The entire amount of the bond shall be forfeited if the hearing officer determines that the protest was filed for frivolous or improper purpose, including but not limited to, the purpose of harassing, causing unnecessary delay, or needless expense for the Agency. All litigation bonds shall be made payable to the Purchasing Division. In lieu of a bond, the protester may submit a cashier's check or certified check payable to the Purchasing Division. Cashier's or certified checks will be deposited with and held by the State Treasurer's office. If it is determined that the protest has not been filed for frivolous or improper purpose, the bond or deposit shall be returned in its entirety.

11. LIQUIDATED DAMAGES: Vendor shall pay liquidated damages in the amount of

for _____

This clause shall in no way be considered exclusive and shall not limit the State or Agency's right to pursue any other available remedy.

- 12. ACCEPTANCE/REJECTION:** The State may accept or reject any bid in whole, or in part. Vendor's signature on its bid signifies acceptance of the terms and conditions contained in the Solicitation and Vendor agrees to be bound by the terms of the Contract, as reflected in the Award Document, upon receipt.
- 13. FUNDING:** This Contract shall continue for the term stated herein, contingent upon funds being appropriated by the Legislature or otherwise being made available. In the event funds are not appropriated or otherwise made available, this Contract becomes void and of no effect beginning on July 1 of the fiscal year for which funding has not been appropriated or otherwise made available.
- 14. PAYMENT:** Payment in advance is prohibited under this Contract. Payment may only be made after the delivery and acceptance of goods or services. The Vendor shall submit invoices, in arrears.
- 15. TAXES:** The Vendor shall pay any applicable sales, use, personal property or any other taxes arising out of this Contract and the transactions contemplated thereby. The State of West Virginia is exempt from federal and state taxes and will not pay or reimburse such taxes.
- 16. CANCELLATION:** The Purchasing Division Director reserves the right to cancel this Contract immediately upon written notice to the vendor if the materials or workmanship supplied do not conform to the specifications contained in the Contract. The Purchasing Division Director may also cancel any purchase or Contract upon 30 days written notice to the Vendor in accordance with West Virginia Code of State Rules § 148-1-7.16.2.
- 17. TIME:** Time is of the essence with regard to all matters of time and performance in this Contract.
- 18. APPLICABLE LAW:** This Contract is governed by and interpreted under West Virginia law without giving effect to its choice of law principles. Any information provided in specification manuals, or any other source, verbal or written, which contradicts or violates the West Virginia Constitution, West Virginia Code or West Virginia Code of State Rules is void and of no effect.
- 19. COMPLIANCE:** Vendor shall comply with all applicable federal, state, and local laws, regulations and ordinances. By submitting a bid, Vendor acknowledges that it has reviewed, understands, and will comply with all applicable law.
- 20. PREVAILING WAGE:** On any contract for the construction of a public improvement, Vendor and any subcontractors utilized by Vendor shall pay a rate or rates of wages which shall not be less than the fair minimum rate or rates of wages (prevailing wage), as established by the West Virginia Division of Labor under West Virginia Code §§ 21-5A-1 et seq. and available at <http://www.sos.wv.gov/administrative-law/wagerates/Pages/default.aspx>. Vendor shall be responsible for ensuring compliance with

prevailing wage requirements and determining when prevailing wage requirements are applicable. The required contract provisions contained in West Virginia Code of State Rules § 42-7-3 are specifically incorporated herein by reference.

- 21. ARBITRATION:** Any references made to arbitration contained in this Contract, Vendor's bid, or in any American Institute of Architects documents pertaining to this Contract are hereby deleted, void, and of no effect.
- 22. MODIFICATIONS:** This writing is the parties' final expression of intent. Notwithstanding anything contained in this Contract to the contrary, no modification of this Contract shall be binding without mutual written consent of the Agency, and the Vendor, with approval of the Purchasing Division and the Attorney General's office (Attorney General approval is as to form only). No Change shall be implemented by the Vendor until such time as the Vendor receives an approved written change order from the Purchasing Division.
- 23. WAIVER:** The failure of either party to insist upon a strict performance of any of the terms or provision of this Contract, or to exercise any option, right, or remedy herein contained, shall not be construed as a waiver or a relinquishment for the future of such term, provision, option, right, or remedy, but the same shall continue in full force and effect. Any waiver must be expressly stated in writing and signed by the waiving party.
- 24. SUBSEQUENT FORMS:** The terms and conditions contained in this Contract shall supersede any and all subsequent terms and conditions which may appear on any form documents submitted by Vendor to the Agency or Purchasing Division such as price lists, order forms, invoices, sales agreements, or maintenance agreements, and includes internet websites or other electronic documents. Acceptance or use of Vendor's forms does not constitute acceptance of the terms and conditions contained thereon.
- 25. ASSIGNMENT:** Neither this Contract nor any monies due, or to become due hereunder, may be assigned by the Vendor without the express written consent of the Agency, the Purchasing Division, the Attorney General's office (as to form only), and any other government agency or office that may be required to approve such assignments. Notwithstanding the foregoing, Purchasing Division approval may or may not be required on certain agency delegated or exempt purchases.
- 26. WARRANTY:** The Vendor expressly warrants that the goods and/or services covered by this Contract will: (a) conform to the specifications, drawings, samples, or other description furnished or specified by the Agency; (b) be merchantable and fit for the purpose intended; and (c) be free from defect in material and workmanship.
- 27. STATE EMPLOYEES:** State employees are not permitted to utilize this Contract for personal use and the Vendor is prohibited from permitting or facilitating the same.
- 28. BANKRUPTCY:** In the event the Vendor files for bankruptcy protection, the State of West Virginia may deem this Contract null and void, and terminate this Contract without notice.

29. CONFIDENTIALITY: The Vendor agrees that it will not disclose to anyone, directly or indirectly, any such personally identifiable information or other confidential information gained from the Agency, unless the individual who is the subject of the information consents to the disclosure in writing or the disclosure is made pursuant to the Agency's policies, procedures, and rules. Vendor further agrees to comply with the Confidentiality Policies and Information Security Accountability Requirements, set forth in <http://www.state.wv.us/admin/purchase/privacy/default.html>.

30. DISCLOSURE: Vendor's response to the Solicitation and the resulting Contract are considered public documents and will be disclosed to the public in accordance with the laws, rules, and policies governing the West Virginia Purchasing Division. Those laws include, but are not limited to, the Freedom of Information Act found in West Virginia Code §§ 29B-1-1 et seq. and the competitive bidding laws found West Virginia Code §§ 5A-3-1 et seq., 5-22-1 et seq., and 5G-1-1 et seq.

If a Vendor considers any part of its bid to be exempt from public disclosure, Vendor must so indicate by specifically identifying the exempt information, identifying the exemption that applies, providing a detailed justification for the exemption, segregating the exempt information from the general bid information, and submitting the exempt information as part of its bid but in a segregated and clearly identifiable format. Failure to comply with the foregoing requirements will result in public disclosure of the Vendor's bid without further notice. A Vendor's act of marking all or nearly all of its bid as exempt is not sufficient to avoid disclosure and WILL NOT BE HONORED. Vendor's act of marking a bid or any part thereof as "confidential" or "proprietary" is not sufficient to avoid disclosure and WILL NOT BE HONORED. A legend or other statement indicating that all or substantially all of the bid is exempt from disclosure is not sufficient to avoid disclosure and WILL NOT BE HONORED. Additionally, pricing or cost information will not be considered exempt from disclosure and requests to withhold publication of pricing or cost information WILL NOT BE HONORED.

Vendor will be required to defend any claimed exemption for nondisclosure in the event of an administrative or judicial challenge to the State's nondisclosure. Vendor must indemnify the State for any costs incurred related to any exemptions claimed by Vendor. Any questions regarding the applicability of the various public records laws should be addressed to your own legal counsel prior to bid submission.

31. LICENSING: In accordance with West Virginia Code of State Rules §148-1-6.1.7, Vendor must be licensed and in good standing in accordance with any and all state and local laws and requirements by any state or local agency of West Virginia, including, but not limited to, the West Virginia Secretary of State's Office, the West Virginia Tax Department, West Virginia Insurance Commission, or any other state agency or political subdivision. Upon request, the Vendor must provide all necessary releases to obtain information to enable the Purchasing Division Director or the Agency to verify that the Vendor is licensed and in good standing with the above entities.

- 32. ANTITRUST:** In submitting a bid to, signing a contract with, or accepting a Award Document from any agency of the State of West Virginia, the Vendor agrees to convey, sell, assign, or transfer to the State of West Virginia all rights, title, and interest in and to all causes of action it may now or hereafter acquire under the antitrust laws of the United States and the State of West Virginia for price fixing and/or unreasonable restraints of trade relating to the particular commodities or services purchased or acquired by the State of West Virginia. Such assignment shall be made and become effective at the time the purchasing agency tenders the initial payment to Vendor.
- 33. VENDOR CERTIFICATIONS:** By signing its bid or entering into this Contract, Vendor certifies (1) that its bid or offer was made without prior understanding, agreement, or connection with any corporation, firm, limited liability company, partnership, person or entity submitting a bid or offer for the same material, supplies, equipment or services; (2) that its bid or offer is in all respects fair and without collusion or fraud; (3) that this Contract is accepted or entered into without any prior understanding, agreement, or connection to any other entity that could be considered a violation of law; and (4) that it has reviewed this Solicitation in its entirety; understands the requirements, terms and conditions, and other information contained herein. Vendor's signature on its bid or offer also affirms that neither it nor its representatives have any interest, nor shall acquire any interest, direct or indirect, which would compromise the performance of its services hereunder. Any such interests shall be promptly presented in detail to the Agency. The individual signing this bid or offer on behalf of Vendor certifies that he or she is authorized by the Vendor to execute this bid or offer or any documents related thereto on Vendor's behalf; that he or she is authorized to bind the Vendor in a contractual relationship; and that, to the best of his or her knowledge, the Vendor has properly registered with any State agency that may require registration.
- 34. PURCHASING CARD ACCEPTANCE:** The State of West Virginia currently utilizes a Purchasing Card program, administered under contract by a banking institution, to process payment for goods and services. The Vendor must accept the State of West Virginia's Purchasing Card for payment of all orders under this Contract unless the box below is checked.
- Vendor is not required to accept the State of West Virginia's Purchasing Card as payment for all goods and services.
- 35. VENDOR RELATIONSHIP:** The relationship of the Vendor to the State shall be that of an independent contractor and no principal-agent relationship or employer-employee relationship is contemplated or created by this Contract. The Vendor as an independent contractor is solely liable for the acts and omissions of its employees and agents. Vendor shall be responsible for selecting, supervising, and compensating any and all individuals employed pursuant to the terms of this Solicitation and resulting contract. Neither the Vendor, nor any employees or subcontractors of the Vendor, shall be deemed to be employees of the State for any purpose whatsoever. Vendor shall be exclusively responsible for payment of employees and contractors for all wages and salaries, taxes, withholding payments, penalties, fees, fringe benefits, professional liability insurance premiums, contributions to insurance and pension, or other deferred compensation plans, including but

not limited to, Workers' Compensation and Social Security obligations, licensing fees, etc. and the filing of all necessary documents, forms, and returns pertinent to all of the foregoing. Vendor shall hold harmless the State, and shall provide the State and Agency with a defense against any and all claims including, but not limited to, the foregoing payments, withholdings, contributions, taxes, Social Security taxes, and employer income tax returns.

- 36. INDEMNIFICATION:** The Vendor agrees to indemnify, defend, and hold harmless the State and the Agency, their officers, and employees from and against: (1) Any claims or losses for services rendered by any subcontractor, person, or firm performing or supplying services, materials, or supplies in connection with the performance of the Contract; (2) Any claims or losses resulting to any person or entity injured or damaged by the Vendor, its officers, employees, or subcontractors by the publication, translation, reproduction, delivery, performance, use, or disposition of any data used under the Contract in a manner not authorized by the Contract, or by Federal or State statutes or regulations; and (3) Any failure of the Vendor, its officers, employees, or subcontractors to observe State and Federal laws including, but not limited to, labor and wage and hour laws.
- 37. PURCHASING AFFIDAVIT:** In accordance with West Virginia Code § 5A-3-10a, all Vendors are required to sign, notarize, and submit the Purchasing Affidavit stating that neither the Vendor nor a related party owe a debt to the State in excess of \$1,000. The affidavit must be submitted prior to award, but should be submitted with the Vendor's bid. A copy of the Purchasing Affidavit is included herewith.
- 38. ADDITIONAL AGENCY AND LOCAL GOVERNMENT USE:** This Contract may be utilized by and extends to other agencies, spending units, and political subdivisions of the State of West Virginia; county, municipal, and other local government bodies; and school districts ("Other Government Entities"). This Contract shall be extended to the aforementioned Other Government Entities on the same prices, terms, and conditions as those offered and agreed to in this Contract. If the Vendor does not wish to extend the prices, terms, and conditions of its bid and subsequent contract to the Other Government Entities, the Vendor must clearly indicate such refusal in its bid. A refusal to extend this Contract to the Other Government Entities shall not impact or influence the award of this Contract in any manner.
- 39. CONFLICT OF INTEREST:** Vendor, its officers or members or employees, shall not presently have or acquire an interest, direct or indirect, which would conflict with or compromise the performance of its obligations hereunder. Vendor shall periodically inquire of its officers, members and employees to ensure that a conflict of interest does not arise. Any conflict of interest discovered shall be promptly presented in detail to the Agency.
- 40. REPORTS:** Vendor shall provide the Agency and/or the Purchasing Division with the following reports identified by a checked box below:
- Such reports as the Agency and/or the Purchasing Division may request. Requested reports may include, but are not limited to, quantities purchased, agencies utilizing the contract, total contract expenditures by agency, etc.

- Quarterly reports detailing the total quantity of purchases in units and dollars, along with a listing of purchases by agency. Quarterly reports should be delivered to the Purchasing Division via email at purchasing_requisitions@wv.gov.

41. BACKGROUND CHECK: In accordance with W. Va. Code § 15-2D-3, the Director of the Division of Protective Services shall require any service provider whose employees are regularly employed on the grounds or in the buildings of the Capitol complex or who have access to sensitive or critical information to submit to a fingerprint-based state and federal background inquiry through the state repository. The service provider is responsible for any costs associated with the fingerprint-based state and federal background inquiry.

After the contract for such services has been approved, but before any such employees are permitted to be on the grounds or in the buildings of the Capitol complex or have access to sensitive or critical information, the service provider shall submit a list of all persons who will be physically present and working at the Capitol complex to the Director of the Division of Protective Services for purposes of verifying compliance with this provision.

The State reserves the right to prohibit a service provider's employees from accessing sensitive or critical information or to be present at the Capitol complex based upon results addressed from a criminal background check.

Service providers should contact the West Virginia Division of Protective Services by phone at (304) 558-9911 for more information.

42. PREFERENCE FOR USE OF DOMESTIC STEEL PRODUCTS: Except when authorized by the Director of the Purchasing Division pursuant to W. Va. Code § 5A-3-56, no contractor may use or supply steel products for a State Contract Project other than those steel products made in the United States. A contractor who uses steel products in violation of this section may be subject to civil penalties pursuant to W. Va. Code § 5A-3-56. As used in this section:

- a. "State Contract Project" means any erection or construction of, or any addition to, alteration of or other improvement to any building or structure, including, but not limited to, roads or highways, or the installation of any heating or cooling or ventilating plants or other equipment, or the supply of and materials for such projects, pursuant to a contract with the State of West Virginia for which bids were solicited on or after June 6, 2001.
- b. "Steel Products" means products rolled, formed, shaped, drawn, extruded, forged, cast, fabricated or otherwise similarly processed, or processed by a combination of two or more or such operations, from steel made by the open hearth, basic oxygen, electric furnace, Bessemer or other steel making process. The Purchasing Division Director may, in writing, authorize the use of foreign steel products if:
- c. The cost for each contract item used does not exceed one tenth of one percent (.1%) of the total contract cost or two thousand five hundred dollars (\$2,500.00), whichever is greater.

For the purposes of this section, the cost is the value of the steel product as delivered to the project; or

- d. The Director of the Purchasing Division determines that specified steel materials are not produced in the United States in sufficient quantity or otherwise are not reasonably available to meet contract requirements.

43. PREFERENCE FOR USE OF DOMESTIC ALUMINUM, GLASS, AND STEEL: In Accordance with W. Va. Code § 5-19-1 et seq., and W. Va. CSR § 148-10-1 et seq., for every contract or subcontract, subject to the limitations contained herein, for the construction, reconstruction, alteration, repair, improvement or maintenance of public works or for the purchase of any item of machinery or equipment to be used at sites of public works, only domestic aluminum, glass or steel products shall be supplied unless the spending officer determines, in writing, after the receipt of offers or bids, (1) that the cost of domestic aluminum, glass or steel products is unreasonable or inconsistent with the public interest of the State of West Virginia, (2) that domestic aluminum, glass or steel products are not produced in sufficient quantities to meet the contract requirements, or (3) the available domestic aluminum, glass, or steel do not meet the contract specifications. This provision only applies to public works contracts awarded in an amount more than fifty thousand dollars (\$50,000) or public works contracts that require more than ten thousand pounds of steel products.

The cost of domestic aluminum, glass, or steel products may be unreasonable if the cost is more than twenty percent (20%) of the bid or offered price for foreign made aluminum, glass, or steel products. If the domestic aluminum, glass or steel products to be supplied or produced in a "substantial labor surplus area", as defined by the United States Department of Labor, the cost of domestic aluminum, glass, or steel products may be unreasonable if the cost is more than thirty percent (30%) of the bid or offered price for foreign made aluminum, glass, or steel products.

This preference shall be applied to an item of machinery or equipment, as indicated above, when the item is a single unit of equipment or machinery manufactured primarily of aluminum, glass or steel, is part of a public works contract and has the sole purpose or of being a permanent part of a single public works project. This provision does not apply to equipment or machinery purchased by a spending unit for use by that spending unit and not as part of a single public works project.

All bids and offers including domestic aluminum, glass or steel products that exceed bid or offer prices including foreign aluminum, glass or steel products after application of the preferences provided in this provision may be reduced to a price equal to or lower than the lowest bid or offer price for foreign aluminum, glass or steel products plus the applicable preference. If the reduced bid or offer prices are made in writing and supersede the prior bid or offer prices, all bids or offers, including the reduced bid or offer prices, will be reevaluated in accordance with this rule.

CERTIFICATION AND SIGNATURE PAGE

By signing below, or submitting documentation through wvOASIS, I certify that I have reviewed this Solicitation in its entirety; understand the requirements, terms and conditions, and other information contained herein; that I am submitting this bid, offer or proposal for review and consideration; that I am authorized by the vendor to execute and submit this bid, offer, or proposal, or any documents related thereto on vendor's behalf; that I am authorized to bind the vendor in a contractual relationship; and that to the best of my knowledge, the vendor has properly registered with any State agency that may require registration.

Bulldog Rock Co
(Company)

 VON KUEPP Pres.
(Authorized Signature) (Representative Name, Title)

304-7486401 304 727-7205 5-11-15
(Phone Number) (Fax Number) (Date)

ADDENDUM ACKNOWLEDGEMENT FORM
SOLICITATION NO.: CRFQ DOT1500000086

Instructions: Please acknowledge receipt of all addenda issued with this solicitation by completing this addendum acknowledgment form. Check the box next to each addendum received and sign below. Failure to acknowledge addenda may result in bid disqualification.

Acknowledgment: I hereby acknowledge receipt of the following addenda and have made the necessary revisions to my proposal, plans and/or specification, etc.

Addendum Numbers Received:
(Check the box next to each addendum received)

- | | |
|---|--|
| <input type="checkbox"/> Addendum No. 1 | <input type="checkbox"/> Addendum No. 6 |
| <input type="checkbox"/> Addendum No. 2 | <input type="checkbox"/> Addendum No. 7 |
| <input type="checkbox"/> Addendum No. 3 | <input type="checkbox"/> Addendum No. 8 |
| <input type="checkbox"/> Addendum No. 4 | <input type="checkbox"/> Addendum No. 9 |
| <input type="checkbox"/> Addendum No. 5 | <input type="checkbox"/> Addendum No. 10 |

I understand that failure to confirm the receipt of addenda may be cause for rejection of this bid. I further understand that any verbal representation made or assumed to be made during any oral discussion held between Vendor's representatives and any state personnel is not binding. Only the information issued in writing and added to the specifications by an official addendum is binding.

Company

Authorized Signature

Date

NOTE: This addendum acknowledgment should be submitted with the bid to expedite document processing.

REQUEST FOR QUOTATION
Structural Steel Beams for Piling

SPECIFICATIONS

1. **PURPOSE AND SCOPE:** The West Virginia Purchasing Division is soliciting bids on behalf of the Division of Highways to establish a contract for the one time purchase of HP-10x42 and W-8x21 structural steel beams for piling.
2. **DEFINITIONS:** The terms listed below shall have the meanings assigned to them below. Additional definitions can be found in section 2 of the General Terms and Conditions.
 - 2.1 **“Contract Item”** means structural steel beams as more fully described by these specifications.
 - 2.2 **“Pricing Page”** means the pages, contained in wvOASIS or attached as Exhibit A, upon which Vendor should list its proposed price for the Contract Items.
 - 2.3 **“Solicitation”** means the official notice of an opportunity to supply the State with goods or services that is published by the Purchasing Division..

3. **GENERAL REQUIREMENTS:**

The specifications of this RFQ and/or any WVDOH standards referenced in and/or attached to this RFQ may include references to specific recognized “industry standard” specifications which are issued by third parties, such as the American Society for Testing and Materials (ASTM) and the American Association of State and Highway Transportation Officials (AASHTO). Such specifications are protected by strict copyright restrictions and cannot be published as part of this RFQ. The ability to access such specifications shall be considered a mandatory requirement for participation in the RFQ process as a Vendor or as a supplier to the Vendor, as applicable.

- 3.1 **Mandatory Contract Item Requirements:** Contract Item must meet or exceed the mandatory requirements listed below.

3.1.1 275,520 pounds of HP-10 x 42 structural steel beam.

3.1.1.1 HP-10 x 42 structural steel beam must be 144 pieces each 30 feet long and 56 pieces each 40 foot long.

3.1.1.2 HP-10 x 42 structural steel beam must be in accordance

REQUEST FOR QUOTATION
Structural Steel Beams for Piling

with West Virginia Dept. of Transportation, Division of Highways Standard Specification Roads and Bridges section 709.12 dated 2010 and the current Supplemental Specifications. Specifications are attached as "Exhibit B".

3.1.2 21,000 pounds of W-8 x 21 structural steel beam

3.1.2.1 W-8 x 21 structural steel beam must be 50 pieces each 20 feet long.

3.1.2.2 W-8 x 21 structural steel beam must be in accordance with West Virginia Dept. of Transportation, Division of Highways Standard Specification Roads and Bridges section 709.12 dated 2010 and the current Supplemental Specifications. Specifications are attached as "Exhibit B".

4. CONTRACT AWARD:

4.1 Contract Award: The Contract is intended to provide Agencies with a purchase price for the Contract Items. The Contract shall be awarded to the Vendor that provides the Contract Items meeting the required specifications for the lowest overall total cost as shown on the Pricing Pages.

4.2 Pricing Page: Vendor should complete the Pricing Page by listing price per pound of each line item requested, extended amount for each item, and grand total. Vendor should complete the Pricing Page in full as failure to complete the Pricing Page in its entirety may result in Vendor's bid being disqualified.

Vendor should type or electronically enter the information into the Pricing Page to prevent errors in the evaluation.

5. PAYMENT:

5.1 Payment: Vendor shall accept payment in accordance with the payment procedures of the State of West Virginia.

REQUEST FOR QUOTATION
Structural Steel Beams for Piling

6. DELIVERY AND RETURN:

- 6.1 Shipment and Delivery:** Vendor shall ship the Contract Items immediately after being awarded this Contract and receiving a purchase order or notice to proceed. Vendor shall deliver the Contract Items within 45 working days after receiving a purchase order or notice to proceed. Contract Items must be delivered to Agency at:

WV Division of Highways
District 7 Storage Yard
1205 US Highway 19 S
Weston, WV 26452

- 6.2 Late Delivery:** The Agency placing the order under this Contract must be notified in writing if the shipment of the Contract Items will be delayed for any reason. Any delay in delivery that could cause harm to an Agency will be grounds for cancellation of the Contract, and/or obtaining the Contract Items from a third party.

Any Agency seeking to obtain the Contract Items from a third party under this provision must first obtain approval of the Purchasing Division.

- 6.3 Delivery Payment/Risk of Loss:** Vendor shall deliver the Contract Items F.O.B. destination to the Agency's location.
- 6.4 Return of Unacceptable Items:** If the Agency deems the Contract Items to be unacceptable, the Contract Items shall be returned to Vendor at Vendor's expense and with no restocking charge. Vendor shall either make arrangements for the return within five (5) days of being notified that items are unacceptable, or permit the Agency to arrange for the return and reimburse Agency for delivery expenses. If the original packaging cannot be utilized for the return, Vendor will supply the Agency with appropriate return packaging upon request. All returns of unacceptable items shall be F.O.B. the Agency's location. The returned product shall either be replaced, or the Agency shall receive a full credit or refund for the purchase price, at the Agency's discretion.
- 6.5 Return Due to Agency Error:** Items ordered in error by the Agency will be returned for credit within 30 days of receipt, F.O.B. Vendor's location. Vendor shall not charge a restocking fee if returned products are in a resalable condition. Items shall be deemed to be in a resalable condition if they are unused and in the original packaging. Any restocking fee for items not in a resalable condition shall

REQUEST FOR QUOTATION
Structural Steel Beams for Piling

be the lower of the Vendor's customary restocking fee or 5% of the total invoiced value of the returned items.

7 VENDOR DEFAULT:

7.1 The following shall be considered a vendor default under this Contract.

7.1.1 Failure to provide Contract Items in accordance with the requirements contained herein.

7.1.2 Failure to comply with other specifications and requirements contained herein.

7.1.3 Failure to comply with any laws, rules, and ordinances applicable to the Contract Services provided under this Contract.

7.1.4 Failure to remedy deficient performance upon request.

7.2 The following remedies shall be available to Agency upon default.

7.2.1 Immediate cancellation of the Contract.

7.2.2 Immediate cancellation of one or more release orders issued under this Contract.

7.2.3 Any other remedies available in law or equity.

709.8-HIGH STRENGTH LOW ALLOY STRUCTURAL METAL:

High-strength structural steel for bridges shall conform to AASHTO M270, grades 50, 50W, or HPS 70W. High-strength steel for all other applications shall conform to AASHTO M222 (weathering) or AASHTO M223.

709.9-BLANK**709.10-GRAY IRON, MALLEABLE IRON AND DUCTILE IRON CASTINGS:**

Gray iron castings shall conform to the requirements of AASHTO M 105, Class No. 30.

Malleable iron castings shall conform to the requirements of ASTM A 47, Grade 32510. Castings shall be boldly filleted at angles, and the arrises shall be sharp and perfect.

Malleable iron castings for railings posts shall be Grade No. 32510 and shall be galvanized with hot-dipped zinc coating in accordance with AASHTO M 232.

Ductile iron castings shall conform to the requirements of ASTM A-536, Grade 80-55-6, 65-45-12 or 60-40-18.

The dimension tolerance for gray iron castings is $\pm 1/16$ inch per foot (5.2 mm per meter) and the weight tolerance is $\pm 5\%$.

All castings shall contain a manufacturer's heat number, lot number, or cast date. This identification shall be cast into the material at the time of manufacturer.

709.11-BLANK**709.12-STRUCTURAL AND EYEBAR STEEL:**

All structural steel for bridges shall conform to the applicable grade of AASHTO M270 that is specified in the Plans. When no specific grade is called for, AASHTO M270, Grade 36 shall be used. Non-designated structural steel in all other sections of the Specifications shall conform to ASTM A36.

709.13-STEEL FORGINGS AND STEEL SHAFTING:

709.13.1-Steel Forgings: Steel forgings shall conform to AASHTO M 102, Class E. They shall be bored as specified in 615.4.9.2. A record of the annealing or normalizing changes shall be furnished showing the forgings in such charge, the melt or melts from which they were secured and the treatment they received.

709.13.2-Steel Shafting: Cold finished carbon steel shafting shall conform to AASHTO M169 Grades 1016 through 1030, inclusive, unless otherwise specified.

709.14-STEEL CASTINGS:

Steel castings shall conform to the requirements of AASHTO M 103, except steel produced by the converter process shall not be used. All steel castings shall be grade 65-35 (450-240). Sharp unfilleted angles or corners shall not be permitted.

WEST VIRGINIA
DEPARTMENT OF TRANSPORTATION
DIVISION OF HIGHWAYS
PLANS FOR CONSTRUCTION
OF
SIMS RUN MULTIPIPE REPLACEMENT

STATE PROJECT NO. SS21-119/7-0.01
COUNTY ROUTE NO. 119/7
COURT HOUSE DISTRICT
LEWIS COUNTY

	Station	Station	ft.	miles
Roadway	0+00.00	to 0+52.53	52.53	0.010
Bridge	0+52.53	to 0+83.67	31.14	0.008
Roadway	0+83.67	to 1+25.00	41.33	0.008
Total Project Length			125.00	0.024

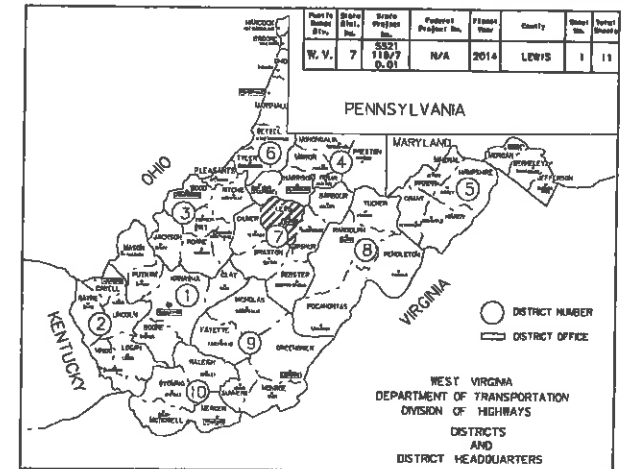

TYPE OF CONSTRUCTION

BRIDGE CONSTRUCTION
BRIDGE REPLACEMENT 11178

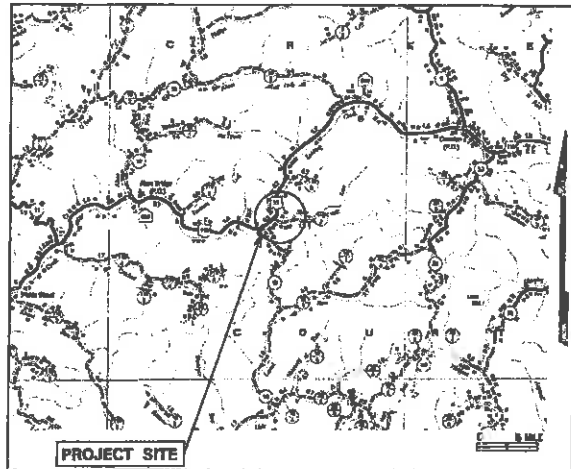

UTILITIES

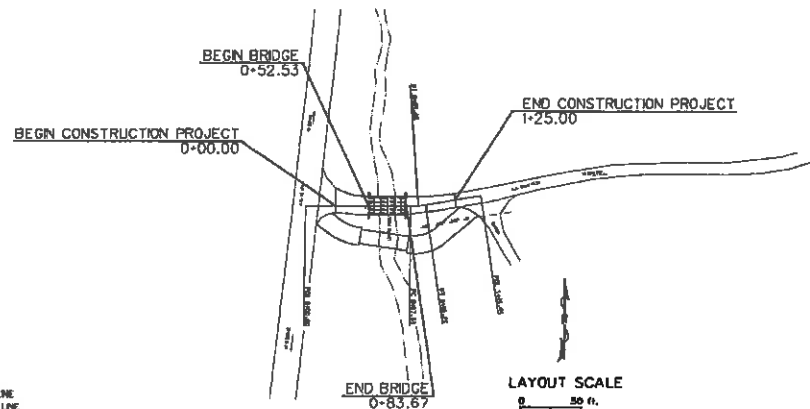

DESIGNED BY:	PMR	8-13
DRAWN BY:	PMR	8-13
CHECKED BY:	PDS	12-13
REVIEWED BY:	BRW	01-14

DESIGN DESIGNATION	
A. D. T. (2012)	10
A. D. T. (2012)	12
D. H. V.	N/A
D.	N/A
T.	N/A
V.	25 MPH

CONVENTIONAL SIGNS	
	STATE LINE
	COUNTY LINE
	CORPORATION LINE
	PROPOSED R/W & EASEMENT LINE
	EXISTING R/W LINE
	PROPERTY LINE
	EXISTING FENCE
	PROPOSED FENCE
	EDGE OF STREAM
	PROPOSED GUARD RAIL
	EXISTING GUARD RAIL
	RAILROAD
	GAS LINE
	WATER LINE
	TELEPHONE LINE
	EXISTING LINE
	TELEPHONE POLE
	POWER POLE
	COMBINED POWER AND TELEPHONE POLE
	TREE
	SHRUB
	RIGHT OF WAY MARKER

NO.	DESCRIPTION
1	TITLE SHEET
2	GENERAL NOTES
3	EXISTING ELEVATION & DECK SECTION, SCOPE OF WORK, & ESTIMATE OF QUANTITIES
4	R/W AND UTILITY INDEX
5	PROJECT PLAN VIEW, GEOMETRIC LAYOUT, END SURVEY REFERENCE POINTS
6	R/W PROPERTY MAP
7	PROFILES, & TYPICAL SECTIONS
8	PROPOSED BRIDGE PLAN VIEW, STEEL LAYOUT & PROPOSED DECK SECTION
9	ELEVATION VIEW, HYDRAULIC DATA, ABUTMENT CAP DETAILS, & DIAPHRAGM DETAILS
10	DECK AND CURB DETAILS
11	ROAD CROSS SECTIONS

NO.	DATE	BY	REVISIONS

I HEREBY CERTIFY THAT THIS IS A CORRECT COPY OF THE PLANS OF PROJECT SS21-119/7-0.01
Richard White
 PROJECT ENGINEER
 11.20.14

DESIGNED: *Richard White*
 RESPONSIBLE ENGINEER
 DATE: 2/3/14

NOTES: STANDARD DETAIL BOOK VOL. I DATED JANUARY 1, 2000 & VOLUME I DATED JANUARY 1, 1994, SHALL APPLY TO THIS PROJECT.

RECOMMENDED FOR APPROVAL
Paul D. Matlock
 STATE HIGHWAY ENGINEER
 APPROVED
Paul D. Matlock
 CHIEF ENGINEER OF DISTRICT

PROJECT NO. SS21-119/7-0.01

GOVERNING SPECIFICATIONS

The governing provisions applicable to this project are the West Virginia Department of Highways Standard Specifications, Roads and Bridges, adopted 2000, as amended by the current Supplemental Specifications of the West Virginia Department of Highways, the contract plans and the contract documents.

Current Supplemental Specifications shall be the Specifications in effect on the first day of project advertisement for bidding to contract.

DESIGN-NEW STRUCTURES

This bridge is designed for a W_{16} live load capacity, as well as for a 25 p.s.f. wearing surface. Design Unit Weight: Reinforcing Steel = 2,500 p.s.f. Class B Concrete = 3,000 p.s.f. Structural Steel (A36) = 200 KSI Class B Concrete = 1,200 p.s.f. Structural Steel (A572) = 49,000 p.s.f. Class B Concrete = 4,500 KSI

DESIGN-REHABILITATION AND STRENGTHENING

This bridge is strengthened for a live load capacity of W_{16} . Strengthening standard design stress = 100 p.s.f. All structural steel shall be ASTM A36 unless otherwise designated on the construction plans.

CONCRETE (CAST-IN-PLACE)

Concrete shall be cured in accordance with Subsection 601.12 of the Standard Specifications. It is noted that the concrete shall conform to the requirements of Subsection 601.12 of the Standard Specifications. The minimum curing, measured from the surface of the concrete, by the use of any retarding seal or other means, shall be in accordance with the provisions of Subsection 601.12 of the Standard Specifications.

SUBSTRUCTURE CONCRETE (CAST-IN-PLACE)

Reinforce in the substructure shall be Class B, as specified. All concrete for decks, curbs, parapets or structures shall be Class C, as specified. All concrete for decks, curbs, parapets or structures shall be Class C, as specified. All concrete for decks, curbs, parapets or structures shall be Class C, as specified. All concrete for decks, curbs, parapets or structures shall be Class C, as specified.

SUBSTRUCTURE CONCRETE (CAST-IN-PLACE)

All concrete in the superstructure shall be Class C, as specified. All concrete for decks, curbs, parapets or structures shall be Class C, as specified. All concrete for decks, curbs, parapets or structures shall be Class C, as specified.

REINFORCING STEEL BARS

All reinforcing steel bars shall be intermediate grade mild steel, Grade 40 or 60 in accordance with Subsection 701.1 of the Standard Specifications. The requirements of Section 602 of the Standard Specifications shall be followed. The minimum clear height or down bar embedment shall be 20 bar diameters.

STRUCTURE EXCAVATION (FOOTINGS FOUNDED IN ROCK)

Structure excavation quantities through rock shall be measured from the top of the rock in the original ground line. If holes are drilled, the hole shall be measured to the bottom of the hole. Excavation shall be classified as wet or rock excavation. Rock shall be drilled and grouted to an extent determined by the rock mass of the footings only. Rock shall be excavated until a level surface is provided with the entire footing resting on a level rock.

STEEL TOUGHNESS REQUIREMENT

The provisions of the AASHTO Specifications in accordance with Article 615.1A of the Standard Specifications shall apply to those bars of structural steel as shown and designated by these plans.

PAINTING (NEW STRUCTURES)

Shop and field painting shall be in accordance with Section 616 of the current Standard Specifications and the Special Provisions.

Paint system shall consist of one shop prime coat, one field prime coat and two field finish coats. Shop Prime Coat: One complete coat of vinyl shop primer conforming to the requirements of Subsection 711.7 of the Standard Specifications. This will replace the shop paint specified in Subsection 616.3.1 of the Standard Specifications. Field Prime Coat: One complete coat of brushable primer conforming to the requirements of Subsection 711.7 of the Standard Specifications. Dry film thickness shall be a minimum of two (2) mils.

Paint system shall consist of shop prime coat, intermediate field fog coat and finish topcoat. Field painting shall also include touch-up and repair of prime paint. Field system shall be the inorganic zinc rich system meeting the requirements of Section 711.7 of the Standard Specifications. Shop Prime Coat: One complete coat of brushable primer conforming to the requirements of Subsection 711.7 of the Standard Specifications. The color shall be in accordance with Federal Standard 595, number 3. Dry film thickness shall be a minimum of two (2) mils.

Paint system shall consist of application of shop prime coat and field touch-up and repair of prime coat. Field system shall be the inorganic zinc rich primer meeting the requirements of Subsection 711.7 of the Standard Specifications. Dry film thickness shall be a minimum of two (2) mils.

CLEANING AND PAINTING (EXISTING STRUCTURES)

Shop and field painting shall be in accordance with other portions of the Standard Specifications and the Special Provisions. When it is determined that the structure contains an environmentally sensitive paint system then section 616.3 shall be applied. The portions of the structure not specified shall be cleaned in accordance with Subsection 616.3.1. It is not intended that sand, silt or dirt be removed unless it is necessary to clean or inhibit.

Attention is called to the requirements of paragraph 2 of Section 602.6 which requires that edges of paint be properly feathered to produce a smooth appearance. In the event that there is a difference of opinion as to which area must be sandblasted or hand cleaned or in the event of surface damage or surface preparation, the decision of the Engineer shall be final. Shop painting of steel surfaces shall be in accordance with the requirements of Section 616.3 of the Standard Specifications. The color shall be in accordance with Federal Standard 595, number 3.

Attention is called to the requirements of paragraph 2 of Section 602.6 which requires that edges of paint be properly feathered to produce a smooth appearance. In the event that there is a difference of opinion as to which area must be sandblasted or hand cleaned or in the event of surface damage or surface preparation, the decision of the Engineer shall be final. Shop painting of steel surfaces shall be in accordance with the requirements of Section 616.3 of the Standard Specifications. The color shall be in accordance with Federal Standard 595, number 3.

STRUCTURE EXCAVATION (FOOTINGS FOUNDED ON PILES)

Structure excavation quantities through earth fill shall be measured from the bottom of the footing to the original ground line, 6 inches outside the cast line of the footings. No excavation will be classified as wet or rock excavation.

PREFORMED ELASTOMERIC JOINT SEALER

The preformed elastomeric joint sealer shall conform to the requirements of Section 616 of the Standard Specifications.

BRIDGE GUARDRAIL

The guardrail, buffer and terminal sections, posts and end anchors shall conform to the requirements as set forth by the West Virginia Department of Highways Standard Details Book Standard Sheet G.11 through G.23, as applicable and Standard Specification Plan Sheet BR-01. Posts are required. End anchors shall be in accordance with Section 612.2 of the Standard Specifications. Hardware will be hot-dip galvanized after fabrication. Thrusts shall be replaced to ensure proper guardrail posts may be square or rounded.

STRUCTURAL STEEL

All structural steel shall conform to the requirements of ASTM A36 (or 20,000 p.s.f.) unless otherwise noted. For approximate welding steel grid flooring, structural steel conforming to the requirements of ASTM A36 (or 27,000 p.s.f.) may be substituted for ASTM A36 steel. No painting shall be required for ASTM A36 steel.

STEEL GRID FLOORING (CONCRETE FILLED TYPE)

The steel grid flooring shall conform to all applicable requirements of Section 621 of the current Standard Specifications under all Special Provisions of the West Virginia Department of Highways. The grid shall conform to all applicable requirements as set forth by the Bridge Grid Flooring Manufacturers Association. Size and type shall be as specified on the plans.

Attention is called to the requirements of paragraph 2 of Section 602.6 which requires that edges of paint be properly feathered to produce a smooth appearance. In the event that there is a difference of opinion as to which area must be sandblasted or hand cleaned or in the event of surface damage or surface preparation, the decision of the Engineer shall be final. Shop painting of steel surfaces shall be in accordance with the requirements of Section 616.3 of the Standard Specifications. The color shall be in accordance with Federal Standard 595, number 3.

STEEL GRID FLOORING (OPEN TYPE)

The steel grid flooring shall conform to all applicable requirements of Section 621 of the current Standard Specifications under all Special Provisions of the West Virginia Department of Highways. The grid shall conform to all applicable requirements as set forth by the Bridge Grid Flooring Manufacturers Association. Size and type shall be as specified on the plans.

Attention is called to the requirements of paragraph 2 of Section 602.6 which requires that edges of paint be properly feathered to produce a smooth appearance. In the event that there is a difference of opinion as to which area must be sandblasted or hand cleaned or in the event of surface damage or surface preparation, the decision of the Engineer shall be final. Shop painting of steel surfaces shall be in accordance with the requirements of Section 616.3 of the Standard Specifications. The color shall be in accordance with Federal Standard 595, number 3.

MAINTAINING TRAFFIC

Trucks shall be maintained in accordance with Section 636 and Subsection 704.5 of the Standard Specifications.

Table with 5 columns: PUBLIC ROAD DIST., STATE R.T. NO., PROJECT NUMBER, COUNTY, SHEET NO., TOTAL SHEETS. Values: W.V.A., 7, S321-119/7-G-01, LEWIS, 2, 11.

NAIL LAMINATED WOOD DECK

The bridge lumber shall be surfaced four sides, pressure treated No. 2 Southern Pine or better Southern Pine as specified by current Grading rules for Southern Pine Lumber published by the General Timber Deck Notes.

The allowable bending stress shall not be less than 1200 p.s.f. and the allowable shearing stress shall not be less than 125 p.s.f.

This material shall be subject to fireproofing in accordance with the above specifications upon delivery. Material will be accepted in bundles when the shipment is accompanied by a certified, issued by a Department of Highways Materials Control, field and Testing Division certified inspector, showing that the lumber in the "white" meets the above requirements. When said certificate is not available, the material will be inspected by Department of Highways personnel at the delivery site and stacked and stored by the vendor, and a minimum retention as specified by the American Wood Preservative Association Standard C-2 shall be obtained.

Material and/or workmanship shall conform to the requirements of Subsection 700.1 of the Standard Specifications. Material shall be delivered in increments of 2,000 board feet or as directed by the Engineer. A minimum of 10 calendar days will be allowed for delivery following notification by the Engineer. The vendor shall notify the Engineer of any loading days prior to delivery of the material.

Under no circumstances may the vendor ship nor will the Department of Highways accept or pay for quantities of material in excess of the quantity stated on the purchase order, except upon advance approval of the Engineer. The inspection agency field hardware may be considered as prequalified. If a vendor desires inspection by responsible agencies other than those listed, advance approval must be obtained from the Director, Materials Control and Testing Division, 212 William Avenue, Charleston, West Virginia 25305. Qualified Lumber Inspection Agencies:

- McCallum Inspection Company Norfolk, Virginia
- Frostburg and Robertson, Inc. Richmond, Virginia
- A.W. Williams Inspection Company Mobile, Alabama
- Southern Pine Inspection Bureau New Orleans, Louisiana

PRESTRESSED CONCRETE SUPERSTRUCTURE

This is the appropriate Standard Plan sheet for design stresses, specifications or notes. Although these items are detailed for a particular project, they are intended to be used for similar types or shaped prestressed concrete beams may be furnished with the following modifications: a) Contractor shall submit proposed alternate with design computations for review and approval by the Department of Highways. b) Contractor must supply detailed construction plans showing all revisions and modifications as required by the use of alternate items for review and approval by the Department of Highways. c) Completion date of the project will not be extended due to any delay encountered in obtaining alternate items. d) The project cannot be started until the revised modified plans are approved by the Department of Highways.

These items are for Purchase Order Contract only.

THE WEST VIRGINIA DEPARTMENT OF TRANSPORTATION DIVISION OF HIGHWAYS-STRUCTURES

CONSTRUCTION PLANS OF LAUREL LICK PIPE BRIDGE REPLACEMENT ON C.R. 263 (SLS) OVER LAUREL LICK LEWIS COUNTY

NOTE SELECTION TABLE with columns CODE, YES, NO and rows 1 through 12.

CONTROL VALUE table with columns CODE, VALUE and rows A through G.

WEST VIRGINIA DEPARTMENT OF TRANSPORTATION DIVISION OF HIGHWAYS-STRUCTURES STANDARD BRIDGE PLANS GENERAL NOTES STANDARD SHEET BR-2A

GENERAL NOTES

Table with columns: DRAWING NO., DATE, SHEET NO., TOTAL SHEETS, BRIDGE NUMBER. Values: S321-119/7-G-01, 08-14, NONE, 2, 11, S321-119/7-G-01 (11/178).

Public Road Dist.	State Project No.	Federal Project No.	Fiscal Year	County	Sheet No.	Total Sheets
W. V.	7	SS21-119/7-0.01	N/A	2010	LEWIS	3 11

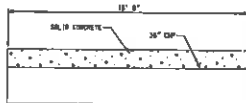

EXISTING DECK SECTION
NO SCALE

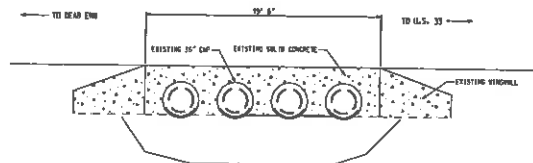

EXISTING ELEVATION VIEW
NO SCALE

#NOTE:
EXISTING STRUCTURE FAILED

SCOPE OF WORK

1. CONSTRUCT DETOUR AND RESET DETOUR BRIDGE.
2. EXCAVATE, DRIVE PILING, PLACE CAP BEAMS AND LAGGING PLATES.
3. PLACE FOUNDATION PROTECTION MATERIAL AROUND CAPS.
4. PLACE SUPERSTRUCTURE STEEL.
5. PLACE BACKWALL PLATES.
6. BACKFILL.
7. CONSTRUCT 2" X 6" DECK.
8. INSTALL CURBS.
9. CONSTRUCT APPROACH ROADWAY.
10. OPEN STRUCTURE TO TRAFFIC.
11. REMOVE DETOUR.
12. FINISH FOUNDATION PROTECTION MATERIAL.
13. SITE DRESS, SEED, & MULCH ALL DISTURBED AREAS.

ESTIMATE OF QUANTITIES			
PROJECT NO. SS21-119/7-0.01			
FOR INFORMATION ONLY			
DESCRIPTION	UNITS	NO. AND SIZE	TOTAL
DECK TIMBER	EA	2" X 6" X 16'	246
NAILS	LB	20 PENNY	86
#NAILING CLIPS	EA	7F-1 1/2"	155
#STRINGERS	LB	5-W10 X 100 X 31' 0"	15500
#PILING	LB	6-W12 X 65 X 20'	7800
#BEARING CAPS	LB	2-W12 X 65 X 21'	2730
#LAGGING PLATES	LB	2-4' X 3/4" X 21'	5145
#LAGGING SUPPORTS	LB	4-CB13.75X4"	220
#BACKWALL PLATES (SHOP CUT SLOPED ENDS)	LB	2-1' 2 3/4" X 3/4" X 21'	1313.1
#DIAPHRAGM ASSEMBLIES	EA	W/OUT AND WASHER	919.1
#3/4" X 2" HIGH STRENGTH BOLTS	EA	W/OUT AND WASHER	75
1/2" DIA X 18" CURB BOLTS	EA	6"X6"X12"	4
CURB	EA	6"X6"X16"	1
SCUPPER BLOCKS	EA	6"X4"X1'6"	6
FOUNDATION PROTECTION MATERIAL	CY		28
STONE	TON		60
DETOUR STONE	TON		102
TEMPORARY PIPE	LF	15" CORRUG. POLYETHYLENE	40

* -ALL STRUCTURAL STEEL SHALL CONFORM TO THE REQUIREMENTS OF ASTM A572 GRADE 50 AND SHALL BE HOT DIPPED GALVANIZED. GALVANIZING SHALL CONFORM TO ASTM A123 EXCEPT BOLTS AND NUTS WHICH SHALL CONFORM TO ASTM A153.

DESIGNED BY:	FRW	6-13						THE WEST VIRGINIA DEPARTMENT OF TRANSPORTATION DIVISION OF HIGHWAYS EXISTING ELEVATION AND END VIEW, ESTIMATE OF QUANTITIES, AND SCOPE OF WORK.
DRAWN BY:	FRW	9-13						
CHECKED BY:	PDS	12-13						
REVIEWED BY:	FRW	02-14	REVISION NUMBER	SHEET NUMBER	REVISION	DATE	BY	

Paralle Roads Div.	State Dist. No.	State Project No.	Federal Project No.	Fiscal Year	County	Sheet No.	Total Sheets
W. V.	7	SS21 119/7 0.01	N/A	2010	LEWIS	4	11

PARCEL NO.	TITLEHOLDER	RECORDED		TRACT #	ROW OWNERSHIP INDEX							REMARKS	R/W DEED RECORD			
		DEED BOOK	PAGE NO.		AREA - Acres (Unless noted otherwise)								TOTAL TAKEN	PARCEL TOTAL	DEED BOOK	PAGE NUMBER
					R/W	EASEMENT		REMAINING		TOTAL						
					TYPE	AREA	LEFT	RIGHT								
1	JEANNE DARLENE PIERCE AND DAVID S. PIERCE	647	174		T.C.E.	2005 S.F.			5.08	0.00	5.08					
2	JANI E. JONES	W.B. 29 557	208		T.C.E.	2041 S.F.			8.52	0.00	8.52					
3	STATE OF WEST VIRGINIA, DEPARTMENT OF COMMERCE, DIVISION OF NATURAL RESOURCES, OFFICE OF LAND AND STREAMS				P.E.	407 S.F.				0.01						

UTILITIES TABLE			
STATION	SHEET	DESCRIPTION	DISPOSITION
		NO UTILITIES ENCOUNTERED	

DESIGNED BY:	RMW	6-13					
DRAWN BY:	RMW	9-13					
CHECKED BY:	POS	12-13					
REVIEWED BY:	WRW	01-14	REVISION	SHEET	REVISION	DATE	BY

THE WEST VIRGINIA DEPARTMENT OF TRANSPORTATION
 DIVISION OF HIGHWAYS
 RIGHT OF WAY OWNERSHIP INDEX
 AND UTILITY TABLE.

Public Road Div.	State Dist. No.	State Project No.	Federal Project No.	Fiscal Year	County	Sheet No.	Total Sheets
W. V.	7	SS21 119/7 0.01	N/A	2014	LEWIS	5	11

Sims Run
C.R. 119/7
Alignment Data

	STATION	NORTHING	EASTING
PDB PC	Element: Linear		
	0+00.00	10046.31	5051.74
	0+87.59	9973.75	5100.80
Tangent Direction: S 34°03'59" E			
Tangent Length: 87.59			
PC PI CC PT	Element: Circular		
	0+87.59	9973.75	5100.80
	0+93.45	9968.89	5104.08
		10015.76	5162.93
	0+99.29	9964.60	5108.08
Radius: 75.00			
Delta: 8°56'35" Left			
Degree of Curvature(Arc): 76°23'40"			
Length: 11.71			
Tangent: 5.87			
Chord: 11.69			
PT POE	Element: Linear		
	0+99.29	9964.60	5108.08
	1+46.44	9930.13	5140.24
Tangent Direction: S 43°00'34" E			
Tangent Length: 47.15			

POINT # 2
IRON ROD & CAP
EASTING =5214.0015
NORTHING =10113.7866
ELEVATION=1001.3966

JEANNE DARLENE PIERCE & DAVID S. PIERCE
D.B. 647, PG 124
W.B. 29, PG. 122
TAX MAP 36, PARCEL 24.5
5.80 AC.

POINT # 3
IRON ROD & CAP
EASTING =5209.2017
NORTHING =9887.7371
ELEVATION=1006.3803

JANI E. JONES
D.B. 557, PG 208
TAX MAP 36, PARCEL 24.3
8.52 AC.

POINT # 1
IRON ROD & CAP
EASTING =5000.0000
NORTHING =10000.0000
ELEVATION=1000.0000

KIMBERLY ANN RUSH
D.B. 647, PG 142
TAX MAP 36, PARCEL 24.2
1.203 AC.

EROSION AND SEDIMENT CONTROL PLAN NOTE
SILT FENCE SHALL BE PLACED ACCORDING TO PLAN. WHEN FOUNDATION PROTECTION MATERIAL IS PLACED, FENCE CAN BE REMOVED FROM DITCH. SILT FENCE TO BE INSTALLED BEFORE ANY SOIL DISTURBANCES AS PER WVDDH EROSION AND SEDIMENT CONTROL MANUAL AMENDED 9/1/2004.

DESIGNED BY:	RAW	6-13							
DRAWN BY:	RAW	6-13							
CHECKED BY:	POS	12-13							
REVIEWED BY:	WRW	01-14	REVISION	SHEET NUMBER	REVISION	DATE	BY		

THE WEST VIRGINIA DEPARTMENT OF TRANSPORTATION
DIVISION OF HIGHWAYS
PROJECT PLAN VIEW, GEOMETRIC LAYOUT,
AND SURVEY REFERENCE POINTS

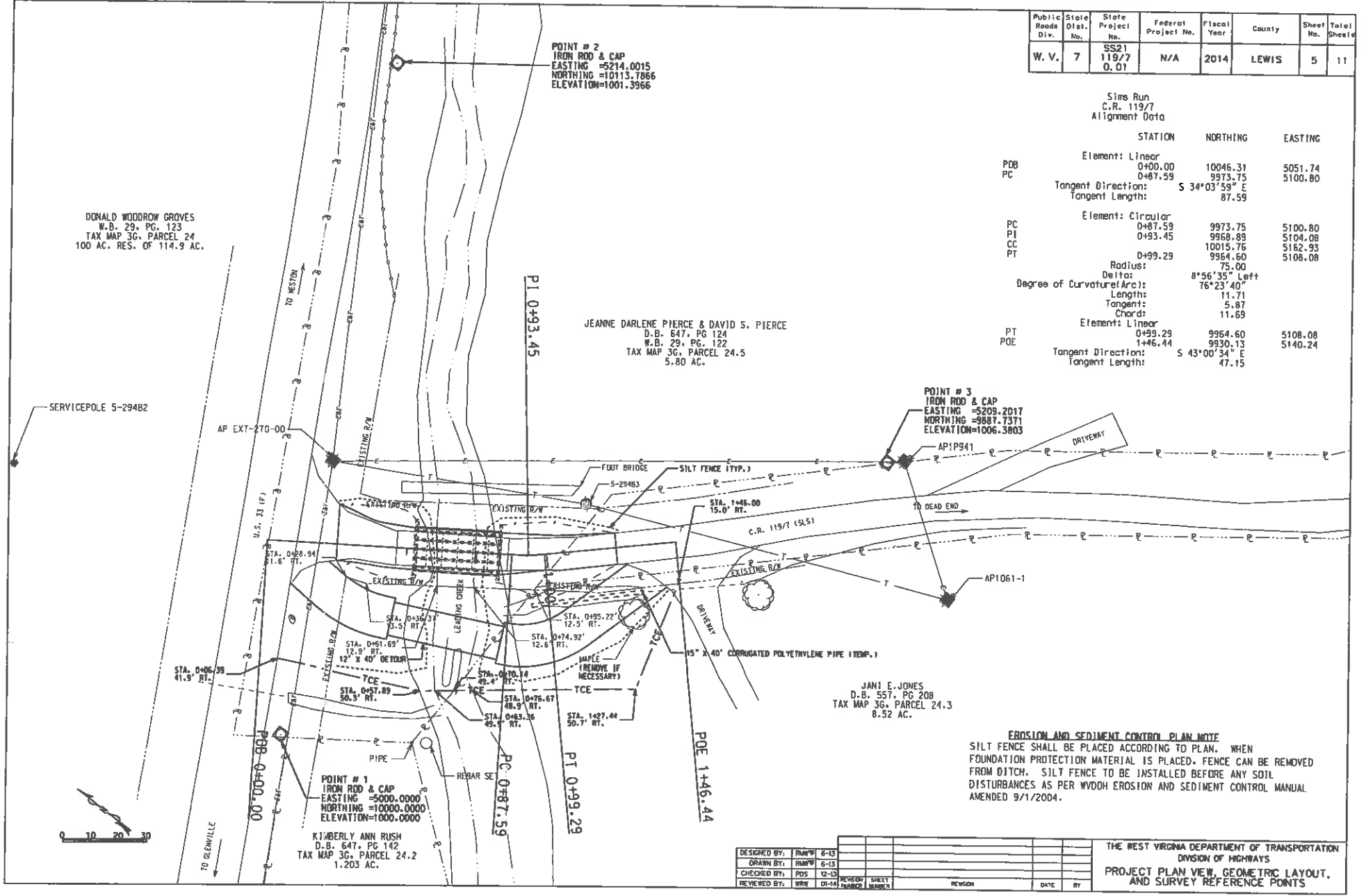

DONALD WOODROW GROVES
W.B. 29, PG. 123
TAX MAP 36, PARCEL 24
100 AC. RES. OF 114.9 AC.

SERVICEPOLE 5-29482

TO BLEWVILLE

TO WESTON

TO DEAD END

POE 1+46.44

PT 0+99.29

PC 0+87.59

PI 0+93.45

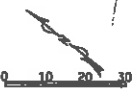

Public Roads Div.	State Dist. No.	State Project No.	Federal Project No.	Fiscal Year	County	Sheet No.	Total Sheets
W. V.	7	SS21 119/7 0.01	N/A	2014	LEWIS	5	11

Sims Run
C.R. 119/7
Alignment Data

	STATION	NORTHING	EASTING
Element: Linear	0+00.00	10046.31	5051.74
PC	0+87.59	9973.75	5100.80
Tangent Direction:	S 34°03'59" E		
Tangent Length:	87.59		
Element: Circular	0+87.59	9973.75	5100.80
PJ	0+93.45	9968.89	5104.08
CC		10075.76	5162.93
PT	0+99.29	9964.60	5108.08
Radius:	75.00		
Delta:	8°56'35" Left		
Degree of Curvature(Arc):	76°23'40"		
Length:	11.71		
Tangent:	5.87		
Chord:	11.69		
Element: Linear	0+99.29	9964.60	5108.08
PT	0+99.29	9930.13	5140.24
POE	1+46.44		
Tangent Direction:	S 43°00'34" E		
Tangent Length:	47.15		

POINT # 2
IRON ROD & CAP
EASTING =5214.0015
NORTHING =10113.7866
ELEVATION=1001.3966

JEANNE DARLENE PIERCE & DAVID S. PIERCE
D.B. 547, PG 124
W.B. 29, PG. 122
TAX MAP 3G, PARCEL 24.5
5.80 AC.

POINT # 3
IRON ROD & CAP
EASTING =5209.2017
NORTHING =9887.7371
ELEVATION=1006.3803

JAMI E. JONES
D.B. 557, PG 208
TAX MAP 3G, PARCEL 24.3
8.52 AC.

EROSION AND SEDIMENT CONTROL PLAN NOTE
SILT FENCE SHALL BE PLACED ACCORDING TO PLAN. WHEN FOUNDATION PROTECTION MATERIAL IS PLACED, FENCE CAN BE REMOVED FROM DITCH. SILT FENCE TO BE INSTALLED BEFORE ANY SOIL DISTURBANCES AS PER WVDOT EROSION AND SEDIMENT CONTROL MANUAL AMENDED 9/1/2004.

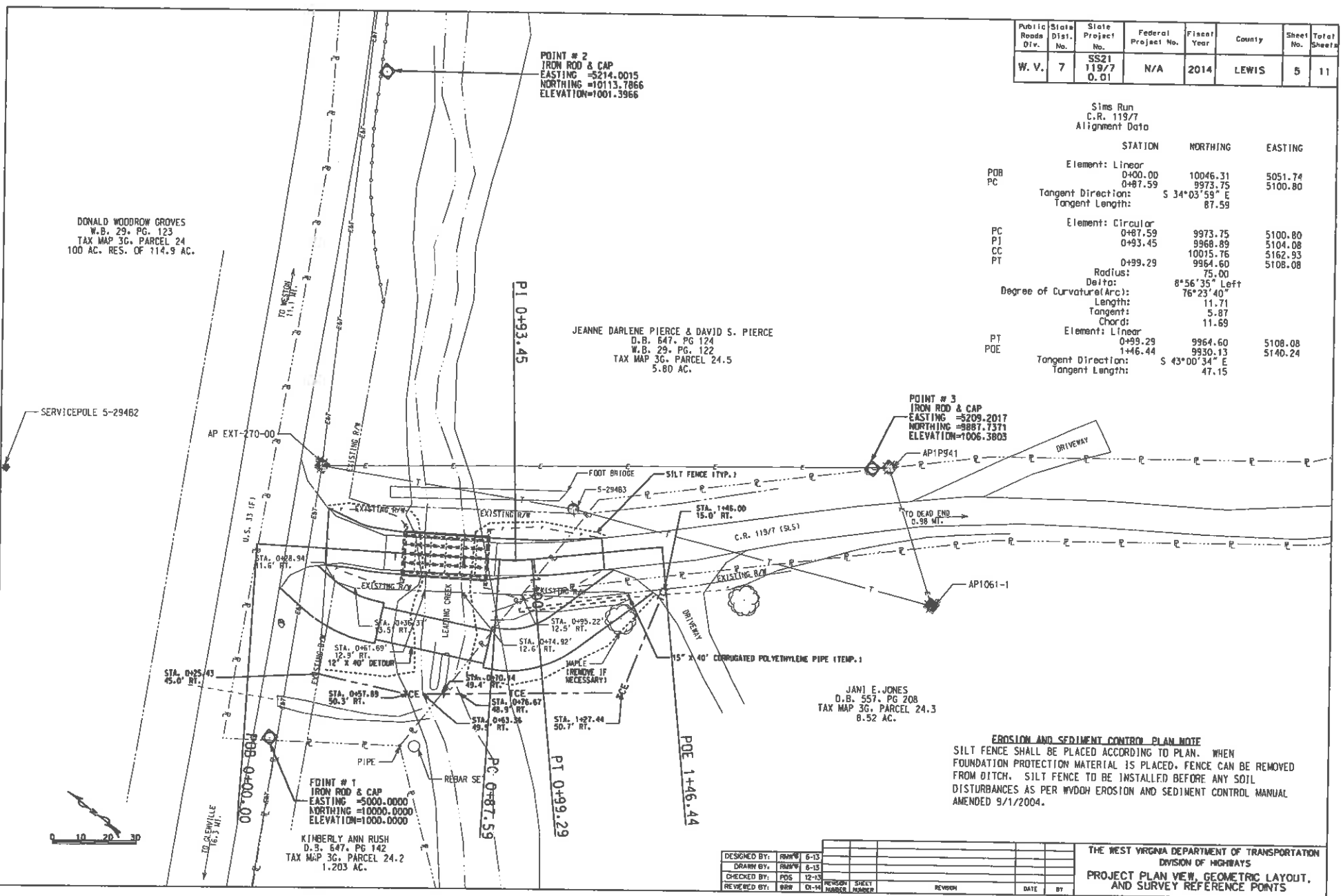

DESIGNED BY:	RMW	6-13	REVISION	SHEET NUMBER	DATE	BY
DRAWN BY:	RMW	6-13				
CHECKED BY:	POS	12-13				
REVIEWED BY:	BRW	01-14				

THE WEST VIRGINIA DEPARTMENT OF TRANSPORTATION
DIVISION OF HIGHWAYS
PROJECT PLAN VIEW, GEOMETRIC LAYOUT,
AND SURVEY REFERENCE POINTS

DONALD WOODROW GROVES
W.B. 29, PG. 123
TAX MAP 3G, PARCEL 24
100 AC. RES. OF 114.9 AC.

POINT # 1
IRON ROD & CAP
EASTING =5000.0000
NORTHING =10000.0000
ELEVATION=1000.0000

KIMBERLY ANN RUSH
D.B. 647, PG 142
TAX MAP 3G, PARCEL 24.2
1.203 AC.

SERVICEPOLE 5-29462

PI 0+93.45

PI 0+99.29

POE 1+46.44

PC 0+87.59

PBB 0+00.00

TO CLEVELAND
16.3 MI.

U.S. 33 (IF)

AP EXT -270-00

FOOT BRIDGE

SILT FENCE (TYP.)

C.R. 119/7 (SLS)

DRIVEWAY

15' x 40' CORRUGATED POLYETHYLENE PIPE (TEMP.)

MAPLE TREES (REMOVE IF NECESSARY)

REBAR SET

PIPE

EXISTING R/W

EXISTING R/W

EXISTING R/W

EXISTING R/W

EXISTING R/W

Public Roads Div.	State Dist. No.	State Project No.	Federal Project No.	Fiscal Year	County	Sheet No.	Total Sheets
W. V.	7	SS21 119/7 0.01	N/A	2014	LEWIS	6	11

DONALD WOODROW GROVES
W.B. 29, PG. 123
TAX MAP 3G, PARCEL 24
100 AC. RES. OF 114.9 AC.

JEANNE DARLENE PIERCE & DAVID S. PIERCE
D.B. 647, PG 124
W.B. 29, PG. 122
TAX MAP 3G, PARCEL 24.5
5.80 AC.

JANI E. JONES
D.B. 557, PG 208
TAX MAP 3G, PARCEL 24.3
8.52 AC.

KIMBERLY ANN RUSH
D.B. 647, PG 142
TAX MAP 3G, PARCEL 24.2
1.203 AC.

NOTE:
THIS IS NOT A BOUNDARY SURVEY PLAT. THIS IS A RIGHT OF WAY PLAT FOR PROPERTY INFORMATION AND IDENTIFICATION. IT WAS COMPILED FROM DEEDS AND RECORDS. NO BOUNDARY SURVEY WAS PERFORMED. NO BOUNDARY MONUMENTS WERE SET.

0 25 50 75 100

DESIGNED BY:	RMM	8-13					
DRAWN BY:	RMM	8-13					
CHECKED BY:	PDS	12-13					
REVIEWED BY:	WRR	01-14	REVISION	SHEET NUMBER	REVISION	DATE	BY

THE WEST VIRGINIA DEPARTMENT OF TRANSPORTATION
DIVISION OF HIGHWAYS
PROPERTY MAP

Public Road No.	State Dist. No.	State Project No.	Federal Project No.	Fiscal Year	County	Sheet No.	Total Sheets
W. V. 7		SS21 119/7 D. 01	N/A	2014	LEWIS	8	11

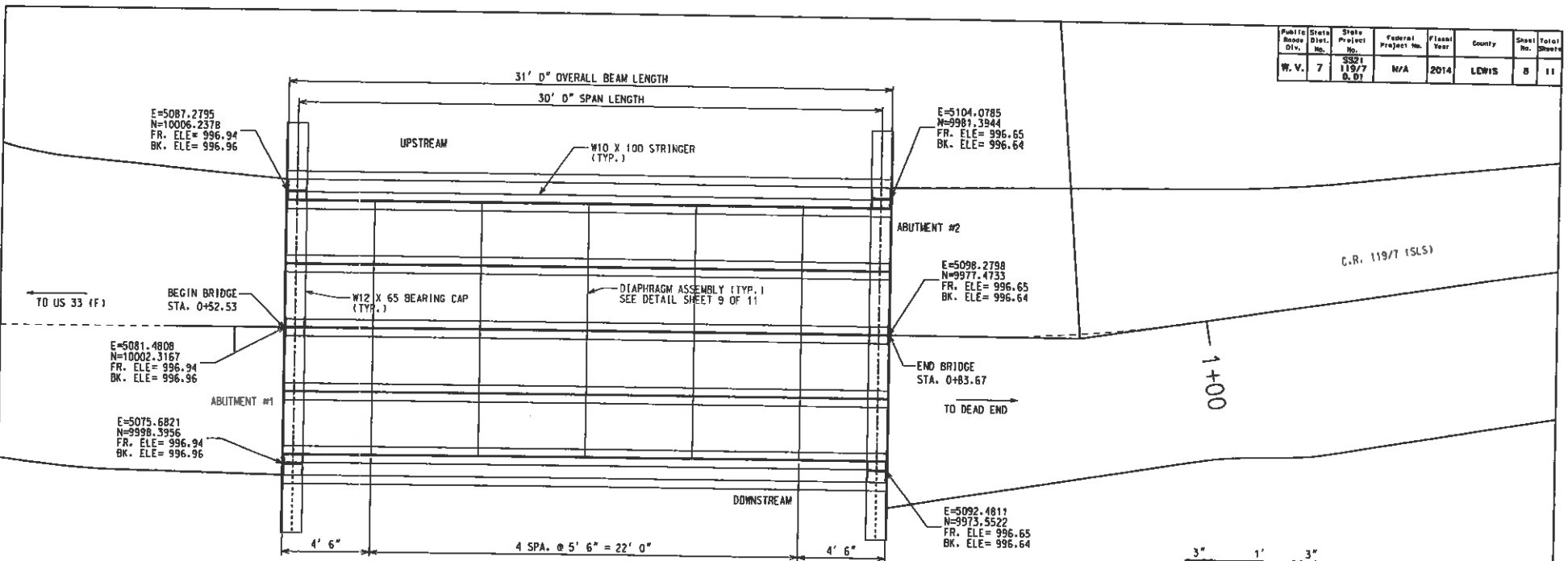

STEEL LAYOUT

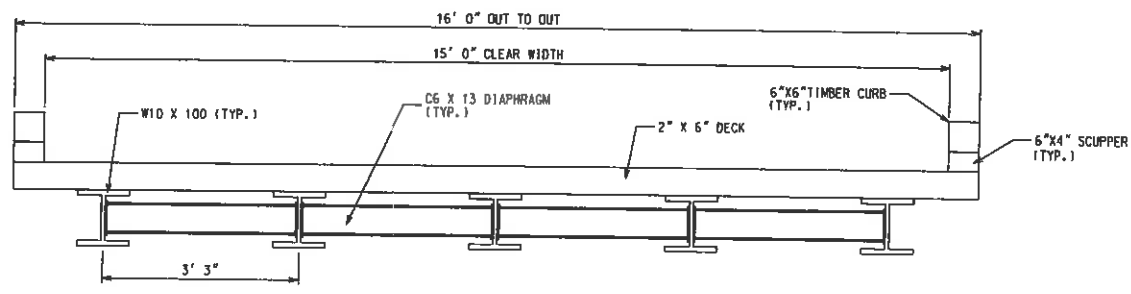

DECK SECTION

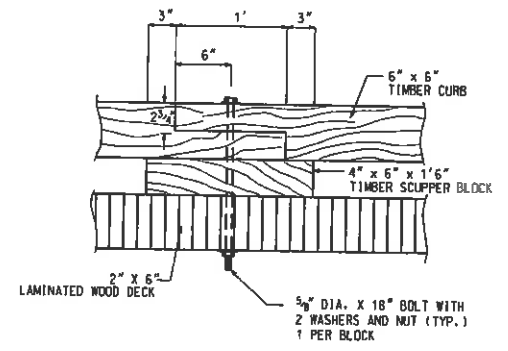

CURB SPLICE DETAIL A

NO SCALE

DESIGNED BY:	DATE	REVISION	DATE	BY
RAW	6-13			
RAW	8-13			
PDS	12-13			
BRW	01-14			

THE WEST VIRGINIA DEPARTMENT OF TRANSPORTATION
DIVISION OF HIGHWAYS
PROPOSED BRIDGE PLAN VIEW, STEEL LAYOUT, PROPOSED DECK SECTION, & CURB SPLICE DETAIL

Fed/State/Local Dist.	Project No.	Fiscal Year	County	Sheet No.	Total Sheets
W. V. 7	SS21 119/7 0, 01	N/A	2014	LEWIS	9 11

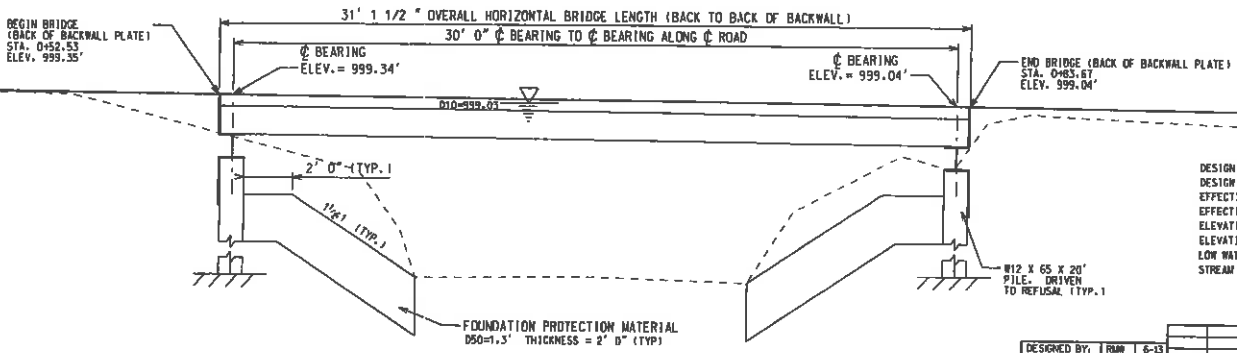
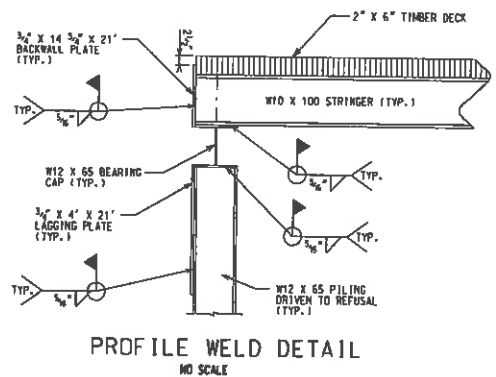
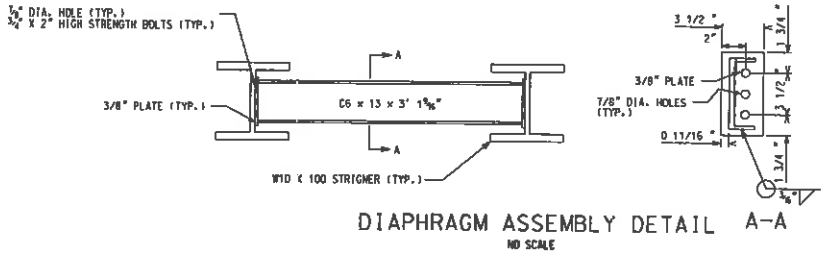
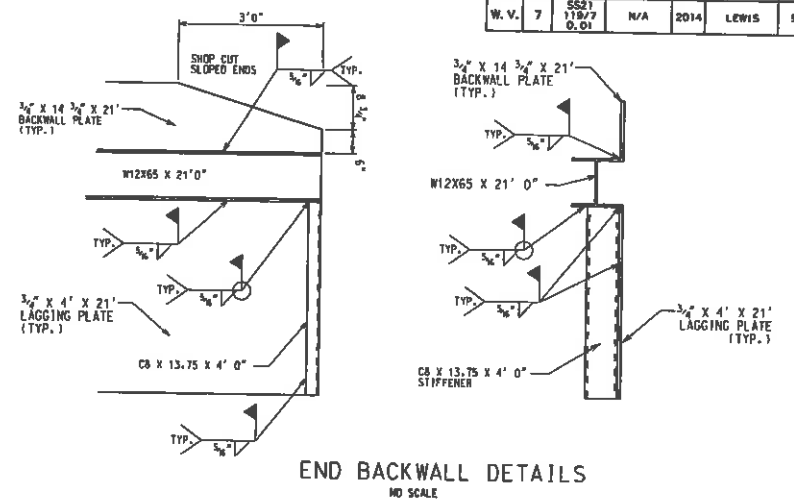
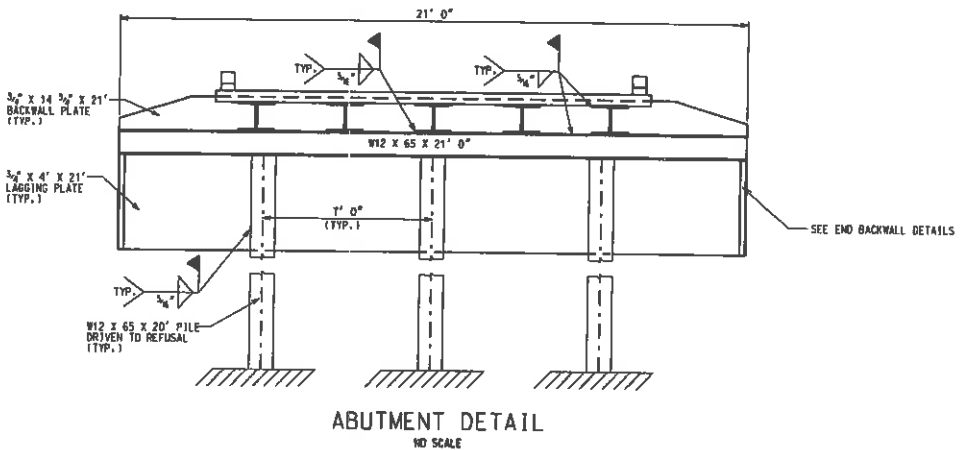

HYDRAULIC DATA

DESIGN FLOOD FREQUENCY:	010
DESIGN DISCHARGE:	874 CFS
EFFECTIVE WATERWAY AREA OF EXISTING STRUCTURE:	28.3 SF
EFFECTIVE WATERWAY AREA OF NEW STRUCTURE:	134 SF
ELEVATION AT BOTTOM OF EXISTING SUPERSTRUCTURE:	991.81
ELEVATION AT BOTTOM OF NEW SUPERSTRUCTURE:	991.52
LOW WATER ELEVATION:	992.39
STREAM BED ELEVATION:	991.81

DESIGNED BY:	DATE:	REVISION NUMBER:	REVISION:	DATE:	BY:
RAM	6-13				
RAM	9-13				
PDS	12-13				
RRR	01-14				

THE WEST VIRGINIA DEPARTMENT OF TRANSPORTATION
DIVISION OF HIGHWAYS
ELEVATION VIEW, HYDRAULIC DATA, ABUTMENT
CAP AND DIAPHRAGM DETAILS

Public Roads Dist.	State Dist. No.	State Project No.	Federal Project No.	Fiscal Year	County	Sheet No.	Total Sheets
W. V.	7	SS21 119/7 0.01	N/A	2014	LEWIS	10	11

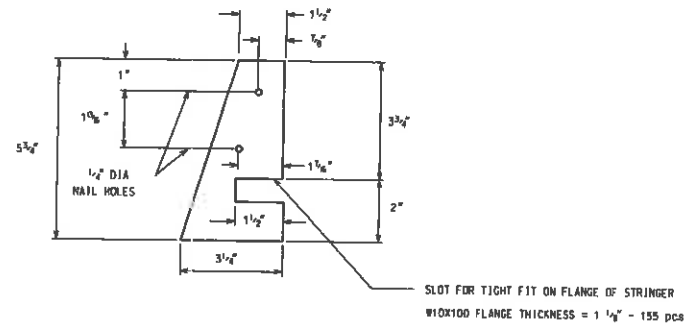

DECK ANCHOR PLATE DETAILS
NO SCALE

SLOT FOR TIGHT FIT ON FLANGE OF STRINGER
WIDEX100 FLANGE THICKNESS = 1 1/2" - 155 pcs

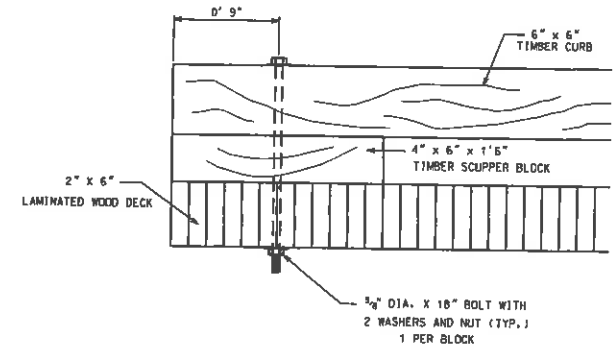

CURB END DETAIL
NO SCALE

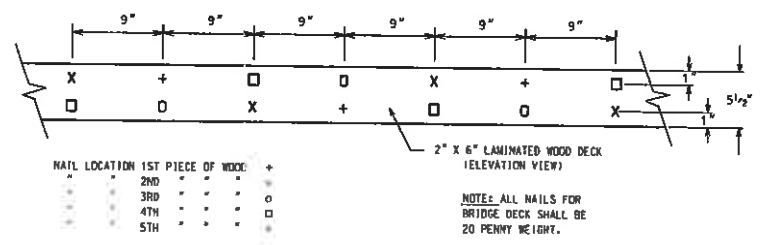

TIMBER DECK NAILING DIAGRAM
NO SCALE

NOTE: ALL NAILS FOR
BRIDGE DECK SHALL BE
20 PENNY WEIGHT.

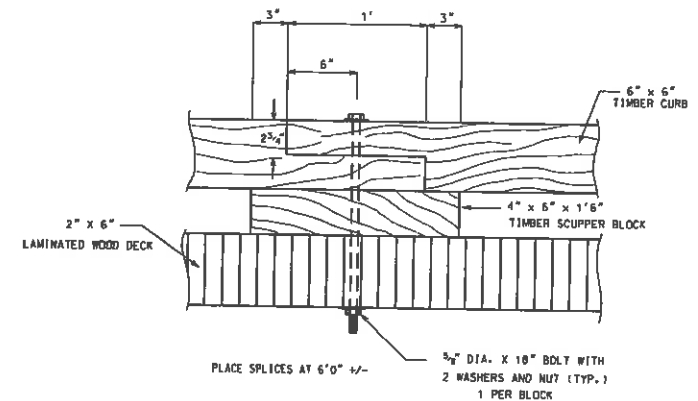

CURB SPLICE DETAIL
NO SCALE

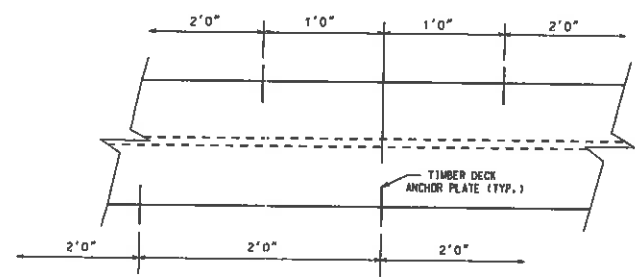

DECK ANCHOR PLATE SPACING DETAIL
(INTERIOR STRINGER)
NO SCALE

NOTE: ALL ANCHOR PLATES
ON EXTERIOR STRINGERS
SHALL BE PLACED ON
INTERIOR FLANGE
SPACED @ 1'0" c-c.

DESIGNED BY:	RAW	6-13				
DRAWN BY:	RAW	6-13				
CHECKED BY:	PDS	12-13				
REVIEWED BY:	BRB	01-14	REVISION	SHEET	NUMBER	
			REVISION	DATE	BY	

THE WEST VIRGINIA DEPARTMENT OF TRANSPORTATION
DIVISION OF HIGHWAYS
DECK NAILING DETAILS & CURB DETAILS

Public Road Dist.	State Dist. No.	State Project No.	Federal Project No.	Fiscal Year	County	Sheet No.	Total Sheets
W. V.	7	SS21 118/2 0.01	N/A	2014	LEWIS	11	11

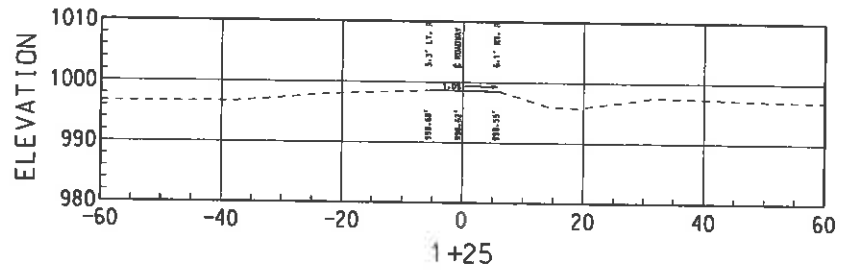
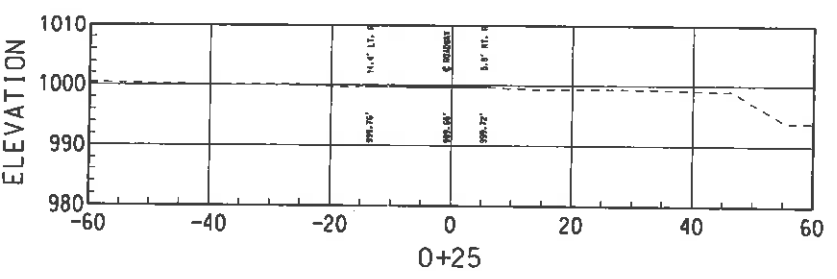
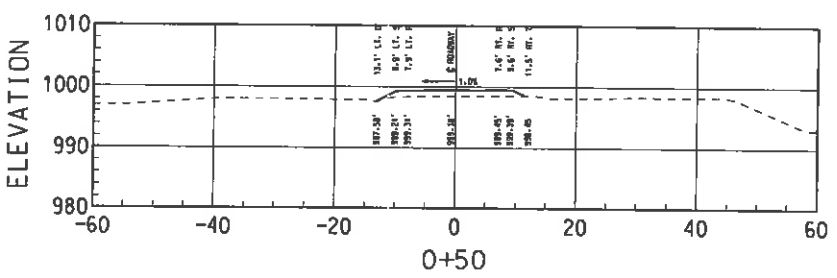
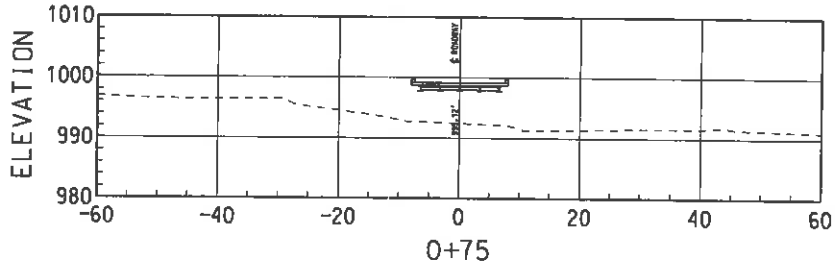
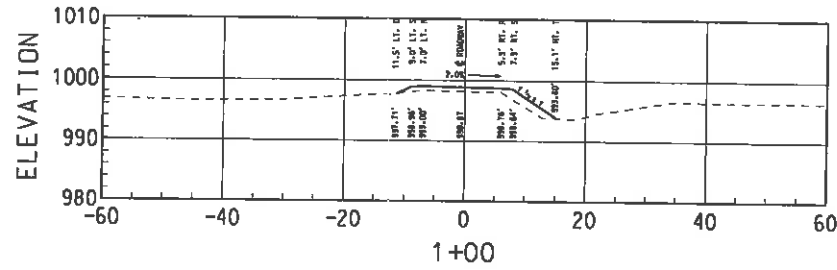

- NOTES:
 UNLESS OTHERWISE NOTED ALL SLOPES ARE 2:1
 R. - EDGE OF ROADWAY
 S. - EDGE OF SHOULDER
 D. - EDGE OF DITCH
 T. - TOE OF SLOPE
 B. - EDGE OF BRIDGE

DESIGNED BY:	DATE	REVISION	DATE	BY
RMW	2-13			
RMW	2-13			
POS	12-13			
RMW	01-14			

THE WEST VIRGINIA DEPARTMENT OF TRANSPORTATION
 DIVISION OF HIGHWAYS
 C.R. 109 CROSS SECTIONS

State of West Virginia

VENDOR PREFERENCE CERTIFICATE

Certification and application* is hereby made for Preference in accordance with West Virginia Code, §5A-3-37. (Does not apply to construction contracts). West Virginia Code, §5A-3-37, provides an opportunity for qualifying vendors to request (at the time of bid) preference for their residency status. Such preference is an evaluation method only and will be applied only to the cost bid in accordance with the West Virginia Code. This certificate for application is to be used to request such preference. The Purchasing Division will make the determination of the Vendor Preference, if applicable.

1. Application is made for 2.5% vendor preference for the reason checked:

✓ Bidder is an individual resident vendor and has resided continuously in West Virginia for four (4) years immediately preceding the date of this certification; or,

_____ Bidder is a partnership, association or corporation resident vendor and has maintained its headquarters or principal place of business continuously in West Virginia for four (4) years immediately preceding the date of this certification; or 80% of the ownership interest of Bidder is held by another individual, partnership, association or corporation resident vendor who has maintained its headquarters or principal place of business continuously in West Virginia for four (4) years immediately preceding the date of this certification; or,

_____ Bidder is a nonresident vendor which has an affiliate or subsidiary which employs a minimum of one hundred state residents and which has maintained its headquarters or principal place of business within West Virginia continuously for the four (4) years immediately preceding the date of this certification; or,

2. Application is made for 2.5% vendor preference for the reason checked:

_____ Bidder is a resident vendor who certifies that, during the life of the contract, on average at least 75% of the employees working on the project being bid are residents of West Virginia who have resided in the state continuously for the two years immediately preceding submission of this bid; or,

3. Application is made for 2.5% vendor preference for the reason checked:

_____ Bidder is a nonresident vendor employing a minimum of one hundred state residents or is a nonresident vendor with an affiliate or subsidiary which maintains its headquarters or principal place of business within West Virginia employing a minimum of one hundred state residents who certifies that, during the life of the contract, on average at least 75% of the employees or Bidder's affiliate's or subsidiary's employees are residents of West Virginia who have resided in the state continuously for the two years immediately preceding submission of this bid; or,

4. Application is made for 5% vendor preference for the reason checked:

_____ Bidder meets either the requirement of both subdivisions (1) and (2) or subdivision (1) and (3) as stated above; or,

5. Application is made for 3.5% vendor preference who is a veteran for the reason checked:

_____ Bidder is an individual resident vendor who is a veteran of the United States armed forces, the reserves or the National Guard and has resided in West Virginia continuously for the four years immediately preceding the date on which the bid is submitted; or,

6. Application is made for 3.5% vendor preference who is a veteran for the reason checked:

_____ Bidder is a resident vendor who is a veteran of the United States armed forces, the reserves or the National Guard, if, for purposes of producing or distributing the commodities or completing the project which is the subject of the vendor's bid and continuously over the entire term of the project, on average at least seventy-five percent of the vendor's employees are residents of West Virginia who have resided in the state continuously for the two immediately preceding years.

7. Application is made for preference as a non-resident small, women- and minority-owned business, in accordance with West Virginia Code §5A-3-59 and West Virginia Code of State Rules.

_____ Bidder has been or expects to be approved prior to contract award by the Purchasing Division as a certified small, women- and minority-owned business.

Bidder understands if the Secretary of Revenue determines that a Bidder receiving preference has failed to continue to meet the requirements for such preference, the Secretary may order the Director of Purchasing to: (a) reject the bid; or (b) assess a penalty against such Bidder in an amount not to exceed 5% of the bid amount and that such penalty will be paid to the contracting agency or deducted from any unpaid balance on the contract or purchase order.

By submission of this certificate, Bidder agrees to disclose any reasonably requested information to the Purchasing Division and authorizes the Department of Revenue to disclose to the Director of Purchasing appropriate information verifying that Bidder has paid the required business taxes, provided that such information does not contain the amounts of taxes paid nor any other information deemed by the Tax Commissioner to be confidential.

Under penalty of law for false swearing (West Virginia Code, §61-5-3), Bidder hereby certifies that this certificate is true and accurate in all respects; and that if a contract is issued to Bidder and if anything contained within this certificate changes during the term of the contract, Bidder will notify the Purchasing Division in writing immediately.

Bidder: Bulldog Rock Co

Signed: [Signature]

Date: 5-11-15

Title: Pres.

STATE OF WEST VIRGINIA
Purchasing Division

PURCHASING AFFIDAVIT

MANDATE: Under W. Va. Code §5A-3-10a, no contract or renewal of any contract may be awarded by the state or any of its political subdivisions to any vendor or prospective vendor when the vendor or prospective vendor or a related party to the vendor or prospective vendor is a debtor and: (1) the debt owed is an amount greater than one thousand dollars in the aggregate; or (2) the debtor is in employer default.

EXCEPTION: The prohibition listed above does not apply where a vendor has contested any tax administered pursuant to chapter eleven of the W. Va. Code, workers' compensation premium, permit fee or environmental fee or assessment and the matter has not become final or where the vendor has entered into a payment plan or agreement and the vendor is not in default of any of the provisions of such plan or agreement.

DEFINITIONS:

"Debt" means any assessment, premium, penalty, fine, tax or other amount of money owed to the state or any of its political subdivisions because of a judgment, fine, permit violation, license assessment, defaulted workers' compensation premium, penalty or other assessment presently delinquent or due and required to be paid to the state or any of its political subdivisions, including any interest or additional penalties accrued thereon.

"Employer default" means having an outstanding balance or liability to the old fund or to the uninsured employers' fund or being in policy default, as defined in W. Va. Code § 23-2c-2, failure to maintain mandatory workers' compensation coverage, or failure to fully meet its obligations as a workers' compensation self-insured employer. An employer is not in employer default if it has entered into a repayment agreement with the Insurance Commissioner and remains in compliance with the obligations under the repayment agreement.

"Related party" means a party, whether an individual, corporation, partnership, association, limited liability company or any other form or business association or other entity whatsoever, related to any vendor by blood, marriage, ownership or contract through which the party has a relationship of ownership or other interest with the vendor so that the party will actually or by effect receive or control a portion of the benefit, profit or other consideration from performance of a vendor contract with the party receiving an amount that meets or exceed five percent of the total contract amount.

AFFIRMATION: By signing this form, the vendor's authorized signer affirms and acknowledges under penalty of law for false swearing (W. Va. Code §61-5-3) that neither vendor nor any related party owe a debt as defined above and that neither vendor nor any related party are in employer default as defined above, unless the debt or employer default is permitted under the exception above.

WITNESS THE FOLLOWING SIGNATURE:

Vendor's Name: Bulldog Rack Co

Authorized Signature: [Signature] Date: 5-11-15

State of West Virginia

County of Hancock, to-wit:

Taken, subscribed, and sworn to before me this 11th day of May, 2015

My Commission expires 3-23, 2020

AFFIX SEAL HERE



Official Seal
Notary Public, State of West Virginia
Valerie A. Stromack
WeaBanc Bank, Inc.
333 Pence Rd
Weirton, WV 26062
My commission expires March 23, 2021

NOTARY PUBLIC Valerie A. Stromack