



West Virginia Purchasing Division

2019 Washington Street, East
Charleston, WV 25305
Telephone: 304-558-2306
General Fax: 304-558-6026
Bid Fax: 304-558-3970

The following documentation is an electronically-submitted vendor response to an advertised solicitation from the *West Virginia Purchasing Bulletin* within the Vendor Self-Service portal at ***wvOASIS.gov***. As part of the State of West Virginia's procurement process, and to maintain the transparency of the bid-opening process, this documentation submitted online is publicly posted by the West Virginia Purchasing Division at ***WVPurchasing.gov*** with any other vendor responses to this solicitation submitted to the Purchasing Division in hard copy format.

Header

[List View](#)

- General Information**
- Contact
- Default Values
- Discount
- Document Information

Procurement Folder: 63224**SO Doc Code:** CRFQ**Procurement Type:** Central Purchase Order**SO Dept:** 0608**Vendor ID:** **SO Doc ID:** COR1500000031**Legal Name:** GRAYBAR ELECTRIC CO INC**Published Date:** 2/13/15**Alias/DBA:****Close Date:** 2/24/15**Total Bid:** \$29,963.00**Close Time:** 13:30**Response Date:** **Status:** Closed**Response Time:** **Solicitation Description:** **Total of Header Attachments:** 0**Total of All Attachments:** 0



Purchasing Division
 2019 Washington Street East
 Post Office Box 50130
 Charleston, WV 25305-0130

**State Of West Virginia
 Solicitation Response**

Proc Folder : 63224

Solicitation Description : Addendum No. 1 - extend bid opening - Digital Video Recorder

Proc Type : Central Purchase Order

Date issued	Solicitation Closes	Solicitation No	Version
	2015-02-24 13:30:00	SR 0608 ESR02231500000002145	1

VENDOR

000000103427
 GRAYBAR ELECTRIC CO INC

FOR INFORMATION CONTACT THE BUYER

Tara Lyle
 (304) 558-2544
 tara.l.yyle@wv.gov

Signature X FEIN # DATE

All offers subject to all terms and conditions contained in this solicitation

Line	Comm Ln Desc	Qty	Unit Issue	Unit Price	Ln Total Or Contract Amount
1	EverFocus or Equal 8 Channel DVR	2.00000	EA	\$399.00	

Comm Code	Manufacturer	Specification	Model #
52161545			

Extended Description : Addendum No. 1 - Responses to vendor questions attached. The bid opening has moved from 02/19/2015 to 02/24/2015 at 1:30 pm. See attached pages.

THE WV PURCHASING DIVISION FOR THE AGENCY, WV DIVISION OF CORRECTIONS, IS SOLICITING BIDS TO

Line	Comm Ln Desc	Qty	Unit Issue	Unit Price	Ln Total Or Contract Amount
2	Everfocus or equal 16 Channel DVR	17.00000	EA	\$1,595.00	

Comm Code	Manufacturer	Specification	Model #
52161545			

Extended Description : This type of device uses a hard drive (like the one in the computer) to record and store television content.

Line	Comm Ln Desc	Qty	Unit Issue	Unit Price	Ln Total Or Contract Amount
3	Everfocus or equal 32 Channel DVR	1.00000	EA	\$2,050.00	

Comm Code	Manufacturer	Specification	Model #
52161545			

Extended Description : This type of device uses a hard drive (like the one in the computer) to record and store television content.

ECOR HD Series

4, 8 Channel HD DVR

eZ.HD



NEW



Features

- Megapixel resolution over standard coaxial / UTP (Unshielded Twisted Pair) cable
- eZ upgrade to HD resolution
- 720p or 960H input in different channel (2 channels a set) simultaneously
- H.264 compression format for enhancing recording capacity and improving network image transmission speed
- Multiple Monitors: Separately configured HDMI, VGA ,CVBS Monitor outputs
- High bandwidth HD recording (4,8 CH 100/120fps) with recordable reduced bandwidth stream for mobile or multiplexed viewing applications.
- Supports live monitoring and playback of video from mobile devices via MobileFocus / MobileFocus Plus Apps.
- Multiple Control Inputs: mouse / front panel / IR remote controller
- Remote configuration support from built-in web interface
- Ethernet interface for remote network viewing and control.
- Integration with Genie XMS
- Multi-language support

Specifications

ECOR HD Series	ECOR HD 4F	ECOR HD 8F
HD or WD1 Video In	x 4 on BNC	x 8 on BNC
Video Out	HDMI x 1 / VGA x 1 / CVBS x 1	
Recording Rate/Resolution	NTSC 120fps@720p; PAL 100fps@720p	NTSC 120fps@720p; PAL 100fps@720p
Playback Rate/Resolution	NTSC 120fps@720p; PAL 100fps@720p	NTSC 120fps@720p; PAL 100fps@720p
Compression Format	H.264	
Operating System	Linux® embedded	
Audion In/Out	4 In / 1 Out	4 In / 1 Out
Alarm In/Out	4 In / 1 Out	4 In / 1 Out
Internal Storage	3.5" HDD x 1 (max 4TB)	3.5" HDD x 2 (max 8TB)
External Storage	N/A	N/A
RAID	N/A	
Built-in slim DVD burner	N/A	
Network/Protocols	10/100 Ethernet x 1/TCP-IP / DHCP / PPPoE / DDNS / SMTP / NTP	
USB	USB 2.0 x 2	
RS-232/RS-485	0 / 1	
Configuration Method	OSD UI / Webpage	
Mobile Viewing	iOS, Android	
Pentaplex Operation	Simultaneous Live, Recording, Playback, Archive and Remote viewing	
Dual Streaming	Yes	
Recording Mode	Manual, Schedule, Event	
Playback Search	Date/Time search	
Video Pause	Yes	
Video Loss Detection	Yes	
Motion Detection	Yes	
Event Log	Yes	
Watch dog timer	Yes	
Schedule settings	Yes	
User Access	3 Levels of user access	
PTZ protocols supported	Pelco D, Pelco P, Samsung, EverFocus Transparent	
Operating Temp.	0°C~40°C / 32°F~104°F	
Power Source	12V 3A	
Power Consumption	36W max.	
Dimensions (W x D x H)	320 x 267.8 x 59.9mm / 12.6" x 10.54" x 2.36"	
Weight	2.36 kgs / 5.2 lbs	3.14 kgs / 6.92 lbs
Certificates	CE, FCC,UL	

Dimensions

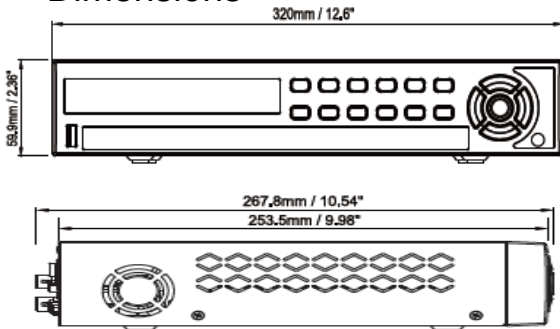

- All product specifications are subject to change without notice
- Models vary in different countries. Please visit EverFocus regional websites for detailed ordering

PARAGON960 X4

16 Channel Real-Time WD1/960H DVR

PARAGON 960

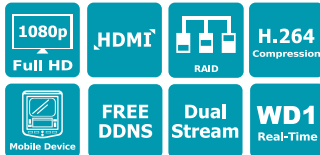

Features

- 16 CH WD1 real-time recording and playback
- WD1 capability provides higher resolution (960x576/960x480) compared to traditional D1 cameras
- H.264 compression format for enhanced recording capacity and improved network image transmission speed
- RAID1 – for full data redundancy
- Multiple Main Monitors: Separately configured HDMI or VGA (1080p) Main monitor outputs
- Call monitor: Sequenced view through composite BNC and HDMI or VGA output with multiplex and sequencing
- High bandwidth WD1 recording (400/480fps) with recordable reduced bandwidth stream for mobile or multiplexed viewing applications
- Free EverFocus DDNS Service – static IP address is not required for reliable remote access
- Supports one eSATA port for external HDD (EDA450)
- Supports live monitoring and playback of video from mobile devices via MobileFocus/ MobileFocus Plus Apps
- Multiple Control Inputs: mouse/front panel/remote controller/EKB500 Keyboard
- Built-in record time calculator for fast recording estimation
- Multiple intelligent video query functionality, including snapshot and smart search
- Powerful archive functionality from both remote and DVR sites
- Simplified access to common features such as setup, archival, playback and search functions through Express menus
- Remote configuration support from built-in web interface
- Dual Gigabit Ethernet interface for remote network viewing and control
- On-screen PTZ control via mouse or front panel
- Built-in DVD burner (Optional)
- Dual USB 2.0 ports for video archive and mouse control
- Integration with PowerVideo Plus
- Multi-language support
- 19" Rack mountable – rack ears included

Specifications

Model Name	PARAGON960 X4
Number of Channels	16 CH
Compression Format	H.264/M-JPEG
Recording Rate/Resolution (Max)	480 NTSC/400 PAL (WD1), 480 NTSC/400 PAL (4CIF/D1), 480 NTSC/400 PAL (2CIF), 480 NTSC/400 PAL (CIF)
Playback Rate/Resolution	480 NTSC/400 PAL (WD1), 480 NTSC/400 PAL (4CIF/D1), 480 NTSC/400 PAL (2CIF), 480 NTSC/400 PAL (CIF)
Remote View Support	Remote live view and playback support on various web browsers including Internet Explorer, Chrome, Firefox, Safari. Integrated with PowerVideo Plus CMS.
Mobile View Support	Live view on mobile browsers MobileFocus apps for iOS and Android devices. MobileFocus HD for iPad
Pentaplex Operation	Simultaneous Live, Recording, Playback, Archive and Remote Viewing
Video Inputs	16 BNC (NTSC/PAL automatic selection)
Main Monitor Outputs	HDMI or VGA (selectable)
Call Monitor Output	BNC(Call), VGA or HDMI (selectable)
Looping Output	16
Audio Inputs	4 x RCA socket; Line level
Audio Outputs	2 x RCA socket; Line level
Recording Modes	Manual, Schedule and Event; or, choose Number of Days
Playback Search	Date/Time, Event, Motion in Recorded Video, snapshot by Interval
Alarm Inputs	16 inputs
Alarm Out	4 x relays; 30 VDC@1A rating
Video Pause	Yes
Video Loss Detection	Yes
Motion Detection	Yes
Event Log	Yes
Watch Dog Timer	Yes
Internal HDD	4 Internal SATA HDD
Raid Function	HW RAID 0,1
External HDD	1 x eSATA (EDA450)
Built-in DVD Burner	Slim Type DVD Burner (Optional)
User Interface	GUI(Graphical User Interface)
OS	Embedded Linux
Network/Protocol	2 x Gigabit Ethernet; TCP-IP/DHCP/PPPoE/DDNS/HTTP
Control PTZ via OSD	Yes (via both local and remote interfaces)
USB	2 x USB 2.0 port (on Front Panel)
Schedule Setting	Supports Express and Advanced Schedule Setting
User Access	3 Levels of User Access Defined
RS-232	9-pin D-Sub socket (male)
RS-485	1 x RS-485(3 pin Terminal connector)
Supported PTZ Protocols	EverFocus, Pelco D, Pelco P, Samsung, Transparent
Power Source	100-240 VAC~, 150W max.
Operating Temperature	0°C~40°C/32°F~104°F (20~80% humidity)
Dimensions (L x W x H)	430 x 423 x 95mm/16.93" x 16.65" x 3.74"
Certificates	

* All product specifications are subject to change without notice

* Models vary in different countries. Please visit EverFocus regional websites for detailed ordering information

* Lens models and availability vary in different regions

Major Operating Controls

- 1 Main Power Plug
- 2 eSATA
- 3 Video Input and Looping
- 4 Audio In/Out
- 5 RS-232 Connector
- 6 RS-485 Connector
- 7 HDMI Monitor 1
- 8 VGA Monitor 2
- 9 Call Monitor Out
- 10 Network Connector
- 11 Alarm In
- 12 Alarm Out

Rear View

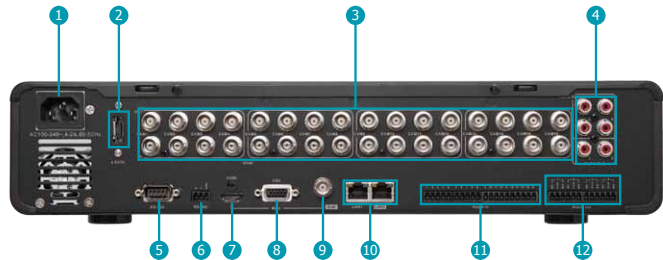

* Front & back panel controls vary depending on models

Advantages

Triplex Function for WDI Real-time

Best performance triplex operation, in WD1 resolution you can still have real-time recording for 16 cameras at 30fps, and playback all 16 cameras with WD1 30fps. It also supports sub streaming for CIF 30fps compression for 16 cameras to do remote control. It can achieve best recording quality locally and get smooth image in low bandwidth environment.



Full HD Video Output

Full HD 1080p brings superior picture performance on a massive scale, it can provide 1:1 output for megapixel camera. Digital output renders stunning images from any resolution which enhances motion to deliver a smoother and clearer looking.

System Configuration

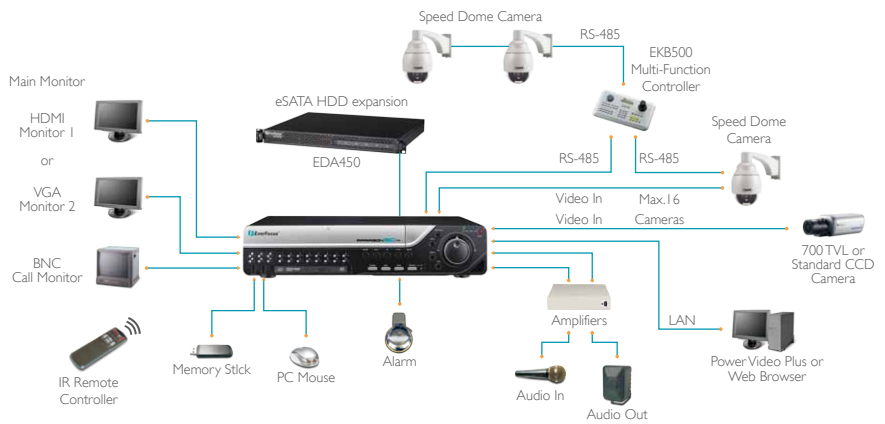

Dimensions

Front View

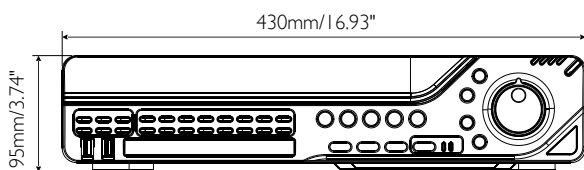

Side View

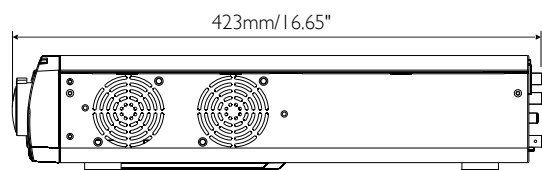

* All product specifications are subject to change without notice
 * Models vary in different countries. Please visit EverFocus regional websites for detailed ordering information
 * Lens models and availability vary in different regions

PARAGON960 X4

32 Channel Real-Time WD1/960H DVR

PARAGON960



Features

- 32CH WD1 real-time recording & playback
- H.264 compression format for enhancing recording capacity and improving network image transmission speed
- RAID5 – for full data redundancy
- Multiple Main Monitors: Separately configured HDMI or VGA (1080p) Main Monitor outputs
- High bandwidth WD1 recording (800/960fps) with recordable reduced bandwidth stream for mobile or multiplexed viewing applications.
- Supports one eSATA port for external HDD
- Supports live monitoring and playback of video from mobile devices via MobileFocus / MobileFocus Plus Apps.
- Multiple Control Inputs: mouse / front panel / remote controller / EKB 200 , 500 Keyboards
- Remote configuration support from built-in web interface
- Dual Gigabit Ethernet interface for remote network viewing and control.
- Integration with PowerVideo® Plus
- Multi-language support

Specifications

Video In	x 32 on BNC
Video Out	HDMI x 1 / VGA x 1 / CVBS x 1/Matrix x 4
Recording Rate/Resolution	NTSC 960fps@WD1; PAL 800fps@WD1
Playback Rate/Resolution	NTSC 960fps@WD1; PAL 800fps@WD1
Compression Format	H.264
Operating System	Linux® embedded
Audio In/Out	16 / 2
Alarm In/Out	16 / 4
Internal Storage	3.5" HDD x 4 (max 16TB)
External Storage	eSATA x 1 (max 8TB) (optional: EDA450)
RAID	RAID 5
Built-in slim DVD burner	1 (optional)
Network/Protocols	2Gb Ethernet x 2/TCP-IP / DHCP / PPPoE / DDNS / UDP / SMTP / RTP / RTSP / NTP
USB	USB 2.0 x 2
RS-232/RS-485	1 / 1
Configuration Method	OSD UI / Webpage
Mobile Viewing	iOS, Android
Pentaplex Operation	Simultaneous Live, Recording, Playback, Archive and Remote viewing
Dual Streaming	Yes
Recording Mode	Manual, Schedule, Event
Playback Search	Date/Time search, Event Search, Smart Search, Snapshot Search
Video Pause	Yes
Video Loss Detection	Yes
Motion Detection	Yes
Event Log	Yes
Watch dog timer	Yes
Schedule settings	Express & Advanced settings
User Access	3 Levels of user access
PTZ protocols supported	EverFocus, Pelco D, Pelco P, Samsung, Transparent
Power Source	100-240 VAC~
Power Consumption	150W max.
Operating Temp.	0°C~40°C / 32°F~104°F
Dimensions (W x D x H)	430 x 423 x 95 mm / 16.93" x 16.65" x 3.74"
Weight	8.2 kg / 20.83 lbs
Certificates	CE, FCC, UL

Dimensions

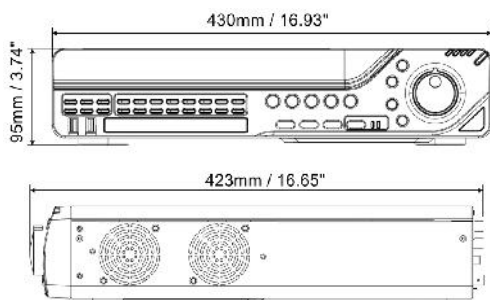

STATE OF WEST VIRGINIA
Purchasing Division

PURCHASING AFFIDAVIT

MANDATE: Under W. Va. Code §5A-3-10a, no contract or renewal of any contract may be awarded by the state or any of its political subdivisions to any vendor or prospective vendor when the vendor or prospective vendor or a related party to the vendor or prospective vendor is a debtor and: (1) the debt owed is an amount greater than one thousand dollars in the aggregate; or (2) the debtor is in employer default.

EXCEPTION: The prohibition listed above does not apply where a vendor has contested any tax administered pursuant to chapter eleven of the W. Va. Code, workers' compensation premium, permit fee or environmental fee or assessment and the matter has not become final or where the vendor has entered into a payment plan or agreement and the vendor is not in default of any of the provisions of such plan or agreement.

DEFINITIONS:

"Debt" means any assessment, premium, penalty, fine, tax or other amount of money owed to the state or any of its political subdivisions because of a judgment, fine, permit violation, license assessment, defaulted workers' compensation premium, penalty or other assessment presently delinquent or due and required to be paid to the state or any of its political subdivisions, including any interest or additional penalties accrued thereon.

"Employer default" means having an outstanding balance or liability to the old fund or to the uninsured employers' fund or being in policy default, as defined in W. Va. Code § 23-2c-2, failure to maintain mandatory workers' compensation coverage, or failure to fully meet its obligations as a workers' compensation self-insured employer. An employer is not in employer default if it has entered into a repayment agreement with the Insurance Commissioner and remains in compliance with the obligations under the repayment agreement.

"Related party" means a party, whether an individual, corporation, partnership, association, limited liability company or any other form or business association or other entity whatsoever, related to any vendor by blood, marriage, ownership or contract through which the party has a relationship of ownership or other interest with the vendor so that the party will actually or by effect receive or control a portion of the benefit, profit or other consideration from performance of a vendor contract with the party receiving an amount that meets or exceeds five percent of the total contract amount.

AFFIRMATION: By signing this form, the vendor's authorized signer affirms and acknowledges under penalty of law for false swearing (*W. Va. Code §61-5-3*) that neither vendor nor any related party owe a debt as defined above and that neither vendor nor any related party are in employer default as defined above, unless the debt or employer default is permitted under the exception above.

WITNESS THE FOLLOWING SIGNATURE:

Vendor's Name: _____

Authorized Signature: _____ Date: _____

State of _____

County of _____, to-wit:

Taken, subscribed, and sworn to before me this ____ day of _____, 20__.

My Commission expires _____, 20__.

AFFIX SEAL HERE

NOTARY PUBLIC _____

State of West Virginia

VENDOR PREFERENCE CERTIFICATE

Certification and application* is hereby made for Preference in accordance with *West Virginia Code*, §5A-3-37. (Does not apply to construction contracts). *West Virginia Code*, §5A-3-37, provides an opportunity for qualifying vendors to request (at the time of bid) preference for their residency status. Such preference is an evaluation method only and will be applied only to the cost bid in accordance with the *West Virginia Code*. This certificate for application is to be used to request such preference. The Purchasing Division will make the determination of the Vendor Preference, if applicable.

- 1. **Application is made for 2.5% vendor preference for the reason checked:**
 Bidder is an individual resident vendor and has resided continuously in West Virginia for four (4) years immediately preceding the date of this certification; **or**,
 Bidder is a partnership, association or corporation resident vendor and has maintained its headquarters or principal place of business continuously in West Virginia for four (4) years immediately preceding the date of this certification; or 80% of the ownership interest of Bidder is held by another individual, partnership, association or corporation resident vendor who has maintained its headquarters or principal place of business continuously in West Virginia for four (4) years immediately preceding the date of this certification; **or**,
 Bidder is a nonresident vendor which has an affiliate or subsidiary which employs a minimum of one hundred state residents and which has maintained its headquarters or principal place of business within West Virginia continuously for the four (4) years immediately preceding the date of this certification; **or**,
- 2. **Application is made for 2.5% vendor preference for the reason checked:**
 Bidder is a resident vendor who certifies that, during the life of the contract, on average at least 75% of the employees working on the project being bid are residents of West Virginia who have resided in the state continuously for the two years immediately preceding submission of this bid; **or**,
- 3. **Application is made for 2.5% vendor preference for the reason checked:**
 Bidder is a nonresident vendor employing a minimum of one hundred state residents or is a nonresident vendor with an affiliate or subsidiary which maintains its headquarters or principal place of business within West Virginia employing a minimum of one hundred state residents who certifies that, during the life of the contract, on average at least 75% of the employees or Bidder's affiliate's or subsidiary's employees are residents of West Virginia who have resided in the state continuously for the two years immediately preceding submission of this bid; **or**,
- 4. **Application is made for 5% vendor preference for the reason checked:**
 Bidder meets either the requirement of both subdivisions (1) and (2) or subdivision (1) and (3) as stated above; **or**,
- 5. **Application is made for 3.5% vendor preference who is a veteran for the reason checked:**
 Bidder is an individual resident vendor who is a veteran of the United States armed forces, the reserves or the National Guard and has resided in West Virginia continuously for the four years immediately preceding the date on which the bid is submitted; **or**,
- 6. **Application is made for 3.5% vendor preference who is a veteran for the reason checked:**
 Bidder is a resident vendor who is a veteran of the United States armed forces, the reserves or the National Guard, if, for purposes of producing or distributing the commodities or completing the project which is the subject of the vendor's bid and continuously over the entire term of the project, on average at least seventy-five percent of the vendor's employees are residents of West Virginia who have resided in the state continuously for the two immediately preceding years.
- 7. **Application is made for preference as a non-resident small, women- and minority-owned business, in accordance with *West Virginia Code* §5A-3-59 and *West Virginia Code of State Rules*.**
 Bidder has been or expects to be approved prior to contract award by the Purchasing Division as a certified small, women- and minority-owned business.

Bidder understands if the Secretary of Revenue determines that a Bidder receiving preference has failed to continue to meet the requirements for such preference, the Secretary may order the Director of Purchasing to: (a) reject the bid; or (b) assess a penalty against such Bidder in an amount not to exceed 5% of the bid amount and that such penalty will be paid to the contracting agency or deducted from any unpaid balance on the contract or purchase order.

By submission of this certificate, Bidder agrees to disclose any reasonably requested information to the Purchasing Division and authorizes the Department of Revenue to disclose to the Director of Purchasing appropriate information verifying that Bidder has paid the required business taxes, provided that such information does not contain the amounts of taxes paid nor any other information deemed by the Tax Commissioner to be confidential.

Under penalty of law for false swearing (*West Virginia Code*, §61-5-3), Bidder hereby certifies that this certificate is true and accurate in all respects; and that if a contract is issued to Bidder and if anything contained within this certificate changes during the term of the contract, Bidder will notify the Purchasing Division in writing immediately.

Bidder: GRAYBAR ELECTRIC

Signed: 

Date: 2/23/2015

Title: SALES REP

State of West Virginia

VENDOR PREFERENCE CERTIFICATE

Certification and application* is hereby made for Preference in accordance with *West Virginia Code*, §5A-3-37. (Does not apply to construction contracts). *West Virginia Code*, §5A-3-37, provides an opportunity for qualifying vendors to request (at the time of bid) preference for their residency status. Such preference is an evaluation method only and will be applied only to the cost bid in accordance with the *West Virginia Code*. This certificate for application is to be used to request such preference. The Purchasing Division will make the determination of the Vendor Preference, if applicable.

- 1. **Application is made for 2.5% vendor preference for the reason checked:**
 Bidder is an individual resident vendor and has resided continuously in West Virginia for four (4) years immediately preceding the date of this certification; **or**,
 Bidder is a partnership, association or corporation resident vendor and has maintained its headquarters or principal place of business continuously in West Virginia for four (4) years immediately preceding the date of this certification; or 80% of the ownership interest of Bidder is held by another individual, partnership, association or corporation resident vendor who has maintained its headquarters or principal place of business continuously in West Virginia for four (4) years immediately preceding the date of this certification; **or**,
 Bidder is a nonresident vendor which has an affiliate or subsidiary which employs a minimum of one hundred state residents and which has maintained its headquarters or principal place of business within West Virginia continuously for the four (4) years immediately preceding the date of this certification; **or**,
- 2. **Application is made for 2.5% vendor preference for the reason checked:**
 Bidder is a resident vendor who certifies that, during the life of the contract, on average at least 75% of the employees working on the project being bid are residents of West Virginia who have resided in the state continuously for the two years immediately preceding submission of this bid; **or**,
- 3. **Application is made for 2.5% vendor preference for the reason checked:**
 Bidder is a nonresident vendor employing a minimum of one hundred state residents or is a nonresident vendor with an affiliate or subsidiary which maintains its headquarters or principal place of business within West Virginia employing a minimum of one hundred state residents who certifies that, during the life of the contract, on average at least 75% of the employees or Bidder's affiliate's or subsidiary's employees are residents of West Virginia who have resided in the state continuously for the two years immediately preceding submission of this bid; **or**,
- 4. **Application is made for 5% vendor preference for the reason checked:**
 Bidder meets either the requirement of both subdivisions (1) and (2) or subdivision (1) and (3) as stated above; **or**,
- 5. **Application is made for 3.5% vendor preference who is a veteran for the reason checked:**
 Bidder is an individual resident vendor who is a veteran of the United States armed forces, the reserves or the National Guard and has resided in West Virginia continuously for the four years immediately preceding the date on which the bid is submitted; **or**,
- 6. **Application is made for 3.5% vendor preference who is a veteran for the reason checked:**
 Bidder is a resident vendor who is a veteran of the United States armed forces, the reserves or the National Guard, if, for purposes of producing or distributing the commodities or completing the project which is the subject of the vendor's bid and continuously over the entire term of the project, on average at least seventy-five percent of the vendor's employees are residents of West Virginia who have resided in the state continuously for the two immediately preceding years.
- 7. **Application is made for preference as a non-resident small, women- and minority-owned business, in accordance with *West Virginia Code* §5A-3-59 and *West Virginia Code of State Rules*.**
 Bidder has been or expects to be approved prior to contract award by the Purchasing Division as a certified small, women- and minority-owned business.

Bidder understands if the Secretary of Revenue determines that a Bidder receiving preference has failed to continue to meet the requirements for such preference, the Secretary may order the Director of Purchasing to: (a) reject the bid; or (b) assess a penalty against such Bidder in an amount not to exceed 5% of the bid amount and that such penalty will be paid to the contracting agency or deducted from any unpaid balance on the contract or purchase order.

By submission of this certificate, Bidder agrees to disclose any reasonably requested information to the Purchasing Division and authorizes the Department of Revenue to disclose to the Director of Purchasing appropriate information verifying that Bidder has paid the required business taxes, provided that such information does not contain the amounts of taxes paid nor any other information deemed by the Tax Commissioner to be confidential.

Under penalty of law for false swearing (*West Virginia Code*, §61-5-3), Bidder hereby certifies that this certificate is true and accurate in all respects; and that if a contract is issued to Bidder and if anything contained within this certificate changes during the term of the contract, Bidder will notify the Purchasing Division in writing immediately.

Bidder: GRAYBAR ELECTRIC

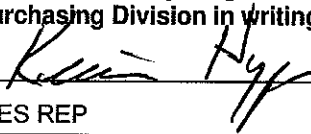
Signed: 

Date: 2/23/2015

Title: SALES REP