



State of West Virginia
 Department of Administration
 Purchasing Division
 2019 Washington Street East
 Post Office Box 50130
 Charleston, WV 25305-0130

Solicitation

NUMBER
AGR1332

PAGE
1

ADDRESS CORRESPONDENCE TO ATTENTION OF
GUY NISBET 304-558-8802

VENDOR

RFQ COPY
 TYPE NAME/ADDRESS HERE

G.A. BROWN & SON, INC.
 215 MILL STREET
 FAIRMONT, WV 26554

SHIP TO

DEPARTMENT OF AGRICULTURE
 LAND SECTION/HUTTONSVILLE FARM
 P.O. BOX 37
 ROUTE 250 SOUTH
 HUTTONSVILLE, WV
 26273 304-558-2222

DATE PRINTED
05/07/2013

BID OPENING DATE: 06/13/2013 BID OPENING TIME 1:30PM

LINE	QUANTITY	UOP	CAT NO	ITEM NUMBER	UNIT PRICE	AMOUNT
0001	1	LS		968-20		
POST FRAME OFFICE AND SHOP BUILDING						
REQUEST FOR SOLICITATION (RFQ)						
THE WEST VIRGINIA STATE PURCHASING DIVISION FOR THE AGENCY, THE WEST VIRGINIA DEPARTMENT OF AGRICULTURE (WVAGR) IS SOLICITING BIDS TO PROVIDE ALL LABOR AND MATERIALS FOR THE CONSTRUCTION OF A "POST AND FRAME" OFFICE AND SHOP BUILDING AT THE WEST VIRGINIA DEPT. OF AGRICULTURE FARM, HUTTONSVILLE, WV. PER THE ATTACHED SPECIFICATIONS.						
***** THIS IS THE END OF RFQ AGR1332 ***** TOTAL:						<u>\$265,250⁰⁰</u>
						06/13/13 01:04:47 PM West Virginia Purchasing Division

SIGNATURE	TELEPHONE 304-363-4500	DATE 06.13.13
TITLE VICE PRESIDENT	FERN 55-0561024	ADDRESS CHANGES TO BE NOTED ABOVE

WHEN RESPONDING TO SOLICITATION, INSERT NAME AND ADDRESS IN SPACE ABOVE LABELED 'VENDOR'

INSTRUCTIONS TO VENDORS SUBMITTING BIDS

- 1. **REVIEW DOCUMENTS THOROUGHLY:** The attached documents contain a solicitation for bids. Please read these instructions and all documents attached in their entirety. These instructions provide critical information about requirements that if overlooked could lead to disqualification of a Vendor's bid. All bids must be submitted in accordance with the provisions contained in these instructions and the Solicitation. Failure to do so may result in disqualification of Vendor's bid.
- 2. **MANDATORY TERMS:** The Solicitation may contain mandatory provisions identified by the use of the words "must," "will," and "shall." Failure to comply with a mandatory term in the Solicitation will result in bid disqualification.
- 3. **PREBID MEETING:** The item identified below shall apply to this Solicitation.

A pre-bid meeting will not be held prior to bid opening.

A **NON-MANDATORY PRE-BID** meeting will be held at the following place and time:

A **MANDATORY PRE-BID** meeting will be held at the following place and time:

WV. Department of Agriculture/ Huttonsville Farm
 Route 250 South
 Huttonsville, WV. 26273

May 21, 2013 at 10:00 AM. EST.

All Vendors submitting a bid must attend the mandatory pre-bid meeting. Failure to attend the mandatory pre-bid meeting shall result in disqualification of the Vendor's bid. No one person attending the pre-bid meeting may represent more than one Vendor.

An attendance sheet provided at the pre-bid meeting shall serve as the official document verifying attendance. The State will not accept any other form of proof or documentation to verify attendance. Any person attending the pre-bid meeting on behalf of a Vendor must list on the attendance sheet his or her name and the name of the Vendor he or she is representing. Additionally, the person attending the pre-bid meeting should include the Vendor's E-Mail address, phone number, and Fax number on the attendance sheet. It is the Vendor's responsibility to locate the attendance sheet and provide the required

information. Failure to complete the attendance sheet as required may result in disqualification of Vendor's bid.

All Vendors should arrive prior to the starting time for the pre-bid. Vendors who arrive after the starting time but prior to the end of the pre-bid will be permitted to sign in, but are charged with knowing all matters discussed at the pre-bid.

Questions submitted at least five business days prior to a scheduled pre-bid will be discussed at the pre-bid meeting if possible. Any discussions or answers to questions at the pre-bid meeting are preliminary in nature and are non-binding. Official and binding answers to questions will be published in a written addendum to the Solicitation prior to bid opening.

4. **VENDOR QUESTION DEADLINE:** Vendors may submit questions relating to this Solicitation to the Purchasing Division. Questions must be submitted in writing. All questions must be submitted on or before the date listed below and to the address listed below in order to be considered. A written response will be published in a Solicitation addendum if a response is possible and appropriate. Non-written discussions, conversations, or questions and answers regarding this Solicitation are preliminary in nature and are non-binding.

Question Submission Deadline:

May 28, 2013 at 2:00 PM. EST.

Submit Questions to:

Guy Nisbet, Senior Buyer

2019 Washington Street, East

P.O. Box 50130

Charleston, WV 25305

Fax: 304.558.3970

Email: Guy.L.Nisbet@WV.Gov

5. **VERBAL COMMUNICATION:** Any verbal communication between the Vendor and any State personnel is not binding, including that made at the mandatory pre-bid conference. Only information issued in writing and added to the Solicitation by an official written addendum by the Purchasing Division is binding.
6. **BID SUBMISSION:** All bids must be signed and delivered by the Vendor to the Purchasing Division at the address listed below on or before the date and time of the bid opening. Any bid received by the Purchasing Division staff is considered to be in the possession of the Purchasing Division and will not be returned for any reason. The bid delivery address is:

Department of Administration, Purchasing Division
 2019 Washington Street East
 P.O. Box 50130,
 Charleston, WV 25305-0130

The bid should contain the information listed below on the face of the envelope or the bid may not be considered:

SEALED BID

BUYER: _____

SOLICITATION NO.: _____

BID OPENING DATE: _____

BID OPENING TIME: _____

FAX NUMBER: _____

In the event that Vendor is responding to a request for proposal, the Vendor shall submit one original technical and one original cost proposal plus convenience copies of each to the Purchasing Division at the address shown above. Additionally, the Vendor should identify the bid type as either a technical or cost proposal on the face of each bid envelope submitted in response to a request for proposal as follows:

BID TYPE: Technical

Cost

7. **BID OPENING:** Bids submitted in response to this Solicitation will be opened at the location identified below on the date and time listed below. Delivery of a bid after the bid opening date and time will result in bid disqualification. For purposes of this Solicitation, a bid is considered delivered when time stamped by the official Purchasing Division time clock.

Bid Opening Date and Time:

June 13, 2013 at 1:30 PM. EST.

Bid Opening Location:

Department of Administration, Purchasing Division
2019 Washington Street East
P.O. Box 50130,
Charleston, WV 25305-0130

8. **ADDENDUM ACKNOWLEDGEMENT:** Changes or revisions to this Solicitation will be made by an official written addendum issued by the Purchasing Division. Vendor should acknowledge receipt of all addenda issued with this Solicitation by completing an Addendum Acknowledgment Form, a copy of which is included herewith. Failure to acknowledge addenda may result in bid disqualification. The addendum acknowledgement should be submitted with the bid to expedite document processing.
9. **BID FORMATTING:** Vendor should type or electronically enter the information onto its bid to prevent errors in the evaluation. Failure to type or electronically enter the information may result in bid disqualification.

GENERAL TERMS AND CONDITIONS:

1. **CONTRACTUAL AGREEMENT:** Issuance of a Purchase Order signed by the Purchasing Division Director, or his designee, and approved as to form by the Attorney General's office constitutes acceptance of this Contract made by and between the State of West Virginia and the Vendor. Vendor's signature on its bid signifies Vendor's agreement to be bound by and accept the terms and conditions contained in this Contract.

2. **DEFINITIONS:** As used in this Solicitation / Contract, the following terms shall have the meanings attributed to them below. Additional definitions may be found in the specifications included with this Solicitation / Contract.
 - 2.1 **"Agency" or "Agencies"** means the agency, board, commission, or other entity of the State of West Virginia that is identified on the first page of the Solicitation or any other public entity seeking to procure goods or services under this Contract.
 - 2.2 **"Contract"** means the binding agreement that is entered into between the State and the Vendor to provide the goods and services requested in the Solicitation.
 - 2.3 **"Director"** means the Director of the West Virginia Department of Administration, Purchasing Division.
 - 2.4 **"Purchasing Division"** means the West Virginia Department of Administration, Purchasing Division.
 - 2.5 **"Purchase Order"** means the document signed by the Agency and the Purchasing Division, and approved as to form by the Attorney General, that identifies the Vendor as the successful bidder and Contract holder.
 - 2.6 **"Solicitation"** means the official solicitation published by the Purchasing Division and identified by number on the first page thereof.
 - 2.7 **"State"** means the State of West Virginia and/or any of its agencies, commissions, boards, etc. as context requires.
 - 2.8 **"Vendor" or "Vendors"** means any entity submitting a bid in response to the Solicitation, the entity that has been selected as the lowest responsible bidder, or the entity that has been awarded the Contract as context requires.

3. **CONTRACT TERM; RENEWAL; EXTENSION:** The term of this Contract shall be determined in accordance with the category that has been identified as applicable to this Contract below:

Term Contract

Initial Contract Term: This Contract becomes effective on

 and extends for a period of year(s).

Renewal Term: This Contract may be renewed upon the mutual written consent of the Agency, and the Vendor, with approval of the Purchasing Division and the Attorney General's office (Attorney General approval is as to form only). Any request for renewal must be submitted to the Purchasing Division Director thirty (30) days prior to the expiration date of the initial contract term or appropriate renewal term. A Contract renewal shall be in accordance with the terms and conditions of the original contract. Renewal of this Contract is limited to successive one (1) year periods. Automatic renewal of this Contract is prohibited. Notwithstanding the foregoing, Purchasing Division approval is not required on agency delegated or exempt purchases. Attorney General approval may be required for vendor terms and conditions.

Reasonable Time Extension: At the sole discretion of the Purchasing Division Director, and with approval from the Attorney General's office (Attorney General approval is as to form only), this Contract may be extended for a reasonable time after the initial Contract term or after any renewal term as may be necessary to obtain a new contract or renew this Contract. Any reasonable time extension shall not exceed twelve (12) months. Vendor may avoid a reasonable time extension by providing the Purchasing Division Director with written notice of Vendor's desire to terminate this Contract 30 days prior to the expiration of the then current term. During any reasonable time extension period, the Vendor may terminate this Contract for any reason upon giving the Purchasing Division Director 30 days written notice. Automatic extension of this Contract is prohibited. Notwithstanding the foregoing, Purchasing Division approval is not required on agency delegated or exempt purchases, but Attorney General approval may be required.

- Fixed Period Contract:** This Contract becomes effective upon Vendor's receipt of the notice to proceed and must be completed within ninety (90) days.
- One Time Purchase:** The term of this Contract shall run from the issuance of the Purchase Order until all of the goods contracted for have been delivered, but in no event shall this Contract extend for more than one fiscal year.
- Other:** See attached.

4. **NOTICE TO PROCEED:** Vendor shall begin performance of this Contract immediately upon receiving notice to proceed unless otherwise instructed by the Agency. Unless otherwise specified, the fully executed Purchase Order will be considered notice to proceed.
5. **QUANTITIES:** The quantities required under this Contract shall be determined in accordance with the category that has been identified as applicable to this Contract below.
- Open End Contract:** Quantities listed in this Solicitation are approximations only, based on estimates supplied by the Agency. It is understood and agreed that the Contract shall cover the quantities actually ordered for delivery during the term of the Contract, whether more or less than the quantities shown.
 - Service:** The scope of the service to be provided will be more clearly defined in the specifications included herewith.
 - Combined Service and Goods:** The scope of the service and deliverable goods to be provided will be more clearly defined in the specifications included herewith.
 - One Time Purchase:** This Contract is for the purchase of a set quantity of goods that are identified in the specifications included herewith. Once those items have been delivered, no additional goods may be procured under this Contract without an appropriate change order approved by the Vendor, Agency, Purchasing Division, and Attorney General's office.
6. **PRICING:** The pricing set forth herein is firm for the life of the Contract, unless specified elsewhere within this Solicitation/Contract by the State. A Vendor's inclusion of price adjustment provisions in its bid, without an express authorization from the State in the Solicitation to do so, may result in bid disqualification.
7. **EMERGENCY PURCHASES:** The Purchasing Division Director may authorize the Agency to purchase goods or services in the open market that Vendor would otherwise provide under this Contract if those goods or services are for immediate or expedited delivery in an emergency. Emergencies shall include, but are not limited to, delays in transportation or an unanticipated increase in the volume of work. An emergency purchase in the open market, approved by the Purchasing Division Director, shall not constitute a breach of this Contract and shall not entitle the Vendor to any form of compensation or damages. This provision does not excuse the State from fulfilling its obligations under a One Time Purchase contract.
8. **REQUIRED DOCUMENTS:** All of the items checked below must be provided to the Purchasing Division by the Vendor as specified below.
- BID BOND:** All Vendors shall furnish a bid bond in the amount of five percent (5%) of the total amount of the bid protecting the State of West Virginia. The bid bond must be submitted with the bid.

PERFORMANCE BOND: The apparent successful Vendor shall provide a performance bond in the amount of . The performance bond must be issued and received by the Purchasing Division prior to Contract award. On construction contracts, the performance bond must be 100% of the Contract value.

LABOR/MATERIAL PAYMENT BOND: The apparent successful Vendor shall provide a labor/material payment bond in the amount of 100% of the Contract value. The labor/material payment bond must be issued and delivered to the Purchasing Division prior to Contract award.

In lieu of the Bid Bond, Performance Bond, and Labor/Material Payment Bond, the Vendor may provide certified checks, cashier's checks, or irrevocable letters of credit. Any certified check, cashier's check, or irrevocable letter of credit provided in lieu of a bond must be of the same amount and delivered on the same schedule as the bond it replaces. A letter of credit submitted in lieu of a performance and labor/material payment bond will only be allowed for projects under \$100,000. Personal or business checks are not acceptable.

MAINTENANCE BOND: The apparent successful Vendor shall provide a two (2) year maintenance bond covering the roofing system. The maintenance bond must be issued and delivered to the Purchasing Division prior to Contract award.

WORKERS' COMPENSATION INSURANCE: The apparent successful Vendor shall have appropriate workers' compensation insurance and shall provide proof thereof upon request.

INSURANCE: The apparent successful Vendor shall furnish proof of the following insurance prior to Contract award:

Commercial General Liability Insurance:
 or more.

Builders Risk Insurance: builders risk – all risk insurance in an amount equal to 100% of the amount of the Contract.

The apparent successful Vendor shall also furnish proof of any additional insurance requirements contained in the specifications prior to Contract award regardless of whether or not that insurance requirement is listed above.

[] LICENSE(S) / CERTIFICATIONS / PERMITS: In addition to anything required under the Section entitled Licensing, of the General Terms and Conditions, the apparent successful Vendor shall furnish proof of the following licenses, certifications, and/or permits prior to Contract award, in a form acceptable to the Purchasing Division.

[]	
[]	
[]	
[]	

The apparent successful Vendor shall also furnish proof of any additional licenses or certifications contained in the specifications prior to Contract award regardless of whether or not that requirement is listed above.

9. LITIGATION BOND: The Director reserves the right to require any Vendor that files a protest of an award to submit a litigation bond in the amount equal to one percent of the lowest bid submitted or \$5,000, whichever is greater. The entire amount of the bond shall be forfeited if the hearing officer determines that the protest was filed for frivolous or improper purpose, including but not limited to, the purpose of harassing, causing unnecessary delay, or needless expense for the Agency. All litigation bonds shall be made payable to the Purchasing Division. In lieu of a bond, the protester may submit a cashier's check or certified check payable to the Purchasing Division. Cashier's or certified checks will be deposited with and held by the State Treasurer's office. If it is determined that the protest has not been filed for frivolous or improper purpose, the bond or deposit shall be returned in its entirety.

10. ALTERNATES: Any model, brand, or specification listed herein establishes the acceptable level of quality only and is not intended to reflect a preference for, or in any way favor, a particular brand or vendor. Vendors may bid alternates to a listed model or brand provided that the alternate is at least equal to the model or brand and complies with the required specifications. The equality of any alternate being bid shall be determined by the State at its sole discretion. Any Vendor bidding an alternate model or brand should clearly identify the alternate items in its bid and should include manufacturer's specifications, industry literature, and/or any other relevant documentation demonstrating the equality of the alternate items. Failure to provide information for alternate items may be grounds for rejection of a Vendor's bid.

11. EXCEPTIONS AND CLARIFICATIONS: The Solicitation contains the specifications that shall form the basis of a contractual agreement. Vendor shall clearly mark any exceptions, clarifications, or

other proposed modifications in its bid. Exceptions to, clarifications of, or modifications of a requirement or term and condition of the Solicitation may result in bid disqualification.

12. LIQUIDATED DAMAGES: Vendor shall pay liquidated damages in the amount

	for	

This clause shall in no way be considered exclusive and shall not limit the State or Agency's right to pursue any other available remedy.

- 13. ACCEPTANCE/REJECTION:** The State may accept or reject any bid in whole, or in part. Vendor's signature on its bid signifies acceptance of the terms and conditions contained in the Solicitation and Vendor agrees to be bound by the terms of the Contract, as reflected in the Purchase Order, upon receipt.
- 14. REGISTRATION:** Prior to Contract award, the apparent successful Vendor must be properly registered with the West Virginia Purchasing Division and must have paid the \$125 fee if applicable.
- 15. COMMUNICATION LIMITATIONS:** In accordance with West Virginia Code of State Rules §148-1-6.6, communication with the State of West Virginia or any of its employees regarding this Solicitation during the solicitation, bid, evaluation or award periods, except through the Purchasing Division, is strictly prohibited without prior Purchasing Division approval. Purchasing Division approval for such communication is implied for all agency delegated and exempt purchases.
- 16. FUNDING:** This Contract shall continue for the term stated herein, contingent upon funds being appropriated by the Legislature or otherwise being made available. In the event funds are not appropriated or otherwise made available, this Contract becomes void and of no effect beginning on July 1 of the fiscal year for which funding has not been appropriated or otherwise made available.
- 17. PAYMENT:** Payment in advance is prohibited under this Contract. Payment may only be made after the delivery and acceptance of goods or services. The Vendor shall submit invoices, in arrears, to the Agency at the address on the face of the purchase order labeled "Invoice To."
- 18. UNIT PRICE:** Unit prices shall prevail in cases of a discrepancy in the Vendor's bid.
- 19. DELIVERY:** All quotations are considered freight on board destination ("F.O.B. destination") unless alternate shipping terms are clearly identified in the bid. Vendor's listing of shipping terms that contradict the shipping terms expressly required by this Solicitation may result in bid disqualification.
- 20. INTEREST:** Interest attributable to late payment will only be permitted if authorized by the West Virginia Code. Presently, there is no provision in the law for interest on late payments.
- 21. PREFERENCE:** Vendor Preference may only be granted upon written request and only in accordance with the West Virginia Code § 5A-3-37 and the West Virginia Code of State Rules. A Resident Vendor Certification form has been attached hereto to allow Vendor to apply for the preference. Vendor's

failure to submit the Resident Vendor Certification form with its bid will result in denial of Vendor Preference. Vendor Preference does not apply to construction projects.

- 22. SMALL, WOMEN-OWNED, OR MINORITY-OWNED BUSINESSES:** For any solicitations publicly advertised for bid on or after July 1, 2012, in accordance with West Virginia Code §5A-3-37(a)(7) and W. Va. CSR § 148-22-9, any non-resident vendor certified as a small, women-owned, or minority-owned business under W. Va. CSR § 148-22-9 shall be provided the same preference made available to any resident vendor. Any non-resident small, women-owned, or minority-owned business must identify itself as such in writing, must submit that writing to the Purchasing Division with its bid, and must be properly certified under W. Va. CSR § 148-22-9 prior to submission of its bid to receive the preferences made available to resident vendors. Preference for a non-resident small, women-owned, or minority owned business shall be applied in accordance with W. Va. CSR § 148-22-9.
- 23. TAXES:** The Vendor shall pay any applicable sales, use, personal property or any other taxes arising out of this Contract and the transactions contemplated thereby. The State of West Virginia is exempt from federal and state taxes and will not pay or reimburse such taxes.
- 24. CANCELLATION:** The Purchasing Division Director reserves the right to cancel this Contract immediately upon written notice to the vendor if the materials or workmanship supplied do not conform to the specifications contained in the Contract. The Purchasing Division Director may cancel any purchase or Contract upon 30 days written notice to the Vendor in accordance with West Virginia Code of State Rules § 148-1-7.16.2.
- 25. WAIVER OF MINOR IRREGULARITIES:** The Director reserves the right to waive minor irregularities in bids or specifications in accordance with West Virginia Code of State Rules § 148-1-4.6.
- 26. TIME:** Time is of the essence with regard to all matters of time and performance in this Contract.
- 27. APPLICABLE LAW:** This Contract is governed by and interpreted under West Virginia law without giving effect to its choice of law principles. Any information provided in specification manuals, or any other source, verbal or written, which contradicts or violates the West Virginia Constitution, West Virginia Code or West Virginia Code of State Rules is void and of no effect.
- 28. COMPLIANCE:** Vendor shall comply with all applicable federal, state, and local laws, regulations and ordinances. By submitting a bid, Vendors acknowledge that they have reviewed, understand, and will comply with all applicable law.
- 29. PREVAILING WAGE:** On any contract for the construction of a public improvement, Vendor and any subcontractors utilized by Vendor shall pay a rate or rates of wages which shall not be less than the fair minimum rate or rates of wages (prevailing wage), as established by the West Virginia Division of Labor under West Virginia Code §§ 21-5A-1 et seq. and available at <http://www.sos.wv.gov/administrative-law/wagerates/Pages/default.aspx>. Vendor shall be responsible for ensuring compliance with prevailing wage requirements and determining when prevailing wage

requirements are applicable. The required contract provisions contained in West Virginia Code of State Rules § 42-7-3 are specifically incorporated herein by reference.

- 30. ARBITRATION:** Any references made to arbitration contained in this Contract, Vendor's bid, or in any American Institute of Architects documents pertaining to this Contract are hereby deleted, void, and of no effect.
- 31. MODIFICATIONS:** This writing is the parties' final expression of intent. Notwithstanding anything contained in this Contract to the contrary, no modification of this Contract shall be binding without mutual written consent of the Agency, and the Vendor, with approval of the Purchasing Division and the Attorney General's office (Attorney General approval is as to form only). **No Change shall be implemented by the Vendor until such time as the Vendor receives an approved written change order from the Purchasing Division.**
- 32. WAIVER:** The failure of either party to insist upon a strict performance of any of the terms or provision of this Contract, or to exercise any option, right, or remedy herein contained, shall not be construed as a waiver or a relinquishment for the future of such term, provision, option, right, or remedy, but the same shall continue in full force and effect. Any waiver must be expressly stated in writing and signed by the waiving party.
- 33. SUBSEQUENT FORMS:** The terms and conditions contained in this Contract shall supersede any and all subsequent terms and conditions which may appear on any form documents submitted by Vendor to the Agency or Purchasing Division such as price lists, order forms, invoices, sales agreements, or maintenance agreements, and includes internet websites or other electronic documents. Acceptance or use of Vendor's forms does not constitute acceptance of the terms and conditions contained thereon.
- 34. ASSIGNMENT:** Neither this Contract nor any monies due, or to become due hereunder, may be assigned by the Vendor without the express written consent of the Agency, the Purchasing Division, the Attorney General's office (as to form only), and any other government agency or office that may be required to approve such assignments. Notwithstanding the foregoing, Purchasing Division approval may or may not be required on certain agency delegated or exempt purchases.
- 35. WARRANTY:** The Vendor expressly warrants that the goods and/or services covered by this Contract will: (a) conform to the specifications, drawings, samples, or other description furnished or specified by the Agency; (b) be merchantable and fit for the purpose intended; and (c) be free from defect in material and workmanship.
- 36. STATE EMPLOYEES:** State employees are not permitted to utilize this Contract for personal use and the Vendor is prohibited from permitting or facilitating the same.
- 37. BANKRUPTCY:** In the event the Vendor files for bankruptcy protection, the State of West Virginia may deem this Contract null and void, and terminate this Contract without notice.

38. HIPAA BUSINESS ASSOCIATE ADDENDUM: The West Virginia State Government HIPAA Business Associate Addendum (BAA), approved by the Attorney General, is available online at <http://www.state.wv.us/admin/purchase/vrc/hipaa.html> and is hereby made part of the agreement provided that the Agency meets the definition of a Covered entity (45 CFR §160.103) and will be disclosing Protected Health Information (45 CFR §160.103) to the Vendor. Additionally, the HIPAA Privacy, Security, Enforcement & Breach Notification Final Omnibus Rule was published on January 25, 2013. It may be viewed online at <http://www.gpo.gov/fdsys/pkg/FR-2013-01-25/pdf/2013-01073.pdf>. Any organization, that qualifies as the Agency's Business Associate, is expected to be in compliance with this Final Rule. For those Business Associates entering into contracts with a HIPAA Covered State Agency between January 25, 2013 and the release of the 2013 WV State Agency Business Associate Agreement, or September 23, 2013 (whichever is earlier), be advised that you will be required to comply with the 2013 WV State Agency Business Associate Agreement. For those Business Associates with contracts with a HIPAA Covered State Agency executed prior to January 25, 2013, be advised that upon renewal or modification, you will be required to comply with the 2013 WV State Agency Business Associate Agreement no later than September 22, 2014.

39. CONFIDENTIALITY: The Vendor agrees that it will not disclose to anyone, directly or indirectly, any such personally identifiable information or other confidential information gained from the Agency, unless the individual who is the subject of the information consents to the disclosure in writing or the disclosure is made pursuant to the Agency's policies, procedures, and rules. Vendor further agrees to comply with the Confidentiality Policies and Information Security Accountability Requirements, set forth in <http://www.state.wv.us/admin/purchase/privacy/default.html>.

40. DISCLOSURE: Vendor's response to the Solicitation and the resulting Contract are considered public documents and will be disclosed to the public in accordance with the laws, rules, and policies governing the West Virginia Purchasing Division. Those laws include, but are not limited to, the Freedom of Information Act found in West Virginia Code § 29B-1-1 et seq.

If a Vendor considers any part of its bid to be exempt from public disclosure, Vendor must so indicate by specifically identifying the exempt information, identifying the exemption that applies, providing a detailed justification for the exemption, segregating the exempt information from the general bid information, and submitting the exempt information as part of its bid but in a segregated and clearly identifiable format. Failure to comply with the foregoing requirements will result in public disclosure of the Vendor's bid without further notice. A Vendor's act of marking all or nearly all of its bid as exempt is not sufficient to avoid disclosure and WILL NOT BE HONORED. Vendor's act of marking a bid or any part thereof as "confidential" or "proprietary" is not sufficient to avoid disclosure and WILL NOT BE HONORED. In addition, a legend or other statement indicating that all or substantially all of the bid is exempt from disclosure is not sufficient to avoid disclosure and WILL NOT BE HONORED. Vendor will be required to defend any claimed exemption for nondisclosure in the event of an administrative or judicial challenge to the State's nondisclosure. Vendor must indemnify the State for any costs incurred related to any exemptions claimed by Vendor. Any questions regarding the applicability of the various public records laws should be addressed to your own legal counsel prior to bid submission.

41. **LICENSING:** In accordance with West Virginia Code of State Rules §148-1-6.1.7, Vendor must be licensed and in good standing in accordance with any and all state and local laws and requirements by any state or local agency of West Virginia, including, but not limited to, the West Virginia Secretary of State's Office, the West Virginia Tax Department, West Virginia Insurance Commission, or any other state agency or political subdivision. Upon request, the Vendor must provide all necessary releases to obtain information to enable the Purchasing Division Director or the Agency to verify that the Vendor is licensed and in good standing with the above entities.
42. **ANTITRUST:** In submitting a bid to, signing a contract with, or accepting a Purchase Order from any agency of the State of West Virginia, the Vendor agrees to convey, sell, assign, or transfer to the State of West Virginia all rights, title, and interest in and to all causes of action it may now or hereafter acquire under the antitrust laws of the United States and the State of West Virginia for price fixing and/or unreasonable restraints of trade relating to the particular commodities or services purchased or acquired by the State of West Virginia. Such assignment shall be made and become effective at the time the purchasing agency tenders the initial payment to Vendor.
43. **VENDOR CERTIFICATIONS:** By signing its bid or entering into this Contract, Vendor certifies (1) that its bid was made without prior understanding, agreement, or connection with any corporation, firm, limited liability company, partnership, person or entity submitting a bid for the same material, supplies, equipment or services; (2) that its bid is in all respects fair and without collusion or fraud; (3) that this Contract is accepted or entered into without any prior understanding, agreement, or connection to any other entity that could be considered a violation of law; and (4) that it has reviewed this RFQ in its entirety; understands the requirements, terms and conditions, and other information contained herein. Vendor's signature on its bid also affirms that neither it nor its representatives have any interest, nor shall acquire any interest, direct or indirect, which would compromise the performance of its services hereunder. Any such interests shall be promptly presented in detail to the Agency.

The individual signing this bid on behalf of Vendor certifies that he or she is authorized by the Vendor to execute this bid or any documents related thereto on Vendor's behalf; that he or she is authorized to bind the Vendor in a contractual relationship; and that, to the best of his or her knowledge, the Vendor has properly registered with any State agency that may require registration.

44. **PURCHASING CARD ACCEPTANCE:** The State of West Virginia currently utilizes a Purchasing Card program, administered under contract by a banking institution, to process payment for goods and services. The Vendor must accept the State of West Virginia's Purchasing Card for payment of all orders under this Contract unless the box below is checked.

Vendor is not required to accept the State of West Virginia's Purchasing Card as payment for all goods and services.

45. **VENDOR RELATIONSHIP:** The relationship of the Vendor to the State shall be that of an independent contractor and no principal-agent relationship or employer-employee relationship is contemplated or created by this Contract. The Vendor as an independent contractor is solely liable for the acts and omissions of its employees and agents. Vendor shall be responsible for selecting,

supervising, and compensating any and all individuals employed pursuant to the terms of this Solicitation and resulting contract. Neither the Vendor, nor any employees or subcontractors of the Vendor, shall be deemed to be employees of the State for any purpose whatsoever. Vendor shall be exclusively responsible for payment of employees and contractors for all wages and salaries, taxes, withholding payments, penalties, fees, fringe benefits, professional liability insurance premiums, contributions to insurance and pension, or other deferred compensation plans, including but not limited to, Workers' Compensation and Social Security obligations, licensing fees, *etc.* and the filing of all necessary documents, forms and returns pertinent to all of the foregoing. Vendor shall hold harmless the State, and shall provide the State and Agency with a defense against any and all claims including, but not limited to, the foregoing payments, withholdings, contributions, taxes, Social Security taxes, and employer income tax returns.

- 46. INDEMNIFICATION:** The Vendor agrees to indemnify, defend, and hold harmless the State and the Agency, their officers, and employees from and against: (1) Any claims or losses for services rendered by any subcontractor, person, or firm performing or supplying services, materials, or supplies in connection with the performance of the Contract; (2) Any claims or losses resulting to any person or entity injured or damaged by the Vendor, its officers, employees, or subcontractors by the publication, translation, reproduction, delivery, performance, use, or disposition of any data used under the Contract in a manner not authorized by the Contract, or by Federal or State statutes or regulations; and (3) Any failure of the Vendor, its officers, employees, or subcontractors to observe State and Federal laws including, but not limited to, labor and wage and hour laws.
- 47. PURCHASING AFFIDAVIT:** In accordance with West Virginia Code § 5A-3-10a, all Vendors are required to sign, notarize, and submit the Purchasing Affidavit stating that neither the Vendor nor a related party owe a debt to the State in excess of \$1,000. The affidavit must be submitted prior to award, but should be submitted with the Vendor's bid. A copy of the Purchasing Affidavit is included herewith.
- 48. ADDITIONAL AGENCY AND LOCAL GOVERNMENT USE:** This Contract may be utilized by and extends to other agencies, spending units, and political subdivisions of the State of West Virginia; county, municipal, and other local government bodies; and school districts ("Other Government Entities"). This Contract shall be extended to the aforementioned Other Government Entities on the same prices, terms, and conditions as those offered and agreed to in this Contract. If the Vendor does not wish to extend the prices, terms, and conditions of its bid and subsequent contract to the Other Government Entities, the Vendor must clearly indicate such refusal in its bid. A refusal to extend this Contract to the Other Government Entities shall not impact or influence the award of this Contract in any manner.
- 49. CONFLICT OF INTEREST:** Vendor, its officers or members or employees, shall not presently have or acquire any interest, direct or indirect, which would conflict with or compromise the performance of its obligations hereunder. Vendor shall periodically inquire of its officers, members and employees to ensure that a conflict of interest does not arise. Any conflict of interest discovered shall be promptly presented in detail to the Agency.

50. REPORTS: Vendor shall provide the Agency and/or the Purchasing Division with the following reports identified by a checked box below:

- Such reports as the Agency and/or the Purchasing Division may request. Requested reports may include, but are not limited to, quantities purchased, agencies utilizing the contract, total contract expenditures by agency, etc.
- Quarterly reports detailing the total quantity of purchases in units and dollars, along with a listing of purchases by agency. Quarterly reports should be delivered to the Purchasing Division via email at purchasing.requisitions@wv.gov.

51. BACKGROUND CHECK: In accordance with W. Va. Code § 15-2D-3, the Director of the Division of Protective Services shall require any service provider whose employees are regularly employed on the grounds or in the buildings of the Capitol complex or who have access to sensitive or critical information to submit to a fingerprint-based state and federal background inquiry through the state repository. The service provider is responsible for any costs associated with the fingerprint-based state and federal background inquiry.

After the contract for such services has been approved, but before any such employees are permitted to be on the grounds or in the buildings of the Capitol complex or have access to sensitive or critical information, the service provider shall submit a list of all persons who will be physically present and working at the Capitol complex to the Director of the Division of Protective Services for purposes of verifying compliance with this provision.

The State reserves the right to prohibit a service provider's employees from accessing sensitive or critical information or to be present at the Capitol complex based upon results addressed from a criminal background check.

Service providers should contact the West Virginia Division of Protective Services by phone at (304) 558-9911 for more information.

52. PREFERENCE FOR USE OF DOMESTIC STEEL PRODUCTS: Except when authorized by the Director of the Purchasing Division pursuant to W. Va. Code § 5A-3-56, no contractor may use or supply steel products for a State Contract Project other than those steel products made in the United States. A contractor who uses steel products in violation of this section may be subject to civil penalties pursuant to W. Va. Code § 5A-3-56. As used in this section:

- a. "State Contract Project" means any erection or construction of, or any addition to, alteration of or other improvement to any building or structure, including, but not limited to, roads or highways, or the installation of any heating or cooling or ventilating plants or other equipment, or the supply of and materials for such projects, pursuant to a contract with the State of West Virginia for which bids were solicited on or after June 6, 2001.
- b. "Steel Products" means products rolled, formed, shaped, drawn, extruded, forged, cast, fabricated or otherwise similarly processed, or processed by a combination of two or more or

such operations, from steel made by the open hearth, basic oxygen, electric furnace, Bessemer or other steel making process.

The Purchasing Division Director may, in writing, authorize the use of foreign steel products if:

- a. The cost for each contract item used does not exceed one tenth of one percent (.1%) of the total contract cost or two thousand five hundred dollars (\$2,500.00), whichever is greater. For the purposes of this section, the cost is the value of the steel product as delivered to the project; or
- b. The Director of the Purchasing Division determines that specified steel materials are not produced in the United States in sufficient quantity or otherwise are not reasonably available to meet contract requirements.

53. PREFERENCE FOR USE OF DOMESTIC ALUMINUM, GLASS, AND STEEL: In Accordance with W. Va. Code § 5-19-1 et seq., and W. Va. CSR § 148-10-1 et seq., for every contract or subcontract, subject to the limitations contained herein, for the construction, reconstruction, alteration, repair, improvement or maintenance of public works or for the purchase of any item of machinery or equipment to be used at sites of public works, only domestic aluminum, glass or steel products shall be supplied unless the spending officer determines, in writing, after the receipt of offers or bids, (1) that the cost of domestic aluminum, glass or steel products is unreasonable or inconsistent with the public interest of the State of West Virginia, (2) that domestic aluminum, glass or steel products are not produced in sufficient quantities to meet the contract requirements, or (3) the available domestic aluminum, glass, or steel do not meet the contract specifications. This provision only applies to public works contracts awarded in an amount more than fifty thousand dollars (\$50,000) or public works contracts that require more than ten thousand pounds of steel products.

The cost of domestic aluminum, glass, or steel products may be unreasonable if the cost is more than twenty percent (20%) of the bid or offered price for foreign made aluminum, glass, or steel products. If the domestic aluminum, glass or steel products to be supplied or produced in a "substantial labor surplus area", as defined by the United States Department of Labor, the cost of domestic aluminum, glass, or steel products may be unreasonable if the cost is more than thirty percent (30%) of the bid or offered price for foreign made aluminum, glass, or steel products.

This preference shall be applied to an item of machinery or equipment, as indicated above, when the item is a single unit of equipment or machinery manufactured primarily of aluminum, glass or steel, is part of a public works contract and has the sole purpose or of being a permanent part of a single public works project. This provision does not apply to equipment or machinery purchased by a spending unit for use by that spending unit and not as part of a single public works project.

All bids and offers including domestic aluminum, glass or steel products that exceed bid or offer prices including foreign aluminum, glass or steel products after application of the preferences provided in this provision may be reduced to a price equal to or lower than the lowest bid or offer price for foreign aluminum, glass or steel products plus the applicable preference. If the reduced bid or offer prices are made in writing and supersede the prior bid or offer prices, all bids or offers, including the reduced bid or offer prices, will be reevaluated in accordance with this rule.

ADDITIONAL TERMS AND CONDITIONS (Construction Contracts Only)

1. **CONTRACTOR'S LICENSE:** West Virginia Code § 21-11-2 requires that all persons desiring to perform contracting work in this state be licensed. The West Virginia Contractors Licensing Board is empowered to issue the contractor's license. Applications for a contractor's license may be made by contacting the West Virginia Division of Labor.

West Virginia Code § 21-11-11 requires any prospective Vendor to include the contractor's license number on its bid. Failure to include a contractor's license number on the bid shall result in Vendor's bid being disqualified. Vendors should include a contractor's license number in the space provided below.

Contractor's Name: G.A.BROWN & SON, INC.

Contractor's License No. WV007675

The apparent successful Vendor must furnish a copy of its contractor's license prior to the issuance of a purchase order/contract.

2. **DRUG-FREE WORKPLACE:** W. Va. Code § 21-ID-5 provides that any solicitation for a public improvement contract requires each Vendor that submits a bid for the work to submit at the same time an affidavit that the Vendor has a written plan for a drug-free workplace policy. To comply with this law, Vendor must either complete the enclosed drug-free workplace affidavit and submit the same with its bid or complete a similar affidavit that fulfills all of the requirements of the applicable code. Failure to submit the signed and notarized drug-free workplace affidavit, or a similar affidavit that fully complies with the requirements of the applicable code, with the bid shall result in disqualification of Vendor's bid.
3. **AIA DOCUMENTS:** All construction contracts that will be completed in conjunction with architectural services procured under Chapter 5G of the West Virginia Code will be governed by the AIA A101-2007 and A201-2007 or the A107-2007 documents, as amended by the Supplementary Conditions for the State of West Virginia, in addition to the terms and conditions contained herein.
4. **SUBCONTRACTOR LIST SUBMISSION:** In accordance with W. Va. Code § 5-22-1, The apparent low bidder on a contract for the construction, alteration, decoration, painting or improvement of a new or existing building or structure valued at more than \$500,000.00 shall submit a list of all subcontractors who will perform more than \$25,000.00 of work on the project including labor and materials. This provision shall not apply to any other construction projects, such as highway, mine reclamation, water or sewer projects.

- c. **Required Information.** The subcontractor list shall contain the following information:
- i. Bidder's name
 - ii. Name of each subcontractor
 - iii. License numbers as required by W. Va. Code § 21-11-1 et. seq.
 - iv. Notation that no subcontractors will be used if the bidder will perform the work
- d. **Submission.** The completed subcontractor list shall be provided to the Purchasing Division within one business day of the opening of bids for review. Failure to submit the subcontractor list within one business day after the deadline for submitting bids shall result in disqualification of the bid.
- e. **Substitution of Subcontractor.** Written approval must be obtained from the Purchasing Division before any subcontractor substitution is permitted. Substitutions are not permitted unless:
- i. The subcontractor listed in the original bid has filed for bankruptcy;
 - ii. The subcontractor in the original bid has been debarred or suspended; or
 - iii. The contractor certifies in writing that the subcontractor listed in the original bill fails, is unable, or refuses to perform his subcontract.
5. **GREEN BUILDINGS MINIMUM ENERGY STANDARDS:** In accordance with § 22-29-4, all new building construction projects of public agencies that have not entered the schematic design phase prior to July 1, 2012, or any building construction project receiving state grant funds and appropriations, including public schools, that have not entered the schematic design phase prior to July 1, 2012, shall be designed and constructed complying with the ICC International Energy Conservation Code, adopted by the State Fire Commission, and the ANSI/ASHRAE/IESNA Standard 90.1-2007: *Provided*, That if any construction project has a commitment of federal funds to pay for a portion of such project, this provision shall only apply to the extent such standards are consistent with the federal standards.

REQUEST FOR QUOTATION
AGR1332 Post Frame Office and Shop Building

SPECIFICATIONS

1. **PURPOSE AND SCOPE:** The West Virginia Purchasing Division is soliciting bids on behalf of the West Virginia Department of Agriculture (WVDA) to establish a contract for the one time purchase of labor and materials required to construct a pre-engineered post frame office and shop building at the West Virginia Department of Agriculture, Huttonsville Farm, Route 250 South, Huttonsville, WV, as stated herein.

2. **DEFINITIONS:** The terms listed below shall have the meanings assigned to them below. Additional definitions can be found in section 2 of the General Terms and Conditions.
 - 2.1 **“Contract Item”** means pre-engineered post frame office and shop building.

 - 2.2 **“Pricing Page”** means the pages upon which Vendor should list its proposed price for the Contract Items in the manner requested. The Pricing Page is either included on the last page of this RFQ or attached hereto as Exhibit A.

 - 2.3 **“RFQ”** means the official request for quotation published by the Purchasing Division and identified as AGR1332.

3. **GENERAL REQUIREMENTS:**
 - 3.1 **Mandatory Contract Item Requirements:** Contract Item must meet or exceed the mandatory requirements listed below.
 - 3.1.1 **Post Frame Office and Shop Building**
 - 3.1.1.1 Post frame office and shop building must be in compliance with the 2009 International Building Code. (WWW.iccsafe.org)

 - 3.1.1.2 Post frame office and shop building must be in accordance with Randolph County and West Virginia State building codes for this location.

 - 3.1.1.3 The Contractor will acquire all necessary permits and licenses to comply with applicable laws, Federal, State, or Municipal and all regulations or ordinances of any regulating body.

 - 3.1.1.4 Contractor must supply all materials, tools, tool accessories, personal safety equipment, and supplies necessary to complete the responsibilities of

REQUEST FOR QUOTATION
AGR1332 Post Frame Office and Shop Building

this contract. Contractor will be responsible for the removal of all waste and debris on a daily basis, as a result of performing this contract.

3.1.1.5 Contractor will be responsible for all mileage and travel costs, including travel time associated with this contract.

3.1.1.6 West Virginia State Code §21-11-2 requires that all persons desiring to perform contracting work in this State must be licensed. The Contractor must furnish a copy of their contractor's license prior to issuance of a purchase order/contract.

3.1.1.7 Contractor must furnish proof of commercial general liability insurance prior to issuance of contract. Unless otherwise specified in the bid documents, the minimum amount of insurance coverage required is \$1,000,000.00 (one million dollars)

3.1.1.8 Any damage to WVDA property from misuse or abuse by the Contractor or their workers will be repaired or replaced by the Contractor at no expense to the WVDA.

3.1.1.9 Sanitary facilities will not be available. The Contractor will be responsible for the provision and maintenance of portable toilets or their equal.

3.1.1.10 A trailer or temporary storage building must be set on the site by the Contractor to secure all equipment and tools. The location of storage area must be approved by the WVDA contact. The Contractor is responsible for his tools, equipment, and materials.

3.1.1.11 Access to the worksite is limited to Monday through Saturday, between 6:00A.M. and 5:00P.M.

3.1.1.12 Any and all work to be performed to successfully execute the terms of this contract by a third party or sub-contractor, must be pre-approved by the owner or their representative. All such work will remain the responsibility of the successful bidder/contractor with regard to all labor, materials, and fees associated with the sub-contracting and any and all associated responsibilities. Under no circumstances will the contractor transfer

REQUEST FOR QUOTATION
AGR1332 Post Frame Office and Shop Building

responsibility for any work as described herein by a third party or sub-contractor.

3.1.1.13 The job will be turn-key for all labor, materials, and equipment necessary to complete the project.

3.1.1.14 Construction shop drawings stamped and signed by a professional engineer licensed by the State of West Virginia must be submitted for review and approval along with "as-built" on sight drawings. Drawings must meet the 2006 International Building Code and other applicable codes required by the State of West Virginia.

3.1.1.15 Post frame office and shop building will be attached to existing concrete pad using approved fastening system according to building manufacturers specifications. Outside measurements to be 46'8" (forty-six foot eight inch) wide by 65' (sixty-five foot) long by 16' (sixteen) foot high to bottom of trusses.

3.1.1.16 Overhang is not required on new building.

3.1.1.17 Posts, secondary framing, purlins, girts, and permanent bracing shall be installed per the design of building manufacturer.

3.1.1.18 All roofing, siding, trims, gutters, downspouts, and flashings shall be furnished in a standard color to match the existing building, and be installed per building manufacturer's instructions

3.1.1.19 The post frame office and shop building will be constructed 10' from the new post frame barn that was built in 2012, as shown on WVDA drawing No.1 (refer to attachments).

3.1.1.20 South wall of building will have one 3'0" x 6' 8" commercial steel door located across from door on existing building, as shown on WVDA drawing No.1 (refer to attachments).

3.1.1.21 East wall of post frame office and shop building to have two operational, insulated sectional, commercial overhead steel garage doors as shown in WVDA drawing No.5 with electronic openers. One 12' wide by 14'

REQUEST FOR QUOTATION
AGR1332 Post Frame Office and Shop Building

high, the other 16' wide by 14' high. East wall also to have one 3'0" x 6'8" commercial steel door next to office also shown on WVDA drawing No.1. Exterior doors to be 18 gauge minimum such as Steelcraft Galvamealed L-18 or equal.

3.1.1.22 Exterior doors will have 4"x25" light. Doors and frames will be primed and finish painted to match color of doors on existing building and have commercial door closers Norton brand 1600 or equal. Locks will be keyed alike lever type Sargent 28CLL26D with panic device 3828FEN or equal.

3.1.1.23 Interior walls and ceiling of shop area will be covered with white uni-rib 29 gauge galvanized steel with R-19 insulation with vapor barrier for all exterior walls and bottom cord of roof trusses

3.1.1.24 Roof of post frame office and shop building will be insulated with 2" (two inch) R-6 PFSK fiberglass insulation.

3.1.1.25 Snow retention system will be installed in accordance to manufacturer's instructions with special consideration for protection over doors and gutters.

3.1.1.26 Inside office space will be constructed in the inside north east corner of the post frame office and shop building, as shown on WVDA drawings Nos.1, 7, & 8 to the outside dimensions of 24' x 12' x 9' (nine foot) height, with 2"x6" framing 16" on center with double top plate.

3.1.1.27 Overhead storage area of office will be constructed of 2"x12" southern yellow pine floor joist with 3/4" Advantech (or equal) sheathing applied with construction adhesive and manufacturer approved fasteners.

3.1.1.28 Office area will have one ADA compliant unisex restroom with one commode and one sink as shown on WVDA drawing No.1.

3.1.1.29 Office area will have one shower room with 60" shower, as also shown on WVDA drawing No.1

REQUEST FOR QUOTATION
AGR1332 Post Frame Office and Shop Building

3.1.1.30 Shower and restroom will be supplied with a 28 (twenty eight) gallon electric water heater; Whirlpool low profile E2F30LD35V or equal, installed overhead of shower room in overhead storage area. Water heater will have a drain pan installed under it and drain to outside of building. Restroom and shower and water heater to be supplied with ¾" soldered copper type "L" with ½" runs to the fixtures. WVDA to have water hook up available near shower wall as shown on WVDA drawing No.1. Contractor to do all plumbing and electrical hookups.

3.1.1.31 Office area walls and area between overhead storage will be insulated with R-19 for noise reduction.

3.1.1.32 Inside office walls will have 5/8" Fire code type X drywall with a ceiling height of 8' (eight foot). Taped, finished, primed and painted with Sherwin Williams Pro-Mar 200 Dover White or equal.

3.1.1.33 Inside restroom and shower room walls will have 5/8" Firecode type X drywall taped and primed and covered with white FRP (fiberglass reinforced plastic) that is installed with Titebond Fast Grab FRP adhesive or equal.

3.1.1.34 Ceiling in office areas to be CertainTeed Bet-17, 2'x4' lay- in tiles or equal with commercial grade track system. Ceiling height in office, shower, and restroom to be 8'.

3.1.1.35 Lighting in office area to consist of two 2x4 lay-in Cooper 2GR8-432A four-lamp fixtures or equal, and restroom and shower to have one each Cooper 2GR8-232A two-lamp fixtures or equal, as shown in WVDA drawing No.3.

3.1.1.36 Contractor shall furnish and install a 200-amp electrical system for Post Office and Shop building complete with panel box Square D model Q0140M200, single phase 40 circuit 200-amp with cover Q0C40US or equal. All electrical work will be installed in compliance to the latest National Electric Code. All interior wiring will be copper and in EMT (thin wall) conduit.

REQUEST FOR QUOTATION
AGR1332 Post Frame Office and Shop Building

3.1.1.37 Shop to have seventeen, 120 volt duplex receptacles spaced every 10' as shown on WVDA drawing No.2 Two, 250-volt 30-amp receptacles for welder and air compressor as shown on WVDA drawing No.2. Electric panel box to also have one, 250-volt 30-amp circuit for water heater. Exterior East wall to have two, 120-volt GFCI weatherproof outlets, as shown on WVDA drawing No.2.

3.1.1.38 Restroom and shower room to each have electric heater, Dayton SZK68 or equal, installed into walls. Office to have Packaged Thermal Air Conditioner (P.T.A.C.) unit General Electric AZ61H12DAB 11,800BTU or equal, with all wall sleeves and materials to install into North wall, as shown on WVDA drawing attachment No.1.

3.1.1.39 Inside office walls to have 8 (eight) 20- amp receptacles as shown on WVDA drawing No.2. Light switch mounted on inside wall by door. Restroom to have one 120 volt GFCI outlet.

3.1.1.40 Outside walls of office area in shop will be covered with white galvanized steel uni-rib 29 gauge panels.

3.1.1.41 Office to have 2 (two) white vinyl insulated windows installed per WVDA drawing No. 1. 1 (one) 48"x48" double hung in exterior east facing wall and 1 (one) 48"x48" deadlight facing out into shop, as also shown in drawing No.1.

3.1.1.42 All vinyl insulated windows are to meet the Energy Star Rating for Northern Climate Zone

3.1.1.43 Office area will have 3 (three) commercial steel doors 3'0"x6'8" with ADA rated hardware to be installed in restroom, as shown in WVDA drawing attachment No.1.

3.1.1.44 Shop area will have 6 Metalux HBI-654-T5-N-UNV-EHT2-U or equal light fixtures as shown in WVDA drawings attachment No.3. Lights in shop area to be controlled by 3-way switches located by both exterior doors, also shown in drawing No.3. Lights will have wire guards Metalux SWG/HBI-4FT-B or equal.

REQUEST FOR QUOTATION
AGR1332 Post Frame Office and Shop Building

3.1.1.45 East exterior wall will have 3 (three) exterior lights with photo-cell Lumark WPP25 250w Metal Halide Pulse Start or equal as shown in WVDA drawing No.4.

3.1.1.46 Drawings provided by the West Virginia Department of Agriculture are preliminary and for bid purposes only. FIELD MEASUREMENTS SHOULD BE MADE BY THE SUCCESSFUL CONTRACTOR BEFORE BIDDING AND ORDERING ANY MATERIALS.

4. CONTRACT AWARD:

4.1 Contract Award: The Contract is intended to provide Agencies with a purchase price for the Contract Items. The Contract shall be awarded to the Vendor that provides the Contract Item meeting the required specifications for the lowest overall total cost as shown on the Pricing Pages.

4.2 Pricing Page: Vendor should complete the Pricing Page in full as failure to complete the Pricing Page in its entirety may result in Vendor's bid being disqualified.

Notwithstanding the foregoing, the Purchasing Division may correct errors as it deems appropriate. Vendor should type the information into the Pricing Page to prevent errors in the evaluation.

5. PAYMENT:

5.1 Payment: Vendor shall accept payment in accordance with the payment procedures of the State of West Virginia.

REQUEST FOR QUOTATION
AGRI332 Post Frame Office and Shop Building

6. DELIVERY AND RETURN:

- 6.1 Shipment and Delivery:** Vendor shall ship the Contract Items immediately after being awarded this Contract and receiving a purchase order or notice to proceed. Vendor shall deliver the Contract Items within 90 (ninety) working days after receiving a purchase order or notice to proceed. Contract Items must be delivered to West Virginia Department of Agriculture, Huttonsville Farm, Route 250 South, Huttonsville, WV 26273. Drop off location to be at the north end of pad where building will be constructed.
- 6.2 Late Delivery:** The Agency placing the order under this Contract must be notified in writing if the shipment of the Contract Items will be delayed for any reason. Any delay in delivery that could cause harm to an Agency will be grounds for cancellation of the Contract, and/or obtaining the Contract Items from a third party.
- Any Agency seeking to obtain the Contract Items from a third party under this provision must first obtain approval of the Purchasing Division.
- 6.3 Delivery Payment/Risk of Loss:** Vendor shall deliver the Contract Items F.O.B. destination to the Agency's location.
- 6.4 Return of Unacceptable Items:** If the Agency deems the Contract Items to be unacceptable, the Contract Items shall be returned to Vendor at Vendor's expense and with no restocking charge. Vendor shall either make arrangements for the return within five (5) days of being notified that items are unacceptable, or permit the Agency to arrange for the return and reimburse Agency for delivery expenses. If the original packaging cannot be utilized for the return, Vendor will supply the Agency with appropriate return packaging upon request. All returns of unacceptable items shall be F.O.B. the Agency's location. The returned product shall either be replaced, or the Agency shall receive a full credit or refund for the purchase price, at the Agency's discretion.
- 6.5 Return Due to Agency Error:** Items ordered in error by the Agency will be returned for credit within 30 days of receipt, F.O.B. Vendor's location. Vendor shall not charge a restocking fee if returned products are in a resalable condition. Items shall be deemed to be in a resalable condition if they are unused and in the original packaging. Any restocking fee for items not in a resalable condition shall be the lower of the Vendor's customary restocking fee or 5% of the total invoiced value of the returned items.

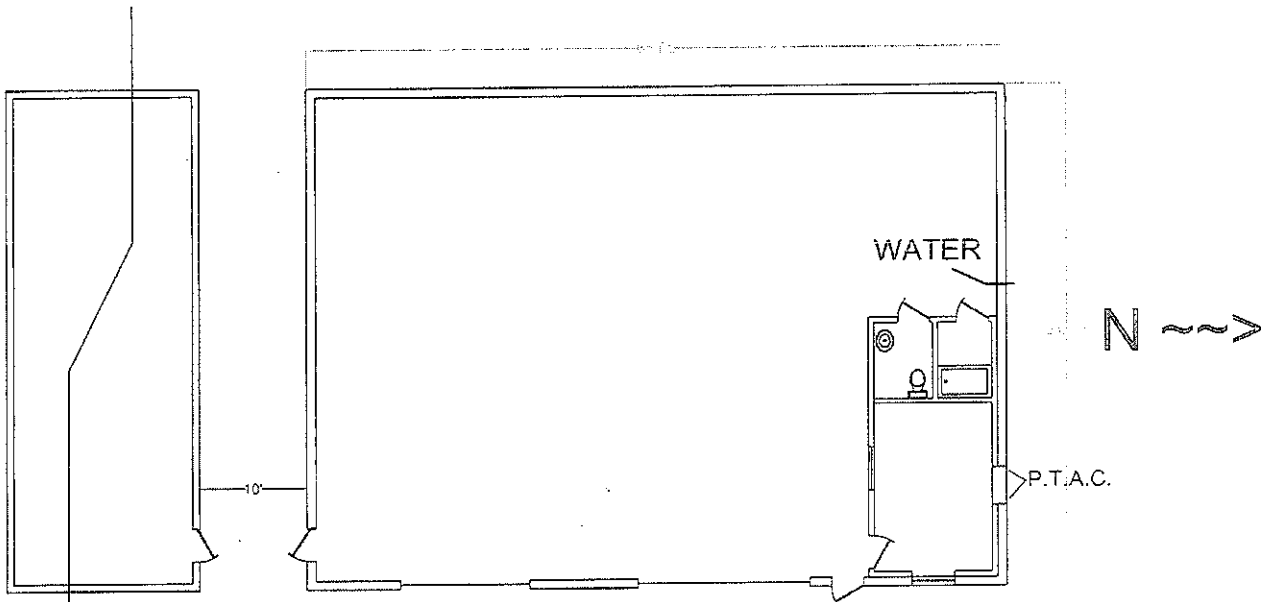

EXISTING BUILDING 100' LONG

FLOORPLAN WVDA DRAWINGS No.1

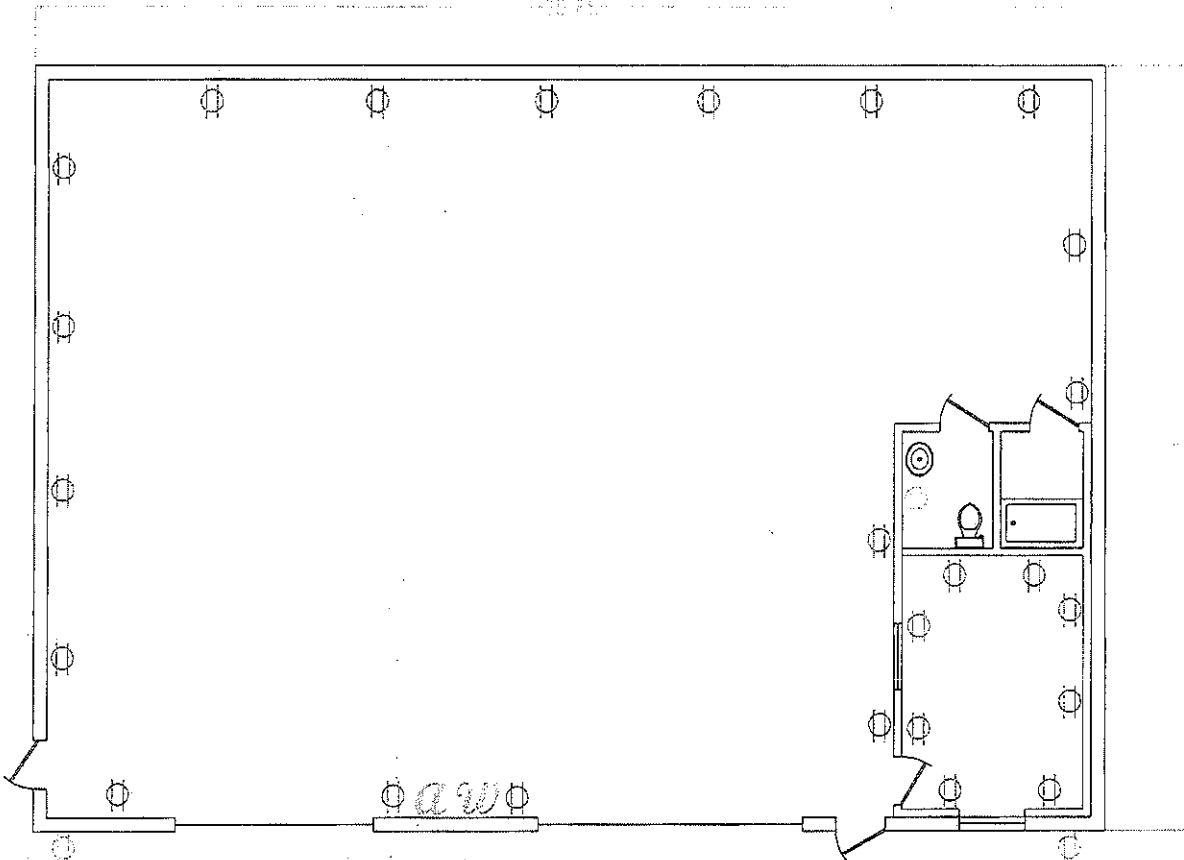

◐ = DUPLEX OUTLET a = AIR COMPRESSOR w = WELDER
 ◑ = GFCI OUTLETS

ELECTRIC OUTLETS WVDA DRAWINGS No.2

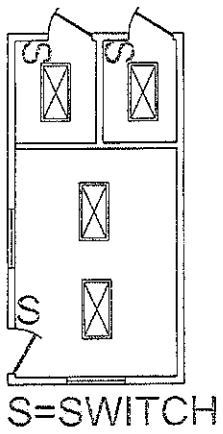

S=SWITCH

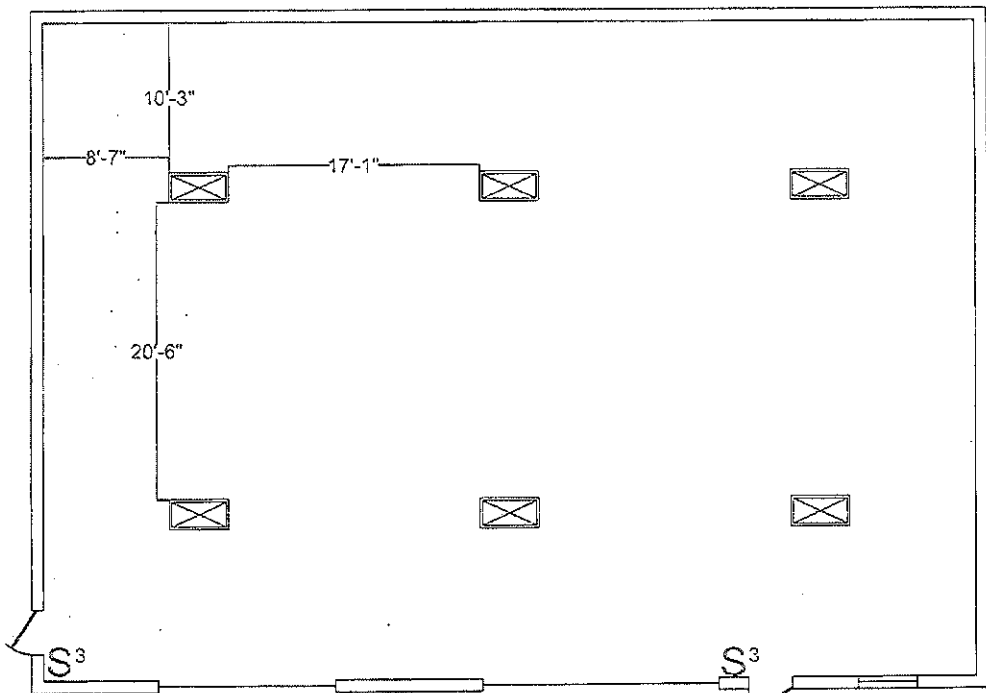

S³=3-WAY SWITCH

S=SWITCH

☒=LIGHTING

LIGHTING LAYOUT WVDA DRAWINGS No.3

Front

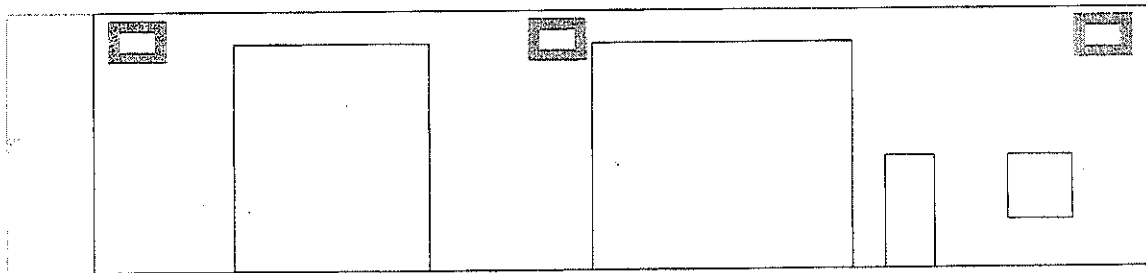

 = OUTSIDE LIGHTS

EAST WALL OUTSIDE LIGHTING WVDA DRAWINGS No.4

Front

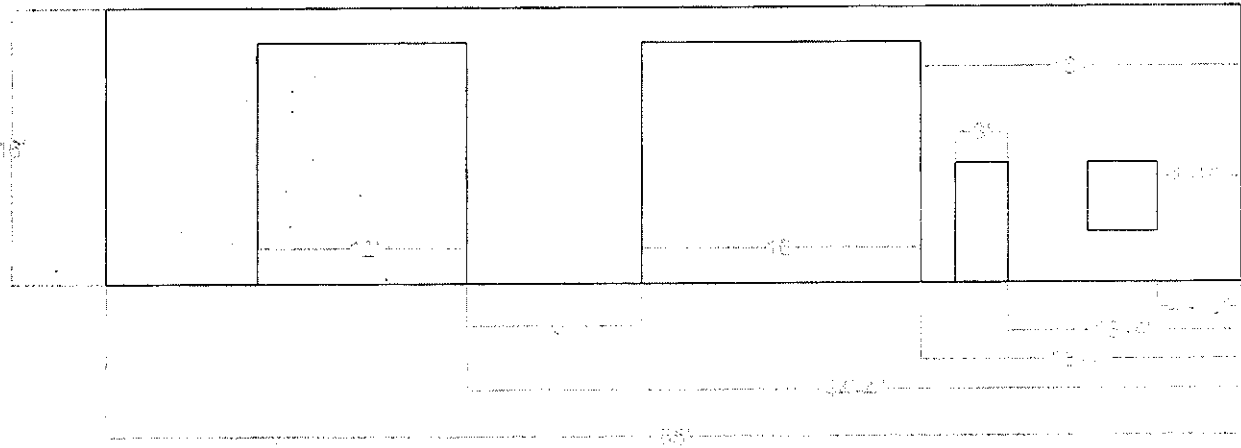

DIMENSIONS AND ELEVATION EAST WALL
WVDA DRAWINGS No.5

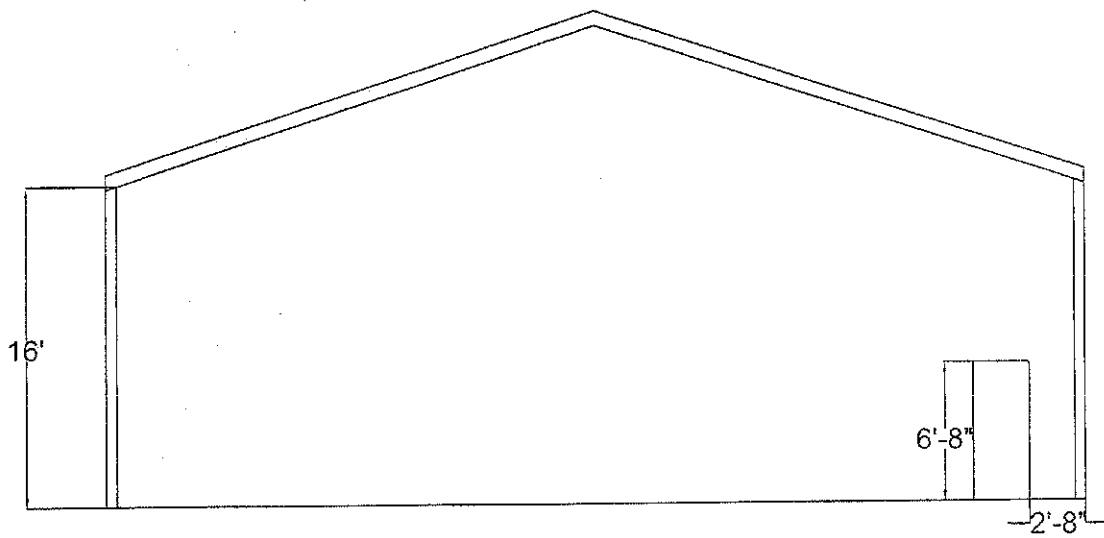

SOUTH WALL ELEVATION
WVDA DRAWINGS No.6

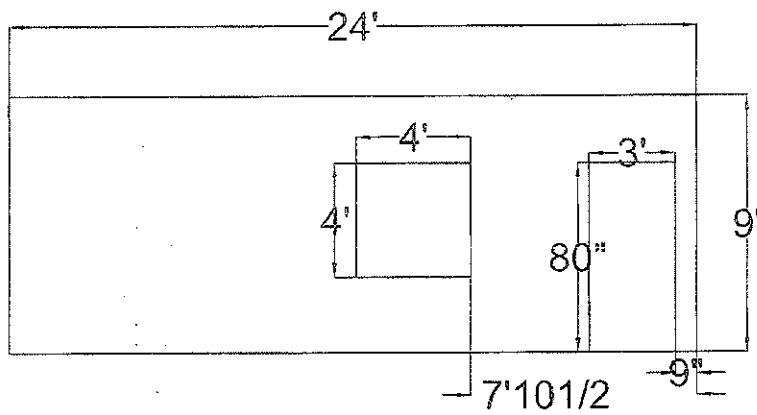

OFFICE SOUTH WALL ELEVATION
 WVDA DRAWINGS No.7

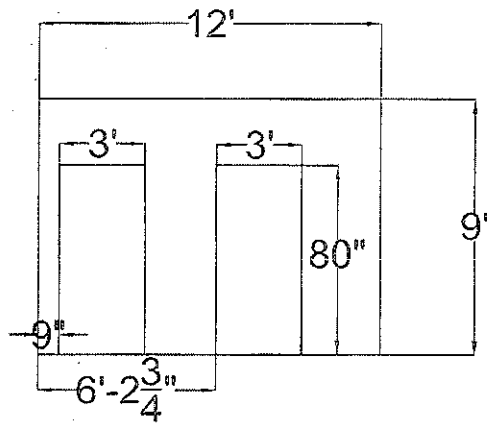

OFFICE WEST WALL ELEVATION
WVDA DRAWINGS No.8

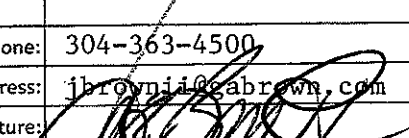
PRICING PAGE AGR1332			
Item No.	Description	Quantity	Amount
1	Pre-Engineered Post Frame Office & Shop Building	1	\$265,250 ⁰⁰
	Failure to use this form may result in disqualification		
	Bidder / Vendor Information		
Name:	G.A.BROWN & SON, INC.		
Address:	215 MILL STREET		
	FAIRMONT, WV 26554		
Phone:	304-363-4500		
Email Address:	jbrowni@gabrown.com		
Authorized Signature:			

WV-75
Created 07/18/12



State of West Virginia

PURCHASING DIVISION

Construction Bid Submission Review Form

This list has been provided for informational purposes only and is not to be construed as a complete list of request for quotation or bidding requirements for any individual construction project. This list does not and cannot include every item, mistake or oversight that could cause a contractor's bid to be disqualified. Rather, this list is intended to draw attention to some of the most common problems that the Purchasing Division encounters in the bidding process for construction projects. All potential bidders must read the request for quotation, all additional documents, and all instructions relating thereto ("Bid Documents") in their entirety to identify the actual request for quotation and bidding requirements. Failure to read the Bid Documents in their entirety and comply with the stated requirements contained therein may result in bid disqualification.

Errors That Shall Be Reason for Immediate Bid Disqualification

1. Failure to attend a mandatory pre-bid meeting
2. Failure to sign the bid
3. Failure to supply West Virginia contractor's license # on bid
4. Failure to supply a signed drug free workplace affidavit with the bid
5. Failure to supply a valid bid bond or other surety approved by the State of West Virginia
6. Failure to meet any mandatory requirement of the RFQ
7. Failure to acknowledge receipt of Addenda (only if stipulated as mandatory)
8. Failure to submit bid prior to the bid opening date and time
9. Federal debarment
10. State of West Virginia debarment or suspension

Errors that May Be Reason for Bid Disqualification Before Contract Award

1. Uncontested debt to the State exceeding \$1,000.00 (must be cured prior to award)
2. Workers' Compensation or Unemployment Compensation delinquency (must be cured prior to award)
3. Not registered as a vendor with the State (must be cured prior to award)
4. Failure to obtain required bonds and/or insurance
5. Failure to provide the sub-contractor listing within 1 business day of bid opening.
6. Failure to use the provided RFQ form (only if stipulated as mandatory).

BID BOND

KNOW ALL MEN BY THESE PRESENTS, That we, the undersigned, G. A. Brown & Son, Inc.
of Fairmont West Virginia, as Principal, and Fidelity and Deposit Company of
Maryland of Baltimore Maryland, a corporation organized and existing under the laws of the State of
Maryland with its principal office in the City of Baltimore, MD, as Surety, are held and firmly bound unto the State
of West Virginia, as Obligee, in the penal sum of Five Percent of the Amount Bid (\$ --- 5% ---) for the payment of which,
well and truly to be made, we jointly and severally bind ourselves, our heirs, administrators, executors, successors and assigns.

The Condition of the above obligation is such that whereas the Principal has submitted to the Purchasing Section of the
Department of Administration a certain bid or proposal, attached hereto and made a part hereof, to enter into a contract in writing for
Post and Frame Office and Shop Building, Huttonsville, WV.

RFQ # AGR1332.

NOW THEREFORE,

- (a) If said bid shall be rejected, or
- (b) If said bid shall be accepted and the Principal shall enter into a contract in accordance with the bid or proposal attached
hereto and shall furnish any other bonds and insurance required by the bid or proposal, and shall in all other respects perform the
agreement created by the acceptance of said bid, then this obligation shall be null and void, otherwise this obligation shall remain in full
force and effect. It is expressly understood and agreed that the liability of the Surety for any and all claims hereunder shall, in no event,
exceed the penal amount of this obligation as herein stated.

The Surety, for the value received, hereby stipulates and agrees that the obligations of said Surety and its bond shall be in no
way impaired or affected by any extension of the time within which the Obligee may accept such bid, and said Surety does hereby
waive notice of any such extension.

IN WITNESS WHEREOF, Principal and Surety have hereunto set their hands and seals, and such of them as are corporations
have caused their corporate seals to be affixed hereunto and these presents to be signed by their proper officers, this

13th day of June, 2013

Principal Corporate Seal

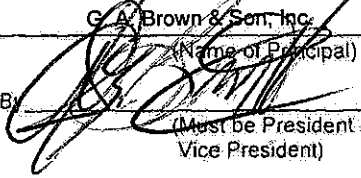
G. A. Brown & Son, Inc.
(Name of Principal)

B. (Must be President or
Vice President)

Vice President
(Title)

Surety Corporate Seal

Fidelity and Deposit Company of Maryland
(Name of Surety)

Attorney-in-Fact

IMPORTANT - Surety executing bonds must be licensed in West Virginia to transact surety insurance. Corporate seals must be affixed,
and a power of attorney must be attached.

Power of Attorney
FIDELITY AND DEPOSIT COMPANY OF MARYLAND

KNOW ALL MEN BY THESE PRESENTS: That the FIDELITY AND DEPOSIT COMPANY OF MARYLAND, a corporation of the State of Maryland, by M. P. HAMMOND, Vice President, and ERIC D. BARNES, Assistant Secretary, in pursuance of authority granted by Article VI, Section 2, of the By-Laws of said Company, which are set forth on the reverse side hereof and are hereby certified to be in full force and effect on the date hereof, does hereby nominate, constitute and appoint **A. L. STANCHINA, of Moneta, Virginia**, its true and lawful agent and Attorney-in-Fact, to make, execute, seal and deliver, for, and on its behalf as surety, and as its act and deed, **any and all bonds and undertakings**, and the execution of such bonds or undertakings in pursuance of these presents, shall be as binding upon said Company, as fully and amply, to all intents and purposes, as if they had been duly executed and acknowledged by the regularly elected officers of the Company at its office in Baltimore, Md. in their own proper persons. This power of attorney revokes that issued on behalf of A. L. STANCHINA, dated June 14, 2004.

The said Assistant Secretary does hereby certify that the extract set forth on the reverse side hereof is a true copy of Article VI, Section 2, of the By-Laws of said Company, and is now in force.

IN WITNESS WHEREOF, the said Vice-President and Assistant Secretary have hereunto subscribed their names and affixed the Corporate Seal of the said FIDELITY AND DEPOSIT COMPANY OF MARYLAND, this 28th day of July, A.D. 2004.

ATTEST:

FIDELITY AND DEPOSIT COMPANY OF MARYLAND



Eric D. Barnes

Eric D. Barnes Assistant Secretary

M. P. Hammond

By:

M. P. Hammond

M. P. Hammond Vice President

State of Maryland } ss:
City of Baltimore }

**FOR YOUR PROTECTION,
LOOK FOR THE ZURICH WATERMARK**

On this 28th day of July, A.D. 2004, before the subscriber, a Notary Public of the State of Maryland, duly commissioned and qualified, came M. P. HAMMOND, Vice President, and ERIC D. BARNES, Assistant Secretary of the FIDELITY AND DEPOSIT COMPANY OF MARYLAND, to me personally known to be the individuals and officers described in and who executed the preceding instrument, and they each acknowledged the execution of the same, and being by me duly sworn, severally and each for himself deposed and saith, that they are the said officers of the Company aforesaid, and that the seal affixed to the preceding instrument is the Corporate Seal of said Company, and that the said Corporate Seal and their signatures as such officers were duly affixed and subscribed to the said instrument by the authority and direction of the said Corporation.

IN TESTIMONY WHEREOF, I have hereunto set my hand and affixed my Official Seal the day and year first above written.



Dennis R. Hayden

Dennis R. Hayden

Dennis R. Hayden Notary Public

My Commission Expires: February 1, 2009

BID BOND PREPARATION INSTRUCTIONS

AGENCY (A)
RFQ/RFP# (B)

- (A) WV State Agency (Stated on Page 1 "Spending Unit") Request for Quotation Number (upper right corner of page #1)
(C) Your Company Name
(D) City, Location of your Company
(E) State, Location of your Company
(F) Surety Corporate Name
(G) City, Location of Surety
(H) State, Location of Surety
(I) State of Surety Incorporation
(J) City of Surety Incorporation
(K) Minimum amount of acceptable bid bond is 5% of total bid. You may state "5% of bid" or a specific amount on this line in words.
(L) Amount of bond in figures
(M) Brief Description of scope of work
(N) Day of the month.
(O) Month
(P) Year
(Q) Name of Corporation
(R) Raised Corporate Seal of Principal
(S) Signature of President or Vice President
(T) Title of person signing
(U) Raised Corporate Seal of Surety
(V) Corporate Name of Surety
(W) Signature of Attorney in Fact of the Surety

NOTE: Dated, Power of Attorney with Raised Surety Seal must accompany this bid bond.

Bid Bond
KNOW ALL MEN BY THESE PRESENTS, That we, the undersigned, (C) of (D), (E) as Principal, and (F) of (G), (H), a corporation organized and existing under the laws of the State of (I) with its principal office in the City of (J), as Surety, are held and firmly bound unto The State of West Virginia, as Obligee, in the penal sum of (K) (\$ (L)) for the payment of which, well and truly to be made, we jointly and severally bind ourselves, our heirs, administrators, executors, successors and assigns.

The Condition of the above obligation is such that whereas the Principal has submitted to the Purchasing Section of the Department of Administration a certain bid or proposal, attached hereto and made a part hereof to enter into a contract in writing for (M)

NOW THEREFORE.
(a) If said bid shall be rejected, or
(b) If said bid shall be accepted and the Principal shall enter into a contract in accordance with the bid or proposal attached hereto and shall furnish any other bonds and insurance required by the bid or proposal, and shall in all other respects perform the agreement created by the acceptance of said bid then this obligation shall be null and void, otherwise this obligation shall remain in full force and effect. It is expressly understood and agreed that the liability of the Surety for any and all claims hereunder shall, in no event, exceed the penal amount of this obligation as herein stated

The Surety for value received, hereby stipulates and agrees that the obligations of said Surety and its bond shall be in no way impaired or affected by any extension of time within which the Obligee may accept such bid: and said Surety does hereby waive notice of any such extension.

IN WITNESS WHEREOF, Principal and Surety have hereunto set their hands and seals, and such of them as are corporations have caused their corporate seals to be affixed hereto and these presents to be signed by their proper officers, this (N) day of (O), 20 (P).

Principal Corporate Seal (R) By (S) (Must be President or Vice President) (T) Title

Surety Corporate Seal (U) (V) (Name of Surety) (W) Attorney-in-Fact

IMPORTANT - Surety executing bonds must be licensed in West Virginia to transact surety insurance. Raised Corporate Seals must be affixed and a Power of Attorney must be attached.

Agency _____
REQ.P.O# _____

BID BOND

KNOW ALL MEN BY THESE PRESENTS, That we, the undersigned, _____
of _____, _____, as Principal, and _____
of _____, _____, a corporation organized and existing under the laws of the State of _____
with its principal office in the City of _____, as Surety, are held and firmly bound unto the State
of West Virginia, as Obligee, in the penal sum of _____ (\$ _____) for the payment of which,
well and truly to be made, we jointly and severally bind ourselves, our heirs, administrators, executors, successors and assigns.

The Condition of the above obligation is such that whereas the Principal has submitted to the Purchasing Section of the
Department of Administration a certain bid or proposal, attached hereto and made a part hereof, to enter into a contract in writing for

NOW THEREFORE,

- (a) If said bid shall be rejected, or
- (b) If said bid shall be accepted and the Principal shall enter into a contract in accordance with the bid or proposal attached
hereto and shall furnish any other bonds and insurance required by the bid or proposal, and shall in all other respects perform the
agreement created by the acceptance of said bid, then this obligation shall be null and void, otherwise this obligation shall remain in full
force and effect. It is expressly understood and agreed that the liability of the Surety for any and all claims hereunder shall, in no event,
exceed the penal amount of this obligation as herein stated.

The Surety, for the value received, hereby stipulates and agrees that the obligations of said Surety and its bond shall be in no
way impaired or affected by any extension of the time within which the Obligee may accept such bid, and said Surety does hereby
waive notice of any such extension.

IN WITNESS WHEREOF, Principal and Surety have hereunto set their hands and seals, and such of them as are corporations
have caused their corporate seals to be affixed hereunto and these presents to be signed by their proper officers, this
_____ day of _____, 20_____.

Principal Corporate Seal

(Name of Principal)

By _____

(Must be President or
Vice President)

(Title)

Surety Corporate Seal

(Name of Surety)

Attorney-in-Fact

**IMPORTANT – Surety executing bonds must be licensed in West Virginia to transact surety insurance. Raised corporate seals
must be affixed, a power of attorney must be attached.**



State of West Virginia
DRUG FREE WORKPLACE CONFORMANCE AFFIDAVIT
West Virginia Code §21-1D-5

STATE OF WEST VIRGINIA

COUNTY OF MARION, TO-WIT:

I, JAMES BROWN, II, after being first duly sworn, depose and state as follows:

- 1. I am an employee of G.A.BROWN & SON, INC.; and,
(Company Name)
- 2. I do hereby attest that G.A.BROWN & SON, INC.
(Company Name)

maintains a valid written drug free workplace policy and that such policy is in compliance with **West Virginia Code** §21-1D-5.

The above statements are sworn to under the penalty of perjury.
G.A.BROWN & SON, INC.

(Company Name)

By: [Signature]
Title: VICE PRESIDENT
Date: 06.13.13

Taken, subscribed and sworn to before me this 13th day of June 2013.

By Commission expires March 11, 2018

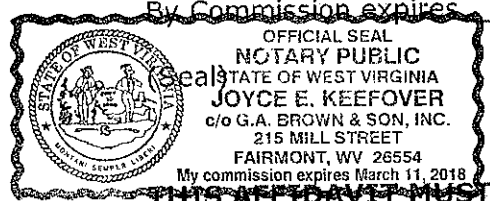

[Signature]
(Notary Public)

THIS AFFIDAVIT MUST BE SUBMITTED WITH THE BID IN ORDER TO COMPLY WITH WV CODE PROVISIONS. FAILURE TO INCLUDE THE AFFIDAVIT WITH THE BID SHALL RESULT IN DISQUALIFICATION OF THE BID.

RFQ No. AGR1332

STATE OF WEST VIRGINIA
Purchasing Division

PURCHASING AFFIDAVIT

MANDATE: Under W. Va. Code §5A-3-10a, no contract or renewal of any contract may be awarded by the state or any of its political subdivisions to any vendor or prospective vendor when the vendor or prospective vendor or a related party to the vendor or prospective vendor is a debtor and: (1) the debt owed is an amount greater than one thousand dollars in the aggregate; or (2) the debtor is in employer default.

EXCEPTION: The prohibition listed above does not apply where a vendor has contested any tax administered pursuant to chapter eleven of the W. Va. Code, workers' compensation premium, permit fee or environmental fee or assessment and the matter has not become final or where the vendor has entered into a payment plan or agreement and the vendor is not in default of any of the provisions of such plan or agreement.

DEFINITIONS:

"Debt" means any assessment, premium, penalty, fine, tax or other amount of money owed to the state or any of its political subdivisions because of a judgment, fine, permit violation, license assessment, defaulted workers' compensation premium, penalty or other assessment presently delinquent or due and required to be paid to the state or any of its political subdivisions, including any interest or additional penalties accrued thereon.

"Employer default" means having an outstanding balance or liability to the old fund or to the uninsured employers' fund or being in policy default, as defined in W. Va. Code § 23-2c-2, failure to maintain mandatory workers' compensation coverage, or failure to fully meet its obligations as a workers' compensation self-insured employer. An employer is not in employer default if it has entered into a repayment agreement with the Insurance Commissioner and remains in compliance with the obligations under the repayment agreement.

"Related party" means a party, whether an individual, corporation, partnership, association, limited liability company or any other form or business association or other entity whatsoever, related to any vendor by blood, marriage, ownership or contract through which the party has a relationship of ownership or other interest with the vendor so that the party will actually or by effect receive or control a portion of the benefit, profit or other consideration from performance of a vendor contract with the party receiving an amount that meets or exceeds five percent of the total contract amount.

AFFIRMATION: By signing this form, the vendor's authorized signer affirms and acknowledges under penalty of law for false swearing (W. Va. Code §61-5-3) that neither vendor nor any related party owe a debt as defined above and that neither vendor nor any related party are in employer default as defined above, unless the debt or employer default is permitted under the exception above.

WITNESS THE FOLLOWING SIGNATURE:

Vendor's Name: G. A. BROWN & SON, INC.

Authorized Signature: [Signature] Date: 06.13.13

State of WV

County of Marion, to-wit:

Taken, subscribed, and sworn to before me this 13 day of June, 2013.

My Commission expires March 11, 2018

AFFIX SEAL HERE

NOTARY PUBLIC

[Signature]
Purchasing Affidavit (Revised 07/01/2012)

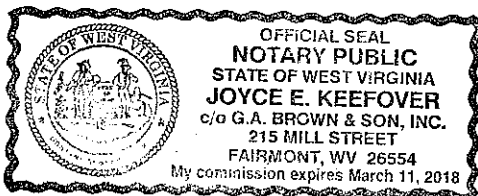

CERTIFICATION AND SIGNATURE PAGE

By signing below, I certify that I have reviewed this Solicitation in its entirety; understand the requirements, terms and conditions, and other information contained herein; that I am submitting this bid or proposal for review and consideration; that I am authorized by the bidder to execute this bid or any documents related thereto on bidder's behalf; that I am authorized to bind the bidder in a contractual relationship; and that to the best of my knowledge, the bidder has properly registered with any State agency that may require registration.

G. A. BROWN & SON, INC.

(Company)

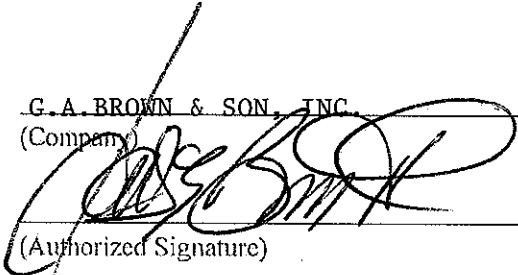

(Authorized Signature)

JAMES BROWN, II VICE PRESIDENT

(Representative Name, Title)

304-363-4500

304-366-9456

(Phone Number)

(Fax Number)

06.13.13

(Date)

