



State of West Virginia
 Department of Administration
 Purchasing Division
 2019 Washington Street East
 Post Office Box 50130
 Charleston, WV 25305-0130

Request for Quotation

RFQ NUMBER BCF12051

PAGE 1

ADDRESS CORRESPONDENCE TO ATTENTION OF: KRISTA FERRELL 304-558-2596

*709044350 304-344-1231
 CONTEMPORARY GALLERIES OF WV I
 1210 SMITH STREET
 CHARLESTON WV 25301

HEALTH AND HUMAN RESOURCES
 VARIOUS LOCATIONS
 AS INDICATED BELOW

VENDOR

SHIP TO

DATE PRINTED 10/31/2011	TERMS OF SALE	SHIP VIA	F.O.B.	FREIGHT TERMS
BID OPENING DATE: 11/03/2011		BID OPENING TIME 01:30PM		

LINE	QUANTITY	UOP	CAT. NO.	ITEM NUMBER	UNIT PRICE	AMOUNT
ADDENDUM NO. 2						
THIS ADDENDUM IS ISSUED TO:						
1.) PROVIDE A COPY OF THE MANDATORY PRE-BID ATTENDEE LIST AND						
2.) PROVIDE REVISED CLARIFICATION TO REQUIREMENTS UNDER SECTION 12.1 OF THE ORIGINAL REQUEST FOR QUOTATION (BCF12051). PLEASE REPLACE SECTION 12.1 WITH THE FOLLOWING:						
"ON ANY CONTRACT FOR THE CONSTRUCTION OF A PUBLIC IMPROVEMENT, VENDOR AND ANY SUBCONTRACTORS UTILIZED BY THE VENDOR SHALL PAY A RATE OF WAGES WHICH SHALL NOT BE LESS THAN THE FAIR MINIMUM RATE OR RATES OF WAGES (PREVAILING WAGE), AS ESTABLISHED BY THE DIVISION OF LABOR UNDER WEST VIRGINIA CODE 21-5A-1 ET SEQ. AND AVAILABLE AT HTTP://WWW.SOS.WV.GOV/ADMINISTRATIVE-LAW/WAGERATES/PAGES/DEFAULT.ASPX VENDOR SHALL BE RESPONSIBLE FOR ENSURING COMPLIANCE WITH PREVAILING WAGE REQUIREMENTS AND DETERMINING WHEN PREVAILING WAGE REQUIREMENTS ARE APPLICABLE. THE REQUIRED CONTRACT PROVISIONS CONTAINED IN WEST VIRGINIA CODE OF STATE RULES 42-7-3 ARE SPECIFICALLY INCORPORATED HEREIN."						
SECONDARY BID OPENING DATE REMAINS: 11/03/2011						
SECONDARY BID OPENING TIME REMAINS: 1:30 PM						
***** END ADDENDUM NO. 2 *****						

RECEIVED
 2011 NOV -3 PM 1:15
 WV PURCHASING
 DIVISION

SEE REVERSE SIDE FOR TERMS AND CONDITIONS			
SIGNATURE <i>Jennifer B. Kunkel</i>	TELEPHONE 304-344-1231	DATE 11-03-11	
TITLE Sales Design	FEIN 650564447	ADDRESS CHANGES TO BE NOTED ABOVE	

WHEN RESPONDING TO RFQ, INSERT NAME AND ADDRESS IN SPACE ABOVE LABELED 'VENDOR'

PRE-BID CONFERENCE
SIGN IN SHEET

Request for Quotation Number: BCF/2051

Date: 10/13/2011

PLEASE PRINT LEGIBLY. THIS INFORMATION IS ESSENTIAL TO CONTACT THE ATTENDEES IN A TIMELY MANNER. FAILURE TO DO SO MAY RESULT IN DELAYS IN YOUR COMPANY GETTING IMPORTANT BID INFORMATION.

Firm Name: Capitol Business Interiors
 Firm Address: 711 Indiana Avenue
Charleston, WV 25302
 Representative Attending: Kelli Bragg
 Phone Number: 304.343.7551
 Fax Number: 304.346.3350
 Email Address: kbragg@ntelos.net

Firm Name: CONTEMPORARY GALLERIES
 Firm Address: 1210 SMITH STREET
CHARLESTON, WV 25301
 Representative Attending: JENNIFER BRAGG
 Phone Number: 304.344.1231
 Fax Number: 304.344.1262
 Email Address: jbragg@netelos.net

Firm Name: Capitol Business Interiors
 Firm Address: 711 Indiana Avenue
Charleston, WV 25302
 Representative Attending: Amber Jones
 Phone Number: 304.343.7551
 Fax Number: 304.346.3350
 Email Address: amberjones@ntelos.net

**CAPITOL
BUSINESS
INTERIORS**
 Kelli Bragg
 Senior Account Executive
 711 Indiana Ave. • Charleston, WV 25302
 304.346.3342 • FAX 304.346.3350
 http://www.cbivwv.com
 e-mail: kbragg@ntelos.net
 A Division of Champion Industries, Inc.

Firm Name: _____
 Firm Address: _____
 Representative Atter: _____
 Phone Number: _____
 Fax Number: _____
 Email Address: _____

Firm Name: Franklin Interiors
 Firm Address: 2740 Smallman St
St. Louis
Pittsburgh Pa 15232
 Representative Attending: Kristin Schwalzer
 Phone Number: 412-261-2525
 Fax Number: 412-255-4089
 Email Address: kschwalzer@franklininteriors.com

**contemporary
galleries**
 1210 Smith Street, Charleston, WV 25301
 P.O. Box 2029, Charleston, WV 25330
 (304) 344-1231
 FAX# (304) 344-1262
 jbragg@netelos.net
 Jennifer B. K...
 Sales/Design

Firm Name: _____
 Firm Address: _____
 Representative Atten: _____
 Phone Number: _____
 Fax Number: _____
 Email Address: _____



State of West Virginia
 Department of Administration
 Purchasing Division
 2019 Washington Street East
 Post Office Box 50130
 Charleston, WV 25305-0130

Request for Quotation

RFQ NUMBER
BCF12051

PAGE
1

ADDRESS CORRESPONDENCE TO ATTENTION OF:
KRISTA FERRELL
304-558-2596

VENDOR

*709044350 304-344-1231
 CONTEMPORARY GALLERIES OF WV I
 1210 SMITH STREET
 CHARLESTON WV 25301

SHIP TO

HEALTH AND HUMAN RESOURCES
 VARIOUS LOCATIONS
 AS INDICATED BELOW

RECEIVED
 OCT 27 2011

BY:

DATE PRINTED	TERMS OF SALE	SHIP VIA	F.O.B.	FREIGHT TERMS
10/25/2011				

BID OPENING DATE: 11/03/2011 BID OPENING TIME 01:30PM

LINE	QUANTITY	UOP	CAT. NO.	ITEM NUMBER	UNIT PRICE	AMOUNT
				ADDENDUM NO. 1		
				THIS ADDENDUM IS ISSUED TO:		
				1.) PROVIDE ANSWERS TO ALL TECHNICAL QUESTIONS SUBMITTED IN ACCORDANCE WITH THE ORIGINAL SECONDARY BID SOLICITATION,		
				FURNITURE IS TO BE INSTALLED IS NOT YET CONSTRUCTED. AS THIS IS AN OPEN CONSTRUCTION SITE NO SITE VISITS ARE PERMITTED, AND		
				3.) TO EXTEND THE BID OPENING DATE.		
				BID OPENING DATE IS EXTENDED TO: 11/03/2011		
				BID OPENING TIME REMAINS: 1:30 PM		
				***** END ADDENDUM NO. 1 *****		
0001	1	JB		425-94		
				NEW MODULAR FURNITURE FOR HARDY COUNTY		
				DHHR OFFICE		

SEE REVERSE SIDE FOR TERMS AND CONDITIONS

SIGNATURE <i>James B. Kupatuck</i>	TELEPHONE <i>304 344 1231</i>	DATE <i>11-03-11</i>
TITLE <i>Sales/Design</i>	FEIN <i>550564447</i>	ADDRESS CHANGES TO BE NOTED ABOVE

WHEN RESPONDING TO RFQ, INSERT NAME AND ADDRESS IN SPACE ABOVE LABELED 'VENDOR'

BCF12051 ADDENDUM #1

Please make the following changes in this Request for Quotation:

ITEM #

3.0 SCOPE OF WORK

3.4 Add: 30" round table, pedestal base, laminate wood, and 29" high

3.8 Now reads: The lobby area will contain 24 stacking hard-shell chairs (fully molded, no open back) with metal frame, 4 legs, stationary without casters. The chairs are ganged in accordance with the attached floor plan. **(Rm. 100 per drawing)**

To read: The waiting area will contain 24 stacking hard-shell chairs (fully molded, no open back) with metal frame, 4 legs, stationary without casters. The chairs are ganged in accordance with the attached floor plan. **(Rm. 100 per drawing)**

3.10 Add: 36" w x 4" high bookcase

4. System Requirements

Now reads: Acceptable Manufacturers: Systems SYSFURN11

To read: Acceptable Manufacturers: Systems SYSFURN10

4.2 Seating Included in Bid:

Now reads: Family Visitation: To consist of one full size sofa, 3 side tables and 3 high lateral file. Fabric to be vinyl.

To read: Family Visitation: To consist of one 3 seat sofa with 4 legs and 2 arms, wood frame and steel base, 3 fixed seat and back cushions stationary without casters (2"-6") legs. 3 chairs metal frame without arms, 4 legs, and stationary casters hard shell. One Glider fully upholstered with arms, wood frame and trim, steel glider base. Upholstered to be vinyl.

4.3 Tables

Add: Family Visitation: one (1) 30" round table, pedestal based, laminate wood, 29" high.

DIAGRAM/DRAWING

Room 111

Now reads: Conference Room

To read: Family Visitation Room

Room 113

Now reads: Family Visitation Room

To read: Conference Room

Questions & Answers

Question: What do the straight stations on the end of the panel packs (hallway side) consist of?

Answer: **End panels are 80" high (+/-4" maximum). All panels are acoustical, monolithic and solid core, no frame and tile panels will be accepted. See section 3.3**

Question: Are transaction tops wanted on the reception stations?

Answer: **No**

Question: In the private offices, do the overhead cabinets need doors, if so should they be locking?

Answer: **No doors leave open**

Question: A few of the offices show product that is not requested in the written part. For example: office 122 (4 lateral files), office 123 (table and chairs) are these to be quoted or ignored?

Answer: **Written scope of work has been corrected and all products should be quoted.**

Question: Is a 5 shelf high bookcase acceptable in the private offices?

Answer: **It is acceptable to offer your product's closest match (5% variation on each dimension) if your product does not conform to the exact dimensions of the products listed. See section 1.1**

Question: Is a separate hard wire connection required for every table in the training room?

Answer: **Yes**

Question: The worksurface height in the mail room is requested to be 36" high wall mount. Three high laterals and storage cabinets are 42" high. Is shorter storage or higher worksurfaces acceptable.

Answer: **Worksurface to be no more than 36" high. It is acceptable to offer your product's closest match (5% variation on each dimension) if your product does not conform to the exact dimensions of the products listed. See section 1.1**

Question: Can the storage cabinets in the large conference room have 1 lateral file and one storage cabinet as opposed to 2 pedestals and 1 storage cabinet?

Answer: **Large conference room has 2 credenzas 24" x 72 with filing on each side and storage in the middle. See section 3.5**

Question: West Virginia Division of Labor carpenter rates are \$37.40 + overhead. Does this apply to the SYSFURN contract which is delivered and installed?

Answer: **No**

Question: Please confirm the labor rate that is to be used.

Answer: Please delete section 12.1 of the original specifications.

Question: Is this a union or non-union installation?

Answer: **Not applicable**

Question: Will the invoice be paid by credit card?

Answer: **No**

Question: Please confirm anticipated award date.

Answer: **When all approvals are final**

Question: Are the drawings available in an AutoCAD format? If so, please provide.

Answer: **No**

*****NOTE*****

Each vendor should submit a drawing/layout with their bid.

Excel spreadsheets

Replace excel spreadsheet in its entirety. Please see new spreadsheets attached.



State of West Virginia
 Department of Administration
 Purchasing Division
 2019 Washington Street East
 Post Office Box 50130
 Charleston, WV 25305-0130

Request for Quotation

RFQ NUMBER
BCF12051

PAGE
1

ADDRESS CORRESPONDENCE TO ATTENTION OF:
KRISTA FERRELL
304-558-2596

VENDOR

*709044350 304-344-1231
 CONTEMPORARY GALLERIES OF WV I
 1210 SMITH STREET
 CHARLESTON WV 25301

SHIP TO

HEALTH AND HUMAN RESOURCES
 VARIOUS LOCATIONS
 AS INDICATED BELOW

DATE PRINTED 10/06/2011	TERMS OF SALE	SHIP VIA	F.O.B.	FREIGHT TERMS
BID OPENING DATE: 10/27/2011		BID OPENING TIME 01:30PM		

LINE	QUANTITY	UOP	CAT. NO.	ITEM NUMBER	UNIT PRICE	AMOUNT
0001	1	JB		425-94		
<p>NEW MODULAR FURNITURE FOR HARDY COUNTY DHHR OFFICE</p> <p>REQUEST FOR QUOTATION SECONDARY BID FOR SYSFURN10</p> <p>THE WEST VIRGINIA STATE PURCHASING DIVISION IN ACCORDANCE WITH THE PROVISIONS OF SYSFURN10, IS SOLICITING SECONDARY COMPETITIVE BIDS FROM SYSFURN10 VENDORS TO PROVIDE THE AGENCY, THE WEST VIRGINIA DEPARTMENT OF HEALTH AND HUMAN RESOURCES, WITH MODULAR FURNITURE FOR THE HARDY COUNTY DHHR OFFICE LOCATED AT #5 ROBERT C. BYRD INDUSTRIAL PARK IN MOOREFIELD, WEST VIRGINIA PER THE ATTACHED SPECIFICATIONS.</p> <p>THIS SECONDARY COMPETITIVE BID IS LIMITED TO THOSE VENDORS HOLDING A STATEWIDE CONTRACT AWARD UNDER SYSFURN10. NO OTHER BIDS WILL BE CONSIDERED.</p> <p>SYSFURN VENDORS MUST BID ONLY PRODUCTS FROM CATALOGS AWARDED AS A PART OF THEIR SYSFURN10 CONTRACT. VENDORS BIDDING PRODUCTS FROM ANY OTHER CATALOGS WILL BE</p> <p>A MANDATORY PRE-BID WILL BE HELD ON 10/13/2011 AT THE AGENCY LOCATION AT 350 CAPITOL STREET IN CHARLESTON, WV AT 10:00 AM. ALL INTERESTED PARTIES ARE REQUIRED TO ATTEND THIS MEETING. FAILURE TO ATTEND THE MANDATORY PRE-BID SHALL RESULT IN DISQUALIFICATION OF THE BID. NO ONE PERSON MAY REPRESENT MORE THAN ONE BIDDER.</p>						

SEE REVERSE SIDE FOR TERMS AND CONDITIONS

SIGNATURE <i>Jennifer B. Kerpeluck</i>	TELEPHONE 304 344 1262	DATE 11-03-11
TITLE <i>Sales Director</i>	FEN 35050447	ADDRESS CHANGES TO BE NOTED ABOVE

WHEN RESPONDING TO RFQ, INSERT NAME AND ADDRESS IN SPACE ABOVE LABELED 'VENDOR'



State of West Virginia
 Department of Administration
 Purchasing Division
 2019 Washington Street East
 Post Office Box 50130
 Charleston, WV 25305-0130

Request for Quotation

RFQ NUMBER
BCF12051

PAGE
2

ADDRESS CORRESPONDENCE TO ATTENTION OF:
KRISTA FERRELL 304-558-2596

*709044350 304-344-1231
 CONTEMPORARY GALLERIES OF WV I
 1210 SMITH STREET
 CHARLESTON WV 25301

VENDOR

SHIP TO

HEALTH AND HUMAN RESOURCES
 VARIOUS LOCATIONS
 AS INDICATED BELOW

DATE PRINTED	TERMS OF SALE	SHIP VIA	F.O.B.	FREIGHT TERMS
10/06/2011				
BID OPENING DATE: 10/27/2011		BID OPENING TIME 01:30PM		

LINE	QUANTITY	UOP	CAT. NO.	ITEM NUMBER	UNIT PRICE	AMOUNT
<p>AN ATTENDANCE SHEET WILL BE MADE AVAILABLE FOR ALL POTENTIAL BIDDERS TO COMPLETE. THIS WILL SERVE AS THE OFFICIAL DOCUMENT VERIFYING ATTENDANCE AT THE MANDATORY PRE-BID. FAILURE TO PROVIDE YOUR COMPANY AND REPRESENTATIVE NAME ON THE ATTENDANCE SHEET WILL RESULT IN DISQUALIFICATION OF THE BID. THE STATE WILL NOT ACCEPT ANY OTHER DOCUMENTATION TO VERIFY ATTENDANCE. THE BIDDER IS RESPONSIBLE FOR ENSURING THEY HAVE COMPLETED THE INFORMATION REQUIRED ON THE ATTENDANCE SHEET. THE PURCHASING DIVISION AND THE STATE AGENCY WILL NOT ASSUME ANY RESPONSIBILITY FOR A BIDDER'S FAILURE TO COMPLETE THE PRE-BID ATTENDANCE SHEET. IN ADDITION, WE REQUEST THAT ALL POTENTIAL BIDDERS INCLUDE THEIR E-MAIL ADDRESS AND FAX NUMBER.</p> <p>ALL POTENTIAL BIDDERS ARE REQUESTED TO ARRIVE PRIOR TO THE STARTING TIME FOR THE PRE-BID. BIDDERS WHO ARRIVE LATE, BUT PRIOR TO THE DISMISSAL OF THE TECHNICAL PORTION OF THE PRE-BID WILL BE PERMITTED TO SIGN IN. BIDDERS WHO ARRIVE AFTER CONCLUSION OF THE TECHNICAL PORTION OF THE PRE-BID, BUT DURING ANY SUBSEQUENT PART OF THE PRE-BID WILL NOT BE PERMITTED TO SIGN THE ATTENDANCE SHEET.</p> <p>TECHNICAL QUESTIONS CONCERNING THIS SOLICITATION MUST BE SUBMITTED IN WRITING TO KRISTA FERRELL IN THE WEST VIRGINIA STATE PURCHASING DIVISION VIA FAX AT 304-558-4115 OR VIA EMAIL AT KRISTA.S.FERRELL@WV.GOV.</p> <p>DEADLINE FOR ALL TECHNICAL QUESTIONS IS 10/18/2011 AT THE CLOSE OF BUSINESS.</p> <p>ANY TECHNICAL QUESTIONS RECEIVED WILL BE ANSWERED BY FORMAL WRITTEN ADDENDUM TO BE ISSUED AFTER THE DEADLINE HAS LAPSED.</p>						

SEE REVERSE SIDE FOR TERMS AND CONDITIONS			
SIGNATURE	TELEPHONE	DATE	
TITLE	FEIN	ADDRESS CHANGES TO BE NOTED ABOVE	

WHEN RESPONDING TO RFQ, INSERT NAME AND ADDRESS IN SPACE ABOVE LABELED 'VENDOR'



State of West Virginia
 Department of Administration
 Purchasing Division
 2019 Washington Street East
 Post Office Box 50130
 Charleston, WV 25305-0130

Request for Quotation

RFQ NUMBER
BCF12051

PAGE
3

ADDRESS CORRESPONDENCE TO ATTENTION OF:
KRISTA FERRELL
304-558-2596

*709044350 304-344-1231
 CONTEMPORARY GALLERIES OF WV I
 1210 SMITH STREET
 CHARLESTON WV 25301

VENDOR

SHIP TO

HEALTH AND HUMAN RESOURCES
 VARIOUS LOCATIONS
 AS INDICATED BELOW

DATE PRINTED	TERMS OF SALE	SHIP VIA	F.O.B.	FREIGHT TERMS
10/06/2011				
BID OPENING DATE: 10/27/2011		BID OPENING TIME 01:30PM		

LINE	QUANTITY	UOP	CAT. NO.	ITEM NUMBER	UNIT PRICE	AMOUNT
<p>VERBAL COMMUNICATION: ANY VERBAL COMMUNICATION BETWEEN THE VENDOR AND ANY STATE PERSONNEL IS NOT BINDING, INCLUDING THOSE MADE DURING THE MANDATORY PRE-BID MEETING. ONLY INFORMATION ISSUED IN WRITING AND ADDED TO THE RFQ SPECIFICATIONS BY A FORMAL WRITTEN ADDENDUM IS BINDING.</p> <p>NO CONTACT BETWEEN THE VENDOR AND ANY AGENCY PERSONNEL IS PERMITTED WITHOUT THE EXPRESS WRITTEN CONSENT OF THE STATE BUYER. VIOLATION MAY RESULT IN THE REJECTION OF THE BID. THE STATE BUYER NAMED ABOVE IS THE SOLE CONTACT FOR ANY AND ALL INQUIRIES AFTER THIS RFQ HAS BEEN RELEASED.</p> <p>EXHIBIT 10</p> <p style="text-align: right;">REQUISITION NO.: BCF12051</p> <p>ADDENDUM ACKNOWLEDGEMENT</p> <p>I HEREBY ACKNOWLEDGE RECEIPT OF THE FOLLOWING CHECKED ADDENDUM(S) AND HAVE MADE THE NECESSARY REVISIONS TO MY PROPOSAL, PLANS AND/OR SPECIFICATION, ETC.</p> <p>ADDENDUM NO.'S:</p> <p>NO. 1 <i>PK</i></p> <p>NO. 2 <i>PK</i></p> <p>NO. 3</p> <p>NO. 4</p> <p>NO. 5</p>						

SEE REVERSE SIDE FOR TERMS AND CONDITIONS			
SIGNATURE	TELEPHONE	DATE	
TITLE	FEIN	ADDRESS CHANGES TO BE NOTED ABOVE	

WHEN RESPONDING TO RFQ, INSERT NAME AND ADDRESS IN SPACE ABOVE LABELED 'VENDOR'



State of West Virginia
 Department of Administration
 Purchasing Division
 2019 Washington Street East
 Post Office Box 50130
 Charleston, WV 25305-0130

Request for Quotation

RFQ NUMBER
BCF12051

PAGE
4

ADDRESS CORRESPONDENCE TO ATTENTION OF:
KRISTA FERRELL
304-558-2596

*709044350 304-344-1231
 CONTEMPORARY GALLERIES OF WV I
 1210 SMITH STREET
 CHARLESTON WV 25301

VENDOR

SHIP TO

HEALTH AND HUMAN RESOURCES
 VARIOUS LOCATIONS
 AS INDICATED BELOW

DATE PRINTED	TERMS OF SALE	SHIP VIA	F.O.B.	FREIGHT TERMS
10/06/2011				
BID OPENING DATE: 10/27/2011		BID OPENING TIME 01:30PM		

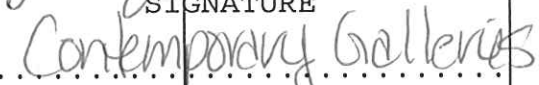
LINE	QUANTITY	UOP	CAT. NO.	ITEM NUMBER	UNIT PRICE	AMOUNT
<p>I UNDERSTAND THAT FAILURE TO CONFIRM THE RECEIPT OF THE ADDENDUM(S) MAY BE CAUSE FOR REJECTION OF BIDS.</p> <p>VENDOR MUST CLEARLY UNDERSTAND THAT ANY VERBAL REPRESENTATION MADE OR ASSUMED TO BE MADE DURING ANY ORAL DISCUSSION HELD BETWEEN VENDOR'S REPRESENTATIVES AND ANY STATE PERSONNEL IS NOT BINDING. ONLY THE INFORMATION ISSUED IN WRITING AND ADDED TO THE SPECIFICATIONS BY AN OFFICIAL ADDENDUM IS BINDING.</p> <div style="text-align: center;">  SIGNATURE  COMPANY 11-03-11 DATE </div> <p>NOTE: THIS ADDENDUM ACKNOWLEDGEMENT SHOULD BE SUBMITTED WITH THE BID.</p> <p>REV. 09/21/2009</p> <p>THE MODEL/BRAND/SPECIFICATIONS NAMED HEREIN ESTABLISH THE ACCEPTABLE LEVEL OF QUALITY ONLY AND ARE NOT INTENDED TO REFLECT A PREFERENCE OR FAVOR ANY PARTICULAR BRAND OR VENDOR. VENDORS WHO ARE BIDDING ALTERNATES SHOULD SO STATE AND INCLUDE PERTINENT LITERATURE AND SPECIFICATIONS. FAILURE TO PROVIDE INFORMATION FOR ANY ALTERNATES MAY BE GROUNDS FOR REJECTION OF THE BID. THE STATE RESERVES THE RIGHT TO WAIVE MINOR IRREGULARITIES IN BIDS OR SPECIFICATIONS IN ACCORDANCE WITH SECTION 148-1-4 (F) OF THE WEST</p>						

SEE REVERSE SIDE FOR TERMS AND CONDITIONS			
SIGNATURE	TELEPHONE	DATE	
TITLE	FEIN	ADDRESS CHANGES TO BE NOTED ABOVE	

WHEN RESPONDING TO RFQ, INSERT NAME AND ADDRESS IN SPACE ABOVE LABELED 'VENDOR'



State of West Virginia
 Department of Administration
 Purchasing Division
 2019 Washington Street East
 Post Office Box 50130
 Charleston, WV 25305-0130

Request for Quotation

RFQ NUMBER
BCF12051

PAGE
5

ADDRESS CORRESPONDENCE TO ATTENTION OF:
KRISTA FERRELL 304-558-2596

VENDOR

*709044350 304-344-1231
 CONTEMPORARY GALLERIES OF WV I
 1210 SMITH STREET
 CHARLESTON WV 25301

SHIP TO

HEALTH AND HUMAN RESOURCES
 VARIOUS LOCATIONS
 AS INDICATED BELOW

DATE PRINTED	TERMS OF SALE	SHIP VIA	F.O.B.	FREIGHT TERMS
10/06/2011				
BID OPENING DATE: 10/27/2011		BID OPENING TIME 01:30PM		

LINE	QUANTITY	UOP	CAT. NO.	ITEM NUMBER	UNIT PRICE	AMOUNT
				VIRGINIA LEGISLATIVE RULES AND REGULATIONS. NOTICE A SIGNED BID MUST BE SUBMITTED TO: DEPARTMENT OF ADMINISTRATION PURCHASING DIVISION BUILDING 15 2019 WASHINGTON STREET, EAST CHARLESTON, WV 25305-0130 THE BID SHOULD CONTAIN THIS INFORMATION ON THE FACE OF THE ENVELOPE OR THE BID MAY NOT BE CONSIDERED: SEALED BID BUYER: KRISTA FERRELL-FILE 42 RFQ. NO.: BCF12051/SECONDARY BID SYSFURN10 BID OPENING DATE: 10/27/2011 BID OPENING TIME: 1:30 PM PLEASE PROVIDE A FAX NUMBER IN CASE IT IS NECESSARY TO CONTACT YOU REGARDING YOUR BID: ----- 304 344-1262 -----		

SEE REVERSE SIDE FOR TERMS AND CONDITIONS

SIGNATURE	TELEPHONE	DATE
TITLE	FEIN	ADDRESS CHANGES TO BE NOTED ABOVE

WHEN RESPONDING TO RFQ, INSERT NAME AND ADDRESS IN SPACE ABOVE LABELED 'VENDOR'



State of West Virginia
 Department of Administration
 Purchasing Division
 2019 Washington Street East
 Post Office Box 50130
 Charleston, WV 25305-0130

Request for Quotation

RFQ NUMBER
BCF12051

PAGE
6

ADDRESS CORRESPONDENCE TO ATTENTION OF:
KRISTA FERRELL 304-558-2596

VENDOR

*709044350 304-344-1231
 CONTEMPORARY GALLERIES OF WV I
 1210 SMITH STREET

 CHARLESTON WV 25301

SHIP TO

HEALTH AND HUMAN RESOURCES
 VARIOUS LOCATIONS
 AS INDICATED BELOW

DATE PRINTED	TERMS OF SALE	SHIP VIA	F.O.B.	FREIGHT TERMS
10/06/2011				

BID OPENING DATE: 10/27/2011 BID OPENING TIME 01:30PM

LINE	QUANTITY	UOP	CAT NO.	ITEM NUMBER	UNIT PRICE	AMOUNT
CONTACT PERSON (PLEASE PRINT CLEARLY): <i>Jennifer B. Kirkpatrick</i>						
***** THIS IS THE END OF RFQ BCF12051 ***** TOTAL:						<u>14491.38</u>

SEE REVERSE SIDE FOR TERMS AND CONDITIONS

SIGNATURE	TELEPHONE	DATE
TITLE	FEIN	ADDRESS CHANGES TO BE NOTED ABOVE

WHEN RESPONDING TO RFQ, INSERT NAME AND ADDRESS IN SPACE ABOVE LABELED 'VENDOR'



contemporary galleries

November 03, 2011

WV Purchasing
ATTN: Krista Ferrell
2019 Washington Street, East
Charleston, WV 25305

RE: RFQ# BCF12051 for the Department of Health & Human Resources – Hardy County

Dear Krista:

Thank you for giving us the opportunity to bid on this project.

We have used our Herman Miller Action Office System. Our tall panel is 85"H. The glides can be run down if needed to be lower.

The lectern for the training room is in (2) sections.

The large conference table size is 42X84 (that may work even better in the space).

The mail area storage is at 39"H. If needed, the base may be adjusted and the surfaces can be mounted to the tops of the storage.

Please note that if awarded this project, adjustments *may* need to be made in order for the furniture to fit properly before ordering.

Please call if you have any questions or need any more information. (304) 344-1231.

Thank you for your interest in Contemporary Galleries.

Sincerely,

Jennifer B. Kirkpatrick
Sales/Design
jblcontgal@netscape.net

Enc.

SWC SYSFURN10 BID SHEET

Release No.: BCF12051
 Project: DHHR, Bureau for Children and Families, Hardy County Office
 Section: Section 3.3 (Workstation Area Rooms 120 and 140)

Please complete the below pricing sheet to include with your bid. Vendors should complete a separate Bid Sheet for each Section defined in the Bid Request package. Vendors may add additional lines in each section as needed.

A hard copy of this form must be included with your bid and an electronic copy should be emailed to krista.s.ferrell@wv.gov prior to the opening of the bid.

All items bid for this project MUST be a part of your SYSFURN10 Contract award. Vendors bidding items not contained on said award shall be disqualified.

Panel Systems

Size:	Quantity	Manufacturer	Part No.	SWC Catalog #	Page	Location/Rooms	Unit Price	Extended Price
6' x 7' Panels	26	HM	A1125.6224N	HM ACTION OFFIC	74	Workstation Area Rms. 120 & 140	149.50	\$3,887.00
	16	HM	A1125.6236N	HM ACTION OFFIC	74		182.85	\$2,925.60
	16	HM	A1125.6248N	HM ACTION OFFIC	74		202.11	\$3,233.76
	42	HM	A1125.8536G	HM ACTION OFFIC	74		259.33	\$10,891.86
	1	HM	A1125.8536N	HM ACTION OFFIC	74		217.93	\$217.93
	10	HM	A1125.8548G	HM ACTION OFFIC	74		285.20	\$2,852.00
	1	HM	A1125.8548N	HM ACTION OFFIC	74		244.38	\$244.38
Subtotal:								

Installation/Electrical Hardware/Misc for Panels

Description	Quantity	Manufacturer	Part No.	SWC Catalog #	Page	Location/Rooms	Unit Price	Extended Price
3 duplex outlets per station, no power strips.	4	HM	A1311.A	HM ACTION OFFIC	194	PK OF 6	47.44	\$189.76
	3	HM	A1311.B	HM ACTION OFFIC	194	PK OF 6	47.44	\$142.32
	3	HM	A1311.C	HM ACTION OFFIC	194	PK OF 6	47.44	\$142.32
	3	HM	A1311.D	HM ACTION OFFIC	194	PK OF 6	47.44	\$142.32
POWER POLE	6	HM	A1325.85E	HM ACTION OFFIC	183		80.50	\$483.00
Subtotal:								\$0.00

Work Surfaces

Size: Quantity Manufacturer Part No. SWC Catalog # Page Location/Rooms Unit Price Extended Price

24"d x 36"w laminate WS	26	HM	A2310.2436L	HM ACTION OFFIC	211	Workstation Area Rms. 120 & 140	85.68	\$2,227.68
24"d x 36"w corner WS	26	HM	A2332.2436L	HM ACTION OFFIC	214	Workstation Area Rms. 120 & 140	133.98	\$3,483.48
24" d x 48" laminate WS	26	HM	A2310.2448L	HM ACTION OFFIC	211	Workstation Area Rms. 120 & 140	96.31	\$2,504.06
								\$0.00
								\$0.00
								\$0.00
								\$0.00
Subtotal:								\$0.00

Installation Hardware/Misc for Work Surfaces

Description	Quantity	Manufacturer	Part No.	SWC Catalog #	Page	Location/Rooms	Unit Price	Extended Price
+Conn,2-Way 90 Deg Hard	16	HM	A1220.62H	HM ACTION OFFIC	129		35.08	\$561.28
+Conn,2-Way 90 Deg Hard	14	HM	A1220.85H	HM ACTION OFFIC	129		40.54	\$567.56
+Conn,3-Way 90 Deg Hard	7	HM	a1230.85h	HM ACTION OFFIC	135		71.59	\$501.13
+Conn,4-Way 90 Deg 85H	7	HM	a1240.85h	HM ACTION OFFIC	138		91.14	\$637.98
+Fin End 62H	32	HM	A1271.62H	HM ACTION OFFIC	139		13.80	\$441.60
+Fin End 85H	1	HM	A1271.85H	HM ACTION OFFIC	139		14.95	\$14.95
+Draw Rod 57H	20	HM	AO215.57	HM ACTION OFFIC	126		5.75	\$115.00
+Draw Rod 80H	46	HM	AO215.80	HM ACTION OFFIC	126		6.33	\$291.18
FINISHED END CH OF HT	26	HM	AO259.	HM ACTION OFFIC	157		6.33	\$164.58
								\$0.00
Subtotal:								\$0.00

Workstation Requirements

Item	Quantity	Manufacturer	Part No.	SWC Catalog #	Page	Location/Rooms	Unit Price	Extended Price
36"w open shelf	26	HM	A3210.1336	HM ACTION OFFIC	290	Workstation Area Rms. 120 & 140	48.30	\$1,255.80
36"w flipper unit	26	HM	A3353.1336	HM ACTION OFFIC	283	same	124.20	\$3,229.20
24" d f/f pedestal	26	HM	LW140.24FF	HM TU FILING	83	same	140.06	\$3,641.56
24" d b/b/f	26	HM	LW140.24BBF	HM TU FILING	83	same	153.56	\$3,992.56
fully adjustable keyboard	26	HM	Y7727.1A	HM THRIVE	130	same	144.88	\$3,766.88
36" w toolbar - BID ASKS F	26	HM	A3610.48	HM ACTION OFFIC	345	same	27.31	\$710.06
paper tray	52	HM	Y7216.10	HM THRIVE	26	same	11.28	\$586.56
diagonal tray	26	HM	Y7218.	HM THRIVE	30	same	18.38	\$477.88
16" x 36" w tackboard	26	HM	A3410.1236	HM ACTION OFFIC	326	same	33.35	\$867.10
30" w task light	26	HM	G6137.30S	HM ACTION OFFIC	339	same	73.89	\$1,921.14
Subtotal:								\$1,921.14

Installation Hardware/Misc for Work Station Requirements

Description	Quantity	Manufacturer	Part No.	SWC Catalog #	Page	Location/Rooms	Unit Price	Extended Price
								\$0.00
								\$0.00
								\$0.00
								\$0.00
								\$0.00
								\$0.00
								\$0.00
								\$0.00
								\$0.00
Subtotal:								\$0.00

Seating

Description	Quantity	Manufacturer	Part No.	SWC Catalog #	Page	Location/Rooms	Unit Price	Extended Price
task chair, standard	22	SOI	40M.A15	SIT ON IT SEATING	80	Workstation Area Rms. 120 & 140	329.00	\$7,238.00
pneumatic height, tilt, swivel								\$0.00
metal frame, with adjustable								\$0.00
arms, 5 star base with casters								\$0.00
mid back design adjustable								\$0.00
lumbar upholstered fabric								\$0.00
task chair, big and tall	4	SOI	672A2	SIT ON IT SEATING	104		598.52	\$2,394.08
pneumatic height, tilt, swivel								\$0.00
metal frame, with adjustable								\$0.00
arms, 5 star base with casters								\$0.00
mid back design adjustable								\$0.00
lumbar upholstered fabric								\$0.00
Subtotal:								\$0.00

Private Offices

Description	Quantity	Manufacturer	Part No.	SWC Catalog #	Page	Location/Rooms	Unit Price	Extended Price
								\$0.00
								\$0.00
								\$0.00
								\$0.00
								\$0.00
								\$0.00
								\$0.00
								\$0.00
								\$0.00
								\$0.00
Subtotal:								\$0.00

Steel Storage

Description	Quantity	Manufacturer	Part No.	SWC Catalog #	Page	Location/Rooms	Unit Price	Extended Price
							\$0.00	
							\$0.00	
							\$0.00	
							\$0.00	
							\$0.00	
Subtotal:							\$0.00	

Tables

Description	Quantity	Manufacturer	Part No.	SWC Catalog #	Page	Location/Rooms	Unit Price	Extended Price
							\$0.00	
							\$0.00	
							\$0.00	
							\$0.00	
							\$0.00	
Subtotal:							\$0.00	

Miscellaneous Items

Description	Quantity	Manufacturer	Part No.	SWC Catalog #	Page	Location/Rooms	Unit Price	Extended Price
coat hook	4	HMI	AO535	HM ACTION OFFIC PACKAGE OF 6	318	Workstation Area Rms. 120 & 14	8.92	\$35.68
								\$0.00
								\$0.00
Subtotal:								\$0.00

Section Subtotal/Total Bid \$46,041.01

4 legs w/o casters upholstered fabric											\$0.00
Subtotal:											

Private Offices

Description	Quantity	Manufacturer	Part No.	SWC Catalog #	Page	Location/Rooms	Unit Price	Extended Price
36" X 72" d peninsula desk	10	WORK	ST-DB3672	WORKSTREAM	30	106,121,122,124,125	407.16	\$4,071.60
48" w return WITH PEDESTAL	10	WORK	ST-RR2448XF	WORKSTREAM	43	141,142,143,144	489.32	\$4,893.20
48" w over desk w/back board	10	WORK	ST-HD1648	WORKSTREAM	79		514.28	\$5,142.80
48 TACK	10	WORK	AC-NB4816	WORKSTREAM	74	Same	101.92	\$1,019.20
36" w task light	10	HM	G6120.36NS	HM ACTION OFF	332	Same	78.49	\$784.90
24" flr pedestal	10	WORK	INCLUDED	WORKSTREAM		Same		\$0.00
24" blr/flr pedestal	10	WORK	ST-PC1628B	WORKSTREAM	81	Same	405.60	\$4,056.00
Keyboard tray	10	HM	Y7727.1A	HM THRIVE	124	Same	144.88	\$1,448.80
Freestanding paper tray	10	HM	Y7216.10	HM THRIVE	26		11.28	\$112.80
Freestanding diagonal tray	10	HM	Y7218.	HM THRIVE	30		18.38	\$183.80
Subtotal:								\$0.00

Steel Storage

Description	Quantity	Manufacturer	Part No.	SWC Catalog #	Page	Location/Rooms	Unit Price	Extended Price
36" W X 4 high Lateral file	13	WORK	ST-L42036L	WORKSTREAM	82	106,121,122,124,125	900.64	\$11,708.32
36" W X 4 high bookcase	10	WORK	ST-BC1260	WORKSTREAM	83	141,142,143,144	404.56	\$4,045.60
						Same		\$0.00
Subtotal:								\$0.00

Tables

Description	Quantity	Manufacturer	Part No.	SWC Catalog #	Page	Location/Rooms	Unit Price	Extended Price
30" round tabel pedestal based	1	HM	DT1C.30LS	HM EVERYWHE	11	Room 123	177.86	\$177.86
laminated wood, 29" high								\$0.00
								\$0.00
								\$0.00
Subtotal:								\$177.86

Miscellaneous Items

Description	Quantity	Manufacturer	Part No.	SWC Catalog #	Page	Location/Rooms	Unit Price	Extended Price
								\$0.00
								\$0.00
								\$0.00
								\$0.00
Subtotal:								\$0.00

Section Subtotal/Total Bid **\$44,703.74**

Description	Quantity	Manufacturer	Part No.	SWC Catalog #	Page	Location/Rooms	Unit Price	Extended Price
Conference Boards with tackable, writeable surface that will close	2	WORK	AC-MB4848	WORKSTREAM	74	Room 126	539.24	\$1,078.48
								\$0.00
								\$0.00
								\$0.00
Subtotal:								\$0.00

Section Subtotal/Total Bid **\$15,364.84**

SWC SYSFURN10 BID SHEET

Release No.: BCF12051
 Project: DHHR, Bureau for Children and Families, Hardy County Office
 Section: Section 3.6 (Lounge Room 131)

Please complete the below pricing sheet to include with your bid. Vendors should complete a separate Bid Sheet for each Section defined in the Bid Request package. Vendors may add additional lines in each section as needed.

A hard copy of this form must be included with your bid and an electronic copy should be emailed to krista.s.ferrell@wv.gov prior to the opening of the bid.

All items bid for this project MUST be a part of your SYSFURN10 Contract award. Vendors bidding items not contained on said award shall be disqualified.

Panel Systems

Size:	Quantity	Manufacturer	Part No.	SWC Catalog #	Page	Location/Rooms	Unit Price	Extended Price
								\$0.00
								\$0.00
								\$0.00
								\$0.00
								\$0.00
								\$0.00
								\$0.00
								\$0.00
								\$0.00
Subtotal:								\$0.00

Installation/Electrical Hardware/Misc for Panels

Description	Quantity	Manufacturer	Part No.	SWC Catalog #	Page	Location/Rooms	Unit Price	Extended Price
								\$0.00
								\$0.00
								\$0.00
								\$0.00
								\$0.00
								\$0.00
								\$0.00
								\$0.00
								\$0.00
Subtotal:								\$0.00

Work Surfaces

Size: _____ Quantity _____ Manufacturer _____ Part No. _____ SWC Catalog # _____ Page _____ Location/Rooms _____ Unit Price _____ Extended Price _____

Miscellaneous Items

Description	Quantity	Manufacturer	Part No.	SWC Catalog #	Page	Location/Rooms	Unit Price	Extended Price
								\$0.00
								\$0.00
								\$0.00
								\$0.00
								\$0.00
Subtotal:								\$0.00

Section Subtotal/Total Bid \$1,897.02

desk no steel									\$0.00
									\$0.00
									\$0.00
Subtotal:									\$0.00

Installation Hardware/Misc for Work Surfaces

Description	Quantity	Manufacturer	Part No.	SWC Catalog #	Page	Location/Rooms	Unit Price	Extended Price
							\$0.00	\$0.00
							\$0.00	\$0.00
							\$0.00	\$0.00
							\$0.00	\$0.00
							\$0.00	\$0.00
Subtotal:								\$0.00

Workstation Requirements

Item	Quantity	Manufacturer	Part No.	SWC Catalog #	Page	Location/Rooms	Unit Price	Extended Price
single pedestal box/file	6			PART OF DESK		Interview Rooms	\$0.00	\$0.00
free standing design						101A,B,C,F,G,H		
fully adjustable keyboard tray	6	HM	Y7727.1A	HMTTHRIVE	124	Same	144.88	\$869.28
brochure holder attached to the wall, must hold 18 brochures max. 29-1/4" x 2" with wood trim	6	SAFCO	5702MH	SAFCO		Same	183.75	\$1,102.50
Tack board 24" x 16" fabric attached to wall	6	HM	A3410.162	HMACTION OF	326	Same	39.96	\$239.76
Subtotal:								\$0.00

Installation Hardware/Misc for Work Station Requirements

Description	Quantity	Manufacturer	Part No.	SWC Catalog #	Page	Location/Rooms	Unit Price	Extended Price
							\$0.00	\$0.00
							\$0.00	\$0.00
							\$0.00	\$0.00
							\$0.00	\$0.00
							\$0.00	\$0.00
Subtotal:								\$0.00

Seating

Description	Quantity	Manufacturer	Part No.	SWC Catalog #	Page	Location/Rooms	Unit Price	Extended Price
task chairs standard pneumatic height, swivel, and tilt features	6	SOI	40M.A15	SIT ON IT SEAT	80	Interview Rooms	329.00	\$1,974.00
metal frame with height adjustable arms, adjustable lumbar 5 star						101A,B,C,F,G,H		\$0.00
								\$0.00
								\$0.00
								\$0.00
Subtotal:								\$0.00

Description	Quantity	Manufacturer	Part No.	SWC Catalog #	Page	Location/Rooms	Unit Price	Extended Price
stationary without casters								\$0.00
Subtotal:								\$0.00

Private Offices

Description	Quantity	Manufacturer	Part No.	SWC Catalog #	Page	Location/Rooms	Unit Price	Extended Price
								\$0.00
								\$0.00
								\$0.00
								\$0.00
								\$0.00
								\$0.00
								\$0.00
								\$0.00
Subtotal:								\$0.00

Steel Storage

Description	Quantity	Manufacturer	Part No.	SWC Catalog #	Page	Location/Rooms	Unit Price	Extended Price
								\$0.00
								\$0.00
								\$0.00
								\$0.00
								\$0.00
Subtotal:								\$0.00

Tables

Description	Quantity	Manufacturer	Part No.	SWC Catalog #	Page	Location/Rooms	Unit Price	Extended Price
								\$0.00
								\$0.00
								\$0.00
								\$0.00
								\$0.00
Subtotal:								\$0.00

Miscellaneous Items

Description	Quantity	Manufacturer	Part No.	SWC Catalog #	Page	Location/Rooms	Unit Price	Extended Price
								\$0.00
								\$0.00
								\$0.00
								\$0.00
								\$0.00
								\$0.00
Subtotal:								\$0.00

Section Subtotal/Total Bid \$1,644.00

metal frame with height										\$0.00
adjustable arms 5 star										\$0.00
base with casters mid										
back design adjustable										
lumber upholstered in fabric										\$0.00
Subtotal:										

Private Offices

Description	Quantity	Manufacturer	Part No.	SWC Catalog #	Page	Location/Rooms	Unit Price	Extended Price	
							\$0.00		
							\$0.00		
							\$0.00		
							\$0.00		
							\$0.00		
							\$0.00		
							\$0.00		
							\$0.00		
							\$0.00		
							\$0.00		
Subtotal:								\$0.00	

Steel Storage

Description	Quantity	Manufacturer	Part No.	SWC Catalog #	Page	Location/Rooms	Unit Price	Extended Price	
bookcase metal frame	1	HM	LG500.365	HM TU FILING	131	Room 112	289.58	\$289.58	
42" h X 36" w							\$0.00		
adjustable shelves (adjustable	3			INCLUDED		Same		\$0.00	
in 1" increments								\$0.00	
								\$0.00	
Subtotal:								\$0.00	

Tables

Description	Quantity	Manufacturer	Part No.	SWC Catalog #	Page	Location/Rooms	Unit Price	Extended Price	
							\$0.00		
							\$0.00		
							\$0.00		
							\$0.00		
							\$0.00		
							\$0.00		
							\$0.00		
							\$0.00		
Subtotal:								\$0.00	

Miscellaneous Items

Description	Quantity	Manufacturer	Part No.	SWC Catalog #	Page	Location/Rooms	Unit Price	Extended Price	
							\$0.00		
							\$0.00		
							\$0.00		
							\$0.00		
							\$0.00		
Subtotal:								\$0.00	

												\$0.00
												\$0.00
												\$0.00
												\$0.00
												\$0.00
Subtotal:												\$0.00

Section Subtotal/Total Bid **\$2,890.75**

height, swivel, and tilt									\$0.00
features metal frame with									\$0.00
height adjustable arms. 5									\$0.00
star base with casters mid									\$0.00
back design upholstered									\$0.00
in fabric									\$0.00
Subtotal:									\$0.00

Private Offices

Description	Quantity	Manufacturer Part No.	SWC Catalog #	Page	Location/Rooms	Unit Price	Extended Price
						\$0.00	\$0.00
						\$0.00	\$0.00
						\$0.00	\$0.00
						\$0.00	\$0.00
						\$0.00	\$0.00
						\$0.00	\$0.00
						\$0.00	\$0.00
						\$0.00	\$0.00
						\$0.00	\$0.00
Subtotal:						\$0.00	\$0.00

Steel Storage

Description	Quantity	Manufacturer Part No.	SWC Catalog #	Page	Location/Rooms	Unit Price	Extended Price
36" w X 4 high bookcase	1	HM	LG500.366	HM TU FILING	131 Room 113	289.58	\$289.58
						\$0.00	\$0.00
						\$0.00	\$0.00
						\$0.00	\$0.00
						\$0.00	\$0.00
Subtotal:						\$0.00	\$0.00

Tables

Description	Quantity	Manufacturer Part No.	SWC Catalog #	Page	Location/Rooms	Unit Price	Extended Price
Conference table	1	HM	ET153L	HM EAMES TAI	114 Room 113	599.44	\$599.44
84" X 48" w X 29" h						\$0.00	\$0.00
laminiate base with						\$0.00	\$0.00
laminiate top 4 legs						\$0.00	\$0.00
without casters						\$0.00	\$0.00
Subtotal:						\$0.00	\$0.00

Miscellaneous Items

Description	Quantity	Manufacturer Part No.	SWC Catalog #	Page	Location/Rooms	Unit Price	Extended Price
conference board with	1	FIRST OFFIC14-4848VP	FIRST OFFICE	25	Room 113	704.38	\$704.38
tackable (able to insert tacks)						\$0.00	\$0.00

writeable surface that closes																					\$0.00
																					\$0.00
																					\$0.00
																					\$0.00
																					\$0.00
																					\$0.00

Subtotal:

Section Subtotal/Total Bid \$4,225.40

standing podium wood frame	1	SAFCO	8916CY	SAFCO	Room 103	114.10	\$114.10
and laminate 18" x 24" x 44 1/2	1	SAFCO	8917CY	SAFCO		183.40	\$183.40
tall with angled stand, storage							\$0.00
shelf, casters							\$0.00
outlets to be located on workstations							\$0.00
exterior base at 12" intervals							\$0.00
pedestals MUST equal depth of work							\$0.00
service and full height							\$0.00
Subtotal:							

Section Subtotal/Total Bid **\$10,630.14**

SWC SYSFURN10 BID SHEET

Release No.: BCF12051
 Project: DHHR, Bureau for Children and Families, Hardy County Office
 Section: Section 3.32 (Reception/Mail Room Area Room 105)

Please complete the below pricing sheet to include with your bid. Vendors should complete a separate Bid Sheet for each Section defined in the Bid Request package. Vendors may add additional lines in each section as needed.

A hard copy of this form must be included with your bid and an electronic copy should be emailed to krista.s.ferrell@wv.gov prior to the opening of the bid.

All items bid for this project MUST be a part of your SYSFURN10 Contract award. Vendors bidding items not contained on said award shall be disqualified.

Panel Systems

Size:	Quantity	Manufacturer	Part No.	SWC Catalog #	Page	Location/Rooms	Unit Price	Extended Price
+Panel Tack Accoust-	2	HM	A1125.623	HM ACTION OF	74		149.50	\$299.00
+Panel Tack Ac-Barrier	4	HM	A1125.623	HM ACTION OF	74		178.94	\$715.76
+Panel Tack Accoust-	2	HM	A1125.623	HM ACTION OF	74		182.85	\$365.70
+Panel Tack Accoust-	2	HM	A1125.624	HM ACTION OF	74		202.11	\$404.22
								\$0.00
								\$0.00
Subtotal:								\$1,784.68

Installation/Electrical Hardware/Misc for Panels

Description	Quantity	Manufacturer	Part No.	SWC Catalog #	Page	Location/Rooms	Unit Price	Extended Price
3 duplex outlets per station, no power strips.	1	HM	A1311.D	HM ACTION OF	194	Room 105 Reception	47.44	\$47.44
								\$0.00
								\$0.00
								\$0.00
POWER POLE	1	HM	A1325.62E	HM ACTION OF	183		78.49	\$78.49
Subtotal:								\$178.93

Work Surfaces

Size:	Quantity	Manufacturer	Part No.	SWC Catalog #	Page	Location/Rooms	Unit Price	Extended Price
Wall mounted WS	2	HM	A2310.247	HM ACTION OF	211	Mail Room Area 105	144.90	\$289.80
36" High				HM ACTION OFFICE				\$0.00

24"d x 36"w laminate	2 HM	A2310.243	HM ACTION OF	211	Room 105 Reception	85.68	\$171.36
24"d x 36"w corner V	2 HM	A2332.243	HM ACTION OF	214	Room 105 Reception	133.98	\$267.96
24"d x 48" laminate V	2 HM	A2310.244	HM ACTION OF	211	Room 105 Reception	96.31	\$192.62
						Subtotal:	\$0.00

Installation Hardware/Misc for Work Surfaces

Description	Quantity	Manufacturer	Part No.	SWC Catalog #	Page	Location/Rooms	Unit Price	Extended Price
							\$0.00	
							\$0.00	
							\$0.00	
							\$0.00	
							\$0.00	
							\$0.00	
							\$0.00	
						Subtotal:	\$0.00	

Workstation Requirements

Item	Quantity	Manufacturer	Part No.	SWC Catalog #	Page	Location/Rooms	Unit Price	Extended Price
36"w open shelf	2 HM		A2310.133	HM ACTION OF	290		48.30	\$96.60
36"w flipper unit	2 HM		A3353.133	HM ACTION OF	283		124.20	\$248.40
24"d f/f pedestal	2 HM		LW140.24	HM TU FILING	83		280.12	\$560.24
24"d b/b/f	2 HM		LW140.24	HM TU FILING	83		153.56	\$307.12
fully adjustable keybd	2 HM		Y7727.1A	HM THRIVE	124		144.88	\$289.76
36"w toolbar - NOTE	2 HM		A3610.28	HM ACTION OF	345		27.31	\$54.62
paper tray	4 HM		Y7216.10	HM THRIVE	26		11.28	\$45.12
diagonal tray	2 HM		Y7218.	HM THRIVE	30		18.38	\$36.76
16"hx36"w tackboard	2 HM		A3410.123	HM ACTION OF	326		33.35	\$66.70
30"w task light	2 HM		G6137.305	HM ACTION OF	339		73.89	\$147.78
						Subtotal:		\$0.00

Installation Hardware/Misc for Work Station Requirements

Description	Quantity	Manufacturer	Part No.	SWC Catalog #	Page	Location/Rooms	Unit Price	Extended Price
DRAW ROD	10 HM		AO215.57	HM ACTION OF	126		6.61	\$66.10
62H 2-WAY	3 HM		A1220.62H	HM ACTION OF	129		38.81	\$116.43
62H 3-WAY	1 HM		A1230.62H	HM ACTION OF	135		62.68	\$62.68
62H FINISHED END	2 HM		A1271.62H	HM ACTION OF	139		16.10	\$32.20
						Subtotal:		\$0.00

Seating

Description	Quantity	Manufacturer	Part No.	SWC Catalog #	Page	Location/Rooms	Unit Price	Extended Price
task chair, standard	2	SOI	40M.A15	SIT ON IT SEAT	80	Room 105	329.00	\$658.00
pneumatic height, tilt, swivel								\$0.00
metal frame, with adjustable								\$0.00
arms, 5 star base with casters								\$0.00
mid back design adjustable								\$0.00
lumbar upholstered fabric								\$0.00
Stool	1	SOI	40B.A15S	SIT ON IT SEAT	80	Room 105	273.50	\$273.50
								\$0.00
								\$0.00
Subtotal:								\$0.00

Private Offices

Description	Quantity	Manufacturer	Part No.	SWC Catalog #	Page	Location/Rooms	Unit Price	Extended Price
								\$0.00
								\$0.00
								\$0.00
								\$0.00
								\$0.00
								\$0.00
								\$0.00
								\$0.00
Subtotal:								\$0.00

Steel Storage

Description	Quantity	Manufacturer	Part No.	SWC Catalog #	Page	Location/Rooms	Unit Price	Extended Price
lateral files 3 high	2	HM	LW200.36	HM TU FILING	14	Mail Room Area 105	311.85	\$623.70
Storage Cabinet	2	HM	LW400.36	HM TU FILING	125	Same	326.36	\$652.72
with shelves 3 high	2	HM	LG940.36	HM TU FILING	127	Same	15.86	\$31.72
under work surface						Same		\$0.00
3 rolls of 5 double in	60	HM	Y7216.10	HM THRIVE	26	Same	11.28	\$676.80
and out baskets						Same		\$0.00
Subtotal:								\$0.00

Tables

Description	Quantity	Manufacturer	Part No.	SWC Catalog #	Page	Location/Rooms	Unit Price	Extended Price
freestanding table	1	HM	DT1A.306	HM EVERVWHE	5	Mail Room Area 105	270.34	\$270.34
on casters 40" high								\$0.00
w/stool								\$0.00
								\$0.00
								\$0.00
								\$0.00
Subtotal:								\$0.00

Miscellaneous Items

Description	Quantity	Manufacturer	Part No.	SWC Catalog #	Page	Location/Rooms	Unit Price	Extended Price
coat hook	1	HM	AO535	HM ACTION OF PACKAGE OF 6	318	Room 105	8.92	\$8.92
								\$0.00
RAILS	6	HM	A0213.60	HM ACTION OF			14.38	\$86.28
RAIL TILE	8	HM	A3615.163	HM ACTION OF			52.61	\$420.88
								\$0.00

Subtotal:

Section Subtotal/Total Bid **\$6,881.04**

LEFT SIDE

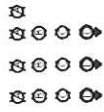
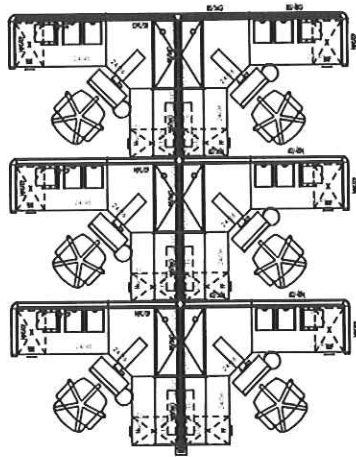

RIGHT SIDE

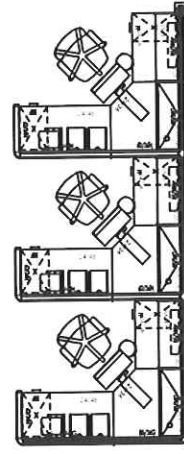
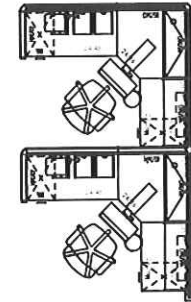
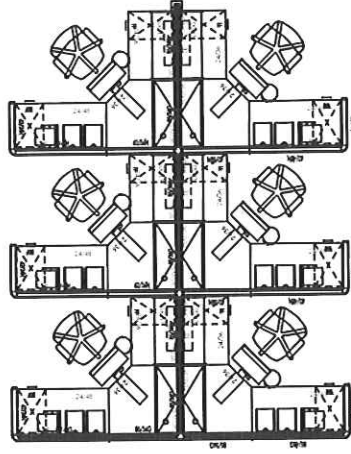
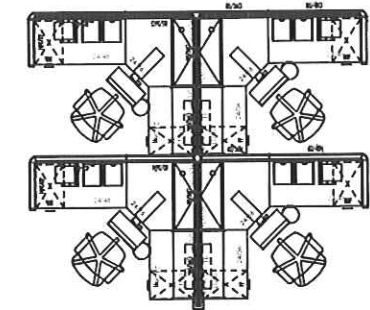
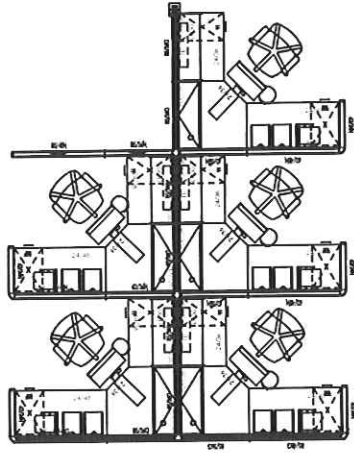

DRAWING TITLE		SECTION 3.3	
PROJECT NAME		HARDY COUNTY DHR OFFICE	
PROJECT ADDRESS		MOOREFIELD, WV	
CONTACT	CONTACT		
DRAWN BY	J. KIRKPATRICK		
ACCOUNT MANAGER	J. KIRKPATRICK		
DATE	11-03-11		
SCALE	TO FIT		
PROJECT NUMBER	REVISONS		
DRAWING LOCATION	HARDY COUNTY DHR OFFICE - HARDY COUNTY BUILDING		
THE DRAWING IS THE PROPERTY OF CONTEMPORARY GALLERIES OF WEST VIRGINIA, INC. AND IS INTENDED FOR OUR EXCLUSIVE USE. ANY REPRODUCTION OR DISTRIBUTION OF THIS DRAWING/DESIGN WITHOUT THE LEGAL WRITTEN CONSENT OF CONTEMPORARY GALLERIES IS PROHIBITED. THIS DRAWING IS LOANED SUBJECT TO BE RETURNED ON DEMAND.			
 contemporariegalleries PO BOX 2827 WY 26330 (304)444-1231			

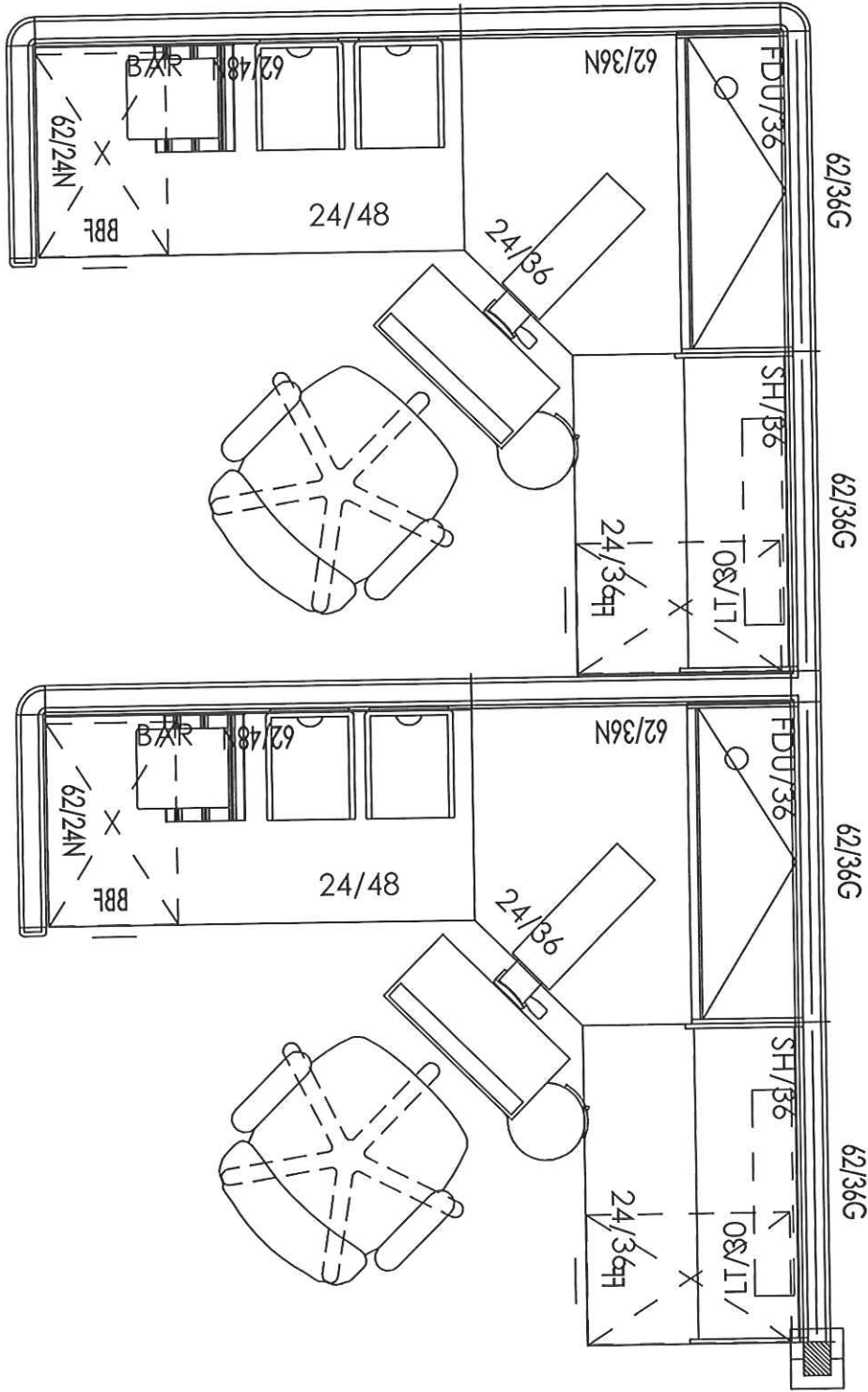

contemporarygalleries

PO BOX 2829
MARTINSBURG, WV 25308
(304)244-1231



PROJECT NUMBER: 11-03-11
DRAWING LOCATION: HARDY COUNTY DHHR - HARDY COUNTY DWG
DATE: 11-03-11
SCALE: TO FIT
PROJECT ADDRESS: MOOREFIELD, WV

CONTACT: J. KIRKPATRICK
ACCOUNT MANAGER: J. KIRKPATRICK
DRAWN BY: J. KIRKPATRICK

SECTION 3.31
HARDY COUNTY DHHR OFFICE
MOOREFIELD, WV

THIS DRAWING IS THE PROPERTY OF CONTEMPORARY GALLERIES OF WEST VIRGINIA, INC. AND IS INTENDED FOR OUR EXCLUSIVE USE. ANY REPRINT OR DISTRIBUTION OF THIS DRAWING WITHOUT THE WRITTEN CONSENT OF CONTEMPORARY GALLERIES IS PROHIBITED. THE DRAWING IS LOANED SUBJECT TO BE RETURNED ON DEMAND.

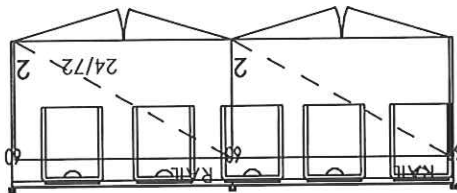
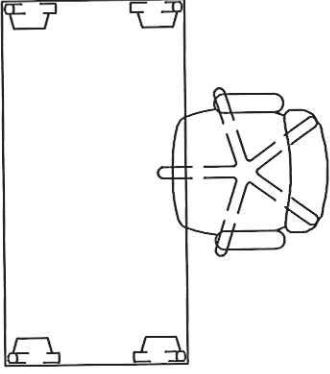
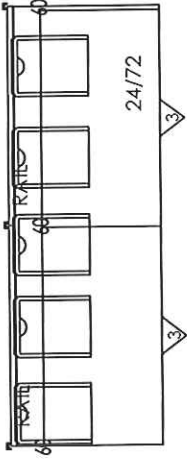

DRAWING TITLE		SECTION 3.32		CONTACT		CONTACT		PROJECT NUMBER		REVISIONS	
PROJECT NAME		HARDY COUNTY DHR OFFICE		DRAWN BY		J. KIRKPATRICK		DRAWING LOCATION		HARDY COUNTY DHR OFFICE	
PROJECT ADDRESS		MOOREFIELD, WV		DATE		11-03-11		PROJECT NUMBER		HARDY COUNTY DHR OFFICE	
				ACCOUNT MANAGER		J. KIRKPATRICK		SCALE		TO FIT	
THE DRAWING IS THE PROPERTY OF CONTEMPORARY GALLERIES OF WEST VIRGINIA INC. AND IS INTENDED FOR OUR EXCLUSIVE USE AS A PART OF THE DESIGN AND CONSTRUCTION OF THE DRAWING. WITHOUT THE LEGAL WRITTEN CONSENT OF CONTEMPORARY GALLERIES IS PROHIBITED. THIS DRAWING IS LOANED SUBJECT TO BE RETURNED ON DEMAND.											
										contemporariegalleries PO BOX 2826 MOOREFIELD, WV 25300 (304) 841-1231	

AC-NB4816

ST-L172036L

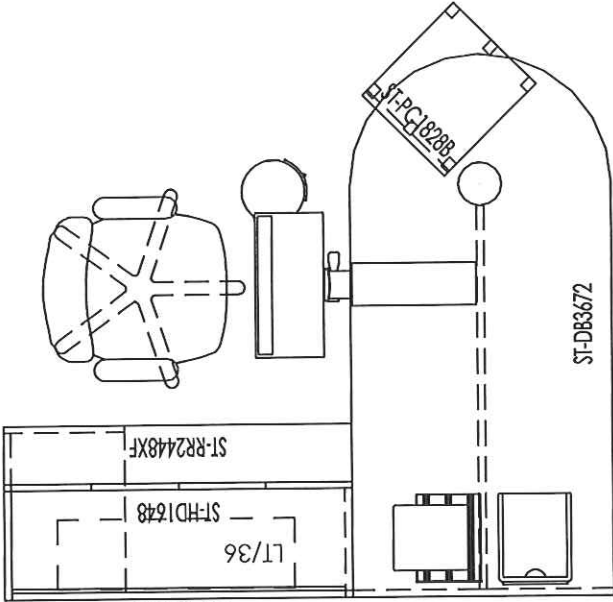

5214

5214

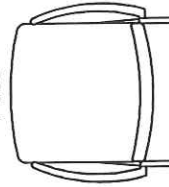
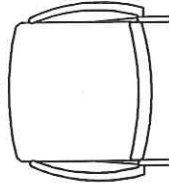

QUANTITY OF (10)



contemporary galleries
 PO BOX 2829 WY 25300
 (304)344-1231

REVISIONS
 PROJECT NUMBER
 DRAWING LOCATION
 PROJECT TITLE
 PROJECT ADDRESS

DATE
 SCALE
 TO FIT

SECTION 3.4
 HARDY COUNTY DHR OFFICE
 MOOREFIELD, WV

THIS DRAWING IS THE PROPERTY OF CONTEMPORARY GALLERIES OF WEST VIRGINIA, INC. AND IS INTENDED FOR OUR USE ONLY. ANY REPRODUCTION OR DISTRIBUTION OF THIS DRAWING WITHOUT THE LEGAL WRITTEN CONSENT OF CONTEMPORARY GALLERIES IS PROHIBITED. THIS DRAWING IS LOANED SUBJECT TO BE RETURNED ON DEMAND.

ACCOUNT MANAGER
 J. KIRKPATRICK

DRAWN BY
 J. KIRKPATRICK

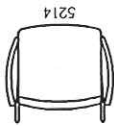
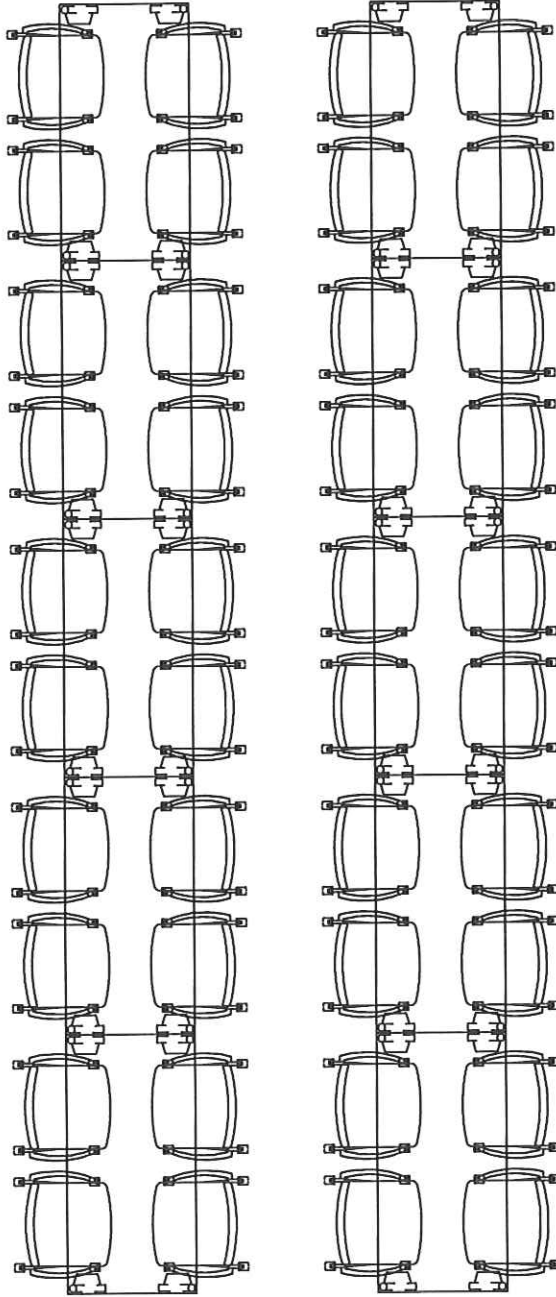

contemporariegalleries

PO BOX 2829
CHARLESTON, WV 25308
(800)444-1211



REVISIONS

PROJECT NUMBER

DRAWING LOCATION
HAYWOOD PROJECTS, LENOIR COUNTY, VA; DHR - HARDY, HARDY COUNTY, WV

THE DRAWING IS THE PROPERTY OF CONTEMPORARY GALLERIES OF WEST VIRGINIA, INC. AND IS INTENDED FOR OUR EXCLUSIVE USE. ANY REPRODUCTION OF THIS DRAWING WITHOUT THE LEGAL WRITTEN CONSENT OF CONTEMPORARY GALLERIES IS PROHIBITED. THIS DRAWING IS LOANED SUBJECT TO BE RETURNED ON DEMAND.

DATE
11-03-11

SCALE
TO FIT

CONTACT

DRAWN BY
J. KIRKPATRICK

ACCOUNT MANAGER
J. KIRKPATRICK

DRAWING TITLE
SECTION 3.5

PROJECT NAME
HARDY COUNTY DHR OFFICE

PROJECT ADDRESS
MOOREFIELD, WV

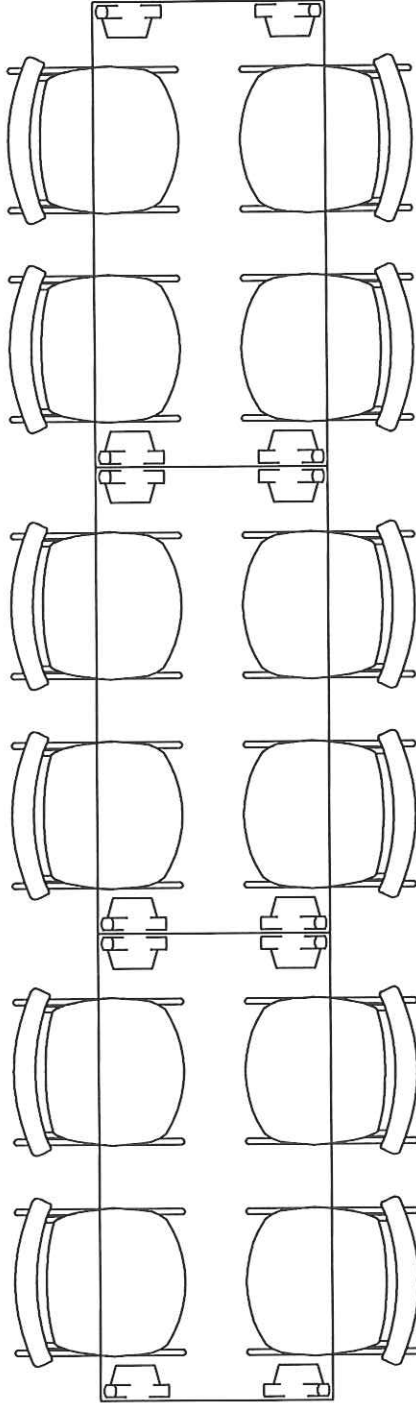

contemporariegalleries
 PO BOX 2829
 CHARLESTON, WV 25308
 (800)44-1211



PROJECT NUMBER	REVISIONS
DRAWING LOCATION	
PROJECT: 2010 WV DHR - HARDY COUNTY DHR THIS DRAWING IS THE PROPERTY OF CONTEMPORARY GALLERIES OF WEST VIRGINIA, INC. AND IS INTENDED FOR OUR USE ONLY. NO PART OF THIS DRAWING OR ANY INFORMATION CONTAINED HEREIN IS TO BE REPRODUCED OR TRANSMITTED IN ANY FORM OR BY ANY MEANS, ELECTRONIC OR MECHANICAL, INCLUDING PHOTOCOPYING, RECORDING, OR BY ANY INFORMATION STORAGE AND RETRIEVAL SYSTEM, WITHOUT THE LEGAL WRITTEN CONSENT OF CONTEMPORARY GALLERIES & PROHIBITED. THIS DRAWING IS LOANED SUBJECT TO BE RETURNED ON DEMAND.	

DATE	TO FIT
11-03-11	
SCALE	
CONTACT	
DRAWN BY	J. KIRKPATRICK
ACCOUNT MANAGER	J. KIRKPATRICK

DRAWING TITLE	SECTION 3.6
PROJECT NAME	HARDY COUNTY DHR OFFICE
PROJECT ADDRESS	MOOREFIELD, WV

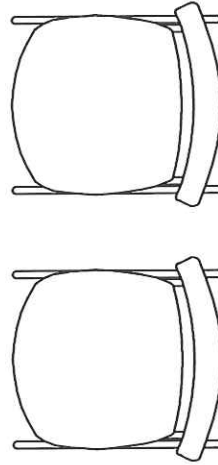
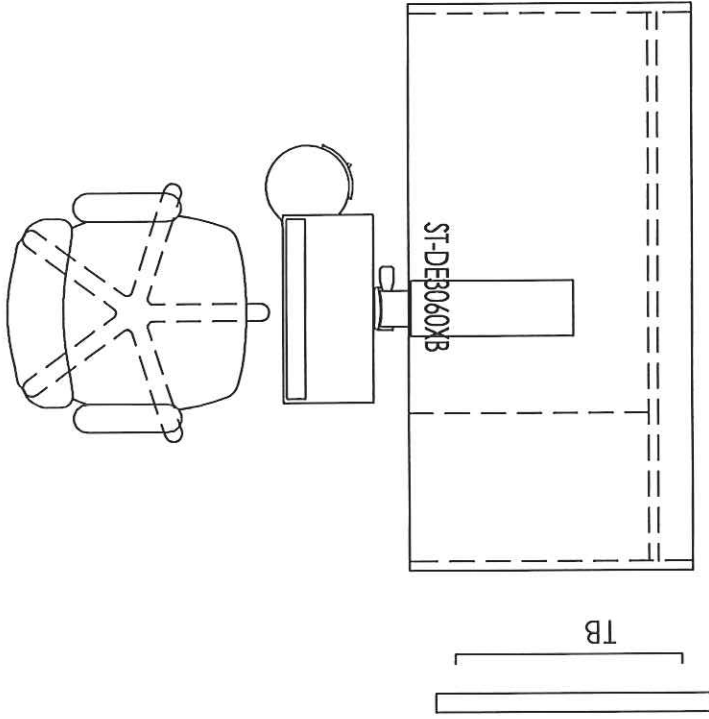

QUANTITY OF (6)

DRAWING TITLE		SECTION 3.7		PROJECT NUMBER		REVISIONS	
PROJECT NAME		HARDY COUNTY DHR OFFICE		DRAWING LOCATION		HARDY COUNTY DHR - HARDY COUNTY, WV	
PROJECT ADDRESS		MOOREFIELD, WV		DATE		11-03-11	
DRAWN BY		J. KIRKPATRICK		SCALE		TO FIT	
ACCOUNT MANAGER		J. KIRKPATRICK		THE DRAWING IS THE PROPERTY OF CONTEMPORARY GALLERIES OF WEST VIRGINIA, INC. AND IS INTENDED FOR OUR EXCLUSIVE USE. ANY REPRODUCTION OR DISTRIBUTION OF THE DRAWING FOR OTHER THAN THE LEGAL WRITTEN CONSENT OF CONTEMPORARY GALLERIES IS PROHIBITED. THIS DRAWING IS LOANED SUBJECT TO BE RETURNED ON DEMAND.			
CONTACT		CONTACT		 contemporariegalleries PO BOX 2829 CHARLESTON, WV 25308 (304) 441-1211			

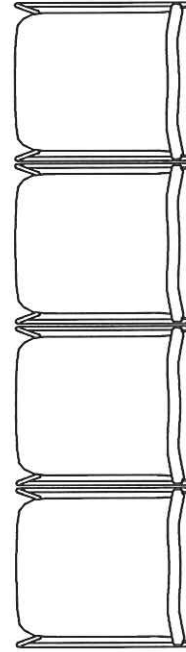
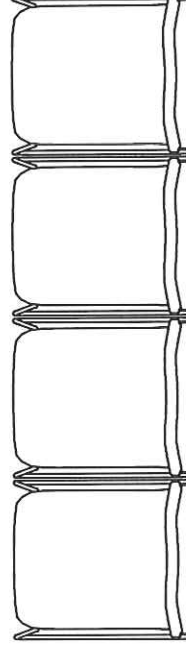
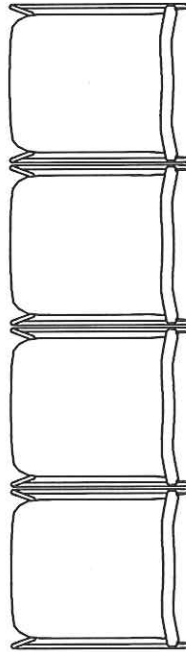
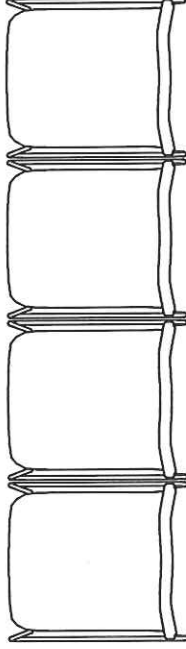
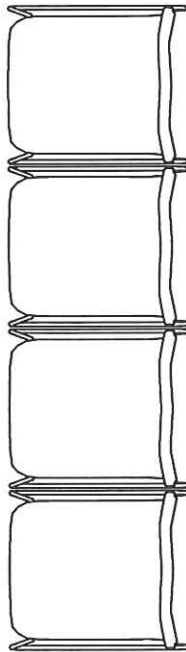
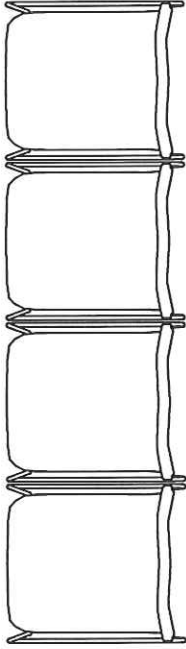

contemporariegalleries
 PO BOX 2827
 CHARLESTON, WV 25300
 (304)344-1231



REVISIONS

PROJECT NUMBER
 DRAWING LOCATION
 HAYZOO PROJECTS, BANNER 2020, WV DHR - HARDY COUNTY DWG

DATE
 11-03-11
 SCALE
 TO FIT

CONTACT
 CONTACT
 DRAWN BY
 J. KIRKPATRICK
 ACCOUNT MANAGER
 J. KIRKPATRICK

DRAWING TITLE
 SECTION 3.8
 PROJECT NAME
 HARDY COUNTY DHR OFFICE
 PROJECT ADDRESS
 MOOREFIELD, WV

THIS DRAWING IS THE PROPERTY OF CONTEMPORARY GALLERIES OF WEST VIRGINIA, INC. AND IS INTENDED FOR OUR CLIENTS USE ONLY. IT IS NOT TO BE REPRODUCED, COPIED, OR TRANSMITTED IN ANY FORM OR BY ANY MEANS, ELECTRONIC OR MECHANICAL, WITHOUT THE WRITTEN CONSENT OF CONTEMPORARY GALLERIES OF WEST VIRGINIA, INC. THIS DRAWING IS LOANED SUBJECT TO BE RETURNED ON DEMAND.

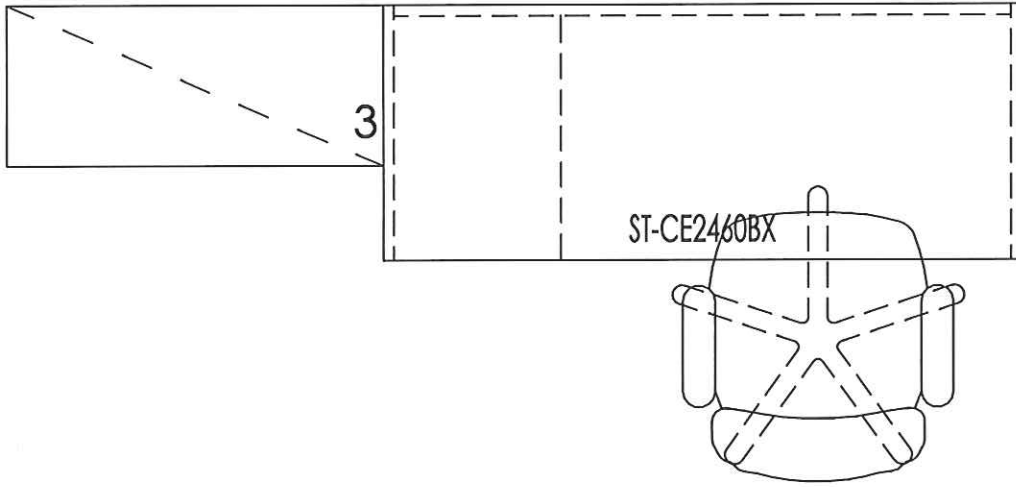

ST-CE2440BX

3

DRAWING TITLE		SECTION 3.9		PROJECT NUMBER		REVISONS	
PROJECT NAME		HARDY COUNTY DHHR OFFICE		DRAWING LOCATION		HARTY HARDY COUNTY DWG	
PROJECT ADDRESS		MOOREFIELD, WV		DATE		11-03-11	
CONTACT		J. KIRKPATRICK		SCALE		TO FIT	
DRAWN BY		J. KIRKPATRICK		<p><small>THIS DRAWING IS THE PROPERTY OF CONTEMPORARY GALLERIES OF WEST VIRGINIA, INC. AND IS INTENDED FOR OUR EXCLUSIVE USE. ANY REPRINT OR REPRODUCTION OF THIS DRAWING DESIGN WITHOUT THE LEGAL WRITTEN CONSENT OF CONTEMPORARY GALLERIES IS PROHIBITED. THIS DRAWING IS LOANED SUBJECT TO BE RETURNED ON DEMAND.</small></p>			
ACCOUNT MANAGER		J. KIRKPATRICK					

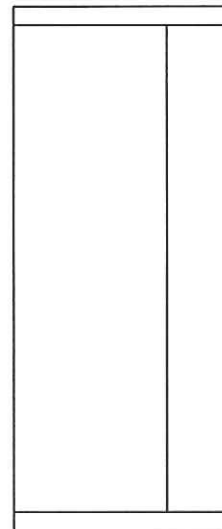
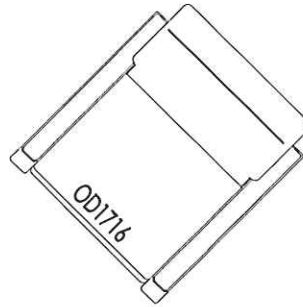
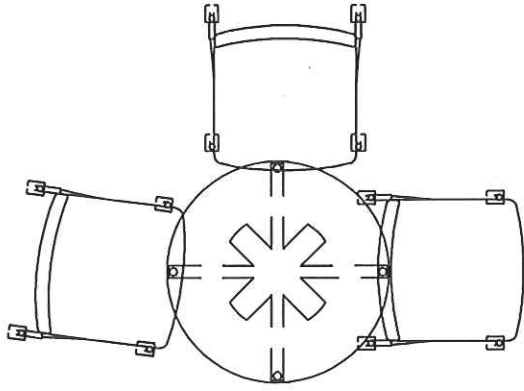

DRAWING TITLE		SECTION 3.10		CONTACT		CONTACT		REVISIONS		 contemporaries PO BOX 2829 CHARLESTON, WV 25306 (304)344-1231	
PROJECT NAME		HARDY COUNTY DHHR OFFICE		DRAWN BY		J. KIRKPATRICK		PROJECT NUMBER			
PROJECT ADDRESS		MOOREFIELD, WV		ACCOUNT MANAGER		J. KIRKPATRICK		DRAWING LOCATION			
				DATE		11-03-11		DRAWING PROJECT NUMBER			
				SCALE		TO FIT		DRAWING PROJECT NUMBER		HARDY COUNTY DHHR - HARDY COUNTY, WV THE DRAWING IS THE PROPERTY OF CONTEMPORARY GALLERIES OF WEST VIRGINIA, INC. AND IS INTENDED FOR OUR EXCLUSIVE USE. ANY REPRODUCTION OR DISTRIBUTION OF THIS DRAWING FOR OTHER THAN THE LEGAL WRITTEN CONSENT OF CONTEMPORARY GALLERIES IS PROHIBITED. THE DRAWING IS LOANED SUBJECT TO BE RETURNED ON DEMAND.	

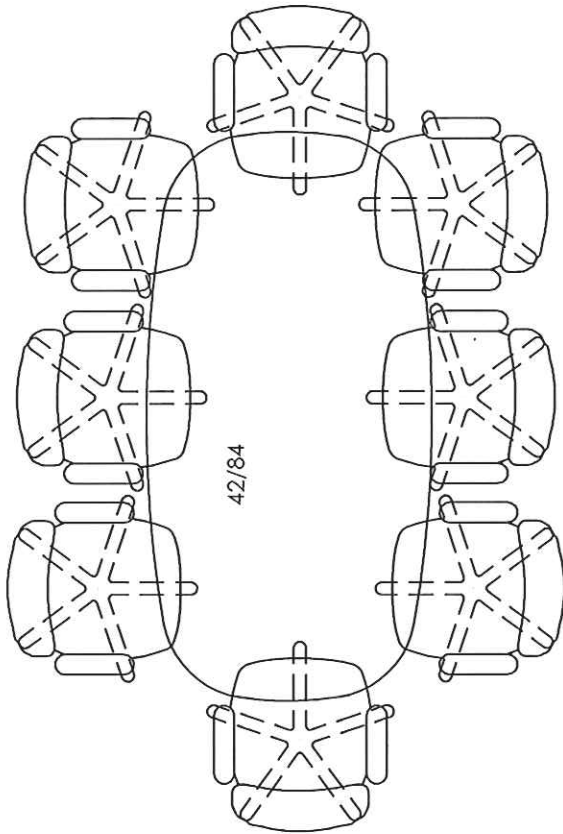

DRAWING TITLE		SECTION 3.11		PROJECT NUMBER		REVISONS	
PROJECT NAME		HARDY COUNTY DHHR OFFICE		DRAWING LOCATION		HARDY COUNTY DHHR - HARDY COUNTY, WV	
PROJECT ADDRESS		MOOREFIELD, WV		DATE		11-03-11	
DRAWN BY		J. KIRKPATRICK		SCALE		TO FIT	
ACCOUNT MANAGER		J. KIRKPATRICK		<p>THIS DRAWING IS THE PROPERTY OF CONTEMPORARY GALLERIES OF WEST VIRGINIA, INC. AND IS INTENDED FOR OUR EXCLUSIVE USE. ANY REPRODUCTION OR DISTRIBUTION OF THIS DRAWING WITHOUT THE LEGAL WRITTEN CONSENT OF CONTEMPORARY GALLERIES IS PROHIBITED. THIS DRAWING IS LOANED SUBJECT TO BE RETURNED ON DEMAND.</p>			
 contemporariegalleries PO BOX 2829 CHARLESTON, WV 25308 (304) 344 1231							

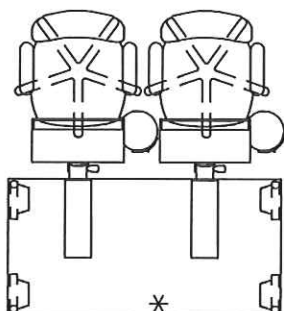
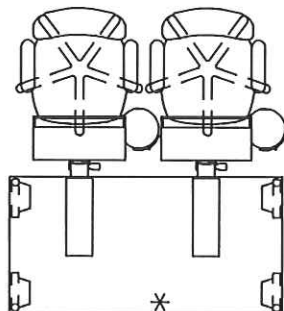
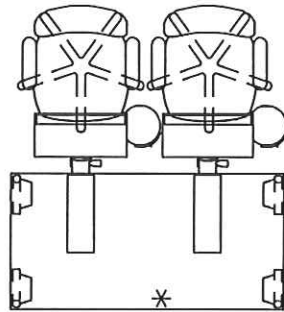
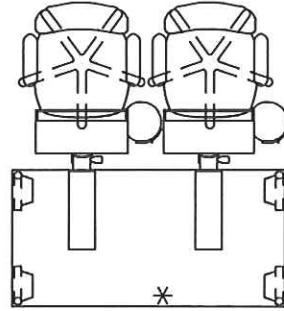
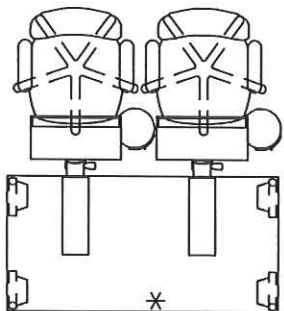
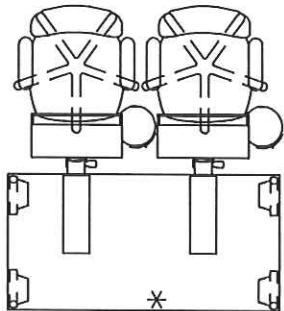
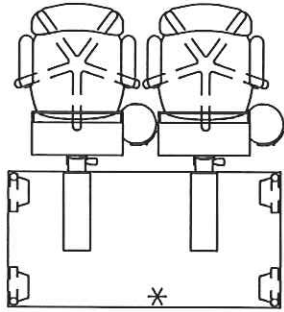
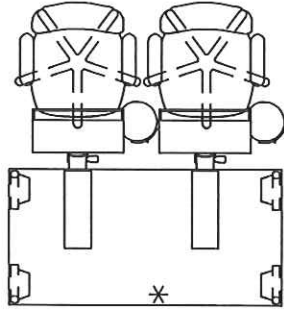

contemporangalleries
PO BOX 2829
CHARLESTON, WV 25300
(803)344-1231



DRAWING TITLE		SECTION 3.12	
PROJECT NAME		HARDY COUNTY DHR OFFICE	
PROJECT ADDRESS		MOOREFIELD, WV	
CONTACT	CONTACT	DRAWN BY	J. KIRKPATRICK
CONTACT	CONTACT	ACCOUNT MANAGER	J. KIRKPATRICK
PROJECT NUMBER	PROJECT NUMBER	DATE	11-03-11
DRAWING LOCATION	DRAWING LOCATION	SCALE	TO FIT
HA 2010 PROJECTS, JANUARY 2010, WV DHR - HARDY, HARDY COUNTY, WV			
THIS DRAWING IS THE PROPERTY OF CONTEMPORARY GALLERIES OF WEST VIRGINIA, INC. AND IS INTENDED FOR OUR CLIENT'S USE ONLY. IT IS NOT TO BE REPRODUCED OR TRANSMITTED IN ANY FORM OR BY ANY MEANS, ELECTRONIC OR MECHANICAL, INCLUDING PHOTOCOPYING, RECORDING, OR BY ANY INFORMATION STORAGE AND RETRIEVAL SYSTEM, WITHOUT THE WRITTEN CONSENT OF CONTEMPORARY GALLERIES OF WEST VIRGINIA, INC. THE DRAWING IS LOANED SUBJECT TO BE RETURNED ON DEMAND.			