



State of West Virginia  
 Department of Administration  
 Purchasing Division  
 2019 Washington Street East  
 Post Office Box 50130  
 Charleston, WV 25305-0130

**Request for  
 Quotation**

RFQ NUMBER
7011EC22A

PAGE
1

ADDRESS CORRESPONDENCE TO ATTENTION OF:
PAUL REYNOLDS 304-558-0468

VENDOR

\*709034551 02 304-842-3511  
 RISH EQUIPMENT COMPANY  
 PO BOX 906  
 BRIDGEPORT WV 26330

SHIP TO

DIVISION OF HIGHWAYS  
 EQUIPMENT DIVISION  
 ROUTE 33  
 BRUSHY FORK ROAD  
 BUCKHANNON, WV  
 26201 304-472-1750

DATE PRINTED	TERMS OF SALE	SHIP VIA	F.O.B.	FREIGHT TERMS
10/12/2011				

BID OPENING DATE: 10/19/2011 BID OPENING TIME 01:30PM

LINE	QUANTITY	UOP	CAT. NO.	ITEM NUMBER	UNIT PRICE	AMOUNT
0001	1	EA		760-47	\$ 99,544.00	\$ 99,544.00
4 WHEEL DRIVE RUBBER TIRED ENDLOADER  REQUEST FOR QUOTATION  OPEN END CONTRACT  THE WEST VIRGINIA STATE PURCHASING DIVISION FOR THE AGENCY, THE WEST VIRGINIA DIVISION OF HIGHWAYS IS SOLICITING BIDS FOR AND OPEN END CONTRACT TO PROVIDE 4 WHEEL DRIVE RUBBER TIRED ENDLOADER PER THE ATTACHED SPECIFICATIONS.  TECHNICAL QUESTIONS CONCERNING THIS SOLICITATION MUST BE SUBMITTED IN WRITING TO PAUL REYNOLDS IN THE WEST VIRGINIA STATE PURCHASING DIVISION VIA MAIL AT THE ADDRESS SHOWN IN THE BODY OF THIS RFQ, VIA FAX AT 304-558-4115, OR VIA EMAIL AT PAUL.REYNOLDS@WV.GOV. ATTACHED FIND WORD DOCUMENT FOR SUBMITTING TECHNICAL QUESTIONS. DEADLINE FOR ALL TECHNICAL QUESTIONS IS 10/14/2011 AT THE CLOSE OF BUSINESS. ANY TECHNICAL QUESTIONS RECEIVED WILL BE ANSWERED BY FORMAL ADDENDUM TO BE ISSUED BY THE PURCHASING DIVISION AFTER THE DEADLINE FOR TECHNICAL QUESTIONS HAS LAPSED.  EXHIBIT 2  LIFE OF CONTRACT: THIS CONTRACT BECOMES EFFECTIVE UPON AWARD AND EXTENDS FOR A PERIOD OF ONE (1)						



SEE REVERSE SIDE FOR TERMS AND CONDITIONS			
SIGNATURE	TELEPHONE	DATE	
Paul Calvert	304-842-3511	10-26-2011	
TITLE	FEIN	ADDRESS CHANGES TO BE NOTED ABOVE	
GENERAL MANAGER	54-139-0608-004		

WHEN RESPONDING TO RFQ, INSERT NAME AND ADDRESS IN SPACE ABOVE LABELED 'VENDOR'

## GENERAL TERMS & CONDITIONS REQUEST FOR QUOTATION (RFQ) AND REQUEST FOR PROPOSAL (RFP)

1. Awards will be made in the best interest of the State of West Virginia.
2. The State may accept or reject in part, or in whole, any bid.
3. Prior to any award, the apparent successful vendor must be properly registered with the Purchasing Division and have paid the required \$125 fee.
4. All services performed or goods delivered under State Purchase Order/Contracts are to be continued for the term of the Purchase Order/Contracts, contingent upon funds being appropriated by the Legislature or otherwise being made available. In the event funds are not appropriated or otherwise available for these services or goods this Purchase Order/Contract becomes void and of no effect after June 30.
5. Payment may only be made after the delivery and acceptance of goods or services.
6. Interest may be paid for late payment in accordance with the *West Virginia Code*.
7. Vendor preference will be granted upon written request in accordance with the *West Virginia Code*.
8. The State of West Virginia is exempt from federal and state taxes and will not pay or reimburse such taxes.
9. The Director of Purchasing may cancel any Purchase Order/Contract upon 30 days written notice to the seller.
10. The laws of the State of West Virginia and the *Legislative Rules* of the Purchasing Division shall govern the purchasing process.
11. Any reference to automatic renewal is hereby deleted. The Contract may be renewed only upon mutual written agreement of the parties.
12. **BANKRUPTCY:** In the event the vendor/contractor files for bankruptcy protection, the State may deem this contract null and void, and terminate such contract without further order.
13. **HIPAA BUSINESS ASSOCIATE ADDENDUM:** The West Virginia State Government HIPAA Business Associate Addendum (BAA), approved by the Attorney General, is available online at [www.state.wv.us/admin/purchase/vrc/hipaa.htm](http://www.state.wv.us/admin/purchase/vrc/hipaa.htm) and is hereby made part of the agreement. Provided that the Agency meets the definition of a Cover Entity (45 CFR §160.103) and will be disclosing Protected Health Information (45 CFR §160.103) to the vendor.
14. **CONFIDENTIALITY:** The vendor agrees that he or she will not disclose to anyone, directly or indirectly, any such personally identifiable information or other confidential information gained from the agency, unless the individual who is the subject of the information consents to the disclosure in writing or the disclosure is made pursuant to the agency's policies, procedures, and rules. Vendor further agrees to comply with the Confidentiality Policies and Information Security Accountability Requirements, set forth in <http://www.state.wv.us/admin/purchase/privacy/noticeConfidentiality.pdf>.
15. **LICENSING:** Vendors must be licensed and in good standing in accordance with any and all state and local laws and requirements by any state or local agency of West Virginia, including, but not limited to, the West Virginia Secretary of State's Office, the West Virginia Tax Department, and the West Virginia Insurance Commission. The vendor must provide all necessary releases to obtain information to enable the director or spending unit to verify that the vendor is licensed and in good standing with the above entities.
16. **ANTITRUST:** In submitting a bid to any agency for the State of West Virginia, the bidder offers and agrees that if the bid is accepted the bidder will convey, sell, assign or transfer to the State of West Virginia all rights, title and interest in and to all causes of action it may now or hereafter acquire under the antitrust laws of the United States and the State of West Virginia for price fixing and/or unreasonable restraints of trade relating to the particular commodities or services purchased or acquired by the State of West Virginia. Such assignment shall be made and become effective at the time the purchasing agency tenders the initial payment to the bidder.

I certify that this bid is made without prior understanding, agreement, or connection with any corporation, firm, limited liability company, partnership, or person or entity submitting a bid for the same material, supplies, equipment or services and is in all respects fair and without collusion or Fraud. I further certify that I am authorized to sign the certification on behalf of the bidder or this bid.

---

### INSTRUCTIONS TO BIDDERS

1. Use the quotation forms provided by the Purchasing Division. Complete all sections of the quotation form.
2. Items offered must be in compliance with the specifications. Any deviation from the specifications must be clearly indicated by the bidder. Alternates offered by the bidder as **EQUAL** to the specifications must be clearly defined. A bidder offering an alternate should attach complete specifications and literature to the bid. The Purchasing Division may waive minor deviations to specifications.
3. Unit prices shall prevail in case of discrepancy. All quotations are considered F.O.B. destination unless alternate shipping terms are clearly identified in the quotation.
4. All quotations must be delivered by the bidder to the office listed below prior to the date and time of the bid opening. Failure of the bidder to deliver the quotations on time will result in bid disqualifications: Department of Administration, Purchasing Division, 2019 Washington Street East, P.O. Box 50130, Charleston, WV 25305-0130
5. Communication during the solicitation, bid, evaluation or award periods, except through the Purchasing Division, is strictly prohibited (W.Va. C.S.R. §148-1-6.6).



State of West Virginia  
 Department of Administration  
 Purchasing Division  
 2019 Washington Street East  
 Post Office Box 50130  
 Charleston, WV 25305-0130

# Request for Quotation

RFQ NUMBER
7011EC22A

PAGE
3

ADDRESS CORRESPONDENCE TO ATTENTION OF:
PAUL REYNOLDS 304-558-0468

VENDOR	*709034551 02 304-842-3511
	RISH EQUIPMENT COMPANY
	PO BOX 906
	BRIDGEPORT WV 26330

SHIP TO	DIVISION OF HIGHWAYS
	EQUIPMENT DIVISION
	ROUTE 33
	BRUSHY FORK ROAD
	BUCKHANNON, WV 26201 304-472-1750

DATE PRINTED	TERMS OF SALE	SHIP VIA	F.O.B.	FREIGHT TERMS
10/12/2011				

BID OPENING DATE: 10/19/2011 BID OPENING TIME 01:30PM

LINE	QUANTITY	UOP	CAT. NO.	ITEM NUMBER	UNIT PRICE	AMOUNT
<p>STATE SPENDING UNIT. IT IS UNDERSTOOD AND AGREED THAT THE CONTRACT SHALL COVER THE QUANTITIES ACTUALLY ORDERED FOR DELIVERY DURING THE TERM OF CONTRACT, WHETHER MORE OR LESS THAN THE QUANTITIES SHOWN.</p> <p>ORDERING PROCEDURE: SPENDING UNIT(S) SHALL ISSUE A WRITTEN EQUIPMENT CONTRACT ORDER (FORM NUMBER WV-35) FOR COMMODITIES COVERED BY THIS CONTRACT. THE ORIGINAL WV-35 MUST BE SENT TO THE PURCHASING DIVISION OF THE DEPARTMENT OF ADMINISTRATION. AFTER APPROVAL AND ENCUMBRANCE, ONE COPY OF THE PURCHASE ORDER WILL BE RETURNED TO THE SPENDING UNIT AND ONE COPY FORWARDED TO THE VENDOR AS AUTHORIZATION FOR SHIPMENT. NO ORDER IS VALID UNLESS APPROVED AND ENCUMBERED BY THE PURCHASING DIVISION.</p> <p>BANKRUPTCY: IN THE EVENT THE VENDOR/CONTRACTOR FILES FOR BANKRUPTCY PROTECTION, THE STATE MAY DEEM THE CONTRACT NULL AND VOID, AND TERMINATE SUCH CONTRACT WITHOUT FUTHER ORDER.</p> <p>REV. 5/2009</p> <p>EXHIBIT 4</p> <p>LOCAL GOVERNMENT BODIES: UNLESS THE VENDOR INDICATES IN THE BID HIS REFUSAL TO EXTEND THE PRICES, TERMS, AND CONDITIONS OF THE BID TO COUNTY, SCHOOL, MUNICIPAL AND OTHER LOCAL GOVERNMENT BODIES, THE BID SHALL EXTEND TO POLITICAL SUBDIVISIONS OF THE STATE OF WEST VIRGINIA. IF THE VENDOR DOES NOT WISH TO EXTEND THE PRICES, TERMS, AND CONDITIONS OF THE BID TO ALL POLITICAL SUBDIVISIONS OF THE STATE, THE VENDOR MUST CLEARLY INDICATE SUCH REFUSAL IN HIS BID. SUCH REFUSAL SHALL NOT PREJUDICE THE AWARD OF THIS CONTRACT IN ANY MANNER.</p>						

SEE REVERSE SIDE FOR TERMS AND CONDITIONS

SIGNATURE <i>Paul Cabnet</i>	TELEPHONE 304-842-3511	DATE 10-26-2011
TITLE GENERAL MANAGER	FEIN 54-139-0608-004	ADDRESS CHANGES TO BE NOTED ABOVE

WHEN RESPONDING TO RFQ, INSERT NAME AND ADDRESS IN SPACE ABOVE LABELED 'VENDOR'



State of West Virginia  
 Department of Administration  
 Purchasing Division  
 2019 Washington Street East  
 Post Office Box 50130  
 Charleston, WV 25305-0130

# Request for Quotation

RFQ NUMBER
7011EC22A

PAGE
2

ADDRESS CORRESPONDENCE TO ATTENTION OF:
PAUL REYNOLDS 304-558-0468

VENDOR	*709034551 02 304-842-3511
	RISH EQUIPMENT COMPANY
	PO BOX 906
	BRIDGEPORT WV 26330

SHIP TO	DIVISION OF HIGHWAYS
	EQUIPMENT DIVISION
	ROUTE 33
	BRUSHY FORK ROAD
	BUCKHANNON, WV 26201
	304-472-1750

DATE PRINTED	TERMS OF SALE	SHIP VIA	F.O.B.	FREIGHT TERMS
10/12/2011				

BID OPENING DATE: 10/19/2011 BID OPENING TIME 01:30PM

LINE	QUANTITY	UOP	CAT NO	ITEM NUMBER	UNIT PRICE	AMOUNT
<p>YEAR OR UNTIL SUCH "REASONABLE TIME" THEREAFTER AS IS NECESSARY TO OBTAIN A NEW CONTRACT OR RENEW THE ORIGINAL CONTRACT. THE "REASONABLE TIME" PERIOD SHALL NOT EXCEED TWELVE (12) MONTHS. DURING THIS "REASONABLE TIME" THE VENDOR MAY TERMINATE THIS CONTRACT FOR ANY REASON UPON GIVING THE DIRECTOR OF PURCHASING THIRTY (30) DAYS WRITTEN NOTICE.</p> <p>UNLESS SPECIFIC PROVISIONS ARE STIPULATED IN THIS CONTRACT DOCUMENT, THE TERMS, CONDITIONS, AND PRICING SET HEREIN ARE FIRM FOR THE LIFE OF THE CONTRACT.</p> <p>RENEWAL: THIS CONTRACT MAY BE RENEWED UPON THE MUTUAL WRITTEN CONSENT OF THE SPENDING UNIT AND VENDOR, SUBMITTED TO THE DIRECTOR OF PURCHASING THIRTY (30) DAYS PRIOR TO THE EXPIRATION DATE. SUCH RENEWAL SHALL BE IN ACCORDANCE WITH THE TERMS AND CONDITIONS OF THE ORIGINAL CONTRACT AND SHALL BE LIMITED TO TWO (2) ONE (1) YEAR PERIODS.</p> <p>CANCELLATION: THE DIRECTOR OF PURCHASING RESERVES THE RIGHT TO CANCEL THIS CONTRACT IMMEDIATELY UPON WRITTEN NOTICE TO THE VENDOR IF THE COMMODITIES AND/OR SERVICES SUPPLIED ARE OF AN INFERIOR QUALITY OR DO NOT CONFORM WITH THE SPECIFICATIONS OF THE BID AND CONTRACT HEREIN.</p> <p>OPEN MARKET CLAUSE: THE DIRECTOR OF PURCHASING MAY AUTHORIZE A SPENDING UNIT TO PURCHASE ON THE OPEN MARKET, WITHOUT THE FILING OF A REQUISITION OR COST ESTIMATE, ITEMS SPECIFIED ON THIS CONTRACT FOR IMMEDIATE DELIVERY IN EMERGENCIES DUE TO UNFORESEEN CAUSES (INCLUDING BUT NOT LIMITED TO DELAYS IN TRANSPORTATION OR AN UNANTICIPATED INCREASE IN THE VOLUME OF WORK).</p> <p>QUANTITIES: QUANTITIES LISTED IN THE REQUISITION ARE APPROXIMATIONS ONLY, BASED ON ESTIMATES SUPPLIES BY TH</p>						

SEE REVERSE SIDE FOR TERMS AND CONDITIONS

SIGNATURE <i>Paul Colvert</i>	TELEPHONE 304-842-3511	DATE 10-26-2011
TITLE GENERAL MANAGER	FEIN 54-139-0608-004	ADDRESS CHANGES TO BE NOTED ABOVE

WHEN RESPONDING TO RFQ, INSERT NAME AND ADDRESS IN SPACE ABOVE LABELED 'VENDOR'



State of West Virginia  
 Department of Administration  
 Purchasing Division  
 2019 Washington Street East  
 Post Office Box 50130  
 Charleston, WV 25305-0130

## Request for Quotation

RFQ NUMBER
7011EC22A

PAGE
4

ADDRESS CORRESPONDENCE TO ATTENTION OF:
PAUL REYNOLDS 304-558-0468

VENDOR

\*709034551 02 304-842-3511  
 RISH EQUIPMENT COMPANY  
 PO BOX 906  
  
 BRIDGEPORT WV 26330

SHIP TO

DIVISION OF HIGHWAYS  
 EQUIPMENT DIVISION  
 ROUTE 33  
 BRUSHY FORK ROAD  
 BUCKHANNON, WV  
 26201 304-472-1750

DATE PRINTED	TERMS OF SALE	SHIP VIA	F.O.B.	FREIGHT TERMS
10/12/2011				

BID OPENING DATE: **10/19/2011** BID OPENING TIME: **01:30PM**

LINE	QUANTITY	UOP	CAT. NO.	ITEM NUMBER	UNIT PRICE	AMOUNT
<p>REV. 3/88</p> <p style="text-align: center;">NOTICE</p> <p>A SIGNED BID MUST BE SUBMITTED TO:</p> <p style="margin-left: 100px;">DEPARTMENT OF ADMINISTRATION            PURCHASING DIVISION            BUILDING 15            2019 WASHINGTON STREET, EAST            CHARLESTON, WV 25305-0130</p> <p>THE BID SHOULD CONTAIN THIS INFORMATION ON THE FACE OF THE ENVELOPE OR THE BID MAY NOT BE CONSIDERED:</p> <p>SEALED BID</p> <p>BUYER: PAUL REYNOLDS FILE 33</p> <p>RFQ. NO.: 7011EC22A</p> <p>BID OPENING DATE: 10/19/2011</p> <p>BID OPENING TIME: 01:30 P.M.</p> <p>PLEASE PROVIDE A FAX NUMBER IN CASE IT IS NECESSARY TO CONTACT YOU REGARDING YOUR BID:</p> <p style="margin-left: 100px;">(304) 842-6126</p> <p>CONTACT PERSON (PLEASE PRINT CLEARLY):</p> <p style="margin-left: 100px;">ANTONIO B. SELARDO</p>						

SEE REVERSE SIDE FOR TERMS AND CONDITIONS

SIGNATURE <i>Paul Calvert</i>	TELEPHONE 304-842-3511	DATE 10-26-2011
TITLE GENERAL MANAGER	FEIN 54-139-0608-004	ADDRESS CHANGES TO BE NOTED ABOVE

WHEN RESPONDING TO RFQ, INSERT NAME AND ADDRESS IN SPACE ABOVE LABELED 'VENDOR'

WEST VIRGINIA DEPARTMENT OF TRANSPORTATION  
DIVISION OF HIGHWAYS  
EQUIPMENT DIVISION

PROCUREMENT SPECIFICATIONS  
NO. 353-1-V

4 WHEEL DRIVE, RUBBER TIRED, ENDLOADER

1.0 PURPOSE

It is the purpose of these specifications to describe a 4 Wheel Drive, Rubber Tired, Endloader (hereinafter referred to as a "endloader" or a "unit") to be purchased for use by the West Virginia Division of Highways (DOH) on an Open End Contract basis.

2.0 BIDDING PROCEDURES

**The current purchasing procedures regarding bidding as established by the Department of Administration, Purchasing Division, shall apply.** Failure to submit the "Request for Quotation" forms, complete in its entirety and according to directions indicated, may subject the bidder to disqualification. **Each bid submitted shall also be accompanied by a Bidder's Evaluation Report completed in detail.** Addendums in order, along with exception sheets, should be with Bidder's Evaluation Report. **FAILURE TO SUBMIT THE BIDDER'S EVALUATION REPORT, COMPLETE IN ITS ENTIRETY, WILL RESULT IN AUTOMATIC DISQUALIFICATION.**

3.0 SPECIFICATIONS

The specifications named herein, mandatory and non-mandatory, establish the acceptable level of quality only and are not intended to reflect a preference or favor any particular brand or vendor.

3.1 EXCEPTIONS TO NON-MANDATORY SPECIFICATIONS

Exception to a non-mandatory unit specification may be made by the bidder, providing the exception is not available from the manufacturer. **Any such exception must be noted on the bidder's evaluation report and should be accompanied by supporting documentation/literature from the manufacturer. Any exception must be indicated on a separate attachment to the bidder's evaluation report and labeled as "Exception to Specifications".** The state reserves the right to waive minor irregularities in bids or specifications in accordance with §148-1-4(f) of the WV Legislative Rules and Regulations.

### 3.2 MANDATORY SPECIFICATIONS

All specifications preceded by "shall, will, and/or must" or are stated as a "minimum and/or maximum" are mandatory as stated in Purchasing Divisions Policies and Procedures. Any bid failing to meet any mandatory item shall be immediately disqualified. Failure to respond in the appropriate evaluation section will also be grounds for immediate disqualification at the discretion of the State.

### 4.0 REPRESENTATIVE UNIT FOR TEST

The successful vendor must (if specified) provide DOH one (1) completed representative unit to be observed and evaluated on each order to insure compliance with specification. If requested, the time period for testing and evaluation shall be seven (7) working days following receipt of the unit. DOH will incur no obligation for deterioration of surfaces, finishes, seals, and mechanical or electrical parts on the unit resulting from operation and testing within the limits of these specifications; nor will DOH incur obligation for damage to the unit resulting from failure to meet specifications when due care and attention is given by DOH and testing is done within the limits of these specifications. Failure of the pilot unit to satisfactorily meet specifications as bid may be cause for cancellation of the purchase order, and return of the delivered unit along with all associated equipment to the vendor at the vendor's expense.

### 4.1 CONDITION OF UNIT(S) UPON DELIVERY

All units must arrive at the prescribed delivery point having been completely preserviced with oil, lubricants, and coolant. All prescribed precautions pertaining to first operations and break-in of the unit are to be posted conspicuously on the unit for ready observance by the operator.

### 4.2 DELIVERY

Delivery point of the completely assembled representative unit will be the DOH, Equipment Division, Route 33 at Brushy Fork Road, Buckhannon, West Virginia (26201).

The vendor is responsible for guaranteeing delivery of the completed units within the time specified and agreed to by the State. Delivery is preferred within 185 calendar days after receipt of purchase agreement. The vendor is responsible for establishing and coordinating delivery terms with allied manufacturers or suppliers. Delivery terms should be stated in the bid and the State reserves the right to accept or reject such terms. Failure to reach an agreement may result in rejection of the bid. **The successful bidder shall provide their manufacturer's confirmation of the order to the WVDOH contact person within seven (7) working days after receiving the approved purchase order.**

**A completed pilot model for inspection must be provided within 100 calendar days after receipt of the purchase agreement by the successful vendor.**

Delivery is an integral part of this specification and failure to comply will be cause to initiate a D.O.T. Administrative Form WV-82, Vendor Performance Form. The WV-82 Form will provide a means of officially notifying the Purchasing Division and the vendor of unsatisfactory performance; such as late deliveries, poor service, inadequate parts supplies, etc.

The decision to initiate subject Form will be at the sole discretion of the D.O.H. Commissioner's established Equipment Review Board.

Issuance of the WV-82 Vendor Complaint Form on unsatisfactory delivery against any vendor will be cause to refuse to consider similar items from those vendors on future Request For Quotations.

(NOTE: Delivery time could be altered due to labor strikes, severe inclement weather conditions, etc.)

## 5.0 AWARD CRITERIA

- 5.1 DOH will recommend the award in accordance with the RFQ evaluation criteria described in the requisition. **The award shall be made to the lowest unit cost vendor that meets or exceeds the specifications.** DOH reserves the right to place multiple orders in any quantity.

## 6.0 SPECIFICATIONS AND GUIDELINES - GENERAL

### 6.1 IDENTIFICATION OF THE UNIT BEING PROPOSED

**The bidder must identify the unit by manufacturer, model, series, and year of manufacture, to enable identification by DOH in the manufacturer's specifications of the proposed unit.** The bidder will submit complete descriptive literature of the proposed unit, to establish that the bid is the manufacturer's most current model, including latest engineering improvements, which have been, or will imminently be, regularly advertised and sold on the open market. The unit specified herein and offered

to be manufactured after January 1, 2011 and be clearly identified and marked with date of manufacture.

### 6.2 OPERATING AND SERVICE MANUALS AND PARTS LISTS

**An operator's manual must be included with each unit upon delivery. A "line sheet" (if applicable) and Equipment Preventative Maintenance Questionnaire (as shown in X6.2 of the Bidder's Evaluation Report) must be with pilot unit upon delivery. In addition, there must be 12 service, shop, or maintenance manuals; ten (10) to be distributed to the Districts and two (2) for the Equipment Division. Also, there must be 14 parts manuals; ten (10) to be distributed to the Districts and four**



(4) for Equipment Division use. CD ROM is preferred in lieu of parts or service manuals.

\* **NOTE: MANUALS SHALL BE DELIVERED UPON COMPLETION OF DELIVERY OF TOTAL UNITS. FAILURE TO DO SO WILL DELAY PAYMENT.**

### 6.3 TRAINING:

Manufacturers and/or dealers will be required to stage a thorough seminar on the subjects of Preventative Maintenance, Operator and Mechanic Training. **In order to keep the operators and mechanics updated, the successful vendor shall conduct training with each purchase order against this open end contract.** Training is preferred within 2 working days after delivery of the pilot unit on the individual purchase order.

**Manufacturers and/or dealers shall be required to furnish the Training Academy with one (1) Operator's Manual to be shipped direct to WVDOH Training Academy, Post Office Box 610, Buckhannon, West Virginia 26201 prior to delivery of the pilot.**

The seminar to be held at the W. Va. Division of Highways, Equipment Division, Buckhannon, West Virginia.

### 6.4 PREVENTIVE MAINTENANCE AND OPERATOR PROCEDURES:

**Manufacturers and/or dealers will be required to submit to the Equipment Division, in addition to the operating and service manuals, booklets and pamphlets explaining the Preventive Maintenance and Operator Procedures to be used by the operators of this equipment, and must include such things as daily prestart inspection procedure, service schedule, and routine maintenance required, safety precautions, etc.**

**The successful vendor shall furnish all training aids; i.e., videos, projectors, etc. required in conducting the training.**

### 6.5 WARRANTY AND SERVICE POLICY

The Manufacturers warranty or service policy is to apply to the unit. Such warranty or service policy is to be recognized at any authorized unit dealer, representing manufacturer of proposed unit throughout the State of West Virginia. The applicable warranty or service policy will not be contingent upon obtaining routine service, lubrication, and servicing of the unit from factory authorized agencies. It will be the responsibility of the bidder to have available labor to repair or replace any defective replacement parts, components and materials, and to have available those replacement parts, components, and/or materials found to be defective during the terms of the warranty period. The bidder should state the labor rates, locations where parts will be stocked, availability of parts, and discounts offered for parts, when terms of the warranty

offer a pro-rated cost for parts and labor. In addition, the successful bidder should offer field work to repair or replace defective parts, components, and materials found to be defective during the terms of the warranty and should provide mechanic's travel rates, mileage charges, field mechanic rates, and any surcharge for miscellaneous items, if applicable, for field work during the warranty period. Submit to Division of Highways any technical or engineering improvements during the term of the warranty. **The unit must be accompanied upon delivery by the unit's manufacturer's executed warranty or service policy.**

**A mandatory minimum two (2) year bumper to bumper basic parts and labor warranty guaranteed by manufacturer excluding abuse and normal wear items is required for this unit without modification.**

**THE "WARRANTY AND SERVICE POLICY QUESTIONNAIRE" ATTACHED IN THE BIDDER'S EVALUATION REPORT MUST BE COMPLETED IN ITS ENTIRETY BY THE SUCCESSFUL BIDDER OR MANUFACTURER PRIOR TO DELIVERY OF THE PILOT MODEL. (SEE SECTION X6.5 OF BIDDER'S EVALUATION REPORT).**

#### 6.6 EVALUATION COMMITTEE REQUIREMENTS

Detailed component specifications, product literature, component models, required for specification compliance determination by the Evaluation Committee should be provided with each bid. Any information supplied that is contrary to/or conflicting with the specifications and/or attached Bidders Evaluation Report may be sufficient cause for rejection of bid.

#### 6.7 UNSPECIFIED ACCESSORIES & FEATURES

**All parts, equipment, accessories, material, design and performance characteristics not specified herein, but which are necessary to provide a complete unit, must be furnished with each unit and required to conform to strength, quality of material, and quality of workmanship to those which are advertised and provided to the market in general by the unit industry.**

**All parts and accessories advertised and regularly supplied as standard shall be included, except those which would represent duplication of these specified, and except those which, by specification, are not to be furnished. All standard safety features, required by Federal and State Law, shall be included.**

7.0 SPECIFICATIONS OF THE QUOTED UNIT ARE AS FOLLOWS:

8.0 Endloader Specification:

8.1 Operating weight to be approximately 18,000 pounds (exclusive of tire ballast).

8.1.1 **Unit shall have a breakout force of 14,000 pounds minimum.**

8.2 Overall length (bucket lowered) 23 foot approximately.

8.3 Loader shall have articulated frame with full hydraulic power steering.

8.3.1 **Tipping load straight 12,000 pounds minimum.**

8.4 Overall height 10 feet 9 inches to top of cab (maximum).

8.4.1 **Dumping clearance at maximum height and 45° dump angle shall be 105 inches minimum**

8.5 Loader shall be equipped with a quick coupler system for interchangeability of attachments, controlled from operator station.

8.6 Unit shall be equipped with manufacturers vandalism package and all machines keyed alike.

8.7 All daily services should be done from ground level.

8.8 Engine:

8.8.1 **Engine to be a minimum power rating of 98 HP**

8.8.2 Manufacturers standard governor with key shut off, wire sealed by manufacturer.

8.8.3 **Engine shall have an engine block water heating element.  
Engine shall have a cold weather starting system consisting of an electric intake manifold pre-heater.**

8.9 Engine Lubrication:

8.9.1 Full pressure lubrication with oil filter and oil by-pass system.

8.9.2 Engine oil cooler.

8.10 Cooling System:

8.10.1 **Manufacturer shall provide maximum cooling system available to allow**

machine to operate at full capability during all seasons.

**8.10.2** Cooling system shall be supplied with Dex-cool or equal extended life anti-freeze protected to a point of -34 degrees F.

**8.10.3** Engine coolant filter shall be provided if recommend by manufacturer for this application.

8.11 Air Induction System:

8.11.1 Dry type dual element (2 stage) air cleaner with pre-cleaner.

**8.11.2** Unit shall have dash mounted air filter restriction indicator that is operator visible when service is required.

8.12 Exhaust System:

**8.12.1** Complete exhaust system shall be manufacturers standard for unit specified.

**8.12.2** Exhaust pipe shall be rain proof.

8.13 Electrical System:

8.13.1 Unit electrical system to be manufacturers noise suppression wiring.

8.13.2 System to be 12 volts/24 volts negative ground (manufacturers standard).

**8.13.3** Manufacturers heavy duty cold cranking amp battery(s), approximately 825 CCA; **reserve capacity 160 minimum.**

8.14 Charging System:

**8.14.1** Unit should have 60 amp alternator (minimum) with internal regulator.

8.15 Engine Fuel System:

**8.15.1** Fuel capacity to be 12 working hours, minimum.

8.15.2 Unit to be provided with a fuel/water separator.

**8.15.3** Dual stage fuel filtering shall be provided.

8.16 Transmission:

- 8.16.1 **Transmission shall be fully hydrostatic with one (1) engine driven pump and two (2) drive motors (hi/low speed) with dynamic breaking inching pedals and a control panel for speed control.**
- 8.16.2 Transmission to have high/low forward and reverse
- 8.16.3 **Transmission shall have a neutral start switch for safety purposes.**
- 8.17 Differential:
  - 8.17.1 Manufacturers front and rear conventional.
- 8.18 Axles:
  - 8.18.1 Front axle to be fixed.
  - 8.18.2 **Rear axle should oscillate 11 degrees minimum.**
- 8.19 Brakes to be as follows:
  - 8.19.1 Manufacturers recommended emergency braking system.
  - 8.19.2 **Emergency brake must be independent of service brake.**
  - 8.19.3 Hydraulic actuated powered assisted service brakes.
  - 8.19.4 Wet type disk service brakes.
- 8.20 Hydraulic System:
  - 8.20.1 **Unit shall provide hydraulic lift, lower, dump, roll back and float plus third spool auxiliary valve and cab controller.**
  - 8.20.2 **All hydraulic cylinders shall be double action chrome plated piston type.**
  - 8.20.3 Loader to be equipped with a hydraulic oil cooler if recommend by manufacturer.
  - 8.20.4 **A sight glass shall be provided for daily checking of hydraulic oil.**
  - 8.20.5 Hydraulic system relief pressure of approximately 2500 PSI.
  - 8.20.6 **Unit shall be equipped with manufacturers standard hydraulic filtering system.**

8.21 Tires and Wheels:

- 8.21.1 **Wheels shall be manufacturers recommended size for unit bid.**
- 8.21.2 **Tires shall be grader/loader type front and rear tubeless radials.**
- 8.21.3 Overall tire width (outside left to outside right) not to exceed 8 feet.

8.22 Cab and related Accessories:

- 8.22.1 **Cab shall be OSHA approved ROPS.**
- 8.22.2 **Cab shall be insulated and pressurized.**
- 8.22.3 **Cab shall be equipped with heater, defroster and air conditioning installed by manufacturer.**
- 8.22.4 **Cab shall have front and rear windshield wipers and washers.**
- 8.22.5 **Cab shall have safety, tinted glass at all locations.**
- 8.22.6 **Left and right side rear view mirrors and in cab rear view mirror shall be provided.**
  
- 8.22.7 **Cab must have at least one (1) entry door, lockable.**
- 8.22.8 Doors should be hinged at rear to provide front to back opening.
- 8.22.9 **Unit shall be provided with non-skid steps and hand holds.**
- 8.22.10 Seat to be cloth type with scotchguard (or equivalent) and with adjustable seat belt.
- 8.22.11 Seat to be equipped with adjustable arm rest.
- 8.22.12 **Seat shall provide height and weight adjustments.**
- 8.22.13 Unit should have adjustable tilt and telescoping steering wheel for easier operator control.
- 8.22.14 **Front and rear fenders shall be provided on unit.**
- 8.22.15 **Fire extinguisher shall be provided and mounted in unit. (Successful bidder**

should notify DOH before mounting).

**8.22.16 AM/FM radio must be provided and installed in unit.**

8.23 Lighting System:

8.23.1 Unit to have two (2) hi/low halogen beam front lights for tramming and working.

8.23.2 Loader to have four (4) work lights, two (2) front and two (2) rear mounted in accordance to cab features.

8.23.3 Unit to have flash/turn signals (front/rear) stoplights and taillights.

**8.23.4 Unit shall be provided with console and dome lighting.**

8.23.5 Class 1 LED beacon, amber

**8.23.6 Unit shall be equipped with OSHA approved audible reverse alarm.**

8.23.7 Articulation locking bar and pin to be provided.

8.24 Unit Instrumentation to provide the following:

8.24.1 Tachometer.

8.24.2 Speedometer.

**8.24.3 Hour meter shall be operable from engine operation not key switch.**

8.24.4 Fuel gauge.

8.24.5 Ammeter/or volt meter.

8.24.6 Coolant temperature indicator with audible buzzer or visual warning light.

8.24.7 Engine oil pressure indicator with audible buzzer or visual warning light.

8.24.8 Transmission oil and/or hydraulic oil temperature indicator or hydraulic filter bypass indicator.

**8.24.9 All features that are considered to be manufacturers standard equipment that are not specifically addressed above shall be provided.**

**8.24.10 Unit shall be delivered to WVDOH with all manufacturers recommended safety related decals and safety features intact.**

**8.24.11 One (1) complete set of replacement filters shall be provided with each unit upon delivery.**

8.25 Bucket:

**8.25.1 The general purpose bucket shall be 1.45 cubic yard minimum**

8.25.2 Bucket width to be approximately 96 inches.

**8.25.3 Bucket shall roll back 40 degrees at ground level and dump at 45 degrees minimum at full height.**

**8.25.4 Unit shall be equipped with automatic return to work leveler for bucket and attachments.**

**8.25.5 Bucket cutting edge and bottom wear strips shall be replaceable.**

**8.25.6 The cutting edge welded to bucket and a bolt-on replaceable cutting edge shall be mounted under it.**

8.25.7 Digging depth below horizontal, (bucket leveled) should be 3 inches (approximately).

8.26 Forks:

**8.26.1 Forks shall be heavy duty steel construction.**

**8.26.2 Carriage shall be heavy duty steel construction.**

8.26.3 Carriage size approximately 3/4 inches side plates and 60 inches wide.

8.26.4 Tines/Forks are to be 6 inches wide and 48 inches long.

8.26.5 Tines/Forks to be approximately 2 inches thick at heel and to be forged solid steel.

8.26.6 Tines/Forks should be mounted on approximately 2.5 inches diameter round bar and adjustable laterally 60 inches approximate.

8.27 Material Handling Boom:

**8.27.1 Material handling boom shall be of heavy duty construction type with hook.**

**8.27.2 Boom of three (3) locking sections with a minimum reach of 12 feet.**



8.28 Paint:

**8.28.1 The endloader and attachments shall be painted manufacturers standard paint color.**

**8.29 Vendor must certify that loader offered will meet or exceed the "Occupational Safety and Health Act of 1970" or subsequent changes that are in effect at time of manufacturer of the unit.**

**8.30 Advertising: Only one (1) manufacturer name plate, which must include model number, may appear on exterior of unit. Logos created through the stamping or casting process of manufacture are also acceptable. No logo will interfere with the Department's striping and logo.**

8.31 Preventive Maintenance and Operators Orientation/Training:

**8.31.1 The Manufacturer or dealer shall provide preventive maintenance/operator orientation seminar to be conducted at the Equipment Division, Buckhannon. All training aids i.e. videos, charts, manuals, etc., to be furnished by successful vendor.**

WEST VIRGINIA DEPARTMENT OF TRANSPORTATION  
DIVISION OF HIGHWAYS  
EQUIPMENT DIVISION

BIDDER'S EVALUATION REPORT

PROCUREMENT SPECIFICATIONS FOR OPEN END CONTRACT  
NO. 353-1-V

4 WHEEL DRIVE, RUBBER TIRED, ENDLOADER

NOTE TO BIDDER: Procurement Specification No. 353-1-S, Paragraph 2.0 recommends the completion and submittal of this Report with your bid. Purpose of this Report is to enable the West Virginia Division of Highways Evaluation Committee to make full and fair evaluation of the bid. Addendums in order, along with a summary of exception as a separate attachment, should be with Bidder's Evaluation Report. FAILURE TO SUBMIT THIS REPORT, COMPLETE IN ITS ENTIRETY, MAY SUBJECT THE BIDDER TO DISQUALIFICATION.

Reference Requisition No.: 7011EC22A

Bidder's Name: RISH EQUIPMENT COMPANY

Address: P.O. Box 906, BRIDGEPORT, WV

Telephone Number: (304) 842-3511

Years Bidder has been registered to do business with the State of West Virginia: 25 YRS.

Years Company has been an authorized dealer for proposed unit: 5 YRS.

X3.2 Have you complied with all mandatory specifications?  YES  NO

X4.2 DELIVERY:

X4.2.1 Delivery date of completed representative unit: 100 Calendar Days After Receipt of Purchase Agreement

X4.2.2 Delivery date of balance of completed units: 185 Calendar Days After Receipt of Purchase Agreement

NOTE: Vendor should type Bidder's Evaluation Report

The "Bidder's Evaluation Report" is available for download on Purchasing's Web site at [www.state.wv.us/admin/purchase](http://www.state.wv.us/admin/purchase)

X5.0 AWARD CRITERIA;

X5.1 Price per unit:

\$ 99,544.<sup>00</sup> per unit

X6.0 SPECIFICATIONS - GENERAL

X6.1 Manufacturer, model, series, and date of manufacture of proposed unit:

KOMATSU WA150-6 WHEEL LOADER - 2012 YEAR  
Is descriptive literature, fully describing proposed unit attached to your bid?  YES  NO

If not, why? \_\_\_\_\_

X6.2 Will the required number of service manuals, and complete parts list be delivered to the Equipment Division at Buckhannon upon completion of delivery of total units?

YES  NO

Will the required Equipment Preventive Maintenance Form (Section X6.2 of Bidders Evaluation Report) be provided upon inspection of the pilot unit?  YES  NO

**EQUIPMENT PREVENTATIVE MAINTENANCE QUESTIONNAIRE**

THIS FORM MUST BE COMPLETED IN ITS ENTIRETY BY SUCCESSFUL BIDDER OR MANUFACTURER'S TECHNICAL REPRESENTATIVE PRIOR TO DELIVERY OF PILOT MODEL TO THE WVDOH.

DESCRIPTION: \_\_\_\_\_ MAKE: \_\_\_\_\_

MODEL: \_\_\_\_\_ YEAR: \_\_\_\_\_ PURCHASE AMOUNT: \_\_\_\_\_

ENGINE: MAKE: \_\_\_\_\_ MODEL: \_\_\_\_\_ FUEL TYPE: \_\_\_\_\_

HORSEPOWER: \_\_\_\_\_ CYLINDER: \_\_\_\_\_ ENGINE SERIAL: \_\_\_\_\_

COOLING SYSTEM CAPACITY: \_\_\_\_\_

BELTS: DESCRIPTION: \_\_\_\_\_ PART NUMBERS: \_\_\_\_\_

\_\_\_\_\_

\_\_\_\_\_

GVW: \_\_\_\_\_ AXLE CAPACITY: FRONT: \_\_\_\_\_ REAR: \_\_\_\_\_

TIRES: FRONT MAKE & SIZE: \_\_\_\_\_

REAR MAKE & SIZE: \_\_\_\_\_

DIMENSIONS OF UNIT: LENGTH: \_\_\_\_\_ WIDTH: \_\_\_\_\_ LENGTH: \_\_\_\_\_

VENDOR CONTACT PERSON: \_\_\_\_\_ PHONE: \_\_\_\_\_

**PARTS:**

BATTERY MAKE: \_\_\_\_\_ MODEL: \_\_\_\_\_ CCA: \_\_\_\_\_

TOP OR SIDE POST: \_\_\_\_\_ DIMENSIONS: LENGTH \_\_\_\_\_ WIDTH \_\_\_\_\_ HEIGHT \_\_\_\_\_

SPARK PLUGS OR FUEL INJECTORS MAKE: \_\_\_\_\_ PART # \_\_\_\_\_

FUEL PUMP OR INJECTION PUMP MAKE: \_\_\_\_\_ MODEL: \_\_\_\_\_

ALTERNATOR MAKE: \_\_\_\_\_ PART #: \_\_\_\_\_

STARTER MAKE: \_\_\_\_\_ PART #: \_\_\_\_\_

TURBO CHARGER MAKE: \_\_\_\_\_ PART #: \_\_\_\_\_

TRANS. MAKE: \_\_\_\_\_ MODEL: \_\_\_\_\_ AUTO/MANUAL: \_\_\_\_\_

HYDRAULIC PUMP MAKE: \_\_\_\_\_ MODEL: \_\_\_\_\_

FILTERS	MAKE	PART NO.	LUBRICANT	MANUFACTURER TYPE
OIL	_____	_____	ENGINE	_____
AIR INNER	_____	_____	TRANSMISSION	_____
AIR OUTER	_____	_____	POWER STEERING	_____
FUEL PRIMARY	_____	_____	HYDRAULIC	_____
FUEL SECONDARY	_____	_____	DIFFERENTIALS	_____
COOLANT	_____	_____	BRAKE FLUID	_____
HYDRAULIC	_____	_____	COOLANT	_____
OTHER	_____	_____	OTHER	_____

X6.3 TRAINING:

Will training seminar be conducted on Preventive Maintenance, Operator and Mechanic Training  YES \_\_\_ NO

Will you conduct training with each purchase order against this open end contract?  YES \_\_\_ NO

Will training be conducted within 2 working days from the delivery of the pilot unit on the individual purchase order?  YES \_\_\_ NO

If NO, explain time frame \_\_\_\_\_

Will an Operator's Manual be furnished directly to Training Academy prior to the delivery of the pilot?  YES \_\_\_ NO

X6.4 If you are the successful vendor, will you furnish all training aids, i.e., videos, projectors, required in conducting the training?  YES \_\_\_ NO

X6.4.1 Will all manuals, booklets, etc. explaining preventive maintenance, operator procedures, and service schedule be delivered with each unit?  YES \_\_\_ NO  
If NO, explain \_\_\_\_\_

X6.5 WARRANTY AND SERVICE POLICY

Will the warranty and service you provide comply with all areas as stated in Section 6.5 of specifications  YES \_\_\_ NO

Is warranty literature attached?  YES \_\_\_ NO

Is a minimum two (2) year bumper to bumper basic parts and labor warranty guaranteed by manufacturer excluding abuse and normal wear items included?  YES \_\_\_ NO

Describe:

SEE ATTACHED WARRANTY DOCUMENT

**X6.5 WARRANTY AND SERVICE POLICY QUESTIONNAIRE**

**THIS FORM MUST BE COMPLETED IN ITS ENTIRETY AND SUBMITTED WITH YOUR BID.**

(If additional lines are needed, make copies of form.)

1. Define the terms of the standard warranty. If not offered, so state. (Attach copy)

STANDARD FACTORY WARRANTY APPLIES FOR TWO (2) YEARS  
UNLIMITED HOURS.

2. Define warranty service to be performed at DOH facilities and warranty service to be performed at manufacturer's representative facility. List name and location of manufacturer's representative.

ALL WARRANTY TO BE PERFORMED AT DEALER UNLESS PRIOR  
ARRANGEMENTS ARE MADE.

3. List locations for parts inventories that are within the State of West Virginia. Also, list availability levels, if known.

BLUEFIELD, WV; BECKLEY, WV; LOGAN, WV; ST. ALBANS, WV; AND  
BRIDGEPORT, WV. FROSTBURG, MD. FOR THE EAST PANHANDLE

4. During the term of warranty, list the guarantee discount to manufacturer's published list price for parts that bidder will sell the parts to owner.

- A. Terms: Net 30                      Manufacturer's published list price less: 0 % discount
- B. Terms: Net 60                      Manufacturer's published list price less: 0 % discount
- C. Terms: Net 90                      Manufacturer's published list price less: 0 % discount

5. During the term of warranty, will all manufacturers or engineering improvements be submitted to Division of Highways?                      X YES      \_\_\_ NO

6. During the term of warranty, list the guaranteed rates charged for repair to the unit.

- A. Shop Rate                              \$ 80.00 per mechanic hour
- B. Travel Time Charge                      \$ 85.00 per mechanic hour  
(Specify if one-way)                      \_\_\_\_\_; port to port \_\_\_\_\_
- C. Mileage Charge                              \$ 3.00 per vehicle mile  
(Specify if one-way)                      \_\_\_\_\_; port to port \_\_\_\_\_
- D. Field Mechanic Rate                      \$ 85.00 per mechanic hour
- E. Specify period of time that prices are in effect: 1 YEAR
- F. Surcharge for miscellaneous items: 4% OF LABOR %

**X6.6 EVALUATION COMMITTEE REQUIREMENTS**

Is all component specifications, product literature, component models provided for Evaluation Committee bid determination?  YES  NO

**X6.7 Will all parts, equipment, accessories, material, design and performance characteristics not specified herein, but which are necessary to provide a complete unit, be furnished with the unit and conform in strength, quality of material, and quality of workmanship to those which are advertised and provided to the market in general by the unit industry?**

YES  NO

**X6.7.1 Are all parts and accessories adequate and regularly supplied as standard to be included except those which may be duplications of specifications herein, and except these by specification are not to be furnished?**

YES  NO

**X6.7.2 Are all standard safety features that are required by Federal and State statutes of law included?**

YES  NO

**X7.0 SPECIFICATIONS OF THE QUOTED UNIT**

The bidder should complete the following schedule in order for the Division to compare the actual bid unit to the specifications. Should the bidder except a requirement, then such exception may be only on the basis that such feature is not offered by the manufacturer. The Division will have the sole discretion as to whether the bidder's substitution meets the requirements of the specifications.

Manufacturer: KOMATSU Model: WA150-6

**X8.0 Endloader Specification:**

**X8.1 Operating weight:** 18,136 pounds (exclusive of tire ballast)

**X8.1.1 Breakout force:** 14,604 pounds

**X8.2 Overall length (bucket lowered):** 20'6" foot

**X8.3 Does loader have articulated frame and full hydraulic power steering?**  
 YES  NO

**X8.3.1 Tipping load straight:** 14,476 pounds

**X8.4 Overall height:** 10'0" to top of cab

- X8.4.1 Dumping clearance at maximum height and 45° dump angle: 106 inches
- X8.5 Are units provided with a quick coupler system for interchangeability of attachments, controlled from operator station  YES  NO
- X8.6 Do machine(s) have vandalism package/keyed alike?  YES  NO
- X8.7 Are daily services done from ground level?  YES  NO
- X8.8 Engine:
- X8.8.1 Engine to be a minimum power rating of 98 HP
- X8.8.2 Is unit equipped with manufacturer's standard governor with key shut off, wire sealed by Manufacturer?  YES  NO
- X8.8.3 Engine equipped with an engine block water heating element?  YES  NO
- Does engine have cold weather starting system consisting of an electric intake manifold pre-heater  YES  NO
- X8.9 Engine Lubrication:
- X8.9.1 Has full pressure lubrication with oil filter and oil by-pass system?  YES  NO
- X8.9.2 Is engine equipped with oil cooler?  YES  NO
- X8.10 Cooling System:
- X8.10.1 Is cooling system of manufacturers maximum to allow full capability of operation for all seasons?  YES  NO
- X8.10.2 Cooling system supplied with Dex-Cool or equal extended life anti freeze to -34°F?  YES  NO
- X8.10.3 Is coolant filter provided if recommended manufacturer for this application?  YES  NO
- X8.11 Air Induction System:
- X8.11.1 Is dry type (2 stage) dual element air cleaner with pre-cleaner provided?  YES  NO
- X8.11.2 Does unit have dash mounted air filter restriction indicator that is visible when service is required ?  YES  NO



X8.12 Exhaust System:

X8.12.1 Is complete exhaust system manufacturers standard for unit specified?

YES  NO

X8.12.2 Is exhaust pipe rain proof?

YES  NO

X8.13 Electrical System:

X8.13.1 Is unit provided with manufacturers noise suppression wiring?

YES  NO

X8.13.2 Is system 12 volts/24 volts negative ground

YES  NO

X8.13.3 Are heavy duty CCA battery(s) provided?

YES  NO

CCA 825 reserve capacity 1160

X8.14 Charging System:

X8.14.1 Alternator AMPS: 60

with internal regulator?  YES  NO

X8.15 Engine Fuel System:

X8.15.1 Is fuel capacity at least 12 working hours

YES  NO

X8.15.2 Is unit provided with a fuel/water separator?

YES  NO

X8.15.3 Is dual stage fuel filtering provided?

YES  NO

X8.16 Transmission:

X8.16.1 Transmission is to have high/low, forward and reverse with a ground speed of minimum of 23 mph.  YES  NO

X8.16.2 Does transmission have high/low  YES  NO

forward and reverse  YES  NO

X8.16.3 Is neutral start switch provided for safety purposes?

YES  NO

X8.17 Differential:

X8.17.1 Is front and rear differential manufacturers conventional type?  YES  NO

X8.18 Axles:

X8.18.1 Is front axle fixed?  YES  NO

X8.18.2 Oscillation of rear axle: 11 degrees

X8.19 Brakes:

X8.19.1 Is Manufacturers recommended emergency braking system provided?  YES  NO

X8.19.2 Is emergency brake independent of service brake?  YES  NO

X8.19.3 Are service brakes powered assisted hydraulic actuated?  YES  NO

X8.19.4 Are service brakes wet disk type?  YES  NO

X8.20 Hydraulic System:

X8.20.1 Does unit provide hydraulic lift, lower, dump, roll back and float  YES  NO

Does unit have third spool auxiliary valve and cab controller  YES  NO

X8.20.2 Are hydraulic cylinders double action chrome plated piston type?  YES  NO

X8.20.3 Is hydraulic oil cooler provided if recommended by manufacturer?  YES  NO

X8.20.4 Is sight glass provided for daily service checks?  YES  NO

X8.20.5 Hydraulic system relief pressure: 2,700 P.S.I.

X8.20.6 Is Manufacturers standard hydraulic filtering system provided?  YES  NO

X8.21 Tires and Wheels:

X8.21.1 Are wheels manufacturers recommended size for unit bid?  YES  NO

Specify size 17.5-R25

X8.21.2 Are tires grader/loader type tubeless radials front and rear?  YES  NO

Specify size: 17.5 - R25

X8.21.3 Overall tire width (outside left to outside right): 7' feet 3" inches

X8.22 Cab and related accessories:

X8.22.1 Is cab OSHA approved ROPS?  YES  NO

X8.22.2 Is cab insulated and pressurized?  YES  NO

X8.22.3 Is cab equipped with heater, defroster, air conditioning installed by the manufacturer?  YES  NO

X8.22.4 Is cab equipped with wipers and washers front and rear?  YES  NO

X8.22.5 Is Manufacturers tinted safety glass at all locations?  YES  NO

X8.22.6 Are left and right rear view mirrors and in cab rear view mirror provided?  YES  NO

X8.22.7 Does cab have one (1) lockable entry door?  YES  NO

X8.22.8 Are doors hinged at rear to provide front to back opening  YES  NO

X8.22.9 Is unit provided with non-skid steps and hand holds  YES  NO

X8.22.10 Is seat cloth type with scotchguard or equal and with adjustable seat belt  YES  NO

X8.22.11 Is seat equipped with adjustable arm rests?  YES  NO

X8.22.12 Does seat provide height and weight adjustments?  YES  NO

X8.22.13 Is unit equipped with adjustable tilt and telescoping steering wheel for easier operator control?  YES  NO

X8.22.14 Are fenders provided front and rear?  YES  NO

X8.22.15 Is fire extinguisher provided and mounted on unit?  YES  NO

X8.22.16 Is AM/FM radio provided and installed in unit?  YES  NO

## X8.23 Lighting System:

- X8.23.1 Is unit equipped with two (2) hi/low halogen beam front lights for tramming and working?  YES  NO
- X8.23.2 Does unit have four (4) work lights; two (2) front/two (2) rear cab mounted work lights  YES  NO
- X8.23.3 Does unit have flash/turn signals (front and rear), stoplights, and taillights?  YES  NO
- X8.23.4 Does unit have console and dome lighting?  YES  NO
- X8.23.5 Does unit have Class 1 LED beacon, amber  YES  NO

If NO, explain \_\_\_\_\_

\_\_\_\_\_

X8.23.6 Is unit equipped with audible OSHA approved reverse alarm?  YES  NO

X8.23.7 Is articulation locking bar and pin provided?  YES  NO

## X8.24 Unit Instrumentation:

- X8.24.1 Tachometer?  YES  NO
- X8.24.2 Speedometer?  YES  NO
- X8.24.3 Does hour meter operate from engine operation?  YES  NO
- X8.24.4 Fuel gauge?  YES  NO
- X8.24.5 Ammeter/ or volt meter?  YES  NO
- X8.24.6 Does coolant temperature indicator have audible buzzer or visual warning light?  YES  NO
- X8.24.7 Does engine oil pressure indicator have audible buzzer or visual warning light?  YES  NO
- X8.24.8 Transmission oil and/or hydraulic oil temperature indicator or hydraulic filter bypass indicator?  YES  NO

X8.24.9 All features considered to be standard equipment not addressed above:

28

YES

X8.24.10 Will unit be delivered to WV DOH with manufacturer's safety decals and features intact?  YES  NO

X8.24.11 Is one (1) complete set of replacement filters for each unit provided?  YES  NO

X8.25 Bucket:

X8.25.1 General purpose bucket shall be 1.4 cubic yard minimum.

X8.25.2 Bucket width: 96" inches

X8.25.3 Bucket roll back 40 degrees at ground level and dump at full height 45 degrees

X8.25.4 Does unit have automatic return to work leveler for bucket and attachments  YES  NO

X8.25.5 Are replaceable cutting edge and bottom wear strips provided  YES  NO

X8.25.6 Is cutting edge welded to bucket and bolt on replaceable cutting edge mounted under it?  YES  NO

X8.25.7 Digging depth below horizontal (bucket level): 3" inches

X8.26 Forks:

X8.26.1 Are forks heavy duty steel construction?  YES  NO

X8.26.2 Is carriage of heavy duty steel construction?  YES  NO

X8.26.3 Carriage size: 3/4 inch side plates and 60 inches wide?

X8.26.4 Tines/Forks: 6 inches wide and 48 inches long

X8.26.5 Tines/Forks: 2 inches thick at heel and forged solid steel  YES  NO

X8.26.6 Tines/Forks mounted on 2.5 inches diameter round bar

Adjustable laterally 60 inches

X8.27 Material Handling Boom:

X8.27.1 Is material handling boom of heavy duty construction with hook?  YES  NO

X8.27.2 Boom has 3 locking sections Boom reach: 12 feet

X8.28 Paint:

X8.28.1 Is endloader painted manufacturers standard color?  YES  NO

X8.29 Does proposed unit meet or exceed the "OSHA of 1970" and/or subsequent changes?  YES  NO

X8.30 Does unit conform to the advertising guidelines?  YES  NO

X8.31 Preventive Maintenance and Operators Orientation/Training:

X8.31.1 Have you attached a copy of proposed training program. Attach schedule describing course offered with a brief explanation of each subject with the time required for each class. Do not attach instruction material or manuals. Will you furnish all training aids; i.e. videos, projectors, etc., required in conducting the training?  YES  NO



State of West Virginia  
 Department of Administration  
 Purchasing Division  
 2019 Washington Street East  
 Post Office Box 50130  
 Charleston, WV 25305-0130

# Request for Quotation

RFQ NUMBER
7011EC22A

PAGE
1

ADDRESS CORRESPONDENCE TO ATTENTION OF:
PAUL REYNOLDS
304-558-0468

VENDOR

\*709034551 02 304-842-3511  
 RISH EQUIPMENT COMPANY  
 PO BOX 906  
 BRIDGEPORT WV 26330

SHIP TO

DIVISION OF HIGHWAYS  
 EQUIPMENT DIVISION  
 ROUTE 33  
 BRUSHY FORK ROAD  
 BUCKHANNON, WV  
 26201 304-472-1750

DATE PRINTED	TERMS OF SALE	SHIP VIA	F.O.B.	FREIGHT TERMS
10/25/2011				

BID OPENING DATE: 11/02/2011 BID OPENING TIME 01:30PM

LINE	QUANTITY	UOP	CAT. NO.	ITEM NUMBER	UNIT PRICE	AMOUNT
ADDENDUM NO. 2						
CHANGES TO THE SPECIFICATIONS ATTACHED.						
BID OPENING DATE CHANGED						
FROM: 10/26/11 @ 1:30 P.M.						
TO: 11/02/11 @ 1:30 P.M.						
NO OTHER CHANGES.						
0001	1	EA		760-47	\$99,544. <sup>00</sup>	\$99,544. <sup>00</sup>
				4 WHEEL DRIVE RUBBER TIRED ENDLOADER		
***** THIS IS THE END OF RFQ 7011EC22A ***** TOTAL:						\$99,544. <sup>00</sup>

SEE REVERSE SIDE FOR TERMS AND CONDITIONS

SIGNATURE <i>Paul Calvert</i>	TELEPHONE 304-842-3511	DATE 11-01-11
----------------------------------	---------------------------	------------------

TITLE <i>General Mgr.</i>	FEIN 54-139-0608-004	ADDRESS CHANGES TO BE NOTED ABOVE
------------------------------	-------------------------	-----------------------------------

WHEN RESPONDING TO RFQ, INSERT NAME AND ADDRESS IN SPACE ABOVE LABELED 'VENDOR'

## GENERAL TERMS & CONDITIONS REQUEST FOR QUOTATION (RFQ) AND REQUEST FOR PROPOSAL (RFP)

1. Awards will be made in the best interest of the State of West Virginia.
2. The State may accept or reject in part, or in whole, any bid.
3. Prior to any award, the apparent successful vendor must be properly registered with the Purchasing Division and have paid the required \$125 fee.
4. All services performed or goods delivered under State Purchase Order/Contracts are to be continued for the term of the Purchase Order/Contracts, contingent upon funds being appropriated by the Legislature or otherwise being made available. In the event funds are not appropriated or otherwise available for these services or goods this Purchase Order/Contract becomes void and of no effect after June 30.
5. Payment may only be made after the delivery and acceptance of goods or services.
6. Interest may be paid for late payment in accordance with the *West Virginia Code*.
7. Vendor preference will be granted upon written request in accordance with the *West Virginia Code*.
8. The State of West Virginia is exempt from federal and state taxes and will not pay or reimburse such taxes.
9. The Director of Purchasing may cancel any Purchase Order/Contract upon 30 days written notice to the seller.
10. The laws of the State of West Virginia and the *Legislative Rules* of the Purchasing Division shall govern the purchasing process.
11. Any reference to automatic renewal is hereby deleted. The Contract may be renewed only upon mutual written agreement of the parties.
12. **BANKRUPTCY:** In the event the vendor/contractor files for bankruptcy protection, the State may deem this contract null and void, and terminate such contract without further order.
13. **HIPAA BUSINESS ASSOCIATE ADDENDUM:** The West Virginia State Government HIPAA Business Associate Addendum (BAA), approved by the Attorney General, is available online at [www.state.wv.us/admin/purchase/vrc/hipaa.htm](http://www.state.wv.us/admin/purchase/vrc/hipaa.htm) and is hereby made part of the agreement. Provided that the Agency meets the definition of a Cover Entity (45 CFR §160.103) and will be disclosing Protected Health Information (45 CFR §160.103) to the vendor.
14. **CONFIDENTIALITY:** The vendor agrees that he or she will not disclose to anyone, directly or indirectly, any such personally identifiable information or other confidential information gained from the agency, unless the individual who is the subject of the information consents to the disclosure in writing or the disclosure is made pursuant to the agency's policies, procedures, and rules. Vendor further agrees to comply with the Confidentiality Policies and Information Security Accountability Requirements, set forth in <http://www.state.wv.us/admin/purchase/privacy/noticeConfidentiality.pdf>.
15. **LICENSING:** Vendors must be licensed and in good standing in accordance with any and all state and local laws and requirements by any state or local agency of West Virginia, including, but not limited to, the West Virginia Secretary of State's Office, the West Virginia Tax Department, and the West Virginia Insurance Commission. The vendor must provide all necessary releases to obtain information to enable the director or spending unit to verify that the vendor is licensed and in good standing with the above entities.
16. **ANTITRUST:** In submitting a bid to any agency for the State of West Virginia, the bidder offers and agrees that if the bid is accepted the bidder will convey, sell, assign or transfer to the State of West Virginia all rights, title and interest in and to all causes of action it may now or hereafter acquire under the antitrust laws of the United States and the State of West Virginia for price fixing and/or unreasonable restraints of trade relating to the particular commodities or services purchased or acquired by the State of West Virginia. Such assignment shall be made and become effective at the time the purchasing agency tenders the initial payment to the bidder.

I certify that this bid is made without prior understanding, agreement, or connection with any corporation, firm, limited liability company, partnership, or person or entity submitting a bid for the same material, supplies, equipment or services and is in all respects fair and without collusion or Fraud. I further certify that I am authorized to sign the certification on behalf of the bidder or this bid.

### INSTRUCTIONS TO BIDDERS

1. Use the quotation forms provided by the Purchasing Division. Complete all sections of the quotation form.
2. Items offered must be in compliance with the specifications. Any deviation from the specifications must be clearly indicated by the bidder. Alternates offered by the bidder as **EQUAL** to the specifications must be clearly defined. A bidder offering an alternate should attach complete specifications and literature to the bid. The Purchasing Division may waive minor deviations to specifications.
3. Unit prices shall prevail in case of discrepancy. All quotations are considered F.O.B. destination unless alternate shipping terms are clearly identified in the quotation.
4. All quotations must be delivered by the bidder to the office listed below prior to the date and time of the bid opening. Failure of the bidder to deliver the quotations on time will result in bid disqualifications: Department of Administration, Purchasing Division, 2019 Washington Street East, P.O. Box 50130, Charleston, WV 25305-0130
5. Communication during the solicitation, bid, evaluation or award periods, except through the Purchasing Division, is strictly prohibited (W.Va. C.S.R. §148-1-6.6).



## ADDENDUM NO. 1

7011EC22A

4 WHEEL DRIVE, RUBBER TIRED, ENDLOADER

## CHANGES TO BIDDER'S EVALUATION REPORT:

FROM:

X8.16.1 Transmission is to have high/low, forward and reverse with a ground speed of minimum of 23 mph.   Y  N

TO:

X8.16.1 Is transmission fully hydrostatic with one (1) engine driven pump and two (2) drive motors (hi/low speed) with dynamic breaking inching pedals and control panel for speed control   X   YES   NO



State of West Virginia  
 Department of Administration  
 Purchasing Division  
 2019 Washington Street East  
 Post Office Box 50130  
 Charleston, WV 25305-0130

# Request for Quotation

RFQ NUMBER
7011EC22A

PAGE
1

ADDRESS CORRESPONDENCE TO ATTENTION OF:
PAUL REYNOLDS 304-558-0468

VENDOR

\*709034551 02 304-842-3511  
 RISH EQUIPMENT COMPANY  
 PO BOX 906  
 BRIDGEPORT WV 26330

SHIP TO

DIVISION OF HIGHWAYS  
 EQUIPMENT DIVISION  
 ROUTE 33  
 BRUSHY FORK ROAD  
 BUCKHANNON, WV  
 26201 304-472-1750

DATE PRINTED	TERMS OF SALE	SHIP VIA	F.O.B.	FREIGHT TERMS
10/14/2011				

BID OPENING DATE: 10/26/2011 BID OPENING TIME 01:30PM

LINE	QUANTITY	UOP	CAT. NO.	ITEM NUMBER	UNIT PRICE	AMOUNT
ADDENDUM NO. 1						
BID OPENING DATE CHANGED						
FROM: 10/19/11 @1:30 P.M.						
TO: 10/26/11 @1:30 P.M.						
NO OTHER CHANGES						
0001	1	EA		760-47	\$99,544. <sup>00</sup>	\$99,544. <sup>00</sup>
				4 WHEEL DRIVE RUBBER TIRED ENDLOADER		
***** THIS IS THE END OF RFQ 7011EC22A ***** TOTAL:						\$99,544. <sup>00</sup>

SEE REVERSE SIDE FOR TERMS AND CONDITIONS

SIGNATURE	TELEPHONE	DATE
<i>Paul Calvert</i>	304-842-3511	10-26-2011
TITLE	FEIN	ADDRESS CHANGES TO BE NOTED ABOVE
GENERAL MANAGER	54-139-0408-004	

WHEN RESPONDING TO RFQ, INSERT NAME AND ADDRESS IN SPACE ABOVE LABELED 'VENDOR'

**GENERAL TERMS & CONDITIONS**  
**REQUEST FOR QUOTATION (RFQ) AND REQUEST FOR PROPOSAL (RFP)**

1. Awards will be made in the best interest of the State of West Virginia.
2. The State may accept or reject in part, or in whole, any bid.
3. Prior to any award, the apparent successful vendor must be properly registered with the Purchasing Division and have paid the required \$125 fee.
4. All services performed or goods delivered under State Purchase Order/Contracts are to be continued for the term of the Purchase Order/Contracts, contingent upon funds being appropriated by the Legislature or otherwise being made available. In the event funds are not appropriated or otherwise available for these services or goods this Purchase Order/Contract becomes void and of no effect after June 30.
5. Payment may only be made after the delivery and acceptance of goods or services.
6. Interest may be paid for late payment in accordance with the *West Virginia Code*.
7. Vendor preference will be granted upon written request in accordance with the *West Virginia Code*.
8. The State of West Virginia is exempt from federal and state taxes and will not pay or reimburse such taxes.
9. The Director of Purchasing may cancel any Purchase Order/Contract upon 30 days written notice to the seller.
10. The laws of the State of West Virginia and the *Legislative Rules* of the Purchasing Division shall govern the purchasing process.
11. Any reference to automatic renewal is hereby deleted. The Contract may be renewed only upon mutual written agreement of the parties.
12. **BANKRUPTCY:** In the event the vendor/contractor files for bankruptcy protection, the State may deem this contract null and void, and terminate such contract without further order.
13. **HIPAA BUSINESS ASSOCIATE ADDENDUM:** The West Virginia State Government HIPAA Business Associate Addendum (BAA), approved by the Attorney General, is available online at [www.state.wv.us/admin/purchase/vrc/hipaa.htm](http://www.state.wv.us/admin/purchase/vrc/hipaa.htm) and is hereby made part of the agreement. Provided that the Agency meets the definition of a Cover Entity (45 CFR §160.103) and will be disclosing Protected Health Information (45 CFR §160.103) to the vendor.
14. **CONFIDENTIALITY:** The vendor agrees that he or she will not disclose to anyone, directly or indirectly, any such personally identifiable information or other confidential information gained from the agency, unless the individual who is the subject of the information consents to the disclosure in writing or the disclosure is made pursuant to the agency's policies, procedures, and rules. Vendor further agrees to comply with the Confidentiality Policies and Information Security Accountability Requirements, set forth in <http://www.state.wv.us/admin/purchase/privacy/noticeConfidentiality.pdf>.
15. **LICENSING:** Vendors must be licensed and in good standing in accordance with any and all state and local laws and requirements by any state or local agency of West Virginia, including, but not limited to, the West Virginia Secretary of State's Office, the West Virginia Tax Department, and the West Virginia Insurance Commission. The vendor must provide all necessary releases to obtain information to enable the director or spending unit to verify that the vendor is licensed and in good standing with the above entities.
16. **ANTITRUST:** In submitting a bid to any agency for the State of West Virginia, the bidder offers and agrees that if the bid is accepted the bidder will convey, sell, assign or transfer to the State of West Virginia all rights, title and interest in and to all causes of action it may now or hereafter acquire under the antitrust laws of the United States and the State of West Virginia for price fixing and/or unreasonable restraints of trade relating to the particular commodities or services purchased or acquired by the State of West Virginia. Such assignment shall be made and become effective at the time the purchasing agency tenders the initial payment to the bidder.

I certify that this bid is made without prior understanding, agreement, or connection with any corporation, firm, limited liability company, partnership, or person or entity submitting a bid for the same material, supplies, equipment or services and is in all respects fair and without collusion or Fraud. I further certify that I am authorized to sign the certification on behalf of the bidder or this bid.

**INSTRUCTIONS TO BIDDERS**

1. Use the quotation forms provided by the Purchasing Division. Complete all sections of the quotation form.
2. Items offered must be in compliance with the specifications. Any deviation from the specifications must be clearly indicated by the bidder. Alternates offered by the bidder as **EQUAL** to the specifications must be clearly defined. A bidder offering an alternate should attach complete specifications and literature to the bid. The Purchasing Division may waive minor deviations to specifications.
3. Unit prices shall prevail in case of discrepancy. All quotations are considered F.O.B. destination unless alternate shipping terms are clearly identified in the quotation.
4. All quotations must be delivered by the bidder to the office listed below prior to the date and time of the bid opening. Failure of the bidder to deliver the quotations on time will result in bid disqualifications: Department of Administration, Purchasing Division, 2019 Washington Street East, P.O. Box 50130, Charleston, WV 25305-0130
5. Communication during the solicitation, bid, evaluation or award periods, except through the Purchasing Division, is strictly prohibited (W.Va. C.S.R. §148-1-6.6).

EXHIBIT 10

REQUISITION NO. 7011EC22A

ADDENDUM ACKNOWLEDGEMENT

I HEREBY ACKNOWLEDGE RECEIPT OF THE FOLLOWING CHECKED ADDENDUM(S) AND HAVE MADE THE NECESSARY REVISIONS TO MY PROPOSAL, PLANS AND/OR SPECIFICATION, ETC.

ADDENDUM NO.'S:

NO. 1  .....

NO. 2  .....

NO. 3 .....

NO. 4 .....

NO. 5 .....

I UNDERSTAND THAT FAILURE TO CONFIRM THE RECEIPT OF THE ADDENDUM(S) MAY BE CAUSE FOR REJECTION OF BIDS. VENDOR MUST CLEARLY UNDERSTAND THAT ANY VERBAL REPRESENTATION MADE OR ASSUMED TO BE MADE DURING ANY ORAL DISCUSSION HELD BETWEEN VENDOR'S REPRESENTATIVES AND ANY STATE PERSONNEL IS NOT BINDING. ONLY THE INFORMATION ISSUED IN WRITING AND ADDED TO THE SPECIFICATIONS BY AN OFFICIAL ADDENDUM IS BINDING.

*Paul Cabut*  
.....  
SIGNATURE

*RFSH EQUIPMENT COMPANY*  
.....  
COMPANY

*10/26/2011*  
.....  
DATE

# State of West Virginia VENDOR PREFERENCE CERTIFICATE

Certification and application\* is hereby made for Preference in accordance with *West Virginia Code*, §5A-3-37. (Does not apply to construction contracts). *West Virginia Code*, §5A-3-37, provides an opportunity for qualifying vendors to request (at the time of bid) preference for their residency status. Such preference is an evaluation method only and will be applied only to the cost bid in accordance with the *West Virginia Code*. This certificate for application is to be used to request such preference. The Purchasing Division will make the determination of the Resident Vendor Preference, if applicable.

1. Application is made for 2.5% resident vendor preference for the reason checked:  
 Bidder is an individual resident vendor and has resided continuously in West Virginia for four (4) years immediately preceding the date of this certification; or,  
 Bidder is a partnership, association or corporation resident vendor and has maintained its headquarters or principal place of business continuously in West Virginia for four (4) years immediately preceding the date of this certification; or 80% of the ownership interest of Bidder is held by another individual, partnership, association or corporation resident vendor who has maintained its headquarters or principal place of business continuously in West Virginia for four (4) years immediately preceding the date of this certification; or,  
 Bidder is a nonresident vendor which has an affiliate or subsidiary which employs a minimum of one hundred state residents and which has maintained its headquarters or principal place of business within West Virginia continuously for the four (4) years immediately preceding the date of this certification; or,
2. Application is made for 2.5% resident vendor preference for the reason checked:  
 Bidder is a resident vendor who certifies that, during the life of the contract, on average at least 75% of the employees working on the project being bid are residents of West Virginia who have resided in the state continuously for the two years immediately preceding submission of this bid; or,
3. Application is made for 2.5% resident vendor preference for the reason checked:  
 Bidder is a nonresident vendor employing a minimum of one hundred state residents or is a nonresident vendor with an affiliate or subsidiary which maintains its headquarters or principal place of business within West Virginia employing a minimum of one hundred state residents who certifies that, during the life of the contract, on average at least 75% of the employees or Bidder's affiliate's or subsidiary's employees are residents of West Virginia who have resided in the state continuously for the two years immediately preceding submission of this bid; or,
4. Application is made for 5% resident vendor preference for the reason checked:  
 Bidder meets either the requirement of both subdivisions (1) and (2) or subdivision (1) and (3) as stated above; or,
5. Application is made for 3.5% resident vendor preference who is a veteran for the reason checked:  
 Bidder is an individual resident vendor who is a veteran of the United States armed forces, the reserves or the National Guard and has resided in West Virginia continuously for the four years immediately preceding the date on which the bid is submitted; or,
6. Application is made for 3.5% resident vendor preference who is a veteran for the reason checked:  
 Bidder is a resident vendor who is a veteran of the United States armed forces, the reserves or the National Guard, if, for purposes of producing or distributing the commodities or completing the project which is the subject of the vendor's bid and continuously over the entire term of the project, on average at least seventy-five percent of the vendor's employees are residents of West Virginia who have resided in the state continuously for the two immediately preceding years.

Bidder understands if the Secretary of Revenue determines that a Bidder receiving preference has failed to continue to meet the requirements for such preference, the Secretary may order the Director of Purchasing to: (a) reject the bid; or (b) assess a penalty against such Bidder in an amount not to exceed 5% of the bid amount and that such penalty will be paid to the contracting agency or deducted from any unpaid balance on the contract or purchase order.

By submission of this certificate, Bidder agrees to disclose any reasonably requested information to the Purchasing Division and authorizes the Department of Revenue to disclose to the Director of Purchasing appropriate information verifying that Bidder has paid the required business taxes, provided that such information does not contain the amounts of taxes paid nor any other information deemed by the Tax Commissioner to be confidential.

Under penalty of law for false swearing (*West Virginia Code*, §61-5-3), Bidder hereby certifies that this certificate is true and accurate in all respects; and that if a contract is issued to Bidder and if anything contained within this certificate changes during the term of the contract, Bidder will notify the Purchasing Division in writing immediately.

Bidder: RISH EQUIPMENT COMPANY Signed: Paul Cabnet  
 Date: OCTOBER 26, 2011 Title: GENERAL MANAGER

\*Check any combination of preference consideration(s) indicated above, which you are entitled to receive.

RFQ No. 7011EC22A

STATE OF WEST VIRGINIA  
Purchasing Division

**PURCHASING AFFIDAVIT**

West Virginia Code §5A-3-10a states: No contract or renewal of any contract may be awarded by the state or any of its political subdivisions to any vendor or prospective vendor when the vendor or prospective vendor or a related party to the vendor or prospective vendor is a debtor and the debt owned is an amount greater than one thousand dollars in the aggregate

**DEFINITIONS:**

"Debt" means any assessment, premium, penalty, fine, tax or other amount of money owed to the state or any of its political subdivisions because of a judgment, fine, permit violation, license assessment, defaulted workers' compensation premium, penalty or other assessment presently delinquent or due and required to be paid to the state or any of its political subdivisions, including any interest or additional penalties accrued thereon.

"Debtor" means any individual, corporation, partnership, association, Limited Liability Company or any other form or business association owing a debt to the state or any of its political subdivisions. "Political subdivision" means any county commission; municipality; county board of education; any instrumentality established by a county or municipality; any separate corporation or instrumentality established by one or more counties or municipalities, as permitted by law; or any public body charged by law with the performance of a government function or whose jurisdiction is coextensive with one or more counties or municipalities. "Related party" means a party, whether an individual, corporation, partnership, association, limited liability company or any other form or business association or other entity whatsoever, related to any vendor by blood, marriage, ownership or contract through which the party has a relationship of ownership or other interest with the vendor so that the party will actually or by effect receive or control a portion of the benefit, profit or other consideration from performance of a vendor contract with the party receiving an amount that meets or exceed five percent of the total contract amount.

EXCEPTION: The prohibition of this section does not apply where a vendor has contested any tax administered pursuant to chapter eleven of this code, workers' compensation premium, permit fee or environmental fee or assessment and the matter has not become final or where the vendor has entered into a payment plan or agreement and the vendor is not in default of any of the provisions of such plan or agreement.

Under penalty of law for false swearing (West Virginia Code §61-5-3), it is hereby certified that the vendor affirms and acknowledges the information in this affidavit and is in compliance with the requirements as stated.

**WITNESS THE FOLLOWING SIGNATURE**

Vendor's Name: RESH EQUIPMENT COMPANY

Authorized Signature: Paul Cahunt Date: OCTOBER 26, 2011

State of West Virginia

County of Harrison to-wit:

Taken, subscribed, and sworn to before me this 25 day of October 20 11

My Commission expires August 25, 20 19

AFFIX SEAL HERE

NOTARY PUBLIC Christine Lynn Davis

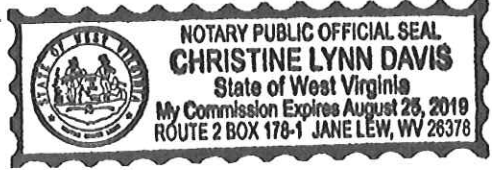

Please use this document for technical questions, posing in a question format

Please refer to the section your question is in reference to.

Technical questions for RFQ# 7011EC22A

Vendor Name: RISH EQUIPMENT COMPANY

Questions:

SECTION: 8.8 ENGINE

8.8.1 - STATES: ENGINE TO BE A MINIMUM POWER RATING OF 98HP

ARE YOU ASKING FOR A GROSS HP RATING OR A NET HP RATING?

---

---

---

---

---

---

---

---



## KOMATSU PRODUCT WARRANTY

This product warranty certificate and the product warranty stated herein are applicable to all Komatsu products marketed under the brand name of Komatsu by Komatsu America Corp., herein after referred to as "Company".

### 1. GENERAL PROVISIONS

We warrant that all new whole machines and attachments ("Machines"), and new parts and assemblies for the Machines, including engines ("Parts") sold by the Company will be free from defects in materials and workmanship for the respective periods specified in paragraph 2 below, subject to the other terms and conditions herein.

### 2. BASIC WARRANTY

- A. The Basic Warranty Period for the Machine shall terminate upon the expiration of **TWO (2) YEARS** after delivery of the Machine to the initial user regardless of the hours.
- B. The Basic Warranty Period for Parts shall be as follows:
- For all replacement Parts furnished pursuant to this warranty, upon expiration of the remainder of the warranty period applicable to the Machine in which such Parts are installed.
  - Other replacement Parts (Parts *not* furnished during the machine warranty period) may be covered under a separate warranty policy. Please consult your local Komatsu distributor.

### 3. COMPANY RESPONSIBILITIES

If a defect in material or workmanship is found during the Basic Warranty Period, the Company will, during normal working hours, at its option, repair or replace any part or component of the Machine or Part which fails to conform to the warranty during the Basic Warranty Period, provided our authorized Distributor is notified of such failure within the Basic Warranty Period.

### 4. CUSTOMER RESPONSIBILITIES

We recommend that you return the product to the Distributor from which it was purchased; however, you may also take it to the most convenient Company authorized Distributor contracted to service products of the type you have purchased. We do not assume the responsibility or cost of transporting the product to and/or from the servicing Distributor. You must also make the product available for repair during the Basic Warranty Period.

### 5. OTHER ENGINE MANUFACTURERS' WARRANTY

The above stated warranty does not apply to engines bearing other manufacturers' trademarks, whether or not such engines are installed in Machines or sold separately. The warranty responsibility on those engines rest with the respective engine manufacturers. Your Komatsu Distributor may be certified to perform warranty service on other manufacturers' engines.

### 6. LIMITATIONS

The Company shall not have any obligation under this warranty for:

- Any defects caused by misuse, misapplication, negligence, accident, improper storage, improper transportation, improper assembly or failure to maintain or use in accordance with the most current operating instructions including, but not limited to, loading the Machine in excess of the Gross Vehicle Weight as set out in the Company's Operation & Maintenance Manual;
- Unauthorized alterations;
- Defects or failures caused by any attachment or parts not manufactured or approved by the Company;
- Failure to conduct normal maintenance and operating services, including without limitation, providing lubricants, coolants, fuel, tune-ups, inspection or adjustments;
- Unreasonable delay (as established by Company) in making the applicable Machines or Parts available upon notification of a Factory Campaign ordered by the Company.

### 7. ITEMS NOT COVERED

The Company is not responsible for the following:

- Premiums charged for overtime labor requested by the purchaser;
- Charges related to transporting the product to and from the place at which warranty work is performed;
- Freight charges related to transporting repair parts to the place at which warranty work is performed;
- All used goods of any kind;
- Tires, tubes, wiper blades, belts, filters, cables, bulbs, condensers, spark plugs, glow plugs, fuses or carbon brushes, other consumable items, and normal wear of Machine or Parts;
- Attachments not manufactured or approved by the Company. (Trademarked attachments are warranted by their respective manufacturers.)

### 8. USE OF NON-OEM PARTS IN CRITICAL SYSTEMS

For safety reasons, the Company strongly recommends against the use of non-OEM replacement parts in critical systems of all Komatsu equipment. Critical systems include but are not limited to steering, braking and operator safety systems. Replacement parts manufactured and supplied by unauthorized sources may not be designed, manufactured or assembled to Komatsu's design specifications; accordingly, use of such parts may compromise the safe operation of Komatsu products and place the operator and others in danger should the part fail. Komatsu is also aware of repair companies that will rework or modify an OEM part for reuse in critical systems. Komatsu does not generally authorize such repairs or modifications for the same reasons as noted above. Use of non-OEM parts places full responsibility for the safe performance of the Komatsu product on the supplier and user. Komatsu will not in any case accept responsibility for the failure or performance of non-OEM parts in its products, including any damages or personal injury resulting from such use.

The foregoing warranty is exclusive and in lieu of all other express, statutory and implied warranties applicable to Machines, Engines, or Parts including without limitation, ALL IMPLIED WARRANTIES OF MERCHANTABILITY OR FITNESS FOR ANY PARTICULAR USE OR PURPOSE.

IN NO EVENT, WHETHER AS A RESULT OF BREACH OF CONTRACT OR WARRANTY, NEGLIGENCE, LIABILITY WITHOUT FAULT OR OTHER LEGAL THEORIES, SHALL THE COMPANY, OR ITS AFFILIATES, PARTNERS OR SUBSIDIARIES BE LIABLE FOR INDIRECT, SPECIAL, INCIDENTAL OR CONSEQUENTIAL DAMAGES, INCLUDING, WITHOUT LIMITATION, LOSS OF PROFIT OR REVENUES, LOSS OF USE OF THE MACHINE OR PARTS OR ANY ASSOCIATED EQUIPMENT, COST OF CAPITAL, COST OF SUBSTITUTE EQUIPMENT, FACILITIES OR SERVICES, DOWNTIME COSTS, LABOR COSTS, OR CLAIMS OF CUSTOMERS, PURCHASERS OR LESSEES FOR SUCH DAMAGES. THE REMEDIES HEREIN ARE THE EXCLUSIVE REMEDIES WITH RESPECT TO MACHINES AND PARTS, WHETHER UNDER THIS WARRANTY OR OTHERWISE.



## EMISSION CONTROL WARRANTY

### A. FEDERAL EMISSION CONTROL WARRANTY STATEMENT (APPLICABLE IN UNITED STATES and CANADA)

#### 1. Products Warranted

Komatsu America Corp. ("Komatsu") produces and/or markets products under the brand name of Komatsu. This emissions warranty applies to new engines bearing the Komatsu name installed in these products and used in the United States and Canada in machines designed for industrial off-highway use.

#### 2. Coverage

Komatsu warrants to the ultimate purchaser and each subsequent purchaser that the engine is designed, built and equipped so as to conform, at the time of sale by Komatsu, with all U.S. and Canadian Federal emission regulations applicable at the time of manufacture and that it is free from defects in workmanship or material which would cause it not to meet these regulations within five (5) years or 3,000 hours of operation, whichever occurs first, as measured from the date of delivery of the engine to the ultimate purchaser. If the machine in which the engine is installed is first placed in service in the state of California, a separate California Emission Warranty also applies.

#### 3. Limitations

Failures, other than those resulting from defects in materials or workmanship, are not covered by this warranty. Komatsu is not responsible for failures or damage resulting from what Komatsu determines to be abuse or neglect, including, but not limited to: operation without adequate coolant or lubricants; over fueling; over speeding; lack of maintenance of lubricating, cooling or intake systems; improper storage, starting, warm-up, run-in or shutdown practices; unauthorized modifications of the engine. Komatsu is also not responsible for failures caused by incorrect fuel or by water, dirt or other contaminants in the fuel. Komatsu is not responsible for non-engine repairs, "downtime" expense, related damage, fines, all business costs or other losses resulting from a warrantable failure.

**KOMATSU IS NOT RESPONSIBLE FOR INCIDENTAL OR CONSEQUENTIAL DAMAGES**

### B. CALIFORNIA EMISSION CONTROL WARRANTY STATEMENT

#### 1. Products Warranted

This Emission Control System Warranty applies to heavy-duty off-road diesel engines certified with the California Air Resources Board, marketed by Komatsu America Corp. (Komatsu) in their Komatsu products and first placed in service in California for use in industrial off-highway applications.

#### 2. Your Warranty Rights and Obligations

The California Air Resources Board and Komatsu are pleased to explain the emission control system warranty on your emissionized engine. In California, new heavy-duty off-road diesel engines must be designed, built and equipped to meet the State's stringent anti-smog standards. Komatsu must warrant the emission control system on your engine for the periods of time listed below provided there has been no abuse, neglect or improper maintenance of your engine. Your emission control system may include parts such as the fuel injection system and air induction system. Also included may be hoses, belts, connectors and other emission-related assemblies. Where a warrantable condition exists, Komatsu will repair your heavy-duty off-road diesel engine at no cost to you including diagnosis, parts and labor.

#### 3. Manufacturer's Warranty Coverage

The heavy-duty off-road diesel engines are warranted for five (5) years or 3,000 hours of engine operation, whichever occurs first, from the date of delivery of the engine to the first user. If any emission-related part on your engine is defective, the part will be repaired or replaced by Komatsu.

#### 4. Owner's Warranty Responsibilities

As a heavy-duty off-road diesel engine owner, you are responsible for the performance of the required maintenance listed in the Operation and Maintenance Manual. Komatsu recommends that you retain all receipts covering maintenance on your heavy-duty off-road diesel engine, but Komatsu cannot deny warranty solely for the lack of receipts or for your failure to ensure the performance of all scheduled maintenance.

You are responsible for presenting your heavy-duty off-road diesel engine to an authorized Komatsu Distributor as soon as a problem exists. The warranty repairs should be completed by the dealer as expeditiously as possible.

As the heavy-duty off-road diesel engine owner, you should also be aware that Komatsu may deny you warranty coverage if your heavy-duty off-road diesel engine or a part has failed due to abuse, neglect, improper maintenance or unapproved modifications. Your engine is designed to operate on diesel fuel only. Use of any other fuel may result in your engine no longer operating in compliance with California's emissions requirements. If you have any questions regarding your warranty rights and responsibilities, you should contact:

Komatsu America Corp.  
 Manager, Warranty Administration  
 One Continental Towers  
 1701 W. Golf Rd.  
 Rolling Meadows, IL 60008  
 (847) 437-5800

Prior to the expiration of the applicable warranty, owner must give notice of any warranted emission control failure to an authorized Komatsu Distributor and deliver the engine to such facility for repair. Owner is responsible for incidental costs such as: communication expenses, meals, lodging incurred by owner or employees of owner as a result of a warrantable failure.

KOMATSU IS NOT RESPONSIBLE FOR INCIDENTAL OR CONSEQUENTIAL DAMAGES WHICH INCLUDE, BUT ARE NOT LIMITED TO, BUSINESS LOSSES AND COSTS, "DOWNTIME" EXPENSES, FINES, PENALTIES, THEFT, VANDALISM OR COLLISION DAMAGE.

**5. Coverage: This emission control system warranty applies to the following emission control parts, if equipped:**

<b>Fuel Pump</b>	<b>Turbocharger</b>	<b>Injectors</b>	<b>Intake Manifold</b>
AFC Spring	Compressor Wheel	Calibration	Charge Air Cooler
AFC Setting	Turbine Wheel	Needle	Aftercooler
Static Timing	Turbine Oil Seal	Nozzle	Positive Crankcase Ventilation
Delivery Valve	Wastegate Valve	Spring	
Fuel Lines			<b>Other Emission Parts</b>
Control Module	<b>Exhaust Manifold</b>		Hoses
	<b>Exhaust Gas Recirculation Valve</b>		Connectors
	<b>Replacement Parts</b>		

Komatsu recommends that any service parts used for maintenance, repair or replacement of emission control systems be new, genuine Komatsu or Komatsu approved rebuilt parts and assemblies, and that the engine be serviced by an authorized Distributor. The owner may elect to have maintenance, replacement or repair of the emission control parts performed by a facility other than an authorized Distributor and may elect to use parts other than new genuine Komatsu or Komatsu approved rebuilt parts and assemblies for such maintenance, replacement or repair; however, the cost of such service or parts will not be covered under this emission control system warranty.

**6. Komatsu Responsibilities**

Repairs and service will be performed by any authorized Distributor using new, genuine Komatsu or Komatsu approved rebuilt parts and assemblies. Komatsu will repair any of the emission control parts found by Komatsu to be defective without charge for parts or labor (including diagnosis which results in determination that there has been a failure of a warranted emission control part).

**7. Warranty and Limitations**

The manufacturer warrants to the ultimate purchaser, and each subsequent purchaser, that the engine is designed, built, and equipped so as to conform with all applicable regulations adopted by the Air Resources Board, and that it is free from defects in material and workmanship which cause the failure of a warranted part for the time periods stated herein. Any warranted part which is not scheduled for replacement as required maintenance, or which is scheduled only for regular inspection to the effect of "repair or replace as necessary" is warranted for the warranty period. Any warranted part which is scheduled for replacement as required maintenance is warranted for the period of time prior to the first scheduled replacement point for that part. The owner will not be charged for diagnostic labor which leads to the determination that a warranted part is defective, if the diagnostic work is performed at an authorized Distributor. The manufacturer is liable for damages to other engine components caused by the failure under warranty of any warranted part. Komatsu is not responsible for failures resulting from improper repair or the use of parts which are not genuine Komatsu or Komatsu approved parts. Komatsu is not responsible for failures resulting from owner or operator abuse or neglect, such as: operation without adequate coolant, fuel or lubricants; over fueling; over speeding; lack of maintenance of lubricating, cooling or air intake systems; improper storage, starting, warm-up, run-in or shutdown practices.

**C. GENERAL EXCLUSIONS**

1. The foregoing engine emission control warranties do not apply to engines in our products, which bear trademarks or names other than Komatsu (i.e. Cummins). The emission control warranty responsibility of such engines shall rest with the respective engine manufacturer. For information on such warranties, please refer to the operator's manual for the engine in question or contact the applicable dealer organization. In the case of Cummins trademarked engines, you may also contact your Komatsu distributor who may be certified by Cummins, under its Certified Distributor Program.
2. These warranties, together with the express commercial warranties, are the sole warranties of Komatsu. **THERE ARE NO OTHER WARRANTIES, EXPRESS OR IMPLIED, OR OF MERCHANTABILITY OR FITNESS FOR ANY PARTICULAR PURPOSE.**



## CUSTOMER CONSENT - MACHINE MONITORING SYSTEMS

By signing the Agreement to Customer Consent - Machine Monitoring Systems (Agreement), Customer acknowledges and agrees to the following with respect to the machine(s) listed on the page on which it appears, as well as with respect to any other machines Customer owns, leases or otherwise uses that are equipped with Komatsu's KOMTRAX System (KOMTRAX), Vehicle Health and Monitoring System (VHMS) and/or Payload Meter (PLM). KOMTRAX, VHMS and PLM are collectively referred to as the "Systems". By signing the Agreement Customer also agrees to the Terms of Use of the Komtrax Service (Terms of Use), as set forth on the Komtrax website. The Terms of Use are available through <http://www.komtrax.us>, as may be updated from time to time by Komatsu to reflect any changes to KOMTRAX including the nature or quantity of data transmitted. By consenting to this Agreement, Customer is also consenting to any future updates to the Terms of Use.

Customer acknowledges that each machine is equipped with KOMTRAX. KOMTRAX is an equipment data tracking and monitoring system to manage information on utility, construction and mining machines. Such data may include details on machine location, usage and diagnostic information. In addition, KOMTRAX may be used to transmit messages and signals to the machine, including a signal that will disable the machine's ignition mechanisms.

Customer further acknowledges that each machine may be equipped with VHMS and/or PLM. VHMS is an equipment data tracking and monitoring system to manage information relating to machine usage, diagnostic and performance information, including, without limitation, items such as engine oil pressure, coolant temperature, fuel rate, engine speed, exhaust temperature and other machine and component information. PLM is a system which measures payload information during each haul truck haul cycle, including, without limitation, gross payload, maximum frame torque, and loading, dumping and driving times.

The information collected through the Systems is transmitted to Komatsu by means of automatic transmission, such as by satellite or other wireless means, and/or by means of manual download performed by Komatsu and/or its distributors and their respective personnel.

Customer consents to the collection, transmission and sharing of the information described above, and authorizes Komatsu America Corp. ("Komatsu"), its affiliates, subsidiaries and distributors to gather, process and use, without limitation, the information developed or collected by or in connection with the Systems. Customer acknowledges and agrees that all information developed or collected by or in connection with Systems shall be Komatsu's exclusive property, except for information provided by Customer, or on Customer's behalf, with respect to Customer's machines. Customer hereby grants to Komatsu a non-exclusive, worldwide, perpetual, irrevocable, royalty-free, sublicenseable right to exercise the copyright and other rights that Customer may have in any information collected by or in connection with the Systems for Komatsu, Komatsu affiliate, and Komatsu distributor business purposes, and for any other purposes, in any media now known or not currently known. This may include sharing of such information with select third parties and business partners.

Customer is responsible for performing any actions that are required by local law or regulation with respect to the collection and use of this information in the above manner, including, but not limited to, any required notification of employees or other parties of the collection and use of the information.

# KOMATSU®

## WA150-6

**NET HORSEPOWER**  
73 kW **98 HP** @ 2200 rpm

**OPERATING WEIGHT**  
7830 - 7915 kg  
**17,262 - 17,450 lb**

**BUCKET CAPACITY**  
1.3 - 1.7 m<sup>3</sup> **1.7 - 2.2 yd<sup>3</sup>**

**WA  
150**



**W  
H  
E  
E  
L  
L  
O  
A  
D  
E  
R**

Photo may include optional equipment.

**WA150-6 WHEEL LOADER**

# WALK-AROUND

## High Productivity & Low Fuel Consumption with Hydrostatic Transmission

- High performance SAA4D95LE-5 engine
- Low fuel consumption
- Electronically-controlled HST with variable shift control system
- Variable traction control system
- S-mode

## Excellent Operator Environment

- HST traction control switch
- Electronically controlled directional lever
- Tilttable steering column
- Low-noise designed cab
- Pillar-less large ROPS/FOPS Level 2 cab-integrated
- Easy entry/exit, rear-hinged doors



## Environmentally Friendly

- EPA Tier 3 and EU stage 3A emissions certified
- Low exterior noise
- Low fuel consumption

### **KOMTRAX**

KOMTRAX sends machine location, Service Meter Reading (SMR) and operation maps to a secure website utilizing wireless technology. Machines also relay error codes, cautions, maintenance items, fuel levels, and much more.

**Reliability**

- Reliable Komatsu designed and manufactured components
- Sturdy main frame
- Adjustment-free, fully hydraulic, wet disc service and parking brakes
- Hydraulic hoses use flat face O-ring seals
- Cathion electrodeposition process is used to apply primer paint
- Powder coating process is used to apply main structure paint
- Sealed DT electrical connectors

**NET HORSEPOWER**  
73 kW 98 HP @ 2200 rpm

**OPERATING WEIGHT**  
7830 - 7915 kg  
17,262 - 17,450 lb

**BUCKET CAPACITY**  
1.3 - 1.7 m<sup>3</sup> 1.7 - 2.2 yd<sup>3</sup>



Photo may include optional equipment.

**Maintenance Features**

- Equipment Management Monitoring System (EMMS)
- Easy access, gull-wing type engine side doors
- Automatic reversible fan
- KOMTRAX<sup>®</sup>

## WA150-6 WHEEL LOADER

# HIGH PRODUCTIVITY & LOW FUEL CONSUMPTION

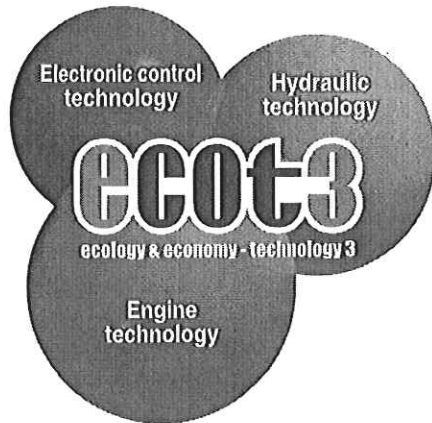

### High Performance SAA4D95LE-5 Engine

Electronic Heavy Duty Common Rail fuel injection system provides optimum combustion of fuel. This system also provides quick throttle response to match the machine's powerful tractive effort and quick hydraulic response.

**Net Power: 73 kW 98 HP**

### Low Emission Engine

This engine is EPA Tier 3 and EU Stage 3A emissions certified, without sacrificing power or machine productivity.

### Low Fuel Consumption

The high-torque engine and Hydrostatic Transmission (HST) with maximum efficiency in the low-speed range provide low fuel consumption.

### Eco Indicator

The eco indicator will help an operator achieve energy savings.



## Hydrostatic Transmission (HST)

### Electronically-Controlled HST Using a 1-Pump, 2-Motor System

- The 1-pump, 2-motor system allows high-efficiency and high tractive effort. Engine power is transmitted hydraulically to a transfer case, then mechanically out to the differentials and the four driving wheels.
- HST provides quick travel response and aggressive drive into the pile. The variable displacement system automatically adjusts to the tractive effort demand to provide maximum power and efficiency.
- Full auto-shifting eliminates any gear shifting and kick-down operation to allow the operator to concentrate on digging and loading.
- When high drive torque is needed for digging, climbing, or initiating movement, the pump feeds both motors. This combination makes the loader very aggressive and quick.
- Under deceleration, the HST system acts as a dynamic brake on the mechanical drive system. The dynamic brake can hold the loader in position on most workable slopes. This can be an advantage in stockpiling and ramp loading.
- As the machine moves and gains ground speed, the torque demand decreases and the low speed motor is effectively removed from the drive system by a clutch. At this point, the flow is going to the high-speed motor and the low-speed motor is not causing drag on the system.
- An inching pedal gives the operator excellent simultaneous control of his travel and equipment hydraulic speeds. By depressing the inching pedal, drive pump flow to the motors will decrease, reducing ground speed and allowing the operator to use the accelerator to increase flow to the equipment hydraulics. Depressing the inching pedal further will activate the service brakes.

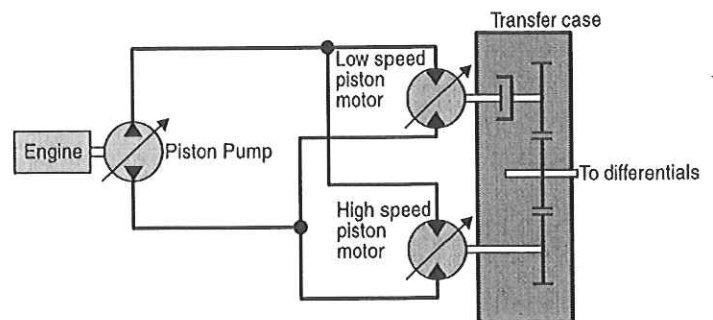

**Electronically-Controlled HST with Variable Shift Control System**

The operator can choose between first, second, third, or fourth maximum speeds by dialing the speed range selector switch. For V-cycles, the operator can set the speed control switch to 1 or 2, which

provides aggressive digging, quick response, and fast hydraulics. For load and carry, select 3 or 4 which still provides aggressive digging but with much faster travel speed.

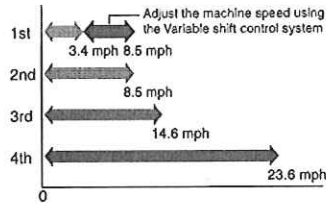

The variable shift control dial allows the operator to adjust machine speed in applications such as confined V-loading. When in 1, the operator can adjust travel speed using the variable shift control dial to match machine speed and hydraulics to the distance travelled. This feature is also useful when powering a broom or snowblower.

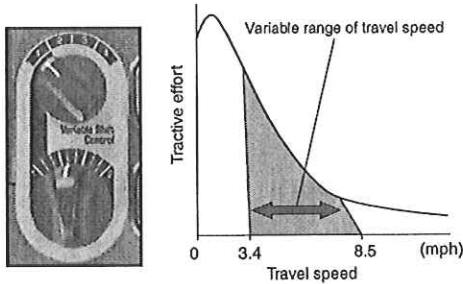

**Variable Traction Control System**

The tractive effort of the machine, when traveling at a low speed, can be reduced by using the traction control switch. Combined with torque proportioning differentials, or optional limited slip differentials this system provides the following benefits:

- Facilitates operation on soft ground where the tires of the machine are apt to slip.
- Eliminates excessive bucket penetration and reduces tire slippage during stockpile loading to improve the work efficiency.
- Reduces tire slippage to extend the life of tires.

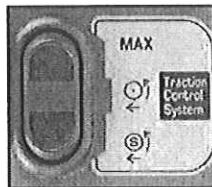
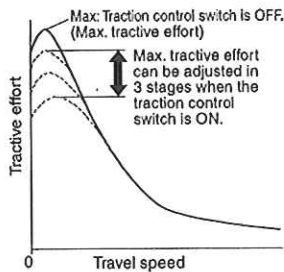

Furthermore, the maximum tractive effort can be adjusted in three stages (one stage for conventional machines) when the traction control switch is ON. This allows the operator to select the optimum tractive effort for diversified road conditions.

**S-mode**

Setting the switch to S-mode provides optimum driving force for operations on slippery road surfaces, like snow-removal on snow-covered surfaces, resulting in reduced tire slippage and facilitation of the operation.

Unexpected tire slippage on slippery road surfaces is suppressed by controlling the engine speed and HST motor when traveling at a low speed. (S-mode is effective only in forward travel.)

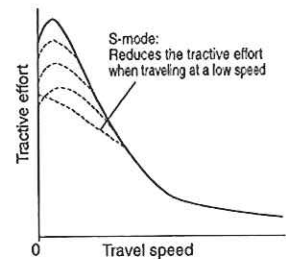

**Max. Traction Switch**

The max. traction switch is located on the work equipment control lever. When the traction control switch is at the ON position or S-mode is selected, pushing this switch cancels the setting of the traction control temporarily and increases the tractive effort to its 100% value. Then pushing the max. traction switch again or operating the F/R lever returns the tractive effort to the set value automatically. This switch is useful for operations such as stockpile work where large tractive effort is required temporarily.

**Accelerator Pedal Sensitive HST Control**

Finely-tuned HST control according to the accelerator pedal angle reduces shocks and allows smoother traveling and better energy-saving operation.



**Dumping Clearance and Reach**

The long lift arms provide high dumping clearance and long dumping reach. The operator can even level loads on the body of a dump truck easily and efficiently.

**Dumping Clearance: 2730 mm 8'11"**  
**Dumping Reach: 945 mm 3'1"**  
 (1.5 m<sup>3</sup> 2.0 yd<sup>3</sup> bucket with B.O.C.E.)



# WA150-6 WHEEL LOADER

## RELIABILITY

### Komatsu Components

Komatsu manufactures the engine, transfer case, axles, and hydraulic components on this wheel loader.

Komatsu loaders are manufactured with an integrated production system under a strict quality control system.

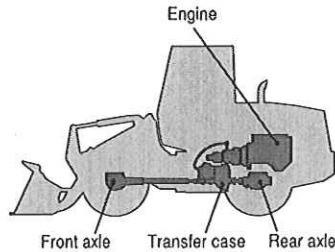

### Wet Multi-disc Brakes and Fully Hydraulic Braking System

This means low maintenance costs and high reliability. Wet disc brakes are fully sealed. Contaminants are kept out, providing low wear and maintenance. Brakes require no adjustments for wear. The parking brake is also an adjustment-free, wet multi-disc for high reliability and long life. Added reliability is designed into the braking system by the use of two independent hydraulic circuits, providing hydraulic backup. Fully hydraulic brakes mean no air system to bleed and no condensation of water in the system that can lead to contamination, corrosion, and freezing.

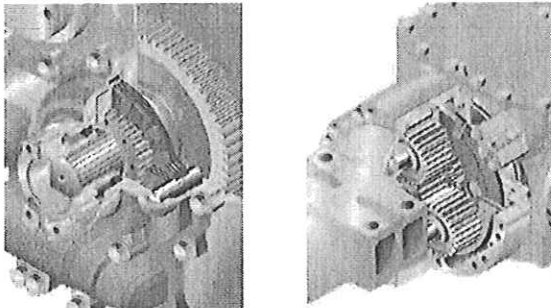

### Overrun Reduction System

When the machine descends a slope of six degrees or less, maximum travel speed is automatically restricted to approximately 43 km/h 27 mph, for protection against damage of power train components and brakes, by sensing the travel speed and controlling the discharge amount of the HST pump and motor. When the machine descends a steep slope and the travel speed reaches 40 km/h 25 mph, the caution lamp lights up to inform the operator to reduce the travel speed.

Note: When the machine descends a steep slope, the use of the service brake is necessary to limit travel speed.

### High-rigidity Frames and Loader Linkage

The front and rear frames and the loader linkage have torsional rigidity to provide resistance to stresses.

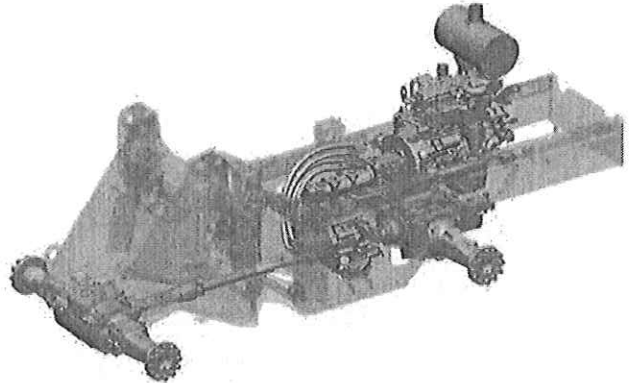

### Flat Face-to-Face O-Ring Seals

Flat face-to-face O-ring seals are used to securely seal hydraulic hose connections.

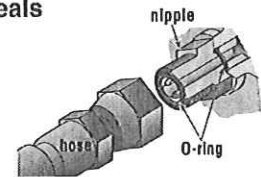

### Cathion Electrodeposition Primer Paint/ Powder Coating Final Paint

Cathion electrodeposition process is used to apply primer paint, and powder coating process is used to apply the topcoat to the exterior metal sheet parts. Some external parts are made of plastic providing long life and high impact resistance.

### Sealed DT Connectors

Main harnesses and controller connections are equipped with sealed DT connectors providing high reliability, water resistance, and dust resistance.



# MAINTENANCE FEATURES



Photo may include optional equipment.

## Equipment Management Monitoring System (EMMS)

The monitor is mounted in front of the operator for easy viewing, allowing the operator to easily check gauges and warning lights.



A specially designed two-spoke steering wheel allows the operator to easily see the instrument panel.

## Maintenance Control and Troubleshooting Functions

- **Action code display function:** If an abnormality occurs, the monitor displays action details on the character display at the center bottom of the monitor.
- **Monitor function:** The controller monitors engine oil pressure, coolant temperature, air cleaner clogging, etc. If the controller finds abnormalities, the error is displayed on the LCD.
- **Replacement time notice function:** The monitor informs replacement time of oil and filters on the LCD when replacement intervals are reached.
- **Trouble data memory function:** The monitor stores abnormality data for effective troubleshooting.

## Gull-wing Type Engine Side Doors Open Wide

The operator can open and close each gull-wing type engine side door easily, with the assistance of a gas spring, to perform daily service checks from the ground.

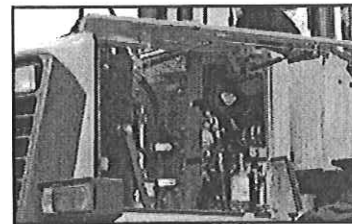

## Ease of Radiator Cleaning

If the machine is operating in adverse conditions, the operator can reverse the hydraulic cooling fan from inside the cab by pressing a switch on the control panel.

## Automatic Reversible Fan

The engine fan is driven hydraulically and can be operated in reverse automatically. When the switch is in the automatic position, the fan revolves in reverse intermittently for 2 minutes every 2 hours. (Default setting)



- B:** Manual Reverse Mode
- A:** Normal Rotation Mode
- C:** Auto Reverse Mode

# OPERATOR ENVIRONMENT

## Easy Operation

### Electronically Controlled Directional Lever

The operator can change machine direction with the touch of a finger, without removing their hand from the steering wheel. Solid state electronics makes this possible.



### Tiltable Steering Column

The operator can tilt the steering column to provide a comfortable working position.

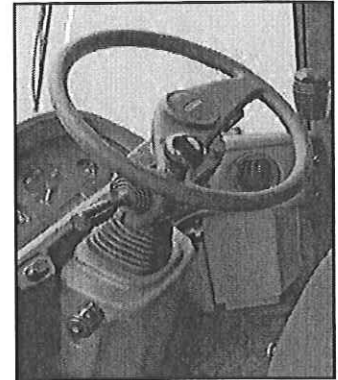

### Multi-function Loader Control Lever with Forward & Reverse Switch

A new multi-function control lever integrated with forward and reverse switch allows the operator to easily operate the work equipment, providing low operator fatigue and good controllability. The adjustable wrist rest provides the operator with a variety of comfortable operating positions.



### Right-side Control Panel

The operator can select the speed range, maximum travel speed in 1st, tractive effort, and reversible fan setting.

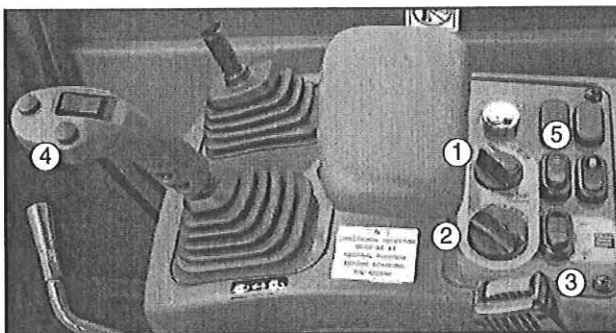

- 1: Speed range selector switch
- 2: Variable shift switch
- 3: Traction control switch
- 4: Max. traction switch
- 5: Fan reverse switch

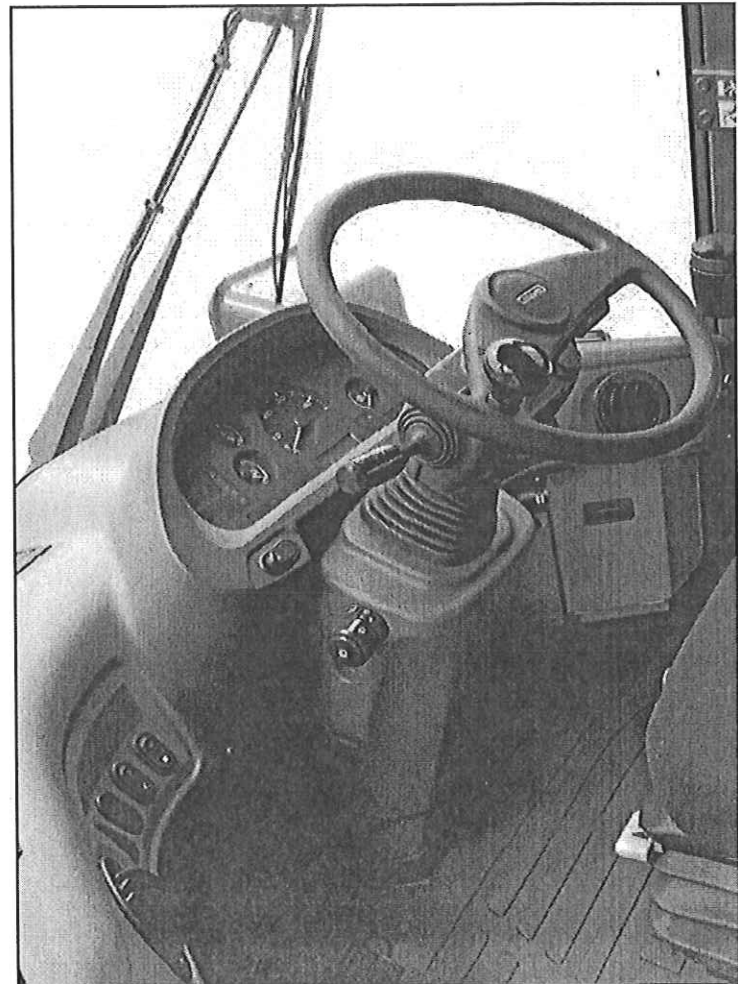

## Comfortable Operation

### Low-noise Design

Noise level at operator's ear: 72 dB(A)  
Dynamic noise level (outside): 104 dB(A)

The large cab is mounted with Komatsu's unique ROPS/FOPS viscous mounts. The low-noise engine, hydraulically driven fan, and hydraulic pumps are mounted with rubber cushions, and the cab sealing is improved to provide a quiet, low-vibration, pressurized, and comfortable operating environment.

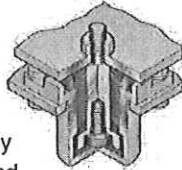

### Pillar-less Large Cab

A wide pillar-less flat glass provides excellent front visibility. The wiper arm covers a large area to provide great visibility even on rainy days. The large cab area provides maximum space

for the operator. The front mounted air conditioner was introduced to increase seat reclining and backward slide adjustment.

### Rear-hinged Full Open Cab Doors

The large cab doors are rear-hinged to open fully, offering easy entry/exit. Exit from the cab is easily accomplished by having steps in view of the operator. Sloped hand rails help guide the foot onto the first step.

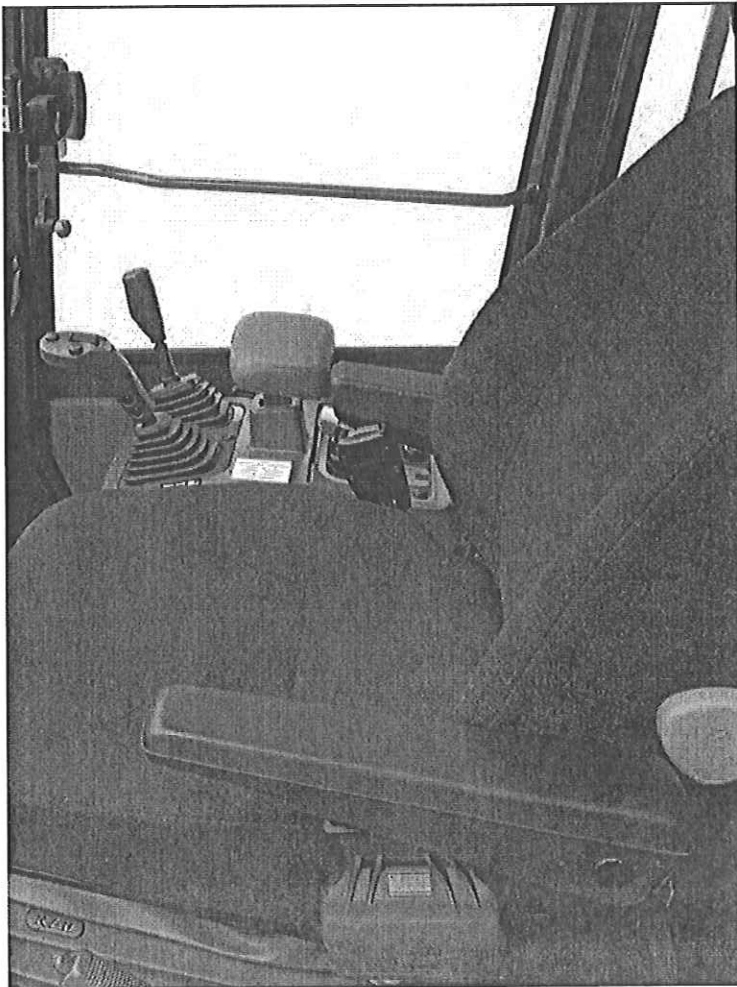

Photos may include optional equipment.

# WA150-6 WHEEL LOADER

## SPECIFICATIONS



### ENGINE

Model .....Komatsu SAA4D95LE-5\*  
 Type .....Water-cooled, 4-cycle  
 Aspiration .....Turbocharged, aftercooled  
 Number of cylinders .....4  
 Bore x stroke .....95 mm x 115 mm 3.74" x 4.53"  
 Piston displacement .....3.26 ltr 199 In<sup>3</sup>  
 Governor .....All-speed, electronic  
 Horsepower  
 SAE J1995 .....Gross 74 kW 99 HP  
 ISO 9249/SAE J1349 .....Net 73 kW 98 HP  
 Hydraulic fan at maximum speed .....Net 71 kW 95 HP  
 Rated rpm .....2200 rpm  
 Fan drive method for radiator cooling .....Hydraulic  
 Fuel system .....Direct injection  
 Lubrication system:  
 Method .....Gear pump, force-lubrication  
 Filter .....Full-flow type  
 Air cleaner .....Dry type with double elements and  
 dust evacuator, plus dust indicator

\*EPA Tier 3 and EU Stage 3A emissions certified.



### TRANSMISSION

Type .....Hydrostatic, 1 pump, 2 motors with speed range select  
 Travel speed: km/h mph  
 Measured with 17.5-25 tires

	1st	2nd	3rd	4th
Both Forward and Reverse	5.5 - 13.6	13.6	23.5	38.0
	3.4 - 8.5	8.5	14.6	23.6



### AXLES AND FINAL DRIVES

Drive system .....Four-wheel drive  
 Front .....Fixed, semi-floating  
 Rear .....Center-pin support, semi-floating,  
 16° total oscillation  
 Reduction gear .....Spiral bevel gear  
 Differential gear .....Torque proportioning  
 Final reduction gear .....Planetary gear, single reduction



### BRAKES

Service brakes .....Hydraulically actuated,  
 wet disc brakes actuate on four wheels  
 Parking brake .....Wet, multi-disc brake on transfer output shaft  
 Emergency brake .....Parking brake is commonly used



### STEERING SYSTEM

Type .....Full-hydraulic power steering  
 Steering angle .....40° each direction  
 Minimum turning radius at  
 the center of outside tire .....4675 mm 15'4"



### HYDRAULIC SYSTEM

Loader and steering pump:  
 Capacity .....108 ltr/min 28.5 U.S. gal/min at rated rpm  
 Steering system:  
 Hydraulic pump .....Gear type pump  
 Relief valve setting .....18.6 MPa 190 kgf/cm<sup>2</sup> 2,700 psi  
 Hydraulic cylinders:  
 Type .....Double-acting, piston type  
 Number of cylinders .....2  
 Bore x stroke .....55 mm x 375 mm 2.2" x 14.8"

Loader control:  
 Hydraulic pump .....Gear type pump  
 Relief valve setting .....20.6 MPa 210 kgf/cm<sup>2</sup> 3,000 psi  
 Hydraulic cylinders:  
 Type .....Double-acting, piston type  
 Number of cylinders—bore x stroke:  
 Boom cylinder .....2- 110 mm x 628 mm 4.3" x 24.7"  
 Bucket cylinder .....1- 110 mm x 452 mm 4.3" x 17.8"  
 Control valve .....2-spool type  
 Control positions:  
 Boom .....Raise, hold, lower, and float  
 Bucket .....Tilt-back, hold, and dump  
 Hydraulic cycle time (rated load in bucket)  
 Raise .....6.0 sec  
 Dump .....1.1 sec  
 Lower (Empty) .....3.6 sec



### SERVICE REFILL CAPACITIES

Cooling system	14.6 ltr	3.9 U.S. gal
Fuel tank	133.0 ltr	35.1 U.S. gal
Engine	11.5 ltr	3.0 U.S. gal
Hydraulic system	47.0 ltr	12.4 U.S. gal
Front axle	14.0 ltr	3.7 U.S. gal
Rear axle	14.5 ltr	3.8 U.S. gal
Transfer case	3.5 ltr	0.9 U.S. gal



### BUCKET SELECTION GUIDE

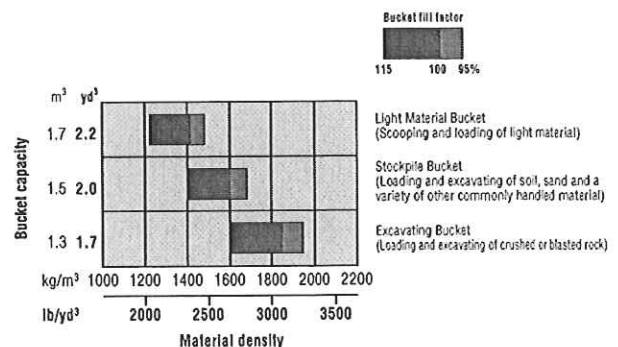



**DIMENSIONS**

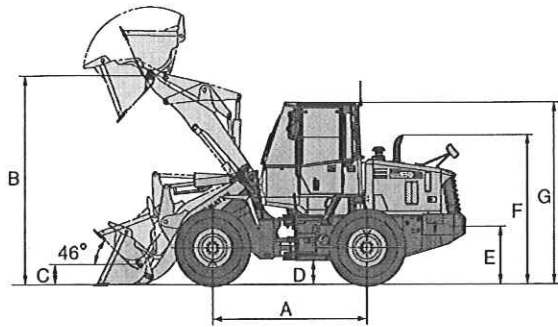

	15.5-25 tires		17.5-25 tires	
Tread	1780 mm	5'10"	1780 mm	5'10"
Width over tires	2180 mm	7'2"	2220 mm	7'3"
A Wheelbase	2600 mm	8'6"	2600 mm	8'6"
B Hinge pin height, max. height	3475 mm	11'5"	3510 mm	11'6"
C Hinge pin height, carry position	360 mm	1'2"	355 mm	1'2"
D Ground clearance	390 mm	1'3"	425 mm	1'5"
E Hitch height	790 mm	2'7"	825 mm	2'8"
F Overall height, top of the stack	2485 mm	8'2"	2520 mm	8'3"
G Overall height, ROPS cab	3025 mm	9'11"	3060 mm	10'0"

Measured with 17.5-25-12PR (L2) tires, ROPS/FOPS cab

	Stockpile Bucket	Excavating Bucket	Light Material Bucket
	Bolt-on Cutting Edges	Bolt-on Cutting Edges	Bolt-on Cutting Edges
Bucket capacity: heaped	1.5 m <sup>3</sup> 2.0 yd <sup>3</sup>	1.3 m <sup>3</sup> 1.7 yd <sup>3</sup>	1.7 m <sup>3</sup> 2.2 yd <sup>3</sup>
struck	1.25 m <sup>3</sup> 1.6 yd <sup>3</sup>	1.1 m <sup>3</sup> 1.4 yd <sup>3</sup>	1.5 m <sup>3</sup> 2.0 yd <sup>3</sup>
Bucket width	2390 mm 7'10"	2390 mm 7'10"	2390 mm 7'10"
Bucket weight	595 kg 1,310 lb	580 kg 1,280 lb	665 kg 1,470 lb
Dumping clearance, max. height and 45° dump angle (H) *	2730 mm 8'11"	2770 mm 9'1"	2655 mm 8'9"
Reach at max. height and 45° dump angle *	945 mm 3'1"	905 mm 3'0"	1020 mm 3'4"
Reach at 2130 mm (7') clearance and 45° dump angle *	1360 mm 4'6"	1340 mm 4'5"	1395 mm 4'7"
Reach with arm horizontal and bucket level *	2030 mm 6'8"	1970 mm 6'5"	2135 mm 7'0"
Operating height (fully raised)	4655 mm 15'3"	4685 mm 15'4"	4735 mm 15'6"
Overall length	6310 mm 20'8"	6250 mm 20'6"	6415 mm 21'1"
Loader clearance circle (bucket at carry, outside corner of bucket)	10755 mm 35'3"	10725 mm 35'2"	10810 mm 35'6"
Digging depth: 0°	65 mm 2.5"	65 mm 2.5"	65 mm 2.5"
10°	230 mm 9.0"	220 mm 8.6"	245 mm 9.6"
Static tipping load: straight	6745 kg 14,873 lb	6785 kg 14,963 lb	6650 kg 14,663 lb
40° full turn	5870 kg 12,939 lb	5905 kg 13,014 lb	5790 kg 12,769 lb
Breakout force	72.6 kN 7400 kgf 16,310 lb	78.6 kN 8010 kgf 17,660 lb	64.0 kN 6530 kgf 14,400 lb
Operating weight	7850 kg 17,311 lb	7835 kg 17,271 lb	7920 kg 17,461 lb

\* At the end of B.O.C.E.

All dimensions, weights, and performance values based on SAE J732c and J742b standards. Static tipping load and operating weight shown include lubricant, coolant, full fuel tank, ROPS cab, additional counterweight, and operator. Machine stability and operating weight affected by counterweight, tire size, and other attachments.

Apply the following weight changes to operating weight and static tipping load.



## WEIGHT AND DIMENSION CHANGES

	Change in Operating Weight		Change in Tipping Load				Change in Width Over Tires	Change in Ground Clearance		Change in Vertical Dimensions		Change in Reach		
			Straight		Full Turn									
15.5-25-8PR (L2) tires and rims	-140 kg	-309 lb	-100 kg	-221 lb	-90 kg	-198 lb	2180 mm	7'2"	390 mm	1'3"	-35 mm	-1.4"	15 mm	0.6"
Install ROPS canopy (instead of cab)	-150 kg	-331 lb	-160 kg	-353 lb	-150 kg	-331 lb								
Additional counterweight	200 kg	441 lb	380 kg	838 lb	330 kg	728 lb								



## STANDARD EQUIPMENT

- 2-spool valve for boom and bucket controls
- Air conditioner
- Alternator, 60 A
- Auto shift transmission with mode select system
- Back-up alarm
- Back-up lamp
- Batteries, 92 Ah/12 V x 2
- Boom kick-out
- Bucket positioner
- Counterweight, standard and additional
- Deluxe suspension seat
- Directional signal
- Engine, Komatsu SAA4D95LE-5 diesel
- Engine shut-off system, electric
- Floor mat
- Front fenders
- Fuel prefilter with water separator
- Hydraulic-driven fan with auto-reverse rotation
- KOMTRAX®
- Lift cylinders and bucket cylinder
- Loader linkage with standard lift boom
- Main monitor panel with Equipment Management Monitoring System (EMMS)
- Mono-lever loader control with transmission F/R switch
- Radiator mask, lattice type
- Rear defroster (electric)
- Rear view mirror, inside (1), outside (2)
- Rear window washer and wiper
- Rims for 17.5-25 tires
- ROPS/FOPS Level 2 cab
- Seat belt, 76 mm 3" retractable
- Service brakes, wet disc type
- Starting motor, 5.5 kW/24 V
- Steering wheel, tiltable
- Sun visor
- Transmission speed ranges, 4 forward and 4 reverse



## OPTIONAL EQUIPMENT

- 3-spool valve
- AM/FM stereo radio cassette
- Auxiliary steering (SAE)
- Cutting edge (bolt-on type)
- Electronically Controlled Suspension System (ECSS)
- Engine pre-cleaner with extension
- Limited slip differential (F&R)
- Rear full fenders
- ROPS canopy
- Rims for 15.5-25 tires

AESS795-01

©2009 Komatsu America Corp.

Printed in USA

D09(5M)C

03/09 (EV-1)

# KOMATSU®

www.KomatsuAmerica.com



Komatsu America Corp. is an authorized licensee of Komatsu Ltd. Materials and specifications are subject to change without notice. **KOMATSU** is a registered trademark of Komatsu Ltd., Japan. **KOMTRAX®** is a registered trademark of Komatsu America Corp.