



July 13, 2010

Via Federal Express

Ms. Roberta Wagner  
Department of Administration  
Purchasing Division, Bldg 15  
State of West Virginia  
2019 Washington Street, East  
Charleston, WV 25305

RECEIVED

2010 JUL 14 P 2: 52

PURCHASING DIVISION  
STATE OF WV

**Re: State of West Virginia RFQ Number LBS11009, Due Date: July 15, 2010 at 1:30pm**

Dear Ms. Wagner:

Thank you for the opportunity to respond to your bid RFQ Number LBS11009 for a LC/MS/MS Instrument. Please accept the attached bid package for the API 4000 Applied Markets System which includes the following:

- Cover letters
- Your completed bid forms
- HIPAA Statement
- List of States participating in the CDC-LRN Program with AB SCIEX instruments
- Quotation Number 20674667
- Product brochure

Please note that the prices set forth in Quote Number 20674667 are valid to September 4, 2010. Any resulting contract and/or purchase order shall be governed by the State's terms and conditions attached to your RFQ, collectively with the non-conflicting terms of the AB SCIEX General Terms and Conditions of Sale attached to Quote No. 20674667, to the extent allowed under the State of West Virginia law, as supplemented by your addendum (pg. 12) and attachment (pg. 13).

To clarify, under Section 13 of your General Terms and Conditions, HIPAA Business Associate Addendum, our understanding, for reasons set forth in the attached HIPAA statement, is the nature of services we will be providing under any resulting contract will not expose us to any protected information that would qualify us as a business associate under HIPAA.

Should you have any questions regarding our products and/or pricing, please contact Robert Christian at phone 434.295.9626 or at email [robert.christian@absciex.com](mailto:robert.christian@absciex.com). For any contractual issues, please contact me as provided below.

Thank you in advance for your time and consideration.

Sincerely,

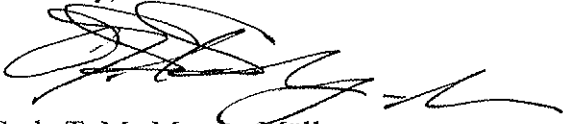

Carla T. Mc Murray-Müller  
Applied Biosystems LLC  
on behalf of AB Sciex  
Ph.650.554.2350  
Fax.650.638.5143  
[carla.mcmurray@lifetech.com](mailto:carla.mcmurray@lifetech.com)

*Enclosures*



### HIPAA Statement

AB Sciex takes privacy very seriously. AB Sciex is also committed to comply with all relevant federal and state regulations pertaining to privacy, including HIPAA. However, we believe that in the normal course of AB Sciex' businesses, AB Sciex and its employees are not "covered entities" under HIPAA. Neither is AB Sciex or its employees "business associates" of covered entities such as the Center for Molecular Medicine, since we neither perform functions on your behalf (such as utilization review or quality assurance) nor provide contracted services to you (such as legal, accounting or information technology support). While the HIPAA privacy regulations at 45 C.F.R. Part 164 require a business associate agreement for certain vendors whom you deal with -- such as the service providers mentioned above -- we deem that it unnecessary to enter into any HIPAA business associate agreements or agree to the terms set forth in the Special Contract Requirement unless required under the law.

AB Sciex sells laboratory instruments and associated maintenance and repair services, and does not use or disclose protected health information, as defined under HIPAA, in providing such services. Typically, AB Sciex accesses system diagnostic information, i.e., information that helps us diagnose the performance of your instrument and identify the parts thereof that need repair. Although there may be rare instances in which AB Sciex needs to look at scientific results generated by the instrument to assess performance of the instrument, such exposures are unlikely to be individually identifiable, and are, in any event, incidental exposures contemplated by the HIPAA Privacy Rule as not requiring a business associate agreement.

If you still believe that a business associate agreement is needed, please provide us with a detailed explanation of how you believe our services fit into 45 C.F.R. Part 164.

Sincerely yours.

AB Sciex



July 12, 2010

Ms. Roberta Wagner  
State of West Virginia  
Department of Administration

**Proposal in Response to RFQ LBS11009**

Dear Ms Wagner,

In response to RFQ LBS11009 AB SCIEX is pleased to offer the enclosed proposal for an API 4000 LC-MS/MS System. AB SCIEX is the worlds leading provider of LC-MS/MS technology with more than 2000 API 4000 units installed around the world. Over the past 4 years **more than 45 AB SCIEX 4000 instruments have been purchased and implemented across at least 34 states** as part of the CDC-LRN program. Our proposal meets or exceeds all of the performance specifications in the RFQ.

Included is a list of US States that are currently using AB SCIEX instruments as part of the CDC-LRN program. If you would like to learn more about working with AB SCIEX and our instruments we would be happy to provide the contact information for any of these labs upon request.

AB SCIEX offers several types of training program. Included in our proposal is 2 days of training at your facility as well as a certificate to attend a four day training program at an AB SCIEX facility. The CDC also offers training as part of the LRN program and this training is performed on an AB SCIEX API 4000 instrument with an Agilent LC front end. Also, the CDC uses this same instrument configuration for method development and validation before releasing the methods to the LRN members. Should you choose to purchase this system you will have the same instrument as the CDC and 34 other states. This will simplify your training process and significantly reduce the burden of the method implementation as the methods and data can be directly downloaded and viewed on our systems.

To support the large install base, AB Sciex offers a best in class service organization with unparalleled response times and speed of resolution. With this bid we are offering our standard Warranty and AB Assurance program which provides four (4) hour telephone call back and 72-hour guaranteed on-site response. We also offer free technical support via our toll free telephone number from 8 am-8 pm, Monday through Friday.

AB SCIEX appreciates the opportunity to work with the State of West Virginia. Our proposal offers the highest performance instruments and offers the State of West Virginia the best value solution available.

Thank you for your consideration.

Sincerely,

ROB CHRISTIAN, Ph.D.  
Mass Spectrometry Sales Specialist

## **States participating in the CDC-LRN Program and using AB SCIEX instruments**

Alabama	Mississippi
Arizona	Minnesota
Arkansas	North Carolina
California	Nebraska
Colorado	New Jersey
Connecticut	New Mexico
District of Columbia	New York
Delaware	Nevada
Florida	Ohio
Georgia	Pennsylvania
Iowa	Rhode Island
Indiana	South Carolina
Massachusetts	South Dakota
Maryland	Texas
Maine	Virginia
Michigan	Wisconsin
Missouri	



State of West Virginia  
 Department of Administration  
 Purchasing Division  
 2019 Washington Street East  
 Post Office Box 50130  
 Charleston, WV 25305-0130

# Request for Quotation

RFQ NUMBER  
 LBS11009

PAGE  
 1

ADDRESS CORRESPONDENCE TO ATTENTION OF:  
 ROBERTA WAGNER  
 304-558-0067

VENDOR \*501152144 650-638-5647  
 APPLIED BIOSYSTEMS  
 850 LINCOLN CENTRE DRIVE  
 FOSTER CITY CA 94404  
*on behalf of ABS CIEX, LLC*

SHIP TO HEALTH AND HUMAN RESOURCES  
 ENVIRONMENTAL CHEMISTRY LAB  
 4710 CHIMNEY DRIVE  
 CHARLESTON, WV 25302  
 304-558-3530  
 JUN 15 11:00

Receive  
 JUN 15 2010

DATE PRINTED 06/10/2010	TERMS OF SALE Net 30	SHIP VIA No: 440-2	F.O.B. Destination	FREIGHT TERMS Freight Collected
----------------------------	-------------------------	-----------------------	-----------------------	------------------------------------

BID OPENING DATE: 07/15/2010 BID OPENING TIME 01:30PM

LINE	QUANTITY	UOP	CAT NO	ITEM NUMBER	UNIT PRICE	AMOUNT
0001	1	EA		490-55		
LIQUID CHROMATOGRAPH/MASS SPECTROMETER/MASS SPECTROMETER (LC/MS/MS) INSTRUMENT TO MEET THE REQUIREMENTS OF THE PUBLIC HEALTH EMERGENCY PREPAREDNESS COOPERATIVE AGREEMENT WITH THE CENTER FOR DISEASE CONTROL AND PREVENTION (CDC). THE TECHNOLOGY OF THE LC/MS/MS MUST BE CONFIGURED SPECIFICALLY FOR THE STATE DEPARTMENT OF HEALTH LABORATORIES WHO ARE MEMBER OF THE US CENTERS FOR DISEASE CONTROL LRN-C PROGRAM. THE RESOLUTION AND SENSITIVITY CAPABILITY MUST BE ABLE TO MEET OR EXCEED THE LIMITS OF DETECTION AND MINIMUM REPORTING LEVELS REQUIRED FOR THESE AGENTS AS STIPULATED UNDER THE CENTER FOR DISEASE CONTROL OFFICE OF QUALITY CONTROL, QUALITY ASSURANCE PROGRAM, VALIDATION GUIDELINES. THIS INSTRUMENT IS TO BE INSTALLED FOR USE BY THE OFFICE OF LABORATORY SERVICES, CHEMICAL THREAT LABORATORY AT 4710 CHIMNEY DRIVE, SUITE G, CHARLESTON, WV 25302, PER THE ATTACHED DETAILED SPECIFICATIONS.						<i>See quotation no. 20674290 attached.</i>
>> PLEASE SEE ATTACHED SPECIFICATIONS/COST SHEET. <<						
CANCELLATION: THE DIRECTOR OF PURCHASING RESERVES THE RIGHT TO CANCEL THIS CONTRACT IMMEDIATELY UPON WRITTEN NOTICE TO THE VENDOR IF THE COMMODITIES AND/OR SERVICES SUPPLIED ARE OF AN INFERIOR QUALITY OR DO NOT CONFORM TO THE SPECIFICATIONS OF THE BID AND CONTRACT HEREIN.						

SEE REVERSE SIDE FOR TERMS AND CONDITIONS

SIGNATURE <i>Phillip G. B...</i>	TELEPHONE 800.874.9868	DATE July 13, 2010
TITLE Sr. Contract Specialist	FEIN 27-1082047	ADDRESS CHANGES TO BE NOTED ABOVE

WHEN RESPONDING TO RFQ, INSERT NAME AND ADDRESS IN SPACE ABOVE LABELED 'VENDOR'

## GENERAL TERMS & CONDITIONS REQUEST FOR QUOTATION (RFQ) AND REQUEST FOR PROPOSAL (RFP)

1. Awards will be made in the best interest of the State of West Virginia.
2. The State may accept or reject in part, or in whole, any bid.
3. Prior to any award, the apparent successful vendor must be properly registered with the Purchasing Division and have paid the required \$125 fee.
4. All services performed or goods delivered under State Purchase Order/Contracts are to be continued for the term of the Purchase Order/Contracts, contingent upon funds being appropriated by the Legislature or otherwise being made available. In the event funds are not appropriated or otherwise available for these services or goods this Purchase Order/Contract becomes void and of no effect after June 30.
5. Payment may only be made after the delivery and acceptance of goods or services.
6. Interest may be paid for late payment in accordance with the *West Virginia Code*.
7. Vendor preference will be granted upon written request in accordance with the *West Virginia Code*.
8. The State of West Virginia is exempt from federal and state taxes and will not pay or reimburse such taxes.
9. The Director of Purchasing may cancel any Purchase Order/Contract upon 30 days written notice to the seller.
10. The laws of the State of West Virginia and the *Legislative Rules* of the Purchasing Division shall govern the purchasing process.
11. Any reference to automatic renewal is hereby deleted. The Contract may be renewed only upon mutual written agreement of the parties.
12. **BANKRUPTCY:** In the event the vendor/contractor files for bankruptcy protection, the State may deem this contract null and void, and terminate such contract without further order.
13. **HIPAA BUSINESS ASSOCIATE ADDENDUM:** The West Virginia State Government HIPAA Business Associate Addendum (BAA), approved by the Attorney General, is available online at [www.state.wv.us/admin/purchase/vrc/hipaa.htm](http://www.state.wv.us/admin/purchase/vrc/hipaa.htm) and is hereby made part of the agreement. Provided that the Agency meets the definition of a Cover Entity (45 CFR §160.103) and will be disclosing Protected Health Information (45 CFR §160.103) to the vendor.
14. **CONFIDENTIALITY:** The vendor agrees that he or she will not disclose to anyone, directly or indirectly, any such personally identifiable information or other confidential information gained from the agency, unless the individual who is the subject of the information consents to the disclosure in writing or the disclosure is made pursuant to the agency's policies, procedures, and rules. Vendor further agrees to comply with the Confidentiality Policies and Information Security Accountability Requirements, set forth in <http://www.state.wv.us/admin/purchase/privacy/noticeConfidentiality.pdf>.
15. **LICENSING:** Vendors must be licensed and in good standing in accordance with any and all state and local laws and requirements by any state or local agency of West Virginia, including, but not limited to, the West Virginia Secretary of State's Office, the West Virginia Tax Department, and the West Virginia Insurance Commission. The vendor must provide all necessary releases to obtain information to enable the director or spending unit to verify that the vendor is licensed and in good standing with the above entities.
16. **ANTITRUST:** In submitting a bid to any agency for the State of West Virginia, the bidder offers and agrees that if the bid is accepted the bidder will convey, sell, assign or transfer to the State of West Virginia all rights, title and interest in and to all causes of action it may now or hereafter acquire under the antitrust laws of the United States and the State of West Virginia for price fixing and/or unreasonable restraints of trade relating to the particular commodities or services purchased or acquired by the State of West Virginia. Such assignment shall be made and become effective at the time the purchasing agency tenders the initial payment to the bidder.

I certify that this bid is made without prior understanding, agreement, or connection with any corporation, firm, limited liability company, partnership, or person or entity submitting a bid for the same material, supplies, equipment or services and is in all respects fair and without collusion or Fraud. I further certify that I am authorized to sign the certification on behalf of the bidder or this bid.

---

### INSTRUCTIONS TO BIDDERS

1. Use the quotation forms provided by the Purchasing Division. Complete all sections of the quotation form.
2. Items offered must be in compliance with the specifications. Any deviation from the specifications must be clearly indicated by the bidder. Alternates offered by the bidder as **EQUAL** to the specifications must be clearly defined. A bidder offering an alternate should attach complete specifications and literature to the bid. The Purchasing Division may waive minor deviations to specifications.
3. Unit prices shall prevail in case of discrepancy. All quotations are considered F.O.B. destination unless alternate shipping terms are clearly identified in the quotation.
4. All quotations must be delivered by the bidder to the office listed below prior to the date and time of the bid opening. Failure of the bidder to deliver the quotations on time will result in bid disqualifications: Department of Administration, Purchasing Division, 2019 Washington Street East, P.O. Box 50130, Charleston, WV 25305-0130
5. Communication during the solicitation, bid, evaluation or award periods, except through the Purchasing Division, is strictly prohibited (W.Va. C.S.R. §148-1-6.6).



State of West Virginia  
 Department of Administration  
 Purchasing Division  
 2019 Washington Street East  
 Post Office Box 50130  
 Charleston, WV 25305-0130

# Request for Quotation

RFQ NUMBER  
**LBS11009**

PAGE  
**2**

ADDRESS CORRESPONDENCE TO ATTENTION OF:  
**ROBERTA WAGNER**  
**304-558-0067**

**\*501152144 650-638-5647**  
**APPLIED BIOSYSTEMS**  
**850 LINCOLN CENTRE DRIVE**  
**FOSTER CITY CA 94404**  
*on behalf of ABS CIEX LLC*

**HEALTH AND HUMAN RESOURCES**  
**ENVIRONMENTAL CHEMISTRY LAB**  
**4710 CHIMNEY DRIVE**  
**CHARLESTON, WV**  
**25302 304-558-3530**

DATE PRINTED <b>06/10/2010</b>	TERMS OF SALE <b>Net 30</b>	SHIP VIA	F.O.B. <b>Destination</b>	FREIGHT TERMS <b>Freight Quoted</b>
-----------------------------------	--------------------------------	----------	------------------------------	--

BID OPENING DATE: **07/15/2010** BID OPENING TIME: **01:30PM**

LINE	QUANTITY	UOP	CAT. NO.	ITEM NUMBER	UNIT PRICE	AMOUNT
<p><b>BANKRUPTCY: IN THE EVENT THE VENDOR/CONTRACTOR FILES FOR BANKRUPTCY PROTECTION, THE STATE MAY DEEM THE CONTRACT NULL AND VOID, AND TERMINATE SUCH CONTRACT WITHOUT FURTHER ORDER.</b></p> <p><b>INQUIRIES: WRITTEN QUESTIONS SHALL BE ACCEPTED THROUGH CLOSE OF BUSINESS ON 6/29/2010. QUESTIONS MAY BE SENT VIA USPS, FAX, COURIER OR E-MAIL. IN ORDER TO ASSURE NO VENDOR RECEIVES AN UNFAIR ADVANTAGE, NO SUBSTANTIVE QUESTIONS WILL BE ANSWERED ORALLY. IF POSSIBLE, E-MAIL QUESTIONS ARE PREFERRED. ADDRESS INQUIRIES TO:</b></p> <p><b>ROBERTA WAGNER</b>  <b>DEPARTMENT OF ADMINISTRATION</b>  <b>PURCHASING DIVISION</b>  <b>2019 WASHINGTON STREET, EAST</b>  <b>CHARLESTON, WV 25311</b></p> <p><b>FAX: 304-558-4115</b>  <b>E-MAIL: ROBERTA.A.WAGNER@WV.GOV</b></p> <p><b>THE MODEL/BRAND/SPECIFICATIONS NAMED HEREIN ESTABLISH THE ACCEPTABLE LEVEL OF QUALITY ONLY AND ARE NOT INTENDED TO REFLECT A PREFERENCE OR FAVOR ANY PARTICULAR BRAND OR VENDOR. VENDORS WHO ARE BIDDING ALTERNATES SHOULD SO STATE AND INCLUDE PERTINENT LITERATURE AND SPECIFICATIONS. FAILURE TO PROVIDE INFORMATION FOR ANY ALTERNATES MAY BE GROUNDS FOR REJECTION OF THE BID. THE STATE RESERVES THE RIGHT TO WAIVE MINOR IRREGULARITIES IN BIDS OR SPECIFICATION</b></p>						

SEE REVERSE SIDE FOR TERMS AND CONDITIONS

SIGNATURE: *Phillip C. R.* TELEPHONE: **800-874-9868** DATE: **July 13, 2010**

TITLE: **St. Contract Specialist** FERN: **27-1082047** ADDRESS CHANGES TO BE NOTED ABOVE

WHEN RESPONDING TO RFQ, INSERT NAME AND ADDRESS IN SPACE ABOVE LABELED 'VENDOR'





State of West Virginia  
 Department of Administration  
 Purchasing Division  
 2019 Washington Street East  
 Post Office Box 50130  
 Charleston, WV 25305-0130

# Request for Quotation

RFQ NUMBER
LBS11009

PAGE
3

ADDRESS CORRESPONDENCE TO ATTENTION OF
ROBERTA WAGNER 304-558-0067

VENDOR

\*501152144      650-638-5647  
 APPLIED BIOSYSTEMS  
 850 LINCOLN CENTRE DRIVE  
 FOSTER CITY CA 94404  
*on behalf of AB SCIEX LLC*

SHIP TO

HEALTH AND HUMAN RESOURCES  
 ENVIRONMENTAL CHEMISTRY LAB  
 4710 CHIMNEY DRIVE  
 CHARLESTON, WV  
 25302      304-558-3530

DATE PRINTED 06/10/2010	TERMS OF SALE <i>Net 30</i>	SHIP VIA	F.O.B <i>Destination</i>	FREIGHT TERMS <i>Freight Quoted</i>
----------------------------	--------------------------------	----------	-----------------------------	--

BID OPENING DATE: 07/15/2010      BID OPENING TIME: 01:30PM

LINE	QUANTITY	UOP	CAT. NO.	ITEM NUMBER	UNIT PRICE	AMOUNT
<p>IN ACCORDANCE WITH SECTION 148-1-4 (F) OF THE WEST VIRGINIA LEGISLATIVE RULES AND REGULATIONS.            VENDOR PREFERENCE CERTIFICATE</p> <p>THIS TEAM EXHIBIT HAS BEEN REPLACED BY THE ONLINE VERSION WHICH IS AVAILABLE HERE:  <a href="http://www.state.wv.us/admin/purchase/vrc/venpref.pdf">HTTP://WWW.STATE.WV.US/ADMIN/PURCHASE/VRC/VENPREF.PDF</a></p> <p>NOTICE</p> <p>A SIGNED BID MUST BE SUBMITTED TO:</p> <p>DEPARTMENT OF ADMINISTRATION            PURCHASING DIVISION            BUILDING 15            2019 WASHINGTON STREET, EAST            CHARLESTON, WV 25305-0130</p> <p>PLEASE NOTE: A CONVENIENCE COPY WOULD BE APPRECIATED.</p> <p>THE BID SHOULD CONTAIN THIS INFORMATION ON THE FACE OF THE ENVELOPE OR THE BID MAY NOT BE CONSIDERED:</p> <p>SEALED BID</p> <p>BUYER:-----RW/FILE 22-----</p> <p>RFQ. NO.:-----LBS11009-----</p> <p>BID OPENING DATE:---7/15/2010---</p> <p>BID OPENING TIME:---1:30 PM-----</p>						

SEE REVERSE SIDE FOR TERMS AND CONDITIONS

SIGNATURE <i>Phillip G. R.</i>	TELEPHONE 800-874-9868	DATE July 13, 2010
TITLE <i>Sr. Contract Specialist</i>	FEIN 27-1082047	ADDRESS CHANGES TO BE NOTED ABOVE

WHEN RESPONDING TO RFQ, INSERT NAME AND ADDRESS IN SPACE ABOVE LABELED 'VENDOR'



State of West Virginia  
 Department of Administration  
 Purchasing Division  
 2019 Washington Street East  
 Post Office Box 50130  
 Charleston, WV 25305-0130

# Request for Quotation

RFQ NUMBER  
 LBS11009

PAGE  
 4

ADDRESS CORRESPONDENCE TO ATTENTION OF:  
 ROBERTA WAGNER  
 304-558-0067

VENDOR

\*501152144      650-638-5647  
 APPLIED BIOSYSTEMS  
 850 LINCOLN CENTRE DRIVE  
 FOSTER CITY CA 94404  
*on behalf of ABSCEX LLC*

SHIP TO

HEALTH AND HUMAN RESOURCES  
 ENVIRONMENTAL CHEMISTRY LAB  
 4710 CHIMNEY DRIVE  
 CHARLESTON, WV  
 25302      304-558-3530

DATE PRINTED 06/10/2010	TERMS OF SALE <i>Net 30</i>	SHIP VIA	F.O.B. <i>Destination</i>	FREIGHT TERMS <i>Freight Quoted</i>
----------------------------	--------------------------------	----------	------------------------------	--

BID OPENING DATE: *07/15/2010*      BID OPENING TIME: *01:30PM*

LINE	QUANTITY	UOP	CAT. NO.	ITEM NUMBER	UNIT PRICE	AMOUNT
PLEASE PROVIDE A FAX NUMBER IN CASE IT IS NECESSARY TO CONTACT YOU REGARDING YOUR BID: <i>650-638-5143</i>						
CONTACT PERSON (PLEASE PRINT CLEARLY): <i>Carla T. Mc Murray</i>						
***** THIS IS THE END OF RFQ LBS11009 ***** TOTAL:						<i>See quotation no. 20674290 attached.</i>

SEE REVERSE SIDE FOR TERMS AND CONDITIONS

SIGNATURE <i>Phillip B. R.</i>	TELEPHONE <i>800-874-7868</i>	DATE <i>July 13, 2010</i>
TITLE <i>Sr. Contract Specialist</i>	FEIN <i>27-1082047</i>	ADDRESS CHANGES TO BE NOTED ABOVE

WHEN RESPONDING TO RFQ, INSERT NAME AND ADDRESS IN SPACE ABOVE LABELED 'VENDOR'

## SPECIFICATIONS AND REQUIREMENTS

The Threat Preparedness and Response Section, Chemical Threats, of the Office of Laboratory Services (CT) is requesting to purchase a Liquid Chromatograph/Mass Spectrometer/Mass Spectrometer (LC/MS/MS).

1. A LC/MS/MS instrument is needed by CT to meet the requirements of the Public Health Emergency Preparedness cooperative agreement with the Center for Disease Control and Prevention (CDC), Atlanta, Georgia.
2. The technology of this LC/MS/MS instrument must be configured specifically for the State Department of Health laboratories who are members of the US Centers for Disease Control LRN-C Program (Laboratory Response Network – Chemical). The resolution and sensitivity capability must be able to meet or exceed the limits of detection and minimum reporting levels required for these agents as stipulated under the Center for Disease Control Office of Quality Control, Quality Assurance Program, Validation Guidelines.
3. The LC/MS/MS instrument must come equipped with a triple quadrupole mass spectrometer, workstation PC and printer, software with 2 data analysis licenses, installation, and familiarization training.
4. The LC/MS/MS instrument must have an atmospheric pressure chemical ionization (APCI) source with spray chamber, corona discharge needle, nebulizer, APCI vaporizer, and test calibration kit.
5. The LC/MS/MS instrument must come equipped with LC/MS rough pumps compatible with BOC Edwards pumps, or equivalent.
6. The LC/MS/MS instrument must have a nitrogen gas generator and a maintenance kit.
7. The LC/MS/MS instrument must have a binary pump system with solvent cabinet, 2 solvent bottles, connecting capillaries, and CAN cable (cable wire that connects the pump system to the computer). It must also contain a maintenance kit, active seal option, and solvent selection valve option.

8. The LC/MS/MS instrument system package must have a micro degasser which includes a 4-channel micro-vacuum, degasser, remote control cable, and connecting tubing.
9. The LC/MS/MS instrument must be fully compatible with a system controlled auto sampler with a 100uL injection loop, tray for two well plates, 10x 2mL vials, 2x54- vial plates, Rheodyne injection valve (600 bar), and 05 m CAN cable.
10. The LC/MS/MS instrument system must have a Peltier (generic term for any device that uses the Peltier effect to heat or cool materials) type device to control the temperature of the auto samplers/fraction collectors.
11. For rapid resolution LC, the column compartment temperature must maximize to 100°C and pressures up to 600 bar.
12. The LC/MS/MS instrument must come with a high pressure liquid chromatography (HPLC) column oven with a temperature tolerance of +/- 2°C.
13. The LC/MS/MS instrument must come with a column Atlantis HILIC Silica, 2.1 x 50 mm 3µm particles, or equivalent for the Ortho-Phosphate Nerve Agents (OPNA) method.
14. The LC/MS/MS instrument system must include a diode array detector with radio-frequency identification (RFID) tracking technology for flow cells and ultra violet (UV) lamp with one standard flow cell.
15. The LC/MS/MS instrument system must contain a SB-C18, 2.1x100mm, 1.8µm, 600 bar, or equivalent column.
16. Consumables to be included with the LC/MS/MS instrument: finger tight polyketone fittings 1/16" in a 10 pack with the maximum pressure capability of 600 bar, rapid resolution liquid chromatography (RRLC) in-line filter, 2 mm, 0.2 um filter with the maximum 600 bar with 3 frits and 70x0.12 mm connecting capillary, and replacement frits, 2mm, 0.2um in a 10 pack what are stainless steel, PEEK encapsulated for use with RRLC in-line filter.
17. The LC/MS/MS instrument must be fully automated for analysis with a system controller that is loaded with the necessary software. System

controller software must be able to export data to the existing Laboratory Information Management System (LIMS), STARLIMS Sunrise version 9, resides on a Microsoft Windows Server 2003 file server. The ability for the equipment to place a results data file into a shared folder on the LIMS server in a format that can be imported is required.

18. The LC/MS/MS instrument system controller software must be able to fulfill all of the analytical and quality control requirements stated in the CDC Office of Quality Control, Quality Assurance Program, Validation Guidelines. The LRN-C validation guidelines as published by the CDC on the LRN-C, the information is not for public distribution and is considered "sensitive" to the point that we are forbidden to pass on uncontrolled copies.

### **Installation Requirements:**

1. Vendor must install the LC/MS/MS instrument system in the Threat Preparedness Laboratory in the Elk Office Center building at 4710 Chimney Drive, Suite G, Charleston, WV, 25302.
2. Vendor must provide to the Threat Preparedness (TP) Program Manager all relevant information concerning the installation in a documented form at least 2 weeks prior to the scheduled installation.
3. At the time of the LC/MS/MS instrument installation, Vendor must provide to the TP Program Manager: All relevant system manuals for hardware components: system and application software documentation: and a parts, supplies, and accessories catalog.
4. Vendor must include all necessary cables and fittings and other costs for installation in the submitted bid price.
5. Installation and on-site training must be completed within 90 days of delivery date.

### **Training Requirements**

1. Vendor must provide, upon completion of installation, two days of on-site training for the Threat Preparedness personnel on the operation and user maintenance requirements of the LC/MS/MS instrument system.

2. All costs incurred by the Vendor including travel, lodging, and living expenses necessary to provide this basic training shall be included in the bid price.

### **Warranty Requirements**

1. Vendor must include in the total price of the equipment at least a one-year factory warranty covering all system components.
2. Software support must be included as part of the one-year warranty.
3. Warranty must include on-site service including labor, travel time, and expenses with a 72-hour on-site response time at no extra cost to maintain the specifications listed in the bid and the Vendor's product specifications. (Vendor should include a copy of the warranty).
4. Warranty must begin upon acceptance of the completed installation and training.

### **Delivery Requirements**

1. The LC/MS/MS instrument and its components must be shipped for "inside delivery" by a freight delivery company and must be delivered within 90 days of receipt of order.
2. The LC/MS/MS instrument and its components must be shipped "F.O.B. Destination" unless otherwise stated in quote by Vendor. Any shipping and handling requirements must be stated in Vendor's quote.

**RFQ COST SHEET**

Bidders shall provide a cost for the following:

Liquid Chromatograph/Mass Spectrometer/Mass Spectrometer  
(LC/MS/MS)

\$ 359,408.78

On-Site User Training (at installation of equipment)

\$ 0

Freight/Shipping Charge

\$ 2,559.82

**Total Cost** \$ 361,968.60

The award will be made to the vendor with the lowest overall total cost of the equipment which meets all requested specifications and requirements. Payment will be made in arrears.

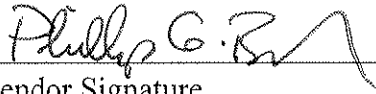
  
Vendor Signature

July 13, 2010  
Date

RFQ No. LBS11009

STATE OF WEST VIRGINIA  
Purchasing Division

**PURCHASING AFFIDAVIT**

West Virginia Code §5A-3-10a states: No contract or renewal of any contract may be awarded by the state or any of its political subdivisions to any vendor or prospective vendor when the vendor or prospective vendor or a related party to the vendor or prospective vendor is a debtor and the debt owed is an amount greater than one thousand dollars in the aggregate.

**DEFINITIONS:**

"Debt" means any assessment, premium, penalty, fine, tax or other amount of money owed to the state or any of its political subdivisions because of a judgment, fine, permit violation, license assessment, defaulted workers' compensation premium, penalty or other assessment presently delinquent or due and required to be paid to the state or any of its political subdivisions, including any interest or additional penalties accrued thereon.

"Debtor" means any individual, corporation, partnership, association, limited liability company or any other form or business association owing a debt to the state or any of its political subdivisions. "Political subdivision" means any county commission; municipality; county board of education; any instrumentality established by a county or municipality; any separate corporation or instrumentality established by one or more counties or municipalities, as permitted by law; or any public body charged by law with the performance of a government function or whose jurisdiction is coextensive with one or more counties or municipalities. "Related party" means a party, whether an individual, corporation, partnership, association, limited liability company or any other form or business association or other entity whatsoever, related to any vendor by blood, marriage, ownership or contract through which the party has a relationship of ownership or other interest with the vendor so that the party will actually or by effect receive or control a portion of the benefit, profit or other consideration from performance of a vendor contract with the party receiving an amount that meets or exceeds five percent of the total contract amount.

**EXCEPTION:** The prohibition of this section does not apply where a vendor has contested any tax administered pursuant to chapter eleven of this code, workers' compensation premium, permit fee or environmental fee or assessment and the matter has not become final or where the vendor has entered into a payment plan or agreement and the vendor is not in default of any of the provisions of such plan or agreement.

Under penalty of law for false swearing (*West Virginia Code §61-5-3*), it is hereby certified that the vendor affirms and acknowledges the information in this affidavit and is in compliance with the requirements as stated.

**WITNESS THE FOLLOWING SIGNATURE**

Vendor's Name: AB SCIEX LLC

Authorized Signature: *Pony Sung* Date: 7/12/10

State of California

County of San Mateo, to-wit:

Taken, subscribed, and sworn to before me this 12th day of July, 2010.

My Commission expires Oct. 21, 2012, 20  .

AFFIX SEAL HERE

NOTARY PUBLIC *Mila T. Kasan*

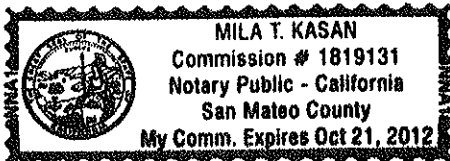



State of West Virginia

VENDOR PREFERENCE CERTIFICATE

Certification and application\* is hereby made for Preference in accordance with West Virginia Code, §5A-3-37. (Does not apply to construction contracts). West Virginia Code, §5A-3-37, provides an opportunity for qualifying vendors to request (at the time of bid) preference for their residency status. Such preference is an evaluation method only and will be applied only to the cost bid in accordance with the West Virginia Code. This certificate for application is to be used to request such preference. The Purchasing Division will make the determination of the Resident Vendor Preference, if applicable.

- 1. Application is made for 2.5% resident vendor preference for the reason checked: Bidder is an individual resident vendor and has resided continuously in West Virginia for four (4) years immediately preceding the date of this certification; or, Bidder is a partnership, association or corporation resident vendor and has maintained its headquarters or principal place of business continuously in West Virginia for four (4) years immediately preceding the date of this certification; or 80% of the ownership interest of Bidder is held by another individual, partnership, association or corporation resident vendor who has maintained its headquarters or principal place of business continuously in West Virginia for four (4) years immediately preceding the date of this certification; or, Bidder is a nonresident vendor which has an affiliate or subsidiary which employs a minimum of one hundred state residents and which has maintained its headquarters or principal place of business within West Virginia continuously for the four (4) years immediately preceding the date of this certification; or,
2. Application is made for 2.5% resident vendor preference for the reason checked: Bidder is a resident vendor who certifies that, during the life of the contract, on average at least 75% of the employees working on the project being bid are residents of West Virginia who have resided in the state continuously for the two years immediately preceding submission of this bid; or,
3. Application is made for 2.5% resident vendor preference for the reason checked: Bidder is a nonresident vendor employing a minimum of one hundred state residents or is a nonresident vendor with an affiliate or subsidiary which maintains its headquarters or principal place of business within West Virginia employing a minimum of one hundred state residents who certifies that, during the life of the contract, on average at least 75% of the employees or Bidder's affiliate's or subsidiary's employees are residents of West Virginia who have resided in the state continuously for the two years immediately preceding submission of this bid; or,
4. Application is made for 5% resident vendor preference for the reason checked: Bidder meets either the requirement of both subdivisions (1) and (2) or subdivision (1) and (3) as stated above; or,
5. Application is made for 3.5% resident vendor preference who is a veteran for the reason checked: Bidder is an individual resident vendor who is a veteran of the United States armed forces, the reserves or the National Guard and has resided in West Virginia continuously for the four years immediately preceding the date on which the bid is submitted; or,
6. Application is made for 3.5% resident vendor preference who is a veteran for the reason checked: Bidder is a resident vendor who is a veteran of the United States armed forces, the reserves or the National Guard, if, for purposes of producing or distributing the commodities or completing the project which is the subject of the vendor's bid and continuously over the entire term of the project, on average at least seventy-five percent of the vendor's employees are residents of West Virginia who have resided in the state continuously for the two immediately preceding years.

Bidder understands if the Secretary of Revenue determines that a Bidder receiving preference has failed to continue to meet the requirements for such preference, the Secretary may order the Director of Purchasing to: (a) reject the bid; or (b) assess a penalty against such Bidder in an amount not to exceed 5% of the bid amount and that such penalty will be paid to the contracting agency or deducted from any unpaid balance on the contract or purchase order.

By submission of this certificate, Bidder agrees to disclose any reasonably requested information to the Purchasing Division and authorizes the Department of Revenue to disclose to the Director of Purchasing appropriate information verifying that Bidder has paid the required business taxes, provided that such information does not contain the amounts of taxes paid nor any other information deemed by the Tax Commissioner to be confidential.

Under penalty of law for false swearing (West Virginia Code, §61-5-3), Bidder hereby certifies that this certificate is true and accurate in all respects; and that if a contract is issued to Bidder and if anything contained within this certificate changes during the term of the contract, Bidder will notify the Purchasing Division in writing immediately.

Bidder: AB SCIEX LLC

Signed: Phillip C. [Signature]

Date: July 13, 2010

Title: Sr. Contract Specialist

\*Check any combination of preference consideration(s) indicated above, which you are entitled to receive.

WV-96  
Rev. 10/07

**AGREEMENT ADDENDUM**

In the event of conflict between this addendum and the agreement, this addendum shall control:

1. **DISPUTES** - Any references in the agreement to arbitration or to the jurisdiction of any court are hereby deleted. Disputes arising out of the agreement shall be presented to the West Virginia Court of Claims.
2. **HOLD HARMLESS** - Any clause requiring the Agency to indemnify or hold harmless any party is hereby deleted in its entirety.
3. **GOVERNING LAW** - The agreement shall be governed by the laws of the State of West Virginia. This provision replaces any references to any other State's governing law.
4. **TAXES** - Provisions in the agreement requiring the Agency to pay taxes are deleted. As a State entity, the Agency is exempt from Federal, State, and local taxes and will not pay taxes for any Vendor including individuals, nor will the Agency file any tax returns or reports on behalf of Vendor or any other party.
5. **PAYMENT** - Any references to prepayment are deleted. Payment will be in arrears.
6. **INTEREST** - Should the agreement include a provision for interest on late payments, the Agency agrees to pay the maximum legal rate under West Virginia law. All other references to interest or late charges are deleted.
7. **RECOUPMENT** - Any language in the agreement waiving the Agency's right to set-off, counterclaim, recoupment, or other defense is hereby deleted.
8. **FISCAL YEAR FUNDING** - Service performed under the agreement may be continued in succeeding fiscal years for the term of the agreement, contingent upon funds being appropriated by the Legislature or otherwise being available for this service. In the event funds are not appropriated or otherwise available for this service, the agreement shall terminate without penalty on June 30. After that date, the agreement becomes of no effect and is null and void. However, the Agency agrees to use its best efforts to have the amounts contemplated under the agreement included in its budget. Non-appropriation or non-funding shall not be considered an event of default.
9. **STATUTE OF LIMITATION** - Any clauses limiting the time in which the Agency may bring suit against the Vendor, lessor, individual, or any other party are deleted.
10. **SIMILAR SERVICES** - Any provisions limiting the Agency's right to obtain similar services or equipment in the event of default or non-funding during the term of the agreement are hereby deleted.
11. **ATTORNEY FEES** - The Agency recognizes an obligation to pay attorney's fees or costs only when assessed by a court of competent jurisdiction. Any other provision is invalid and considered null and void.
12. **ASSIGNMENT** - Notwithstanding any clause to the contrary, the Agency reserves the right to assign the agreement to another State of West Virginia agency, board or commission upon thirty (30) days written notice to the Vendor and Vendor shall obtain the written consent of Agency prior to assigning the agreement.
13. **LIMITATION OF LIABILITY** - The Agency, as a State entity, cannot agree to assume the potential liability of a Vendor. Accordingly, any provision limiting the Vendor's liability for direct damages to a certain dollar amount or to the amount of the agreement is hereby deleted. Limitations on special, incidental or consequential damages are acceptable. In addition, any limitation is null and void to the extent that it precludes any action for injury to persons or for damages to personal property.
14. **RIGHT TO TERMINATE** - Agency shall have the right to terminate the agreement upon thirty (30) days written notice to Vendor. Agency agrees to pay Vendor for services rendered or goods received prior to the effective date of termination.
15. **TERMINATION CHARGES** - Any provision requiring the Agency to pay a fixed amount or liquidated damages upon termination of the agreement is hereby deleted. The Agency may only agree to reimburse a Vendor for actual costs incurred or losses sustained during the current fiscal year due to wrongful termination by the Agency prior to the end of any current agreement term.
16. **RENEWAL** - Any reference to automatic renewal is hereby deleted. The agreement may be renewed only upon mutual written agreement of the parties.
17. **INSURANCE** - Any provision requiring the Agency to insure equipment or property of any kind and name the Vendor as beneficiary or as an additional insured is hereby deleted.
18. **RIGHT TO NOTICE** - Any provision for repossession of equipment without notice is hereby deleted. However, the Agency does recognize a right of repossession with notice.
19. **ACCELERATION** - Any reference to acceleration of payments in the event of default or non-funding is hereby deleted.
20. **CONFIDENTIALITY**: -Any provision regarding confidentiality of the terms and conditions of the agreement is hereby deleted. State contracts are public records under the West Virginia Freedom of Information Act.
21. **AMENDMENTS** - All amendments, modifications, alterations or changes to the agreement shall be in writing and signed by both parties. No amendment, modification, alteration or change may be made to this addendum without the express written approval of the Purchasing Division and the Attorney General.

ACCEPTED BY:

**STATE OF WEST VIRGINIA**

Spending Unit: \_\_\_\_\_

Signed: \_\_\_\_\_

Title: \_\_\_\_\_

Date: \_\_\_\_\_

**VENDOR**

Company Name: AB SCIEX LLC

Signed: Phillip C. B...

Title: Sr. Contracts Specialist

Date: July 13, 2010

ATTACHMENT  
P.O.# LBS11009

This agreement constitutes the entire agreement between the parties, and there are no other terms and conditions applicable to the licenses granted hereunder.

Agreed

Phillip C. Brown      July 13, 2010  
Signature                      Date

St. Contracts Specialist  
Title

AB SCIEX LLC  
Company Name

\_\_\_\_\_  
Signature                      Date

\_\_\_\_\_  
Title

\_\_\_\_\_  
Agency/Division



# Quotation

AB Sciex LLC  
 353 Hatch Drive  
 Foster City, CA 94404 U.S.A.  
 T(650)638-5800, F(650)638-5884

PAGE 1 of 10

To: Roberta Wagner  
 Dept of Administration  
 4710 Chimney Drive  
 CHARLESTON WV 25305

**Quote No.:** 20674667  
**Quote Valid To:** 09/04/2010  
**Quote Date:** 07/13/2010  
**Pay Terms:** Net 30 Days  
**Freight Terms:** FOB DESTINATION - FRT QUOTED

Telephone No. 304-558-0067  
 Fax No.  
 Reference Bid # LBS11009

**Please reference Quote No. when placing your orders.**

Item	Part Number	Description	QTY	Unit List Price	Unit Net Price	Total Extended Price
0001	4362722	API 4000 Applied Markets System Package	1.00	395,000.00	265,950.00	265,950.00
<p>INCLUDES:</p> <p>API 4000 Instrument            Enhanced high performance triple quadrupole mass spectrometer system with a mass range of m/z 5 to 3000.</p> <p>Please select ONE (1) of the following pump options to complete your API 4000 instrument configuration.</p> <p>Varian Single Wet Pump Kit PN 1027671 -no additional charge            OR            Quotes would appear for the API 4000: \$6,123.00 USD (\$6,857.76 CAD)            Varian Single Dry Pump Kit PN 1027672 - additional \$6,123.00 USD (\$6,857.76 CAD)            OR            Edwards Single Dry Pump Kit PN 1032168 - additional \$6,123.00 USD (\$6,857.76 CAD)            PN WC026992 PN 4362722 PN4401849</p>						

### WARRANTY INFORMATION

AB Sciex limited product warranties are included with shipment of its products. You may visit [www.absciex.com](http://www.absciex.com) for warranty information or contact your local AB SCIEX sales representative to request a copy. AB Sciex instruments and accessories are warranted by AB Sciex for a period of one year, unless a different period or no warranty is indicated on AB Sciex quotation. The warranty period for AB Sciex instruments begins on the earlier of the date of installation or 90 days from the date of shipment for instruments installed by AB Sciex personnel. For AB Sciex instruments installed by the buyer or anyone other than AB Sciex, the warranty period begins on the date the instrument is delivered.

### TERMS AND CONDITIONS

This quotation, including AB Sciex' General Terms and Conditions of Sale furnished with this quotation, and, if software is included, AB Sciex' applicable end user software license agreement, sets forth the terms on which AB Sciex is offering to sell the product(s) listed on this quotation. AB Sciex' end user license agreement for instrument operating software can be found on AB Sciex website, at: <http://www.absciex.com/legal>. Licenses for stand alone software are in click wrap form. You may contact AB Sciex for a copy at any time. By issuing a purchase order or otherwise ordering the product(s), the customer expressly agrees to these General Terms and Conditions of Sale (and operating software end user software license agreement, if applicable) to the exclusion of all others not expressly agreed to in writing by an authorized representative of AB Sciex. If you have any questions, please call AB Sciex' Customer Account Services at 650-638-5800. Stenographical/clerical errors are subject to correction. Most recent quotation will supersede all prior quotations. All amounts are in USD.

**Sales Representative: Robert Christian**

**Prepared by: Cherry Gallardo**



# Quotation

AB Sciex LLC  
353 Hatch Drive  
Foster City, CA 94404 U.S.A.  
T(650)638-5800, F(650)638-5884

PAGE 2 of 10

**QUOTE NO.:** 20674667  
**QUOTE VALID TO:** 09/04/2010  
**QUOTE DATE:** 07/13/2010

To: Roberta Wagner  
Dept of Administration

**Please reference Quote No.  
when placing your orders.**

Item	Part Number	Description	QTY	Unit List Price	Unit Net Price	Total Extended Price
		<p>Turbo V Source Accepts TurboIonSpray or APCI probe</p> <p>TurboIonSpray Probe Heated IonSpray probe for use in the Turbo V Source. Accepts flow rates from 5 to 3000 ul/min without splitting.</p> <p>APCI Probe Atmospheric Pressure Chemical Ionization probe for use in Turbo V Source. Accepts flow rates of 200 to 3000 ul/min.</p> <p>Analyst software for control, data acquisition, and data processing on AB SCIEX QqQ and QTRAP(R) mass spectrometers. Includes 2 licenses: 1 license for the instrument workstation, and 1 processing-only license for an extra non-instrument PC. Compatible with Windows XP SP3 or 2000 SP4.</p> <p>Cliquid 3.0 Software Startup Kit Software for Routine Analysis and Microsoft office only. Designed for users who want to employ their own tests or to add tests using the iMethods Test products (to be purchased separately). Two sample methods and an example System Suitability test are included.</p> <p>MultiQuant(TM) Software Version 2.0 Base Version for quantitation of small and large molecule compounds. Compatible with all AB SCIEX QTRAP® and Triple Quad# based platforms. One DVD and one perpetual license included. Scheduled® MRM and Audit Trail &amp; Security functionality are not included in this version.</p> <p>Dell Optiplex 960 Core 2 Duo, 3.0GHz processor, 4 GB RAM, 2x500GB hard drives with RAID 1 configuration, DVD RW (CD RW capable), 3 Ethernet ports, Laser 6-button mouse and keyboard. Built-in DisplayPort Video (with adapter) capable of a maximum digital resolution of 1920x1200. The computer is imaged with Windows XP SP3 Professional (licensed with Vista Business) and drivers. This PC is RoHS compliant and can be used as an acquisition workstation or stand-alone processing computer. (This computer contains no GPIB PCI card for instrument communication.USB GPIB is included in instrument installation kit where instrument control by GPIB is required.)</p> <p>Dell 22 inch Widescreen LCD Monitor</p>				



# Quotation

AB Sciex LLC  
 353 Hatch Drive  
 Foster City, CA 94404 U.S.A.  
 T(650)638-5800, F(650)638-5884

PAGE 3 of 10

**QUOTE NO.:** 20674667  
**QUOTE VALID TO:** 09/04/2010  
**QUOTE DATE:** 07/13/2010

To: Roberta Wagner  
 Dept of Administration

**Please reference Quote No.  
 when placing your orders.**

Item	Part Number	Description	QTY	Unit List Price	Unit Net Price	Total Extended Price
		<p>Edgeport USB to serial converter box with 4 port connections and one meter USB cable. Required to control more than 2 peripheral devices. Requires the purchase of appropriate peripheral cables.</p> <p>LIMITED WARRANTY:            Standard parts and labor warranty for 1 year starting from the completion of instrument commissioning, including 1 PM visit {as provided in AB SCIEX's written limited warranty statement and accompanying terms in the user manual or other product documentation}.</p> <p>TRAINING:            Tuition for one person for an Operator Training Class at an AB SCIEX facility (does not include travel and living expenses). This training session is valid for one year from installation and is not transferable.</p>				
0002	WC014179	<p>Line Transformers            Required in areas where line voltage is out of specification (208-240VAC). Item(s) are REQUIRED FOR INSTALLATION.</p>	1.00	1,000.00	660.00	660.00
0003	800-L	LCMS-5000NA Tri-Gas Generator	1.00	0.01	20,137.00	20,137.00
0004	800-L	HP® Color LaserJet CP2025dn Printer	1.00	0.01	499.98	499.98
0005	WC024736	<p>NT-Based Peripheral Cable            PRODUCT DESCRIPTION:            Communication cable required to control Agilent 1100 Autosamplers (standard, thermostatted, wellplate, micro)            Agilent 1100 Column Oven            Agilent 1100 Pumps (isocratic, binary, quaternary, capillary)            CTC PAL Autosampler            Shimadzu SCL-10Avp System Controller            PerkinElmer Series 200 Micro Pump (two cables required)            PerkinElmer Series 200 Quaternary Pump</p>	1.00	100.00	75.00	75.00
0006	N020-0514	API ONSITE CONSULTATION (CHARGE PER DAY)	2.00	3,500.00	0.00	0.00



# Quotation

PAGE 4 of 10

AB Sciex LLC  
353 Hatch Drive  
Foster City, CA 94404 U.S.A.  
T(650)638-5800, F(650)638-5884

**QUOTE NO.:** 20674667  
**QUOTE VALID TO:** 09/04/2010  
**QUOTE DATE:** 07/13/2010

To: Roberta Wagner  
Dept of Administration

**Please reference Quote No.  
when placing your orders.**

Item	Part Number	Description	QTY	Unit List Price	Unit Net Price	Total Extended Price
		NOTE Cancellations of on-site FAS support that have been scheduled at least three weeks in advance are subject to a \$1,000.00 cancellation fe (or its dollar equivalent of time)IF the customer cancellation occurs within 5 working days of the agreed to date to come on-site with the customer.				
0007	WC013873	Single Syringe Pump Assembly Harvard Syringe Pump for closed loop injection and infusion WC013873	1.00	1,800.00	1,350.00	1,350.00
0008	1023606	AGILENT 1200 BINARY PUMP SL Binary pump optimized for 1.8 um particle size column technology. Includes solvent cabinet, 2 solvent bottles, solvent selection option, and maintenance kit.	1.00	23,480.00	18,784.00	18,784.00
0009	1023591	AGILENT 1200 MICRO VACUUM DEGASSER 4-channel micro vacuum degasser with maximum flow rate of 5 ml/min (per channel).	1.00	4,250.00	3,400.00	3,400.00
0010	1032432	AGILENT 1200 SAMPLER SL PLUS High performance autosampler includes well-plate tray for two well plates and 10 x 2 ml vials, 2 x 54 (2 ml) vial plate, and high pressure injection valve.	1.00	21,240.00	16,992.00	16,992.00
0011	1023579	AGILENT 1200 A/S THERMOSTAT MODULE Includes Peltier device to control the temperature of the Agilent series autosamplers	1.00	5,420.00	4,336.00	4,336.00
0012	1023607	AGILENT 1200 THERM COLUMN COMP SL Thermostatted column compartment with column identification module.  Thermostatted column compartment with column identification module.	1.00	6,500.00	5,200.00	5,200.00
0013	1023611	AGILENT 1200 DIODE ARRAY DET SL Diode array detector with CAN cable. Designed for fast LC. Appropriate flow cells must be purchased separately.	1.00	22,500.00	18,000.00	18,000.00
0014	1023615	AGILENT STD FLOW CELL DAD 13 ul flow cell, 10 mm path length, pressure tight to 120 bar.	1.00	1,561.00	1,248.80	1,248.80



# Quotation

AB Sciex LLC  
 353 Hatch Drive  
 Foster City, CA 94404 U.S.A.  
 T(650)638-5800, F(650)638-5884

PAGE 5 of 10

To: Roberta Wagner  
 Dept of Administration

**QUOTE NO.:** 20674667  
**QUOTE VALID TO:** 09/04/2010  
**QUOTE DATE:** 07/13/2010

**Please reference Quote No.  
 when placing your orders.**

Item	Part Number	Description	QTY	Unit List Price	Unit Net Price	Total Extended Price
------	-------------	-------------	-----	-----------------	----------------	----------------------

0015	1026762	CARD,INTEL ETHERNET 2 PORT PCIe RC Intel PRO/1000 PT Dual Port Ethernet Card, PCI express slot, RoHS compliant	1.00	220.00	176.00	176.00
0016	1023559	AGILENT 1200 INSTANT PILOT Handheld control modules allows LC system to be operated as stand-alone.	1.00	3,250.00	2,600.00	2,600.00

\*\*\*\*\*  
 QUOTATION TOTAL: \$359,408.78  
 \*\*\*\*\*

\* Quotation Total above does not include freight.

Estimated Shipping and Handling: 2,559.82

Note: AB SCIEX makes no warranty whatsoever in regards to products or parts furnished by third parties; such products or parts will be subject to the warranties, if any, of their respective manufacturer. (applies to all 800-L items quoted).

The items quoted are being offered as a convenience to the customer and may only be purchased in conjunction with AB SCIEX products listed above.

THE SPECIAL DISCOUNTS APPLIED TO THIS QUOTATION ARE VALID UNDER THIS QUOTATION ONLY AND IS CONTINGENT UPON RECEIPT OF YOUR PURCHASE ORDER FOR ITEMS AS QUOTED, ON OR BEFORE THE "QUOTE VALID" DATE.

Freight charges are prepaid and added to invoice. Shipments are made immediately upon availability.

All orders made in reference to this quotation must include all part numbers and quantities as listed. If you would like to modify this order, please contact your Sales Representative.





# Quotation

AB Sciex LLC  
353 Hatch Drive  
Foster City, CA 94404 U.S.A.  
T(650)638-5800, F(650)638-5884

PAGE 6 of 10

**QUOTE NO.:** 20674667  
**QUOTE VALID TO:** 09/04/2010  
**QUOTE DATE:** 07/13/2010

To: Roberta Wagner  
Dept of Administration

**Please reference Quote No.  
when placing your orders.**

Item	Part Number	Description	QTY	Unit List Price	Unit Net Price	Total Extended Price
------	-------------	-------------	-----	-----------------	----------------	----------------------

All information provided on this quotation is Confidential between our Customer and AB SCIEX.

To place your AB SCIEX LLC order:

For INSTRUMENTS & CONSUMABLES:

Fax # 650-638-5875, Attn: Sales Administration or phone 1-800-327-3002

## AB SCIEX LLC GENERAL TERMS AND CONDITIONS OF SALE

These General Terms and Conditions of Sale ("Terms") shall govern all orders for and purchases of products and services from AB Sciex ("AB"), including installation of equipment, unless other terms are specifically designated by AB to apply to a specific product or service, or AB and buyer have entered into a master purchase agreement or other written agreement that expressly provides that its terms supersede and replace these Terms with respect to the products or services covered by the master purchase or other agreement (See Section 12, SOLE TERMS, INCONSISTENCIES, ORDER OF PRECEDENCE).

**1. PRICE.** The price for any product or service (hereinafter collectively "Product") shall be the price stated in AB's quotation to buyer for the Product ("AB's Quotation") or, if AB has not issued a quotation, AB's list price of the Product at the time AB receives buyer's purchase order. AB's quotations are valid for 30 days from the quotation date unless otherwise stated in AB's Quotation. If AB's price is stated by reference to a price list then the price shall be AB's list price in the jurisdiction in which the Product is to be delivered or performed in effect at the time AB receives buyer's purchase order. Prices stated are exclusive of all taxes, fees, licenses, duties, levies or other governmental assessments ("Taxes") and, unless otherwise stated in AB's Quotation, shipping and handling charges, freight and insurance. All Taxes related to Product shall be paid by buyer (other than taxes assessed against AB's net income), or in lieu thereof, buyer shall provide AB with a tax exemption certificate acceptable to the relevant taxing authorities. Taxes and other charges payable by buyer may be billed as separate items on AB's invoice.

**2. PAYMENT TERMS; COLLECTION COSTS; SECURITY TERMS.** Payment terms are net 30 days from date of AB's invoice. If AB deems buyer to be or to have become uncreditworthy, AB shall have the right to require alternative payment terms, including without limitation sight draft, letter of credit, or payment in advance. Payment for partial shipments shall be based on unit or prorated prices, and payment for partial installation(s) shall be based on percentage of completion of installation, as reasonably determined by AB. If payment is not received by the due date, AB may assess and buyer agrees to pay a late payment charge at the rate of 1% per month (12% per year) or the maximum legal rate, whichever is less, of the amount due from the due date to the date of payment. If AB retains a collection agency or attorney to collect unpaid amounts, AB may invoice buyer for, and buyer will pay, all reasonable costs of collection, including without limitation reasonable attorneys fees. Buyer hereby grants to AB and AB reserves a purchase money security interest in all tangible Product purchased from AB, and in any proceeds thereof, for all amounts owing to AB for or related to such Product. Upon request by AB, buyer shall sign any reasonable documents required for AB to perfect such security interest and, to the fullest extent permitted by law, buyer hereby expressly grants AB authority and a limited power of attorney to file financing statements and amendments thereto for and on behalf of buyer for such Product and any proceeds thereof. Payment in full of all amounts owed for and related to such Product shall release such security interest in the Product and proceeds.

**3. CREDIT TERMS.** AB may, at any time and in its sole discretion, limit or cancel the credit of buyer as to time and amount, suspend shipments, demand payment in cash before delivery of Product, or demand other assurances of buyer's performance. If buyer fails to agree and comply with the different terms of payment demanded, or fails to give adequate assurances of performance, AB may, without prejudice to any other right or remedy AB may have: (i) by notice to buyer, treat such failure or refusal as a repudiation by buyer of that portion of buyer's order not then fully performed, whereupon AB may cancel all further deliveries, and any amounts unpaid for non-cancelled Product shall immediately become due and payable; or (ii) make shipments under reservation of a security interest and demand payment against tender of title documents.

**4. ACCEPTANCE OF ORDERS, DELIVERY, TITLE AND RISK OF LOSS, INSTALLATION.** AB may accept or reject any buyer purchase order for Product in whole or in part. If a purchase order is accepted, AB will use reasonable efforts to ship tangible Product or perform services, including equipment installation if agreed to by AB, subject to the purchase order within a reasonable time after ordered, or if a shipment, service commencement or installation date is indicated in AB's Quotation or otherwise agreed upon in writing by an authorized representative of AB, on or before such date. AB may make delivery in installments, and each installment shall be deemed to be a separate sale. AB may render a separate invoice for each installment, which invoice shall be paid without regard to prior or subsequent installments. Unless indicated otherwise in AB's Quotation, title and risk of loss with respect to all Products except Products that are software or services, and risk of loss with respect to software, shall pass from AB to buyer upon transfer of possession of the Product to a common or other third party carrier at AB's facility. If AB has undertaken to install a Product, it is buyer's responsibility, at buyer's cost, to have the installation site prepared and available for installation free of hazardous or unsafe conditions and, unless AB otherwise agrees, to move the Product, uncrated, from the buyer's delivery dock or receiving location to the table top or other place of installation. Buyer shall not assign AB personnel to work in biosafety level 3 or level 4 laboratories without prior written notice to AB and AB's consent.

**5. CANCELLATION AND DEFERRAL.** BUYER MAY NOT CANCEL ANY PURCHASE ORDER. However, unless otherwise stated in AB's Quotation, buyer may defer the shipment date one time for up to 60 days for instruments and other hardware, and up to 30 days for reagents, consumables and other tangible Product, by giving written notice to AB at least 30 days before the scheduled shipment date for instruments and other hardware, and at least 10 days before the scheduled shipment date for other Product.

**6. REJECTION AND RETURN OF GOODS.** Any claims for damaged, missing or defective Product must be reported in writing by buyer within 15 days from the date of buyer's receipt of the Product. In addition, buyer must promptly return a rejected Product to AB, C.O.D., unused and in a condition no worse than that delivered to buyer and in the Product's original containers and packing material, accompanied by a valid return authorization number obtained from AB. AB may refuse any Product not timely rejected or sought to be returned without a valid return authorization number. For any valid claim timely made, AB, at its option, may repair the Product or replace the Product with an identical or substantially similar Product. Shipping charges will not be credited. **THESE ARE BUYER'S SOLE AND EXCLUSIVE REMEDIES FOR DAMAGED OR MISSING PRODUCT, AND, EXCEPT FOR EXPRESS WRITTEN WARRANTY RIGHTS, FOR DEFECTIVE PRODUCT.** AB may require that buyer sign and deliver a properly completed certificate of decontamination prior to returning any Product.

**7. LIMITED WARRANTY.** AB makes only those warranties with respect to Product expressly identified as "warranties" and set forth in AB's current operating manual or catalog, or in a specific written warranty included with and covering Product, if any. Warranties are made only to the buyer purchasing the Product directly from AB, are not transferable and do not extend to the benefit of any other person or entity, unless otherwise expressly stated in writing by AB. **ANY PRODUCT NOT COVERED BY AN EXPRESS WRITTEN WARRANTY IS SOLD AND PROVIDED "AS IS" WITHOUT WARRANTY OF ANY KIND, STATUTORY, EXPRESS OR IMPLIED.** Any description of Product recited in AB's Quotation is for the sole purpose of identifying Product, and any such description is not part of any contract between AB and buyer and does not constitute a warranty that Product shall conform to that description. Any sample or model used in connection with AB's Quotation is for illustrative purposes only, and is not part of any contract between AB and buyer and does not constitute a warranty that Product will conform to the sample or model. No affirmation of fact or promise made by AB, whether or not in AB's Quotation, shall constitute a warranty that Product will conform to the affirmation or promise. Unless otherwise specified in writing in documentation shipped with Product or otherwise agreed by AB in writing, AB does not provide service or support

for custom products or other products made to buyer's specifications. **THE WARRANTIES IDENTIFIED IN THE FIRST SENTENCE OF THIS PARAGRAPH ARE AB'S SOLE AND EXCLUSIVE WARRANTIES WITH RESPECT TO PRODUCT AND ARE IN LIEU OF ALL OTHER WARRANTIES, STATUTORY, EXPRESS OR IMPLIED, ALL OF WHICH OTHER WARRANTIES ARE EXPRESSLY DISCLAIMED, INCLUDING WITHOUT LIMITATION ANY IMPLIED WARRANTY OF MERCHANTABILITY, FITNESS FOR A PARTICULAR PURPOSE, NON-INFRINGEMENT, OR REGARDING RESULTS OBTAINED THROUGH THE USE OF ANY PRODUCT (INCLUDING, WITHOUT LIMITATION, ANY CLAIM OF INACCURATE, INVALID OR INCOMPLETE RESULTS), WHETHER ARISING FROM A STATUTE OR OTHERWISE IN LAW OR FROM A COURSE OF PERFORMANCE, DEALING OR USAGE OF TRADE.**

## **8. INTELLECTUAL PROPERTY AND RELATED INDEMNITY.**

**8.1 BY AB.** Subject to the restrictions set forth in this Section 8 and provided buyer complies with its obligations in this Section 8, AB agrees to defend buyer, and indemnify buyer from and against any infringement damages finally awarded, in any legal action or proceeding brought by a third party against buyer to the extent that such action is based on a claim that the manufacture and sale of a Product by AB infringes any United States or foreign patent, copyright, trademark or other intellectual property right of such third party if AB had actual knowledge of such intellectual property right and infringement at the time of delivery of the Product to buyer. Notwithstanding the foregoing, AB shall have no liability or obligation under this Section 8 with respect to any claim of infringement based upon: (i) modifications to any Product made by buyer or a third party; (ii) manufacture, assembly, labeling or branding of Product by AB pursuant to specifications or designs or requests for specific labeling or branding furnished by buyer. Notwithstanding anything herein to the contrary, AB shall have no indemnification obligations with respect to Product originating from a third party and provided under these Terms. Buyer's sole right to indemnification with respect to such third party Product shall be pursuant to the original manufacturer's or licensor's indemnification obligations, if any, to the extent provided by the original manufacturer or licensor.

**8.1.1 Buyer's Obligations.** Buyer must notify AB in writing of any claim for which it may seek defense and indemnity from AB hereunder promptly after becoming aware of such claim, make no admission of liability with respect to the claim, and cooperate with and provide reasonable assistance to AB, at AB's expense with respect to reasonable out of pocket expenses paid by buyer to third parties for such assistance, in the defense or settlement of such claim. AB shall have sole authority to defend and/or settle any claim under this Section 8. AB's obligations under this Section 8 are contingent upon buyer's compliance with all of the foregoing.

**8.1.2 Remedy for Infringement, Rights of AB, Exceptions.** If any Product or portion thereof is subject to a suit or other legal proceeding claiming that the Product or such portion infringes a third party's intellectual property right, or in AB's opinion is (are) likely to become subject of such a claim, AB shall, at its option, have the right to either: (a) procure for buyer the right to continue using the Product; or (b) modify the Product so that it becomes non-infringing; or (c) require buyer to return the Product and upon return, refund to buyer the price actually paid by buyer for the Product, less a reasonable amount for use, damage and obsolescence; or (d) substitute for the alleged infringing Product other suitable, non-infringing Products with comparable functionality.

**8.1.3 ENTIRE LIABILITY. THE FOREGOING STATES THE ENTIRE LIABILITY OF AB, AND THE EXCLUSIVE REMEDY OF BUYER, FOR ANY INFRINGEMENT OR CLAIMED INFRINGEMENT OF PATENT, COPYRIGHT, TRADE SECRET OR ANY OTHER INTELLECTUAL PROPERTY RIGHT BY OR IN CONNECTION WITH ANY PRODUCT.**

**8.2 BY BUYER FOR BUYER'S MODIFICATIONS OR SPECIFICATIONS.** If buyer modifies any Product or furnishes AB with specifications or designs or requests for specific labeling or branding, buyer agrees to defend, indemnify and hold AB harmless against all liabilities, damages, costs, expenses and claims arising from or based upon buyer's modifications or AB's manufacture and sale of Product or other performance in compliance with such specifications or designs or requests for labeling or branding.

**9. COMPLIANCE WITH LAWS, USE OF PRODUCT, VALIDATION.** Without limiting the generality of the paragraph above entitled "LIMITED WARRANTY," unless otherwise expressly stated in writing by AB, no claim or representation is made or intended (i) as to any clinical use of any Product (whether diagnostic, prognostic, therapeutic, blood banking or any other clinical use), (ii) that any Product has been cleared, approved, registered or otherwise qualified (collectively, "Approval") by AB with any regulatory agency for use in any clinical procedure or for other use requiring compliance with any federal, state, provincial, European or any other governmental agency or regulatory body regulating diagnostic, therapeutic, blood or other clinical products, medical devices or similar products (collectively, "Regulatory Laws"), (iii) that any Product will satisfy the requirements of any governmental body or other organization, including, but not limited to, the United States Food and Drug Administration or the International Organization for Standardization, or (iv) that any Product or its performance is suitable or has been validated for any specific use or application. Product should not be used for any purpose that would require Approval unless proper Approval is obtained, or, in the case of use in diagnostic laboratory systems and then only to the extent permitted by law, the laboratory has validated its complete system as required by the Clinical Laboratory Improvements Act of 1988, as amended, in the United States or equivalents in other countries. Buyer agrees that if it elects to use Product for a purpose that would subject buyer, its customers or any Product to the jurisdiction of Regulatory Laws or other applicable law, buyer shall be solely responsible for obtaining any required Approvals or other approvals and otherwise ensuring that its use of any Product complies with such laws. Unless otherwise expressly stated in writing, Products have not been tested by or for AB for any particular use or purpose, or for safety or efficacy. Buyer agrees that it is buyer's responsibility, and not AB's, to validate the performance of Products for any specific use or application and to ensure that Products meet applicable regulatory, certification, validation or its other requirements, since the use and performance characteristics of Products have not been validated by AB for any specific use or application, except as may be otherwise expressly set forth by AB in writing. Product should be used in strict accordance with applicable instructions, warnings and other information in user manuals and other Product documentation.

**10. FORCE MAJEURE.** AB shall not be liable for any delay or failure of performance, including without limitation failure to deliver or failure to install, where such delay or failure arises or results from any cause beyond AB's reasonable control, including, but not limited to, flood, fire, explosion, natural catastrophe, military operations, blockade, sabotage, revolution, riot, civil commotion, war or civil war, plant breakdown, computer or other equipment failure, unusually severe weather, earthquake or other act of God, power loss or reduction, strike, lock-out, boycott or other labor disputes of any kind (whether relating to its own employees or others), embargo, governmental regulation or an inability or delay in obtaining materials. In the event of any such delay or failure of performance, AB shall have such additional time within which to perform its obligations hereunder as may be reasonably necessary under the circumstances; and AB shall also have the right, to the extent necessary in AB's reasonable judgment, to apportion Product then available for delivery fairly among its various customers in such manner as AB may consider equitable.

**11. LIMITATION OF LIABILITY. TO THE FULLEST EXTENT ALLOWED BY LAW, IN NO EVENT SHALL AB BE LIABLE, WHETHER IN CONTRACT, TORT, STRICT LIABILITY, NEGLIGENCE, WARRANTY, OR UNDER ANY STATUTE OR ON ANY OTHER BASIS FOR ANY SPECIAL, INCIDENTAL, INDIRECT, EXEMPLARY, PUNITIVE, MULTIPLE OR CONSEQUENTIAL DAMAGES SUSTAINED BY BUYER OR ANY OTHER PERSON OR ENTITY ARISING OUT OF OR CAUSED BY PRODUCT, AB'S**

**PERFORMANCE OR FAILURE TO PERFORM ITS OBLIGATIONS RELATING TO THE PURCHASE OF PRODUCT OR PERFORMANCE OF SERVICES, AB'S BREACH OF THESE TERMS, THE POSSESSION OR USE OF ANY PRODUCT, OR THE PERFORMANCE BY AB OF ANY SERVICES, WHETHER OR NOT FORESEEABLE AND WHETHER OR NOT AB IS ADVISED OF THE POSSIBILITY OF SUCH DAMAGES, INCLUDING WITHOUT LIMITATION DAMAGES ARISING FROM OR RELATED TO LOSS OF USE, LOSS OF DATA, DOWNTIME, PROCUREMENT OF SUBSTITUTE GOODS OR SERVICES, OR FOR LOSS OF REVENUE, PROFITS, GOODWILL, OR BUSINESS OR OTHER FINANCIAL LOSS.**

**12. SOLE TERMS; INCONSISTENCIES; ORDER OF PRECEDENCE.** These Terms, together with AB's Quotation, any applicable label license or patent statement or other written conditions of use, any other terms and conditions expressly agreed to in writing by an authorized representative of AB "(collectively, "AB's Terms"), and buyer's statement on its purchase order (if accepted by AB) of the name or identity of the Product(s) purchased, quantity, delivery date, bill to and ship to address and, if accurate, price (and only such information on buyer's purchase order), constitute the complete, exclusive and entire agreement between AB and buyer with respect to purchases of Product (unless other terms and conditions are expressly designated to be applicable by AB in writing), and AB's offer to sell Product is expressly limited to such terms. Such terms shall take precedence over and supersede and replace all prior or contemporaneous understandings or agreements, written or oral, and any of buyer's additional or different terms and conditions, which are hereby rejected and shall be void. Buyer's submission of a purchase order or other instrument for or regarding the purchase of Product, whether or not in response to an AB Quotation, shall be deemed acceptance of and agreement to AB's Terms to the exclusion of any other terms and conditions appearing in or referenced in such purchase order (except the name or identity of products purchased, quantity, delivery date, bill to and ship to address and, if accurate, price) or other instrument, which are hereby deemed to be material alterations and notice of objection to which is hereby given, notwithstanding anything contained to the contrary in buyer's purchase order or other instrument or elsewhere. Any acceptance by AB of any offer of buyer is expressly conditioned on buyer's assent to and acceptance of AB's Terms to the extent they are additional or different terms from those of buyer's offer. Except as otherwise provided in these Terms, in the event of an inconsistency between these Terms and the terms appearing on AB's Quotation or other agreement signed by an authorized representative of AB, the terms appearing on AB's Quotation or such other agreement shall supersede and take precedence over the inconsistent provision(s) of these Terms, and all other provisions of these Terms shall remain in full force and effect.

**13. NO IMPLIED RIGHTS.** Nothing in these Terms shall be deemed or construed (i) as a license or grant of any intellectual property rights, whether express, implied, by estoppel or otherwise; (ii) to limit AB's rights to enforce its patent or other intellectual property rights, including, without limitation, as to use of any Product beyond that granted under any patent or other intellectual property label license or statement applicable to the Product; (iii) as granting buyer any right to be supplied with any Product or component thereof beyond those ordered by buyer and supplied by AB in accordance with these Terms; or (iv) as a license or grant of any right to buyer to manufacture or to have manufactured any Product.

**14. CHOICE OF LAW.** Any contract between AB and buyer relating to Product, including these Terms, and any disputes relating thereto, shall be governed by and construed in accordance with the laws of the State of California, U.S.A., excluding both its choice of law provisions and the United Nations Convention on Contracts for the International Sale of Goods.

**15. EXPORT CONTROLS.** Buyer agrees that it will not export or transfer Product for re-export in violation of any United States laws or the laws of any other jurisdiction, or to any denied or prohibited person, entity, or embargoed country in violation of such laws.

**16. MISCELLANEOUS.** No amendment of AB's Quotation or these Terms or modification thereof shall be binding unless in writing and signed by a duly authorized representative of both AB and buyer. AB's failure to exercise any rights hereunder shall not constitute or be deemed a waiver or forfeiture of such rights or any other rights hereunder. Headings are included herein for convenience of reference only and shall not constitute a part of these Terms for any other purpose. If any provision of these Terms shall be held to be invalid or unenforceable for any reason, such provisions shall, to the extent of such invalidity or enforceability, be severed without in any way affecting the remainder of such provision or any other provision thereof, all of which shall continue in full force and effect.

**17. ADDITIONAL TERMS AND CONDITIONS OF SALE FOR OLIGONUCLEOTIDE PRODUCTS, INCLUDING SPECIAL TERMS TO PROTECT CUSTOMER CONFIDENTIAL INFORMATION.** THE FOLLOWING TERMS AND CONDITIONS OF SALE FOR PRODUCTS THAT ARE OLIGONUCLEOTIDE PRODUCTS, IN ADDITION TO ALL OF THE TERMS AND CONDITIONS OF SALE SET FORTH ABOVE, APPLY TO THE PURCHASE AND SALE OF ALL AB SCIEX OLIGONUCLEOTIDE PRODUCTS, INCLUDING TAQMAN® ASSAYS, TAQMAN® LOW DENSITY ARRAYS AND CUSTOM OLIGONUCLEOTIDE SYNTHESIS PRODUCTS.

**17.1 DEFINITIONS.** The following definitions apply to these Additional Terms and Conditions of Sale for Oligonucleotide Products.

"Confidential Information of Buyer" means each Nucleic Acid Sequence specified by buyer in writing to AB that is intended to be detected by use of a Custom Product or to be included in primers and probes or other oligonucleotide Products manufactured by AB and sold to buyer, and the facts that buyer placed orders for Products containing or intended to detect such sequence and that buyer ordered oligonucleotide Products from AB containing or intending to detect such sequence.

"Custom Product" means (i) an Oligonucleotide Kit that is intended to detect a Nucleic Acid Sequence specified by buyer, or (ii) primers and probes or any other oligonucleotide Product that includes a Nucleic Acid Sequence, or other non-off-the-shelf elements or features, specified by buyer.

"Nucleic Acid Sequence" means the nucleic acid sequence of a genome intended to be detected by use of an Oligonucleotide Kit or that is specified as being included in other oligonucleotide Products.

"Oligonucleotide Kit" means a Product that consists of a combination of reagents and other products that includes at least one oligonucleotide based primer or probe, that is sold by AB as an assay kit, and the use of which is intended to detect at least one specific nucleic acid sequence in a sample.

"Synthesis" means the design (where applicable) or manufacture by AB of Custom Kits or other oligonucleotide Products for delivery to buyer.

**17.2 AB'S EVALUATION OF CUSTOM KIT ORDERS.** AB may decline the Synthesis, at any stage of the Synthesis process, of any Custom Product ordered by buyer that AB deems to be unsuitable or commercially impractical for Synthesis, whether on technological, cost or other grounds. AB will give written notice to buyer within a reasonable time following its determination to decline Synthesis of a Custom Product. Buyer shall have no obligation to pay any fees for time and materials, or for any other expenses incurred by AB, in connection with any declined Custom Product. All Custom Product orders not declined by AB must be paid for by buyer, and orders may not be cancelled or changed by buyer without the written consent of AB. Buyer understands and agrees that buyer's obligation to pay for all Custom Products that AB proceeds to Synthesize and deliver is firm and irrevocable, regardless of the number of Custom Products declined for Synthesis in a given order. Each purchase order for Custom Products must be for the total amount payable for all Custom

Products ordered. The amount corresponding to the charges applicable to declined Synthesis will be reflected in AB's invoice for the order.

**17.3 BUYER'S REPRESENTATIONS.** By submitting an order, buyer represents, warrants and agrees that

(i) buyer will provide AB with all information known to buyer regarding biological, radiological, and chemical hazards associated with the handling, transport, exposure to or other use of any materials supplied to AB by buyer;  
(ii) buyer has the right to cause the sequences that buyer has requested AB to manufacture to be manufactured by AB and sold to buyer, that such sequences and the manufacture and sale thereof to buyer will not infringe or result from the misappropriation of the intellectual property rights, including without limitation patent, copyright, trademark and trade secrets, of any third party anywhere in the world (provided that the foregoing shall not be deemed a representation or warranty with respect to methods of manufacture employed by AB), and that the materials buyer furnishes to AB will not infringe or result from the misappropriation of any such intellectual property rights; and  
(iii) the oligonucleotide Products and components thereof sold to buyer shall be for buyer's own internal research and development use only and shall not be resold or otherwise transferred or conveyed to any third party without the prior express written consent of AB.

**17.4 CONFIDENTIAL INFORMATION OF BUYER.** AB agrees that for seven (7) years after the disclosure by buyer to AB of Confidential Information of Buyer, AB shall not disclose such Confidential Information of Buyer to any third party and will use at least the same degree of care as it uses to protect its own confidential information of a like nature, but in no event less than a reasonable degree of care, to prevent the disclosure of such Confidential Information of Buyer to any third party. This undertaking of confidentiality shall not apply to, and AB shall have no obligations under this paragraph with respect to, any Confidential Information of Buyer that (a) was in AB's possession before receipt from buyer, (b) is or becomes a matter of public knowledge or part of the public domain through no fault of AB, (c) is rightfully received by AB from a third party that was not obliged to keep such information confidential, (d) is developed by AB without reference to Confidential Information of Buyer, or (e) is disclosed by AB with buyer's prior written approval. Notwithstanding the foregoing, AB may disclose Confidential Information of Buyer to the extent required to comply with governmental regulations and other applicable laws or to respond to subpoena or other compulsory legal process, provided in all cases that AB takes reasonable and lawful actions to avoid or minimize the extent of such disclosure and notifies buyer in writing as far in advance of the date of disclosure as is reasonably feasible so that buyer to the extent feasible will have an opportunity to seek to prevent or limit disclosure.

**17.5 INTELLECTUAL PROPERTY RIGHTS.** Any inventions (patentable or otherwise), discoveries, developments, improvements, information, data, compounds, formulae, know-how or other results that are conceived, developed, discovered, reduced to practice, or generated by or for AB or jointly by buyer and AB and that relate or apply to the processes and methods used in or related to the Synthesis of oligonucleotide Products or otherwise in connection with designing or manufacturing oligonucleotide Products, including without limitation primers and probes, shall be and remain the sole and exclusive intellectual property of AB Sciex Pte. Ltd., a limited liability company organized under the laws of Singapore ("AB SCIEX Pte") or one of its affiliates, as applicable and buyer hereby transfers and assigns all of its right, title and interest in and to any such joint intellectual property to AB SCIEX Pte. Buyer will take reasonable steps, upon the request and at the expense of AB SCIEX Pte, to assist AB to secure, evidence and record AB SCIEX Pte's rights in such intellectual property.

# API 4000™

LC/MS/MS System

The standard for pharmaceutical quantitation

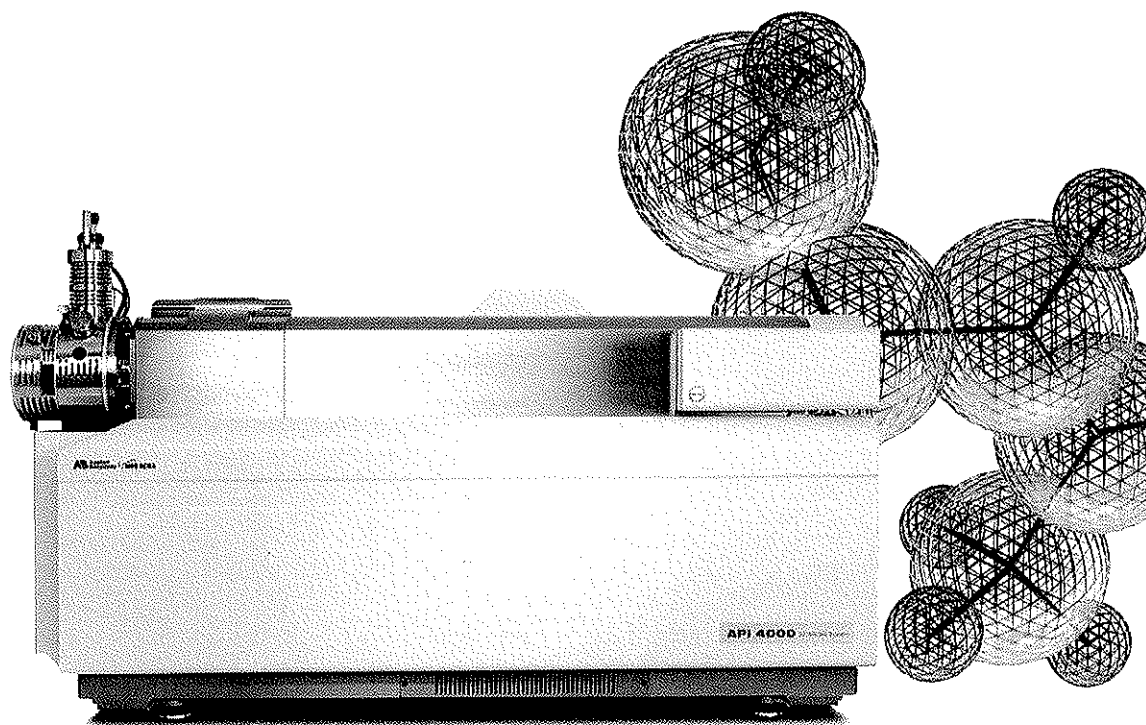

# The industry standard for high-performance quantitation and identification

Performance at the highest level requires a company with solid experience and a sound knowledge of the drug development challenges that scientists face. Applied Biosystems/MDS SCIEX has served the pharmaceutical industry since 1989 with state-of-the-art technology and increasingly more powerful triple quadrupole mass spectrometers. The industry-standard API 4000™ LC/MS/MS system brings powerful, proven performance to every phase of pharmaceutical development—from drug discovery to clinical trials.

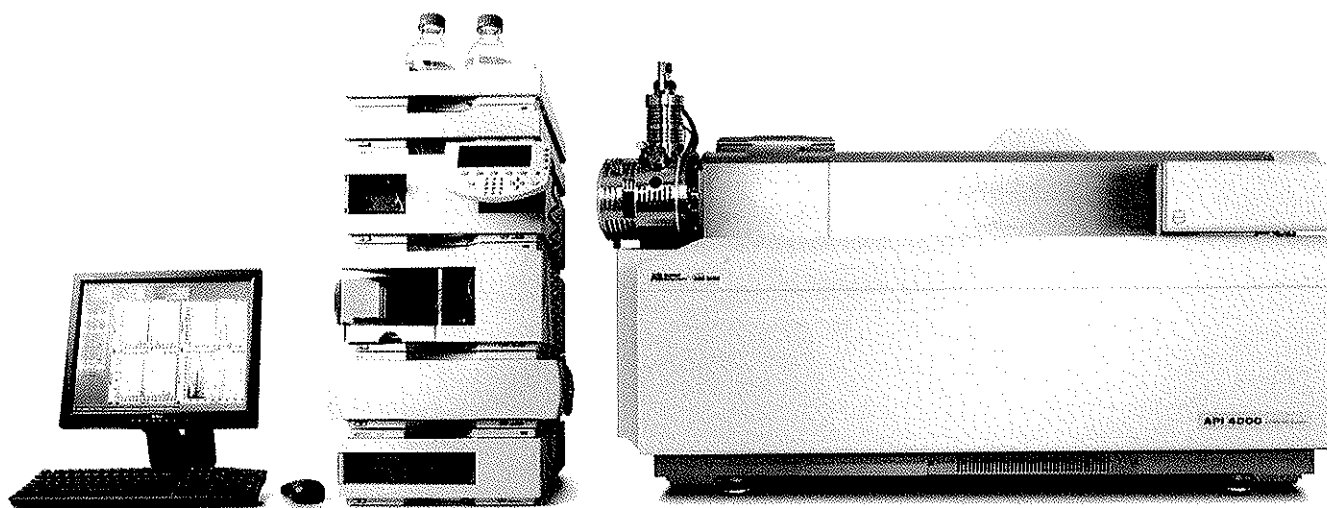

### Proven Performance, Reliable Results

Drug development scientists have consistently relied on Applied Biosystems/MDS SCIEX for top-performing mass spectrometry systems. The API 4000™ system addresses the most pressing drug development challenges, whether you are a novice or an expert user. The system's superior sensitivity also ensures low detection limits for trace analysis of pesticide/drug residues in food and environmental samples, forensic toxicology, and clinical research applications.

The API 4000 LC/MS/MS system established the standard of performance, reliability, and dependability for the pharmaceutical industry. It delivers the sensitive results for drug development and features improved robustness and throughput for enhanced efficiency.

### Superior Quantitation and Identification

The API 4000™ LC/MS/MS system brings outstanding performance for quantitation and identification of low abundance compounds in complex matrices. Through every phase of the pharmaceutical development process, from discovery to clinical trials, the API 4000 system can help you deliver new products to market sooner.

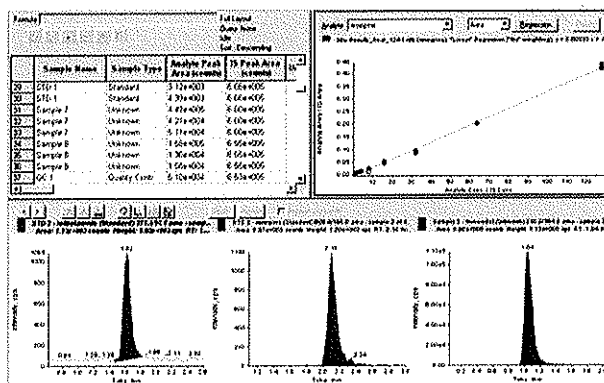

Superior quantitative results require a superior system. The industry-standard API 4000™ system with Analyst® software provides rapid access to information and ensures the success of your lab.

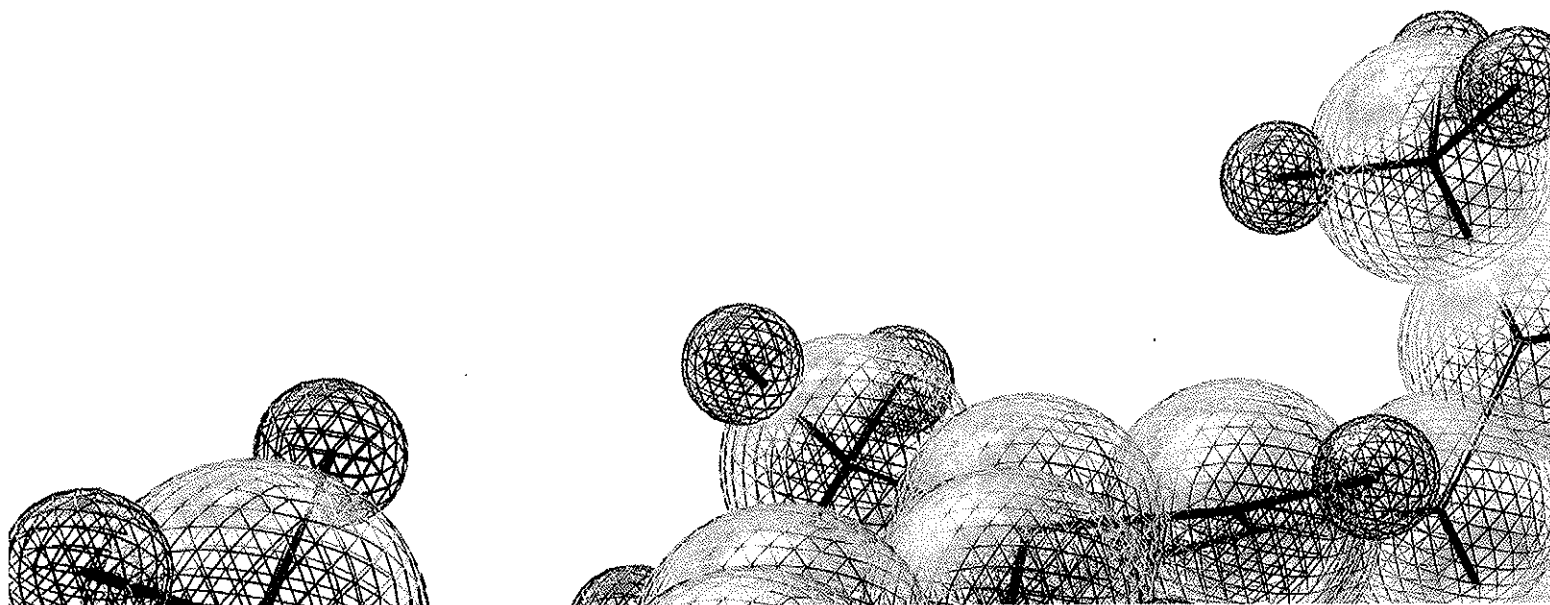



# Optimized Ion Path

Higher throughput—from the advanced ion source to the reliable interface to the patented LINAC® collision cell, the ion path is designed to accelerate productivity.

API 4000™ LC/MS/MS System Ion Path

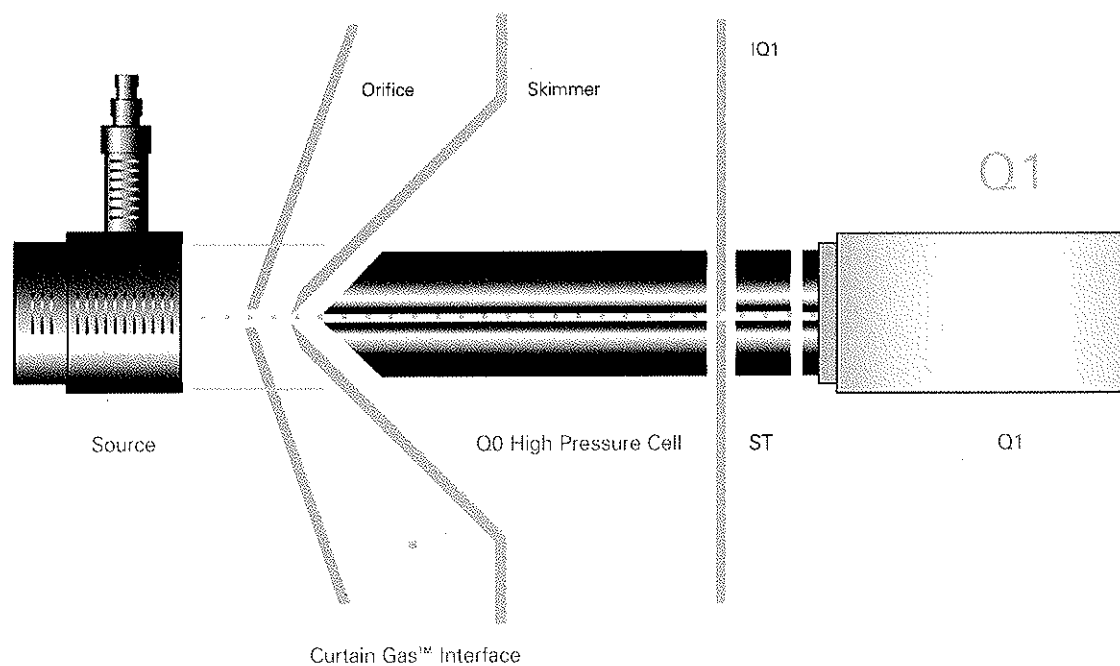

## Plug-and-Play Probes

Easy to use—The Turbo V™ source permits rapid change between APCI (atmospheric pressure chemical ionization) and TurbolonSpray® probes for effortless flexibility.

## Innovative Turbo V™ Source

Superior detection limits—improved ionization efficiency, reduced chemical noise, and enhanced gas dynamics enable remarkably low levels of quantitation, even at flow rates as high as 3 mL/min.

## Pristine Ceramic Interface

Unparalleled ruggedness—proven Curtain Gas™ interface technology combined with improved gas dynamics in the housing reduces maintenance and increases uptime.

## Rugged, Reliable Operation

In the API 4000™ system, the innovative APCI probe design significantly reduces peak tailing from cross-contamination and other sources of chemical noise. Absorptive residues are completely eliminated because samples are instantly vaporized at higher temperatures, resulting in less thermal degradation and reduced ionization suppression that improves sensitivity and throughput even at flow rates up to 3 mL/min. The self-cleaning probe's rugged reliability ensures uninterrupted operation and repeatability—day in and day out.

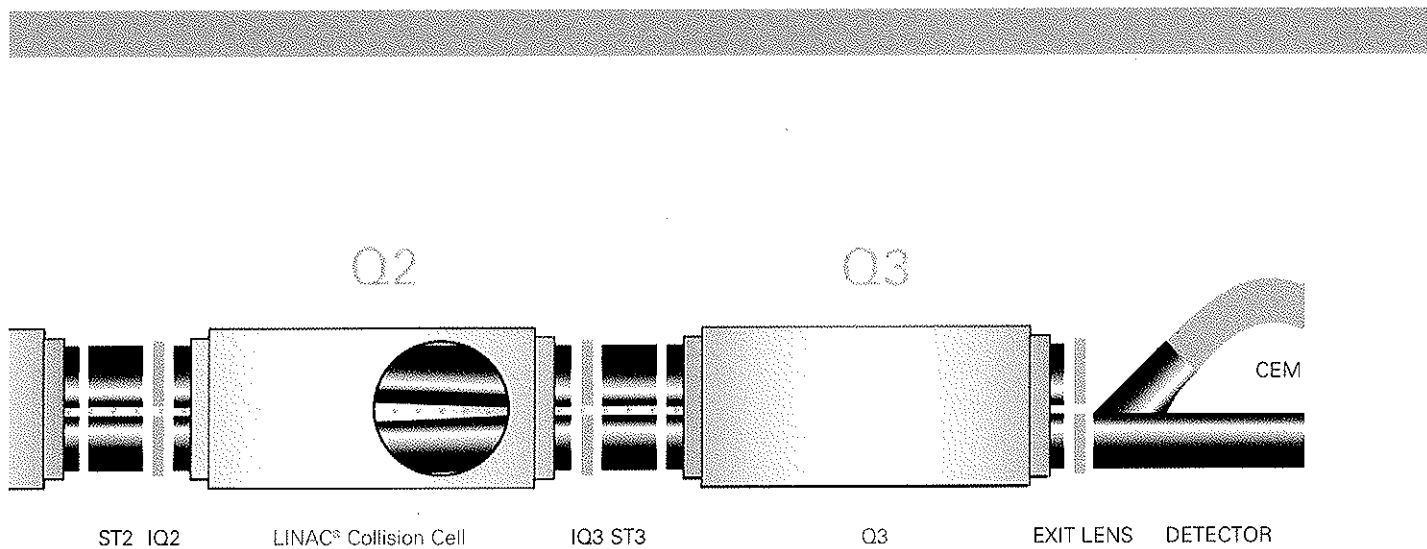

### Unique Collision Cell Design

Patented LINAC<sup>®</sup> high-pressure collision cell technology used in the API 4000<sup>™</sup> system ensures maximum ion transfer from the interface to the detector in MS/MS mode. The LINAC collision cell enables fast scanning without compromising performance in all modes of MS/MS operation, including multiple reaction monitoring (MRM), product ion scan, precursor ion scan, and neutral loss scan. For quantitative applications, the advantages of the LINAC collision cell translate into multiple component analysis in a single-period MRM experiment. In qualitative applications, the LINAC collision cell enables faster precursor ion and neutral loss scans with excellent sensitivity and resolution.

### Dependable Digital Pulse-counting Detector

The sensitive pulse-counting detector in the API 4000 system provides consistent quantitative results over a wide dynamic range day after day. The consistent, reproducible intra-day and inter-day results let you quickly validate even your most difficult assays.

# Greater sensitivity and ease-of-use make all the difference

Advanced source design features highly efficient ionization probes

## Turbo V™ Source Improves Lab Results

The Turbo V source for the API 4000™ system maximizes ionization efficiency by combining embedded ceramic heater technology with improved gas dynamics. The increased ion yield in the gas phase translates into greater sensitivity. The dual heaters in the Turbo V source provide greater efficiency in ionization over the wide range of liquid flow rates used in drug metabolism and pharmacokinetic (DMPK) analysis. Improved heat transfer and gas dynamics provide a tenfold increase in sensitivity.

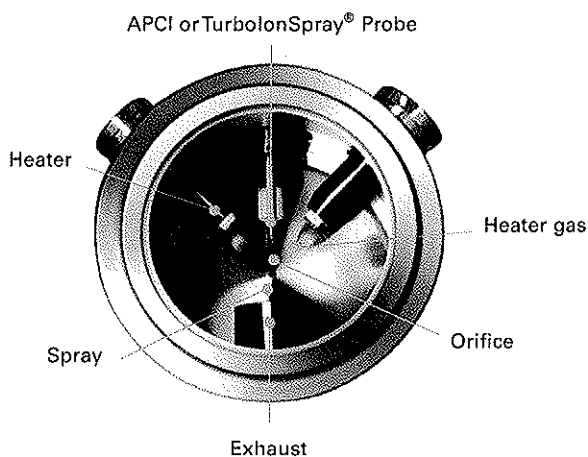

With the advanced Turbo V™ source, you can switch between APCI and TurbolonSpray® probes in seconds. Determining the optimal ionization technique during method development is now simpler and faster.

## Higher Sensitivity

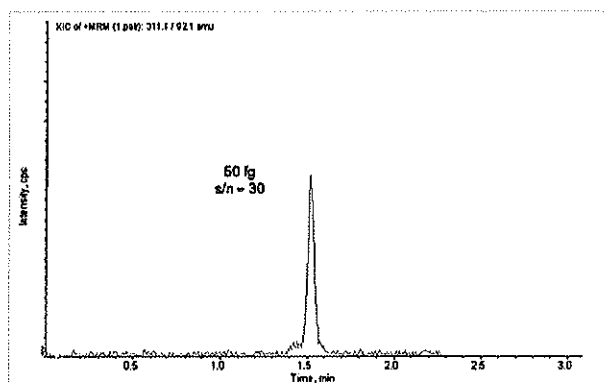

The TurbolonSpray® probe significantly increases sensitivity at high flow rates, up to 3 mL/min, without flow splitting.

## Higher Throughput

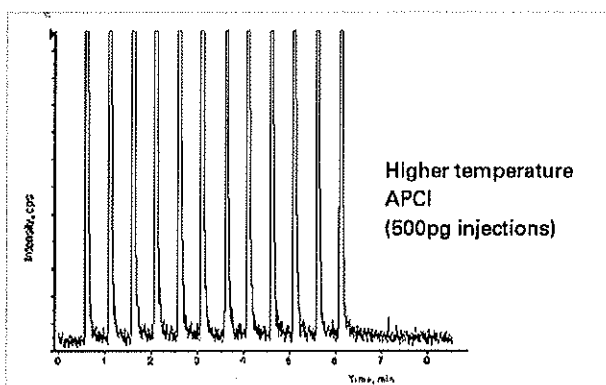

The Turbo V™ source virtually eliminates cross-contamination, even with large sample loads. Injection of 5-fluorouracil every 30 seconds demonstrates no discernible peak tailing.

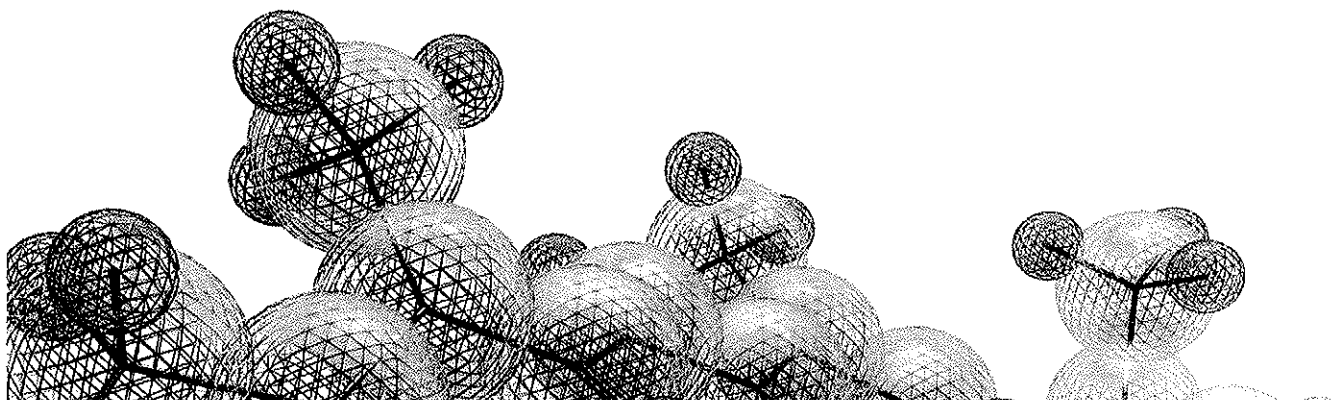

# High throughput for the networked lab

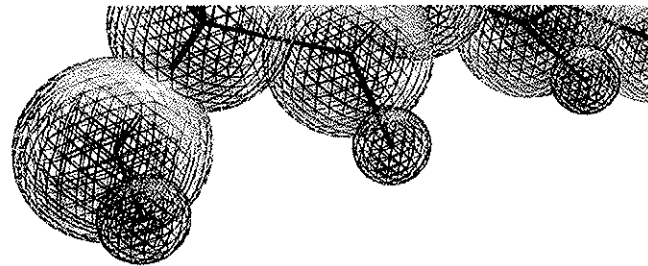

## Analyst® Software for Quantitation

Windows® platform-based Analyst software is the industry standard for high-throughput quantitation. Analyst software also helps laboratories working in regulated environments by providing easy database searching, traceability, and the most comprehensive suite of features available to assist with 21 CFR Part 11 compliance—complete, role-based security, auditing, and electronic records compliance. The software's core functions enable the user of the API 4000 system to configure, tune, acquire, explore, and quantitate with superior results from any matrix.

Analyst® software provides powerful tools for automating method development, data analysis, review, and reporting:

- Quantitative optimization—for easy creation of fully optimized methods for multiple compounds
- Intelligent integration—new, parameter-free algorithms reduce time spent revising and reviewing results
- Centralized security management—power and flexibility in one easy-to-use console provides the finest security model for regulated labs
- Powerful auditing features—complete, easily managed auditing tools give you project-based auditing on your terms, for all levels of compliance
- Slide Show—for quick review of peak integration
- Metric Plot—for clear visualization of results and trends
- Direct network acquisition—eliminate manual file management and enhance your data security by acquiring data directly over your network
- Support for your workflow—from LIMS to processing tools, Analyst software has the flexibility to be integrated quickly into your environment

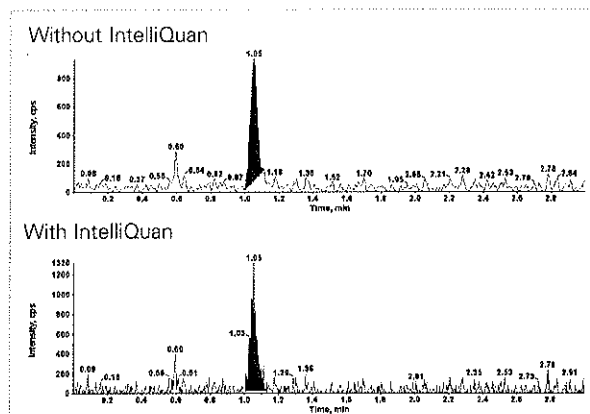

The IntelliQuan integration algorithm provides a new level of confidence in automatic integration. Produce high quality results without having to set integration parameters in advance. IntelliQuan minimizes manual intervention during integration and speeds up data review, reducing your data analysis time to improve your lab's productivity.

## Versatile Software Tools

The automated add-on applications for Analyst® software—IDA, Metabolite ID, and Automaton—extend its functionality. The IDA application maximizes the MS and MS/MS information generated from a single run. Using IDA with triple quadrupole systems, you obtain unprecedented selectivity of candidate ion species when precursor ion and neutral loss scans are used in the decision-making process. The Metabolite ID application automates data acquisition and processing for metabolite profiling. The Automaton application easily performs automated, unattended optimization and quantitative analyses of samples from drug discovery and development experiments. Applied Biosystems/MDS SCIEX continues to develop systems and software that produce higher-quality data, so you can make better-informed decisions and arrive at discoveries faster.

# Put the industry standard API 4000™ LC/MS/MS system to work for you

Mass spectrometry is a critical and core enabling technology for the life sciences. From basic research to drug discovery and development, clinical research, forensic, food, and environmental analysis, mass spectrometry-based methods play a key role.

When you choose Applied Biosystems/MDS SCIEX as your partner, you're choosing to work with the leading developer of LC/MS/MS technologies. We are committed to remaining at the forefront of life science research by providing you with the tools you need to succeed.

## Support You Can Depend On—Whenever and Wherever You Need It

Our LC/MS/MS systems are backed by one of the world's most extensive service and support organizations staffed by professionals who are trained and dedicated to keep your system running at peak performance and productivity 24 hours a day, seven days a week.

## Maximize Instrument Uptime with Applied Biosystems BioMonitor® Service

With our BioMonitor Service, we can remotely and proactively track critical system parameters over the Internet and identify potential instrument problems before they affect your lab's efficiency. Using a combination of remote monitoring, preemptive monitoring and remote diagnostics, our award-winning BioMonitor Service is helping many of our customers achieve a significant increase in instrument uptime.

Find out why more labs depend on the API 4000 LC/MS/MS system.

Call the Applied Biosystems sales office nearest you, or visit [www.appliedbiosystems.com/4000](http://www.appliedbiosystems.com/4000).

---

For Research Use Only. Not for use in diagnostic procedures.

Applied Biosystems, AB (Design), and BioMonitor are registered trademarks and Applera is a trademark of Applera Corporation or its subsidiaries in the US and/or certain other countries. Analyst, LINAC, and TurboSpray are registered trademarks and API 4000, Curtain Gas, and Turbo V are trademarks of Applied Biosystems/MDS SCIEX, a joint venture between Applera Corporation and MDS Inc. All other trademarks are the sole property of their respective owners. MDS and SCIEX are registered trademarks of MDS Inc.

© Copyright 2006, Applera Corporation and MDS Inc.

Printed in the USA, 02/2006 Publication 114BR07-02

---



### Headquarters

850 Lincoln Center Drive | Foster City, CA 94404 USA  
Phone 650.638.5800 | Toll Free 800.345.5224  
[www.appliedbiosystems.com](http://www.appliedbiosystems.com)

### International Sales

For our office locations please call the division headquarters or refer to our Web site at [www.appliedbiosystems.com/about/offices.cfm](http://www.appliedbiosystems.com/about/offices.cfm)