



State of West Virginia
 Department of Administration
 Purchasing Division
 2019 Washington Street East
 Post Office Box 50130
 Charleston, WV 25305-0130

Request for Quotation

RFQ NUMBER
DBSM108117

PAGE
1

ADDRESS CORRESPONDENCE TO ATTENTION OF
SHELLY MURRAY
304-558-8801

RFQ COPY

TYPE NAME/ADDRESS HERE

Lee Hartman & Sons, Inc.
3 Davis Court
Hurricane, WV 25526
V 304-397-4100 F 304-397-4101

SHIP TO

SCHOOL FOR THE DEAF & BLIND
RECEIVING DEPARTMENT

301 EAST MAIN STREET
ROMNEY, WV
26757-1894 304-822-4810

DATE PRINTED	TERMS OF SALE	SHIP VIA	FOB	FREIGHT TERMS
06/16/2010	Net 30	Over Truck	Dest	PPD

BID OPENING DATE: **07/22/2010** BID OPENING TIME **01:30PM**

LINE	QUANTITY	UOP	CAT. NO.	ITEM NUMBER	UNIT PRICE	AMOUNT
0001	1	LS		725-55-01-001		\$ 265,000 ⁰⁰
<p>THE WEST VIRGINIA PURCHASING DIVISION FOR THE AGENCY, THE WEST VIRGINIA SCHOOLS FOR THE DEAF AND BLIND, IS SOLICITING BIDS FOR VIDEO CONFERENCEING EQUIPMENT PER THE ATTACHED SPECIFICATIONS.</p> <p>TECHNICAL QUESTIONS MUST BE SUBMITTED IN WRITING TO SHELLY MURRAY IN THE WEST VIRGINIA PURCHASING DIVISION VIA MAIL AT THE ADDRESS SHOWN AT THE TOP OF THIS RFQ, VIA FAX AT 304-558-4115, OR VIA EMAIL AT SHELLY.L.MURRAY@WV.GOV. DEADLINE FOR ALL TECHNICAL QUESTIONS IS 07/08/2010 AT THE CLOSE OF BUSINESS. ALL TECHNICAL QUESTIONS RECEIVED, IF ANY, WILL BE ADDRESSED BY ADDENDUM AFTER THE DEADLINE.</p> <p>TELEPHONE OR VIDEO CONFERENCE EQUIPMENT</p> <p>THE MODEL/BRAND/SPECIFICATIONS NAMED HEREIN ESTABLISH THE ACCEPTABLE LEVEL OF QUALITY ONLY AND ARE NOT INTENDED TO REFLECT A PREFERENCE OR FAVOR ANY PARTICULAR BRAND OR VENDOR. VENDORS WHO ARE BIDDING ALTERNATES SHOULD SO STATE AND INCLUDE PERTINENT LITERATURE AND SPECIFICATIONS. FAILURE TO PROVIDE INFORMATION FOR ANY ALTERNATES MAY BE GROUNDS FOR REJECTION OF THE BID. THE STATE RESERVES THE RIGHT TO WAIVE MINOR IRREGULARITIES IN BIDS OR SPECIFICATIONS IN ACCORDANCE WITH SECTION 148-1-4(F) OF THE WEST VIRGINIA LEGISLATIVE RULES AND REGULATIONS.</p>						

RECEIVED
 2010 JUL 21 A 8:23
 PURCHASING DIVISION
 STATE OF WV

SEE REVERSE SIDE FOR TERMS AND CONDITIONS

SIGNATURE: *Randy T. Cox* TELEPHONE: 304-397-4100 DATE: 7-19-2010

TITLE: Assoc. Manager FEIN: 540716364 ADDRESS CHANGES TO BE NOTED ABOVE

WHEN RESPONDING TO RFQ, INSERT NAME AND ADDRESS IN SPACE ABOVE LABELED 'VENDOR'

GENERAL TERMS & CONDITIONS REQUEST FOR QUOTATION (RFQ) AND REQUEST FOR PROPOSAL (RFP)

1. Awards will be made in the best interest of the State of West Virginia.
2. The State may accept or reject in part, or in whole, any bid.
3. Prior to any award, the apparent successful vendor must be properly registered with the Purchasing Division and have paid the required \$125 fee.
4. All services performed or goods delivered under State Purchase Order/Contracts are to be continued for the term of the Purchase Order/Contracts, contingent upon funds being appropriated by the Legislature or otherwise being made available. In the event funds are not appropriated or otherwise available for these services or goods this Purchase Order/Contract becomes void and of no effect after June 30.
5. Payment may only be made after the delivery and acceptance of goods or services.
6. Interest may be paid for late payment in accordance with the *West Virginia Code*.
7. Vendor preference will be granted upon written request in accordance with the *West Virginia Code*.
8. The State of West Virginia is exempt from federal and state taxes and will not pay or reimburse such taxes.
9. The Director of Purchasing may cancel any Purchase Order/Contract upon 30 days written notice to the seller.
10. The laws of the State of West Virginia and the *Legislative Rules* of the Purchasing Division shall govern the purchasing process.
11. Any reference to automatic renewal is hereby deleted. The Contract may be renewed only upon mutual written agreement of the parties.
12. **BANKRUPTCY:** In the event the vendor/contractor files for bankruptcy protection, the State may deem this contract null and void, and terminate such contract without further order.
13. **HIPAA BUSINESS ASSOCIATE ADDENDUM:** The West Virginia State Government HIPAA Business Associate Addendum (BAA), approved by the Attorney General, is available online at www.state.wv.us/admin/purchase/vrc/hipaa.htm and is hereby made part of the agreement. Provided that the Agency meets the definition of a Cover Entity (45 CFR §160.103) and will be disclosing Protected Health Information (45 CFR §160.103) to the vendor.
14. **CONFIDENTIALITY:** The vendor agrees that he or she will not disclose to anyone, directly or indirectly, any such personally identifiable information or other confidential information gained from the agency, unless the individual who is the subject of the information consents to the disclosure in writing or the disclosure is made pursuant to the agency's policies, procedures, and rules. Vendor further agrees to comply with the Confidentiality Policies and Information Security Accountability Requirements, set forth in <http://www.state.wv.us/admin/purchase/privacy/noticeConfidentiality.pdf>.
15. **LICENSING:** Vendors must be licensed and in good standing in accordance with any and all state and local laws and requirements by any state or local agency of West Virginia, including, but not limited to, the West Virginia Secretary of State's Office, the West Virginia Tax Department, and the West Virginia Insurance Commission. The vendor must provide all necessary releases to obtain information to enable the director or spending unit to verify that the vendor is licensed and in good standing with the above entities.
16. **ANTITRUST:** In submitting a bid to any agency for the State of West Virginia, the bidder offers and agrees that if the bid is accepted the bidder will convey, sell, assign or transfer to the State of West Virginia all rights, title and interest in and to all causes of action it may now or hereafter acquire under the antitrust laws of the United States and the State of West Virginia for price fixing and/or unreasonable restraints of trade relating to the particular commodities or services purchased or acquired by the State of West Virginia. Such assignment shall be made and become effective at the time the purchasing agency tenders the initial payment to the bidder.

I certify that this bid is made without prior understanding, agreement, or connection with any corporation, firm, limited liability company, partnership, or person or entity submitting a bid for the same material, supplies, equipment or services and is in all respects fair and without collusion or fraud. I further certify that I am authorized to sign the certification on behalf of the bidder or this bid.

INSTRUCTIONS TO BIDDERS

1. Use the quotation forms provided by the Purchasing Division. Complete all sections of the quotation form.
2. Items offered must be in compliance with the specifications. Any deviation from the specifications must be clearly indicated by the bidder. Alternates offered by the bidder as **EQUAL** to the specifications must be clearly defined. A bidder offering an alternate should attach complete specifications and literature to the bid. The Purchasing Division may waive minor deviations to specifications.
3. Unit prices shall prevail in case of discrepancy. All quotations are considered F.O.B. destination unless alternate shipping terms are clearly identified in the quotation.
4. All quotations must be delivered by the bidder to the office listed below prior to the date and time of the bid opening. Failure of the bidder to deliver the quotations on time will result in bid disqualifications: Department of Administration, Purchasing Division, 2019 Washington Street East, P.O. Box 50130, Charleston, WV 25305-0130
5. Communication during the solicitation, bid, evaluation or award periods, except through the Purchasing Division, is strictly prohibited (W.Va. C.S.R. §148-1-6.6).



State of West Virginia
 Department of Administration
 Purchasing Division
 2019 Washington Street East
 Post Office Box 50130
 Charleston, WV 25305-0130

Request for Quotation

BFO NUMBER
DBSM108117

PAGE
2

ADDRESS CORRESPONDENCE TO ATTENTION OF
**SHELLY MURRAY
 304-558-8801**

RFQ COPY
 TYPE NAME/ADDRESS HERE

**Lee Hartman & Sons, Inc.
 3 Davis Court
 Hurricane, WV 25526
 V 304-397-4100 F 304-397-4101**

**SCHOOL FOR THE DEAF & BLIND
 RECEIVING DEPARTMENT
 301 EAST MAIN STREET
 ROMNEY, WV
 26757-1894 304-822-4810**

DATE PRINTED	TERMS OF SALE	SHIP VIA	F.O.B.	FREIGHT TERMS
06/16/2010	Net 30	Over Truck	Dest	FFO

BID OPENING DATE: **07/22/2010** BID OPENING TIME **01:30PM**

LINE	QUANTITY	UQP	CAT NO	ITEM NUMBER	UNIT PRICE	AMOUNT
<p>EXHIBIT 5</p> <p>WEST VIRGINIA CODE 21-1D-5 PROVIDES THAT: ANY SOLICITATION FOR A PUBLIC IMPROVEMENT CONSTRUCTION CONTRACT REQUIRES EACH VENDOR THAT SUBMITS A BID FOR THE WORK TO SUBMIT AT THE SAME TIME AN AFFIDAVIT OF COMPLIANCE WITH THE BID. THE ENCLOSED DRUG-FREE WORKPLACE AFFIDAVIT MUST BE SIGNED AND SUBMITTED WITH THE BID AS EVIDENCE OF THE VENDOR'S COMPLIANCE WITH THE PROVISIONS OF ARTICLE 1D, CHAPTER 21 OF THE WEST VIRGINIA CODE. FAILURE TO SUBMIT THE SIGNED DRUG-FREE WORKPLACE AFFIDAVIT WITH THE BID SHALL RESULT IN DISQUALIFICATION OF SUCH BID.</p> <p>NOTICE TO PROCEED: THIS CONTRACT IS TO BE PERFORMED WITHIN 60 CALENDAR DAYS AFTER THE NOTICE TO PROCEED IS RECEIVED. UNLESS OTHERWISE SPECIFIED, THE FULLY EXECUTED PURCHASE ORDER WILL BE CONSIDERED NOTICE TO PROCEED.</p> <p>CANCELLATION: THE DIRECTOR OF PURCHASING RESERVES THE RIGHT TO CANCEL THIS CONTRACT IMMEDIATELY UPON WRITTEN NOTICE TO THE VENDOR IF THE MATERIALS OR WORKMANSHIP SUPPLIED ARE OF AN INFERIOR QUALITY OR DO NOT CONFORM WITH THE SPECIFICATIONS OF THE BID AND CONTRACT HERE IN.</p> <p>WAGE RATES: THE CONTRACTOR OR SUBCONTRACTOR SHALL PAY THE HIGHER OF THE U.S. DEPARTMENT OF LABOR MINIMUM WAGE RATES AS ESTABLISHED FOR HAMPSHIRE, ROANE, AND GRANT COUNTIES, PURSUANT TO WEST VIRGINIA CODE 21-5A, ET, SEQ. (PREVAILING WAGE RATES APPLY TO THIS PROJECT)</p> <p>ARBITRATION: ANY REFERENCES MADE TO ARBITRATION OR INTEREST FOR PAYMENTS DUE (EXCEPT FOR ANY INTEREST REQUIRED BY STATE LAW) CONTAINED IN THIS CONTRACT OR IN ANY AMERICAN INSTITUTE OF ARCHITECTS DOCUMENTS</p>						

SEE REVERSE SIDE FOR TERMS AND CONDITIONS

SIGNATURE <i>Ramsey T Cox</i>	TELEPHONE 304-397-4100	DATE 7-19-2010
TITLE Area Manager	FEIN 540 716 361	ADDRESS CHANGES TO BE NOTED ABOVE

WHEN RESPONDING TO RFQ, INSERT NAME AND ADDRESS IN SPACE ABOVE LABELED 'VENDOR'



State of West Virginia
 Department of Administration
 Purchasing Division
 2019 Washington Street East
 Post Office Box 50130
 Charleston, WV 25305-0130

Request for Quotation

RFQ NUMBER
DBSM108117

PAGE
3

ADDRESS CORRESPONDENCE TO ATTENTION OF
SHELLY MURRAY 304-558-8801

RFQ COPY
 TYPE NAME/ADDRESS HERE

Lee Hartman & Sons, Inc.
 3 Davis Court
 Hurricane, WV 25526
 V 304-397-4100 F 304-397-4101

SCHOOL FOR THE DEAF & BLIND
 RECEIVING DEPARTMENT
 301 EAST MAIN STREET
 ROMNEY, WV
 26757-1894 304-822-4810

DATE PRINTED	TERMS OF SALE	SHIP VIA	F.O.B.	FREIGHT TERMS
06/16/2010	Net 30	Over Truck	Dest	PPD

BID OPENING DATE: 07/22/2010 BID OPENING TIME 01:30PM

LINE	QUANTITY	UOP	CAT NO	ITEM NUMBER	UNIT PRICE	AMOUNT
<p>PERTAINING TO THIS CONTRACT ARE HEREBY DELETED.</p> <p>WORKERS' COMPENSATION: VENDOR IS REQUIRED TO PROVIDE A CERTIFICATE FROM WORKERS' COMPENSATION IF SUCCESSFUL.</p> <p>ALL OF THE ITEMS CHECKED BELOW WILL BE A REQUIREMENT OF THIS CONTRACT:</p> <p>(XX) INSURANCE: SUCCESSFUL VENDOR SHALL FURNISH PROOF OF COMMERCIAL GENERAL LIABILITY INSURANCE PRIOR TO ISSUANCE OF CONTRACT. UNLESS OTHERWISE SPECIFIED IN THE BID DOCUMENTS, THE MINIMUM AMOUNT OF INSURANCE COVERAGE REQUIRED IS \$250,000.</p> <p>() BUILDERS RISK INSURANCE: SUCCESSFUL VENDOR SHALL FURNISH PROOF OF BUILDERS RISK - ALL RISK INSURANCE IN AN AMOUNT EQUAL TO 100% OF THE AMOUNT OF THE CONTRACT.</p> <p>(XX) BONDS: FIVE PERCENT (5%) OF THE TOTAL AMOUNT OF THE BID PAYABLE TO THE STATE OF WEST VIRGINIA, SHALL BE SUBMITTED WITH EACH BID AS A BID BOND. THE SUCCESSFUL BIDDER SHALL ALSO FURNISH A PERFORMANCE BOND AND LABOR/MATERIAL BOND FOR 100% OF THE AMOUNT OF THE CONTRACT. BONDS MAY BE PROVIDED IN THE FORM OF A CERTIFIED CHECK IRREVOCABLE LETTER OF CREDIT, OR BOND FURNISHED BY A SOLVENT SURETY COMPANY AUTHORIZED TO DO BUSINESS IN THE STATE OF WEST VIRGINIA. A LETTER OF CREDIT SUBMITTED IN LIEU OF A BOND WILL ONLY BE ALLOWED FOR PROJECTS UNDER \$100,000. PERSONAL OR BUSINESS CHECKS ARE NOT ACCEPCTABLE IN LIEU OF THE 5% BID BOND, PERFORMANCE BOND, OR LABOR AND MATERIAL BOND.</p> <p>() MAINTENANCE BOND: A TWO (2) YEAR MAINTENANCE BOND COVERING THE ROOFING SYSTEM WILL BE A REQUIREMENT OF THE SUCCESSFUL VENDOR.</p>						

SEE REVERSE SIDE FOR TERMS AND CONDITIONS

SIGNATURE <i>Danny May</i>	TELEPHONE 304-397-4100	DATE 7-19-2010
TITLE Area Manager	FEIN 540216361	ADDRESS CHANGES TO BE NOTED ABOVE

WHEN RESPONDING TO RFQ, INSERT NAME AND ADDRESS IN SPACE ABOVE LABELED 'VENDOR'



State of West Virginia
 Department of Administration
 Purchasing Division
 2019 Washington Street East
 Post Office Box 50130
 Charleston, WV 25305-0130

Request for Quotation

RFO NUMBER
DBSM108117

PAGE
5

ADDRESS CORRESPONDENCE TO ATTENTION OF
SHELLY MURRAY
304-558-8801

RFQ COPY
 TYPE NAME/ADDRESS HERE

Lee Hartman & Sons, Inc.
 3 Davis Court
 Hurricane, WV 25526
 V 304-397-4100 F 304-397-4100

SCHOOL FOR THE DEAF & BLIND
 RECEIVING DEPARTMENT

301 EAST MAIN STREET
 ROMNEY, WV
 26757-1894 304-822-4810

DATE PRINTED	TERMS OF SALE	SHIP VIA	P.O.B.	FREIGHT TERMS
06/16/2010	net 30	Our Truck	Dest	FRD

BID OPENING DATE: **07/22/2010** BID OPENING TIME **01:30PM**

LINE	QUANTITY	UOP	CAT NO	ITEM NUMBER	UNIT PRICE	AMOUNT
<p>ALUMINUM, GLASS OR STEEL THAT IS REASONABLE AND LOWER THAN THE LOWEST BID DOMESTIC PRODUCTS, THE SPENDING OFFICE MAY REQUEST, IN WRITING, A REEVALUATION AND REDUCTION IN THE LOWEST BID FOR SUCH DOMESTIC PRODUCTS. ALL VENDORS MUST INDICATE IN THEIR BID IF THEY ARE SUPPLYING FOREIGN ALUMINUM, GLASS OR STEEL.</p> <p>REV. 3/88</p> <p>EXHIBIT 9</p> <p>NOTICE FOR ISSUANCE & ACKNOWLEDGEMENT OF CONSTRUCTION PROJECT ADDENDA</p> <p>THE ARCHITECT/ENGINEER AND/OR AGENCY SHALL BE REQUIRED TO ABIDE BY THE FOLLOWING SCHEDULE IN ISSUING CONSTRUCTION PROJECT ADDENDA FOR STATE AGENCIES:</p> <p>(1) THE ARCHITECT/ENGINEER SHALL PREPARE THE ADDENDUM AND A LIST OF ALL PARTIES THAT HAVE PROCURED DRAWINGS AND SPECIFICATIONS FOR THE PROJECT. THE ADDENDUM AND LIST SHALL BE FORWARDED TO THE BUYER IN THE STATE PURCHASING DIVISION. THE ARCHITECT/ENGINEER SHALL ALSO SEND A COPY OF THE ADDENDUM TO THE STATE AGENCY FOR WHICH THE CONTRACT IS ISSUED.</p> <p>(2) THE BUYER SHALL SEND THE ADDENDUM TO ALL INTERESTED PARTIES AND, IF NECESSARY, EXTEND THE BID OPENING DATE. ANY ADDENDUM SHOULD BE RECEIVED BY THE BUYER WITHIN FOURTEEN (14) DAYS PRIOR TO THE BID OPENING DATE.</p> <p>(3) ALL ADDENDA SHOULD BE FORMALLY ACKNOWLEDGED BY ALL BIDDERS AND SUBMITTED TO THE STATE PURCHASING DIVISION. THE SAME RULES AND REGULATIONS</p>						

SEE REVERSE SIDE FOR TERMS AND CONDITIONS

SIGNATURE <i>Danny T. [Signature]</i>	TELEPHONE 304-347-4100	DATE 7-19-2010
TITLE Area Manager	FEIN 540 716 361	ADDRESS CHANGES TO BE NOTED ABOVE

WHEN RESPONDING TO RFQ, INSERT NAME AND ADDRESS IN SPACE ABOVE LABELED 'VENDOR'



State of West Virginia
 Department of Administration
 Purchasing Division
 2019 Washington Street East
 Post Office Box 50130
 Charleston, WV 25305-0130

Request for Quotation

RFQ NUMBER
DBSM108117

PAGE
6

ADDRESS CORRESPONDENCE TO ATTENTION OF
SHELLY MURRAY
304-558-8801

RFQ COPY
 TYPE NAME/ADDRESS HERE

Lee Hartman & Sons, Inc.
3 Davis Court
Hurricane, WV 25526
V 304-397-4100 F 304-397-4101

SCHOOL FOR THE DEAF & BLIND
RECEIVING DEPARTMENT
301 EAST MAIN STREET
ROMNEY, WV
26757-1894 304-822-4810

DATE PRINTED	TERMS OF SALE	SHIP VIA	FOB	FREIGHT TERMS
06/16/2010	net 30	03 Truck	dest	PPD

BID OPENING DATE: **07/22/2010** BID OPENING TIME **01:30PM**

LINE	QUANTITY	UOP	CAT NO	ITEM NUMBER	UNIT PRICE	AMOUNT
<p>THAT APPLY TO THE ORIGINAL BIDDING DOCUMENT SHALL ALSO APPLY TO AN ADDENDUM DOCUMENT. THE ONLY EXCEPTION MAY BE FOR AN ADDENDUM THAT IS ISSUED FOR THE SOLE PURPOSE OF CHANGING A BID OPENING TIME AND/OR DATE.</p> <p>REV. 11/96</p> <p>EXHIBIT 10</p> <p>ADDENDUM ACKNOWLEDGEMENT</p> <p>I HEREBY ACKNOWLEDGE RECEIPT OF THE FOLLOWING CHECKED ADDENDUM(S) AND HAVE MADE THE NECESSARY REVISIONS TO MY PROPOSAL, PLANS AND/OR SPECIFICATION, ETC.</p> <p>ADDENDUM NOS.:</p> <p>NO. 1</p> <p>NO. 2</p> <p>NO. 3</p> <p>NO. 4</p> <p>NO. 5</p> <p>I UNDERSTAND THAT FAILURE TO CONFIRM THE RECEIPT OF TH ADDENDUM(S) MAY BE CAUSE FOR REJECTION OF THE BIDS.</p> <p>VENDOR MUST CLEARLY UNDERSTAND THAT ANY VERBAL REPRESENTATION MADE OR ASSUMED TO BE MADE DURING ANY ORAL DISCUSSION HELD BETWEEN VENDOR'S REPRESENTATIVES AND ANY STATE PERSONNEL IS NOT BINDING. ONLY THE</p>						

SEE REVERSE SIDE FOR TERMS AND CONDITIONS

SIGNATURE <i>Shelly Murray</i>	TELEPHONE <i>304-397-4100</i>	DATE <i>7-19-2010</i>
TITLE <i>Assoc. Manager</i>	FEIN <i>540716361</i>	ADDRESS CHANGES TO BE NOTED ABOVE

WHEN RESPONDING TO RFQ, INSERT NAME AND ADDRESS IN SPACE ABOVE LABELED 'VENDOR'



State of West Virginia
 Department of Administration
 Purchasing Division
 2019 Washington Street East
 Post Office Box 50130
 Charleston, WV 25305-0130

Request for Quotation

RFQ NUMBER
DBSM108117

PAGE
7

ADDRESS CORRESPONDENCE TO ATTENTION OF
**SHELLY MURRAY
 304-558-8801**

RFQ COPY
 TYPE NAME/ADDRESS HERE

**Lee Hartman & Sons, Inc.
 3 Davis Court
 Hurricane, WV 25526
 V 304-397-4100 F 304-397-4101**

**SCHOOL FOR THE DEAF & BLIND
 RECEIVING DEPARTMENT
 301 EAST MAIN STREET
 ROMNEY, WV
 26757-1894 304-822-4810**

DATE PRINTED	TERMS OF SALE	SHIP VIA	F.O.B.	FREIGHT TERMS
06/16/2010	Net 30	our Truck	Dest	PPG

BID OPENING DATE: **07/22/2010** BID OPENING TIME **01:30PM**

LINE	QUANTITY	UOP	CAT NO	ITEM NUMBER	UNIT PRICE	AMOUNT
<p>INFORMATION ISSUED IN WRITING AND ADDED TO THE SPECIFICATIONS BY AN OFFICIAL ADDENDUM IS BINDING.</p> <p><i>Randy Myers</i> SIGNATURE <i>Lee Hartman & Sons, Inc</i> COMPANY <i>7-19-2010</i> DATE</p> <p>REV. 11/96</p> <p>CONTRACTORS LICENSE</p> <p>WEST VIRGINIA STATE CODE 21-11-2 REQUIRES THAT ALL PERSONS DESIRING TO PERFORM CONTRACTING WORK IN THIS STATE MUST BE LICENSED. THE WEST VIRGINIA CONTRACTORS LICENSING BOARD IS EMPOWERED TO ISSUE THE CONTRACTORS LICENSE. APPLICATIONS FOR A CONTRACTORS LICENSE MAY BE MADE BY CONTACTING THE WEST VIRGINIA DIVISION OF LABOR CAPITOL COMPLEX, BUILDING 3, ROOM 319, CHARLESTON, WV 25305. TELEPHONE: (304) 558-7890.</p> <p>WEST VIRGINIA STATE CODE 21-11-11 REQUIRES ANY PROSPECTIVE BIDDER TO INCLUDE THE CONTRACTORS LICENSE NUMBER ON THEIR BID.</p> <p>BIDDER TO COMPLETE:</p> <p>CONTRACTORS NAME: <i>Lee Hartman & Sons, Inc</i> CONTRACTORS LICENSE NO.: <i>WV 037.65</i></p> <p>THE SUCCESSFUL BIDDER WILL BE REQUIRED TO FURNISH A COPY OF THEIR CONTRACTORS LICENSE PRIOR TO ISSUANCE OF</p>						

SEE REVERSE SIDE FOR TERMS AND CONDITIONS

SIGNATURE <i>Randy Myers</i>	TELEPHONE 304-397-4100	DATE 7-19-2010
TITLE Area Manager	FEIN 540716361	ADDRESS CHANGES TO BE NOTED ABOVE

WHEN RESPONDING TO RFQ, INSERT NAME AND ADDRESS IN SPACE ABOVE LABELED 'VENDOR'



State of West Virginia
 Department of Administration
 Purchasing Division
 2019 Washington Street East
 Post Office Box 50130
 Charleston, WV 25305-0130

Request for Quotation

RFQ NUMBER
DBSM108117

PAGE
8

ADDRESS CORRESPONDENCE TO ATTENTION OF
**SHELLY MURRAY
 304-558-8801**

RFQ COPY
 TYPE NAME/ADDRESS HERE

**Lee Hartman & Sons, Inc.
 3 Davis Court
 Hurricane, WV 25526
 V 304-397-4100 F 304-397-4101**

**SCHOOL FOR THE DEAF & BLIND
 RECEIVING DEPARTMENT**

**301 EAST MAIN STREET
 ROMNEY, WV
 26757-1894 304-822-4810**

DATE PRINTED	TERMS OF SALE	SHIP VIA	FOB	FREIGHT TERMS
06/16/2010	Net 30	Over Truck	Dist	FFD

BID OPENING DATE: **07/22/2010** BID OPENING TIME **01:30PM**

LINE	QUANTITY	UOP	CAT NO.	ITEM NUMBER	UNIT PRICE	AMOUNT
<p>A PURCHASE ORDER/CONTRACT</p> <p>APPLICABLE LAW</p> <p>THE WEST VIRGINIA STATE CODE, PURCHASING DIVISION RULES AND REGULATIONS, AND THE INFORMATION PROVIDED IN THE "REQUEST FOR QUOTATION" ISSUED BY THE PURCHASING DIVISION IS THE SOLE AUTHORITY GOVERNING THIS PROCUREMENT.</p> <p>ANY INFORMATION PROVIDED IN SPECIFICATION MANUALS, OR ANY OTHER SOURCE, VERBAL OR WRITTEN, WHICH CONTRADICTS OR ALTERS THE INFORMATION PROVIDED FROM THE SOURCES AS DESCRIBED IN THE ABOVE PARAGRAPH IS VOID AND OF NO EFFECT.</p> <p>BANKRUPTCY: IN THE EVENT THE VENDOR/CONTRACTOR FILES FOR BANKRUPTCY PROTECTION, THE STATE MAY DEEM THE CONTRACT NULL AND VOID, AND TERMINATE SUCH CONTRACT WITHOUT FURTHER ORDER.</p> <p>REV. 5/2009</p> <p>NOTICE</p> <p>A SIGNED BID MUST BE SUBMITTED TO:</p> <p>DEPARTMENT OF ADMINISTRATION PURCHASING DIVISION BUILDING 15 2019 WASHINGTON STREET, EAST CHARLESTON, WV 25305-0130</p> <p>THE BID SHOULD CONTAIN THIS INFORMATION ON THE FACE OF</p>						

SEE REVERSE SIDE FOR TERMS AND CONDITIONS

SIGNATURE <i>Shelly Murray</i>	TELEPHONE 304-347-4800	DATE 7-19-2010
TITLE Area Manager	FEIN 540916361	ADDRESS CHANGES TO BE NOTED ABOVE

WHEN RESPONDING TO RFQ, INSERT NAME AND ADDRESS IN SPACE ABOVE LABELED 'VENDOR'



State of West Virginia
 Department of Administration
 Purchasing Division
 2019 Washington Street East
 Post Office Box 50130
 Charleston, WV 25305-0130

Request for Quotation

RFQ NUMBER
DBSM108117

PAGE
9

ADDRESS CORRESPONDENCE TO ATTENTION OF
SHELLY MURRAY 304-558-8801

RFQ COPY
 TYPE NAME/ADDRESS HERE

Lee Hartman & Sons, Inc.
 3 Davis Court
 Hurricane, WV 25526
 V 304-397-4100 F 304-397-4101

SCHOOL FOR THE DEAF & BLIND
 RECEIVING DEPARTMENT

301 EAST MAIN STREET
 ROMNEY, WV
 26757-1894 304-822-4810

DATE PRINTED	TERMS OF SALE	SHIP VIA	F.O.B.	FREIGHT TERMS
06/16/2010	Net 30	Do: Truck	Dest	PPD

BID OPENING DATE: **07/22/2010** BID OPENING TIME **01:30PM**

LINE	QUANTITY	UOP	CAT NO	ITEM NUMBER	UNIT PRICE	AMOUNT
THE ENVELOPE OR THE BID MAY NOT BE CONSIDERED: SEALED BID BUYER: SHELLY MURRAY REQ. NO.: DBSM108117 BID OPENING DATE: 07/22/2010 BID OPENING TIME: 1:30 PM PLEASE PROVIDE A FAX NUMBER IN CASE IT IS NECESSARY TO CONTACT YOU REGARDING YOUR BID: 304-397-4101 PLEASE PRINT OR TYPE NAME OF PERSON TO CONTACT CONCERNING THIS QUOTE: Larry T. Cox ***** THIS IS THE END OF RFQ DBSM108117 ***** TOTAL: <u>\$ 265,000.00</u>						

SEE REVERSE SIDE FOR TERMS AND CONDITIONS

SIGNATURE	TELEPHONE	DATE
<i>Larry T. Cox</i>	304-397-4100	7-19-2010
TITLE	FEIN	ADDRESS CHANGES TO BE NOTED ABOVE
<i>Area Manager</i>	540916361	

WHEN RESPONDING TO RFQ, INSERT NAME AND ADDRESS IN SPACE ABOVE LABELED 'VENDOR'

DBSM108117
REQUEST FOR QUOTATION
West Virginia Schools for the Deaf and Blind (WVSDB)
Videoconferencing Equipment

PURPOSE:

WVSDB is soliciting a Request for Quotation from qualified vendors to provide videoconferencing equipment to WVSDB and 5 other schools that are partners in this project.

SPECIFICATIONS:

Background:

The West Virginia Schools for the Deaf and Blind want to install a state of the art videoconference system in order to participate in projects with our 5 partners across the state. This will allow our students to participate in numerous 21st century educational activities.

Scope of Work:

The majority of the videoconferencing equipment will be installed on the campus of WVSDB. Each of our partners will be receiving items 24, 25, 26, 28, 29, 31 and 32 on the list of equipment. This includes the Tandberg Edge 95 or equal, the Natural Presenter package, on-site installation/configuration and the 1 year warranty. These units will be installed at the following locations:

Petersburg Elementary School
333 Rig Street
Petersburg, WV 26847

Spencer Elementary School
85 Clay Road
Spencer, WV 25276

Geary Elementary Middle School
9538 Clay Road
Left Hand, WV 25251

Spencer Middle School
102 Chapman Avenue
Spencer, WV 25276

Walton Elementary/Middle School
90 School Drive
Walton, WV 25286

This should include all materials, labor and delivery to specified locations, installation by a certified installer, and training.

Equipment Specification:

The qualified vendor shall provide a quote for the following requested quantity, brand or equal to and equipment equal to.

Below is a listing of the requested items with specifications on the following pages.

Item #	QTY	Manufacturer	Equipment Description	Unit Cost	Extended Co.
1	1	Tandberg	VCS Control Application <i>As specified</i>	13,290 ⁰⁰	13,290 ⁰⁰
2	1	Tandberg	VCS Control Application 1 yr manufacturer's warranty	1,585 ⁰⁰	1,585 ⁰⁰
3	1	Tandberg	VCS Expressway Application	1,400 ⁰⁰	1,400 ⁰⁰
4	1	Tandberg	VCS Expressway Application 1 yr manufacturer's warranty	1,585 ⁰⁰	1,585 ⁰⁰
5	1	Tandberg	Content Server- 5 recording ports 2 live output	28,465 ⁰⁰	28,465 ⁰⁰
6	1	Tandberg	Content Server 1 yr manufacturer's warranty	2,765 ⁰⁰	2,765 ⁰⁰
7	1	Tandberg	TMS Server Appliance	11,400 ⁰⁰	11,400 ⁰⁰
8	1	Tandberg	TMS Server Appliance 1 yr manufacturer's warranty	1,840 ⁰⁰	1,840 ⁰⁰
9	1	Tandberg	MCU-4205 12 Port Enterprise MCU	32,740 ⁰⁰	32,740 ⁰⁰
10	1	Tandberg	MCU-4205 12 Port Enterprise 1 yr manufacturer's warranty	3,165 ⁰⁰	3,165 ⁰⁰
11	1		On-site Installation & Configuration of MCU-4205	5,095 ⁰⁰	5,095 ⁰⁰
12	1	Tandberg	3000 MXP Profile- Single 42" WXGA LCD w/ Precision HD camera"	18,455 ⁰⁰	18,455 ⁰⁰
13	1	Tandberg	Tandberg 3000 MXP Natural Presenter Package	1,325 ⁰⁰	1,325 ⁰⁰
14	1	Tandberg	Wheel base option for 3000 MXP Profile 42"	300 ⁰⁰	300 ⁰⁰
15	1		Onsite Installation and Configuration for 3000 MXP	1,865 ⁰⁰	1,865 ⁰⁰
16	1	Tandberg	3000 MXP Profile- 42" WXGA LCD & camera 1 yr man. warranty	1,325 ⁰⁰	1,325 ⁰⁰
17	1	Tandberg	HD 6000 MXP Integrator Package	19,165 ⁰⁰	19,165 ⁰⁰
18	1	Tandberg	HD 6000 MXP Integrator Package 1 yr manufacturers warranty	1,150 ⁰⁰	1,150 ⁰⁰
19	1	Tandberg	HD 6000 MXP Natural Presenters Package	1,325 ⁰⁰	1,325 ⁰⁰
20	1		Onsite Installation for the Tandberg HD 6000 MXP	1,865 ⁰⁰	1,865 ⁰⁰
21	1	Tandberg	W.A.V.E. II camera with 20m cable	3,485 ⁰⁰	3,485 ⁰⁰
22	1	Tandberg	W.A.V.E. II camera 1 yr manufacturer's warranty	240 ⁰⁰	240 ⁰⁰
23	1	Tandberg	T4 Complete Program	4,270 ⁰⁰	4,270 ⁰⁰
24*	5	Tandberg	Edge 95	8,425 ⁰⁰	42,125 ⁰⁰
25*	5	Tandberg	Edge 95 Natural Presenters Package	1,325 ⁰⁰	6,625 ⁰⁰
26*	5	Tandberg	Edge 95 3 year manufacturers warranty	1,930 ⁰⁰	9,650 ⁰⁰
27			Misc. Cables for WVSDB equipment	400 ⁰⁰	400 ⁰⁰
28*			Misc. Cables for partner locations	150 ⁰⁰	750 ⁰⁰
29*	5		Installation, Configuration and training of all equipment at partners locations	1,210 ⁰⁰	6,050 ⁰⁰
30	2	Cisco	52" LCD TV and mounts <i>Alternate LG M5201C-BA</i>	2630 ⁰⁰	5,260 ⁰⁰
31*	5	Cisco	42" LCD TV <i>Alternate LG M4224C-BA</i>	1,215 ⁰⁰	6,075 ⁰⁰
32*	5	Cisco	Equipment carts <i>Alternate VFI-TP1000</i>	865 ⁰⁰	4,325 ⁰⁰
33	2	Cisco	Equipment carts <i>Alternate VFF TP1000</i>	865 ⁰⁰	1,730 ⁰⁰
34			Complete Installation, configuration and training at WVSDB	11,310 ⁰⁰	11,310 ⁰⁰

TOTAL \$ 265,000⁰⁰

* indicates items for partner locations

Time Frame:

The scope of work shall be completed within 60 days after contract is awarded and notice to proceed is given.

Mandatory Qualifications:

By submitting a bid, the vendor adheres to the following:

1. The vendor verifies that they have completed at least 3 projects of the same nature in the past five years.
2. The vendor must be certified on the proposed installed equipment
3. The vendor must be registered as a Vendor with the State of West Virginia prior to award.

TANDBERG VCS Control Application**Item #1**

- Single box must support gatekeeping functionality using the industry standard of H323 and SIP proxy functionality using the industry standard of SIP
- System must be capable of interworking H.323 and SIP without user intervention
- Flash memory and hard drive
- Must provide PBX functionality to end points such as call hold, call transfer and conferencing without the need for an embedded MCU in the endpoints
- Support for IP Version 4 support and support for IP Version 6 support
- H.323 v5 Annex O for DNS dialing support
- ITU-T H.323 v5 complaint and ITU-T H.225 v4 complaint
- Single box solution must support SIP based presence
- Solution must support clustering and up to 10,000 users in a cluster and up to 2,000 simultaneous calls in a cluster

TANDBERG VCS Expressway Application**Item #3**

- Single box solution must support H.460 firewall traversal with multiplexed media technology without the use of external or add-on devices
- Single box solution must support SIP based firewall traversal technology without the use of external or add-on devices
- Solution must support clustering and up to 10,000 users in a cluster
- Solution must support clustering and up to 2,000 simultaneous calls in a cluster
- Must support ICE (interactive connectivity establishment)
- Support for Registration of traversal-enabled endpoints
- SIP based STUN Discover y and STUN Relay services

- H.460.18/19 complaint and H.460.18 client proxy support
- Instant restart and boot – under 90 seconds

**TANDBERG Content Server
Item #5**

- A single box solution must support a minimum of 5 simultaneous accesses
- The system must support RSS feeds and portable device downloads
- The system must support Flash, Windows Media Player, Quicktime, and Real
- The system must support native Multicast without the use of external equipment
- The system must integrate direction with Apple iTunes and Apple Podcast Producer
- The system must provide build in Streaming Server based on Windows Media Server
- The system must provide SIP support to allow SIP end points to record and stream

**TMS Server Appliance
Item #7**

- The management system must be able to manage both newer and legacy Tandberg and Polycom endpoints, along with the network infrastructure chosen. This includes MCUs, Firewall Traversal Solutions, Streaming systems, Call Control systems, Gatekeepers and others.
- The management software must provide diagnostic capabilities, billing capabilities as well as graphical reports
- The management software must provide H.350 support (import and export) Active Directory support
- The management software must provide Centrally-managed server phone books creation of one or multiple phone books with the ability to search unlimited entries
- The management software must provide Automatic directory import from gatekeeper, ILS and LDAP (single or multiple source)
- The management software must provide Automatic MCU, gateway and network selection
- The management software must provide Support for SIP enabled endpoints and dialing
- The management software must provide battery status on remote controls, diagnostic messages and solution suggestions system status, gatekeeper status, SNMP configuration, ISDN/IP configuration and information
- The management software must Manage calls made on multiple protocols (IP using H.323 and SIP, ISDN and mixed calls)
- The management software must provide for System Upgrades – Able to upgrade either pre-scheduled or ad-hoc software updates to endpoints

**MCU-4205 12 Port Multisite Bridge
Item #9**

- There must be NO reduction of ports for features. This includes individual transcoding, encryption, and others. It must be conveyed that the capacity of the system IS the capacity of the system regardless of features being used
- The system must support standards based H.264 (no proprietary algorithms will be permitted) and standards based AAC for audio (no proprietary algorithms will be permitted)
- Content or data sharing channel must support 30 FPS
- The system must provide easy to use software clients
- Dimensions not to exceed 1 rack unit (U)

**TANDBERG 3000 MXP Profile-Single 42"
Item #12**

- The system must support standards based H.264 for high definition video (no proprietary algorithms will be permitted)
- The system must support standards based AAC for high definition audio (no proprietary algorithms will be permitted)
- Content or data sharing channel must support 30 FPS
- The codec must support 16 x 9 native (not stretched) at all bandwidths including 128k, 256k, 384k, 512k, and 768k.
- The system must support H.239 for data collaboration using H.323 (no proprietary algorithms will be permitted)
- The system must support BFCP for data collaboration using SIP (no proprietary algorithms will be permitted)
- The system must support H.460.18/19 multiplexed media for firewall traversal using H.323 (no proprietary algorithms will be permitted)
- The system must support STUN/ICE multiplexed media for firewall traversal using SIP (no proprietary algorithms will be permitted)
- The system must allow for real-time address books (not updated on a schedule)

**TANDBERG 3000 MXP Natural Presenters Package
Item # 13**

- Software option that allows two video streams at one time, allows students to view instructor and interpreter simultaneously
- Allows users to incorporate computers, laptops, document camera into the video presentation

Wheel Base Option for 3000 MXP Profile 42"
Item # 14

- Wheel base for equipment that allows the unit to be portable

HD 6000 MXP Integrator Package
Item #17

- 6000 MXP codec
- Precision HD camera
- Camera cable set (2m, 5m and 19.5m cable extension kit),
- 2 table microphones
- 2 trackers

HD Integrator 6000 MXP Natural Presenter Package
Item #19

- Software option that allows two video streams at one time, allows students to view instructor and interpreter simultaneously
- Allows users to incorporate computers, laptops, document camera into the video presentation

W.A.V.E. II Camera
Item #21

- 13CCD Color Camera PAL or NTSC
- 10 x zoom
- 1/4" CCD
- 96° total vertical field of view and 77° horizontal field of view
- 267° total horizontal field of view
- 460 (PAL) / 470 (NTSC) horizontal TV lines
- Min. illumination 2 Lux (F1.8)
- Auto or manual focus, brightness and white balance
- Far end camera control w/ 15 near and far-end camera pre-sets
- Voice-activated camera positioning
- Daisy chain support for up to 4 cameras
- VISCA camera support.

T4 Complete Program
Item # 23

- Complete training program for teachers.
- Includes 10 hours of training for classroom teachers on the following:
 - 4.5 hours of video conferencing basics includes basic operation of equipment, methods of engaging students, using administrative applications

- 2.5 hours of how to best utilize peripheral equipment as part of the video conferencing experience
- 1.5 hours of instruction on preparing lesson plans for delivery over video
- 1.5 hours of review, wrap up and practice of previous sessions.

**Edge 95
Item #24**

- The system must be able to connect up to 4 video sites and 3 audio sites with embedded Multi Site functionality
- The system must support up to 2 Mbps H.323/2 Mbps SIP/512 kbps H.320/2.3 Mbps total MultiSite
- The system must be wireless capable
- The system must allow for viewers to view presentations and presenters simultaneously with Duo Video and H.239 Dual Stream
- The system must incorporate H.264 standard for superior video quality

**Edge 95 Natural Presenter Package
Item #25**

- Software option that allows two video streams at one time, allows students to view instructor and interpreter simultaneously
- Allows users to incorporate computers, laptops, document camera into the video presentation

**Misc. Cable
Item #27 and 28**

- RCA Female To BNC Male Adapter
- DVI To VGA Display Adapter
- 6ft Outlet Saver Power Extension Cord Black
- Audio Y-Adapter Cable
- 3.5mm Stereo Male To 3.5mm Stereo Female Y-Cable
- Panel-Mount VGA F-F Coupler Gender Changer
- Box of 20 Raceway White 3/4" X 1/2" X 8'
- Straight Through Modular In-line Coupler RJ45
- HDMI Gold Digital Video Cable 50ft
- 25ft 3.5mm M/M Stereo
- 25ft Grey Cat5e Patch Cable Molded Snag less
- 50ft Male to Male Premium SVGA VGA cable DB15M to DB15M
- Single Gang Surface Mount Box WHITE
- One-Piece Deep Low Voltage Junction Box w/Adhesive
- Essential 7 Outlet Surge Suppressor
- 6 Outlet Surge Suppressor 6x Receptacles 1 x power cable – 16.4 ft

- VGA VIDEO SPLITTER/EXTENDER 2- 2 PORT HDMI SPLITTER
- Any other cable needed to connect, attach equipment quoted but not listed here

**Cisco 52" LCD TV monitors and mounts
Item #30**

- Commercial grade LCD monitor
- Must have 1080p resolution with HDMI input
- Must have a PC input-RGB/VGA 15 pin that supports 1080p resolution
- 3 year manufacturers warranty included

**Cisco 42" LCD TV monitors and mounts
Item #31**

- Commercial grade LCD monitor
- Must have 1080p resolution with HDMI input
- Must have a PC input-RGB/VGA 15 pin that supports 1080p resolution
- 3 year manufacturers warranty included

**Monitor Carts
Item # 32 and 33**

- Cart must be capable of holding securely the LCD monitor and all Videoconferencing equipment necessary to complete the unit.
- Cart must be capable of locking to secure equipment

**Installation, Configuration and Training
Item # 34**

- Price must be all inclusive to provide a turnkey project.
- All equipment will be installed at the locations listed
- Equipment will be tested for complete functionality
- Must be installed by certified installers
- Training will be given at all sites



State of West Virginia
DRUG FREE WORKPLACE CONFORMANCE AFFIDAVIT
West Virginia Code §21-1D-5

STATE OF West Virginia

COUNTY OF Kanawha, TO-WIT:

I, Larry T. Cox, after being first duly sworn, depose and state as follows:

- 1. I am an employee of Lee Hartman & Sons, Inc.; and,
2. I do hereby attest that Lee Hartman & Sons, Inc.

maintains a valid written drug free workplace policy and that such policy is in compliance with West Virginia Code §21-1D-5.

The above statements are sworn to under the penalty of perjury.

Lee Hartman & Sons, Inc.
(Company Name)

By: Larry T. Cox

Title: Area Manager

Date: July 19, 2010

Taken, subscribed and sworn to before me this 19 day of July, 2010.

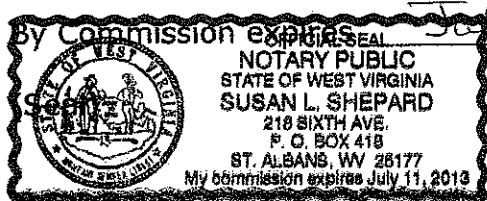

Susan L. Shepard
(Notary Public)

THIS AFFIDAVIT MUST BE SUBMITTED WITH THE BID IN ORDER TO COMPLY WITH WV CODE PROVISIONS. FAILURE TO INCLUDE THE AFFIDAVIT WITH THE BID SHALL RESULT IN DISQUALIFICATION OF THE BID.

BID BOND PREPARATION INSTRUCTIONS

AGENCY (A)
RFQ/RFP# (B)

Bid Bond

KNOW ALL MEN BY THESE PRESENTS, That we, the undersigned,

(C) of (D), (E) as Principal, and (F) of (G), (H), a corporation organized and existing under the laws of the State of (I) with its principal office in the City of (J), as Surety, are held and firmly bound unto The State of West Virginia, as Oblige, in the penal sum of (K) (\$ (L)) for the payment of which, well and truly to be made, we jointly and severally bind ourselves, our heirs, administrators, executors, successors and assigns.

The Condition of the above obligation is such that whereas the Principal has submitted to the Purchasing Section of the Department of Administration a certain bid or proposal, attached hereto and made a part hereof to enter into a contract in writing for (M)

NOW THEREFORE.

(a) If said bid shall be rejected, or (b) If said bid shall be accepted and the Principal shall enter into a contract in accordance with the bid or proposal attached hereto and shall furnish any other bonds and insurance required by the bid or proposal, and shall in all other respects perform the agreement created by the acceptance of said bid then this obligation shall be null and void, otherwise this obligation shall remain in full force and effect. It is expressly understood and agreed that the liability of the Surety for any and all claims hereunder shall, in no event, exceed the penal amount of this obligation as herein stated

The Surety for value received, hereby stipulates and agrees that the obligations of said Surety and its bond shall be in no way impaired or affected by any extension of time within which the Oblige may accept such bid: and said Surety does hereby waive notice of any such extension.

IN WITNESS WHEREOF, Principal and Surety have hereunto set their hands and seals, and such of them as are corporations have caused their corporate seals to be affixed hereto and these presents to be signed by their proper officers, this (N) day of (O), 20 (P).

Principal Corporate Seal

(R)

(U) Surety Corporate Seal

(Q) (Name of Principal) By (S) (Must be President or Vice President) (T) Title (V) (Name of Surety) (W) Attorney-in-Fact

- (A) WV State Agency (Stated on Page 1 "Spending Unit") Request for Quotation Number (upper right corner of page #1)
(C) Your Company Name
(D) City, Location of your Company
(E) State, Location of your Company
(F) Surety Corporate Name
(G) City, Location of Surety
(H) State, Location of Surety
(I) State of Surety Incorporation
(J) City of Surety Incorporation
(K) Minimum amount of acceptable bid bond is 5% of total bid. You may state "5% of bid" or a specific amount on this line in words.
(L) Amount of bond in figures
(M) Brief Description of scope of work
(N) Day of the month
(O) Month
(P) Year
(Q) Name of Corporation
(R) Raised Corporate Seal of Principal
(S) Signature of President or Vice President
(T) Title of person signing
(U) Raised Corporate Seal of Surety
(V) Corporate Name of Surety
(W) Signature of Attorney in Fact of the Surety
NOTE: Dated, Power of Attorney with Raised Surety Seal must accompany this bid bond.

IMPORTANT -- Surety executing bonds must be licensed in West Virginia to transact surety insurance. Raised Corporate Seals must be affixed and a Power of Attorney must be attached.

Agency _____
REQ.P.O# _____

BID BOND

KNOW ALL MEN BY THESE PRESENTS, That we, the undersigned, _____
_____ of _____, _____, as Principal, and _____
_____ of _____, _____, a corporation organized and existing under the laws of the State of _____
_____ with its principal office in the City of _____, as Surety, are held and firmly bound unto the State
of West Virginia, as Obligee, in the penal sum of _____ (\$ _____) for the payment of which,
well and truly to be made, we jointly and severally bind ourselves, our heirs, administrators, executors, successors and assigns.

The Condition of the above obligation is such that whereas the Principal has submitted to the Purchasing Section of the
Department of Administration a certain bid or proposal, attached hereto and made a part hereof, to enter into a contract in writing for

NOW THEREFORE,

- (a) If said bid shall be rejected, or
- (b) If said bid shall be accepted and the Principal shall enter into a contract in accordance with the bid or proposal attached
hereto and shall furnish any other bonds and insurance required by the bid or proposal, and shall in all other respects perform the
agreement created by the acceptance of said bid, then this obligation shall be null and void, otherwise this obligation shall remain in full
force and effect. It is expressly understood and agreed that the liability of the Surety for any and all claims hereunder shall, in no event,
exceed the penal amount of this obligation as herein stated.

The Surety, for the value received, hereby stipulates and agrees that the obligations of said Surety and its bond shall be in no
way impaired or affected by any extension of the time within which the Obligee may accept such bid, and said Surety does hereby
waive notice of any such extension.

IN WITNESS WHEREOF, Principal and Surety have hereunto set their hands and seals, and such of them as are corporations
have caused their corporate seals to be affixed hereunto and these presents to be signed by their proper officers, this
_____ day of _____, 20_____.

Principal Corporate Seal

(Name of Principal)

By _____
(Must be President or
Vice President)

(Title)

Surety Corporate Seal

(Name of Surety)

Attorney-in-Fact

**IMPORTANT – Surety executing bonds must be licensed in West Virginia to transact surety insurance. Raised corporate seals
must be affixed, a power of attorney must be attached.**

STATE OF WEST VIRGINIA
Purchasing Division

PURCHASING AFFIDAVIT

West Virginia Code §5A-3-10a states: No contract or renewal of any contract may be awarded by the state or any of its political subdivisions to any vendor or prospective vendor when the vendor or prospective vendor or a related party to the vendor or prospective vendor is a debtor and the debt owed is an amount greater than one thousand dollars in the aggregate.

DEFINITIONS:

"Debt" means any assessment, premium, penalty, fine, tax or other amount of money owed to the state or any of its political subdivisions because of a judgment, fine, permit violation, license assessment, defaulted workers' compensation premium, penalty or other assessment presently delinquent or due and required to be paid to the state or any of its political subdivisions, including any interest or additional penalties accrued thereon.

"Debtor" means any individual, corporation, partnership, association, limited liability company or any other form or business association owing a debt to the state or any of its political subdivisions. "Political subdivision" means any county commission; municipality; county board of education; any instrumentality established by a county or municipality; any separate corporation or instrumentality established by one or more counties or municipalities, as permitted by law; or any public body charged by law with the performance of a government function or whose jurisdiction is coextensive with one or more counties or municipalities. "Related party" means a party, whether an individual, corporation, partnership, association, limited liability company or any other form or business association or other entity whatsoever, related to any vendor by blood, marriage, ownership or contract through which the party has a relationship of ownership or other interest with the vendor so that the party will actually or by effect receive or control a portion of the benefit, profit or other consideration from performance of a vendor contract with the party receiving an amount that meets or exceeds five percent of the total contract amount.

EXCEPTION: The prohibition of this section does not apply where a vendor has contested any tax administered pursuant to chapter eleven of this code, workers' compensation premium, permit fee or environmental fee or assessment and the matter has not become final or where the vendor has entered into a payment plan or agreement and the vendor is not in default of any of the provisions of such plan or agreement.

Under penalty of law for false swearing (*West Virginia Code §61-5-3*), it is hereby certified that the vendor affirms and acknowledges the information in this affidavit and is in compliance with the requirements as stated.

WITNESS THE FOLLOWING SIGNATURE

Vendor's Name: Lee Hartman & Sons, Inc.

Authorized Signature: *Randy Tex* Date: July 19, 2010

State of West Virginia

County of Kanawha, to-wit:

Taken, subscribed, and sworn to before me this 19 day of July, 2010.

My Commission expires July 11, 2013.

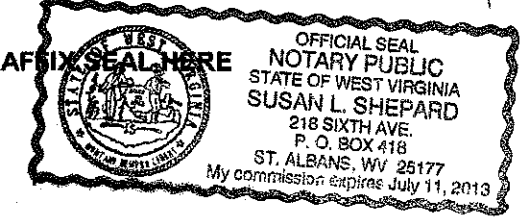

NOTARY PUBLIC *Susan L. Shepard*

Agency WVSD
REQ.P.O# DBSM108117

BID BOND

KNOW ALL MEN BY THESE PRESENTS, That we, the undersigned, LEE HARTMAN & SONS, INC.
of ROANOKE, VIRGINIA, as Principal, and CINCINNATI INSURANCE COMPANY
of FAIRFIELD, OHIO, a corporation organized and existing under the laws of the State of OHIO
with its principal office in the City of FAIRFIELD, as Surety, are held and firmly bound unto the State
of West Virginia, as Oblgee, in the penal sum of 5% OF BID (\$ 5% OF BID) for the payment of which,
well and truly to be made, we jointly and severally bind ourselves, our heirs, administrators, executors, successors and assigns.

The Condition of the above obligation is such that whereas the Principal has submitted to the Purchasing Section of the
Department of Administration a certain bid or proposal, attached hereto and made a part hereof, to enter into a contract in writing for
VIDEO CONFERENCING EQUIPMENT FOR WV SCHOOLS FOR DEAF AND BLIND

NOW THEREFORE,

- (a) If said bid shall be rejected, or
- (b) If said bid shall be accepted and the Principal shall enter into a contract in accordance with the bid or proposal attached hereto and shall furnish any other bonds and insurance required by the bid or proposal, and shall in all other respects perform the agreement created by the acceptance of said bid, then this obligation shall be null and void, otherwise this obligation shall remain in full force and effect. It is expressly understood and agreed that the liability of the Surety for any and all claims hereunder shall, in no event, exceed the penal amount of this obligation as herein stated.

The Surety, for the value received, hereby stipulates and agrees that the obligations of said Surety and its bond shall be in no way impaired or affected by any extension of the time within which the Oblgee may accept such bid, and said Surety does hereby waive notice of any such extension.

IN WITNESS WHEREOF, Principal and Surety have hereunto set their hands and seals, and such of them as are corporations have caused their corporate seals to be affixed hereunto and these presents to be signed by their proper officers, this
12TH day of JULY, 2010.

Principal Corporate Seal

LEE HARTMAN & SONS, INC.

(Name of Principal)

By Lee C. Hartman

(Must be President or Vice President)

President

(Title)

Surety Corporate Seal

CINCINNATI INSURANCE COMPANY

(Name of Surety)

Cecilia W. Long
Attorney-In-Fact

IMPORTANT - Surety executing bonds must be licensed in West Virginia to transact surety insurance. Raised corporate seals must be affixed, a power of attorney must be attached.

THE CINCINNATI INSURANCE COMPANY

Fairfield, Ohio

POWER OF ATTORNEY

KNOW ALL MEN BY THESE PRESENTS: That THE CINCINNATI INSURANCE COMPANY, a corporation organized under the laws of the State of Ohio, and having its principal office in the City of Fairfield, Ohio, does hereby constitute and appoint E. Gerald Stump; William E. Haynie; Mark B. Stump; Cecelia W. Long; Paula B. Gibson; Samuel A. Lowman, Jr.; Barbara Hall; Linda St. Clair; Robert Gibson; Mike Repass; Lisa Bain; Sandra Short; Timothy Merry and/or Cindy Walters each in their separate capacity of Salem and Midlothian, Virginia its true and lawful Attorney(s)-in-Fact to sign, execute, seal and deliver on its behalf as Surety, and as its act and deed, any and all bonds, policies, undertakings, or other like instruments, as follows:

Any such obligations in the United States, up to Twenty Million and No/100 Dollars (\$20,000,000.00).

This appointment is made under and by authority of the following resolution passed by the Board of Directors of said Company at a meeting held in the principal office of the Company, a quorum being present and voting, on the 6th day of December, 1958, which resolution is still in effect:

"RESOLVED, that the President or any Vice President be hereby authorized, and empowered to appoint Attorneys-in-Fact of the Company to execute any and all bonds, policies, undertakings, or other like instruments on behalf of the Corporation, and may authorize any officer or any such Attorney-in-Fact to affix the corporate seal; and may with or without cause modify or revoke any such appointment or authority. Any such writings so executed by such Attorneys-in-Fact shall be binding upon the Company as if they had been duly executed and acknowledged by the regularly elected officers of the Company."

This Power of Attorney is signed and sealed by facsimile under and by the authority of the following Resolution adopted by the Board of Directors of the Company at a meeting duly called and held on the 7th day of December, 1973.

"RESOLVED, that the signature of the President or a Vice President and the seal of the Company may be affixed by facsimile on any power of attorney granted, and the signature of the Secretary or Assistant Secretary and the seal of the Company may be affixed by facsimile to any certificate of any such power and any such power of certificate bearing such facsimile signature and seal shall be valid and binding on the Company. Any such power so executed and sealed and certified by certificate so executed and sealed shall, with respect to any bond or undertaking to which it is attached, continue to be valid and binding on the Company."

IN WITNESS WHEREOF, THE CINCINNATI INSURANCE COMPANY has caused these presents to be sealed with its corporate seal, duly attested by its Vice President this 10th day of October, 2008.



THE CINCINNATI INSURANCE COMPANY

Thomas H. Kelly
Vice President

STATE OF OHIO) ss:
COUNTY OF BUTLER)

On this 10th day of October, 2008, before me came the above-named Vice President of THE CINCINNATI INSURANCE COMPANY, to me personally known to be the officer described herein, and acknowledged that the seal affixed to the preceding instrument is the corporate seal of said Company and the corporate seal and the signature of the officer were duly affixed and subscribed to said instrument by the authority and direction of said corporation.

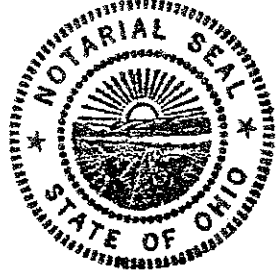

MARK J. HULLER, Attorney at Law
NOTARY PUBLIC - STATE OF OHIO
My commission has no expiration date. Section 147.03 O.R.C.

I, the undersigned Secretary or Assistant Secretary of THE CINCINNATI INSURANCE COMPANY, hereby certify that the above is a true and correct copy of the Original Power of Attorney issued by said Company, and do hereby further certify that the said Power of Attorney is still in full force and effect.

GIVEN under my hand and seal of said Company at Fairfield, Ohio, this 12th day of July, 2010



Secretary



CERTIFICATE OF LIABILITY INSURANCE

DATE (MM/DD/YYYY)
7/9/2010

PRODUCER (540)389-2327 FAX: (540)389-5901
 Humphrey Stump & Haynie Insurance Agency, Inc
 100 E. Main Street
 P.O. Box 3205
 Salem VA 24153

THIS CERTIFICATE IS ISSUED AS A MATTER OF INFORMATION ONLY AND CONFERS NO RIGHTS UPON THE CERTIFICATE HOLDER. THIS CERTIFICATE DOES NOT AMEND, EXTEND OR ALTER THE COVERAGE AFFORDED BY THE POLICIES BELOW.

INSURED
 Lee Hartman & Sons, Inc.
 P.O. Box 13365
 Roanoke VA 24033-3365

INSURERS AFFORDING COVERAGE	NAIC #
INSURER A: Cincinnati Insurance Company	10677
INSURER B: Accident Fund National Ins Co	12305
INSURER C:	
INSURER D:	
INSURER E:	

COVERAGES

THE POLICIES OF INSURANCE LISTED BELOW HAVE BEEN ISSUED TO THE INSURED NAMED ABOVE FOR THE POLICY PERIOD INDICATED. NOTWITHSTANDING ANY REQUIREMENT, TERM OR CONDITION OF ANY CONTRACT OR OTHER DOCUMENT WITH RESPECT TO WHICH THIS CERTIFICATE MAY BE ISSUED OR MAY PERTAIN, THE INSURANCE AFFORDED BY THE POLICIES DESCRIBED HEREIN IS SUBJECT TO ALL THE TERMS, EXCLUSIONS AND CONDITIONS OF SUCH POLICIES. AGGREGATE LIMITS SHOWN MAY HAVE BEEN REDUCED BY PAID CLAIMS.

INSR / ADD'L LTR / INSRD	TYPE OF INSURANCE	POLICY NUMBER	POLICY EFFECTIVE DATE (MM/DD/YYYY)	POLICY EXPIRATION DATE (MM/DD/YYYY)	LIMITS
A	GENERAL LIABILITY <input checked="" type="checkbox"/> COMMERCIAL GENERAL LIABILITY <input type="checkbox"/> CLAIMS MADE <input checked="" type="checkbox"/> OCCUR	CPP0834074	10/1/2009	10/1/2010	EACH OCCURRENCE \$ 1,000,000
	GEN'L AGGREGATE LIMIT APPLIES PER: <input checked="" type="checkbox"/> POLICY <input type="checkbox"/> PRO-JECT <input type="checkbox"/> LOC				DAMAGE TO RENTED PREMISES (Ea occurrence) \$ 500,000 MED EXP (Any one person) \$ 10,000 PERSONAL & ADV INJURY \$ 1,000,000 GENERAL AGGREGATE \$ 2,000,000 PRODUCTS - COMP/OP AGG \$ 2,000,000
A	AUTOMOBILE LIABILITY <input checked="" type="checkbox"/> ANY AUTO <input type="checkbox"/> ALL OWNED AUTOS <input type="checkbox"/> SCHEDULED AUTOS <input checked="" type="checkbox"/> HIRED AUTOS <input checked="" type="checkbox"/> NON-OWNED AUTOS <input checked="" type="checkbox"/> Hired Car Physical Damage - \$50,000	CPP0834074	10/1/2009	10/1/2010	COMBINED SINGLE LIMIT (Ea accident) \$ 1,000,000
					BODILY INJURY (Per person) \$
					BODILY INJURY (Per accident) \$
					PROPERTY DAMAGE (Per accident) \$
	GARAGE LIABILITY <input type="checkbox"/> ANY AUTO				AUTO ONLY - EA ACCIDENT \$ OTHER THAN AUTO ONLY: EA ACC \$ AGG \$
A	EXCESS / UMBRELLA LIABILITY <input checked="" type="checkbox"/> OCCUR <input type="checkbox"/> CLAIMS MADE	CPP0834074	10/1/2009	10/1/2010	EACH OCCURRENCE \$ 3,000,000
	<input type="checkbox"/> DEDUCTIBLE <input type="checkbox"/> RETENTION \$				AGGREGATE \$ 3,000,000 \$ \$ \$
B	WORKERS COMPENSATION AND EMPLOYERS' LIABILITY ANY PROPRIETOR/PARTNER/EXECUTIVE OFFICER/MEMBER EXCLUDED? (Mandatory in NH) If yes, describe under SPECIAL PROVISIONS below	WCV6049063	10/1/2009	10/1/2010	<input checked="" type="checkbox"/> WC STATUTORY LIMITS <input type="checkbox"/> OTHER E.L. EACH ACCIDENT \$ 500,000 E.L. DISEASE - EA EMPLOYEE \$ 500,000 E.L. DISEASE - POLICY LIMIT \$ 500,000
A	OTHER Installation Floater	CPP0834074	10/1/2009	10/1/2010	Limit \$100,000

DESCRIPTION OF OPERATIONS / LOCATIONS / VEHICLES / EXCLUSIONS ADDED BY ENDORSEMENT / SPECIAL PROVISIONS

CERTIFICATE HOLDER

STATE OF WEST VIRGINIA
 DEPT OF ADMINISTRATION
 PURCHASING DIVISION
 2019 WASHINGTON ST., EAST
 PO BOX 50130
 CHARLESTON, WV 25305-0130

CANCELLATION

SHOULD ANY OF THE ABOVE DESCRIBED POLICIES BE CANCELLED BEFORE THE EXPIRATION DATE THEREOF, THE ISSUING INSURER WILL ENDEAVOR TO MAIL 15 DAYS WRITTEN NOTICE TO THE CERTIFICATE HOLDER NAMED TO THE LEFT, BUT FAILURE TO DO SO SHALL IMPOSE NO OBLIGATION OR LIABILITY OF ANY KIND UPON THE INSURER, ITS AGENTS OR REPRESENTATIVES.

AUTHORIZED REPRESENTATIVE
 Cecelia Long/CECELI *Cecelia Long*

52" CLASS (52.0" DIAGONAL)

M5201C-BA

LCD
MONITOR

LCD Widescreen Full HD Capable Monitor

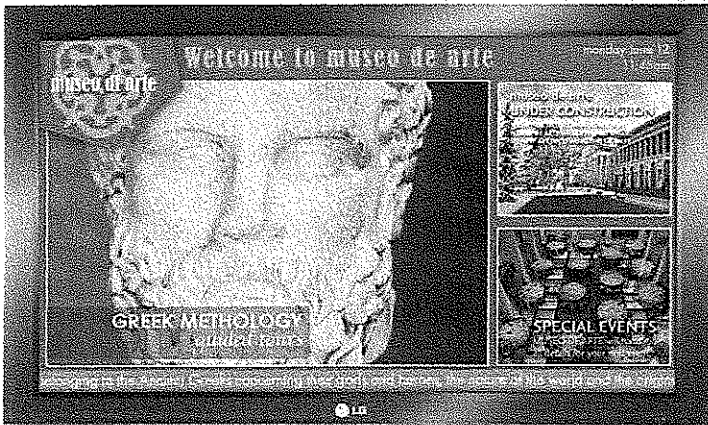

FULL HD 1080p RESOLUTION
1920 x 1080 WUXGA

 3 POWER SAVING LEVELS

CONTRAST RATIO
1,600:1, 800:1 (DCR)

HIGH BRIGHTNESS
500 cd/m²

SPLIT ZOOM (self video wall)
Up to 4 x 4 matrix - adjusts for bezel width

LG EXCLUSIVE XD ENGINE[®]

TEMPERATURE AND LAMP FAULT SENSOR

HDMI™/DVI WITH HDCP

RS-232C CONTROL

CABINET COLOR
Black

 RoHS COMPLIANT

3-YEAR LIMITED WARRANTY
(parts/labor)

www.LGcommercial.com



LG
Life's Good



M5201C-BA

52" CLASS [52.0" DIAGONAL]

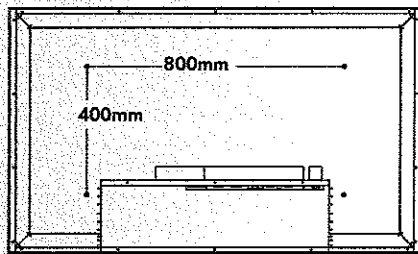
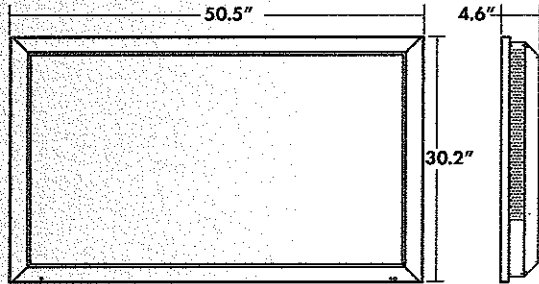

Rear Jack Pack Panel

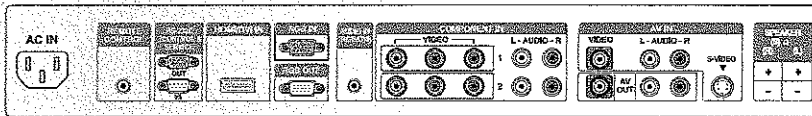

SPECIFICATIONS

LCD Panel Type	52"
Display Area	52.0"
Aspect Ratio	16 : 9
Native Resolution	1920 x 1080 (Full HD)
Pixels (H x V x 3)	6,220,800
Brightness	500 cd/m ²
Contrast Ratio	800:1 (1,600:1 DCR)
Viewing Angle (H x V)	178° x 178°
SIPS	Yes
Color Depth	1.07 Billion
Response Time	9ms(G to G)
Surface Treatment	Hard Coating (3H); Antiglare
MTBF	50,000 Hr., Portrait & Landscape

VIDEO

Max Input Resolution	D-Sub 1920 x 1080 @ 60Hz
DVID	1920 x 1080 @ 60Hz
H-Scanning Frequency	D-Sub 30 ~ 83 kHz
DVID	30 ~ 83 kHz
V-Scanning Frequency	56 ~ 85 Hz
Pixel Frequency	Max. 148.5 MHz
Sync Compatibility	Separate / Composite / Digital
Video Input	RGB Analog / Digital
EZ Video	Dynamic / Standard / Mild / User1 / User2
ACC	Warm / Normal / Cool

REAR INPUTS

Component Video	2 (480p, 720p, 1080i)
PC Input via 15-Pin Sub "D"	1
Composite Video Input/Output	1 / 1
Audio Inputs	3 Plus PC Sound
HDTV Formats	720p / 1080i
PC Formats	Auto Scaling to Full HD
HDMI/DVI with HDCP	Yes
RS-232C Input/Output	1 / 1 Female-to-Female Crossed Type
S-Video	1
Discrete IR Input	Yes
External Speaker Out	Yes

AUDIO

Surround MAX	Yes
Auto Volume Limiter	Yes
Audio Power	20W (10W x 2)
Balance	Yes
EZ Audio	Flat / Music / Movie / Sports / User

SPECIAL FEATURES

Advanced Picture In Picture	No
New Temperature Sensor	Yes
New Lamp Fault Sensor	Yes
Cooling FAN	Yes
New Split Zoom	Yes, supports natural mode
Image Zoom	No
Source Selection	Digital(HDMI/DVI) / Analog (RGB) / Component 1 & 2 / AV
Brightness/Contrast	Yes
Color	Normal, Cool, Warm / User Control (R/G/B)
Position	H / V
Tracking	Auto / Clock / Phase
Setup Language	English / French / Spanish / Korean / Italian / German / Portuguese / Japanese / Chinese
ISM Method	Normal / White Wash / Orbiter / Inversion / Orb. + Inv.
XD Engine	XD Contrast / XD Color / XD NR / MPEG NR
Advanced	Cinema / Black level
Time	Clock / Off time / On time
Special	Auto Adjust, OSD lock
Mute	Yes
Sleep Timer	Yes
Auto Power/Source Memory	Yes
Child Lock	Yes
Power Indicator	On / Off

CABINET

Color	Black
Bezel Width	63.6mm
Monitor Dimension (W x H x D)	50.5" x 30.2" x 4.6"
Weight	93.4 lbs.
Carton Dimensions (W x H x D)	55.8" x 35.4" x 15.1"
Packed Weight	108.6 lbs.
VESA™ Standard Mount Interface	800mm x 400mm (APWX60)
Accessory Stand & Speakers	None available

POWER

Power Saving	Yes, Level1 / Level2 / Level3
Power Supply	90 ~ 264V / AC (47 ~ 63Hz)
Power Type	Built-in Power
Power Switch Type	Tact Switch
Power Saving	Normal 400W
DPMS	1W (RGB) / 2W (HDMI/DVI)
Switch Off	1W

STANDARD (CERTIFICATION)

Safety	UL / c-UL / CB scheme / TUV / NEMKO
EMC	FCC Class "B" / VCCI / C-tick / CE / KCC
RoHS Compliant	Yes
UPC CODE	7 19192 18481 7



All screen images are simulated. Dimensions and weights are approximate. Design, specifications, and features subject to change without notice. HDTV monitors require an optional set-top-box to receive high-definition broadcast.

© Copyright 2010 LG Electronics USA, Inc. All Rights Reserved. LG Life's Good is a registered trademark of LG Corp.

XD Engine is a registered trademark of LG Electronics USA, Inc. VESA is a registered trademark of Video Electronics Standards Association.

All other product and brand names are trademarks or registered trademarks of their respective companies.

Printed in the USA. April 2010

www.LGcommercial.com



LG Electronics U.S.A., Inc.
Business Solutions Division
2000 Millbrook Drive
Lincolnshire, IL 60069

Customer Service: 888.865.3026

Contact your LG regional sales representative:
Vertical Markets: 800.897.8788
Channels: 800.897.8871
Hospitality: 800.228.1236
E-mail: LGcommercial@lge.com

SPEC_M5201C-BA_031011_PR

42" CLASS (42.0" DIAGONAL)

M4224C-BA

LCD
MONITOR

LCD Widescreen Full HD Capable Monitor

NATIVE DISPLAY RESOLUTION
1920 x 1080 (WUXGA) Full 1080p resolution

IMPROVED! ULTRA THIN NARROW BEZEL
16.9mm (0.67")

 BACKLIGHT CONTROL

NEW! LAN CONTROL

CONVENIENT EXTERNAL SPEAKER-OUT
INFORMATION DISPLAY FOR SERIAL NUMBER

VIEWING ANGLE and LIFE EXPECTANCY
Enhanced in Portrait Mode

SPLIT ZOOM (self video wall)
Up to 5 x 5 matrix - adjusts for bezel width

IMPROVED! HIGH BRIGHTNESS
700 cd/m²

CONTRAST RATIO
3000:1 (DCR)

HDMI™ WITH HDCP

SUPER IPS
178° Viewing Angle

OSD and REMOTE CONTROL LOCK

RS-232C CONTROL

OPTIONAL HIDDEN SPEAKERS

 RoHS COMPLIANT

3-YEAR LIMITED WARRANTY
parts/labor

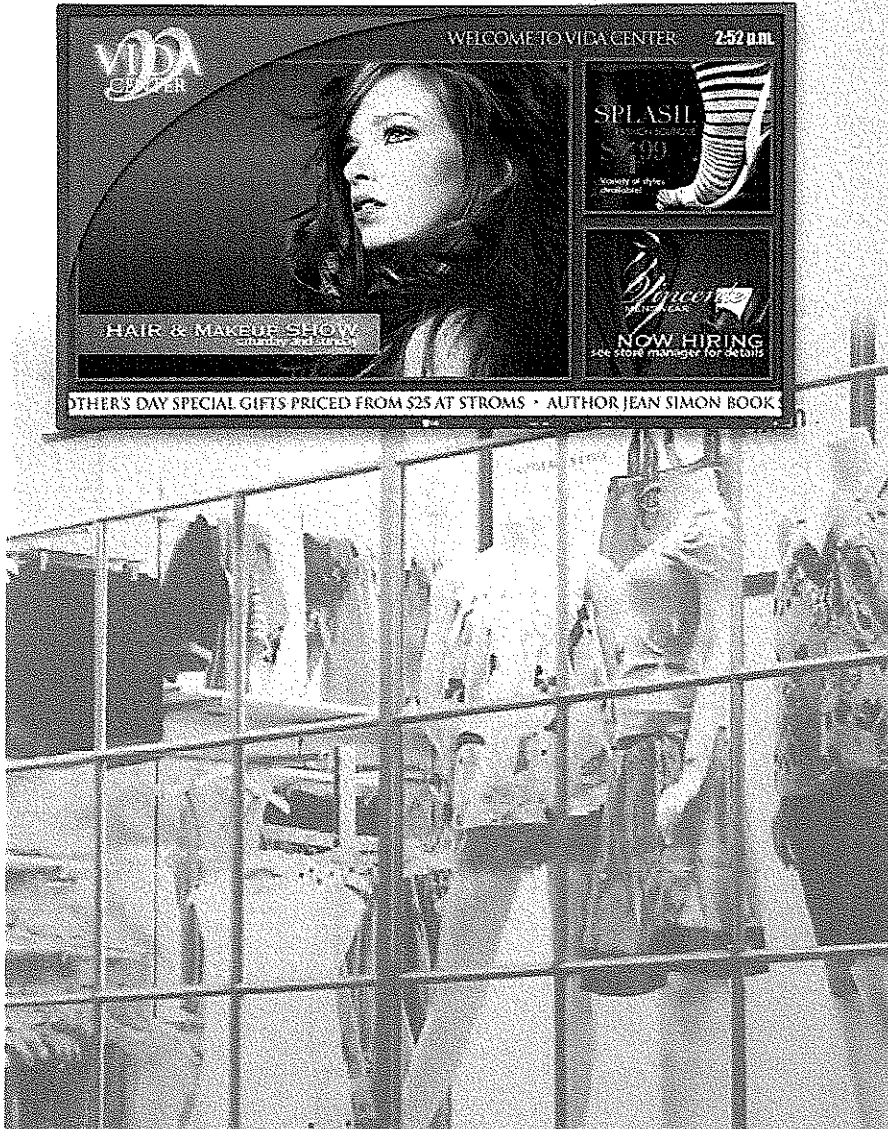

www.LGcommercial.com



LG
Life's Good

VIDEO WALL CONTROL

The content for each monitor can be easily controlled by selecting the video source per unit.

computer input video input 1 video input 2 video input 3	computer input video input 1 video input 2 video input 3	computer input video input 1 video input 2 video input 3	computer input video input 1 video input 2 video input 3	computer input video input 1 video input 2 video input 3
computer input video input 1 video input 2 video input 3	computer input video input 1 video input 2 video input 3	computer input video input 1 video input 2 video input 3	computer input video input 1 video input 2 video input 3	computer input video input 1 video input 2 video input 3
computer input video input 1 video input 2 video input 3	computer input video input 1 video input 2 video input 3	computer input video input 1 video input 2 video input 3	computer input video input 1 video input 2 video input 3	computer input video input 1 video input 2 video input 3
computer input video input 1 video input 2 video input 3	computer input video input 1 video input 2 video input 3	computer input video input 1 video input 2 video input 3	computer input video input 1 video input 2 video input 3	computer input video input 1 video input 2 video input 3
computer input video input 1 video input 2 video input 3	computer input video input 1 video input 2 video input 3	computer input video input 1 video input 2 video input 3	computer input video input 1 video input 2 video input 3	computer input video input 1 video input 2 video input 3



5 x 5 Matrix (Max)

FEATURES

HIGH BRIGHTNESS, CLEAR CONTRAST RATIO (700 nits, 10,000:1)

The M4224C sets a new standard in video performance with a brightness of 700 cd/m² and a high-contrast ratio of 10,000:1 which surpasses standard monitors.

VIEWING ANGLE AND LIFE EXPECTANCY ENHANCED IN PORTRAIT MODE

- 178 (H)/178 (V) viewing angles
- Panel life 50,000 hours (approx.) to half brightness

City	Country	Time	Area
NEW YORK	USA	12:00	100
LOS ANGELES	USA	09:00	100
TOKYO	JAPAN	21:00	100
SINGAPORE	SINGAPORE	18:00	100
HONG KONG	HONG KONG	18:00	100
SEOUL	KOREA	21:00	100
BEIJING	CHINA	00:00	100
MUMBAI	INDIA	18:00	100
SYDNEY	AUSTRALIA	00:00	100
MELBOURNE	AUSTRALIA	00:00	100
PERTH	AUSTRALIA	00:00	100
BRISBANE	AUSTRALIA	00:00	100
WELLINGTON	NEW ZEALAND	23:00	100
AUCKLAND	NEW ZEALAND	23:00	100
CHICAGO	USA	08:00	100
DALLAS	USA	08:00	100
HOUSTON	USA	08:00	100
PHOENIX	USA	08:00	100
PORTLAND	USA	08:00	100
SAN FRANCISCO	USA	08:00	100
WASHINGTON DC	USA	08:00	100
AMSTERDAM	NETHERLANDS	01:00	100
BRUSSELS	NETHERLANDS	01:00	100
PARIS	FRANCE	01:00	100
BERLIN	GERMANY	01:00	100
MOSCOW	RUSSIA	03:00	100
ST. PETERSBURG	RUSSIA	03:00	100
SYDNEY	AUSTRALIA	00:00	100
MELBOURNE	AUSTRALIA	00:00	100
PERTH	AUSTRALIA	00:00	100
BRISBANE	AUSTRALIA	00:00	100
WELLINGTON	NEW ZEALAND	23:00	100
AUCKLAND	NEW ZEALAND	23:00	100
CHICAGO	USA	08:00	100
DALLAS	USA	08:00	100
HOUSTON	USA	08:00	100
PHOENIX	USA	08:00	100
PORTLAND	USA	08:00	100
SAN FRANCISCO	USA	08:00	100
WASHINGTON DC	USA	08:00	100
AMSTERDAM	NETHERLANDS	01:00	100
BRUSSELS	NETHERLANDS	01:00	100
PARIS	FRANCE	01:00	100
BERLIN	GERMANY	01:00	100
MOSCOW	RUSSIA	03:00	100
ST. PETERSBURG	RUSSIA	03:00	100

SUPER IPS

Technology that delivers ultra-wide viewing angles. Ideal for situations where screens are positioned at different angles.

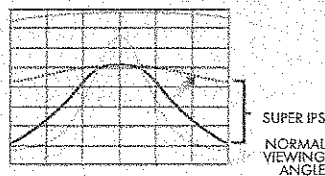
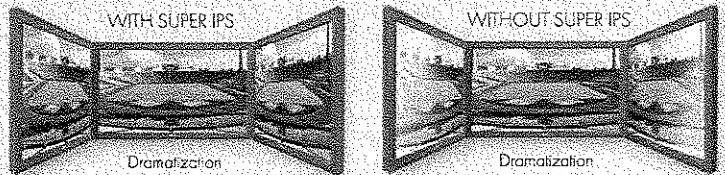

REMOTE CONTROL USING LAN OR RS-232C

- RJ45 and RS-232C jacks provide the communication interface between the set and external equipment.
- With LAN or RS-232C, functions can be executed at a distance with ease by using a remote control to manage the power on/off, color calibration, aspect ratio, etc...
- LAN control provides a convenient way to manage multiple monitors from a single control center.

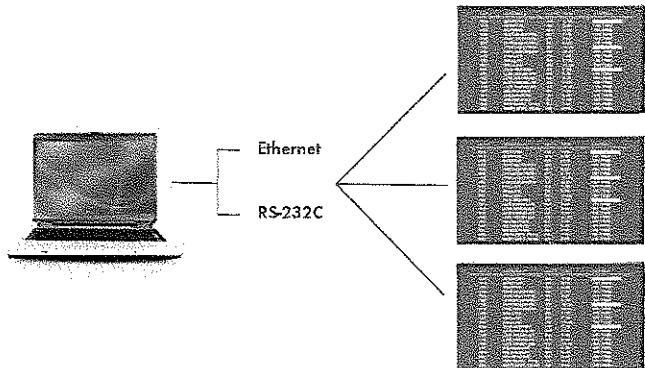

DISPLAY INFORMATION

Adjust Set ID and check Serial Number and Software Version.

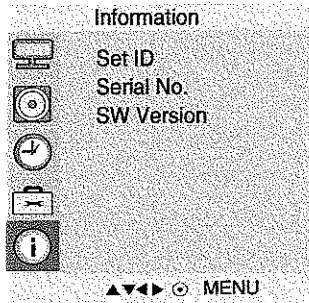

BACKLIGHT CONTROL

Controls the brightness of the screen by adjusting the LCD panel brightness. The result would be an increase in energy savings if brightness is reduced.

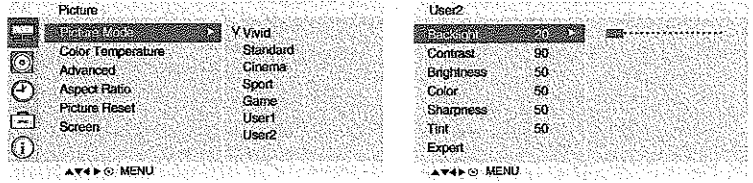

DIMENSIONS

HIDDEN SPEAKERS SP0000K [optional]

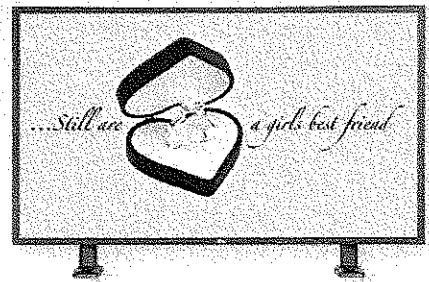
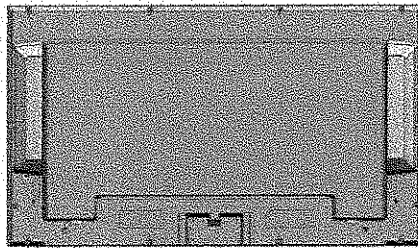
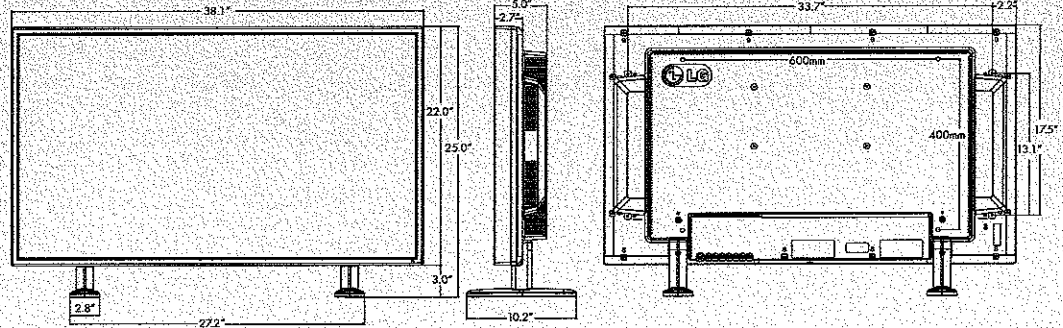
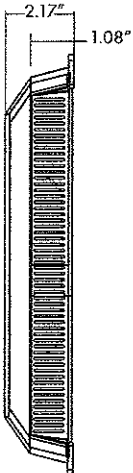
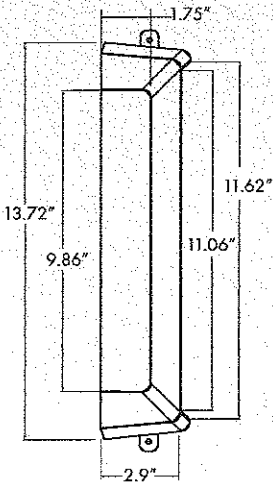

HIDDEN SPEAKERS SP0000K [optional]
 Dimensions (WxHxD) 2.9" x 13.7" x 2.2" each
 Weight 1.7 lbs [0.85 lbs x 2]
 10 Watts

Stand ST0000K [optional]
 Dimensions (WxHxD) 2.6" x 10.1" x 7.3"
 Weight 2.8 lbs [1.4 lbs x 2]

REAR JACK PANEL

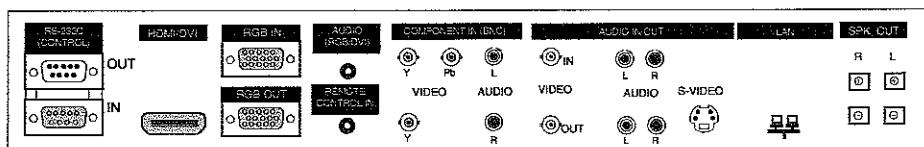



M4224C-BA

42" CLASS (42.0" DIAGONAL)



PANEL

LCD Panel Type	42"
Display Area	42.0" diagonal
Aspect Ratio	16 : 9
Native Resolution	1920 x 1080 (WUXGA)
Pixels (H x V x 3)	6,220,800
Brightness	700 cd/m2
Contrast Ratio	3,000:1 (DCR)
Viewing Angle (H x V)	178° x 178°
Super IPS	Yes
Color Depth	10.6 Billion
Response Time	9 ms (G to G)
Surface Treatment	Hard Coating (3H) Anti-glare
MTBF	50,000 Hr. (Minimum) Portrait & Landscape

VIDEO

Max Input Resolution	1920 x 1080 @ 60Hz (RGB, HDMI/DVI)
Recommended Resolution	1920 x 1080 @ 60Hz (RGB, HDMI/DVI)
H-Scanning Frequency	30 ~ 83kHz (RGB, HDMI/DVI)
V-Scanning Frequency	56 ~ 75 Hz (RGB), 60 Hz (HDMI/DVI)
Pixel Frequency	148.5 MHz (RGB, HDMI/DVI)
Sync Compatibility	Separate / Composite / Digital
Video Input	RGB, HDMI/DVI
Picture mode	Vivid/Standard/Cinema/Sports/Game/ User1/User2

Color temperature Warm/Medium/Cool/User

REAR INPUTS/OUTPUTS

Component Video	1 Hi-Res (BNC)
PC Input via 15-Pin Sub "D"	1 in / 1 out
Composite Video Input/Output	1 [BNC] / 1 [BNC]
Audio Output	1
Audio Inputs	2 Plus PC Sound
HDTV Formats	Component : 720p/1080i/1080p HDMI : 720p/1080i/1080p
PC Formats	Auto Scaling to WUXGA
HDMI with HDCP	Yes
RI45	Yes
RS-232C Input/Output	1 / 1
S-Video	1 (S-Video has a priority but there is no input mode)
Audio Jack Built-in (No Amp)	Yes
Discrete IR Input	Yes
External Speaker Out	Yes

AUDIO

Auto Volume	Yes
Balance	Yes
Audio Power	20W (10W x 2)
Speaker On/off	Yes
Sound mode	Clear Voice/Standard/Music/Cinema/ Sports/Game/User

POWER

Power Supply	100-240V~, 50/60Hz
Power Type	Built-in Power
Power Switch Type	Tact Switch
Power Saving	
Normal	200 W
Stand-by/Suspend	2W (RGB)/4W (HDMI/DVI)
DPM Off	2W (RGB)/4W (HDMI/DVI)
Switch Off	1W

SPECIAL FEATURES

Backlight Control	Yes
Temperature Sensor	Yes
Split Zoom (Self Video Wall, Max 5 x 5)	Yes, supports natural mode
Source Selection	Digital (HDMI/DVI)/Analog (RGB)/ Component/AV
Brightness/Contrast	Yes
Color	Warm/Medium/Cool User Control [R/G/B]
Position	H / V
Tracking	Auto/Clock/Phase
Set-up	Language(English/French/Spanish/ Italian/German/Portugues/ Korean/Japanese/Chinese/Russian)
ISM Method	Normal/White wash/Orbiter/ Inversion/Dot wash
Advanced	Gamma/Film mode/Black level/ Noise Reduction
Time	Clock/On/off timer/Auto sleep/ Power on Delay
Information display	Serial Number, SET ID, MNT S/W Version, LAN S/W Version
Mute	Yes
Sleep Timer	Yes
Auto Power/Source Memory	Yes
Key Lock	Yes
DPM Select	Yes

CABINET

Monitor Dimensions (WxHxD)	38.1" x 22.0" x 5.0"
Monitor Weight (WxHxD)	41.2 lbs
Monitor Dimensions w/opt. stand (WxHxD)	38.1" x 25.0" x 10.2"
Weight w/opt. stand	44.1 lbs
Monitor w/opt. stand and opt. speakers (WxHxD)	38.1" x 25.0" x 10.2"
Weight w/opt. stand and opt. speakers	45.8 lbs
Packaging (WxHxD)	38.1" x 22.1" x 4.9"
Weight with Packaging	48.0 lbs
Color	Black/Silver
VESA™ Standard Mount Interface	600mm x 400mm

STANDARD (CERTIFICATION)

Safety	UL/cUL/CB scheme/TUV/NEMKO
EMC	FCC Class "B"/VCCI/C-tick/CE/MIC
RoHS Compliant	Yes
UPC	7 19192 18545 6

SERVICE/LIMITED WARRANTY

Limited Warranty (Parts/Labor)	3 Years
--------------------------------	---------

OPTIONAL ACCESSORIES

SP0000K (speakers)	fits M4224C-BA
Dimensions (W x H x D) (each)	2.9" x 13.7" x 2.2"
Weight (2 speakers)	1.7 lbs
Packaging Dimensions (W x H x D)	15.1" x 5.3" x 6.9"
Packed Weight	2.36 lbs (2 Speakers/1 Package)
ST0000K (stand)	fits M4224C-BA
Dimensions (W x H x D)	2.6" x 10.1" x 7.3"
Weight	2.8 lbs
Packaging Dimensions (W x H x D)	12.4" x 2.8" x 11.0"
Shipping Weight	3.64 lbs.

www.LGcommercial.com

LG Electronics U.S.A., Inc.
Commercial Products Division
2000 Millbrook Drive
Lincolnshire, IL 60069

Customer Service: 888.865.3026

Contact your LG Regional Sales Representative:
Enterprise: 800.897.8788
Channel: 800.897.8871
Hospitality: 800.228.1236
E-mail: LGcommercial@lge.com

SPEC_M4224CBA_050922_PR



All screen images are simulated. Dimensions and weights are approximate. Design, features and specifications subject to change without notice.

© Copyright 2009 LG Electronics USA, Inc. All Rights Reserved. "LG Life's Good" is a registered trademark of LG Corp. In Plane Switching is a trademark of LG Philips LCD Ltd. VESA is a trademark of Video Electronics Standards Association. HDMI, the HDMI Logo and High-Definition Multimedia Interface are trademarks or registered trademarks of HDMI Licensing LLC.

All other product and brand names are trademarks or registered trademarks of their respective companies.

Printed in the USA, June 2009



VIDEO FURNITURE INTERNATIONAL

Furniture Designs That Communicate.

TP1000, Telepresence stand

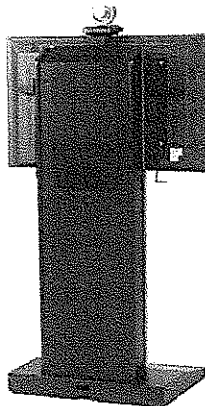
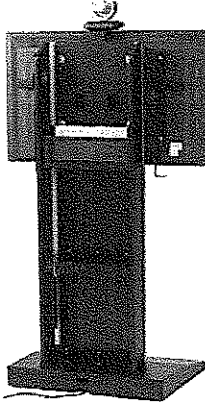

Model TP1000 Telepresence stand

VFI's Telepresence stand is designed for a clean modern look. TP1000 is a self supporting stand with built in shelves engineered for all common videoconference codecs and accessories such as switches and routers. TP1000 includes 2" casters so it can be moved if required.

This mount accommodates most 40" to 58"+ Flatpanel TV's. Max mount hole location is 800mm wide X 440mm high.

Standard Features Include:

- Heavy duty steel tube construction
- Furniture grade laminate, Aluminum and steel construction
- Base is weighted MDF laminate with steel cover.
- Accomodates 40-58 Flatscreen TV's (800mm x 440mm spacing)
- Steel 2" casters with 360 degree swivel.
- Wiring channel inside main pillar
- Adjustable height camera mount can be above or below TV.
- Adjustable TV bracket height, during setup.
- Includes codec and power supply shelves inside rear
- 6 outlet power bar with 10ft cord mounted inside

Options

- TVCB-Camera above left or right TV
- Six outlet power bar with 10 ft cord (additional)
- Colors: Other colors available with lead time.

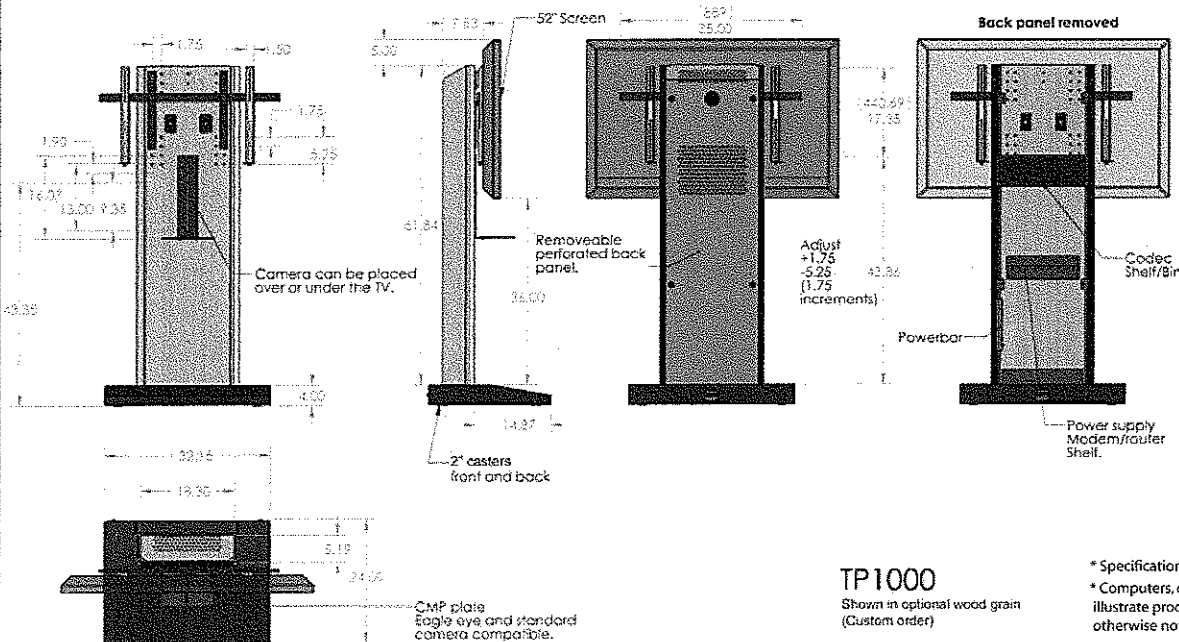

TP1000

Shown in optional wood grain (Custom order)

* Specification subject to change without notice.
* Computers, cameras, monitors, etc. are shown to illustrate product usage and are not included unless otherwise noted.

190 Don Hillock Drive . Aurora . Ontario . L4G 0G9

Tel: (905) 751-1459 Toll Free: (877) 834-3876 Fax: (905) 751-1488

sales@video-furn.com www.video-furn.com