



State of West Virginia

RFQ. NO: DNR210019

BID OPENING DATE: 09/08/09

BID OPENING TIME: 1:30 PM

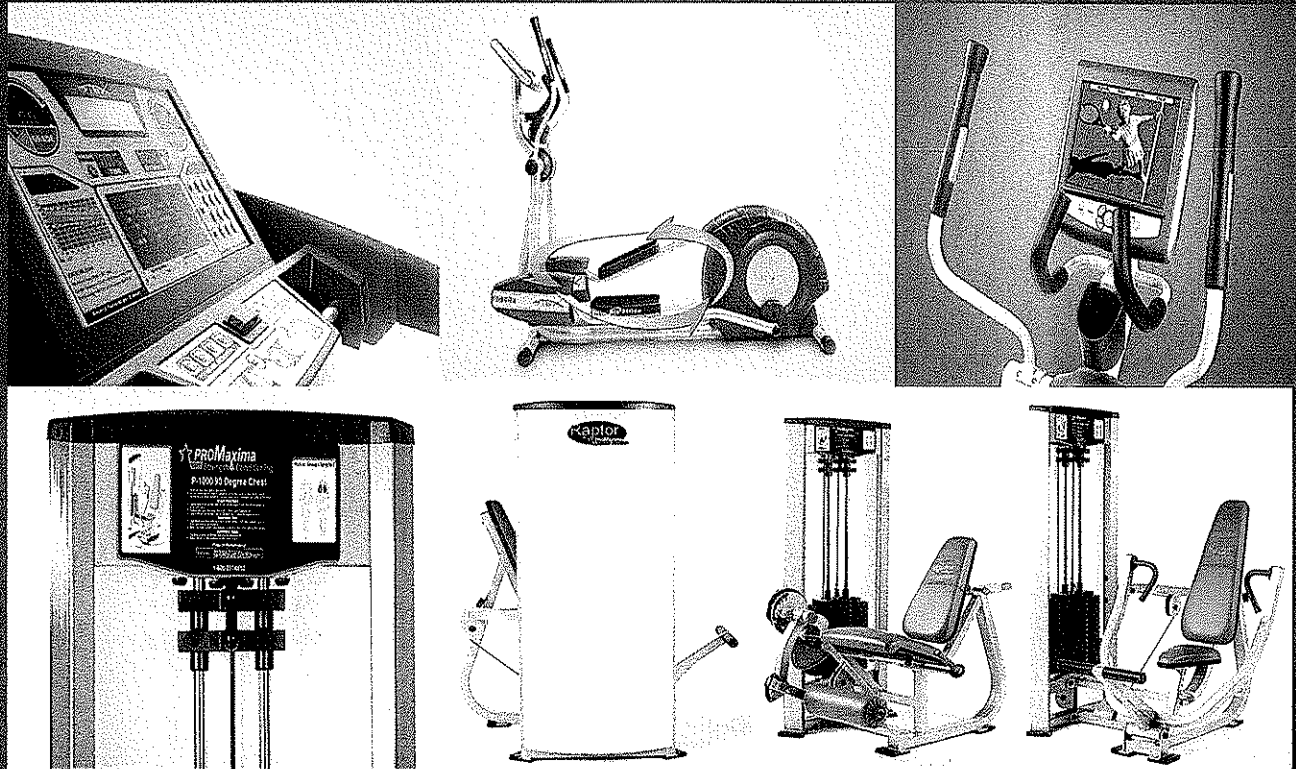
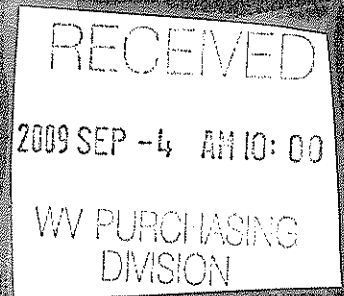

5310 Ashbrook Houston TX 77081 800.231.6652 ph: 713-667-9606 f:713-667-9941

**GENERAL TERMS & CONDITIONS
REQUEST FOR QUOTATION (RFQ) AND REQUEST FOR PROPOSAL (RFP)**

1. Awards will be made in the best interest of the State of West Virginia.
2. The State may accept or reject in part, or in whole, any bid.
3. All quotations are governed by the *West Virginia Code* and the *Legislative Rules* of the Purchasing Division.
4. Prior to any award, the apparent successful vendor must be properly registered with the Purchasing Division and have paid the required \$125 fee.
5. All services performed or goods delivered under State Purchase Order/Contracts are to be continued for the term of the Purchase Order/Contracts, contingent upon funds being appropriated by the Legislature or otherwise being made available. In the event funds are not appropriated or otherwise available for these services or goods, this Purchase Order/Contract becomes void and of no effect after June 30.
6. Payment may only be made after the delivery and acceptance of goods or services.
7. Interest may be paid for late payment in accordance with the *West Virginia Code*.
8. Vendor preference will be granted upon written request in accordance with the *West Virginia Code*.
9. The State of West Virginia is exempt from federal and state taxes and will not pay or reimburse such taxes.
10. The Director of Purchasing may cancel any Purchase Order/Contract upon 30 days written notice to the seller.
11. The laws of the State of West Virginia and the *Legislative Rules* of the Purchasing Division shall govern all rights and duties under the Contract, including without limitation the validity of this Purchase Order/Contract.
12. Any reference to automatic renewal is hereby deleted. The Contract may be renewed only upon mutual written agreement of the parties.
13. **BANKRUPTCY:** In the event the vendor/contractor files for bankruptcy protection, the State may deem this contract null and void, and terminate such contract without further order.
14. **HIPAA BUSINESS ASSOCIATE ADDENDUM:** The West Virginia State Government HIPAA Business Associate Addendum (BAA), approved by the Attorney General, and available online at the Purchasing Division's web site (<http://www.state.wv.us/admin/purchase/vrc/hipaa.htm>) is hereby made part of the agreement. Provided that, the Agency meets the definition of a Cover Entity (45 CFR §160.103) and will be disclosing Protected Health Information (45 CFR §160.103) to the vendor.
15. **WEST VIRGINIA ALCOHOL & DRUG-FREE WORKPLACE ACT:** If this Contract constitutes a public improvement construction contract as set forth in Article 1D, Chapter 21 of the West Virginia Code ("The West Virginia Alcohol and Drug-Free Workplace Act"), then the following language shall hereby become part of this Contract: "The contractor and its subcontractors shall implement and maintain a written drug-free workplace policy in compliance with the West Virginia Alcohol and Drug-Free Workplace Act, as set forth in Article 1D, Chapter 21 of the West Virginia Code. The contractor and its subcontractors shall provide a sworn statement in writing, under the penalties of perjury, that they maintain a valid drug-free work place policy in compliance with the West Virginia and Drug-Free Workplace Act. It is understood and agreed that this Contract shall be cancelled by the awarding authority if the Contractor: 1) Fails to implement its drug-free workplace policy; 2) Fails to provide information regarding implementation of the contractor's drug-free workplace policy at the request of the public authority; or 3) Provides to the public authority false information regarding the contractor's drug-free workplace policy."

INSTRUCTIONS TO BIDDERS

1. Use the quotation forms provided by the Purchasing Division.
2. **SPECIFICATIONS:** Items offered must be in compliance with the specifications. Any deviation from the specifications must be clearly indicated by the bidder. Alternates offered by the bidder as **EQUAL** to the specifications must be clearly defined. A bidder offering an alternate should attach complete specifications and literature to the bid. The Purchasing Division may waive minor deviations to specifications.
3. Complete all sections of the quotation form.
4. Unit prices shall prevail in case of discrepancy.
5. All quotations are considered F.O.B. destination unless alternate shipping terms are clearly identified in the quotation.
6. **BID SUBMISSION:** All quotations must be delivered by the bidder to the office listed below prior to the date and time of the bid opening. Failure of the bidder to deliver the quotations on time will result in bid disqualifications: Department of Administration, Purchasing Division, 2019 Washington Street East, P.O. Box 50130, Charleston, WV 25305-0130



State of West Virginia
 Department of Administration
 Purchasing Division
 2019 Washington Street East
 Post Office Box 50130
 Charleston, WV 25305-0130

Request for Quotation

RFQ NUMBER
DNR210019

PAGE
1

ADDRESS CORRESPONDENCE TO ATTENTION OF
FRANK WHITTAKER
304-558-2316

RFQ COPY

TYPE NAME/ADDRESS HERE

Promaxima MFG
5310 Ashbrook
Houston, TX 77081

DIVISION OF NATURAL RESOURCES
 CHIEF LOGAN STATE PARK
 ATTN: PARK SUPERINTENDENT

LOGAN, WV
 25601
 304-792-7125

DATE PRINTED	TERMS OF SALE	SHIP VIA	F.O.B.	FREIGHT TERMS
08/12/2009	NET 30	Promaxima	Destination	Included

BID OPENING DATE: **09/08/2009** BID OPENING TIME **01:30PM**

LINE	QUANTITY	UOP	CAT NO	ITEM NUMBER	UNIT PRICE	AMOUNT
0001	1	LS		805-57	\$66,493.00	\$66,493.00
<p>EXERCISE EQUIPMENT</p> <p>THE WEST VIRGINIA PURCHASING DIVISION, FOR THE AGENCY, THE WEST VIRGINIA DIVISION OF NATURAL RESOURCES, IS SOLICITING BIDS FROM RESPONSIBLE VENDORS TO PROVIDE EXERCISE EQUIPMENT, INCLUDING DELIVERY AND INSTALLATION IN ACCORDANCE WITH THE MANUFACTURERS RECOMMENDATIONS, PER THE ATTACHED SPECIFICATIONS.</p> <p>ALL TECHNICAL QUESTIONS MUST BE SUBMITTED IN WRITING TO FRANK WHITTAKER IN THE PURCHASING DIVISION VIA EMAIL AT FRANK.M.WHITTAKER@WV.GOV OR VIA FAX AT 304-558-4115. DEADLINE FOR TECHNICAL QUESTIONS IS 08/24/09 AT 3:00 P ALL TECHNICAL QUESTIONS WILL BE ADDRESSED BY ADDENDUM AFTER THE DEADLINE.</p> <p>BANKRUPTCY: IN THE EVENT THE VENDOR/CONTRACTOR FILES FOR BANKRUPTCY PROTECTION, THE STATE MAY DEEM THE CONTRACT NULL AND VOID, AND TERMINATE SUCH CONTRACT WITHOUT FURTHER ORDER.</p> <p>NOTICE</p> <p>A SIGNED BID MUST BE SUBMITTED TO:</p> <p>DEPARTMENT OF ADMINISTRATION PURCHASING DIVISION BUILDING 15 2019 WASHINGTON STREET, EAST CHARLESTON, WV 25305-0130</p>						

SEE REVERSE SIDE FOR TERMS AND CONDITIONS

SIGNATURE <i>John Whigley</i>	TELEPHONE 500-231-6652	DATE 9-3-09
TITLE Bid Director	FEIN 76-0578028	ADDRESS CHANGES TO BE NOTED ABOVE

WHEN RESPONDING TO RFQ, INSERT NAME AND ADDRESS IN SPACE ABOVE LABELED 'VENDOR'



State of West Virginia
 Department of Administration
 Purchasing Division
 2019 Washington Street East
 Post Office Box 50130
 Charleston, WV 25305-0130

Request for Quotation

RFQ NUMBER:
DNR210019

PAGE:
2

ADDRESS CORRESPONDENCE TO ATTENTION OF:
FRANK WHITTAKER
304-558-2316

VENDOR

RFQ COPY
 TYPE NAME/ADDRESS HERE
Promaxima MFL
5310 Ashbrook
Houston TX 77081

SHIP TO

DIVISION OF NATURAL RESOURCES
 CHIEF LOGAN STATE PARK
 ATTN: PARK SUPERINTENDENT
 LOGAN, WV
 25601
 304-792-7125

DATE PRINTED	TERMS OF SALE	SHIP VIA	F.O.B.	FREIGHT TERMS
08/12/2009	NET 30	Promaxima	Destination	Included

BID OPENING DATE: **09/08/2009** BID OPENING TIME **01:30PM**

LINE	QUANTITY	UOP	CAT NO	ITEM NUMBER	UNIT PRICE	AMOUNT
<p>THE BID SHOULD CONTAIN THIS INFORMATION ON THE FACE OF THE ENVELOPE OR THE BID MAY NOT BE CONSIDERED:</p> <p>SEALED BID</p> <p>BUYER: 44</p> <p>RFQ. NO.: DNR210019</p> <p>BID OPENING DATE: 09/08/09</p> <p>BID OPENING TIME: 1:30 PM</p> <p>PLEASE PROVIDE A FAX NUMBER IN CASE IT IS NECESSARY TO CONTACT YOU REGARDING YOUR BID: <i>713.667.9941</i></p> <p>CONTACT PERSON (PLEASE PRINT CLEARLY): <i>John Rutigliano, JR</i></p>						

SEE REVERSE SIDE FOR TERMS AND CONDITIONS

SIGNATURE <i>John Rutigliano</i>	TELEPHONE 800-231-6652	DATE 9-3-09
TITLE Bid Director	FEIN 76-057 8028	ADDRESS CHANGES TO BE NOTED ABOVE

WHEN RESPONDING TO RFQ, INSERT NAME AND ADDRESS IN SPACE ABOVE LABELED 'VENDOR'



State of West Virginia
 Department of Administration
 Purchasing Division
 2019 Washington Street East
 Post Office Box 50130
 Charleston, WV 25305-0130

Request for Quotation

RFQ NUMBER
DNR210019

PAGE
3

ADDRESS CORRESPONDENCE TO ATTENTION OF
**FRANK WHITTAKER
 304-558-2316**

RFQ COPY

TYPE NAME/ADDRESS HERE

*Proxima MFB
 5310 Ashbrook
 Houston TX 77081*

SHIP TO

DIVISION OF NATURAL RESOURCES
 CHIEF LOGAN STATE PARK
 ATTN: PARK SUPERINTENDENT

LOGAN, WV
 25601
 304-792-7125

DATE PRINTED	TERMS OF SALE	SHIP VIA	F.O.B.	FREIGHT TERMS
08/12/2009	NET 30	Proxima	Destination	Included

BID OPENING DATE: **09/08/2009** BID OPENING TIME **01:30PM**

LINE	QUANTITY	UOP	CAT NO	ITEM NUMBER	UNIT PRICE	AMOUNT
***** THIS IS THE END OF RFQ DNR210019 ***** TOTAL:						<u>\$66,493.00</u>

SEE REVERSE SIDE FOR TERMS AND CONDITIONS

SIGNATURE <i>John M...</i>	TELEPHONE <i>800-231-6652</i>	DATE <i>9-3-09</i>
TITLE <i>Bid Director</i>	FEIN <i>76-0578028</i>	ADDRESS CHANGES TO BE NOTED ABOVE

WHEN RESPONDING TO RFQ, INSERT NAME AND ADDRESS IN SPACE ABOVE LABELED 'VENDOR'

WVDNR210019
 Chief Logan Recreation Center
 FITNESS EQUIPMENT LIST

Please complete the below information concerning the brand(s) of equipment being bid in relation to this project. If bidding in or equal inch brands, please attach manufacturer's literature documenting that it meets the mandatory requirements stated in the specifications. Vendors should note the areas of the provided manufacturer's literature that adheres to the mandatory requirements outlined in the Request For Quotation.

Item No.	Equipment	Manufacturer	Model
1	Leg Press	Promaxima	P-5000
2	Leg Extension	Promaxima	P-5100
3	Seated Leg Curl	Promaxima	P-5300
4	Inner Thigh	Promaxima	P-6300A
5	Out Thigh	Promaxima	P-6300B
6	Chest Press	Promaxima	P-1000
7	Shoulder Press	Promaxima	P-2000
8	Pectoral Fly	Promaxima	P-1400
9	Lat Pulldown	Promaxima	P-4100
10	Seated Row	Promaxima	P-4000
11	Biceps Curl	Promaxima	P-3000
12	Triceps Extension	Promaxima	P-3100
13	Low Back Extension	Promaxima	P-6000
14	Abdominal	Promaxima	P-6100

WVDNR210019
Chief Logan Recreation Center
FITNESS EQUIPMENT LIST

10

Item No.	Equipment	Manufacturer	Model
15	Rotary Torso	Promaxima	P-6200
16	Cable Crossover	Promaxima	P-7200
17	Max Rack or equal	Promaxima	PLR-955
18	Dip Unit	Promaxima	FW-23
19	Adjustable Benches	Promaxima	FW-150
20	Rubber Coated Hex Dumbbells 5 lbs. - 50lbs. (5 lb. Increments)	Promaxima	HexR-SET 1
21	Dumbbell Rack	Promaxima	FW-15
22	Rubber Coated Olympic Plates - 45 lb.	Promaxima	EZR-45
23	Rubber Coated Olympic Plates - 35 lb.	Promaxima	EZR-35
24	Rubber Coated Olympic Plates - 25 lb.	Promaxima	EZR-25
25	Rubber Coated Olympic Plates - 10 lb.	Promaxima	EZR-10
26	Rubber Coated Olympic Plates - 5 lb.	Promaxima	EZR-05
27	Rubber Coated Olympic Plates - 2.5 lb.	Promaxima	EZR-02.5
28	Rubber Coated Fixed Curl Bar 20 lbs. - 60 lbs. (10 lb. Increments)	Promaxima	BB-806R
29	Rubber Coated Fixed Straight Bar 20 lbs. - 60 lbs. (10 lb. Increments)	Promaxima	BB-806R
30	Fixed Bar Rack	Promaxima	FW-69
31	Commercial Treadmill	Promaxima - STEX	CV-8025TW

WVDNR210019
Chief Logan Recreation Center
FITNESS EQUIPMENT LIST

11

Item No.	Equipment	Manufacturer	Model
32	Commercial Elliptical Trainer	Promaxima - STEX	CV-8020E

Chief Logan Recreation Center
FITNESS EQUIPMENT PRICING SHEET

Item No.	Quantity	Description	Unit Price	Amount
1	1	Leg Press	#1975.00	#1975.00
2	1	Leg Extension	#1975.00	#1975.00
3	1	Seated Leg Curl	#1975.00	#1975.00
4	1	Inner Thigh	#1975.00	#1975.00
5	1	Out Thigh	#1975.00	#1975.00
6	1	Chest Press	#1975.00	#1975.00
7	1	Shoulder Press	#1975.00	#1975.00
8	1	Pectoral Fly	#1975.00	#1975.00
9	1	Lateral Pulldown	#1975.00	#1975.00
10	1	Seated Row	#1975.00	#1975.00
11	1	Biceps Curl	#1975.00	#1975.00
12	1	Triceps Extension	#1975.00	#1975.00
13	1	Low Back Extension	#1975.00	#1975.00
14	1	Abdominal	#1975.00	#1975.00
15	1	Rotary Torso	#1975.00	#1975.00
16	1	Cable Crossover	#2275.00	#2275.00
17	1	Max Rack	#1975.00	#1975.00
18	1	Dip Unit	#275.00	#275.00

Chief Logan Recreation Center
FITNESS EQUIPMENT PRICING SHEET

Item No.	Quantity	Description	Unit Price	Amount
19	3	Adjustable Benches	\$275.00	\$825.00
20	10	Rubber Coated Hex Dumbbells 5 lbs. - 50 lbs. (5 lb. increments)	\$60.5	\$605.00
21	1	Dumbbell Rack	\$247.50	\$247.50
22	6	Rubber Coated Olympic Plates - 45 lb.	\$52.00	\$312.00
23	2	Rubber Coated Olympic Plates - 35 lb.	\$40.00	\$80.00
24	2	Rubber Coated Olympic Plates - 25 lb.	\$29.00	\$58.00
25	4	Rubber Coated Olympic Plates - 10 lb.	\$12.00	\$48.00
26	2	Rubber Coated Olympic Plates - 5 lb.	\$6.00	\$12.00
27	2	Rubber Coated Olympic Plates - 2.5 lb.	\$2.75	\$5.50
28	5	Rubber Coated Fixed Curl Bar 20 lbs. - 60 lbs. (10 lb. Increments)	\$101.00	\$505.00
29	5	Rubber Coated Fixed Straight Bar 20 lbs. - 60 lbs. (10 lb. Increments)	\$101.00	\$505.00
30	1	Fixed Bar Rack	\$247.00	\$247.00
31	4	Commercial Treadmill	\$4599.00	\$18,396.00
32	3	Commercial Elliptical Trainer	\$3499.00	\$10,497.00
TOTALS:				\$66,493.00

State of West Virginia VENDOR PREFERENCE CERTIFICATE

Certification and application* is hereby made for Preference in accordance with *West Virginia Code*, §5A-3-37. (Does not apply to construction contracts). *West Virginia Code*, §5A-3-37, provides an opportunity for qualifying vendors to request (at the time of bid) preference for their residency status. Such preference is an evaluation method only and will be applied only to the cost bid in accordance with the *West Virginia Code*. This certificate for application is to be used to request such preference. The Purchasing Division will make the determination of the Resident Vendor Preference, if applicable.

1. **Application is made for 2.5% resident vendor preference for the reason checked:**
 Bidder is an individual resident vendor and has resided continuously in West Virginia for four (4) years immediately preceding the date of this certification; or,
 Bidder is a partnership, association or corporation resident vendor and has maintained its headquarters or principal place of business continuously in West Virginia for four (4) years immediately preceding the date of this certification; or 80% of the ownership interest of Bidder is held by another individual, partnership, association or corporation resident vendor who has maintained its headquarters or principal place of business continuously in West Virginia for four (4) years immediately preceding the date of this certification; or,
 Bidder is a nonresident vendor which has an affiliate or subsidiary which employs a minimum of one hundred state residents and which has maintained its headquarters or principal place of business within West Virginia continuously for the four (4) years immediately preceding the date of this certification; or,
2. **Application is made for 2.5% resident vendor preference for the reason checked:**
 Bidder is a resident vendor who certifies that, during the life of the contract, on average at least 75% of the employees working on the project being bid are residents of West Virginia who have resided in the state continuously for the two years immediately preceding submission of this bid; or,
3. **Application is made for 2.5% resident vendor preference for the reason checked:**
 Bidder is a nonresident vendor employing a minimum of one hundred state residents or is a nonresident vendor with an affiliate or subsidiary which maintains its headquarters or principal place of business within West Virginia employing a minimum of one hundred state residents who certifies that, during the life of the contract, on average at least 75% of the employees or Bidder's affiliate's or subsidiary's employees are residents of West Virginia who have resided in the state continuously for the two years immediately preceding submission of this bid; or,
4. **Application is made for 5% resident vendor preference for the reason checked:**
 Bidder meets either the requirement of both subdivisions (1) and (2) or subdivision (1) and (3) as stated above; or,
5. **Application is made for 3.5% resident vendor preference who is a veteran for the reason checked:**
 Bidder is an individual resident vendor who is a veteran of the United States armed forces, the reserves or the National Guard and has resided in West Virginia continuously for the four years immediately preceding the date on which the bid is submitted; or,
6. **Application is made for 3.5% resident vendor preference who is a veteran for the reason checked:**
 Bidder is a resident vendor who is a veteran of the United States armed forces, the reserves or the National Guard, if, for purposes of producing or distributing the commodities or completing the project which is the subject of the vendor's bid and continuously over the entire term of the project, on average at least seventy-five percent of the vendor's employees are residents of West Virginia who have resided in the state continuously for the two immediately preceding years.

Bidder understands if the Secretary of Revenue determines that a Bidder receiving preference has failed to continue to meet the requirements for such preference, the Secretary may order the Director of Purchasing to: (a) reject the bid; or (b) assess a penalty against such Bidder in an amount not to exceed 5% of the bid amount and that such penalty will be paid to the contracting agency or deducted from any unpaid balance on the contract or purchase order.

By submission of this certificate, Bidder agrees to disclose any reasonably requested information to the Purchasing Division and authorizes the Department of Revenue to disclose to the Director of Purchasing appropriate information verifying that Bidder has paid the required business taxes, provided that such information does not contain the amounts of taxes paid nor any other information deemed by the Tax Commissioner to be confidential.

Under penalty of law for false swearing (*West Virginia Code*, §61-5-3), Bidder hereby certifies that this certificate is true and accurate in all respects; and that if a contract is issued to Bidder and if anything contained within this certificate changes during the term of the contract, Bidder will notify the Purchasing Division in writing immediately.

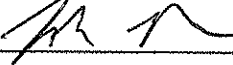
Bidder: Promaxima MFG Signed: 
 Date: 9-3-09 Title: Bid Director

*Check any combination of preference consideration(s) indicated above, which you are entitled to receive.

We Do NOT qualify for this preference.

STATE OF WEST VIRGINIA
Purchasing Division**PURCHASING AFFIDAVIT****VENDOR OWING A DEBT TO THE STATE:**

West Virginia Code §5A-3-10a provides that: No contract or renewal of any contract may be awarded by the state or any of its political subdivisions to any vendor or prospective vendor when the vendor or prospective vendor or a related party to the vendor or prospective vendor is a debtor and the debt owed is an amount greater than one thousand dollars in the aggregate.

PUBLIC IMPROVEMENT CONTRACTS & DRUG-FREE WORKPLACE ACT:

If this is a solicitation for a public improvement construction contract, the vendor, by its signature below, affirms that it has a written plan for a drug-free workplace policy in compliance with Article 1D, Chapter 21 of the *West Virginia Code*. The vendor **must** make said affirmation with its bid submission. Further, public improvement construction contract may not be awarded to a vendor who does not have a written plan for a drug-free workplace policy in compliance with Article 1D, Chapter 21 of the *West Virginia Code* and who has not submitted that plan to the appropriate contracting authority in timely fashion. For a vendor who is a subcontractor, compliance with Section 5, Article 1D, Chapter 21 of the *West Virginia Code* may take place before their work on the public improvement is begun.

ANTITRUST:

In submitting a bid to any agency for the state of West Virginia, the bidder offers and agrees that if the bid is accepted the bidder will convey, sell, assign or transfer to the state of West Virginia all rights, title and interest in and to all causes of action it may now or hereafter acquire under the antitrust laws of the United States and the state of West Virginia for price fixing and/or unreasonable restraints of trade relating to the particular commodities or services purchased or acquired by the state of West Virginia. Such assignment shall be made and become effective at the time the purchasing agency tenders the initial payment to the bidder.

I certify that this bid is made without prior understanding, agreement, or connection with any corporation, firm, limited liability company, partnership or person or entity submitting a bid for the same materials, supplies, equipment or services and is in all respects fair and without collusion or fraud. I further certify that I am authorized to sign the certification on behalf of the bidder or this bid.

LICENSING:

Vendors must be licensed and in good standing in accordance with any and all state and local laws and requirements by any state or local agency of West Virginia, including, but not limited to, the West Virginia Secretary of State's Office, the West Virginia Tax Department, West Virginia Insurance Commission, or any other state agencies or political subdivision. Furthermore, the vendor must provide all necessary releases to obtain information to enable the Director or spending unit to verify that the vendor is licensed and in good standing with the above entities.

CONFIDENTIALITY:

The vendor agrees that he or she will not disclose to anyone, directly or indirectly, any such personally identifiable information or other confidential information gained from the agency, unless the individual who is the subject of the information consents to the disclosure in writing or the disclosure is made pursuant to the agency's policies, procedures and rules. Vendor further agrees to comply with the Confidentiality Policies and Information Security Accountability Requirements, set forth in <http://www.state.wv.us/admin/purchase/privacy/noticeConfidentiality.pdf>.

Under penalty of law for false swearing (*West Virginia Code* §61-5-3), it is hereby certified that the vendor affirms and acknowledges the information in this affidavit and is in compliance with the requirements as stated.

Vendor's Name: Promaxima MFGAuthorized Signature: Date: 9-3-09

QUOTE

Promaxima Manufacturing, LTD

5310 Ashbrook
Houston, TX 77081
(800) 231-6652
Fax: (713) 667-9941

QUOTE NUMBER: 0072890

QUOTE DATE: 9/3/09

EXPIRATION DATE: 12/31/99

CUSTOMER NO: 00-ST25305

QUOTE TO:

STATE OF WEST VIRGINIA
DEPARTMENT OF ADMINISTRATION
PURCHASING DIVISION
2019 WASHINGTON STREET EAST
Charleston, WV 25305-0130

ATTN: FRANK WHITAKER
Phone: 304-558-2316
Fax:

SHIP TO:

DIVISION OF NATURAL RESOURCES
CHIEF LOGAN STATE PARK
Logan, WV 25601

DELIVERY INFO:

SALESPERSON: John Rutigliano Jr

CUSTOMER P.O.	SHIP VIA	F.O.B.	TERMS
			Due on Delivery

REQD	QUANTITY	ITEM NO. DROP SHIP?	DESCRIPTION	UNIT PRICE	AMOUNT
			RFQ NUMBER DNR210019 *****		
	1	P-5000	Raptor Seated Leg Press, 300 lb. Weight Stack	1,975.00	1,975.00
	1	P-5100	Raptor Leg Extension With Range Of Motion And Limiter, 225 lb. Weight Stack	1,975.00	1,975.00
	1	P-5300	Raptor Seated Leg Curl With Range of Motion And Limiter 225 lb. Weight Stack	1,975.00	1,975.00
	1	P-6300A	Raptor Adduction with 225lb Weight Stack	1,975.00	1,975.00
	1	P-6300B	Raptor Abduction with 225lb Weight Stack	1,975.00	1,975.00
	1	P-1000	Raptor Vertical Chest Press, 300 lb. Weight Stack	1,975.00	1,975.00
	1	P-2000	Raptor Shoulder Press, 225 lb. Weight Stack	1,975.00	1,975.00
	1	P-1400	Raptor Butterfly Contractor With Range Of Motion 225 lb. Weight Stack	1,975.00	1,975.00
	1	P-4100	Raptor Hi Lat Pull With Revolving Handles 225 lb. Weight Stack	1,975.00	1,975.00
	1	P-4000	Raptor Seated Row, 225 lb. Weight Stack	1,975.00	1,975.00
	1	P-3000	Raptor Bicep Curl, 150 lb. Weight Stack	1,975.00	1,975.00
	1	P-3100	Raptor Tricep Extension, 150 lb. Weight Stack	1,975.00	1,975.00
	1	P-6000	Raptor Low Back Extension 150lb Weight Stack	1,975.00	1,975.00
	1	P-6100	Raptor Abdominal Crunch, 150 lb. Weight Stack	1,975.00	1,975.00
	1	P-6200	Raptor Rotary Torso With Range Of Motion 150 lb. Weight Stack	1,975.00	1,975.00
	1	P-7200	Raptor Adjustable Cable Cross Over With 2- 150 lb. Weight Stacks	2,275.00	2,275.00
	1	PLR-955	Smith Machine 3" x 3" Steel Frame With Linear Bearings & 2" Case Hardened Steel Guide Rods, 7 - Degree Lifting Angle, Rotating Counter Balance Lifting Bar Starting At 10lbs., 6 - Laser Notched Slots On Each Side Accommodates All User Heights, Stainless Steel Weight Plate Holders	1,975.00	1,975.00
	1	FW-23	Hip Flexion & Dip Stand	275.00	275.00
	3	FW-150	Adjustable Deluxe Work Bench 0 to 90 Degrees, No Pop Pin. Foot Lever Back Pad Adjustment. Seat Lock Out Adjustment System, Wheels For Easy Movement	275.00	825.00
	1	HEXR-SET1	5 to 50lb. Set 5lb. Increments Hex Rubber Dumbbell Set- 10 Pairs (550 lbs total weight)	605.00	605.00
	1	FW-15	2 - Tier, Dumbbell Rack Without Saddles Comm'l Model	247.50	247.50
	6	EZR-45	CC Rubber EZ Grip Plate 45lb	52.00	312.00
	2	EZR-35	CC Rubber EZ Grip Plates 35lbs	40.00	80.00

QUOTE

Promaxima Manufacturing, LTD

5310 Ashbrook
Houston, TX 77081
(800) 231-6652
Fax: (713) 667-9941

QUOTE NUMBER: 0072890

QUOTE DATE: 9/3/09

EXPIRATION DATE: 12/31/99

CUSTOMER NO: 00-ST25305

QUOTE TO:

STATE OF WEST VIRGINIA
DEPARTMENT OF ADMINISTRATION
PURCHASING DIVISION
2019 WASHINGTON STREET EAST
Charleston, WV 25305-0130

SHIP TO:

DIVISION OF NATURAL RESOURCES
CHIEF LOGAN STATE PARK
Logan, WV 25601

ATTN: FRANK WHITAKER
Phone: 304-558-2316
Fax:

DELIVERY INFO:

SALESPERSON: John Rutigliano Jr

CUSTOMER P.O.	SHIP VIA	F.O.B.	TERMS
			Due on Delivery

QUANTITY REQD	ITEM NO. DROP SHIP?	DESCRIPTION	UNIT PRICE	AMOUNT
2	EZR-25	CC Rubber EZ Grip Plates 25lbs	29.00	58.00
4	EZR-10	CC Rubber EZ Grip Plates 10lbs	12.00	48.00
2	EZR-05	CC Rubber EZ Grip Plates 5lbs	6.00	12.00
2	EZR-02.5	CC Rubber EZ Grip Plates 2.5lbs	2.75	5.50
1	BB-806R	20 - 60 lb.Set Rubber Encased Straight Barball Solid Ends, (10lb. Increments)	505.00	505.00
1	BB-806R	20 - 60 lb.Set Rubber Encased EZ Curl Barball Solid Ends, (10lb. Increments)	505.00	505.00
1	FW-69	10-Bar Barbell Rack With Wear Frame Protective Guard	247.00	247.00
4	CV-8025TW	8025TW FULL COMMERCIAL UNLIMITED USE TREADMILL: 5.5 hp. AC Continuous Duty Motor, Maintenance Free Brushless Motor, 22" x 64" 4 Ply Self-Lubricating Running Belt, 500lbs User Weight Capacity, Speed .5 to 15 MPH, 0 to 16% Elevation, Shock Absorp tion Deck System, 20 Programs, I Pod Compatible, Pre- Wired For Optional Samsung TV Entertainment System, Polar Contact Heart Rate & Polar Receiver, CSAFE Port, Gerkin Protocal, Army PFT, Marine PFT, Air Force PFT, Fit Test LifeTime Warranty on the M otor and Frame; 3 Years On All Parts	4,599.00	18,396.00
3	CV-8020E	8020E ELLIPTICAL CROSS TRAINER, Self Powered Automotive Alternator System, Front Drive "BioStride" Which Provides A Smooth Natural Free Workout For All Major Muscle Groups Without Any Stress To The Ankles, Knees, Hips And Back Joints; Link Six Sealed Bea ring Tracking System; 13 Programs, 20 Resistance Levels, I Pod Compatible, Pre- Wired For Optional Samsung TV Entertainment System, Polar Contact Heart Rate & Polar Receiver, Gerkin Protocal, Army PFT, Marine PFT, Air Force PFT, Fit Test , 3 Years Warra nty on all Parts ***** INCLUDES FREIGHT INSIDE DELIVERY/INSTALLATION	3,499.00	10,497.00

Net Order: 66,493.00
Sales Tax: 0.00

Order Total: 66,493.00

RAPTOR

BY PROMaxima

Standard Series Features

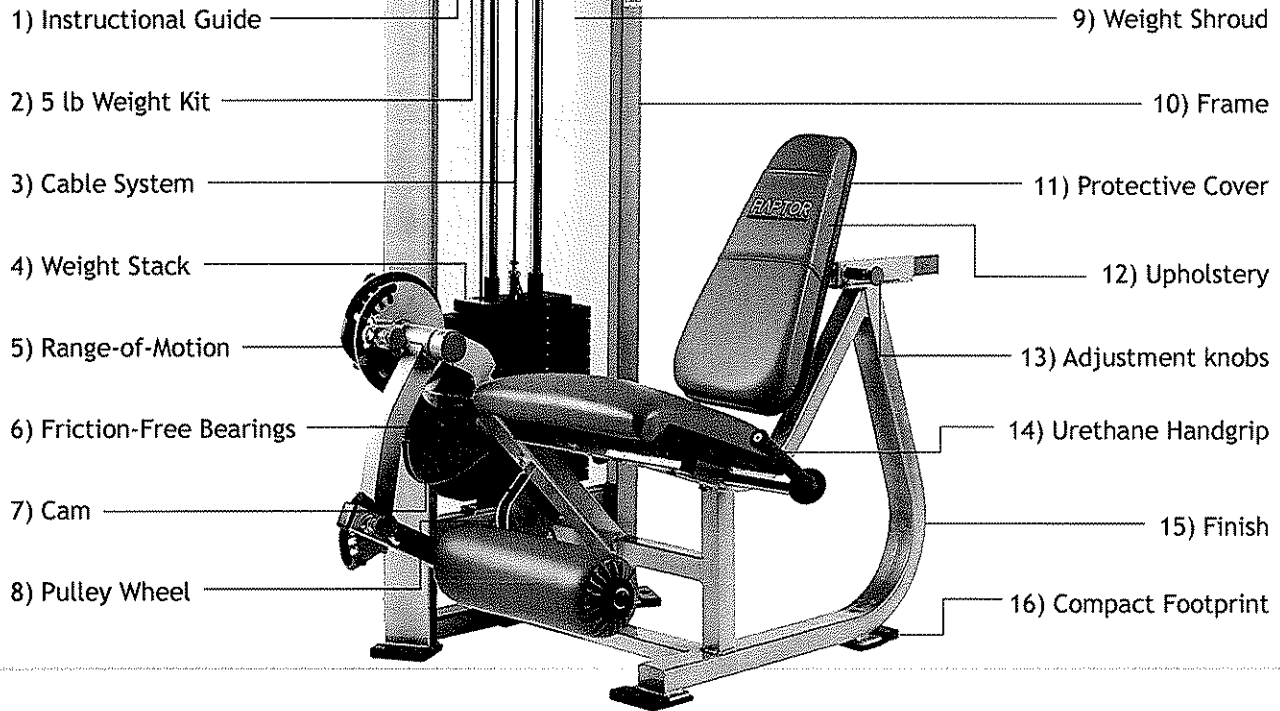

1) Instructional Guide

Instructional guide charts used to inform correct usage for each machine along with anatomical highlights to show which muscle groups are being worked.

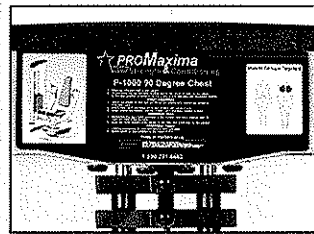

4) Weight Stack

Weight Stacks are adjusted with a tethered, magnetic selector pin that extends through the entire weight stack.

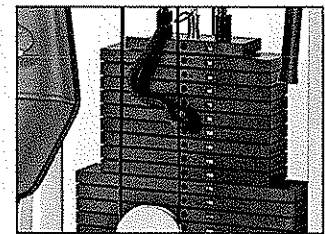

2) 5 lb Weight Kit

Weight system allows user to increase resistance by 5lb increments.

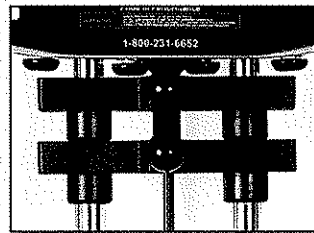

5) Range-of-Motion & Limiter

Allows exact alignment for starting and ending positions of any size athlete, which is a necessity for proper biomechanics and rehabilitation work.

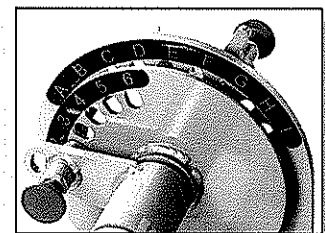

3) Cable System

1/4" thick, 4800lb test military spec galvanized and oil-impregnated aircraft cable, finished with a thick nylon coating. Manual Tension Adjusters for cable adjustments.



6) Friction-Free Bearings

Pivot points use double-sealed Radial Bearings with steel housings and line up to the human body's joints for proper biomechanics. 1-inch axis steel shaft used for maximum strength.

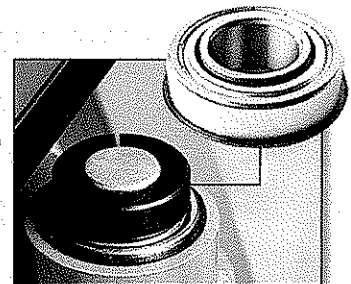

PROMaxima STRENGTH & CONDITIONING

5325 Ashbrook Drive, Houston, Texas 77081 ☎ Toll Free: 1.800.231.6652 Fax: 713.667.9941 ☎ www.ProMaximaMFG.com

7) Cam Engineered Variable Resistance

1/4" thick solid steel cams, computer-designed and laser-cut to exact spec to allow proper variable resistance throughout the complete range of motion.

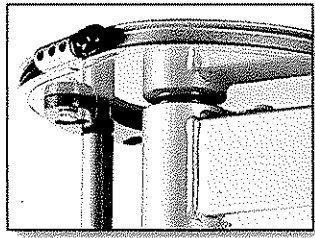

8) Pulley Wheels

5" and 6" reinforced solid web fiberglass body with a 1/2" cable groove. Oil-dipped, double-sealed racer ball bearings with 1/2" axis shaft hole. Sealed for moisture and dust-proof. 1/4" thick steel pulley housing welded directly to frame.

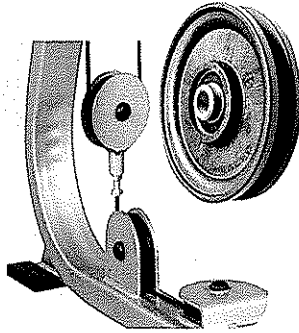

9) Weight Shroud

Weight stacks are completely enclosed in full-length shrouds.

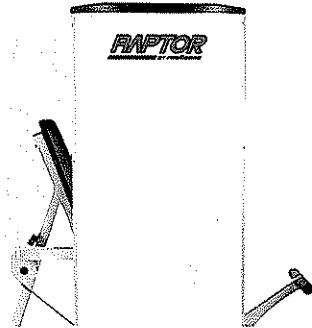

10) Frame

Constructed of high stress 2"x4", 2"x3" & 2"x2" ASTM A-500 Grade B structural carbon steel tubing (7-Gauge). All welds are ground down and stress-tested.

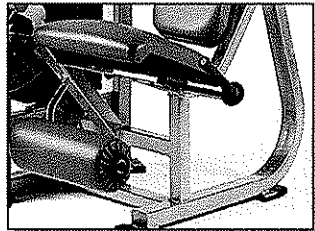

11) Protective Cover

ABS Seat and Back protective dishes.

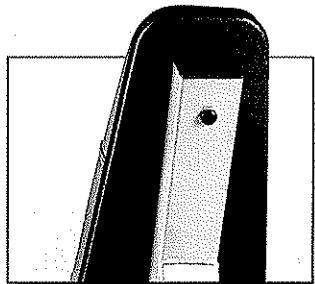

12) Upholstery

40 oz. commercial grade marine Naugahyde, Federal Specification AA-2950A (Supersedes CCCA680a), Federal Aviation Admin. FAR 25.853 (b) & Appendix F Part 1 (a)(i) (ii)(v), Boston Fire Code (BFD IX_1), Port Authority of NY & NJ, Bacteria-resistant. 3" closed cell high-density foam padding with 3/4" plywood back support.

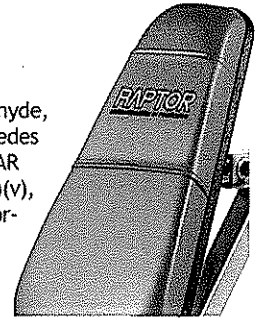

13) Adjustment Knobs

Colored pull-pin knobs allow exact positioning on all machines. They accommodate all users to ensure correct biomechanical function.

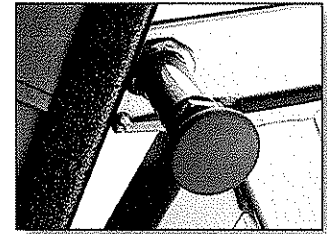

14) Urethane Handgrip

Long-lasting urethane rubber handgrips

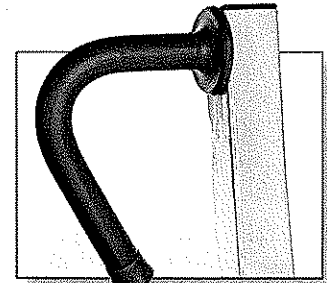

15) Finish

Magnetic powder coating process results in a flawless, uniform finish.



16) Compact Footprint

Raptor's space-efficient design helps maximize your floor space.

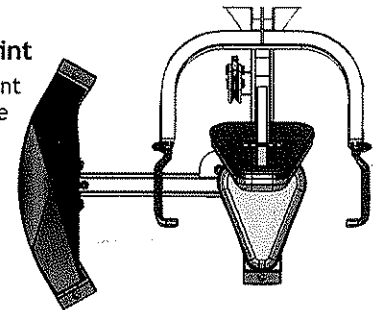

Commercial Warranty

- **Lifetime:** Frames, Welds, and Solid Steel Weight Stacks
- **5 Years:** Friction-Free Bearings, Cams, Guide Rods, Bushings & Pulley Wheels
- **2 Year:** Cables
- **1 Year:** Uphostery & Wear Items

ProMaxima STRENGTH & CONDITIONING

5325 Ashbrook Drive, Houston, Texas 77081 • Toll Free: 1.800.231.6652 Fax: 713.667.9941 • www.ProMaximaMFG.com

RAPTOR

BY *PROMAXIMA*

P-5000 Leg Press

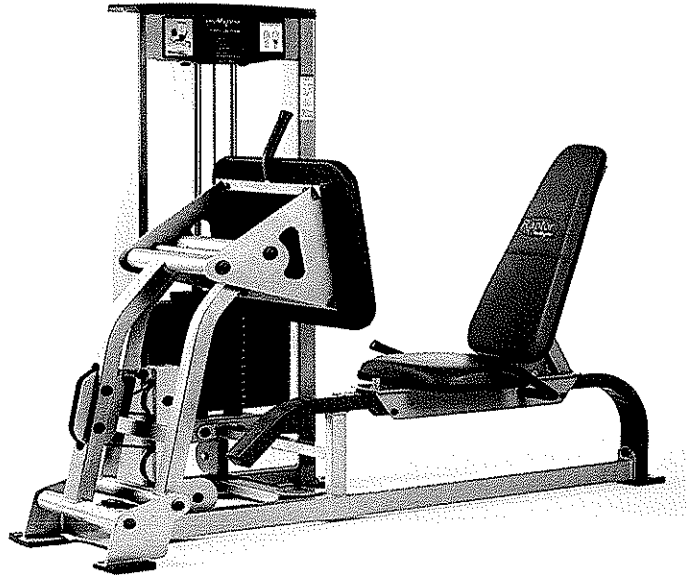

Promaxima Raptor Series P-5000 Leg Press

- Low Seat Profile and Angled Pad
- Custom Made Oversized Solid Rubber Footplate with EZ grip Handle for easy mounting/dismounting
- ABS Seat & Back Protective Dishes- Seamless Upholstery
- Friction Free Sealing Radial Bearings at all pivot points
- Ergonomically formed and positioned custom rubber handles
- Five Position Seat Adjustment
- Bright Red Colored Pull Knobs
- Form Fitted Weight Stack Shields
- Instructional Color Placard
- 5lb add on weight system
- 68"H. x 43"W. x 82"L.
- 300 lb weight stack
- Unit Weight 735lb

RAPTOR

BY PROMAXIMA

P-5100 Leg Extension

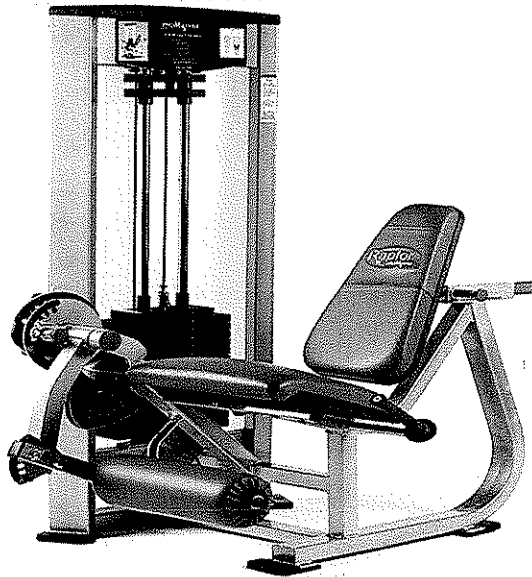

Promaxima Raptor Series **P-5100 Leg Extension**

- Lower Limb adjustment w/ numerical indexing, 1-5
- Start Range of Motion with numerical indexing, 1-6
- Stop Range limitation with alphabetical indexing, A-I
- Computerized Precision Laser Cut True Strength Curve Cams
- Friction Free Sealed Radial Bearings at all Pivot points
- ABS Seat & Back Protective Dishes- Seamless Upholstery
- Six position back pad adjustment
- Custom Made Rubber Hand Grips
- Bright Red Colored Pull Knobs
- Form Fitted Weight Stack Shields
- Instructional Color Placard
- 5lb add on weight system
- 68"H. x 42"W.x51.5"L.
- 225 lb weight stack
- Unit Weight 530lb

RAPTOR

BY PROMAXIMA

P-5300 Seated Leg Curl

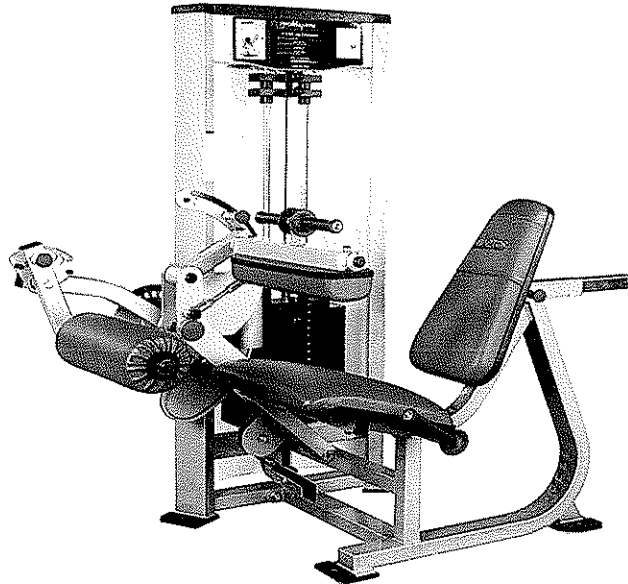

Promaxima Raptor Series

P-5300 Seated Leg Curl

- Lower Limb adjustment w/ numerical indexing, 1-5
- Start Range of Motion with numerical indexing, 1-6
- Stop Range limitation with alphabetical indexing, A-I
- Friction Free Sealed Radial Bearings at all Pivot Points
- Computerized Precision Laser Cut True Strength Curve Cams
- 6 Position Back Pad Adjustment
- Adjustable Thigh Pad
- ABS Seat Protective Dishes- Seamless Upholstery
- Custom Made Rubber Hand Grips
- Bright Red Colored Pull Knobs
- Form Fitted Weight Stack Shields
- Instructional Color Placard
- 5lb add on weight system
- 68"H. x 42"W. x 51.5"L.
- 225 lb weight stack
- Unit Weight 530lb

RAPTOR

BY PROMAXIMA

P-6300 Adductor/Abductor

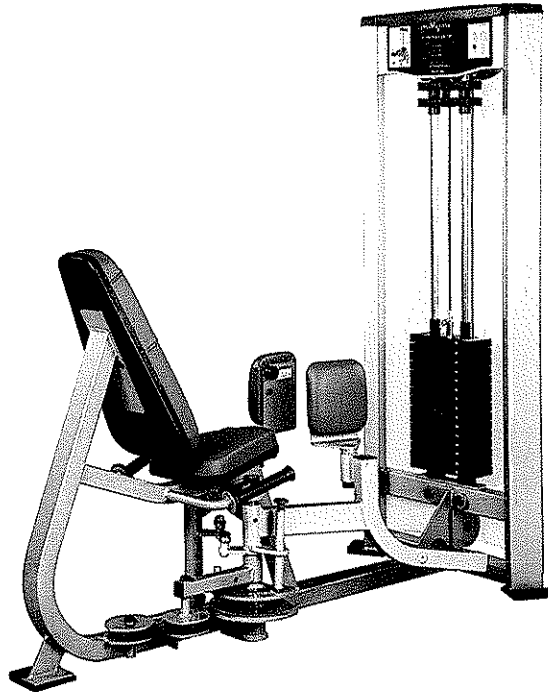

Promaxima Raptor Series **P-6300 Adductor/Abductor Combo**

- Two way Swivel Leg Pads adjusting for Inner and Outer thigh exercises
- Easily Converts from Adductor to Abductor Position
- Computerized Precision Laser Cut True Strength Curve Cams
- ABS Seat Protective Dishes- Seamless Upholstery
- Custom Made Rubber Hand Grips
- Bright Red Colored Pull Knobs
- Form Fitted Weight Stack Shields
- Instructional Color Placard
- 5lb add on weight system
- 68"H. x 32"W.x 68"L.
- 225 lb weight stack
- Unit Weight 635lb

RAPTOR

BY PROMAXIMA

P-1000 Chest Press



Promaxima Raptor Series **P-1000 90 Degree Chest Press**

- Vertical Chest Press w/ foot lever arm for easy mounting/dismounting
- ABS Seat & Back Protective Dishes- Seamless Upholstery
- Ergonomically formed and positioned custom rubber hand grips
- Friction free sealed Radial Bearings at all pivot points
- Five Position Seat Adjustment
- Bright Red Colored Pull Knobs
- Weight Stack Shields
- Instructional Color Placard
- 5lb add on weight system
- 68"H. x 52.5"W. x 55"L.
- 300 lb weight stack
- Unit Weight 595lb

RAPTOR

BY PROMAXIMA

P-2000 Shoulder Press

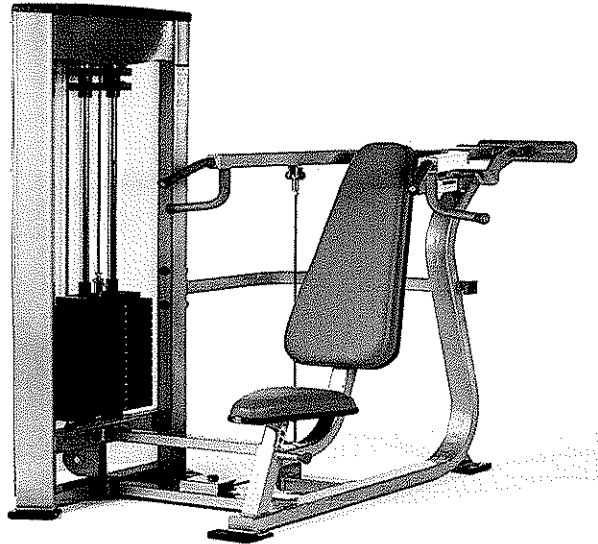

Promaxima Raptor Series **P-2000 Shoulder Press**

- Shoulder Press w/ multiple hand position for maximum isolation
- Counter Balanced Drive Arm
- ABS Seat & Back Protective Dishes- Seamless Upholstery
- Ergonomically formed and positioned custom rubber hand grips
- Friction free sealed radial bearings at all pivot points
- Five Position Seat Adjustment
- Bright Red Colored Pull Knobs
- Weight Stack Shields
- Instructional Color Placard
- 5lb add on weight system
- 68"H. x 51"W.x 69"L.
- 225 lb weight stack
- Unit Weight 594lb

PROMAXIMA RAPTOR SERIES

P-1400 Pec Contractor

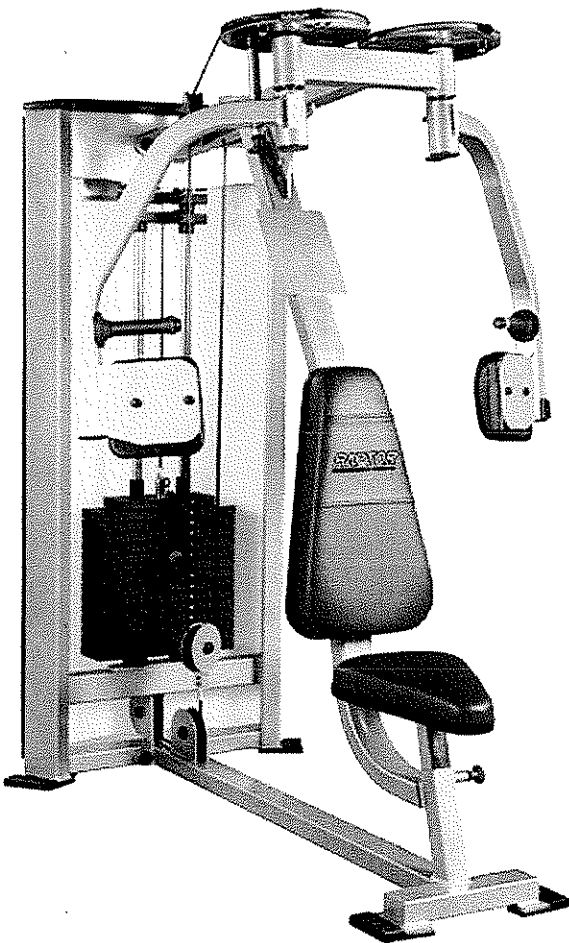

List Price - \$2499

Promaxima Raptor Series P-1400 Pectoral Contractor

- ABS Seat & Back Protective Dishes- Seamless Upholstery
- Ergonomically formed and positioned custom rubber hand grips
- Five Position Seat Adjustment
- Start Range Limitation with numerical indexing, 1-5
- Bright Red Colored Pull Knobs
- Form Fitted Weight Stack Shields
- Instructional Color Placard
- Custom Rubber Feet
- 5lb add on weight system
- 75"H. x 44"W.x 60"L.
- 250 lb weight stack
- Unit Weight 612lb

RAPTOR

BY PROMAXIMA

P-4100 Hi Lat Pull

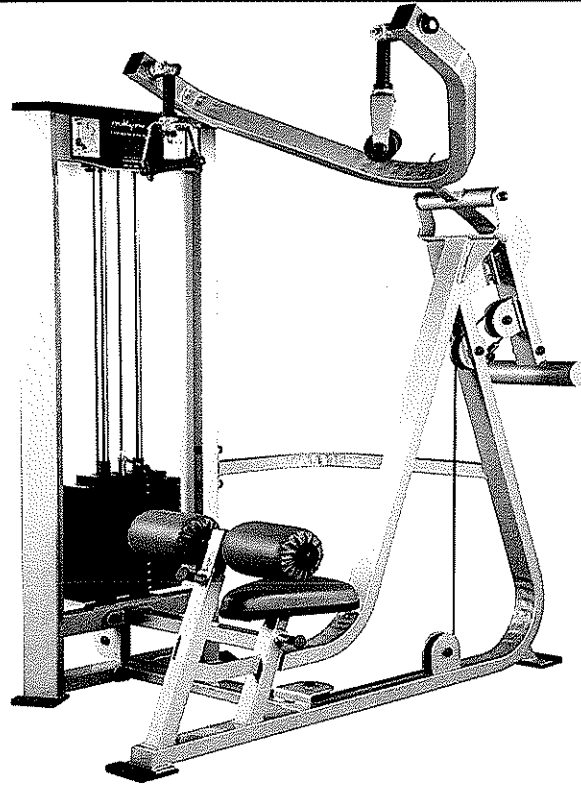

Promaxima Raptor Series

P-4100 Hi Lat Pull

- **Counter Balanced High Lat pulling arm**
- **Friction Free Sealed Radial Bearings at all pivot points**
- **ABS Seat Protective Dishes- Seamless Upholstery**
- **Custom Made Rubber Hand Grips**
- **Triple pivot handle allows for supinate or pronate grips**
- **Bright Red Colored Pull Knobs**
- **Form Fitted Weight Stack Shields**
- **Instructional Color Placard**
- **68"H. x 42"W.x51.5"L.**
- **225 lb weight stack**
- **Unit Weight 530lb**

RAPTOR

BY PROMAXIMA

P-4000 Seated Row

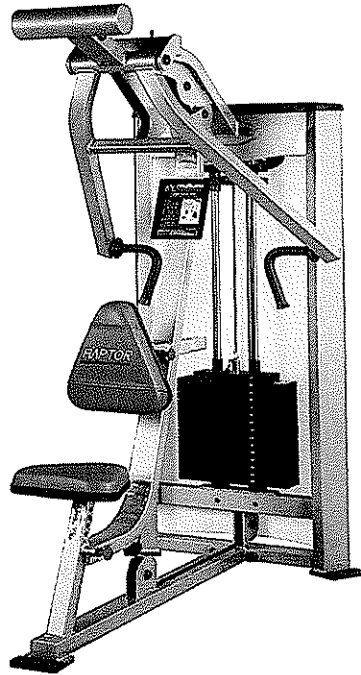

Promaxima Raptor Series **P-4000 Seated Row**

- **Seven position Chest Pad adjustment.**
- **Carriage Counter Balanced pulling arms**
- **ABS Seat Protective Dishes- Seamless Upholstery**
- **Custom Made Rubber Hand Grips**
- **Friction free sealed radial bearings at all pivot points**
- **Bright Red Colored Pull Knobs**
- **Five position seat adjustment**
- **Weight Stack Shields**
- **Instructional Color Placard**
- **5lb add on weight system**
- **68"H. x 42"W.x51.5"L.**
- **225 lb weight stack**
- **Unit Weight 595lb**

RAPTOR

BY PROMAXIMA

P-3000 Bicep Curl

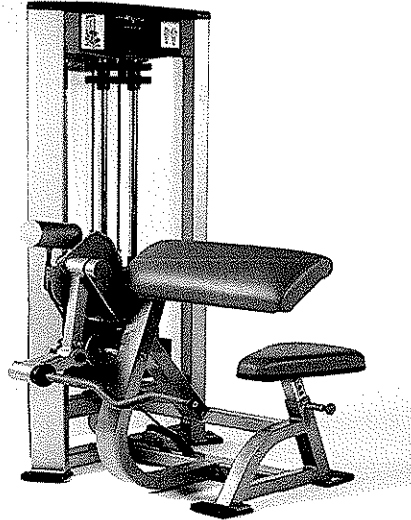

Promaxima Raptor Series P-3000 Bicep Curl

- Self-Adjusting Compensating arm with radial bearing mounted wrist swivel
- Counter Balanced Drive Arm and a precision laser cut True strength curve cam
- ABS Seat & Back Protective Dishes- Seamless Upholstery
- Ergonomically formed and positioned custom rubber handle with three different grips
- Friction free sealed radial bearings at all pivot points
- Five Position Seat Adjustment
- Bright Red Colored Pull Knobs
- Form Fitted Weight Stack Shields
- Instructional Color Placard
- 5lb add on weight system
- 68"H. x 51"W. x 69"L.
- 150 lb weight stack
- Unit Weight 500lb

RAPTOR

BY PROMAXIMA

P-3100 Tricep Extension

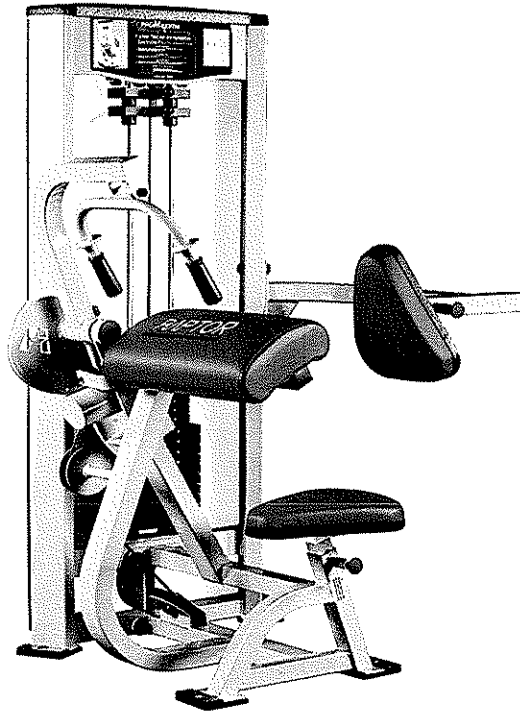

Promaxima Raptor Series

P-3100 Tricep Extension

- ABS Seat & Back Protective Dishes- Seamless Upholste
- Ergonomically formed and positioned custom rubber hand grips
- Five Position Seat Adjustment
- Counter Balanced Drive Arm
- Bright Red Colored Pull Knobs
- Form Fitted Weight Stack Shields
- Instructional Color Placard
- Custom Rubber Feet
- 5lb add on weight system
- 69"H. x 42"W. x 50"L.
- 150 lb weight stack
- Unit Weight 591lb

RAPTOR

BY PROMAXIMA

P-6000 Low Back

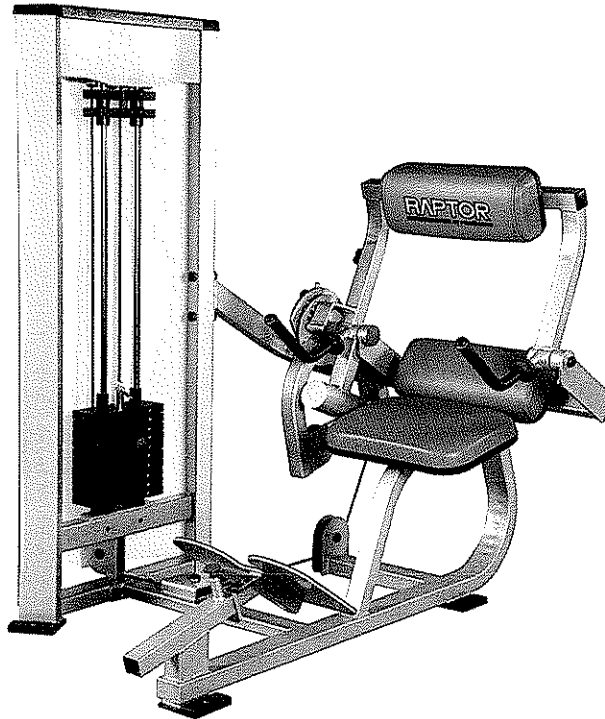

Promaxima Raptor Series **P-6000 Low Back**

- Double pivot on the primary drive arm promotes a stable movement
- Adjustable Non Sid Foot Plate for Proper Alignment
- Friction Free Sealed Radial Bearings at all Pivot Points
- Counter Balanced Drive Arm
- Start range limitation with numerical indexing, 1-4
- Stop range limitation with alphabetical indexing, A-I
- ABS Seat Protective Dishes- Seamless Upholstery
- Custom Made Rubber Hand Grips
- Bright Red Colored Pull Knobs
- Form Fitted Weight Stack Shields
- Instructional Color Placard
- 5lb add on weight system
- 68"H. x 42"W. x 51.5"L.
- 150 lb weight stack
- Unit Weight 530lb

RAPTOR

BY **PROMAXIMA**

P-6100 Abdominal Crunch

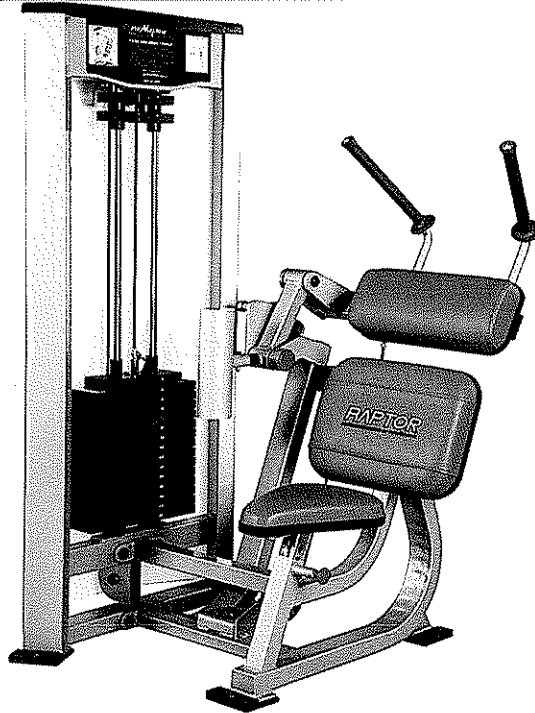

Promaxima Raptor Series P-6100 Abdominal Crunch

- Adjustable Pull arm Handles to stabilize during the exercise
- Counter Balanced Drive Arm
- Friction Free Sealed Radial Bearings at all Pivot Points
- 6 Adjustable Seat Positions
- ABS Seat Protective Dishes- Seamless Upholstery
- Custom Made Rubber Hand Grips
- Bright Red Colored Pull Knobs
- Form Fitted Weight Stack Shields
- Instructional Color Placard
- 5lb add on weight system
- 68"H. x 38"W. x 38"L.
- 150 lb weight stack
- Unit Weight 628lb

RAPTOR

BY PROMAXIMA

P-6200 Rotary Torso

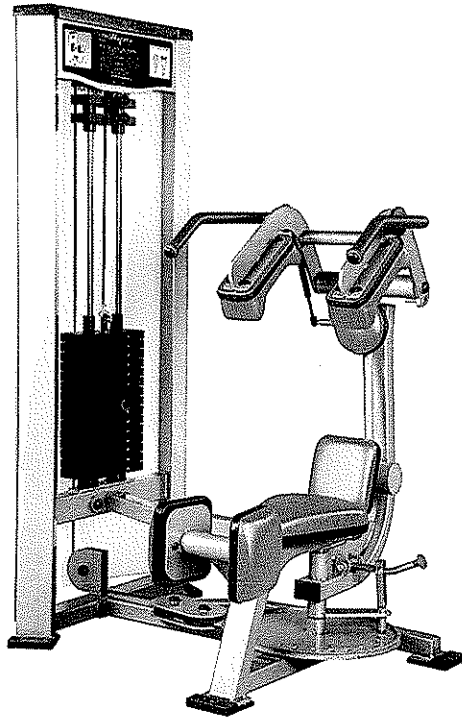

Promaxima Raptor Series **P-6200 Rotary Torso**

- Adjustable Shoulder Pad and handles designed to stabilize the user throughout the exercise
- Start Range of Motion with numerical indexing, 1-6
- Counter Balanced Drive Arm
- Computerized Precision Laser Cut True Strength Curve Cams
- Friction Free Sealed Radial Bearings at all Pivot Points
- ABS Seat Protective Dishes- Seamless Upholstery
- Custom Made Rubber Hand Grips
- Bright Red Colored Pull Knobs
- Form Fitted Weight Stack Shields
- Instructional Color Placard
- 5lb add on weight system
- 68"H. x 38"W. x 38"L.
- 150 lb weight stack
- Unit Weight 628lb

RAPTOR

BY ProMaxima

P-7200 Adjustable Cable Crossover



Promaxima Raptor Series **P-7200 Adjustable Cable Crossover**

- Adjustable Cable Column with 11 different adjustable settings
- Both Columns equipped with Swivel Pulley Systems
- Multi-Grip Chin up bar
- Oversized Three Point Base Design
- Built in Accessory Rack
- Hi/Low Adjustment Column w/ easy lift adjustment handle
- Multi-plane Adjustable pulley bracket
- Custom Made Rubber Hand Grips
- Bright Red Colored Pull Knobs
- Form Fitted Weight Stack Shields
- Instructional Color Placard
- 5lb add on weight system
- 91.5"H. x 55"W.x 168"L.
- 2-150 lb weight stacks
- Unit Weight 1095lb

PROMaxima STRENGTH & CONDITIONING

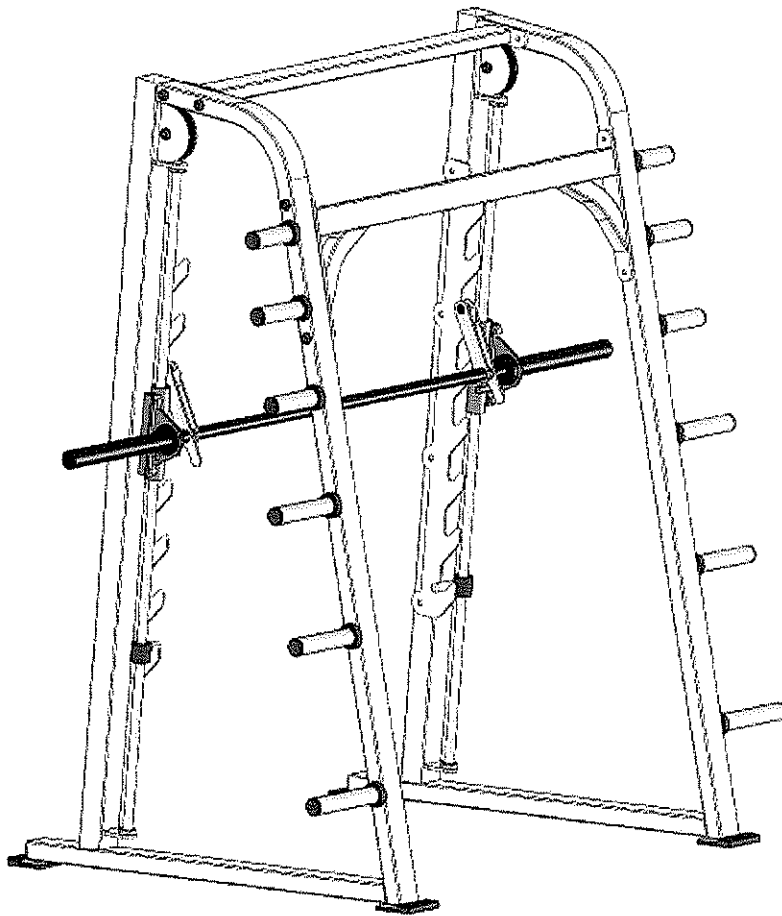

PLR-955 ANGLED SMITH MACHINE

- 3" x 3" Steel Frame
- Linear Bearings
- 2" Case Hardened Steel Guide Rods
- 7 Degree Lifting Angle
- Rotating Counter Balance Lifting Bar Starting At 10lbs
- 6 - Laser Notched Slots On Each Side Accommodates All User Heights
- Stainless Steel Weight Plate Holders

FW-23 HIP FLEXION

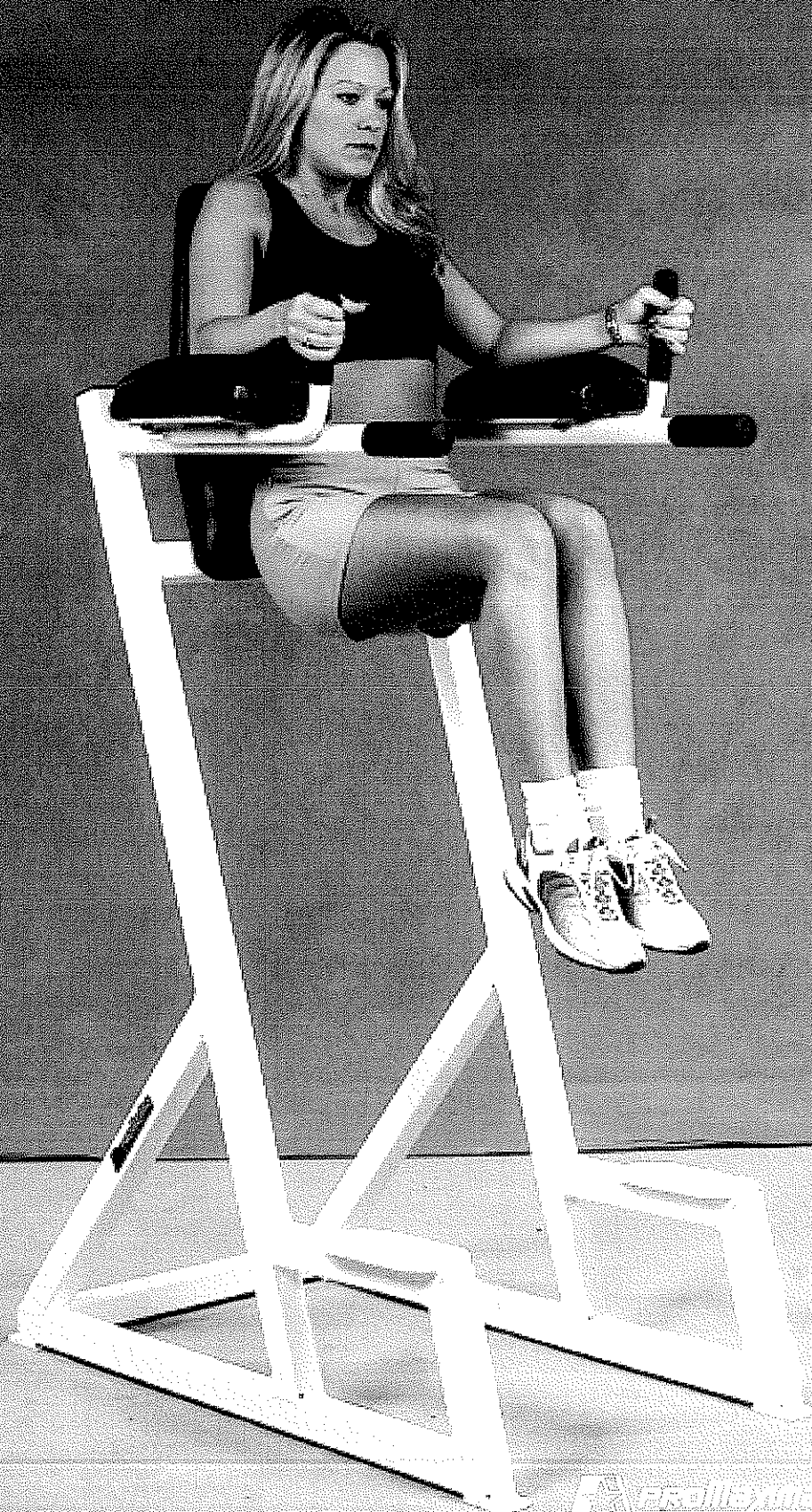

PROMAXIMA FW SERIES

FW-150 Deluxe Multi-purpose Bench

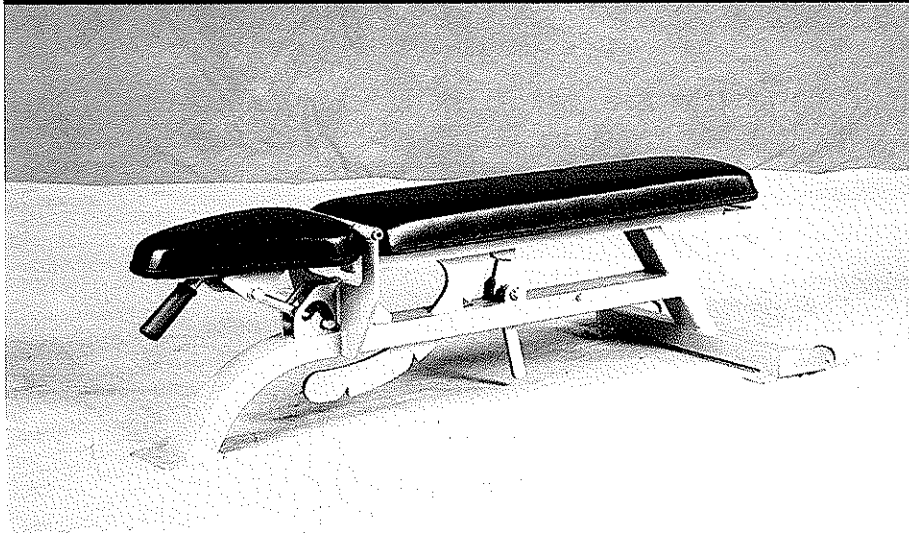

Promaxima FW Series

FW-150 Deluxe Multi-purpose Bench

- One solid welded piece.
- 0-90 degree adjustable bench
- Adjustable Seat Lockout System
- Wheels for Easy Movement
- Premier Heavy-duty 40 oz. commercial grade marine nautahyde, Federal Specification AA-2950A (Supercedes CCCA680a), Federal Aviation Admin. FAR 25.853 (b) & appendix F Part 1 (i) (ii)(v) Boston Fire Code (BFD IX-1), Port Authority of NY & NJ., Bacteria resistant, Padding is 3" closed cell High Density foam reinforced with 3/4" thick plywood back support.
- State of the art 3-stage process that includes a preparatory pellet blasting (sandblasting) machine system that purifies the steel. The steel is then sent through a preheat stage before the final magnetic paint powder is applied. Final coating meets military specifications and is toughest paint finish available. (optional colors)

FW-15
2-TIER DUMBBELL RACK
FW-15A
2-TIER DUMBBELL RACK WITH SADDLES

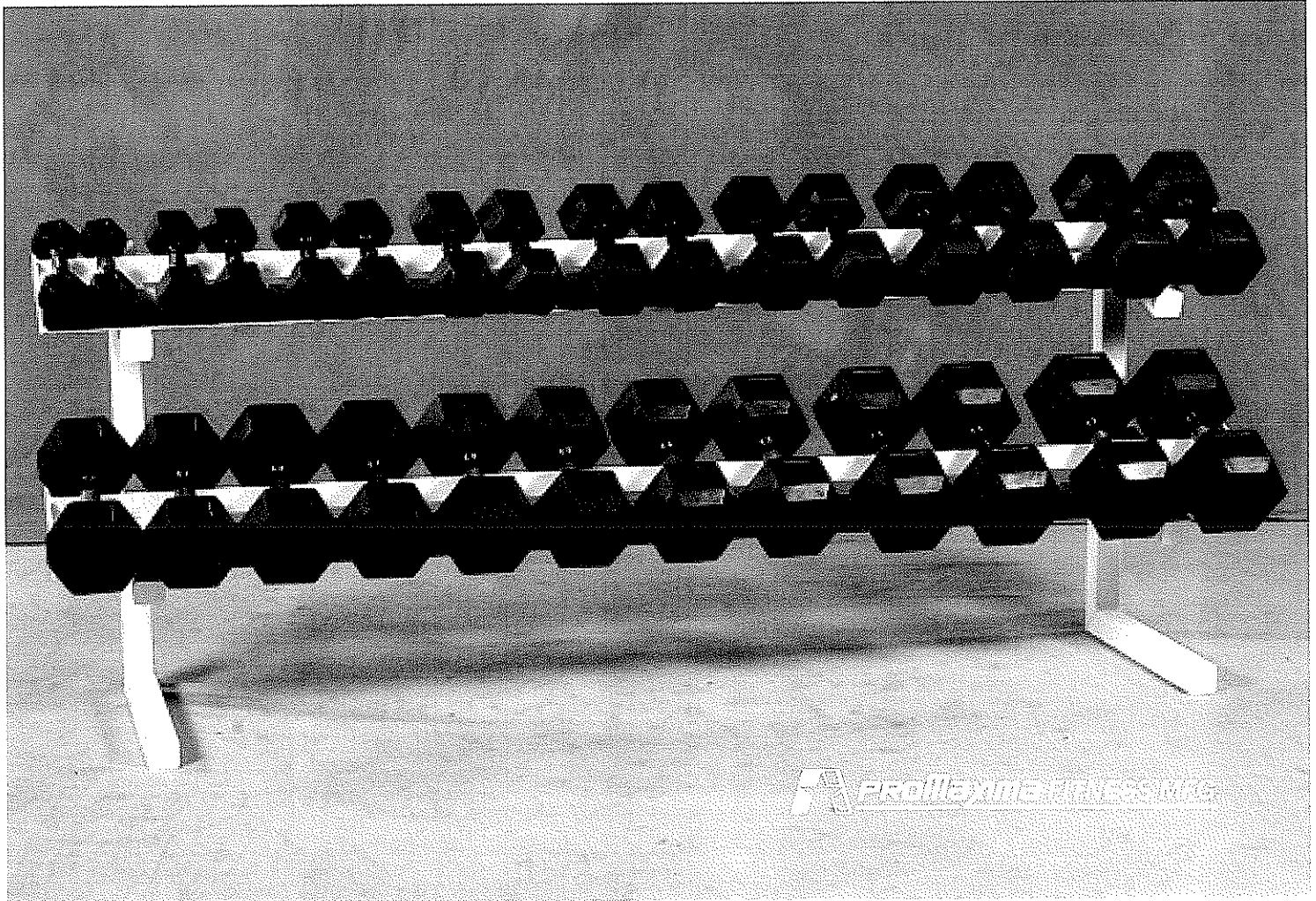

FW-69
10-BAR RACK

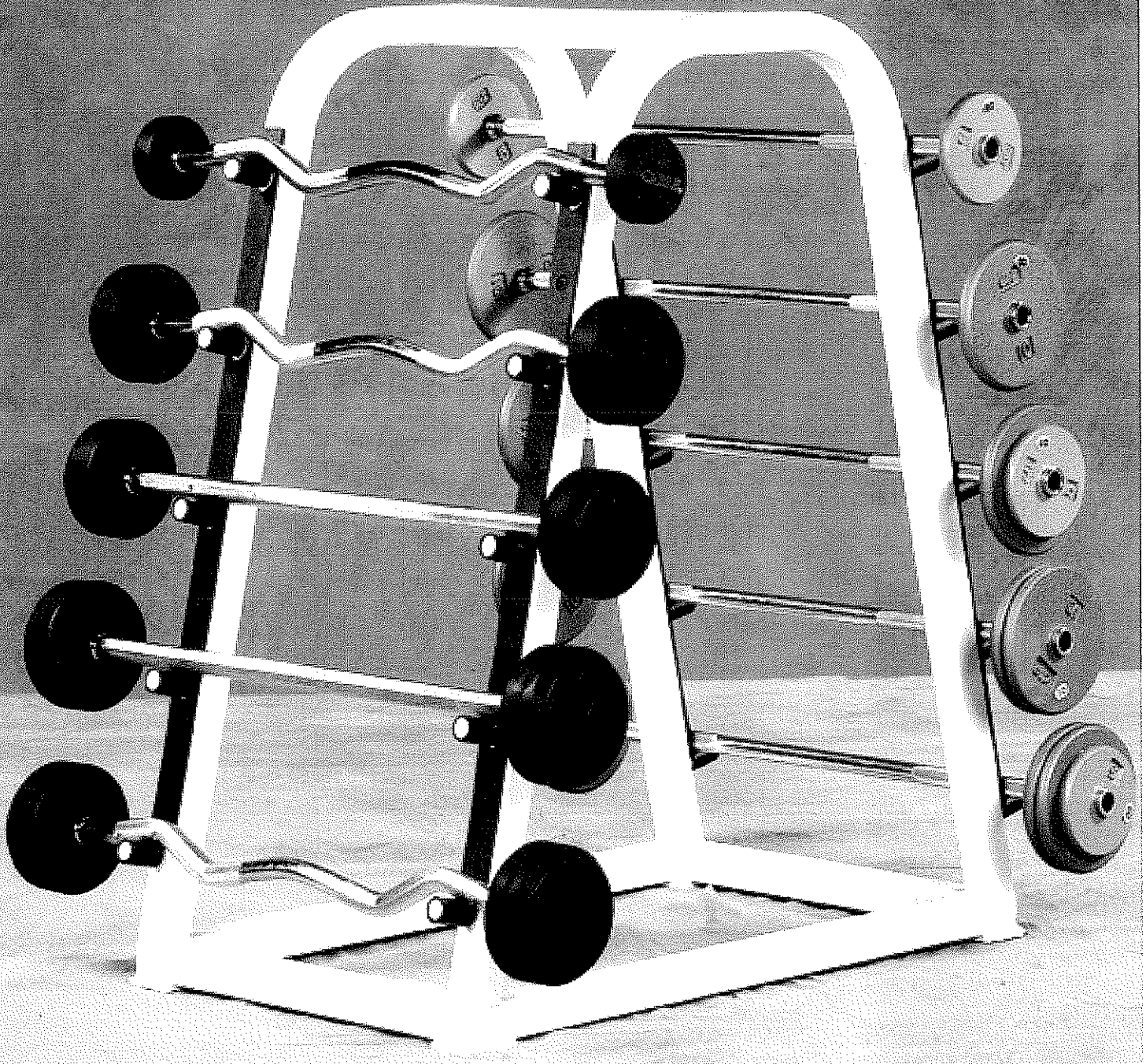

The 8025T treadmills are a technological breakthrough with comfort and results in mind, allowing your users to get more out of their workout. Built to perfection, this next generation of Treadmills will withstand any heavy commercial use. Most importantly, your users will appreciate its easy operation, sturdy design, and dependable engineering that ensure a high level of performance.

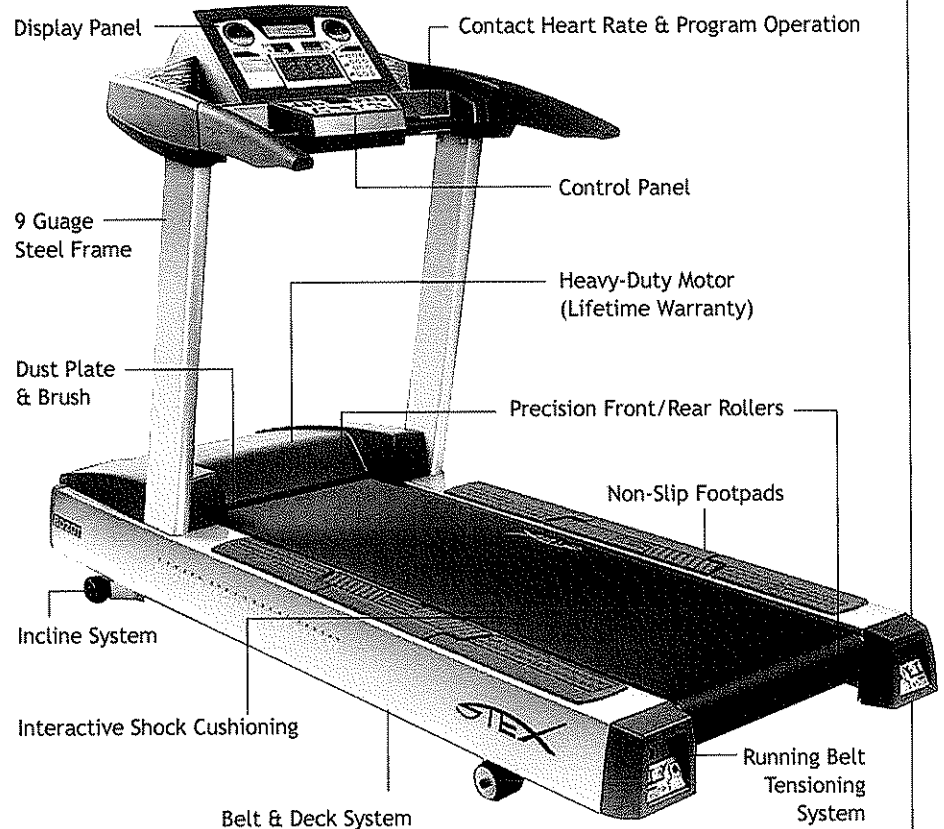

Heavy-Duty Motor (Lifetime Warranty)

Mitsubishi AC Inverter Drive System

- Energy-saving high efficiency digital AC control inverter
- Streamlines energy consumption with magnetic flux vector control and optimized torque control

Harmonically-Balanced Flywheel

- Provides a smooth consistent feel and protects the motor and electronics from stress & pounding

Hyundai 5.5 AC HP Motor

- Hyundai heavy industrial 5.5 hp AC brushless motor
- High-efficiency energy-saving
- Lifetime warranty

Unique Automotive Tensioning System

- Maintenance-free, provides longer lifespan on drive belt

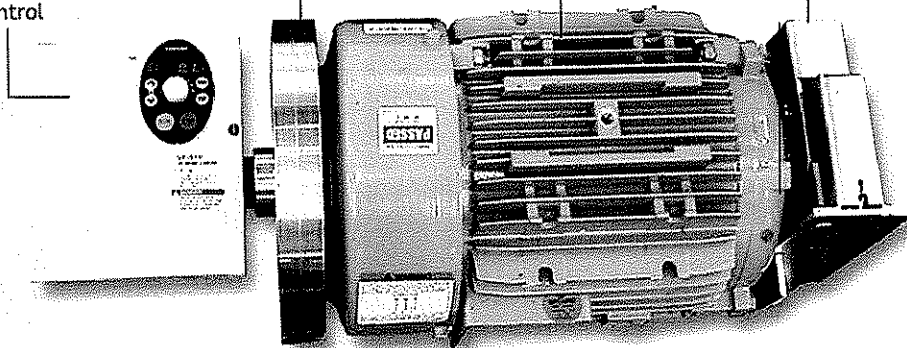

Commercial Warranty:

- Lifetime — AC Motor and Frame
- 3 Years — Running Belt & Deck; Other Commercial Parts

Overview:

Unit Weight: 550 lbs

Dimensions:

L:87" W:35" H:60"

Maximum User Weight: 500 lbs.

Power Requirements:

AC 120 Volts, 50/60Hz

Key Specifications:

- 5.5 HP Heavy-Duty Industrial AC Motor
- Harmonically-Balanced Flywheel Provides a smooth consistent feel and protects the motor and electronics from stress and pounding. Torque Control
- Interactive Shock Cushioning System.
- 4" sealed bearing precision front/rear rollers
- Pre-Lubricated 4-Ply Belt
- 0.5 to 15 mph speed range
- 0% to 20% incline range
- 20" x 60" running/walking surface
- Polar Telemetry with Touch Sensor (chest strap required)
- 10 Workout Programs
- Ergonomically Designed Handrails
- Message Window Displays:
Elapsed Time
Distance MPH
RPM
Calories
Calories per Hour,
Custom Messaging
Language Choices
Time and distance

Contact Heart-Rate & Program Operation

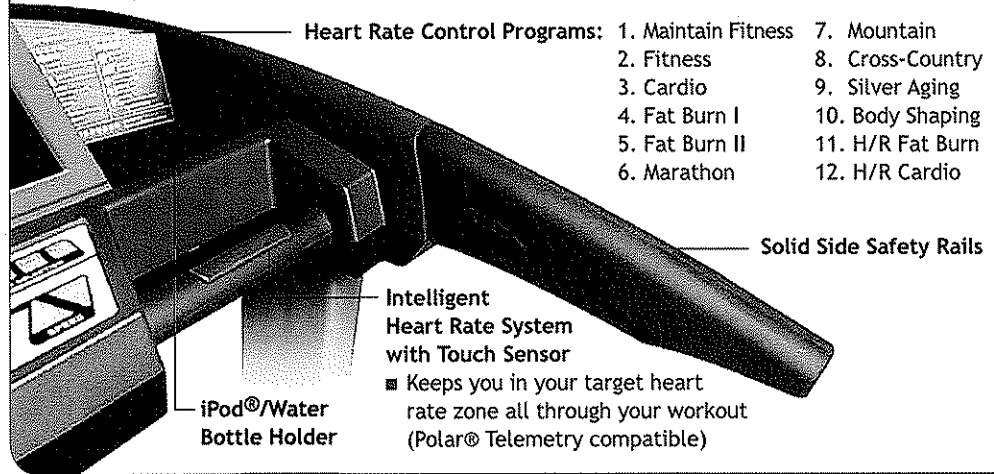

Control Panel

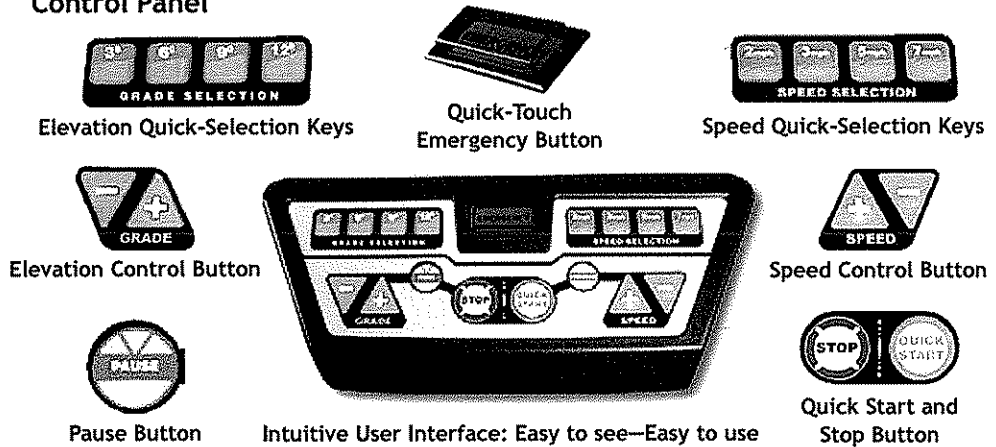

Display Panel

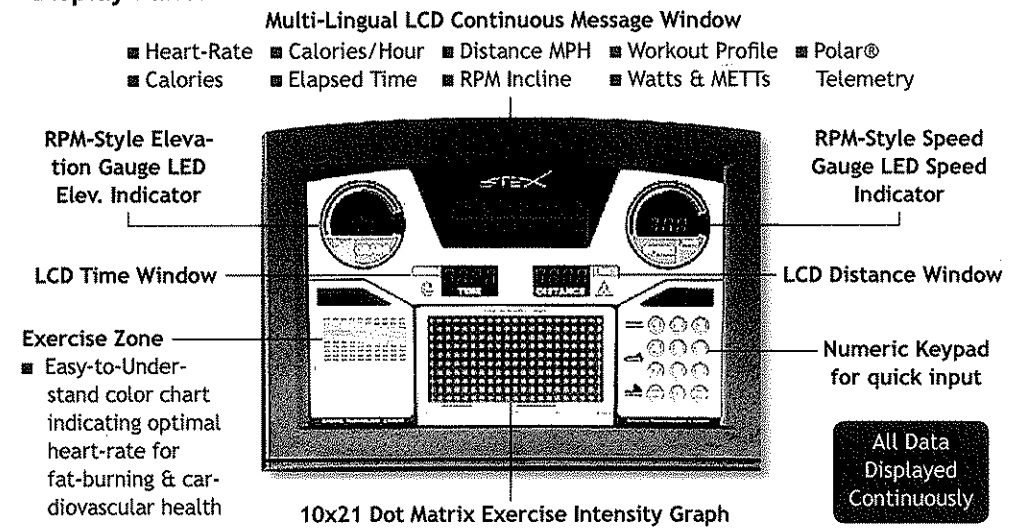

Incline System with Dust Plate & Brush

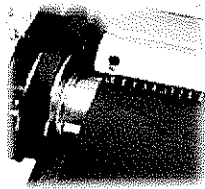

Anti-Static System
■ Wide & Wise Twin Brush™ for anti-static operation

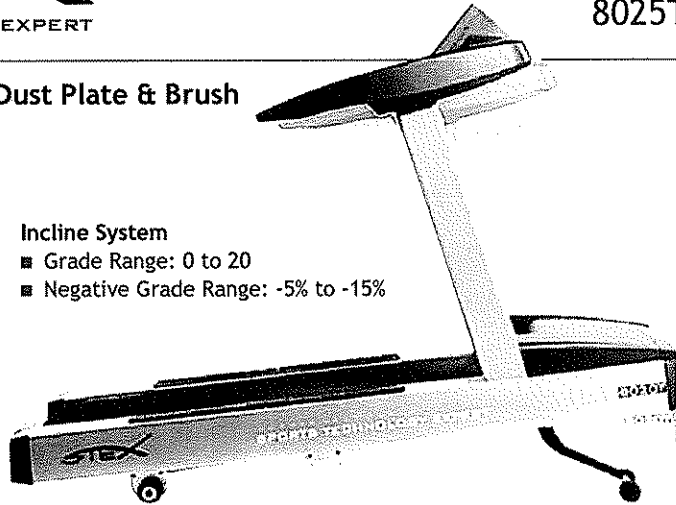

Incline System
■ Grade Range: 0 to 20
■ Negative Grade Range: -5% to -15%

Frame, Deck & Belt System

Heavy Duty Frame
■ Built-to-last steel frame backed by lifetime Warranty

Deck System Cushioning System
■ Maintenance-free double-sided Phenolic laminated 1"-thick medium density fiberboard deck

Interactive Shock Cushioning System provides a low-impact safe ankle, knee and hip joints exercise for runners and walkers

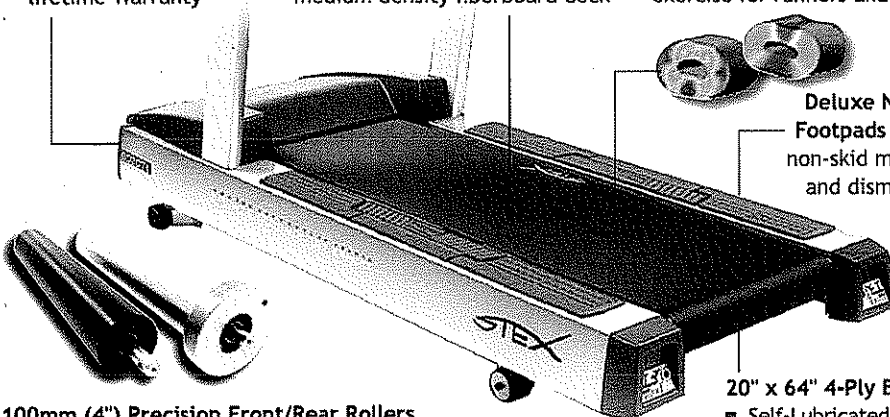

100mm (4") Precision Front/Rear Rollers
■ Gives bigger movement energy for a smooth exercise experience

Deluxe Non-Slip Footpads provide non-skid mounting and dismounting

20" x 64" 4-Ply Belt
■ Self-Lubricated, rugged commercial belt designed for years of use

About ProMaxima

- 40 Year History of Success
- Fleet of dedicated 18-Wheelers for the professional handling and delivery of all fitness equipment
- Trained technicians for setup and installation of all fitness equipment
- Affordabel Payment Plans available
- Industry Leading Warranty
- Professional Floorplan Layout Consultation at no additional charge
- Fitness Industry's best value
- Also available from ProMaxima Manufacturing:
 - Treadmills
 - Ellipticals
 - Upright Bikes
 - Recumbent Bikes
 - Selectorized Circuit Units
 - Multi-Gyms
 - Leverage Machines
 - Free Weights
 - Racks & Platforms
 - Youth Circuits
 - Core Training Equipment

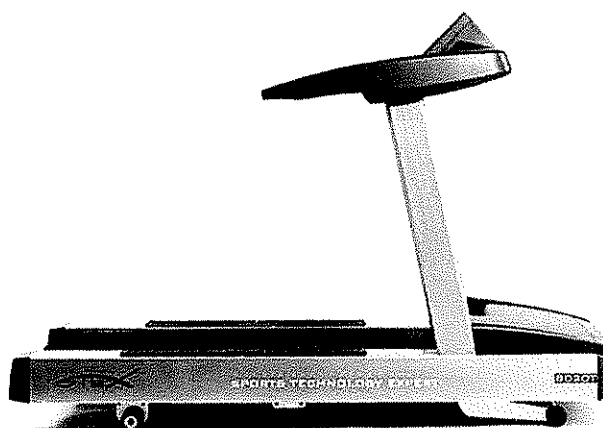
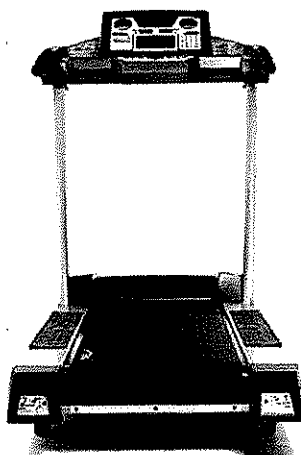

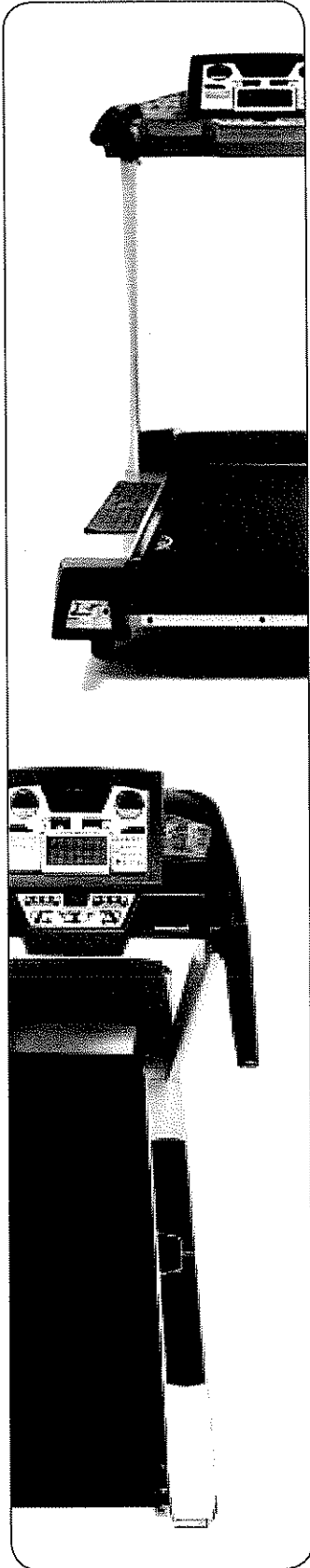

HEART RATE MONITORING
Polar Telemetry (chest strap required)
Intelligent Heart Rate System with Touch Sensor

WORKOUTS
Quick Start, Manual, Intervals, Body Fat Workout, Cool Down

Heart Rate Control Programs	1. Maintain Fitness	2. Fitness	3. Cardio
12 Courses	4. Fat Burn I	5. Fat Burn II	6. Marathon
	7. Mountain	8. Cross Country	9. Silver Aging
	10. Body Shaping	11. H/R Fat Burn	12. H/R Cardio

Program Mode: Four different workouts for Beginners
10 Courses: Three courses for Intermediate, Three courses for Advanced

User-Defined Programs: User customizes their own workout. Chooses time, speed, distance, intervals. Incline Settings automatically change during workout.
Can Save 6 Different Workouts

Fitness Test Protocols: Gerkin, Navy PFT, Marine PFT, Army PFT, Airforce PRT, & Fit Test

EXERCISE RANGE
Speed: 0.5 - 15 mph Incline: 0% - 20%, Optional Decline -5%

CONSOLE DISPLAY
Message Window: Elapsed Time, Distance MPH, RPM, Calories, Calories per Hour, HR, Watts, METs, Custom Messaging, Language Choices, Time and Distance Visual Display
LCD - 10x21 Dot Matrix

Display Type: 4 FND, 10x21 Dot Matrix, 240x64 Graphic LCD

Smart Card Access Reader: Standard

Firmware Upgrade Port, Quick Touch Emergency Stop, Speed/Incline Direct Buttons, Multilingual

DRIVE SYSTEM
Motor: Hyundai Heavy-Duty Industrial AC Motor 5.5 HP, Mitsubishi/Toshiba Drive Inverter
Roller: 4" Precision Front/Rear Roller
Control Method: Magnetic Flux Vector Control
Auto-Tensioning System, Torque Optimizer, Dust Isolation Plate

SPECIAL FEATURES	Interactive Shock Cushioning	Intelligent Soft Deck
	Self-Diagnostic Maintenance Check	Pre-Lubricated Belt
	Deluxe Non-Slip Footpad	CSAFE (+RS232) Comm Port
	Wide and Wise Twin Brush	Steel Frame
	4 Silicone & 4 Rubber Shock Absorbers	Handlebars & Handrails

DIMENSIONS
Running Deck: 20"x64"
Product Size: 35"x87"x60" (WxLxH)
Product Weight: 550 lbs

POWER REQUIREMENT AC 120 VOLTS, 50/60Hz, NEMA Plug, Dedicated Line

WARRANTY

AC Motor - Hyundai 5.5 Brushes	Lifetime	Running Belt & Deck	3 Years
Steel Frame	Lifetime	Mechanical Parts	3 Years
Shock Absorbers	Lifetime	Electronic Parts	3 Years

8020E Commercial Elliptical

The 8020E elliptical features the patented Bio-Stride technology which provides a smooth and stress free workout. The unique design provides a complete workout for all of your major muscle groups without placing any unnecessary stress on your knees or lower back. It has a maintenance free "track-less" drive system; integrated magazine rack, iPod holder and drink holder; automotive belt-drive system and self-powered automotive alternator system. Easy operation, sturdy design and very dependable engineering ensure a high level of performance and quality.

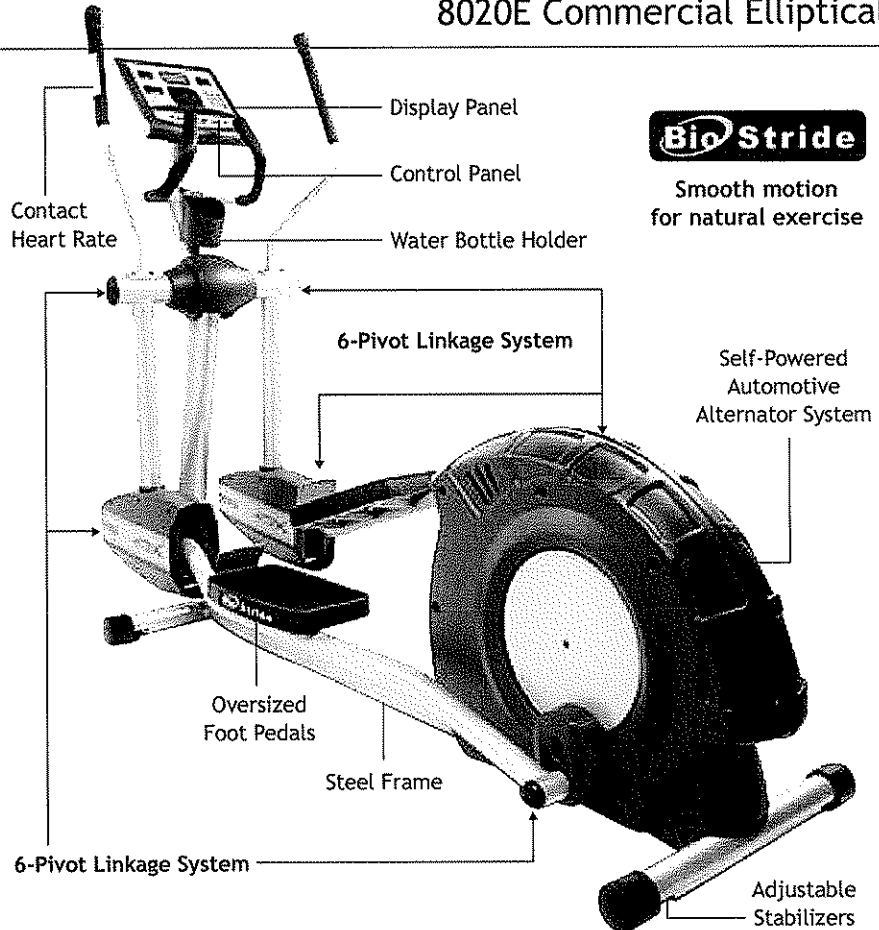

Bio Stride
Smooth motion
for natural exercise

Durable Body with Integrated Drive Train System

Bio Stride
Smooth motion
for natural exercise

Heavy-Duty Shroud Covers
■ Sturdy, rugged construction built to withstand continuous commercial use

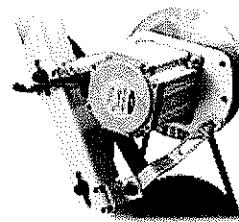

Self-Powered Automotive Drive System (Cordless)
■ Self-contained alternator brake system to control the pace at which you exercise (Lifetime Warranty)

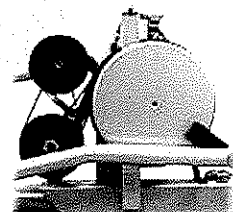
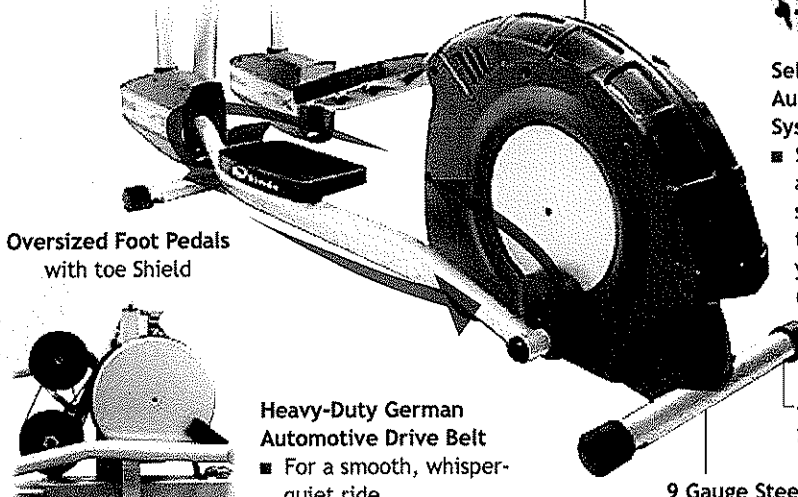

Commercial Warranty:

- Lifetime — AC Motor and Frame
- 3 Years — Other Commercial Parts
- 2 Years — Optional LCD Monitor

Overview:

Unit Weight: 220 lbs

Dimensions:
W: 27" L: 80" H: 64"

Maximum User Weight: 400 lbs.

Power Requirements:
AC 120 Volts, 50/60Hz

Key Specifications:

- Self-Powered Auto-motive Drive System (Cordless)
- Smart Card Access Reader
- Firmware Upgrade Port
- Multilingual
- 25 Resistance Levels
- CSAFE (+RS232) Comm Port
- Electromagnetic Braking System
- Body Fat Calculator
- Steel Frame
- Polar Telemetry with Touch Sensor (chest strap required)
- 21 Workout Programs
- Ergonomically Designed Handgrips
- Message Window
LCD - 16x16
Dot Matrix
Elapsed Time
Distance MPH
RPM, Calories
Calories per Hour
HR, Watts, METs
Custom Messaging
Language Choices
Time and Distance
Visual Display
260x64 Graphic LCD

Bio Stride Drive Train System

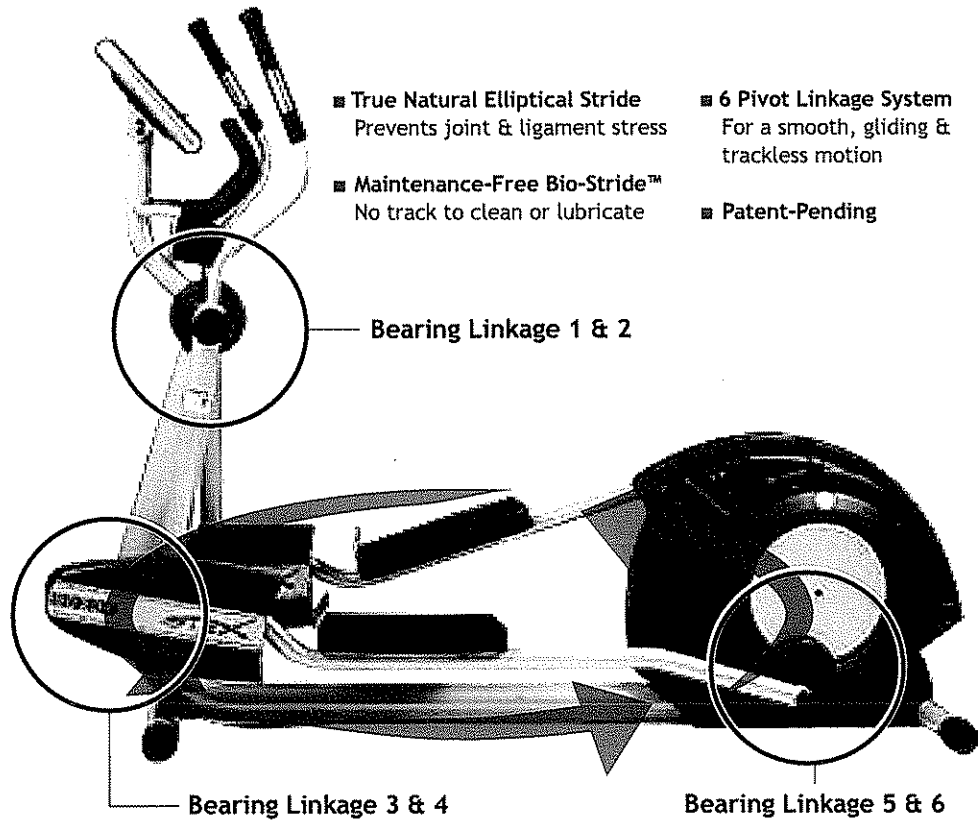

- True Natural Elliptical Stride Prevents joint & ligament stress
- Maintenance-Free Bio-Stride™ No track to clean or lubricate
- 6 Pivot Linkage System For a smooth, gliding & trackless motion
- Patent-Pending

Dual Contact Heart Sensors & Programs

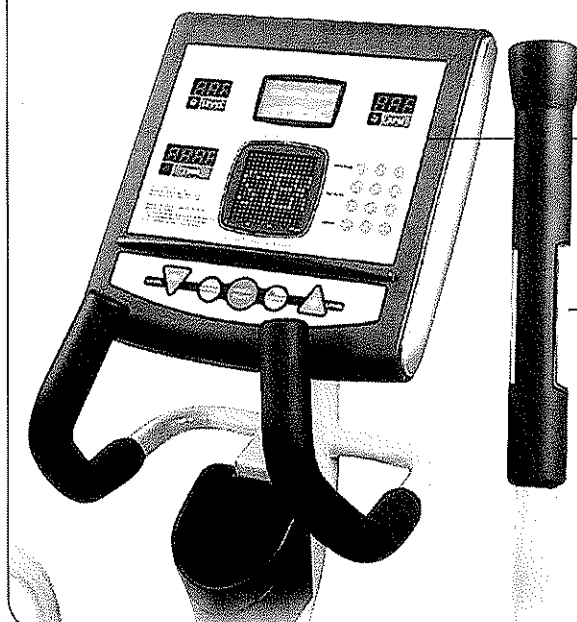

- Display**
- Multilingual LCD window
 - Customized with facility's name
 - Firmware upgrade RJ-45 port
 - Upgradeable software
 - Storage space
- Heart Rate**
- Polar Telemetry (chest strap required-optional)
 - Intelligent Heart Rate System (IHRS®) touch H/R plus

Workout Programs (21 Total)

- 6 preset programs
- 6 interactive HRC programs
- 3 Manual programs
- 6 User-defined programs
- 25 Resistance Levels

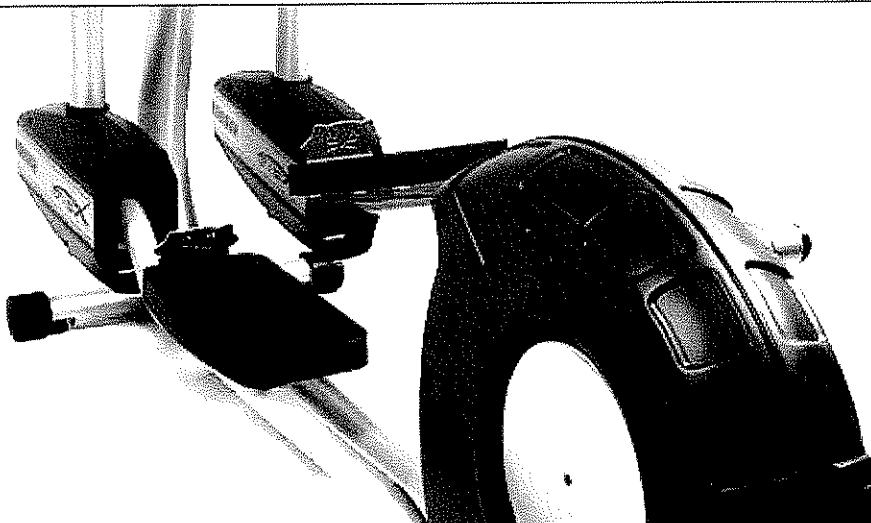
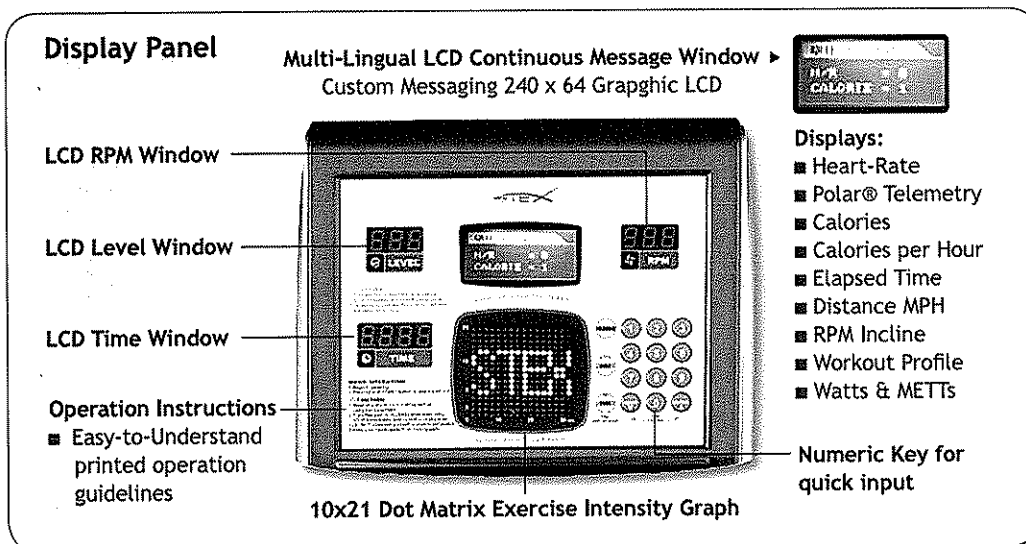
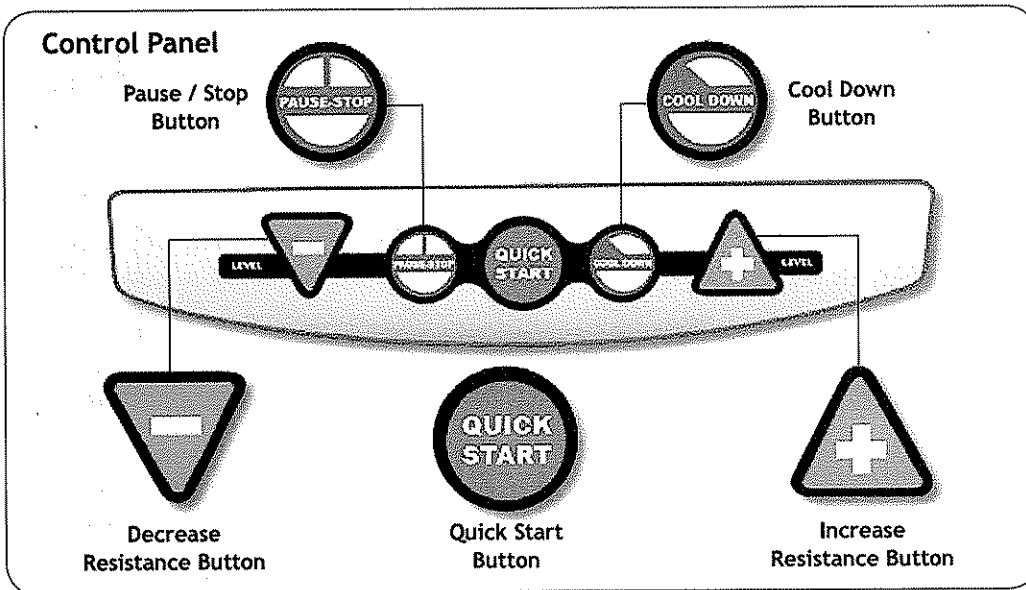

About ProMaxima

- 40 Year History of Success
- Fleet of dedicated 18-Wheelers for the professional handling and delivery of all fitness equipment
- Trained technicians for setup and installation of all fitness equipment
- Affordabel Payment Plans available
- Industry Leading Warranty
- Professional Floorplan Layout Consultation at no additional charge
- Fitness Industry's best value
- Also available from ProMaxima Manufacturing:
 - Treadmills
 - Ellipticals
 - Upright Bikes
 - Recumbent Bikes
 - Selectorized Circuit Units
 - Multi-Gyms
 - Leverage Machines
 - Free Weights
 - Racks & Platforms
 - Youth Circuits
 - Core Training Equipment



HEART RATE MONITORING
Polar Telemetry (chest strap required)
with Touch Sensor

WORKOUTS
Quick Start Yes
Body Fat Yes
Heart Rate Control Programs (6 Options)
1. Cardio
2. Fitness
3. Fat Burn
4. Cross Country
5. Mountain
6. Body Shaping
Program Mode: 6 Workouts
Two Interval Courses
Two Increasing Courses
Two Pyramid Courses
Body Fat
Fitness Test Protocols: Gerkin, Navy PFT, Marine PFT, Army PFT, Airforce PRT, & Fit Test
Cool Down

Resistance 25 Resistance Levels

CONSOLE DISPLAY
Message Window
LCD - 10x21 Dot Matrix
Elapsed Time, Distance MPH, RPM, Calories, Calories per Hour, HR Watts, METs, Custom Messaging, Language Choices, Time and Distance Visual Display
Display Type 4 FND, 240x64 Graphic LCD
Smart Card Access Reader
Firmware Upgrade Port
Multilingual

DRIVE SYSTEM
Self-Powered Automotive Alternator System
Control Method: Electrical Resistance Control

FEATURES
Electromagnetic Braking System
Accessory Holder Magazine Rack, Cup Holder, Phone Holder
CSAFE (+RS232) Comm Port
Handlebars and Steel Frame

DIMENSIONS
Product Size 27"x80"x64" (LxWxH)
Product Weight 220 lbs

WARRANTY
Alternator & Frame Lifetime
Mechanical Parts 3 Years
Electronic Parts 3 Years

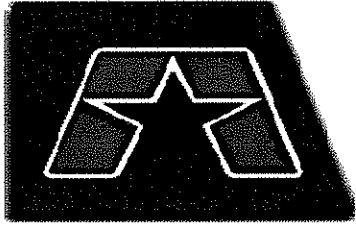

PROMAXIMA
Manufacturing

PROMAXIMA FW EQUIPMENT SERIES:

FRAMES: ASTM 2" X 2", 2" x 3" & 3" X 4" A-500 Grade B structural carbon steel tubing (11 & 7 Gauge) is used on complete frames. All welds are ground down and stress tested and all tubing ends have solid steel caps welded to them.

BEARINGS: All pivot points use double sealed Radial Bearings with steel housing. A Solid 1" steel axes shaft is used for maximum strength. All pivot points are designed to line up exactly to the bodies joints, for proper biomechanics. Bearings are double sealed to prevent dust and moisture.

WEIGHT STORAGE: The PL Line includes standard weight peg storage to provide additional weight plate storage on the machines.

UPHOLSTERY: Premier Heavy-duty 40 oz. commercial grade marine naugahyde, Federal Specification AA-2950A (Supercedes CCCA680a), Federal Aviation Admin. FAR 25.853 (b) & appendix F Part 1 (a) (i) (ii)(v), Boston Fire Code (BFD IX_1), port Authority of NY & NJ., Bacteria resistant, Padding is 3" closed cell High Density foam reinforced with 3/4" thick plywood back support.

ALIGNMENT / ADJUSTMENTS: Heavy duty spring loaded pop pins are located for quick easy adjustment for proper alignment for all users heights. Proper gauge square tubing is used for a nice snug fit. Tubing telescopes for straight stability.

FINISH: Units go through a three stage, state of the art wash system that paralyzes the material. Then they go into a dryer to dry and preheat material for applying the magnetic paint powder which then goes into a oven which is 750 ° hot. The units take 20 to 30 min. to bake urethane paint coating which meets all military spec and is the toughest paint finish available. Option of school colors.

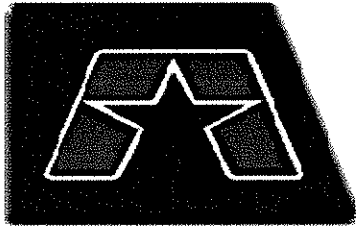

PROflexina
Manufacturing

WARRANTIES
THE BEST IN THE INDUSTRY

FRAMES AND WELDS (Lifetime)

WEIGHT STACK PLATES (Lifetime)

PILLOW BLOCK BEARINGS (10 YEARS)

**LINEAR BEARINGS, CAMS, GUIDE RODS, BUSHINGS &
PULLEYS
(5 YEARS)**

CABLES (2 YEARS)

UPHOLSTERY (1 YEAR)