



State of West Virginia
 Department of Administration
 Purchasing Division
 2019 Washington Street East
 Post Office Box 50130
 Charleston, WV 25305-0130

Request for Quotation

RFQ NUMBER
 WEH90125

PAGE
 1

ADDRESS CORRESPONDENCE TO ATTENTION OF
 ROBERTA WAGNER
 304-558-0067

RFQ COPY
 TYPE NAME/ADDRESS HERE

Medical Device Depot, Inc.
 3230 Bethany Lane, Suite 8
 Ellicott City, MD 21042
 877-846-3300
 www.medicaldevicedepot.com

SHIP TO
 HEALTH AND HUMAN RESOURCES
 WELCH COMMUNITY HOSPITAL
 454 MCDOWELL STREET
 WELCH, WV
 24801 304-436-8710

DATE PRINTED	TERMS OF SALE	SHIP VIA	F.O.B.	FREIGHT TERMS
05/18/2009				

BID OPENING DATE: 06/18/2009	BID OPENING TIME: 01:30PM
------------------------------	---------------------------

LINE	QUANTITY	UOP	CAT. NO.	ITEM NUMBER	UNIT PRICE	AMOUNT
0001	2	EA		410-60		
AMSOCO 3085 SP SURGICAL TABLES OR EQUAL. (SEE ATTACHED SPECIFICATIONS.) CANCELLATION: THE DIRECTOR OF PURCHASE RIGHT TO CANCEL THIS CONTRACT IMMEDIATE NOTICE TO THE VENDOR IF THE COMMODITIES SUPPLIED ARE OF AN INFERIOR QUALITY OR TO THE SPECIFICATIONS OF THE BID AND CONTRACT. BANKRUPTCY: IN THE EVENT THE VENDOR/CONTRACTOR FILES FOR BANKRUPTCY PROTECTION, THIS CONTRACT IS AUTOMATICALLY NULL AND VOID, AND IS TERMINATED WITHOUT FURTHER ORDER. INQUIRIES: WRITTEN QUESTIONS SHALL BE ACCEPTED THROUGH CLOSE OF BUSINESS ON 6/2/2009. QUESTIONS MAY BE SENT VIA USPS, FAX, COURIER OR E-MAIL. IN ORDER TO ASSURE NO VENDOR RECEIVES AN UNFAIR ADVANTAGE, NO SUBSTANTIVE QUESTIONS WILL BE ANSWERED ORALLY. IF POSSIBLE, E-MAIL QUESTIONS ARE PREFERRED. ADDRESS INQUIRIES TO: ROBERTA WAGNER DEPARTMENT OF ADMINISTRATION						

RECEIVED
 2009 JUN 18 A 10:16
 PURCHASING DIVISION
 STATE OF WV

RFQ WEH90125

SEE REVERSE SIDE FOR TERMS AND CONDITIONS		
SIGNATURE <i>[Signature]</i>	TELEPHONE 410-750-8757	DATE 6/17/09
TITLE Vice President	FERN 26-0222502	ADDRESS CHANGES TO BE NOTED ABOVE

WHEN RESPONDING TO RFQ, INSERT NAME AND ADDRESS IN SPACE ABOVE LABELED 'VENDOR'

**GENERAL TERMS & CONDITIONS
REQUEST FOR QUOTATION (RFQ) AND REQUEST FOR PROPOSAL (RFP)**

1. Awards will be made in the best interest of the State of West Virginia.
2. The State may accept or reject in part, or in whole, any bid.
3. All quotations are governed by the *West Virginia Code* and the *Legislative Rules* of the Purchasing Division.
4. Prior to any award, the apparent successful vendor must be properly registered with the Purchasing Division and have paid the required \$125 fee.
5. All services performed or goods delivered under State Purchase Order/Contracts are to be continued for the term of the Purchase Order/Contracts, contingent upon funds being appropriated by the Legislature or otherwise being made available. In the event funds are not appropriated or otherwise available for these services or goods, this Purchase Order/Contract becomes void and of no effect after June 30.
6. Payment may only be made after the delivery and acceptance of goods or services.
7. Interest may be paid for late payment in accordance with the *West Virginia Code*.
8. Vendor preference will be granted upon written request in accordance with the *West Virginia Code*.
9. The State of West Virginia is exempt from federal and state taxes and will not pay or reimburse such taxes.
10. The Director of Purchasing may cancel any Purchase Order/Contract upon 30 days written notice to the seller.
11. The laws of the State of West Virginia and the *Legislative Rules* of the Purchasing Division shall govern all rights and duties under the Contract, including without limitation the validity of this Purchase Order/Contract.
12. Any reference to automatic renewal is hereby deleted. The Contract may be renewed only upon mutual written agreement of the parties.
13. **BANKRUPTCY:** In the event the vendor/contractor files for bankruptcy protection, this Contract may be deemed null and void, and terminated without further order.
14. **HIPAA BUSINESS ASSOCIATE ADDENDUM:** The West Virginia State Government HIPAA Business Associate Addendum (BAA), approved by the Attorney General, and available online at the Purchasing Division's web site (<http://www.state.wv.us/admin/purchase/vrc/hipaa.htm>) is hereby made part of the agreement. Provided that, the Agency meets the definition of a Cover Entity (45 CFR §160.103) and will be disclosing Protected Health Information (45 CFR §160.103) to the vendor.
15. **WEST VIRGINIA ALCOHOL & DRUG-FREE WORKPLACE ACT:** If this Contract constitutes a public improvement construction contract as set forth in Article 1D, Chapter 21 of the West Virginia Code ("The West Virginia Alcohol and Drug-Free Workplace Act"), then the following language shall hereby become part of this Contract: "The contractor and its subcontractors shall implement and maintain a written drug-free workplace policy in compliance with the West Virginia Alcohol and Drug-Free Workplace Act, as set forth in Article 1D, Chapter 21 of the West Virginia Code. The contractor and its subcontractors shall provide a sworn statement in writing, under the penalties of perjury, that they maintain a valid drug-free work place policy in compliance with the West Virginia and Drug-Free Workplace Act. It is understood and agreed that this Contract shall be cancelled by the awarding authority if the Contractor: 1) Fails to implement its drug-free workplace policy; 2) Fails to provide information regarding implementation of the contractor's drug-free workplace policy at the request of the public authority; or 3) Provides to the public authority false information regarding the contractor's drug-free workplace policy."

INSTRUCTIONS TO BIDDERS

1. Use the quotation forms provided by the Purchasing Division.
2. **SPECIFICATIONS:** Items offered must be in compliance with the specifications. Any deviation from the specifications must be clearly indicated by the bidder. Alternates offered by the bidder as **EQUAL** to the specifications must be clearly defined. A bidder offering an alternate should attach complete specifications and literature to the bid. The Purchasing Division may waive minor deviations to specifications.
3. Complete all sections of the quotation form.
4. Unit prices shall prevail in case of discrepancy.
5. All quotations are considered F.O.B. destination unless alternate shipping terms are clearly identified in the quotation.
6. **BID SUBMISSION:** All quotations must be delivered by the bidder to the office listed below prior to the date and time of the bid opening. Failure of the bidder to deliver the quotations on time will result in bid disqualifications: Department of Administration, Purchasing Division, 2019 Washington Street East, P.O. Box 50130, Charleston, WV 25305-0130



State of West Virginia
 Department of Administration
 Purchasing Division
 2019 Washington Street East
 Post Office Box 50130
 Charleston, WV 25305-0130

Request for Quotation

RFQ NUMBER
WEH90125

PAGE
2

ADDRESS CORRESPONDENCE TO ATTENTION OF:
**ROBERTA WAGNER
 304-558-0067**

VENDOR

RFQ COPY
 TYPE NAME/ADDRESS HERE

Medical Device Depot, Inc.
3230 Bethany Lane, Suite 6
Ellicott City, MD 21042
877-648-3300
www.medicaldevicedepot.com

SHIP TO

**HEALTH AND HUMAN RESOURCES
 WELCH COMMUNITY HOSPITAL
 454 MCDOWELL STREET
 WELCH, WV
 24801 304-436-8710**

DATE PRINTED 05/18/2009	TERMS OF SALE	SHIP VIA	FOB	FREIGHT TERMS
-----------------------------------	---------------	----------	-----	---------------

BID OPENING DATE:

06/18/2009

BID OPENING TIME 01:30PM

LINE	QUANTITY	UCP	CAT. NO.	ITEM NUMBER	UNIT PRICE	AMOUNT
<p>PURCHASING DIVISION 2019 WASHINGTON STREET, EAST CHARLESTON, WV 25311</p> <p>FAX: (304) 558-4115 E-MAIL: ROBERTA.A.WAGNER@WV.GOV</p> <p>THE MODEL/BRAND/SPECIFICATIONS NAMED HEREIN ESTABLISH THE ACCEPTABLE LEVEL OF QUALITY ONLY AND ARE NOT INTENDED TO REFLECT A PREFERENCE OR FAVOR ANY PARTICULAR BRAND OR VENDOR. VENDORS WHO ARE BIDDING ALTERNATES SHOULD SO STATE AND INCLUDE PERTINENT LITERATURE AND SPECIFICATIONS. FAILURE TO PROVIDE INFORMATION FOR ANY ALTERNATES MAY BE GROUNDS FOR REJECTION OF THE BID. THE STATE RESERVES THE RIGHT TO WAIVE MINOR IRREGULARITIES IN BIDS OR SPECIFICATIONS IN ACCORDANCE WITH SECTION 148-1-4(F) OF THE WEST VIRGINIA LEGISLATIVE RULES AND REGULATIONS.</p> <p style="text-align: center;">NOTICE</p> <p>A SIGNED BID MUST BE SUBMITTED TO:</p> <p>DEPARTMENT OF ADMINISTRATION PURCHASING DIVISION BUILDING 15 2019 WASHINGTON STREET, EAST CHARLESTON, WV 25305-0130</p> <p>PLEASE NOTE: A CONVENIENCE COPY WOULD BE APPRECIATED.</p> <p>THE BID SHOULD CONTAIN THIS INFORMATION ON THE FACE OF</p>						

SEE REVERSE SIDE FOR TERMS AND CONDITIONS

SIGNATURE <i>[Signature]</i>	TELEPHONE 410-750-8757	DATE 6-17-09
TITLE Vice President	FEN 26-022502	ADDRESS CHANGES TO BE NOTED ABOVE

WHEN RESPONDING TO RFQ, INSERT NAME AND ADDRESS IN SPACE ABOVE LABELED 'VENDOR'



State of West Virginia
 Department of Administration
 Purchasing Division
 2019 Washington Street East
 Post Office Box 50130
 Charleston, WV 25305-0130

Request for Quotation

RFQ NUMBER
WEH90125

PAGE
4

ADDRESS CORRESPONDENCE TO ATTENTION OF
ROBERTA WAGNER
304-558-0067

VENDOR

RFQ COPY
 TYPE NAME/ADDRESS HERE

Medical Device Depot, Inc.
3230 Bethany Lane, Suite 8
Ellicott City, MD 21042
877-646-3300
www.medicaldevicedepot.com

SHIP TO

HEALTH AND HUMAN RESOURCES
WELCH COMMUNITY HOSPITAL
454 MCDOWELL STREET
WELCH, WV
24801 **304-436-8710**

DATE PRINTED	TERMS OF SALE	SHIP VIA	F.O.B.	FREIGHT TERMS
05/18/2009				

BID OPENING DATE: **06/18/2009** BID OPENING TIME **01:30PM**

LINE	QUANTITY	UOP	CAT NO.	ITEM NUMBER	UNIT PRICE	AMOUNT
***** THIS IS THE END OF RFQ WEH90125 ***** TOTAL: _____						

SEE REVERSE SIDE FOR TERMS AND CONDITIONS

SIGNATURE 	TELEPHONE 410-750-8757	DATE 6-17-09
TITLE Vice President	FEIN 26-022502	ADDRESS CHANGES TO BE NOTED ABOVE

WHEN RESPONDING TO RFQ, INSERT NAME AND ADDRESS IN SPACE ABOVE LABELED 'VENDOR'

Welch Community Hospital
 WEH90125 Amsco 3085 SP Surgical Table or Equal

GENERAL INFORMATION

Project: to purchase two (2) new Amsco 3085 SP Surgical table or equal for Welch Community Hospital.

OPERATING ENVIRONMENT

Delivery Location: Welch Community Hospital, 454 McDowell Street, Welch WV 24801

Background: Welch Community Hospital is a 124 bed hospital, 59 of which are Long Term care beds. Acute care beds include: 8 Intensive care beds; 2 pediatric beds; 10 obstetrical beds and 45 medical/surgical beds. The hospital serves the counties of McDowell, Wyoming and Mingo with a total market population of about 83,000.

PROCUREMENT SPECIFICATIONS

1.) General Requirements:

Two (2) each, new Amsco 3085 SP Surgical tables or equal with specified components.

(All equipment must be new. No used, reconditioned, re-manufactured equipment.)

2.) Specifications:

- A.) Must provide two (2) new Amsco 3085 SP Surgical Table or equal.
- B.) Each table must include 2" tabletop pad set.
- C.) Each table must include X-ray (radiolucent) tops. X-ray top should be designed so that cassettes can be loaded from the head, foot, or either side for a full range of exposure angles.
- D.) Each table must include two (2) anesthesia arm-boards w/3" pad.
- E.) Each table must include perineal cutout filler piece.
- F.) Each table must include cable wrap.
- G.) Each table must include conductive restraint strap: standard length 66 ½".
- H.) Each table must be electric powered, 120 volts.
- I.) Each table must have a Raise/Lower Height range -- 27" to 44".
- J.) Each table must have Lateral tilt-18 degrees.
- K.) Each tabletop must have the ability to:
 - a. Trendelenburg and Reverse Trendelenburg position 25 degrees maximum from horizontal.
 - b. Lateral Tilt position (right and left) 18 degrees maximum from horizontal.

Welch Community Hospital
WEH90125 Amsco 3085 SP Surgical Table or Equal

- c. Back up position 55 degrees maximum (80 degrees in REVERSE orientation) or down 25 degrees maximum (105 degrees in REVERSE orientation) from horizontal.
- d. Leg up 80 degrees maximum (55 degrees in REVERSE orientation) or down 105 degrees maximum (25 degrees in REVERSE orientation) from seat section.
- e. Flex position back section down 20 degrees maximum with seat section down 25 degrees maximum from horizontal.
- f. Reflex position, back section up 25 degrees maximum with seat section up 35 degrees maximum from horizontal.
- g. Return to level-the tabletop can be returned to level by pressing the level control. The table must move in anatomically correct increments until it reaches level.
- h. Height-27" minimum to 44" maximum.
- L.) Each table must be rated to support 1,000 lb patients in a normal patient orientation.
- M.) Each table must be equipped with an auxiliary override system to allow table operation in the event of primary control malfunction.
- N.) The base will have at least four swivel casters to facilitate easy table relocation and movement.
- O.) The table base will have at least three floor locks.
- P.) Each table will have a T-shaped pedestal table base.
- Q.) Each table will have a shipping weight not greater than 1,000 pounds.
- R.) Each table length will be at least 75" no greater than 78".
- S.) Each table width will be at least 20" no greater than 22".
- T.) Each table will be constructed of quality materials and craftsmanship to be used in a surgical environment, with easy to clean surfaces that will resist stain, tarnish, and rust.

3.) Delivery and In-service Training

- A.) Delivery shall be within thirty (30) days after receipt of the approved purchase order. Vendor must deliver the equipment, setup, and provide instructional training on the equipment usage and features.
- B.) Within fifteen (15) days of the vendor's receipt of the approved purchase order, the selected vendor must contact the Director of Nursing at Welch Community Hospital for coordination of vendor's delivery and healthcare providers' in-service training.

Welch Community Hospital
WEH90125 Amsco 3085 SP Surgical Table or Equal

C.) Vendor will be responsible for the removal and disposal of delivery material and/or packing debris.

4.) Payment

The Vendor shall submit invoices, in arrears, to the Facility at the address on the face of the purchase order labeled "Invoice To" pursuant to the terms of the contract. Payment will be made in arrears, upon completion of delivery and in-service training. State law forbids payment of invoices prior to receipt of goods or services.

Cost Sheet
WEH90125 Amsco 3085 SP Surgical Table or Equal

Equipment Description	Quantity	Equipment Each	Total Equipment Cost
1. Amsco 3085 SP Surgical Table or Equal <i>Volante V1000</i>	2	\$ <i>33750</i>	\$ <i>67500.00</i>
2. X-ray Tops	2	\$ <i>1200.00</i>	\$ <i>2400.00</i>
3. Standard Accessory Package to include: Anesthesia Armboard w/3" Pad Qty. 2 Perineal Cutout Filler Piece Cable Wrap Conductive Restraint Strap: Standard Length 66 1/2 inches.	2	\$ <i>1000.00</i>	\$ <i>2000.00</i>
4. In-Service Training	1	\$ <i>0</i>	\$ <i>0</i>
5. Delivery Charge	1	\$ <i>1500.00</i>	\$ <i>1500.00</i>
Total			\$ <i>73400.00</i>

Award will be made to the vendor with the lowest overall grand total of all items requested in accordance with the bid specifications.

Vendor will invoice hospital for equipment, delivery and in-service, payment will be made in arrears.

 Vendor Signature

Sollan Gladstein/medical
 Vendor Name

6-17-09
 Date

device dept

RFQ No. WEH90125STATE OF WEST VIRGINIA
Purchasing Division**PURCHASING AFFIDAVIT****VENDOR OWING A DEBT TO THE STATE:**

West Virginia Code §5A-3-10a provides that: No contract or renewal of any contract may be awarded by the state or any of its political subdivisions to any vendor or prospective vendor when the vendor or prospective vendor or a related party to the vendor or prospective vendor is a debtor and the debt owed is an amount greater than one thousand dollars in the aggregate.

PUBLIC IMPROVEMENT CONTRACTS & DRUG-FREE WORKPLACE ACT:

If this is a solicitation for a public improvement construction contract, the vendor, by its signature below, affirms that it has a written plan for a drug-free workplace policy in compliance with Article 1D, Chapter 21 of the *West Virginia Code*. The vendor must make said affirmation with its bid submission. Further, public improvement construction contract may not be awarded to a vendor who does not have a written plan for a drug-free workplace policy in compliance with Article 1D, Chapter 21 of the *West Virginia Code* and who has not submitted that plan to the appropriate contracting authority in timely fashion. For a vendor who is a subcontractor, compliance with Section 5, Article 1D, Chapter 21 of the *West Virginia Code* may take place before their work on the public improvement is begun.

ANTITRUST:

In submitting a bid to any agency for the state of West Virginia, the bidder offers and agrees that if the bid is accepted the bidder will convey, sell, assign or transfer to the state of West Virginia all rights, title and interest in and to all causes of action it may now or hereafter acquire under the antitrust laws of the United States and the state of West Virginia for price fixing and/or unreasonable restraints of trade relating to the particular commodities or services purchased or acquired by the state of West Virginia. Such assignment shall be made and become effective at the time the purchasing agency tenders the initial payment to the bidder.

I certify that this bid is made without prior understanding, agreement, or connection with any corporation, firm, limited liability company, partnership or person or entity submitting a bid for the same materials, supplies, equipment or services and is in all respects fair and without collusion or fraud. I further certify that I am authorized to sign the certification on behalf of the bidder or this bid.

LICENSING:

Vendors must be licensed and in good standing in accordance with any and all state and local laws and requirements by any state or local agency of West Virginia, including, but not limited to, the West Virginia Secretary of State's Office, the West Virginia Tax Department, West Virginia Insurance Commission, or any other state agencies or political subdivision. Furthermore, the vendor must provide all necessary releases to obtain information to enable the Director or spending unit to verify that the vendor is licensed and in good standing with the above entities.

CONFIDENTIALITY:

The vendor agrees that he or she will not disclose to anyone, directly or indirectly, any such personally identifiable information or other confidential information gained from the agency, unless the individual who is the subject of the information consents to the disclosure in writing or the disclosure is made pursuant to the agency's policies, procedures and rules. Vendor further agrees to comply with the Confidentiality Policies and Information Security Accountability Requirements, set forth in <http://www.state.wv.us/admin/purchase/privacy/noticeConfidentiality.pdf>.

Under penalty of law for false swearing (*West Virginia Code* §61-5-3), it is hereby certified that the vendor affirms and acknowledges the information in this affidavit and is in compliance with the requirements as stated.

Vendor's Name: _____

Authorized Signature: _____

Date: _____

State of West Virginia **VENDOR PREFERENCE CERTIFICATE**

Certification and application* is hereby made for Preference in accordance with *West Virginia Code*, §5A-3-37. (Does not apply to construction contracts). *West Virginia Code*, §5A-3-37, provides an opportunity for qualifying vendors to request (at the time of bid) preference for their residency status. Such preference is an evaluation method only and will be applied only to the cost bid in accordance with the *West Virginia Code*. This certificate for application is to be used to request such preference. The Purchasing Division will make the determination of the Resident Vendor Preference, if applicable.

- 1. **Application is made for 2.5% resident vendor preference for the reason checked:**
 Bidder is an individual resident vendor and has resided continuously in West Virginia for four (4) years immediately preceding the date of this certification; or,
 Bidder is a partnership, association or corporation resident vendor and has maintained its headquarters or principal place of business continuously in West Virginia for four (4) years immediately preceding the date of this certification; or 80% of the ownership interest of Bidder is held by another individual, partnership, association or corporation resident vendor who has maintained its headquarters or principal place of business continuously in West Virginia for four (4) years immediately preceding the date of this certification; or,
 Bidder is a nonresident vendor which has an affiliate or subsidiary which employs a minimum of one hundred state residents and which has maintained its headquarters or principal place of business within West Virginia continuously for the four (4) years immediately preceding the date of this certification; or,
- 2. **Application is made for 2.5% resident vendor preference for the reason checked:**
 Bidder is a resident vendor who certifies that, during the life of the contract, on average at least 75% of the employees working on the project being bid are residents of West Virginia who have resided in the state continuously for the two years immediately preceding submission of this bid; or,
- 3. **Application is made for 2.5% resident vendor preference for the reason checked:**
 Bidder is a nonresident vendor employing a minimum of one hundred state residents or is a nonresident vendor with an affiliate or subsidiary which maintains its headquarters or principal place of business within West Virginia employing a minimum of one hundred state residents who certifies that, during the life of the contract, on average at least 75% of the employees or Bidder's affiliate's or subsidiary's employees are residents of West Virginia who have resided in the state continuously for the two years immediately preceding submission of this bid; or,
- 4. **Application is made for 5% resident vendor preference for the reason checked:**
 Bidder meets either the requirement of both subdivisions (1) and (2) or subdivision (1) and (3) as stated above; or,
- 5. **Application is made for 3.5% resident vendor preference who is a veteran for the reason checked:**
 Bidder is an individual resident vendor who is a veteran of the United States armed forces, the reserves or the National Guard and has resided in West Virginia continuously for the four years immediately preceding the date on which the bid is submitted; or,
- 6. **Application is made for 3.5% resident vendor preference who is a veteran for the reason checked:**
 Bidder is a resident vendor who is a veteran of the United States armed forces, the reserves or the National Guard, if, for purposes of producing or distributing the commodities or completing the project which is the subject of the vendor's bid and continuously over the entire term of the project, on average at least seventy-five percent of the vendor's employees are residents of West Virginia who have resided in the state continuously for the two immediately preceding years.

Bidder understands if the Secretary of Revenue determines that a Bidder receiving preference has failed to continue to meet the requirements for such preference, the Secretary may order the Director of Purchasing to: (a) reject the bid; or (b) assess a penalty against such Bidder in an amount not to exceed 5% of the bid amount and that such penalty will be paid to the contracting agency or deducted from any unpaid balance on the contract or purchase order.

By submission of this certificate, Bidder agrees to disclose any reasonably requested information to the Purchasing Division and authorizes the Department of Revenue to disclose to the Director of Purchasing appropriate information verifying that Bidder has paid the required business taxes, provided that such information does not contain the amounts of taxes paid nor any other information deemed by the Tax Commissioner to be confidential.

Under penalty of law for false swearing (*West Virginia Code*, §61-5-3), Bidder hereby certifies that this certificate is true and accurate in all respects; and that if a contract is issued to Bidder and if anything contained within this certificate changes during the term of the contract, Bidder will notify the Purchasing Division in writing immediately.

Bidder: John W. D. Steen Medical Device Depot Signed: [Signature]
 Date: 1-17-09 Title: Vice President

*Check any combination of preference consideration(s) indicated above, which you are entitled to receive.



VOLANTÉ
SURGICAL TABLES



PRODUCT
OVERVIEW

Medical Device Depot, Inc.
3230 Bethany Lane, Suite 6
Ellicott City, MD 21042
877-848-3300
www.medicaldevicedepot.com

Medical Device Depot, Inc.
3230 Bethany Lane, Suite 8
Ellicott City, MD 21042
877-646-3300
www.medicaldevicedepot.com

NUVO

Volanté

Versatility begins with "V" ...



Full-feature table controlled
by hand control or optional
foot control

Medical Device Depot, Inc.
3230 Bethany Lane, Suite 8
Ellicott City, MD 21042
877-646-3300
www.medicaldevicedepot.com

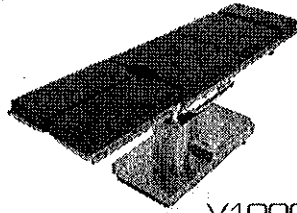

V1000T

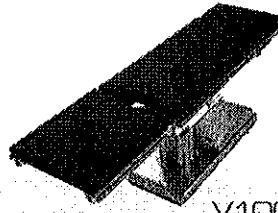

V1000

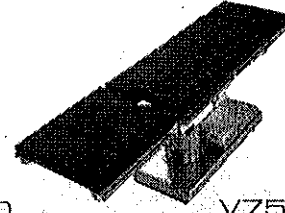

V750

The Volanté Series of Surgical Tables.

- Sleek, streamlined stainless steel construction
- Powered surgical table with 180° rotating top
- Full-length radiolucent top
- Offset cylindrical column for superior imaging
- Superior weight capacity
- Standard back-up battery
- Auto-leveling brake system
- 12" horizontal slide
- Full line of accessories for all specialties
- Optional traction bar assembly
- Removable head and/or leg section
- All models include 2" pressure-relieving mattress
- Ease of movement with steering castors

180° ROTATING TOP

Experience the ease of patient positioning with the Volanté 180° rotating top.

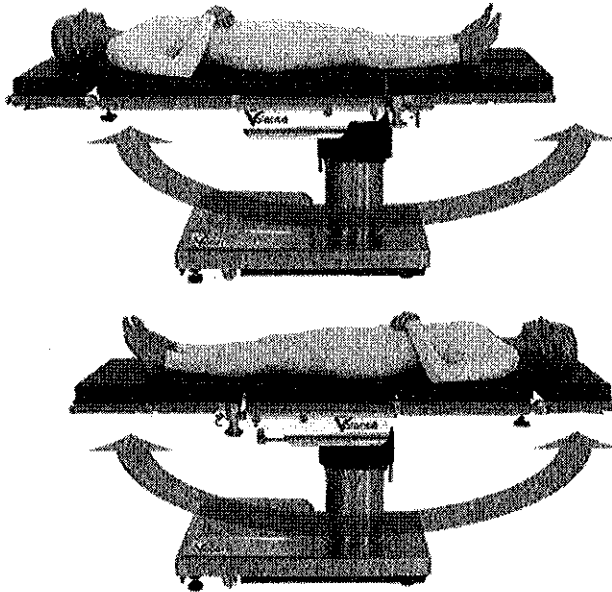

ENHANCED IMAGING ACCESS

"Image" the possibilities with the Volanté line of surgical tables.

V1000T

Volanté's V1000T 12" horizontal sliding top offers superior full-body imaging access. Whether it's the upper torso or lower extremities, the surgical staff will have total control at their fingertips.

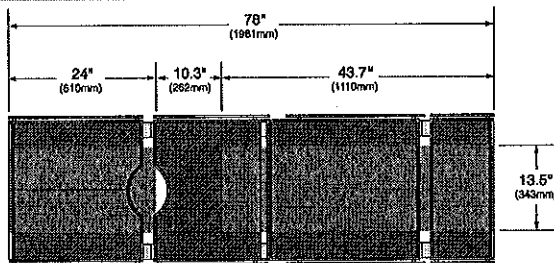

X-ray via cassette tunnel, and C-arm Imaging
Table Traversed Toward Head →

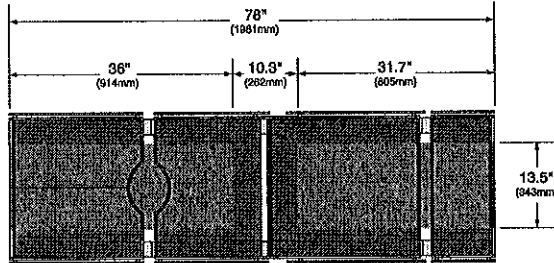

X-ray via cassette tunnel, and C-arm Imaging
← Table Traversed Toward Foot

Medical Device Depot, Inc.
3230 Bethany Lane, Suite 8
Ellicott City, MD 21042
877-646-3300
www.medicaldevicedepot.com

V1000 & V750

Volanté's V1000 and V750 offer excellent C-arm access with 180° rotating table top.

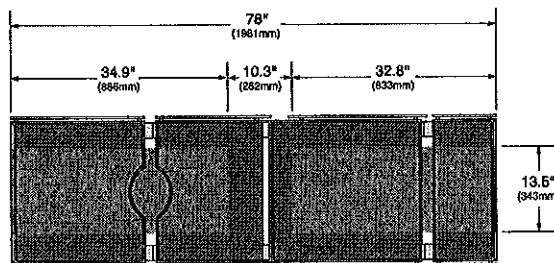

X-ray via cassette tunnel, and C-arm imaging

Models V1000T, V1000 & V750

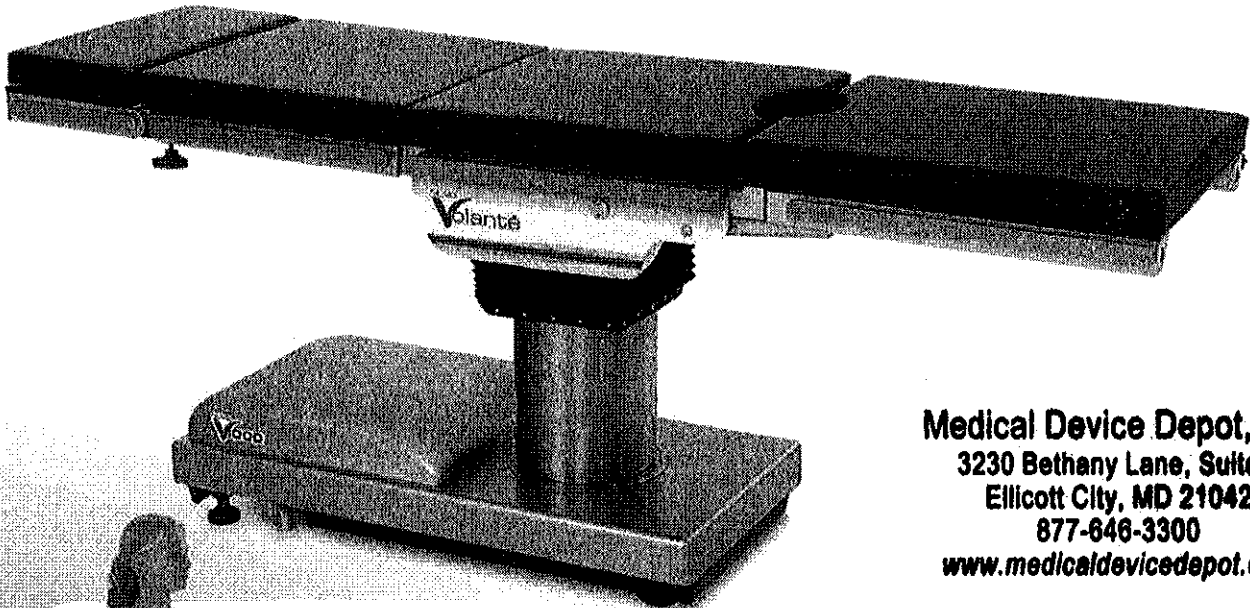

Medical Device Depot, Inc.
3230 Bethany Lane, Suite 8
Ellicott City, MD 21042
877-646-3300
www.medicaldevicedepot.com

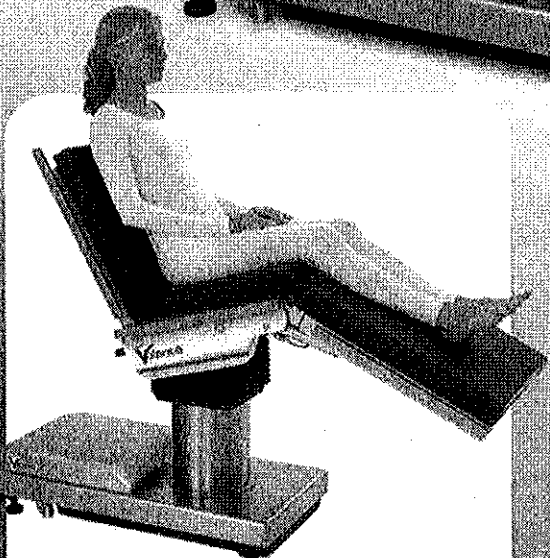

Neurological
Seated Position

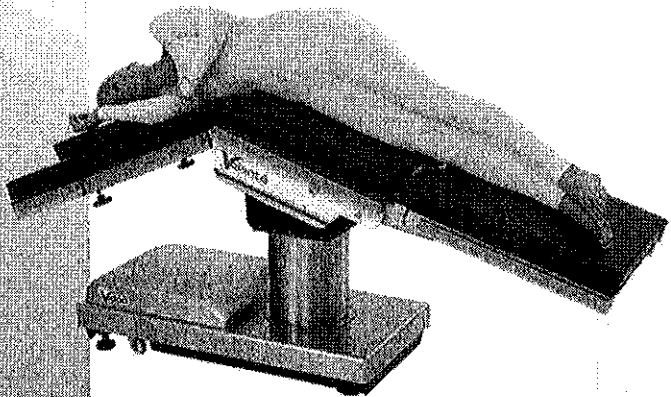

Nephrectomy
Procedure

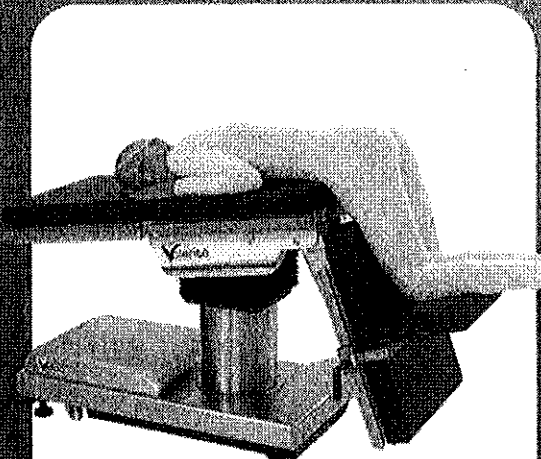

Laminectomy
Procedure

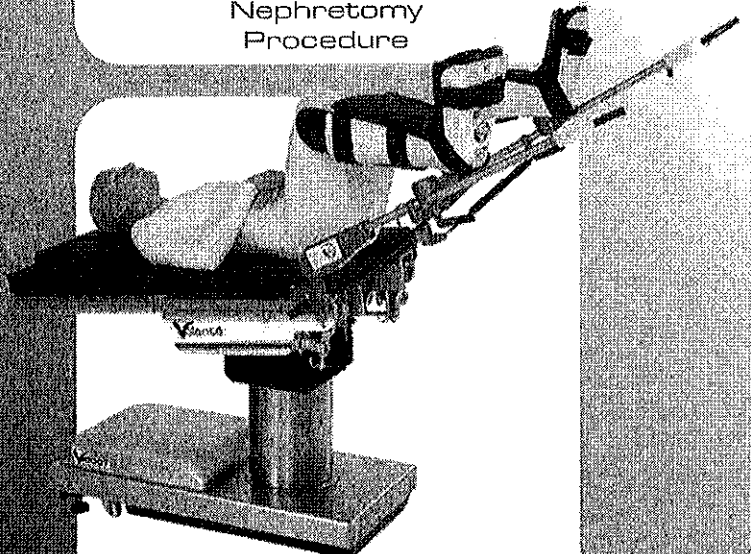

Gynecology & Urology
Procedures

V1000T Orthopedic

When you don't have
time to waste ...
Volanté Traction Assembly

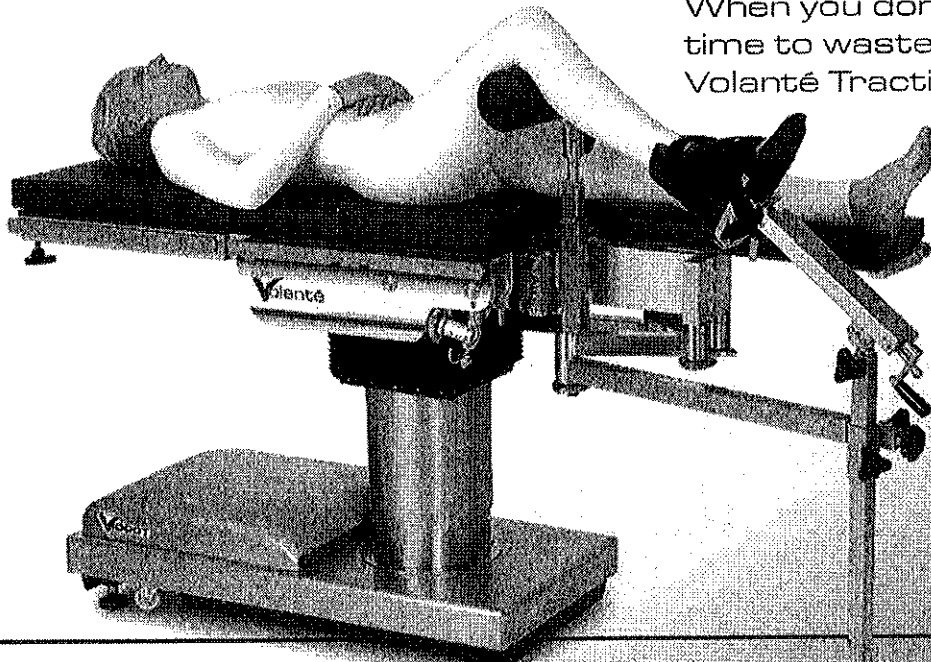

Medical Device Depot, Inc.
3230 Bethany Lane, Suite 8
Ellicott City, MD 21042
877-646-3300
www.medicaldevicedepot.com

Fibula and Tibia

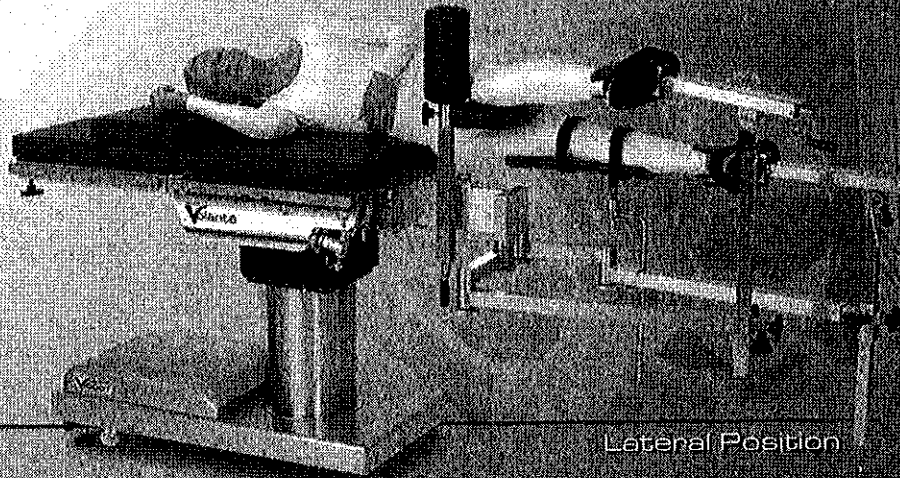
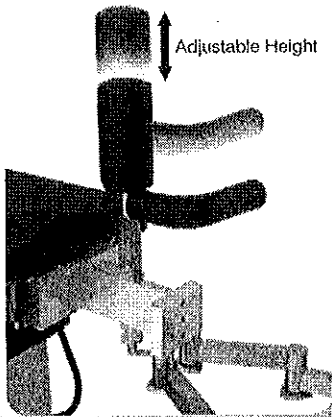

Lateral Position

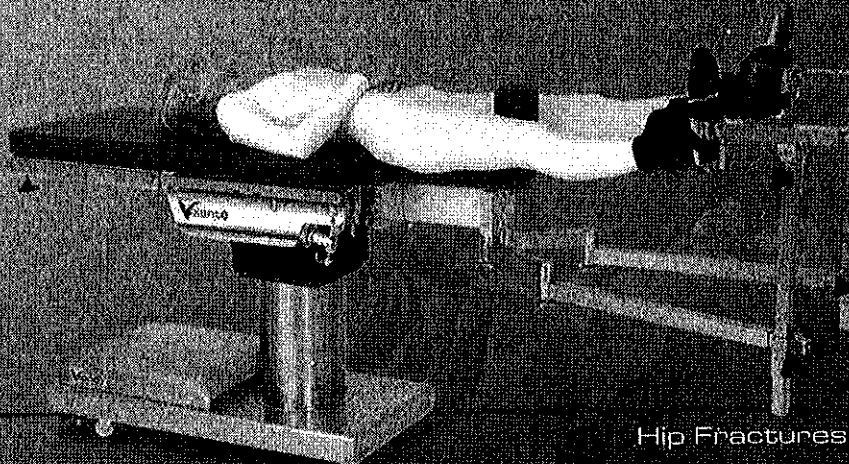
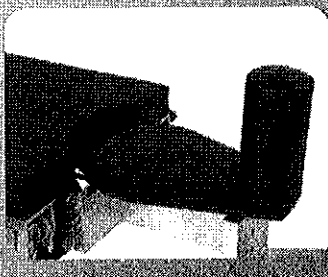

Hip Fractures

Medical Device Depot, Inc.
3230 Bethany Lane, Suite 8
Ellicott City, MD 21042
877-646-3300

Volanté Traction Assembly requires only one person for installation. www.medicaldevicedepot.com
Simply remove the standard split leg section of the Volanté V1000T and the traction assembly attaches effortlessly. The V1000T is a surgical table for all specialties.

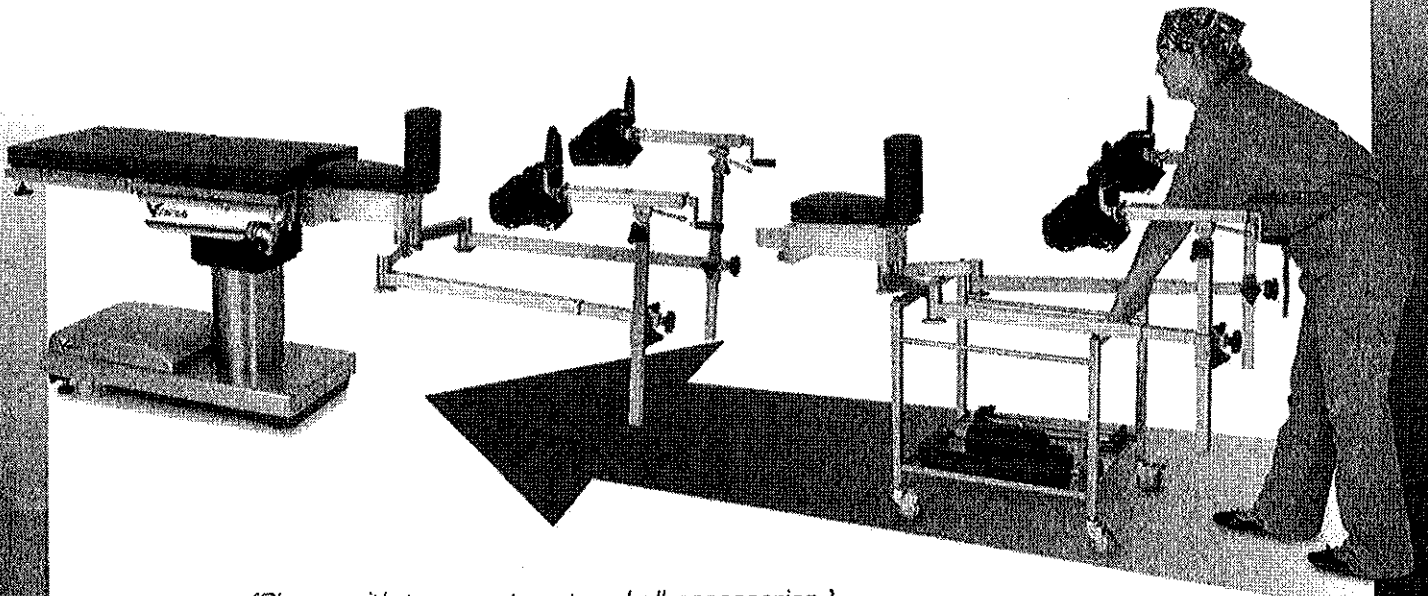

(Shown with transport cart and all accessories.)

NUVO Shoulder Chair



NUVO Shoulder Chair attaches effortlessly to the Volanté line

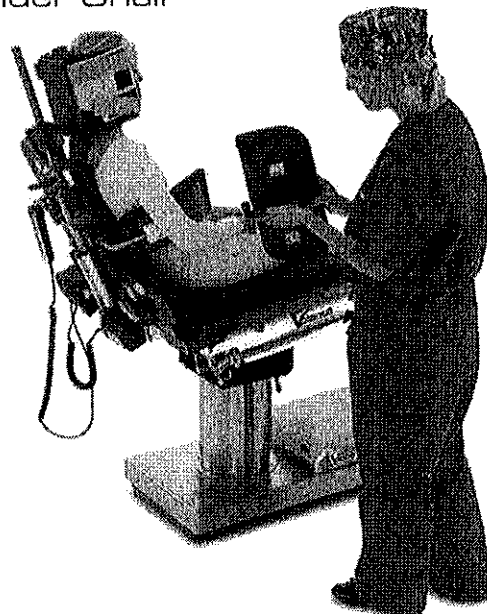

Lateral support and removable wings for unparalleled access

Models

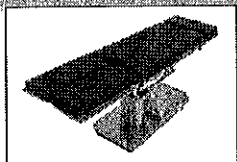

V1000T

1000 lbs. Lift Capacity
 800 lbs. Articulation
 12" Horizontal Slide
 180° Rotating Top

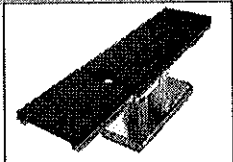

V1000

1000 lbs. Lift Capacity
 800 lbs. Articulation
 180° Rotating Top
 Removable Head Section
 can be attached to Leg Section

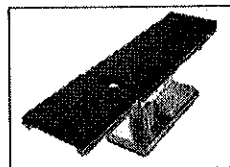

V750

750 lbs. Lift Capacity
 750 lbs. Articulation
 180° Rotating Top
 Removable Head Section
 can be attached to Leg Section

Removable Head Section
 Standard Removable Split Leg Section
 Optional Traction Bar Assembly
 Ideal for all Specialties

From Trauma Surgery to Ambulatory Surgery, the Volanté Series brings versatility to the operating room.

Dimensions

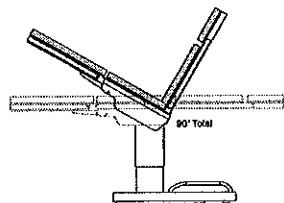
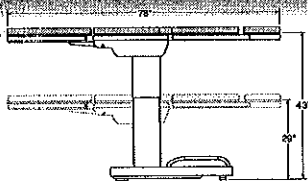

Reflex 90°

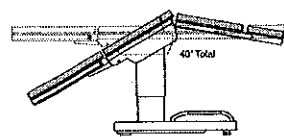

Flex 40°

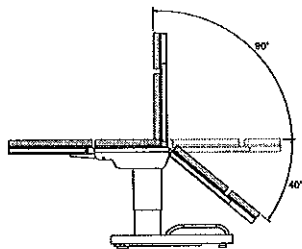

Back Up 90°
 Back Down 40°

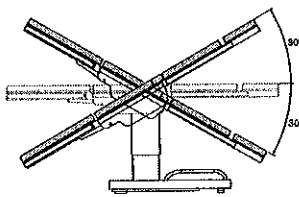

30° Trendelenburg
 and Reverse Trendelenburg

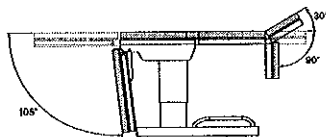

Head Up 30° Head Down 90°
 Leg Up 0° Leg Down 105°

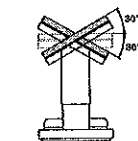

30° Lateral Tilt
 Right & Left

Table Top	
Length:	78 inches
Width:	19 3/4 inches
Max. Height:	43 inches
Min. Height:	29 inches
Lift Capacity	
V1000T	1,000 lbs.
V1000	1,000 lbs.
V750	750 lbs.
Articulation	
V1000T	800 lbs.
V1000	800 lbs.
V750	750 lbs.
Lateral Tilt	
	30 degrees
Trendelenburg	
	30 degrees
Back Section	
	+ 90 degrees
	- 40 degrees
Head Section	
	+ 30 degrees
	- 90 degrees
Leg Section	
	+ 0 degrees
	- 105 degrees
Table Rotation	
	180 degrees
Self-Leveling Brakes	
	Powered

MUVO

MEDICAL DEVICE DEPOT, INC.