



State of West Virginia
 Department of Administration
 Purchasing Division
 2019 Washington Street East
 Post Office Box 50130
 Charleston, WV 25305-0130

Request for Quotation

RFQ NUMBER
DNR209114

PAGE
1

ADDRESS CORRESPONDENCE TO ATTENTION OF:
FRANK WHITTAKER 304-558-2316

VENDOR

*709022058 800-848-7556
 SERVICE SUPPLY LTD
 1524 SOUTH HAMILTON RD

 COLUMBUS OH 43227

SHIP TO

DIVISION OF NATURAL RESOURCES
 CABWAYLINGO STATE FOREST
 ATTN: PARK SUPERINTENDENT
 ROUTE 1, BOX 85
 DUNLOW, WV 25511 385-4255

DATE PRINTED	TERMS OF SALE	SHIP VIA	F.O.B.	FREIGHT TERMS
04/21/2009				

BID OPENING DATE: **05/26/2009** BID OPENING TIME **01:30PM**

LINE	QUANTITY	UOP	CAT. NO.	ITEM NUMBER	UNIT PRICE	AMOUNT
0001	1	LS		650-38		
<p>PLAYGROUND EQUIPMENT (NOT OTHERWISE CLASSIFIED)</p> <p>THE WEST VIRGINIA PURCHASING DIVISION, FOR THE AGENCY, THE WEST VIRGINIA DIVISION OF NATURAL RESOURCES, IS SOLICITING BIDS FROM RESPONSIBLE VENDORS TO PROVIDE PLAYGROUND EQUIPMENT FOR CABWAYLINGO STATE FOREST PER THE ATTACHED SPECIFICATIONS.</p> <p>A MANDATORY PRE-BID MEETING WILL BE HELD ON MAY 6, 2009 AT 10:00 AM AT THE PARK HEADQUARTERS. FAILURE TO ATTEND THE MANDATORY MEETING WILL RESULT IN BID DISQUALIFICATION. AN INDIVIDUAL MAY NOT REPRESENT MORE THAN 1 (ONE) FIRM AT THE MANDATORY PRE-BID MEETING.</p> <p>TECHNICAL QUESTIONS MAY BE SUBMITTED IN WRITING TO FRANK WHITTAKER IN THE PURCHASING DIVISION VIA FAX AT 304-558-4115 OR VIA EMAIL AT FRANK.M.WHITTAKER@WV.GOV. DEADLINE FOR TECHNICAL QUESTIONS IS 05/07/09 @ 3:00 PM. ALL TECHNICAL QUESTIONS WILL BE ADDRESSED BY ADDENDUM AFTER THE DEADLINE.</p> <p>BANKRUPTCY: IN THE EVENT THE VENDOR/CONTRACTOR FILES FOR BANKRUPTCY PROTECTION, THIS CONTRACT MAY BE DEEMED NULL AND VOID, AND TERMINATED WITHOUT FURTHER ORDER.</p> <p>THE MODEL/BRAND/SPECIFICATIONS NAMED HEREIN ESTABLISH THE ACCEPTABLE LEVEL OF QUALITY ONLY AND ARE NOT</p>						

RECEIVED

2009 JUN -2 P 10:03

PURCHASING DIVISION
STATE OF WV

SEE REVERSE SIDE FOR TERMS AND CONDITIONS

SIGNATURE <i>Frank Whittaker</i>	TELEPHONE 800-848-7556	DATE 5/29/09
TITLE VICE PRESIDENT	ADDRESS CHANGES TO BE NOTED ABOVE	

WHEN RESPONDING TO RFQ, INSERT NAME AND ADDRESS IN SPACE ABOVE LABELED 'VENDOR'



State of West Virginia
 Department of Administration
 Purchasing Division
 2019 Washington Street East
 Post Office Box 50130
 Charleston, WV 25305-0130

Request for Quotation

RFQ NUMBER
DNR209114

PAGE
2

ADDRESS CORRESPONDENCE TO ATTENTION OF
FRANK WHITTAKER
304-558-2316

VENDOR

*709022058 800-848-7556
 SERVICE SUPPLY LTD
 1524 SOUTH HAMILTON RD

 COLUMBUS OH 43227

SHIP TO

DIVISION OF NATURAL RESOURCES
 CABWAYLINGO STATE FOREST
 ATTN: PARK SUPERINTENDENT
 ROUTE 1, BOX 85
 DUNLOW, WV
 25511 385-4255

DATE PRINTED	TERMS OF SALE	SHIP VIA	F.O.B.	FREIGHT TERMS
04/21/2009				

BID OPENING DATE: **05/26/2009** BID OPENING TIME **01:30PM**

LINE	QUANTITY	UOP	CAT NO	ITEM NUMBER	UNIT PRICE	AMOUNT
<p>INTENDED TO REFLECT A PREFERENCE OR FAVOR ANY PARTICULAR BRAND OR VENDOR. VENDORS WHO ARE BIDDING ALTERNATES SHOULD SO STATE AND INCLUDE PERTINENT LITERATURE AND SPECIFICATIONS. FAILURE TO PROVIDE INFORMATION FOR ANY ALTERNATES MAY BE GROUNDS FOR REJECTION OF THE BID. THE STATE RESERVES THE RIGHT TO WAIVE MINOR IRREGULARITIES IN BIDS OR SPECIFICATIONS IN ACCORDANCE WITH SECTION 148-1-4(F) OF THE WEST VIRGINIA LEGISLATIVE RULES AND REGULATIONS.</p> <p style="text-align: center;">NOTICE</p> <p>A SIGNED BID MUST BE SUBMITTED TO:</p> <p style="padding-left: 40px;">DEPARTMENT OF ADMINISTRATION PURCHASING DIVISION BUILDING 15 2019 WASHINGTON STREET, EAST CHARLESTON, WV 25305-0130</p> <p>THE BID SHOULD CONTAIN THIS INFORMATION ON THE FACE OF THE ENVELOPE OR THE BID MAY NOT BE CONSIDERED:</p> <p>SEALED BID</p> <p>BUYER: 44</p> <p>RFQ. NO.: DNR209114</p> <p>BID OPENING DATE: 05/26/09</p> <p>BID OPENING TIME: 1:30 PM</p>						

SEE REVERSE SIDE FOR TERMS AND CONDITIONS

SIGNATURE 	TELEPHONE 800-848-7556	DATE 5/29/09
TITLE VICE PRESIDENT	ADDRESS CHANGES TO BE NOTED ABOVE	

WHEN RESPONDING TO RFQ, INSERT NAME AND ADDRESS IN SPACE ABOVE LABELED 'VENDOR'



State of West Virginia
 Department of Administration
 Purchasing Division
 2019 Washington Street East
 Post Office Box 50130
 Charleston, WV 25305-0130

Request for Quotation

RFQ NUMBER DNR209114

PAGE 3

ADDRESS CORRESPONDENCE TO ATTENTION OF: FRANK WHITTAKER 304-558-2316

VENDOR

*709022058 800-848-7556
 SERVICE SUPPLY LTD
 1524 SOUTH HAMILTON RD

 COLUMBUS OH 43227

SHIP TO

DIVISION OF NATURAL RESOURCES
 CABWAYLINGO STATE FOREST
 ATTN: PARK SUPERINTENDENT
 ROUTE 1, BOX 85
 DUNLOW, WV
 25511 385-4255

DATE PRINTED	TERMS OF SALE	SHIP VIA	F.O.B.	FREIGHT TERMS
04/21/2009				

BID OPENING DATE: **05/26/2009** BID OPENING TIME **01:30PM**

LINE	QUANTITY	UOP	CAT NO	ITEM NUMBER	UNIT PRICE	AMOUNT
<p>PLEASE PROVIDE A FAX NUMBER IN CASE IT IS NECESSARY TO CONTACT YOU REGARDING YOUR BID: ----- 614-863-0113 -----</p> <p>CONTACT PERSON (PLEASE PRINT CLEARLY): ----- JERRY GROVES, VICE PRESIDENT -----</p> <p>***** THIS IS THE END OF RFQ DNR209114 ***** TOTAL: _____</p>						

SEE REVERSE SIDE FOR TERMS AND CONDITIONS			
SIGNATURE <i>Jerry Groves</i>	TELEPHONE 800-848-7556	DATE 5/29/09	
TITLE VICE PRESIDENT	FEIN	ADDRESS CHANGES TO BE NOTED ABOVE	

WHEN RESPONDING TO RFQ, INSERT NAME AND ADDRESS IN SPACE ABOVE LABELED 'VENDOR'

WVDNR209114
Cabwaylingo State Forest Playground Specifications

To provide playground equipment at Cabwaylingo State Forest in Dunlow, West Virginia and offer play and physical activity for children ages five (5) to twelve (12). Playground equipment will be purchased for four (4) separate areas in the park. Park personnel will install all playground equipment. The award may be split if it is in the best interest of the West Virginia Division of Natural Resources. All items are to be F.O.B. Destination. Freight or delivery charges must be included in the price of the goods. Delivery must be made within sixty (60) days of purchase order award.

Long Branch Picnic Area Playground

GameTime freestanding stainless steel straight chuters slide, Item #8681, or equal. Slide must be a minimum of 6' in height; must have a top platform enclosed with metal bars; and steps to platform must have hand railings.

GameTime the whirl (Merry-Go-Round), Item #919, or equal. Equipment must have four metal u-shaped handrails on a one-piece platform with a hydraulic speed limit; and must have concealed fastener style hardware.

GameTime tire swing (one bay), Item #1077, or equal. Swing top rail must be a minimum height of 6'8"; and swing bay must be composed of galvanized steel uprights and top rail.

GameTime 8' classic swing frame, Item #P8542, or equal. Swing base must have a minimum of 2 3/8" OD top rail and legs; must be constructed of a minimum of 13 gauge galvanized pipe; and must be powder coated.

GameTime 8' classic swing frame add-a-bay, Item #P8546, or equal. Frame must have a minimum of 2 3/8" OD top rail and legs; and must be an "A" frame style.

GameTime enclosed tot seat with clevis, Item #8695, or equal. Seat must include galvanized chain and hardware for a minimum of a 2 3/8" swing frame.

Crum/Morgan Area Playground

GameTime freestanding stainless steel straight chuters slide, Item #8681, or equal. Slide must be a minimum of 6' in height; must have a top platform enclosed with metal bars; and must have steps to platform must have hand railings.

WVDNR209114
Cabwaylingo State Forest Playground Specifications

GameTime buck-a-bouts, Item #243, or equal. Buck-a-bouts must have a minimum of two (2) seats with rubber springs; each seat must metal footings for both feet; and must have a U-shaped handrail (saddle seat).

GameTime saddle mates for buck-a-bout rider, Item #2313, or equal. Seats must be metal with hand holders.

GameTime cruisin mates desert commando car, Item #6058, or equal. Car must have a minimum of two (2) spring mounts; must have handholds constructed of a minimum of 1 1/6" OD galvanized pipe and a minimum of 3/16" thick flat steel; and must have a powder coat finish.

GameTime adventure mate, dinosaur rider, Item #6051, or equal. Rider must be mounted with a minimum of three (3) spring bases; and must have galvanized steel plate mounting.

GameTime in-ground mount package for the dinosaur spring mate, Item #6065, or equal.

Lower Walnut Picnic Area Playground

GameTime freestanding stainless steel straight chuters slide, Item #8681, or equal. Slide must be a minimum of 6' in height; must have a top platform enclosed with metal bars; and steps to platform must have hand railings.

GameTime PowerScape single station climber, Challenge Station, single tower, Item #8533, or equal. Station must be a minimum of 6' 4" in height; and must be composed of metal climbing stations, platform, and supports. Unit must include a cosmix climber or equal; climber must have a minimum of two openings for feet and a minimum of six openings for hands.

GameTime 8' classic swing frame, Item #P8542, or equal. Swing base must have a minimum of 2 3/8" OD top rail and legs; must be constructed of a minimum of 13 gauge galvanized pipe; and must be powder coated.

GameTime, 8' classic swing frame add-a-bay, Item #P8546, or equal. Frame must have a minimum of 2 3/8" OD top rail and legs; and must be an "A" frame style.

Game Time enclosed tot seat with clevis, Item #8695, or equal. Seat must include galvanized chain and hardware for a minimum of a 2 3/8" swing frame.

WVDNR209114
Cabwaylingo State Forest Playground Specifications

GameTime fire engine vehicle climber, Item #7002, or equal. Climber must have a deck height a minimum of 2' from ground; must be constructed of polyethylene molding; and must include steel hardware.

Spruce Creek Area Playground

GameTime freestanding stainless steel straight chuters slide, Item #8681, or equal. Slide must be a minimum of 6' in height; must have a top platform enclosed with metal bars; and must have steps to platform must have hand railings.

GameTime space module climber, Item #618, or equal. Freestanding climber must have a minimum of two (2) center posts; and must include rails surrounding the inside of the top and bottom platform.

GameTime buck-a-bouts, Item #243, or equal. Buck-a-bouts must have a minimum of two (2) seats with rubber springs; each seat must metal footings for both feet; and a U-shaped handrail (saddle seat).

GameTime saddle mates for buck-a-bout rider, Item #2313, or equal. Seats must be metal with hand holders.

ITEMS FOR ALL FOUR PLAYGROUNDS

Geo-textile fabric, 2,250 sq. ft. roll, or equal. Fabric must provide a water permeable separation between the earth and the wood fiber and at least 150 gallons per square foot per minute.

Game Time, Geo-Textile Fabric, 1,125 sq. ft. roll, or equal. Fabric rolls provide a water permeable separation between the earth and the wood fiber. 150 gallons per square foot per minute.

Certified engineered wood fiber or equal. Material must be recently harvested and debarked; free of chemical treatments and additives; free of soil, twigs, leaves and other contaminates.

WVDNR209114
Cabwaylingo State Forest Playground Specifications

All playground equipment and engineered wood fiber must meet the following requirements:

- Compliance with U.S. Consumer Product Safety Commission, Handbook for Public Playground Safety.
- Compliance with ASTM Standard F 1487.
- Compliance with Architectural and Transportation Barriers Compliance Board, Americans with Disabilities Act (ADA) Accessibility Guidelines for Buildings and Facilities; Play Areas.

Vendors must submit the following attachments:

- Complete manufacturer's parts specifications and warranties.
- Layout drawing to scale of the proposed play structure or equipment.
- ASTM and CPSC Statement of Compliance

Warranties:

- All equipment and engineered wood fiber must be guaranteed to be free of defects in workmanship and material for a minimum of one year from date of acceptance. However, if manufacturer warranty periods are longer than the required minimum one year warranty, those warranties shall apply.

Color scheme of equipment must be coordinated with Cabwaylingo State Forest. Color of items will be selected from manufacturer's standard colors.

A mandatory pre-bid conference will be held on May 6, 2009, at Cabwaylingo State Forest Headquarters at 10:00 a.m. A failure to attend the mandatory pre-bid conference will result in bid disqualification. An individual may not represent more than one firm at the pre-bid conference.

WVDNR209114
Cabwaylingo State Forrest
PLAYGROUND EQUIPMENT SHEET

Please complete the below information concerning the brand(s) of equipment being bid in relation to this project. If bidding "or equal" brands, please attach manufacturer's literature documenting that it meets the mandatory requirements stated in the specifications. Vendors should note the areas of the provided manufacturer's literature that adheres to the mandatory requirements outlined in the Request For Quotation.

Item No.	Equipment	Manufacturer	Item
1	Long Branch Picnic Area Playground Game Time freestanding stainless steel straight chuters slide, Item #8681, or equal.	Landscape Structures Inc.	#34759 Stainless steel slide
2	Long Branch Picnic Area Playground Game Time the whirl (Merry-Go-Round), Item #919, or equal.	Sportsplay	# Whirl
3	Long Branch Picnic Area Playground Game Time tire swing (one bay), Item #10777, or equal.	Landscape Structures Inc.	#120891A Tire Swing
4	Long Branch Picnic Area Playground GameTime 8' classic swing frame, Item #P8542, or equal.	Landscape Structures Inc.	Custom Swing #34759 #122837A
5	Long Branch Picnic Area Playground GameTime, 8' classic swing frame add-a-bay, Item #P8546, or equal.	Include in #4	
6	Long Branch Picnic Area Playground Game Time enclosed tot seat with clevis, Item #8695, or equal.	Included in #4	
7	Crum/ Morgan Area Playground Game Time freestanding stainless steel straight chuters slide, Item #8681, or equal.	Landscape Structures Inc.	#34759
8	Crum/ Morgan Area Playground GameTime buck-a-bouts, Item #243, or equal.	Landscape Structures Inc.	#148636A-B
9	Crum/ Morgan Area Playground GameTime saddle mates for buck-a-bout rider, Item #2313, or equal.	Seats included in #8	

WVDNR209114
 Cabwaylingo State Forrest
PLAYGROUND EQUIPMENT SHEET

Item No.	Equipment	Manufacturer	Item
10	Crum/ Morgan Area Playground GameTime cruisin mates desert commando car, Item #6058, or equal.	Landscape Structures Inc.	#157290A-B Car
11	Crum/ Morgan Area Playground GameTime adventure mate, dinosaur rider, Item #6051, or equal.	Landscape Structures Inc.	#100123A-B Rhino Dino
12	Crum/ Morgan Area Playground GameTime in-ground mount package for the dinosaur spring mate, Item #6065, or equal.	Include in #11	
13	Lower Walnut Picnic Area Playground GameTime freestanding stainless steel straight chuters slide, Item #8681, or equal.	Landscape Structures Inc.	#34759
14	Lower Walnut Picnic Area Playground GameTime, PowerScape single station climber, Challenge Station, single tower, Item #8533, or equal.	Landscape Structures Inc.	#34759-1-1-3 Custom Playbooster
15	Lower Walnut Picnic Area Playground GameTime 8' classic swing frame, Item #P8542, or equal.	Landscape Structures Inc.	#122837A #34759 Custom Swing
16	Lower Walnut Picnic Area Playground GameTime, 8' classic swing frame add-a- bay, Item #P8546, or equal.	Include in #16	
17	Lower Walnut Picnic Area Playground GameTime enclosed tot seat with clevis, Item #8695, or equal.	Included in #16	
18	Lower Walnut Picnic Area Playground GameTime, Fire Engine Vehicle Climber, Item No. 7002 or Equal.	Sportsplay	#902-798
19	Spruce Creek Area Playground GameTime freestanding stainless steel straight chuters slide, Item #8681, or equal.	Landscape Structures Inc.	#34759

WVDNR209114
 Cabwaylingo State Forrest
PLAYGROUND EQUIPMENT SHEET

Item No.	Equipment	Manufacturer	Item
20	Spruce Creek Area Playground GameTime space module climber, Item #618, or equal.	Landscape Structures Inc.	#154359A Orbitor-3-IP
21	Spruce Creek Area Playground GameTime buck-a-bouts, Item #243, or equal.	Landscape Structures Inc.	#148636A-B
22	Spruce Creek Area Playground GameTime saddle mates for buck-a-bout rider, Item #2313, or equal.	Included in #21	
23	Items For All Four Playgrounds Geotextile fabric, 2,250 sq. ft. roll, or equal.	Zeager Bros.	Geotextile
24	Items For All Four Playgrounds Geotextile fabric, 1,125 sq. ft. roll, or equal.	Zeager Bros	Mulch
25	Items For All Four Playgrounds Certified engineered wood fiber or equal.	Zeager Bros	Mulch

Cabwaylingo State Forest Playground Equipment
PRICING SHEET

Item No.	Quantity	Description	Unit Price	Amount
1	1	Long Branch Picnic Area Playground Game Time freestanding stainless steel straight chuters slide, Item #8681, or equal.	\$ 3,600.00	\$ 3,600.00
2	1	Long Branch Picnic Area Playground Game Time the whirl (Merry-Go-Round), Item #919, or equal.	\$ 2,600.00	\$ 2,600.00
3	1	Long Branch Picnic Area Playground Game Time tire swing (one bay), Item #10777, or equal.	\$ 2,400.00	\$ 2,400.00
4	1	Long Branch Picnic Area Playground GameTime 8' classic swing frame, Item #P8542, or equal.	\$ 1,900.00	\$ 1,900.00
5	1	Long Branch Picnic Area Playground GameTime, 8' classic swing frame add-a-bay, Item #P8546, or equal.	Included in	#4
6	2	Long Branch Picnic Area Playground Game Time enclosed tot seat with clevis, Item #8695, or equal.	Included in	#4
7	1	Crum/ Morgan Area Playground Game Time freestanding stainless steel straight chuters slide, Item #8681, or equal.	\$ 3,600.00	\$ 3,600.00
8	2	Crum/ Morgan Area Playground GameTime buck-a-bouts, Item #243, or equal.	\$ 1,600.00	\$ 3,200.00
9	4	Crum/ Morgan Area Playground GameTime saddle mates for buck-a-bout rider, Item #2313, r equal.	Seats included	in #8
10	1	Crum/ Morgan Area Playground GameTime cruisin mates desert commando car, Item #6058, or equal.	\$ 850.00	\$ 850.00
11	1	Crum/ Morgan Area Playground GameTime adventure mate, dinosaur rider, Item #6051, or equal.	\$ 750.00	\$ 750.00

**Cabwaylingo State Forest Playground Equipment
PRICING SHEET**

Item No.	Quantity	Description	Unit Price	Amount
12		Crum/ Morgan Area Playground GameTime in-ground mount package for the dinosaur spring mate, Item #6065, or equal.	Included in	#11
13	1	Lower Walnut Picnic Area Playground GameTime freestanding stainless steel straight chuters slide, Item #8681, or equal.	\$ 3,600.00	\$ 3,600.00
14	1	Lower Walnut Picnic Area Playground GameTime, PowerScope single station climber, Challenge Station, single tower, Item #8533, or equal.	\$ 9,000.00	\$ 9,000.00
15	1	Lower Walnut Picnic Area Playground GameTime 8' classic swing frame, Item #P8542, or equal.	\$ 1,900.00	\$ 1,900.00
16	1	Lower Walnut Picnic Area Playground GameTime, 8' classic swing frame add- a-bay, Item #P8546, or equal.	Included in	#15
17	2	Lower Walnut Picnic Area Playground GameTime enclosed tot seat with clevis, Item #8695, or equal.	Included in	#15
18	1	Lower Walnut Picnic Area Playground GameTime, Fire Engine Vehicle Climber, Item #7002, or equal.	\$ 5,000.00	\$ 5,000.00
19	1	Spruce Creek Area Playground GameTime freestanding stainless steel straight chuters slide, Item #8681, or equal.	\$ 3,600.00	\$ 3,600.00
20	1	Spruce Creek Area Playground GameTime space module climber, Item #618, or equal.	\$ 3,500.00	\$ 3,500.00
21	4	Items For All Four Playgrounds Geo- textile fabric, 2,250 sq. ft. roll, or equal. 9,000 sq. ft.	\$.25 square foot	\$ 2,250.00
22	1	Items For All Four Playgrounds Geo- textile fabric, 1,125 sq. ft. roll, or equal.	\$.25 square foot	\$ 281.25

Cabwaylingo State Forest Playground Equipment
PRICING SHEET

Item No.	Quantity	Description	Unit Price	Amount
23	9,811 sq. ft.	Items For All Four Playgrounds Certified engineered wood fiber or equal.	\$ 1.05 square feet	\$10,301.55
		TOTAL		\$58,332.80

IF NEEDED ADD TO ABOVE, NOTE: LEFT OUT ON PRICING SHEET:

ITEM #21 BUCK-A-BOUT ADD \$1,600.00 EACH UNIT

ITEM #22 INCLUDED IN ITEM #21

Individual
Area
Spec's

Swings

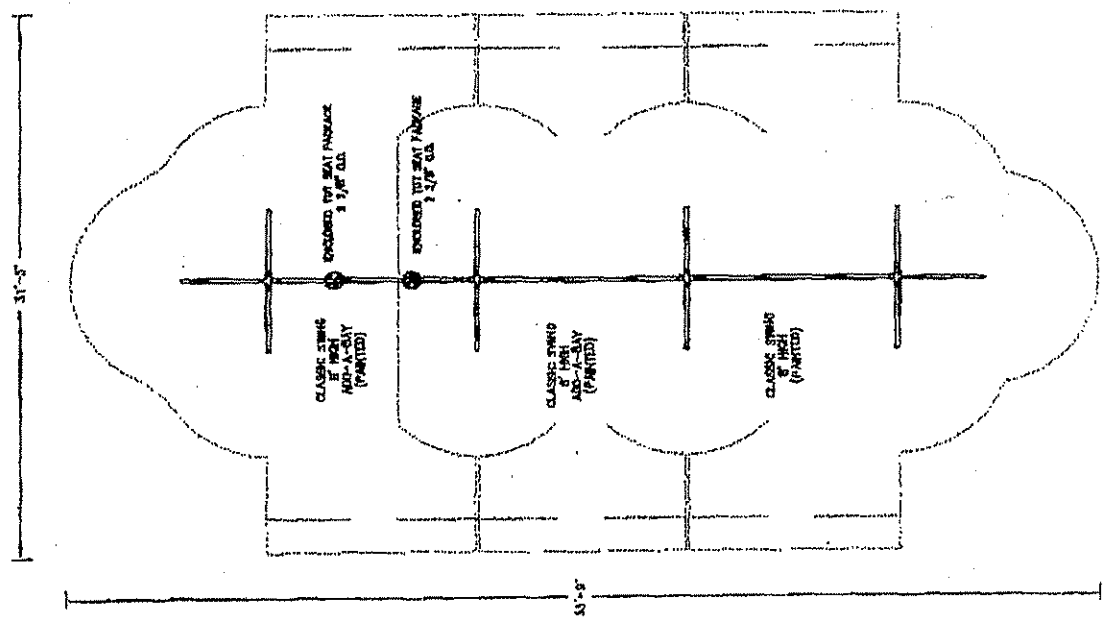

(Spruce Creek Camp Ground Area)

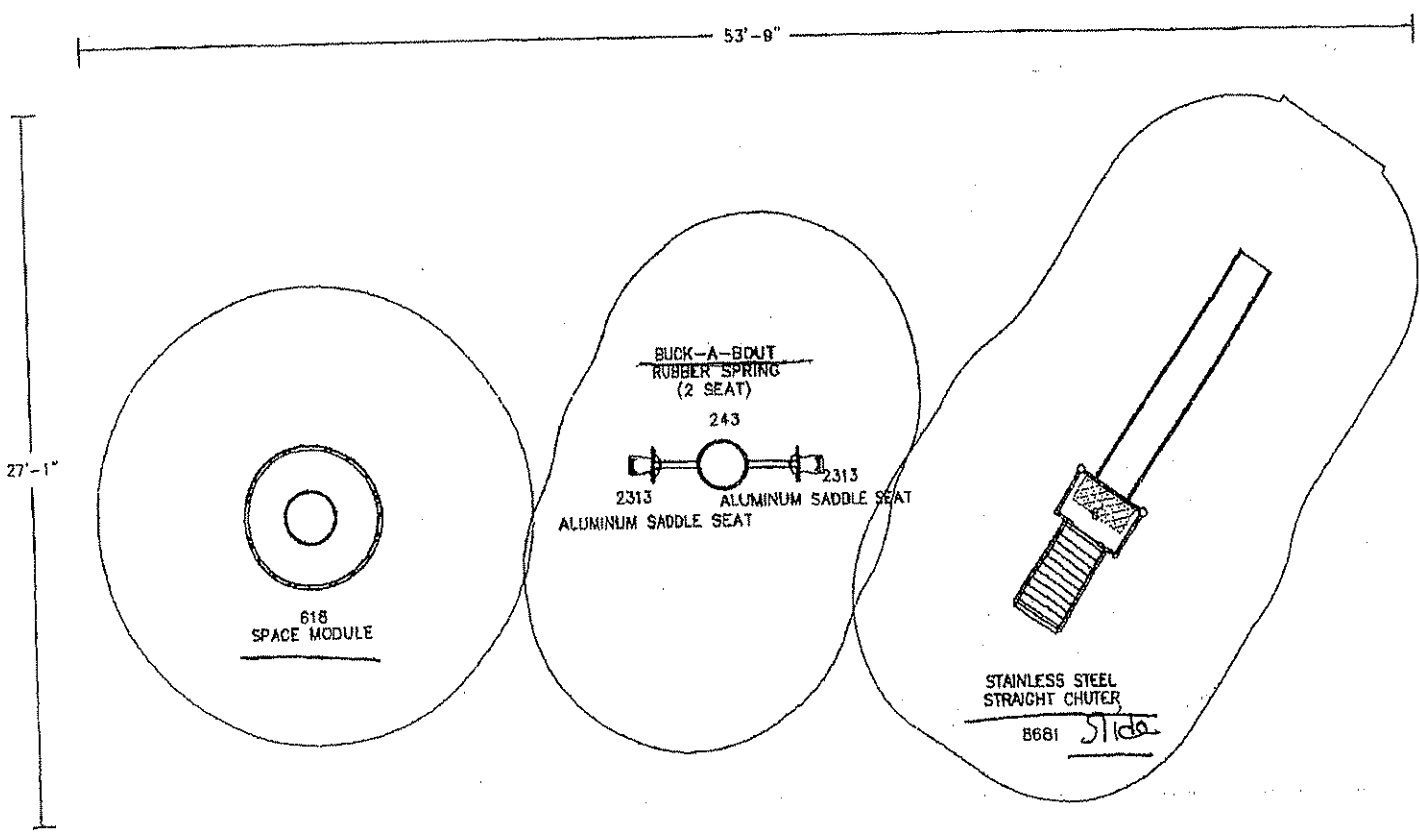

LOWER WALNUT PICNIC AREA

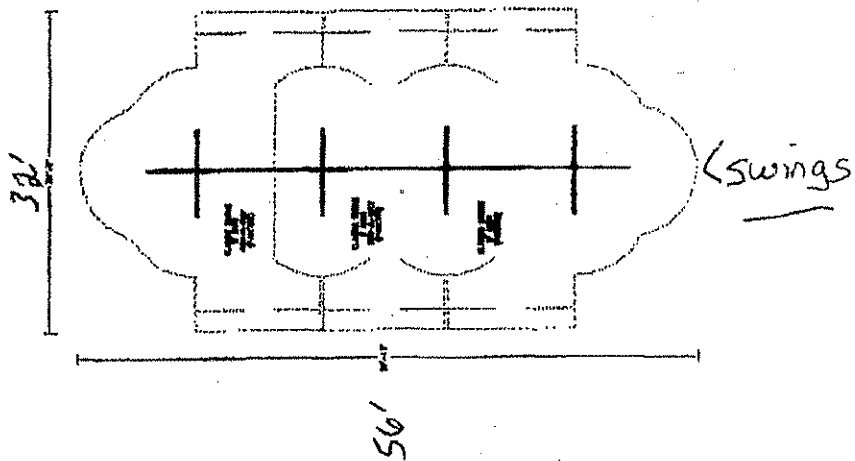
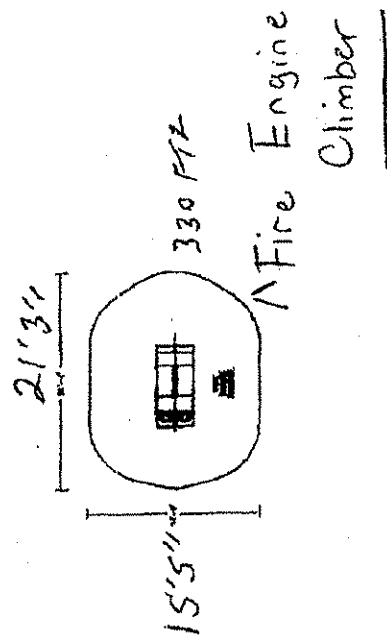
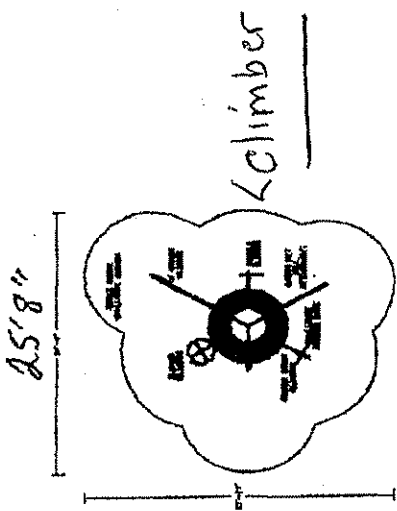
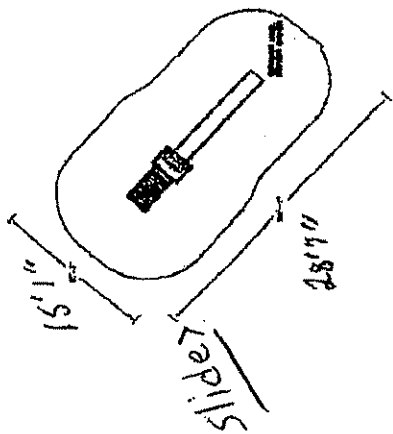

(Long Branch Picnic Area)

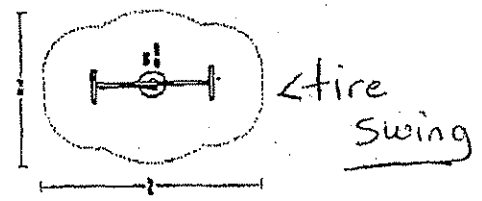
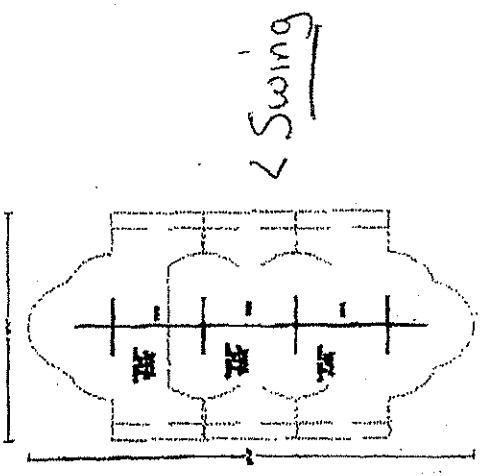
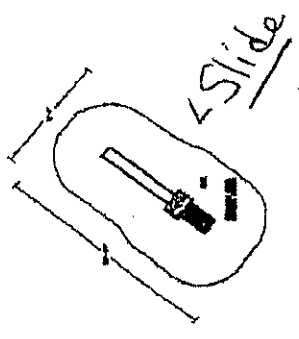
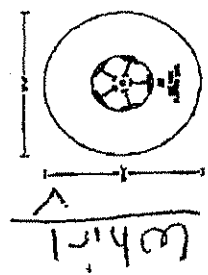

(Crum / Morgan Picnic Shelter Area)

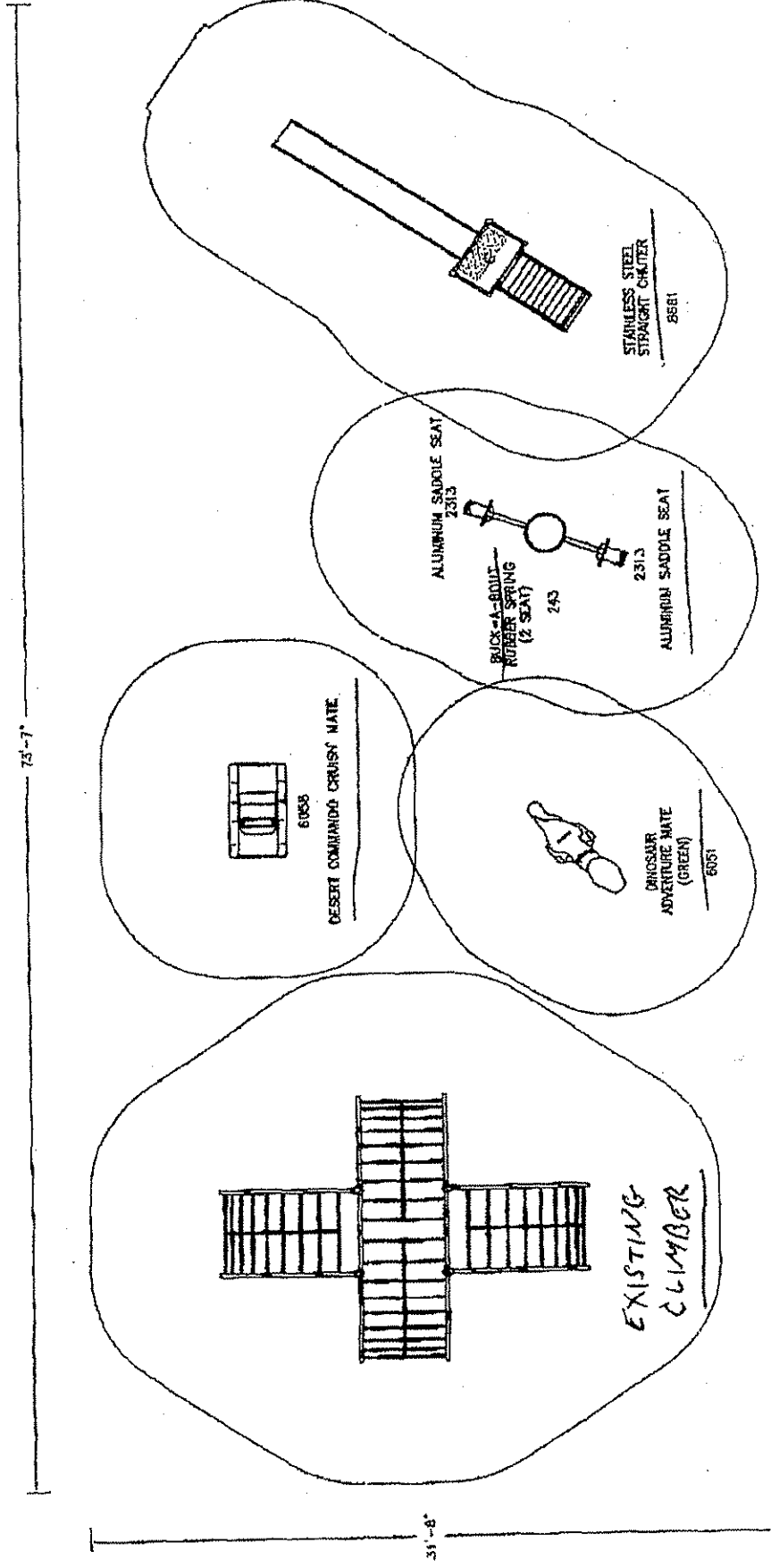

Tire Swing
27'-0"

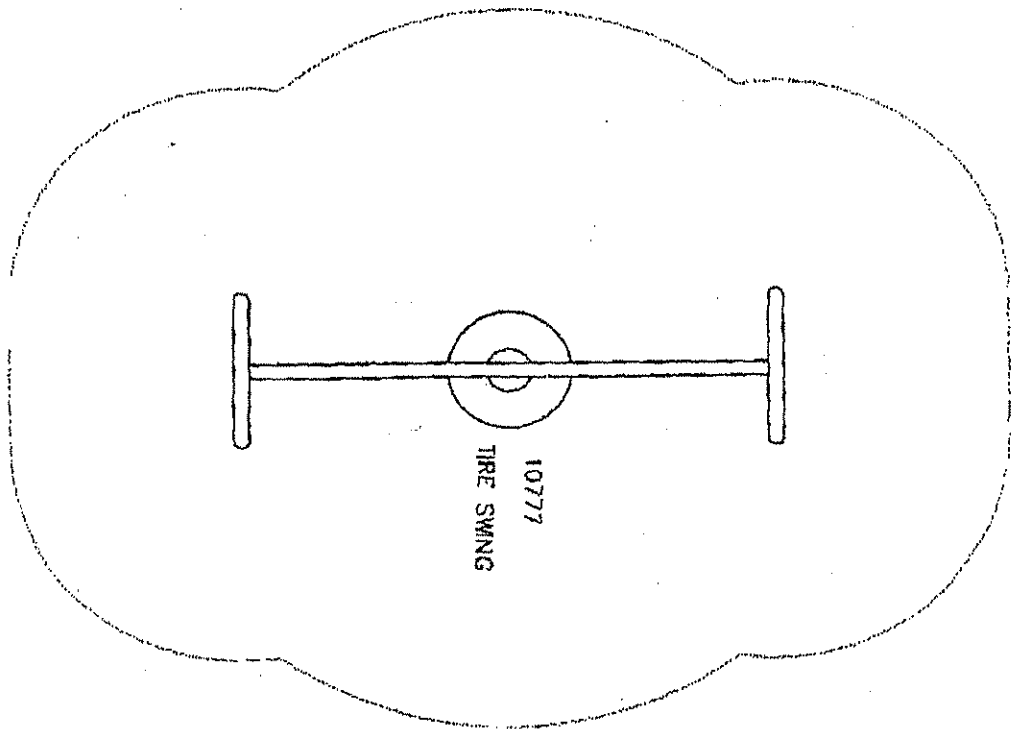

Whirl

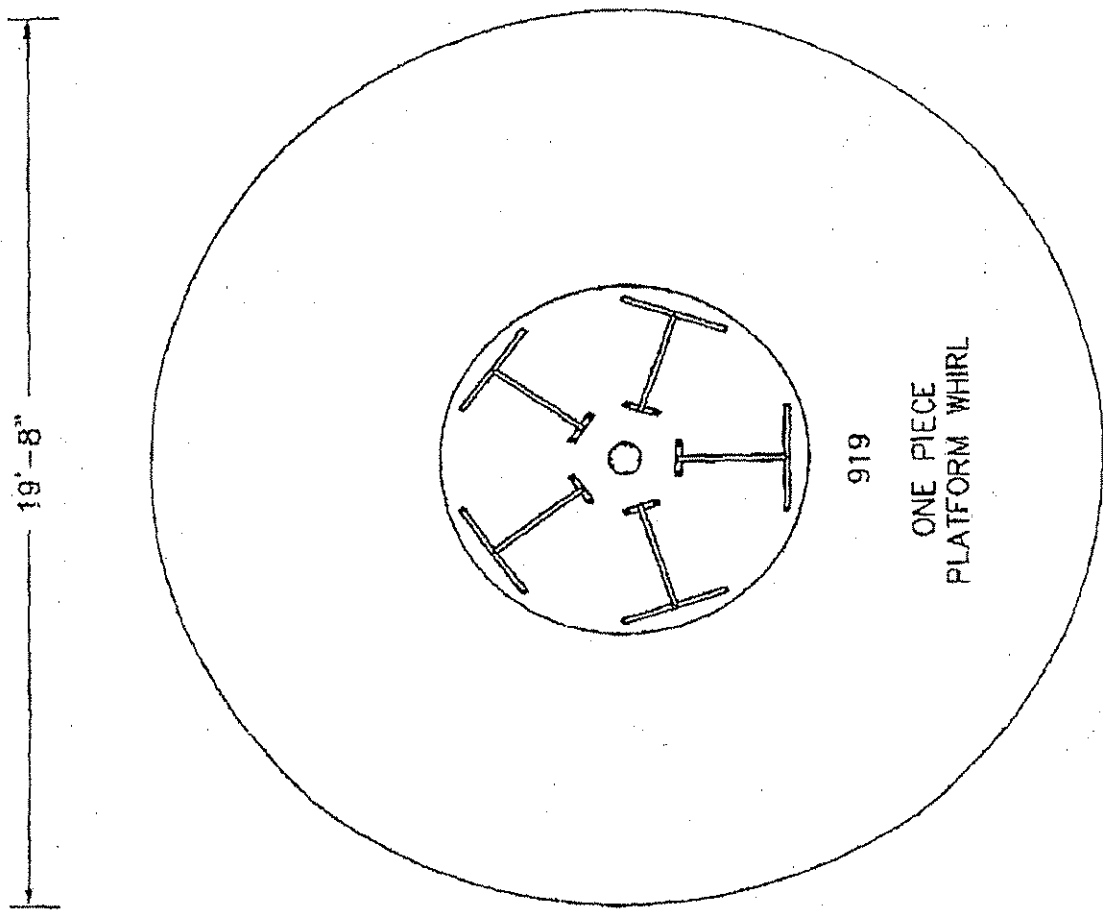

19'-8"

19'-8"

919

ONE PIECE
PLATFORM WHIRL

Slide

15'-4"

28'-7"

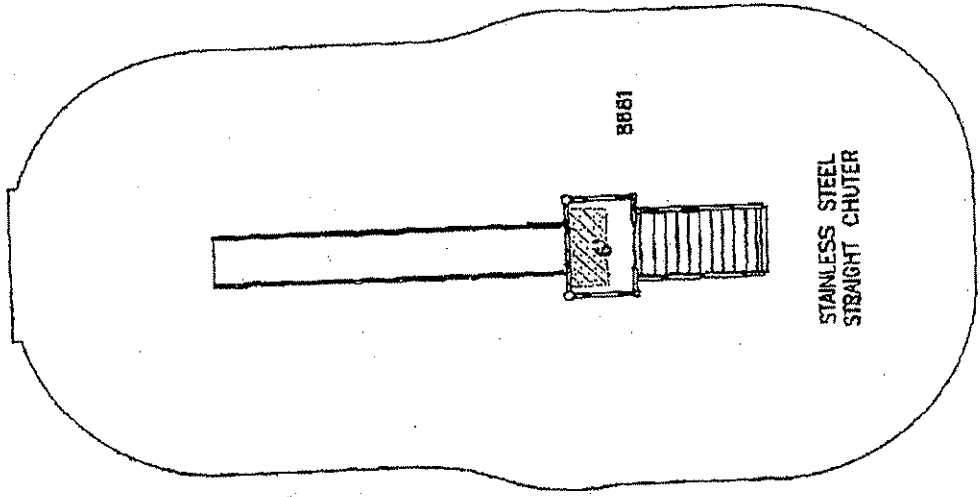

8881

STAINLESS STEEL
STRAIGHT CHUTER

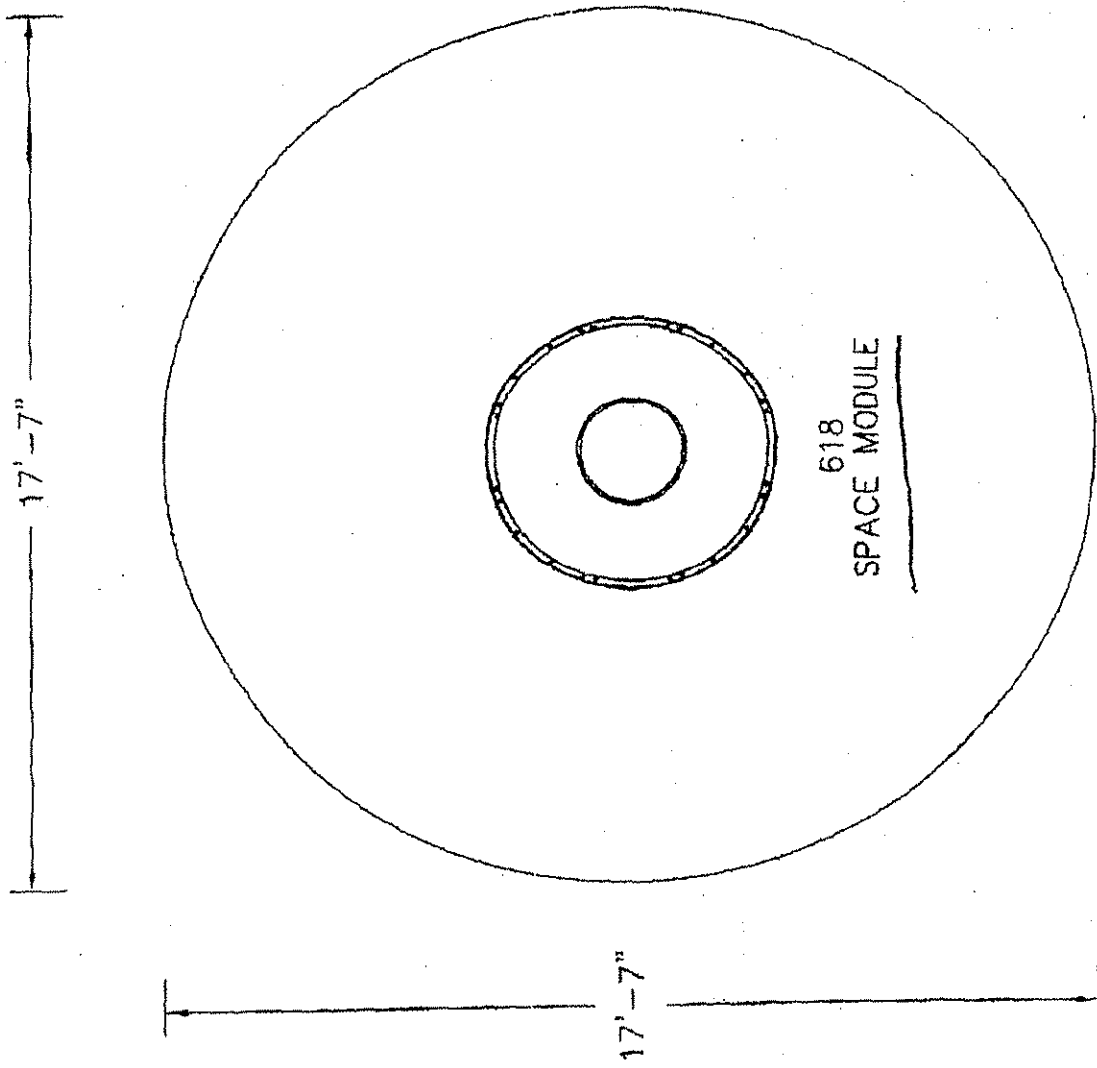

618
SPACE MODULE

State of West Virginia
VENDOR PREFERENCE CERTIFICATE

Certification and application* is hereby made for Preference in accordance with *West Virginia Code*, §5A-3-37. (Does not apply to construction contracts). *West Virginia Code*, §5A-3-37, provides an opportunity for qualifying vendors to request (at the time of bid) preference for their residency status. Such preference is an evaluation method only and will be applied only to the cost bid in accordance with the *West Virginia Code*. This certificate for application is to be used to request such preference. The Purchasing Division will make the determination of the Resident Vendor Preference, if applicable.

1. Application is made for 2.5% resident vendor preference for the reason checked:

- Bidder is an individual resident vendor and has resided continuously in West Virginia for four (4) years immediately preceding the date of this certification; **or**,
- Bidder is a partnership, association or corporation resident vendor and has maintained its headquarters or principal place of business continuously in West Virginia for four (4) years immediately preceding the date of this certification; or 80% of the ownership interest of Bidder is held by another individual, partnership, association or corporation resident vendor who has maintained its headquarters or principal place of business continuously in West Virginia for four (4) years immediately preceding the date of this certification; **or**,
- Bidder is a nonresident vendor which has an affiliate or subsidiary which employs a minimum of one hundred state residents and which has maintained its headquarters or principal place of business within West Virginia continuously for the four (4) years immediately preceding the date of this certification; **or**,

2. Application is made for 2.5% resident vendor preference for the reason checked:

- Bidder is a resident vendor who certifies that, during the life of the contract, on average at least 75% of the employees working on the project being bid are residents of West Virginia who have resided in the state continuously for the two years immediately preceding submission of this bid; **or**,

3. Application is made for 2.5% resident vendor preference for the reason checked:

- Bidder is a nonresident vendor employing a minimum of one hundred state residents or is a nonresident vendor with an affiliate or subsidiary which maintains its headquarters or principal place of business within West Virginia employing a minimum of one hundred state residents who certifies that, during the life of the contract, on average at least 75% of the employees or Bidder's affiliate's or subsidiary's employees are residents of West Virginia who have resided in the state continuously for the two years immediately preceding submission of this bid; **or**,

4. Application is made for 5% resident vendor preference for the reason checked:

- Bidder meets either the requirement of both subdivisions (1) and (2) or subdivision (1) and (3) as stated above; **or**,

5. Application is made for 3.5% resident vendor preference who is a veteran for the reason checked:

- Bidder is an individual resident vendor who is a veteran of the United States armed forces, the reserves or the National Guard and has resided in West Virginia continuously for the four years immediately preceding the date on which the bid is submitted; **or**,

6. Application is made for 3.5% resident vendor preference who is a veteran for the reason checked:

- Bidder is a resident vendor who is a veteran of the United States armed forces, the reserves or the National Guard, if, for purposes of producing or distributing the commodities or completing the project which is the subject of the vendor's bid and continuously over the entire term of the project, on average at least seventy-five percent of the vendor's employees are residents of West Virginia who have resided in the state continuously for the two immediately preceding years.

Bidder understands if the Secretary of Revenue determines that a Bidder receiving preference has failed to continue to meet the requirements for such preference, the Secretary may order the Director of Purchasing to: (a) reject the bid; or (b) assess a penalty against such Bidder in an amount not to exceed 5% of the bid amount and that such penalty will be paid to the contracting agency or deducted from any unpaid balance on the contract or purchase order.

By submission of this certificate, Bidder agrees to disclose any reasonably requested information to the Purchasing Division and authorizes the Department of Revenue to disclose to the Director of Purchasing appropriate information verifying that Bidder has paid the required business taxes, provided that such information does not contain the amounts of taxes paid nor any other information deemed by the Tax Commissioner to be confidential.

Under penalty of law for false swearing (West Virginia Code, §61-5-3), Bidder hereby certifies that this certificate is true and accurate in all respects; and that if a contract is issued to Bidder and if anything contained within this certificate changes during the term of the contract, Bidder will notify the Purchasing Division in writing immediately.

Bidder: SERVICE SUPPLY LTD., INC.

Signed: _____

JERRY GROVES

Date: MAY 29, 2009

Title: _____

VICE PRESIDENT

*Check any combination of preference consideration(s) indicated above, which you are entitled to receive.

STATE OF WEST VIRGINIA
Purchasing Division

PURCHASING AFFIDAVIT

VENDOR OWING A DEBT TO THE STATE:

West Virginia Code §5A-3-10a provides that: No contract or renewal of any contract may be awarded by the state or any of its political subdivisions to any vendor or prospective vendor when the vendor or prospective vendor or a related party to the vendor or prospective vendor is a debtor and the debt owed is an amount greater than one thousand dollars in the aggregate.

PUBLIC IMPROVEMENT CONTRACTS & DRUG-FREE WORKPLACE ACT:

If this is a solicitation for a public improvement construction contract, the vendor, by its signature below, affirms that it has a written plan for a drug-free workplace policy in compliance with Article 1D, Chapter 21 of the **West Virginia Code**. The vendor **must** make said affirmation with its bid submission. Further, public improvement construction contract may not be awarded to a vendor who does not have a written plan for a drug-free workplace policy in compliance with Article 1D, Chapter 21 of the **West Virginia Code** and who has not submitted that plan to the appropriate contracting authority in timely fashion. For a vendor who is a subcontractor, compliance with Section 5, Article 1D, Chapter 21 of the **West Virginia Code** may take place before their work on the public improvement is begun.

ANTITRUST:

In submitting a bid to any agency for the state of West Virginia, the bidder offers and agrees that if the bid is accepted the bidder will convey, sell, assign or transfer to the state of West Virginia all rights, title and interest in and to all causes of action it may now or hereafter acquire under the antitrust laws of the United States and the state of West Virginia for price fixing and/or unreasonable restraints of trade relating to the particular commodities or services purchased or acquired by the state of West Virginia. Such assignment shall be made and become effective at the time the purchasing agency tenders the initial payment to the bidder.

I certify that this bid is made without prior understanding, agreement, or connection with any corporation, firm, limited liability company, partnership or person or entity submitting a bid for the same materials, supplies, equipment or services and is in all respects fair and without collusion or fraud. I further certify that I am authorized to sign the certification on behalf of the bidder or this bid.

LICENSING:

Vendors must be licensed and in good standing in accordance with any and all state and local laws and requirements by any state or local agency of West Virginia, including, but not limited to, the West Virginia Secretary of State's Office, the West Virginia Tax Department, West Virginia Insurance Commission, or any other state agencies or political subdivision. Furthermore, the vendor must provide all necessary releases to obtain information to enable the Director or spending unit to verify that the vendor is licensed and in good standing with the above entities.

CONFIDENTIALITY:

The vendor agrees that he or she will not disclose to anyone, directly or indirectly, any such personally identifiable information or other confidential information gained from the agency, unless the individual who is the subject of the information consents to the disclosure in writing or the disclosure is made pursuant to the agency's policies, procedures and rules. Vendor further agrees to comply with the Confidentiality Policies and Information Security Accountability Requirements, set forth in <http://www.state.wv.us/admin/purchase/privacy/noticeConfidentiality.pdf>.

Under penalty of law for false swearing (**West Virginia Code §61-5-3**), it is hereby certified that the vendor affirms and acknowledges the information in this affidavit and is in compliance with the requirements as stated.

Vendor's Name: SERVICE SUPPLY LTD., INC.

Authorized Signature:  Date: MAY 29, 2009

Purchasing Affidavit (Revised 01/01/09) JERRY GROVES, VICE PRESIDENT



State of West Virginia
 Department of Administration
 Purchasing Division
 2019 Washington Street East
 Post Office Box 50130
 Charleston, WV 25305-0130

WV PURCHASING ACA SECT Fax 304-558-4115
Request for Quotation

May 5 2009 11:46am P001/001

RFQ NUMBER
 DNR209114

PAGE
 1

ADDRESS CORRESPONDENCE TO ATTENTION OF
 FRANK WHITTAKER
 304-558-2316

RFQ COPY
 TYPE NAME/ADDRESS HERE

DIVISION OF NATURAL RESOURCES
 CABWAYLINGO STATE FOREST
 ATTN: PARK SUPERINTENDENT
 ROUTE 1, BOX 85
 DUNLOW, WV
 25511 385-4255

DATE PRINTED	TERMS OF SALE	SHIP VIA	FOB	FREIGHT TERMS
05/05/2009				

BID OPENING DATE: 06/03/2009 BID OPENING TIME 01:30PM

LINE	QUANTITY	UOP	CAT NO	ITEM NUMBER	UNIT PRICE	AMOUNT
***** ADDENDUM NO.1 *****						
THIS ADDENDUM IS ISSUED TO MAKE THE FOLLOWING CHANGES.						
MANDATORY PRE-BID MEETING DATE AND TIME: CHANGED FROM 05/06/09 TO 05/13/09 @ 10:00 AM AT THE PARK HEADQUARTERS.						
TECHNICAL QUESTIONS DEADLINE CHANGED TO 05/15/09 @ 3:00						
BID OPENING CHANGED FROM 05/26/09 TO 06/03/09 @ 1:30 P						
0001	1	LS		650-38		
PLAYGROUND EQUIPMENT (NOT OTHERWISE CLASSIFIED)						
***** THIS IS THE END OF RFQ DNR209114 ***** TOTAL:						

SEE REVERSE SIDE FOR TERMS AND CONDITIONS

SIGNATURE: *Tracy Lane* TELEPHONE: 1-800-848-7556 DATE: 5/29/09

TITLE: VICE PRESIDENT FEIN: ADDRESS CHANGES TO BE NOTED ABOVE

WHEN RESPONDING TO RFQ, INSERT NAME AND ADDRESS IN SPACE ABOVE LABELED 'VENDOR'



February 2, 2009

To Whom It May Concern:

Landscape Structures Inc. has been actively involved in the development of safety standards for public playground equipment for more than 15 years. We are also a charter member of the International Play Equipment Manufacturers Association (IPEMA).

All products covered under the scope of the Standard in our 2009 Park and Playground Equipment catalog have been tested/certified and validated by an independent third party to be in compliance with the requirements of the ASTM (American Society for Testing and Materials) F1487 Safety Standard according to procedures set forth by the IPEMA, except where listed. A listing of all certified products can be seen at www.ipema.org. This listing will also show that all products except where noted, are certified to the CAN/CSA Z614-07 Children's Playspaces and Equipment published in March 2007 by the Canadian Standards Association (CSA).

To the best of our knowledge, we also conform to the U.S. Consumer Products Safety Commission's (CPSC) Handbook for Public Playground Safety published in 1998.

The company achieved ISO 9001:2000 certification in March 2003 and the ISO 14001 environmental standard in September 1998. The pursuit of ISO certification helped Landscape Structures establish its quality management systems and establish the infrastructure for continued growth.

If you have any questions, please contact the undersigned.

Sincerely,

Landscape Structures Inc.

Randy Watermill
Director of Product Development

Subscribed and sworn before me on this 2nd day of February, 2009.

Notary Public

2/2/09
Date

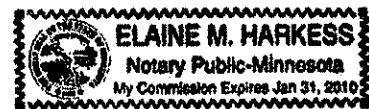

(Notary Stamp)



2009 Play Equipment Warranty

You have our word.

100-Year Limited Warranty for all stainless steel fasteners, aluminum posts, clamps, beams and caps, against structural failure due to corrosion/natural deterioration or manufacturing defects. This warranty does not include any cosmetic issues or wear and tear from normal use.

15-Year Limited Warranty for all plastic and steel components, including TuffTimbers™ against structural failure due to corrosion/natural deterioration or manufacturing defects. TenderTuff™-coating against structural failure due to natural deterioration or manufacturing defects. (Except Wiggle Ladders, Chain Ladders and Swing Chain). TuffTur® against material or manufacturing defects when properly installed. Corocord® cable on Spacenet™ climbers against breakage.

10-Year Limited Warranty for all CoolToppers™ structural steel frames and Mobius climbers™ against structural failure due to natural deterioration or manufacturing defects.

5-Year Limited Warranty for Corocord cables on Spacenet climbers and CoolToppers® fabric against natural deterioration or manufacturing defects. This warranty is limited to the design loads as stated in the specifications found in the technical information. The Natural Elements™ climbers exterior GFRC material, against structural failure due to natural deterioration or manufacturing defects.

3-Year Limited Warranty for all other parts, ie: CableCore™ products, Swing seats and hangers, Mobius climber handholds, Wiggle Ladders, Chain Ladders and Swing Chain, Track Ride trolleys and bumpers, all rocking equipment including Sway Fun™, PVC belting material, HealthBeat™ hydraulic cylinders, Seesaws, Wiggle Ring Bridge, etc. against failure due to corrosion, natural deterioration or manufacturing defects.

This warranty does not include any cosmetic issues or wear and tear from normal use.

Landscape Structures Inc. warrants that all playstructures and/or equipment sold will conform in kind and in quality to the specifications manual for the products identified in the Acknowledgment of Order and will be free of defects in manufacturing and material. Seller further warrants:

All the warranties commence on date of Seller's invoice. Should any failure to conform to the above express warranties appear within the applicable warranty period, Seller shall, upon being notified in writing promptly after discovery of the defect and within the applicable warranty period, correct such nonconformity either by repairing any defective part or parts, or by making available a replacement part within 60 days of written notification. Seller shall deliver the repaired or replacement part or parts to the site free of charge, but will not be responsible for providing labor or the cost of labor for the removal of the defective part or parts and the installation of any replacement part or parts. Replacement parts will be warranted for the balance of the original warranty.

THIS WARRANTY IS EXCLUSIVE AND IN LIEU OF ALL OTHER WARRANTIES, WHETHER EXPRESS OR IMPLIED, INCLUDING BUT NOT LIMITED TO ANY WARRANTY OF MERCHANTABILITY OR OF FITNESS FOR A PARTICULAR PURPOSE.

The remedies hereby provided shall be the exclusive and sole remedies of the purchaser. Seller shall not be liable for any direct, indirect, special, incidental or consequential damages.

Seller neither assumes nor authorizes any employee, representative or any other person to assume for Seller any other liability in connection with the sale or use of the structures sold, and there are no oral agreements or warranties collateral to or affecting this agreement. The warranty stated above is valid only if the structures and or equipment are erected in conformance with Landscape Structures' installation instructions and maintained according to the maintenance procedures furnished by Landscape Structures Inc.; have been subjected to normal use for the purpose for which the goods were designed; have not been subject to misuse, negligence, vandalism, or accident; have not been subjected to addition or substitution of parts; and have not been modified, altered, or repaired by persons other than Seller or Seller's designees in any respect which, in the judgement of Seller, affects the condition or operation of the structures. To make a claim, send your written statement of claim, along with the original job number or invoice number to: Landscape Structures Inc. 601 7th Street South, Delano, Minnesota, 55328-8605

Signed:

Chairman

Date: 01/01/09



2009 Terms of Sale

PRICING: Prices in the Landscape Structures price list do not include delivery and handling charges. Prices are subject to change without notice.

TERMS: To tax-supported institutions and those with established credit: Net 30 days from the date of the invoice. 1.5% per month thereafter, freight charges are prepaid and applied to the invoice. Taxes: Prices listed in the Landscape Structures price list do not include applicable taxes, if any.

WEIGHTS: Weights shown in the catalog and price list are approximate, and may vary. Delivery: If delivery of the equipment is by common carrier, should there be damage or a shortage, notify the carrier at once and sign delivery documents provided by the carrier noting the damage or shortage. Most products are delivered on large pallets and will require a forklift or similar equipment to unload as a unit on the site. If this is not possible, the units can be unpacked in the truck.

INSTALLATION: All Playstructures and/or equipment are delivered unassembled and packaged with recyclable materials. For a list of Factory Certified Installers in your area, please contact your Landscape Structures Representative.

SERVICE: We have knowledgeable, qualified sales consultants throughout the world. Our Representatives are available to help you before, during and after the sale. Landscape Structures Inc. has exclusive design software that features all of our parts and

pieces in pull-down menus. With this, your Sales Representative can design a playground layout that meets not only your needs, but ASTM and CPSC standards. In addition, we have a full staff of NPSI-certified designers along with 2D and 3D drawing capabilities to assist you with your playground plans. Please contact us at 601 Seventh Street South, Delano, Minnesota 55328 or call 1-800-328-0035 inside the USA or 1-763-972-3391 outside the USA, for your sales representative or visit our web site at playlsi.com

RETURN POLICY: As an indication of our commitment to our customers, Landscape Structures will accept returns of new structures and/or new equipment purchased within 60 days of the original invoice date. Advance notification is necessary to assure proper credit. Parts not included in this return policy are custom parts, (including PlayShaper® posts) as well as used or damaged parts. A 20% restock fee plus all freight charges will apply to all product returns. Note: All parts are subject to inspection upon return. Parts returned damaged may not receive a full credit. For this reason, it is important that all returned parts are properly packaged to prevent damages while in transit.

PRODUCT CHANGES: Because of our commitment to safety, innovation, and value, we reserve the right to change specifications at any time.

CONTRACTOR LICENSE

Authorized by the

West Virginia Contractor Licensing Board

Number:

WV013333

Classification:

SPECIALTY

SERVICE SUPPLY LTD INC
DBA SERVICE SUPPLY LTD INC
1524 S HAMILTON RD
COLUMBUS, OH 43227-2493

Date Issued

Expiration Date

JANUARY 24, 2009

JANUARY 24, 2010

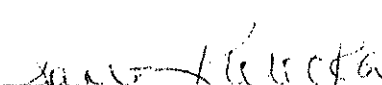
Authorized Company Signature

Chair, West Virginia Contractor
Licensing Board

WEST VIRGINIA
CONTRACTOR
LICENSING
BOARD

This license, or a copy thereof, must be posted in a conspicuous place at every construction site where work is being performed. This license number must appear in all advertisements, on all bid submissions and on all fully executed and binding contracts. This license cannot be assigned or transferred by licensee. Issued under provisions of West Virginia Code, Chapter 21, Article 11.



**WORKERS COMPENSATION
AND
EMPLOYERS LIABILITY POLICY**

INFORMATION PAGE WC 00 00 01 (A)

RENEWAL OF POLICY NUMBER: WC10102907-04
POLICY NUMBER: WC10102907-05

INSURER: BRICKSTREET MUTUAL INSURANCE COMPANY

- 1. **INSURED:**
SERVICE SUPPLY LTD INC
1524 SOUTH HAMILTON ROAD
COLUMBUS, OH 43227
- PRODUCER:**
BRICKSTREET MUTUAL INSURANCE
COMPANY
400 QUARRIER STREET
CHARLESTON, WV 25301-2010

Insured is a(n) CORPORATION

Other work places and identification numbers are shown in the schedule(s) attached.

- 2. The policy period is from 11/30/2008 to 11/30/2009 12:01 A.M. at the insured's mailing address.
- 3. **A. WORKERS COMPENSATION INSURANCE:** Part One of the policy applies to the Workers Compensation Law of the state(s) listed here:

WEST VIRGINIA
- B. EMPLOYERS LIABILITY INSURANCE:** Part Two of the policy applies to work in each state listed in item 3.A. The limits of our liability under Part Two are:

Bodily Injury by Accident:	\$100,000	Each Accident
Bodily Injury by Disease:	\$500,000	Policy Limit
Bodily Injury by Disease:	\$100,000	Each Employee
- C. OTHER STATES INSURANCE:** Part Three of the policy applies to the states, if any, listed here:

See West Virginia Limited Other States Insurance Endorsement WC 99 03 05
- D.** This policy includes these endorsements and schedules:

SEE LIST OF ENDORSEMENTS - EXTENSION OF INFORMATION PAGE
- 4. The premium for this policy will be determined by our Manuals of Rules, Classifications, Rates and Rating Plans. All required information is subject to verification and change by audit to be made in accordance with Part Five of the Policy.

DATE OF ISSUE: 12/29/2008
ISSUING OFFICE: Charleston, WV
PRODUCER: BRICKSTREET MUTUAL INSURANCE COMPANY



**Bureau of Workers'
Compensation**

30 W. Spring St.
Columbus, OH 43215

Certificate of Premium Payment

This certifies the employer listed below has paid into the Ohio State Insurance Fund as required by law. Therefore, the employer is entitled to the rights and benefits of the fund for the period specified. For more information, call 1-800-OHIOBWC.

This certificate must be conspicuously posted.

Policy No. and Employer

Period Specified Below

406937

01/01/2009 Thru 08/31/2009

SERVICE SUPPLY LTD., INC.
1524 S HAMILTON RD
COLUMBUS, OH 43227-2429



ohiobwc.com

Marsha P. Repp
Administrator

You can reproduce this certificate as needed.

Ohio Bureau of Workers' Compensation

Required Posting

Effective Oct. 13, 2004, Section 4123.54 of the Ohio Revised Code requires notice of rebuttable presumption. Rebuttable presumption means an employee may dispute or prove untrue the presumption (or belief) that alcohol or a controlled substance not prescribed by the employee's physician is the proximate cause (main reason) of the work-related injury.

The burden of proof is on the employee to prove the presence of alcohol or a controlled substance was not the proximate cause of the work-related injury. An employee who tests positive or refuses to submit to chemical testing may be disqualified for compensation and benefits under the Workers' Compensation Act.



**Bureau of Workers'
Compensation**

You must post this language with the certificate of premium payment.



Ohio Bureau of Workers' Compensation

Governor, Ted Strickland
Administrator/CEO Marsha P. Ryan

Focus on
Ohio Employers

log on

[?](#) help [print](#) [search](#) [glossary](#) [cc](#)

- Accident/Injury Info »
- Claim Info »
- Claim Payment »
- Claim Reference Info »
- Coverage look-up
- Employer Services »
- Quick Pay
- Safety Services »
- Self-Insured »
- Forms
- Section Map

Live support available
Monday through Friday
7:30 a.m. - 5:30 p.m.
[Click here to get help!](#)

Service: State construction contractor search results

Policy number: 406937-0
 Company name: SERVICE SUPPLY LTD., INC.
 Construction contractor status: APPROVED
 Construction contractor status date: 5/4/2007 12:00:00 AM

[search again](#)

Note: BWC has designed this database for those responsible for ensuring that a construction subcontractor has a drug-free program that complies with the governor's executive order requiring a drug-free workplace. A contractor or subcontractor in an APPROVED status has agreed to implement a drug-free workplace program which makes the company compliant with the governor's executive order. Therefore, you can print this page for your records.

Click the Help tab in the upper-right hand corner for more status definitions.



ACORD™ CERTIFICATE OF LIABILITY INSURANCE

DATE (MM/DD/YYYY)
12/10/2008

PRODUCER Phone: 6168783351
The Campbell Group
PO Box 1788
Grand Rapids MI 49501

Fax: 8008473129
SERVICE SUPPLY LTD.

THIS CERTIFICATE IS ISSUED AS A MATTER OF INFORMATION ONLY AND CONFERS NO RIGHTS UPON THE CERTIFICATE HOLDER. THIS CERTIFICATE DOES NOT AMEND, EXTEND OR ALTER THE COVERAGE AFFORDED BY THE POLICIES BELOW.

INSURED
Service Supply Ltd Inc
1524 S Hamilton Road
Columbus OH 43227

IN BUSINESS FOR FUN AND SAFETY

INSURERS AFFORDING COVERAGE	NAIC #
INSURER A: Continental Casualty Co	
INSURER B: American Casualty Co of Reading	
INSURER C:	
INSURER D:	
INSURER E:	

COVERAGES

THE POLICIES OF INSURANCE LISTED BELOW HAVE BEEN ISSUED TO THE INSURED NAMED ABOVE FOR THE POLICY PERIOD INDICATED. NOTWITHSTANDING ANY REQUIREMENT, TERM OR CONDITION OF ANY CONTRACT OR OTHER DOCUMENT WITH RESPECT TO WHICH THIS CERTIFICATE MAY BE ISSUED OR MAY PERTAIN, THE INSURANCE AFFORDED BY THE POLICIES DESCRIBED HEREIN IS SUBJECT TO ALL THE TERMS, EXCLUSIONS AND CONDITIONS OF SUCH POLICIES. AGGREGATE LIMITS SHOWN MAY HAVE BEEN REDUCED BY PAID CLAIMS.

INSR ADD'L LTR	INSRD	TYPE OF INSURANCE	POLICY NUMBER	POLICY EFFECTIVE DATE (MM/DD/YY)	POLICY EXPIRATION DATE (MM/DD/YY)	LIMITS
B		GENERAL LIABILITY <input checked="" type="checkbox"/> COMMERCIAL GENERAL LIABILITY <input type="checkbox"/> CLAIMS MADE <input checked="" type="checkbox"/> OCCUR GEN'L AGGREGATE LIMIT APPLIES PER: <input type="checkbox"/> POLICY <input checked="" type="checkbox"/> PROJECT <input type="checkbox"/> LOC	2088184534	12/10/2008	12/10/2009	EACH OCCURRENCE \$ 1,000,000 DAMAGE TO RENTED PREMISES (Ea occurrence) \$ 100,000 MED EXP (Any one person) \$ 5,000 PERSONAL & ADV INJURY \$ 1,000,000 GENERAL AGGREGATE \$ 2,000,000 PRODUCTS - COMP/OP AGG \$ 2,000,000
A		AUTOMOBILE LIABILITY <input checked="" type="checkbox"/> ANY AUTO <input type="checkbox"/> ALL OWNED AUTOS <input type="checkbox"/> SCHEDULED AUTOS <input checked="" type="checkbox"/> HIRED AUTOS <input checked="" type="checkbox"/> NON-OWNED AUTOS	2088184498	12/10/2008	12/10/2009	COMBINED SINGLE LIMIT (Ea accident) \$ 1,000,000 BODILY INJURY (Per person) \$ BODILY INJURY (Per accident) \$ PROPERTY DAMAGE (Per accident) \$ AUTO ONLY - EA ACCIDENT \$ OTHER THAN AUTO ONLY: EA ACC \$ AGG \$
		GARAGE LIABILITY <input type="checkbox"/> ANY AUTO				AUTO ONLY - EA ACCIDENT \$ OTHER THAN AUTO ONLY: EA ACC \$ AGG \$
A		EXCESS/UMBRELLA LIABILITY <input checked="" type="checkbox"/> OCCUR <input type="checkbox"/> CLAIMS MADE <input type="checkbox"/> DEDUCTIBLE <input checked="" type="checkbox"/> RETENTION \$ 10,000	2088184453	12/10/2008	12/10/2009	EACH OCCURRENCE \$ 2,000,000 AGGREGATE \$ 2,000,000 \$ \$ \$
		WORKERS COMPENSATION AND EMPLOYERS' LIABILITY ANY PROPRIETOR/PARTNER/EXECUTIVE OFFICER/MEMBER EXCLUDED? If yes, describe under SPECIAL PROVISIONS below				WC STATUTORY LIMITS OTH-ER E.L. EACH ACCIDENT \$ E.L. DISEASE - EA EMPLOYEE \$ E.L. DISEASE - POLICY LIMIT \$
B		OTHER Installation Floater	2088184534	12/10/2008	12/10/2009	\$ 120,000

DESCRIPTION OF OPERATIONS / LOCATIONS / VEHICLES / EXCLUSIONS ADDED BY ENDORSEMENT / SPECIAL PROVISIONS

CERTIFICATE HOLDER

Service Supply Ltd Inc
1524 South Hamilton Road
Columbus OH 43227

CANCELLATION

SHOULD ANY OF THE ABOVE DESCRIBED POLICIES BE CANCELLED BEFORE THE EXPIRATION DATE THEREOF, THE ISSUING INSURER WILL ENDEAVOR TO MAIL 30 DAYS WRITTEN NOTICE TO THE CERTIFICATE HOLDER NAMED TO THE LEFT, BUT FAILURE TO DO SO SHALL IMPOSE NO OBLIGATION OR LIABILITY OF ANY KIND UPON THE INSURER, ITS AGENTS OR REPRESENTATIVES.

AUTHORIZED REPRESENTATIVE

Wanda Fitzpatrick

IMPORTANT

If the certificate holder is an **ADDITIONAL INSURED**, the policy(ies) must be endorsed. A statement on this certificate does not confer rights to the certificate holder in lieu of such endorsement(s).

If **SUBROGATION IS WAIVED**, subject to the terms and conditions of the policy, certain policies may require an endorsement. A statement on this certificate does not confer rights to the certificate holder in lieu of such endorsement(s).

DISCLAIMER

The Certificate of Insurance on the reverse side of this form does not constitute a contract between the issuing insurer(s), authorized representative or producer, and the certificate holder, nor does it affirmatively or negatively amend, extend or alter the coverage afforded by the policies listed thereon.

PRODUCER
Aon Risk Services Central, Inc.
fka Aon Risk Services, Inc. of Minnesota
8300 Norman Center Drive
Suite 1000
Minneapolis MN 55437 USA

PHONE: (952) 656-8000 FAX: (312) 381-0536

THIS CERTIFICATE IS ISSUED AS A MATTER OF INFORMATION ONLY AND CONFERS NO RIGHTS UPON THE CERTIFICATE HOLDER. THIS CERTIFICATE DOES NOT AMEND, EXTEND OR ALTER THE COVERAGE AFFORDED BY THE POLICIES BELOW.

INSURED
Landscape Structures, Inc.,
Basics, Inc., Skatewave, a
Division of Landscape Structures, Inc.
601 7th Street South
Delano MN 55328 USA

INSURERS AFFORDING COVERAGE		NAIC #
INSURER A:	ACE American Insurance Company	22667
INSURER B:	American International Specialty Lines	26883
INSURER C:		
INSURER D:		
INSURER E:		

COVERAGES SIR: May App IV

THE POLICIES OF INSURANCE LISTED BELOW HAVE BEEN ISSUED TO THE INSURED NAMED ABOVE FOR THE POLICY PERIOD INDICATED. NOTWITHSTANDING ANY REQUIREMENT, TERM OR CONDITION OF ANY CONTRACT OR OTHER DOCUMENT WITH RESPECT TO WHICH THIS CERTIFICATE MAY BE ISSUED OR MAY PERTAIN, THE INSURANCE AFFORDED BY THE POLICIES DESCRIBED HEREIN IS SUBJECT TO ALL THE TERMS, EXCLUSIONS AND CONDITIONS OF SUCH POLICIES. AGGREGATE LIMITS SHOWN MAY HAVE BEEN REDUCED BY PAID CLAIMS.

INSR LTR	ADD'L INSRD	TYPE OF INSURANCE	POLICY NUMBER	POLICY EFFECTIVE DATE (MM/DD/YYYY)	POLICY EXPIRATION DATE (MM/DD/YYYY)	LIMITS SHOWN ARE AS REQUESTED	
						LIMITS	
A		GENERAL LIABILITY <input checked="" type="checkbox"/> COMMERCIAL GENERAL LIABILITY CLAIMS MADE <input checked="" type="checkbox"/> OCCUR <input checked="" type="checkbox"/> BFPD Incl. <input checked="" type="checkbox"/> Bkt Contractual Incl GEN'L AGGREGATE LIMIT APPLIES PER: <input type="checkbox"/> POLICY <input checked="" type="checkbox"/> PRO-JECT <input type="checkbox"/> LOC	PMIG23860971 GL & Products Liability	06/01/08	06/01/09	EACH OCCURRENCE	\$2,000,000
						DAMAGE TO RENTED PREMISES (Ea occurrence)	\$50,000
						MED EXP (Any one person)	Excluded
						PERSONAL & ADV INJURY	\$2,000,000
						GENERAL AGGREGATE	\$4,000,000
						PRODUCTS - COMP/OP AGG	\$4,000,000
		AUTOMOBILE LIABILITY <input type="checkbox"/> ANY AUTO <input type="checkbox"/> ALL OWNED AUTOS <input type="checkbox"/> SCHEDULED AUTOS <input type="checkbox"/> HIRED AUTOS <input type="checkbox"/> NON OWNED AUTOS				COMBINED SINGLE LIMIT (Ea accident)	
						BODILY INJURY (Per person)	
						BODILY INJURY (Per accident)	
						PROPERTY DAMAGE (Per accident)	
		GARAGE LIABILITY <input type="checkbox"/> ANY AUTO				AUTO ONLY - EA ACCIDENT	
						OTHER THAN AUTO ONLY: EA ACC AGG	
B		EXCESS / UMBRELLA LIABILITY <input checked="" type="checkbox"/> OCCUR <input type="checkbox"/> CLAIMS MADE <input type="checkbox"/> DEDUCTIBLE <input type="checkbox"/> RETENTION \$10,000	BE1030126	06/01/08	06/01/09	EACH OCCURRENCE	\$5,000,000
						AGGREGATE	\$5,000,000
		WORKERS COMPENSATION AND EMPLOYERS' LIABILITY ANY PROPRIETOR / PARTNER / EXECUTIVE OFFICER/MEMBER EXCLUDED? If yes, describe under SPECIAL PROVISIONS below				WC STATUTORY LIMITS	OTHER
						E.L. EACH ACCIDENT	
						E.L. DISEASE-EA EMPLOYEE	
						E.L. DISEASE-POLICY LIMIT	
		OTHER					

DESCRIPTION OF OPERATIONS/LOCATIONS/VEHICLES/EXCLUSIONS ADDED BY ENDORSEMENT/SPECIAL PROVISIONS
Broad Form Vendors Endorsement

CERTIFICATE HOLDER
Service Supply Ltd., Inc.
1524 South Hamilton Road
Columbus OH 43227 USA

DECLARATION
SHOULD ANY OF THE ABOVE DESCRIBED POLICIES BE CANCELLED BEFORE THE EXPIRATION DATE THEREOF, THE ISSUING INSURER WILL ENDEAVOR TO MAIL 30 DAYS WRITTEN NOTICE TO THE CERTIFICATE HOLDER NAMED TO THE LEFT. BUT FAILURE TO DO SO SHALL IMPOSE NO OBLIGATION OR LIABILITY OF ANY KIND UPON THE INSURER, ITS AGENTS OR REPRESENTATIVES.

AUTHORIZED REPRESENTATIVE
Aon Risk Services Central, Inc.

Holder Identifier : 570028850357 Certificate No :

SERVICE SUPPLY LTD., INC.



1524 SOUTH HAMILTON ROAD - COLUMBUS, OHIO 43227 - TELEPHONE 614 / 861 - 3681
FAX 614/863-0113

June 1, 2005

Service Supply Ltd., Inc. - founded in 1959 in Columbus, Ohio. We originally had offices in the Bryson Building in Columbus, Ohio, and have been in our present facilities, 1524 South Hamilton Road, Columbus, Ohio since 1967.

Ralph Groves, my brother, founded Service Supply Ltd., Inc. and was president until his death in 1973.

Our employees at this time are:

Mary G. Groves (wife) President (1960)
Jerry Groves (son) Vice President (1969)
Janet Kletecka (daughter) Board of Directors (1974)
Alan Kletecka (son-in law) Sales Manager (1973)
Ben Groves (husband) Secretary-Treasurer (1961)
Donna Hetzner - Secretary (1999)
Linda Groves (daughter-in-law) Secretary (1977)
Linda Kroonemeyer - Secretary (1986)
Medrith Mollenkamp - Secretary (1988)
Connie Triplett - Secretary (2003)

We have five (5) sales persons located in various areas of Ohio, Indiana and West Virginia that are on straight commission basis. Some of these sales persons also offer other lines that are related to the same market that we service. This gives us a total of seven (7) sales persons on the road.

Service Supply Ltd., Inc. originally sold items pertaining to Traffic and Highway Safety such as paint stripers, traffic paint, signs, and sign posts We expanded into the park and recreation market and then into the school market which includes all grade 1-12 and colleges. We also call on the private sector where our site amenities, signs, and play structures are popular. Our early childcare play equipment is designed for institutional and corporate facilities that have become involved in day care centers.

A partial list of our suppliers and their principals, addresses, phone numbers, and products to follow:

- Landscape Structures, Inc., Barb and Steve King, Route #3, 601 7th Street, South, Delano, MN 55328
612-479-2546 PLAYGROUND EQUIPMENT
- Wabash Valley Manufacturing, Inc., Jerry Shilling, P. O. Box 5, Silver Lake, IN 46982
219-352-2102 SITE AMENITIES (expanded metal)
- DuMor, Inc., Steve Richard, P. O. Box 142, Mifflintown, PA 17059
717-436-2106 SITE AMENITIES (wood)
- American Aluminum Seating, Inc., Bob Palmer, P. O. Box 1468, Marshalltown, IA 50158
515-753-5366 PORTABLE BLEACHERS, STADIUM GRANDSTANDS
- Interkal LLC, Richard Patterson, P. O. Box 2107, Kalamazoo, MI 49003
616-349-1521 TELESCOPIC GYM BLEACHERS

We are listed in D&B; any late payments that may be listed on these reports are the result of problems in delivery of total order, which in turn holds up payment to the manufacturer. This would only appear if it were a very large order, which would involve telescopic bleachers.

Our bank, which we have been with since 1959, is National City Bank, Bexley Office, 2594 East Main Street, Bexley, OH 43209- phone 614-238-7100.

Our accountant is Schwartz, Adleman, Kellerman & Marks, (Mr. Sam Schwartz) 145 North Reynoldsburg-New Albany Road, Blacklick, OH 43004-9701. Phone number is 614-866-1600.

Our legal counsel is the firm of Kahn, Kleinman, Yanowitz & Arnson (contact for Service Supply is Mr. Neil Kurit, The Tower at Erievue, Suite 2600, 1301 East Ninth Street, Cleveland, OH 44114-1824. Neil Kurit's phone number is 216-736-3452.

**Should you have any questions, please feel free to call me Toll Free -
in Ohio call 800-282-1900 - Indiana and West Virginia call 800-848-7556.**

Very truly yours,

SERVICE SUPPLY LTD., INC.

Jerry Groves

**Jerry Groves
Vice President**

JG/dlh

SERVICE SUPPLY LTD., INC.

ACTION BY UNANIMOUS WRITTEN CONSENT OF THE BOARD OF DIRECTORS

December 12, 1988

Pursuant to Section 1701.54 of the Ohio Revised Code, the undersigned, being all of the members of the Board of Directors of SERVICE SUPPLY LTD., INC. (the "Corporation"), do hereby take and adopt the following actions by this unanimous written consent:

RESOLVED: That the following persons be, and they hereby are, elected to the offices of the Corporation set opposite their respective names, each to serve in such capacity until his or her successor is duly elected and qualified:

Mary G. Groves	President
Jerry L. Groves	Vice President
Oscar B. Groves	Secretary/Treasurer
Alan Kletecka	Sales Manager

RESOLVED: That the officers of the Corporation select a bank to be the official depository of the Corporation and that the corporate resolutions required by such institution be, and they same hereby are, adopted by the Corporation as part of this resolution and that any one of the officers be, and they hereby are, authorized to execute, acknowledge, and deliver in the name and on behalf of the Corporation, any and all agreements, documents and certificates, and to do and perform all such acts and things as may be deemed by them necessary or appropriate to effectuate the purpose of this resolution;

RESOLVED
FURTHER: That said bank be, and it hereby is, authorized to pay out the funds of the Corporation on deposit with it from time to time upon checks, drafts or other withdrawal orders drawn upon it and signed in the name of the Corporation by any one of the following persons:

Oscar B. Groves
Mary G. Groves

whether the checks, drafts or other withdrawal orders are payable to cash, bearer, the orders of any third party, the order of the signing officers or employees of the Corporation, or to the order

of any other officer or employee of the Corporation in either his or her individual or official capacity; and

RESOLVED FURTHER: That the Secretary of the Corporation be, and hereby is, authorized to furnish to said institution a certified copy of this resolution and that this resolution remain in full force and effect until a certified copy of a resolution amending, modifying, replacing, or rescinding this resolution has been furnished to the bank; and

RESOLVED FURTHER: That any one of the officers be, and they hereby are, authorized to execute and deliver any and all notes, agreements, documents or papers of any type or nature whatsoever to consummate the purpose of the foregoing resolution.

RESOLVED: That any one of the officers be, and they hereby are, authorized to pay all fees and expenses incident to and necessary for the organization of the Corporation.

RESOLVED: That any of the officers of the Corporation be, and they hereby are, authorized, directed and empowered to file or cause to be filed a Notification of Exemption on Form 3-0 with the Ohio Division of Securities within sixty (60) days from the date of the original subscription to the shares of the Corporation.



Oscar B. Groves



Mary G. Groves

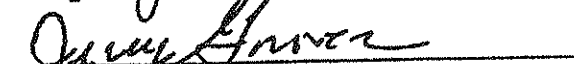

Jerry Groves



Janet Kletecka

"Directors"

SERVICE SUPPLY LTD., INC.

ACTION BY UNANIMOUS WRITTEN CONSENT
OF THE BOARD OF DIRECTORS

January 2, 1989

Pursuant to Section 1701.54 of the Ohio Revised Code, the undersigned, being all of the members of the Board of Directors of SERVICE SUPPLY LTD., INC. (the "Corporation"), do hereby take and adopt the following action by this unanimous written consent:

RESOLVED: That the following persons are authorized to sign any bids on behalf of the Corporation:

Oscar B. Groves
Mary G. Groves
Alan Kletecka
Jerry L. Groves
Janet Kletecka

Oscar B. Groves
Oscar B. Groves
Mary G. Groves
Mary G. Groves
Janet Kletecka
Janet Kletecka
Jerry L. Groves
Jerry L. Groves
"Directors"

SERVICE SUPPLY LTD., INC.

LTD

1524 SOUTH HAMILTON ROAD - COLUMBUS, OHIO 43227 - TELEPHONE 614 / 861 - 3681
FAX 614/863-0113

NOTICE TO ALL COMPANY SUPERVISORY AND ADMINISTRATIVE PERSONNEL

Attached hereto and a part hereof is our Written Statement of Company Policy of Service Supply Ltd., Inc. with respect to equal employment opportunity.

It now becomes part of your responsibility with Service Supply Ltd., Inc. to implement this policy in every way, especially with respect to taking affirmation action as stated in the policy. Accordingly, you are hereby directed to:

- A. Post such notices as are prescribed by the Federal or State laws, City Ordinances and resolutions, and the rules and regulations adopted thereunder together with the applicable orders of the governmental agencies or officers established thereunder.
- B. Encourage employment of minority group employees for work in trades where they are not frequently represented. This will be done generally by our main office in hiring but the same shall apply to all job sites. Any applicant for any job should be referred to Mrs. Mary Groves at the main office to assure proper processing of his or her application.
- C. Encourage minority group candidates for apprenticeship classes.



Secretary-Treasurer

Signature of Company Official

SERVICE SUPPLY LTD., INC.

1524 SOUTH HAMILTON ROAD - COLUMBUS, OHIO 43227 - TELEPHONE 614 / 861 - 3681
FAX 614/863-0113

WRITTEN STATEMENT OF COMPANY POLICY

It is the policy of Service Supply Ltd., Inc. that equal employment opportunity be afforded to all qualified persons without regard to race, religion, color, sex or national origin.

In support of this policy Service Supply Ltd., Inc. will not discriminate against any employee or applicant for employment because of race, religion, color, sex or national origin.

The Service Supply Ltd., Inc. will take affirmative action to insure that applicants are employed, and that employees are treated during employment without regard to race, religion, color, sex or national origin. Such action will include but not be limited to:

**RECRUITMENT, ADVERTISING OR SOLICITATION FOR
EMPLOYMENT, HIRING, PLACEMENT, UPGRADING, TRANSFER
OR DEMOTION. SELECTION FOR TRAINING INCLUDING
APPRENTICESHIP, TREATMENT DURING EMPLOYMENT, RATES
OF PAY OR OTHER FORMS OF COMPENSATION, LAYOFF OR
TERMINATION.**

SERVICE SUPPLY LTD., INC.

Ben Groves

Secretary -Treasurer

Signature of Company Official

SERVICE SUPPLY LTD., INC.

LTD

1524 SOUTH HAMILTON ROAD - COLUMBUS, OHIO 43227 - TELEPHONE 614 / 861 - 3681
FAX 614/863-0113

WRITTEN STATEMENT OF COMPANY POLICY

Please be advised that our policy also includes ancestry.

Service Supply Ltd., Inc. is a family oriented business. We have a total of nine employees, all but three employees are related. We do not recruit, if necessary to recruit, sources and all applicants will be advised that we are an equal opportunity employer.

There is no training program at the present, if it becomes necessary, we will make training available.

If an employee feel that he or she has been discriminated against, they should contact Ben Groves, Secretary/Treasurer of Service Supply Ltd., Inc., he will inform them of any other areas of redress. We will not retaliate against any employee or applicant who files an internal grievance.



Signature of Company
Official

SERVICE SUPPLY LTD., INC.

LTD

1524 SOUTH HAMILTON ROAD - COLUMBUS, OHIO 43227 - TELEPHONE 614 / 861 - 3681
FAX 614/863-0113

January 1, 1990

NOTICE TO EMPLOYEES

RE: DRUG FREE WORKPLACE POLICY

Please be advised that as of this date, all employees of Service Supply Ltd., Inc. are hereby notified that we consider Service Supply Ltd., Inc. to be a Drug Free Workplace.

Without exception, the unlawful manufacture, distribution, dispensing, possession, or use of a controlled substance while in the workplace is strictly prohibited.

Service Supply Ltd., Inc. requires that as a condition of employment, any employee convicted of a drug violation occurring in the workplace must notify his or her employer within five (5) days after conviction.

Any employee found in violation of this policy is subject to appropriate personnel action, up to and including termination of employment. Continued employment may be conditioned upon successful completion of an acceptable drug rehabilitation program.

Any employee seeking information on drug or alcohol abuse awareness, the availability of counseling and referral services should contact Ben Groves, Secretary-Treasurer at (614) 861-3681.

SERVICE SUPPLY LTD., INC.

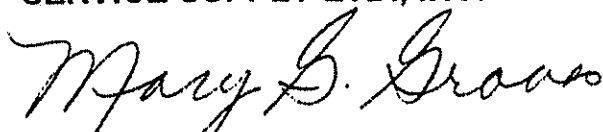

Mary G. Groves
President

MG/bh

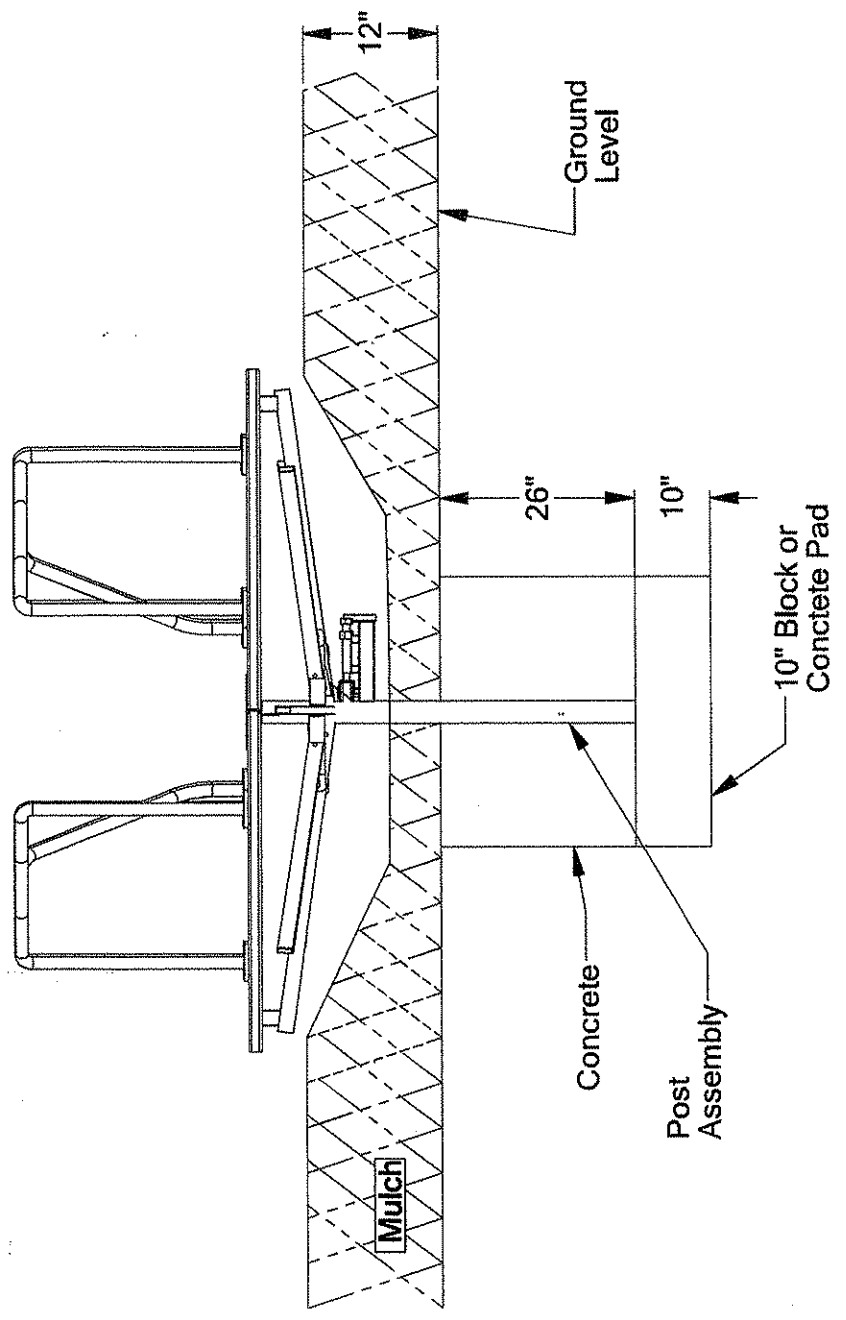

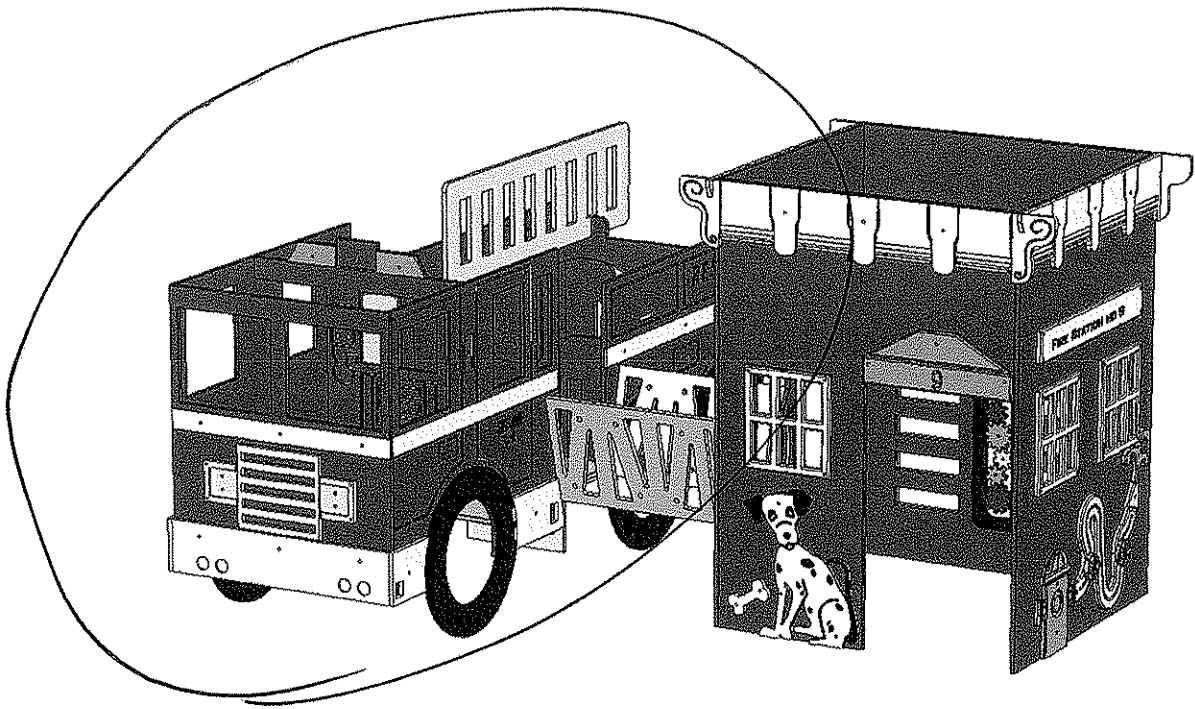

CLIMBER
PANEL

FIRETRUCK
SIDE PANEL

INSTRUMENT
PANEL

FIRETRUCK
SIDE PANEL

FIRETRUCK
FRONT

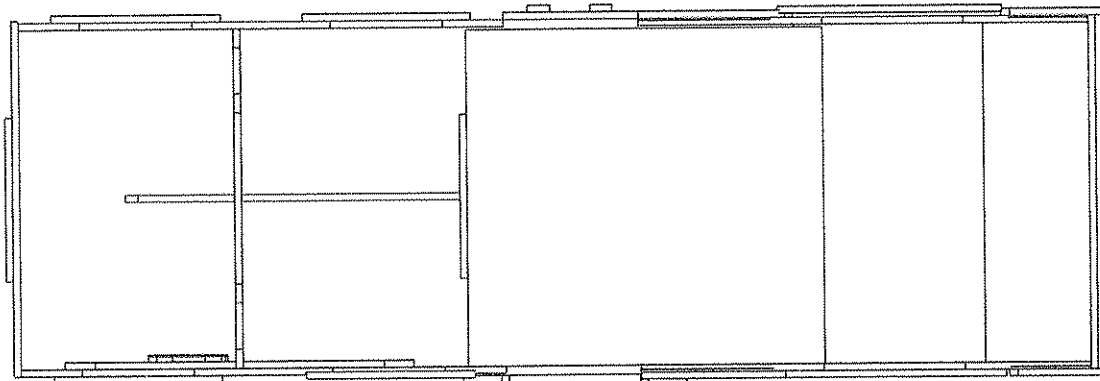

CAR RACE
TRACK
PANEL

CAT
WALK

FIRETRUCK
SIDE PANEL

GEAR
PANEL

BENCHES

ENTRANCE
PANEL

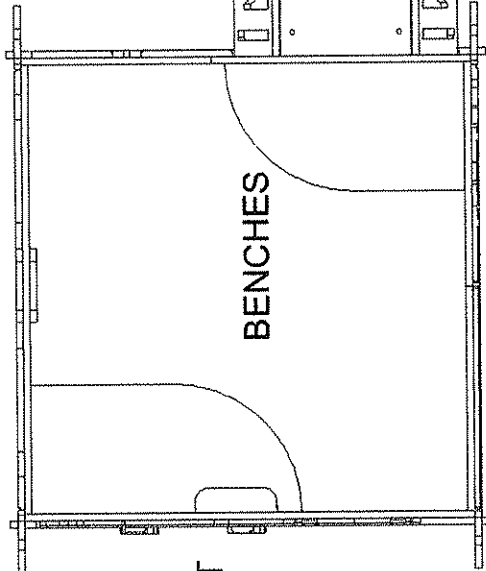

HYDRANT
SPINNER

Use Zone
16' x 16'



FIRETRUCK & HOUSE COMBO

ITEM NO.	Part Number	DESCRIPTION	QTY.
1		House Front	1
2		House Back	1
3		House Side (Catwalk)	1
4		House Side (Hydrant)	1
5		Inside Trim	2
6		Outside Trim	2
7		Catwalk Frame	1
8		Catwalk Deck	1
9		Catwalk Rail	2
10		Firetruck Front	1
11		Firetruck Back	1
12		Firetruck Side (Catwalk)	1
13		Firetruck Side (router)	1
14		Control Panel	1
15		Firetruck Back Side (Left)	1
16		Firetruck Back Side (Right)	1
17		Ladder Support Back	1
18		Ladder Support Front	1
19		Ladder	1
20		Water Spout	1
21		Firetruck Seat Back	1
22		Firetruck Deck	1
23		Firetruck Climber	1
24		Bench	1
25		Firetruck Deck	1
26		Red Steering Wheel	1
27		Firetruck Wheel for Gear Panel	1
28		5/16" x 3/4" Buttonhead Bolt	120
29		5/16" x 1" Buttonhead Bolt	110
30		5/16" x 1-1/2" Buttonhead Bolt	24
31		5/16" x 2" Buttonhead Bolt	6
32		5/16" x 2-1/2" Buttonhead Bolt	6
33		5/16" x 3" Buttonhead Bolt	2
34		5/16" x 3" Flat Washer	240
35		5/16" x 1" Buttonhead Nut	250
36		3/8" Flat Washer	240
37		3/8" x 3" Buttonhead Bolt	1
38		1/2" x 2-1/2" Bolt	1
39		1/2" Nylon Lock Nut	14
40		1/2" Flat Washer	14
41		7/8" Rubber Washer	14
42		1" Rubber Washer	14
43		Corner Bracket	52
44		5/16" x 1-3/4" Bolt	12
45		5/16" x 1-1/4" Bolt	14
46		3/8" x 1-1/4" Buttonhead Bolt	1
47		Water Balls	4
48		Firetruck Back Tires	4
49		Firetruck Frt Tires	2
50		Ladder Trim	2
51		Bench Post	1
52		Water trim (yellow)	1
53		Dog	1
54		Dog Bone	1
55		Door Trim (blue)	1
56		Windows	3
57		Cars (yellow)	2
58		Race Track Panel	1
59		Race Panel Trim	1
60		Firetruck Trim Frt	3
61		Grill	1
62		Head Lights	2
63		Light Bar	1
64		Deck Supports	2
65		Corner Anchors	6
66		Hydrant	1
117		Steering Wheel	1

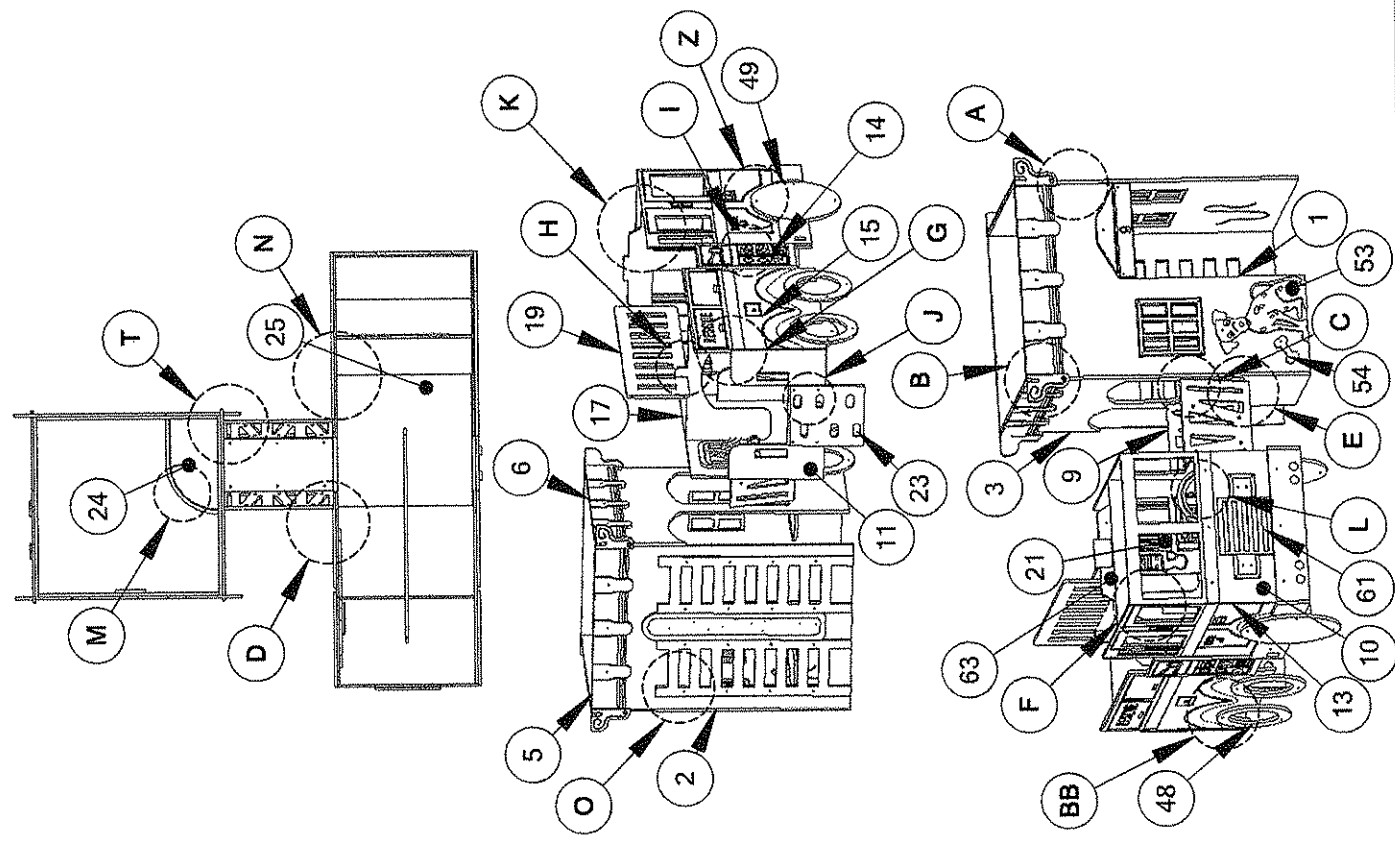



FIRETRUCK & HOUSE COMBO

SHEET 2 OF 6

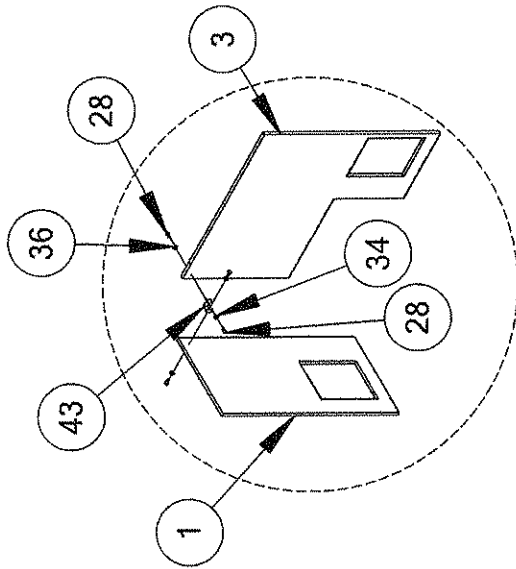

DETAIL A

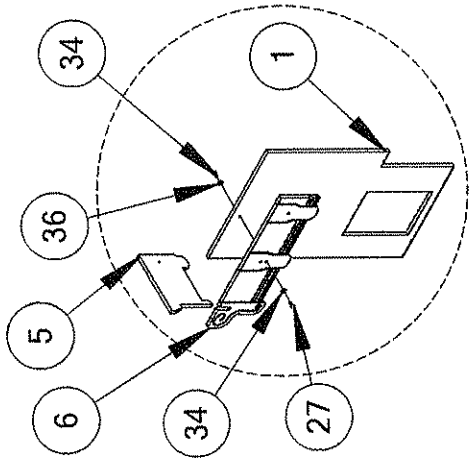

DETAIL B

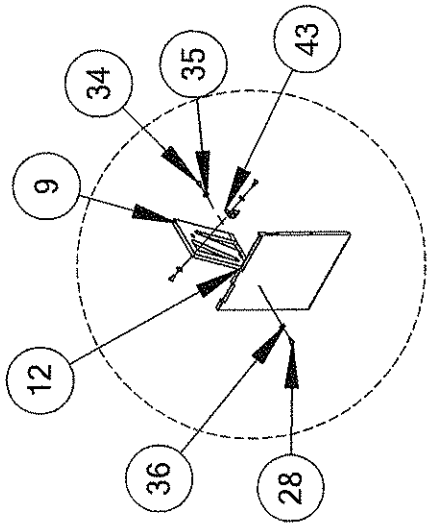

DETAIL C

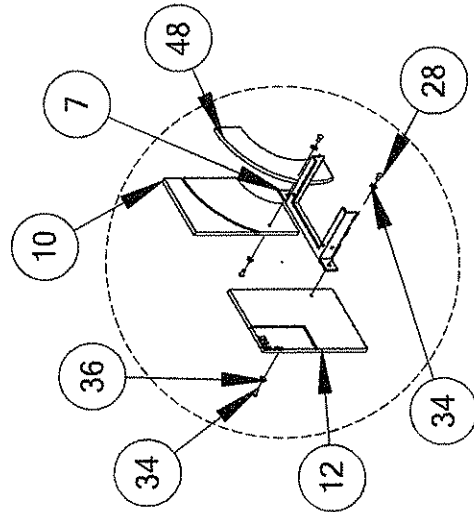

DETAIL D

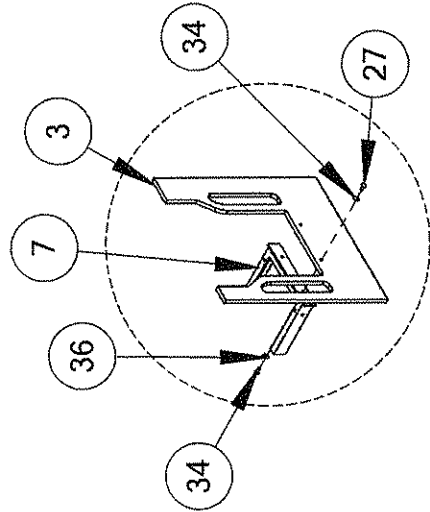

DETAIL E

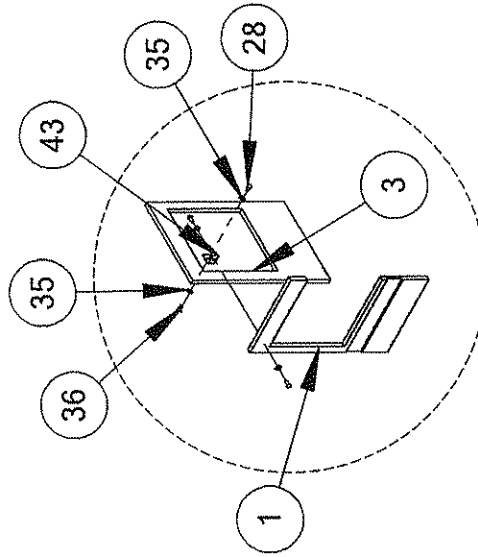

DETAIL F



FIRETRUCK & HOUSE COMBO

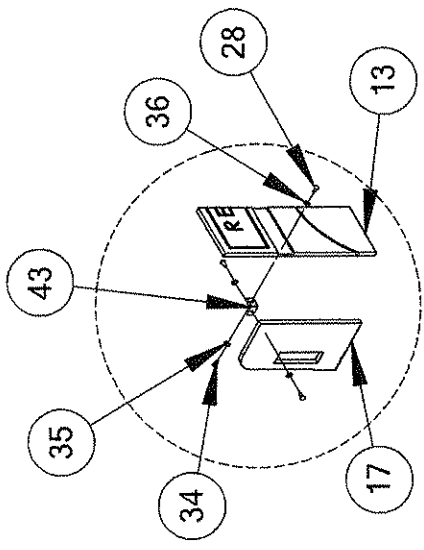

DETAIL G

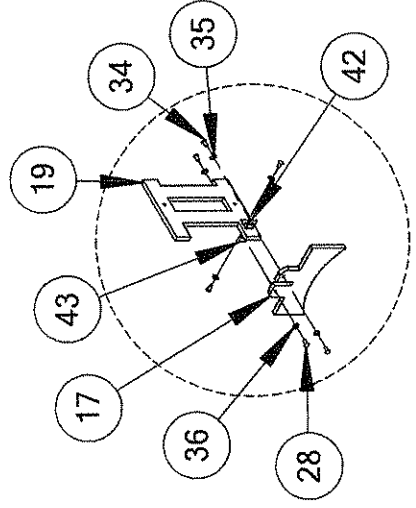

DETAIL H

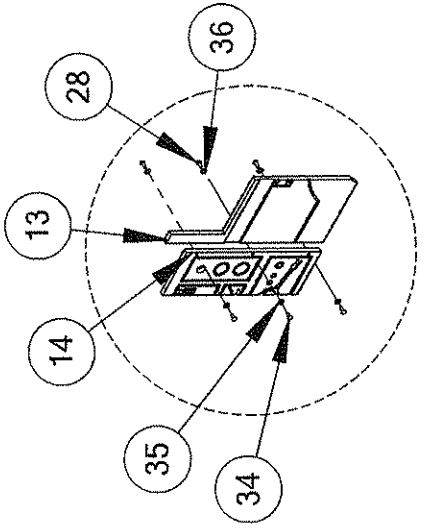

DETAIL I

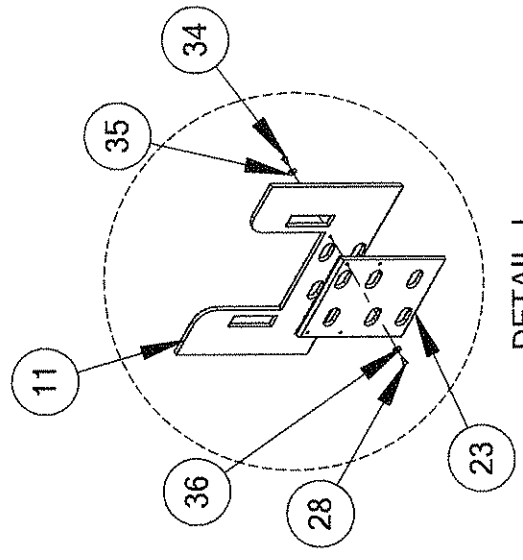

DETAIL J

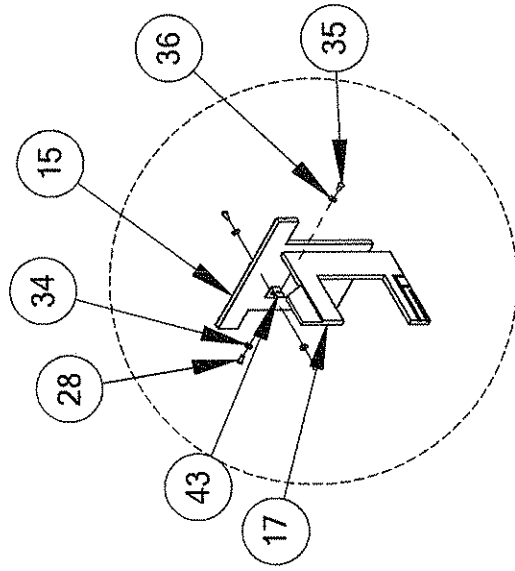

DETAIL K

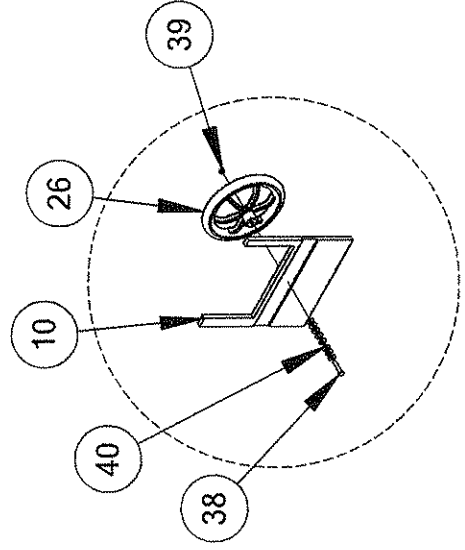

DETAIL L

1 2 3 4 5



FIRETRUCK & HOUSE COMBO

SHEET 4 OF 6

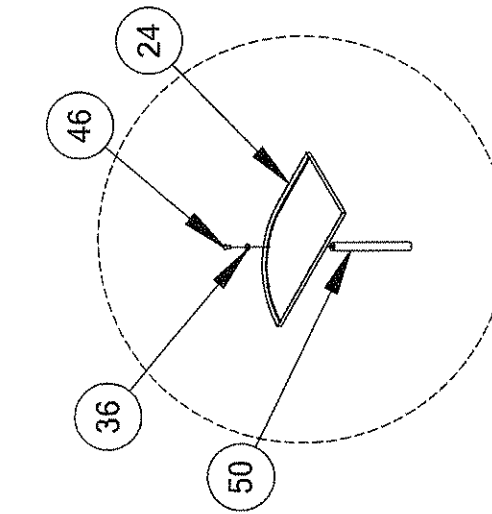

DETAIL M

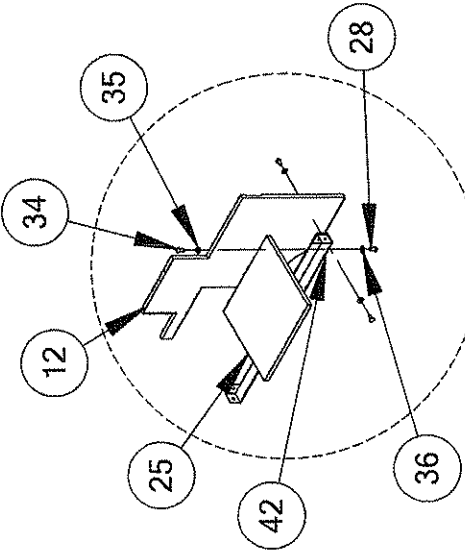

DETAIL N

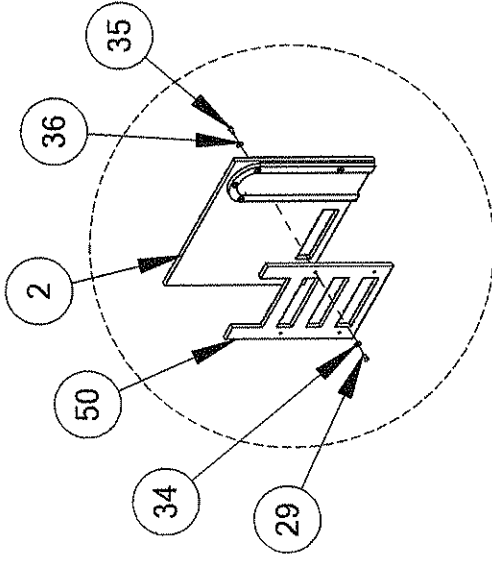

DETAIL O

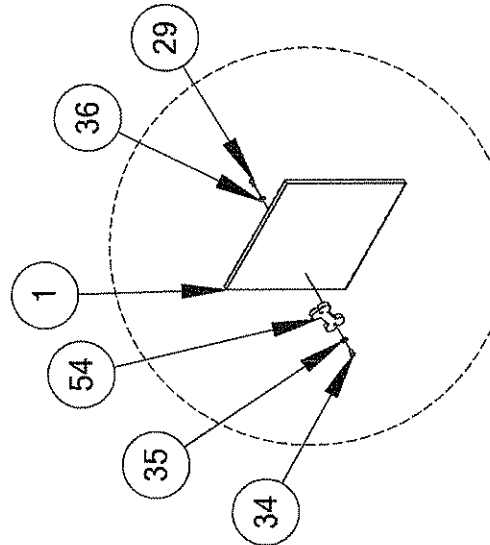

DETAIL P

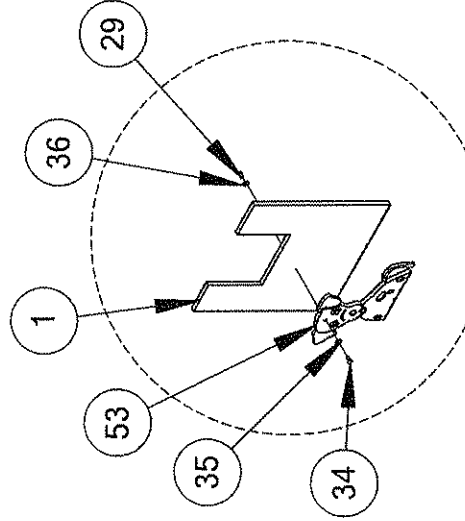

DETAIL Q

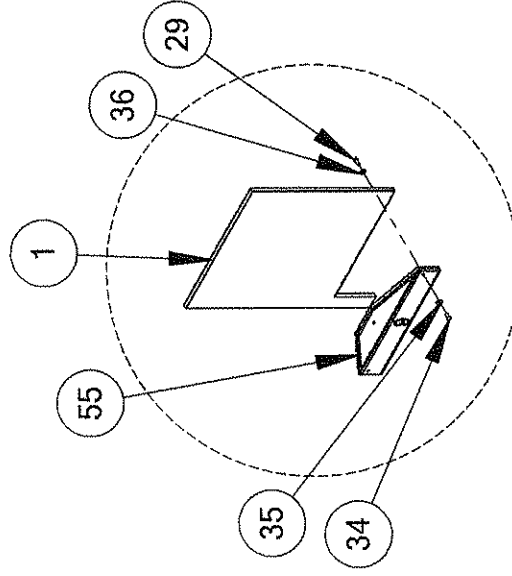

DETAIL R

1 2 3 4 5



FIRETRUCK & HOUSE COMBO

SHEET 5 of 6

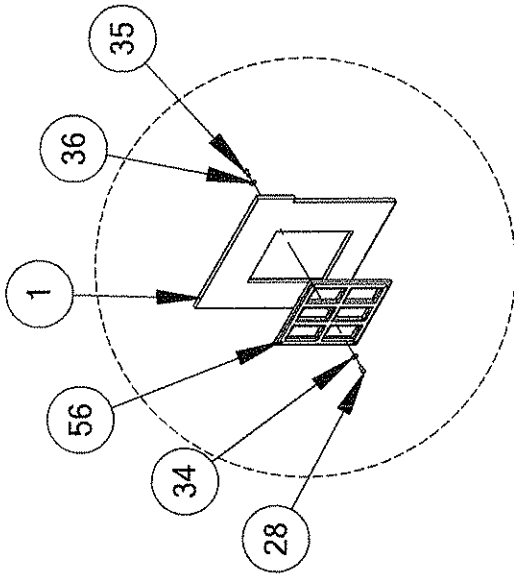

DETAIL S

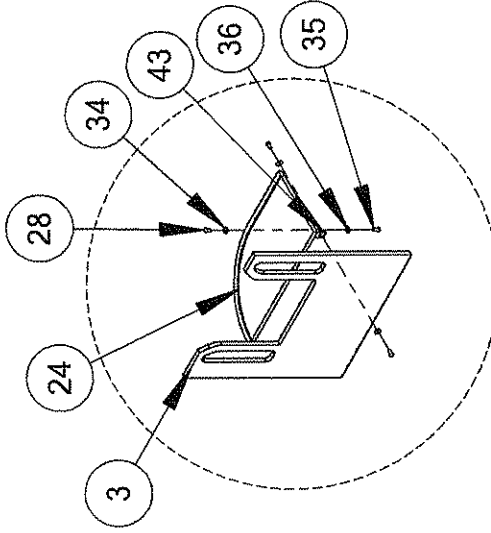

DETAIL T

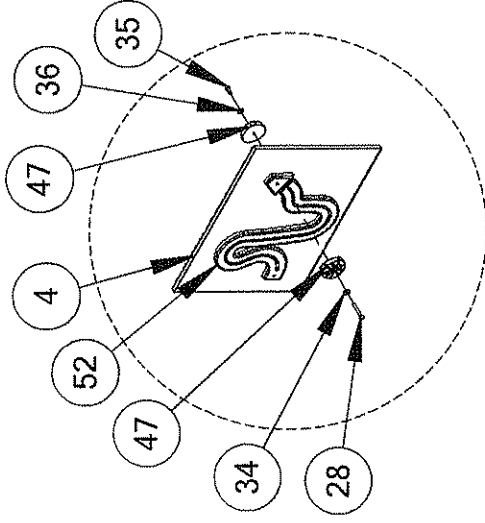

DETAIL U

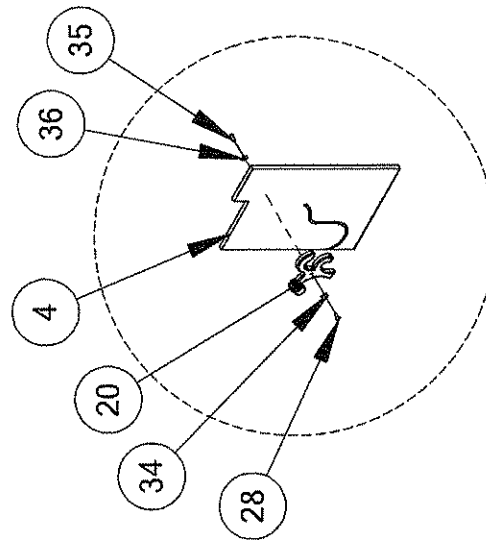

DETAIL V

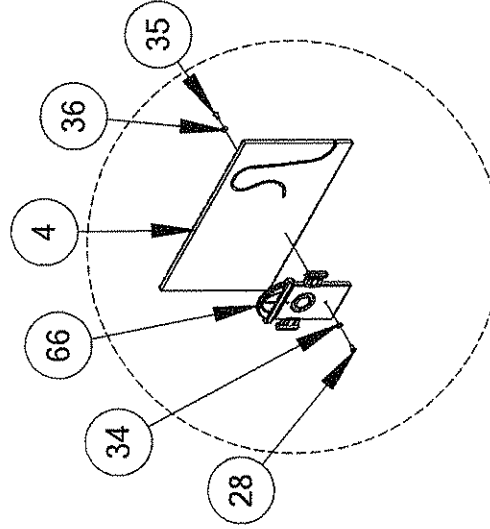

DETAIL W

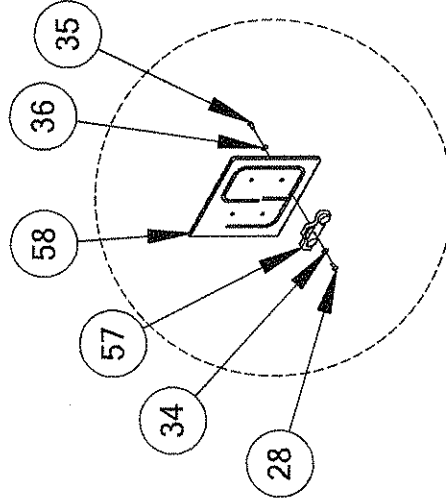

DETAIL X

1 2 3 4 5



FIRETRUCK & HOUSE COMBO

SHEET 6 OF 6

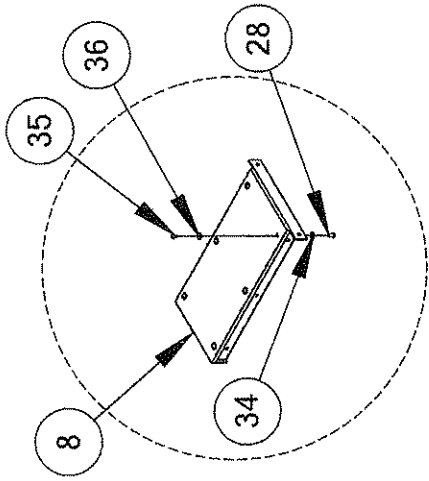

DETAIL Y

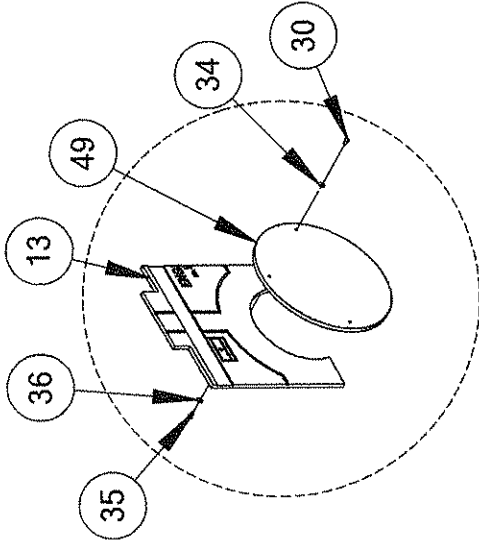

DETAIL Z

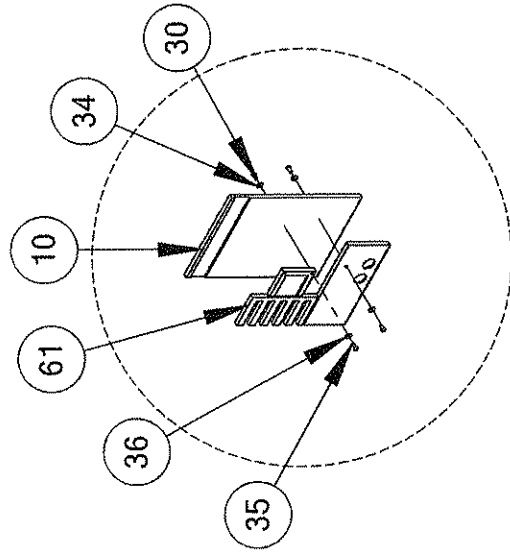

DETAIL AA

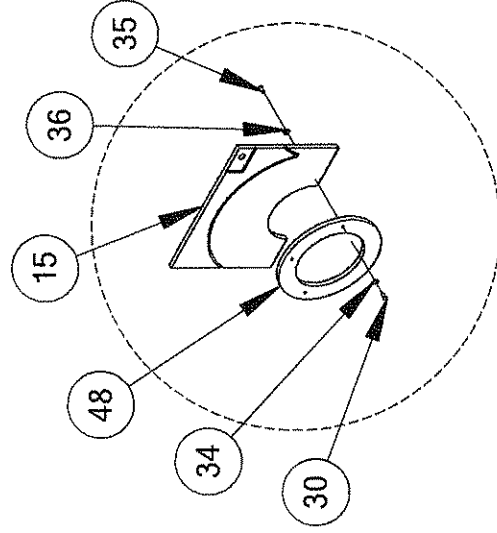

DETAIL BB

1 2 3 4 5



FIRE-ENGINE HOUSE COMBO

902-799

IMPORTANT

PLEASE RETAIN THIS INSTRUCTION SHEET IN YOUR FILES. IT CONTAINS IMPORTANT REPLACEMENT PARTS INFORMATION. ALL EQUIPMENT SHOULD BE INSTALLED IN ACCORDANCE WITH THESE INSTRUCTIONS.

IT IS IMPORTANT TO USE AND MAINTAIN ALL PUBLIC PLAYGROUND EQUIPMENT PROPERLY. PLAYGROUND EQUIPMENT, WHICH IS IMPROPERLY MAINTAINED, CAN CAUSE SERIOUS INJURY. PERIODICAL INSPECTIONS, MAINTENANCE, REPAIR AND/OR REPLACEMENT OF DAMAGED PARTS IS NECESSARY FOR SAFE OPERATION OF EQUIPMENT AND SAFETY OF USERS. **RESILIENT SURFACING** SHOULD BE USED UNDER ALL PLAYGROUND EQUIPMENT. APPROPRIATE PUBLICATIONS, AVAILABLE AT **NO CHARGE**, FROM THE CONSUMER PRODUCT SAFETY COMMISSION, INCLUDE "A HANDBOOK FOR PUBLIC PLAYGROUND SAFETY." YOU CAN RECEIVE YOUR FREE COPY BY CALLING 1-301-504-7908.

GENERAL ASSEMBLY INSTRUCTIONS:

Check all the parts and hardware with the packing list to be sure you have received everything needed to assemble this product. **CONTACT YOUR LOCAL DISTRIBUTOR WITH NOTIFICATION OF ANY MISSING OR DAMAGED PARTS.** Contact must be made within 10 days of receipt of your order. Only hand-tighten nuts and bolts on initial assembly. Final tightening should be done **EVENLY** after final assembly when unit has been plumbed and leveled.

GENERAL MAINTENANCE INSTRUCTIONS:

Check **MONTHLY** for loose bolts, damaged, or broken parts. Tighten and/or replace immediately.

SPECIFIC ASSEMBLY INSTRUCTIONS

1. Begin by locating the exact area in which the structure will be placed, it is very heavy once installed so assemble it as close as possible to the correct location.
2. The area required for this structure is 10' wide x 10' long x 6' high.
3. Install the house front, house back, and the 2 sides by referencing details A, B, & C.
4. Arrange the Firetruck as shown in the picture. Then attach the FT Front, FT Front left side, and Ft Front Right Side as shown in detail H.
5. Attach the catwalk frame and guardrails as shown in details E & F. This will tie the house to the Firetruck and the front of the Firetruck to the back of the Firetruck.
6. Next attach the Firetruck control panel between the firetruck Front Left side and the Firetruck Back Left side.
7. Now attach the Firetruck back between the Firetruck back sides.
8. Install the Seat back, and green deck in the front of the Firetruck.
9. Next install the ladder supports (2) and then install the Firetruck ladder as shown in detail J.
10. Attach the House trim pieces as shown in detail D.
11. Also attach the step as shown in detail M.
12. Now dig two holes in the ground directly in the middle of the back side panels deep enough to accommodate two of the red metal posts. These attach directly to the plastic side panels (inside) and are used to help strengthen the structure. Two more metal posts are included to be installed in front of the firetruck if desired. These can be cut down to accommodate a more shallow hole, but make sure the hole is at least 16" deep.

QUOTE SHEET

Quote No: 34759-1-1-1

Date: 05-19-09
By: GDW

Rep Organization: SERVICE SUPPLY
Contact Person: PAM WILLIAMSON

Project Title: CABWAYLINGO STATE PARK

Location: DUNLOW, WV

Phone No:

Style: No-Structure Bury Type: Direct Bury

Age: 5-12 Unless Otherwise Noted.

QTY	NO.	DESCRIPTION
-----	-----	-------------

NON STANDARD PRODUCT CHARGES
INDEPENDENT COMPONENTS

KIDS IN MOTION

1 154359A ORBITER-3 IP

INDEPENDENT SWINGS

1 120891A ARCH TIRE SWING DB ONLY

1 122837A SGL POST SWING UNCOATED

Two Full Bucket Seats.

NON STANDARD PRODUCT CHARGES

1 34759 S/S SLIDE

1 34759 CUSTOM SWING

Weight & Cost of Independent Items
Concrete: 39.50 cu-ft, Footings: 10
Labor: 19.00 Man-Hours

Weight & Cost of Equipment

Estimated requirements for Equipment.

Concrete: 39.50 cu-ft, Footings: 10

Labor: 19.00 Man-Hours

Total Safety Zone Square Footage = 1892 sq ft

Estimated Man-Hours do not include site preparation.

This quote is valid for 90 days. Purchase orders submitted with an expired quote are subject to price changes.

Custom freight quotes are valid for 30. Expired custom freight quotes are subject to changes.

Signed _____ Date _____

Material Specifications

Quote: 34759-1-1-1.QSd

5/20/2009

General Specifications: Material: All materials shall be structurally sound and suitable for safe play. Durability shall be ensured on all steel parts by the use of time-tested coatings such as zinc plating, galvanizing, ProShield finish, TenderTuff coating, etc. Colors shall be specified.

Fasteners: Primary fasteners shall be socketed and pinned tamperproof in design, stainless steel (SST) per ASTM F879 unless otherwise indicated (see specific product installation/specifications). All primary fasteners shall include a locking patch-type material that will meet the minimum torque requirements of IFI-125. Manufacturer to provide special tools for pinned tamperproof fasteners.

TenderTuff Coating: Metal components to be TenderTuff-coated shall be thoroughly cleaned in a hot phosphatizing pressure washer, then primed with a water-based thermosetting solution. Primed parts shall be preheated prior to dipping in UV-stabilized, liquid polyvinyl chloride (PVC), then salt cured at approximately 400 degrees. The finished coating shall be approximately .080" thick at an 85 durometer hardness and have a matte finish. Four standard colors are available (brown only for HealthBeat). Not applicable for Evos.

ProShield Finish: All metal components with ProShield finish shall be thoroughly cleaned and phosphatized through a five-stage power washer. Parts are then thoroughly dried, preheated and processed through a set of automatic powder spray guns where a minimum .002" of epoxy primer is applied. The parts are allowed to cool and then pass through a second set of automatic powder spray guns. A minimum .004" of architectural-grade Super-Durable polyester TGIC powder is applied. The parts are oven-cured at 400 degrees F metal temperature for 10-minutes. The average ProShield film thickness is .006".

ProShield is formulated and tested per the following ASTM standards. Each color must meet or exceed the ratings listed below:

- Hardness (D3363) rating 2H
- Impact (D2794) rating minimum 80 inch-pounds
- Salt Fog Resistance (B117 and D1654) 4,000 hours and rating 7 or greater
- UV Exposure (G154, 340 bulb) 3,000 hours, rating delta E of 2, and 90 percent gloss retention
- Adhesion (D3359, Method B) rating 5B

The Paint Line shall employ a "checkered" adhesion test daily.

Eighteen standard colors are available.

Decks: All Tenderdecks shall be of modular design and have 5/16" diameter holes on the standing surface. There shall be a minimum of (4) slots in each face to accommodate face mounting of components. Tenderdecks shall be manufactured from a single piece of low carbon 12 GA (.105") sheet steel conforming to ASTM specification A-569. The sheet shall be perforated then flanged formed and reinforced as necessary to ensure structural integrity. The unit shall then be TenderTuff-coated brown only. Tenderdecks shall be designed

so that all sides are flush with the outside edge of the supporting posts. Not applicable for Evos, Weevos or HealthBeat.

Rotationally Molded Polyethylene Parts: These parts shall be molded using prime compounded linear low-density polyethylene with a tensile strength of 2500 psi per ASTM D638 and with color and UV-stabilizing additives. Wall thickness varies by product from .187" (3/16") to .312" (5/16"). Five standard colors are available (Black only for HealthBeat).

Permalene Parts: These parts shall be manufactured from 3/4" high-density polyethylene that has been specially formulated for optimum UV stability and color retention. Products shall meet or exceed density of .960 G/cc per ASTM D1505, tensile strength of 2400 PSI per ASTM D638. Five standard solid colors are available. Some Permalene parts are available in a two-color product with (2) .100" thick exterior layers over a .550" interior core of a contrasting color. Eight standard two-color options are available. Not applicable for Evos or HealthBeat.

Footings: Unless otherwise specified, the bury on all footings shall be 34" below Finished Grade (FG) on all in-ground play events/posts. Other types of anchoring are available upon request.

Hardware Packages: All shipments shall include individual component-specific hardware packages. Each hardware package shall be labeled with the part number, description, a component diagram showing the appropriate component, package weight, a bar code linking the hardware package to the job number, assembler's name, date and time the package was assembled, work center number, and work order number.

Installation Documentation: All shipments shall include a notebook or packet of order-specific, step-by-step instructions for assembly of each component, including equipment assembly diagrams, estimated hours for assembly, footing dimensions, concrete quantity for direct bury components, fall height information, area required information and detailed material specifications.

Packing List: All shipments shall include a packing list for each skid/container, specifying the part numbers and quantities on each skid or within each container.

Packaging: PlayBooster posts shall be individually packaged in sturdy, water-resistant, mar-resistant cardboard boxes. Other components shall be individually wrapped or bulk wrapped to provide protection during shipment. Small parts and hardware packages will be placed in crates for shipment. The components and crates are then shrink-wrapped to skids (pallets) to ensure secure shipping.

Maintenance Kit: An order-specific maintenance kit shall be provided for each structure order. The kit will include a notebook or packet with a second set of installation documents and order-specific maintenance documentation with recommendations on how often to inspect, what to look for and what to do to keep the equipment in like-new condition. The kit also includes touch-up primer, appropriate

color touch-up paint, sandpaper, appropriate color touch-up PVC, graffiti remover and additional installation tools for the tamperproof fasteners.

Material Specifications:

154359A

Orbiter3 Spinner, Steel Post, (Available for Direct Bury Only)

Standing Post Assy:(Spinner Post) Weldment comprised of 2.875" O.D. RS40 (.160"-.170" wall) galvanized steel tubing,

1.125" O.D. steel shaft, 12 Ga. (.105") HR flat steel and 1141 or 1144 steel collar.Finish: Powdercoat, color specified.

(Sleeve/Plate) Weldment comprised of 1/4" sheet HRPO steel and 2.875" O.D. schedule 80 steel tubing. Finish: Powdercoat, color specified.

Spinner Assembled Top: (Upper Assembly) Weldment comprised of 1/4" x 3" HRPO flat steel, 1.900" O.D. RS40 (.120"-.130" wall) galvanized steel tube,

3.500" O.D. RS20 (.125" wall) galvanized steel tube, and 1.125" O.D. steel shaft. Finish: Powdercoat, color specified. (Sleeve/Plate) Weldment comprised of 1/4" sheet HRPO steel and 2.875" O.D. schedule 80 steel tubing. Finish: Powdercoat, color specified.

Rubber Gasket: Made from 50 durometer neoprene.

Spinner Platform:Comprised of 7 GA. (.179") HRPO flat steel and 3/8"-16 x 1" weld studs.

Standing surface is perforated with 3/8" diameter holes. Finish: TenderTuff, color specified.

Spinner Wheel: Weldment comprised of 1.029" O.D. RS20 (.070"-.080" wall) galvanized steel tube, 1/4" HRPO flat steel and 3/8" flange weld nuts. Finish: TenderTuff, color specified.

Fasteners: Primary fasteners shall be socketed and pinned tamperproof in design, stainless steel (SST) per ASTM F 879 unless otherwise indicated (see specific product installation/specifications).

120891A

Tire Swings Arch Tire Swing, TenderTuff-coated Chain

Arch Posts: See PlayBooster (PB) General Specifications.

Beam: Weldment comprised of 5" O.D. x 11 GA (.120") galvanized steel tubing, 3 1/2" O.D. RS-20 (.125") galvanized steel tubing and 7 GA (.179") flat steel gussets. Tee clamps and tire swing clamps are mechanically attached at factory

with stainless steel fasteners. Finish: Powdercoat, color specified.

Hanger Assembly: Machined from 303 stainless steel, with oil impregnated bronze bearings.

Insert: Made from 303 stainless steel.

Chain: Steel 3/16" straight link chain, 800 lb. working load limit. Finish: TenderTuff, color specified.

Tire: Rotationally molded from U.V. stabilized, E.V.A. (ethyl vinyl acetate) and high density polyethylene, blended to retain flexibility at below freezing temperatures, black in color. Tire measures 28" O.D. x 14" I.D. x 6" high.

Tire Ring: Fabricated from 1.315" O.D. RS-20 (.080" - .090") galvanized steel tubing.

Fasteners: Primary fasteners shall be socketed and pinned tamperproof in design, stainless steel (SST) per ASTM F 879 unless otherwise indicated (see specific product installation/specifications).

122837A

Single Post Swings 2-Place, Uncoated Chain

Post: See PlayBooster (PB) General Specifications.

Beam: Weldment comprised of 2.375" O.D. RS-40 (.130" - .140") galvanized steel tubing, 3" wide zinc-plated steel clamps and 1 1/4" housings w/bronze bushings. Finish: Powdercoat, color specified.

Half Clamp: Cast aluminum. Finish: Powdercoat, color specified.

Chain Spacer: Made from white nylon measuring .080" x .785" O.D..

Chain: Steel 3/16" straight link chain, 800 lb. working load limit. Finish: Hot galvanized.

Belt Seat: Molded from UV stabilized black EPDM rubber encapsulating a weldment comprised of a 22 GA (.029") spring stainless steel sheet and (4) .105 thick stainless steel washers. The belt seat elliptical shape measures 7" wide x 26" long x .700" thick.

Fasteners: Primary fasteners shall be socketed and pinned tamperproof in design, stainless steel (SST) per ASTM F 879 unless otherwise indicated (see specific product installation/specifications).

Warranty: You have our word.

Landscape Structures Inc. warrants that all playstructures and/or equipment sold will conform in kind and in quality to the specifications manual for the products identified in the Acknowledgement of Order and will be free of defects in manufacturing and material. Seller further warrants:

100-Year Limited Warranty for all stainless steel fasteners, aluminum posts,

clamps, beams and caps, against structural failure due to corrosion/natural deterioration or manufacturing defects. This warranty does not include any cosmetic issues or wear and tear from normal use.

15-Year Limited Warranty for all plastic and steel components, including TuffTimbers™, against structural failure due to corrosion/natural deterioration or manufacturing defects. TenderTuffR-coating against structural failure due to natural deterioration or manufacturing defects. (Except Wiggle Ladders, Chain Ladders and Swing Chain). TuffTurfR against material or manufacturing defects when properly installed. CorocordR cable on Spacenet climbers against breakage.

10-Year Limited Warranty for all CoolToppersR structural steel frames and Mobius climbers against structural failure due to natural deterioration or manufacturing defects.

5-Year Limited Warranty for Corocord cables on Spacenet climbers and CoolToppersR fabric against natural deterioration or manufacturing defects. This warranty is limited to the design loads as stated in the specifications found in the technical information. The Natural Elements™ climbers exterior GFRC material, against structural failure due to natural deterioration or manufacturing defects.

3-Year Limited Warranty for all other parts, ie: CableCore™ products, Swing seats and hangers, Mobius climber handholds, Wiggle Ladders, Chain Ladders and Swing Chain, Track Ride trolleys and bumpers, all rocking equipment including Sway Fun™, PVC belting material, HealthBeat hydraulic cylinders, Seesaws, Wiggle Ring Bridge, etc. against failure due to corrosion/natural deterioration or manufacturing defects.

This warranty does not include any cosmetic issues or wear and tear from normal use.

The warranty stated above is valid only if the structures and/or equipment are erected in conformance with Landscape Structures' installation instructions and maintained according to the maintenance procedures furnished by Landscape Structures Inc. For a full text of the warranty, contact your local sales representative.

QUOTE SHEET

Quote No: 34759-1-1-2

Date: 05-19-09
By: GDW

Rep Organization: SERVICE SUPPLY
Contact Person: PAM WILLIAMSON

Project Title: CABWAYLINGO STATE PARK

Location: DUNLOW, WV

Phone No:

Style: No-Structure Bury Type: Direct Bury

Age: 5-12 Unless Otherwise Noted.

QTY	NO.	DESCRIPTION
-----	-----	-------------

NON STANDARD PRODUCT CHARGES
INDEPENDENT COMPONENTS

SPRING RIDERS

- 2 164075B DOUBLE BOBBLE RIDER D.B.
- 1 100123B RHINO-DINO (PERMALENE) D.B.
- 1 100124B T-REX (PERMALENE) D.B.

NON STANDARD PRODUCT CHARGES

- 1 34759 S/S SLIDE

Weight & Cost of Independent Items
Concrete: 30.50 cu-ft, Footings: 4
Labor: 10.00 Man-Hours

Weight & Cost of Equipment

Estimated requirements for Equipment.
Concrete: 30.50 cu-ft, Footings: 4
Labor: 10.00 Man-Hours

Total Safety Zone Square Footage = 1038 sq ft

Estimated Man-Hours do not include site preparation.

This quote is valid for 90 days. Purchase orders submitted with an expired quote are subject to price changes.
Custom freight quotes are valid for 30. Expired custom freight quotes are subject to changes.

Signed _____ Date _____

Material Specifications
Quote: 34759-1-1-2.QSd
5/20/2009

General Specifications: Material: All materials shall be structurally sound and suitable for safe play. Durability shall be ensured on all steel parts by the use of time-tested coatings such as zinc plating, galvanizing, ProShield finish, TenderTuff coating, etc. Colors shall be specified.

Fasteners: Primary fasteners shall be socketed and pinned tamperproof in design, stainless steel (SST) per ASTM F879 unless otherwise indicated (see specific product installation/specifications). All primary fasteners shall include a locking patch-type material that will meet the minimum torque requirements of IFI-125. Manufacturer to provide special tools for pinned tamperproof fasteners.

TenderTuff Coating: Metal components to be TenderTuff-coated shall be thoroughly cleaned in a hot phosphatizing pressure washer, then primed with a water-based thermosetting solution. Primed parts shall be preheated prior to dipping in UV-stabilized, liquid polyvinyl chloride (PVC), then salt cured at approximately 400 degrees. The finished coating shall be approximately .080" thick at an 85 durometer hardness and have a matte finish. Four standard colors are available (brown only for HealthBeat). Not applicable for Evos.

ProShield Finish: All metal components with ProShield finish shall be thoroughly cleaned and phosphatized through a five-stage power washer. Parts are then thoroughly dried, preheated and processed through a set of automatic powder spray guns where a minimum .002" of epoxy primer is applied. The parts are allowed to cool and then pass through a second set of automatic powder spray guns. A minimum .004" of architectural-grade Super-Durable polyester TGIC powder is applied. The parts are oven-cured at 400 degrees F metal temperature for 10-minutes. The average ProShield film thickness is .006".

ProShield is formulated and tested per the following ASTM standards. Each color must meet or exceed the ratings listed below:

- Hardness (D3363) rating 2H
- Impact (D2794) rating minimum 80 inch-pounds
- Salt Fog Resistance (B117 and D1654) 4,000 hours and rating 7 or greater
- UV Exposure (G154, 340 bulb) 3,000 hours, rating delta E of 2, and 90 percent gloss retention
- Adhesion (D3359, Method B) rating 5B

The Paint Line shall employ a "checkered" adhesion test daily.

Eighteen standard colors are available.

Decks: All Tenderdecks shall be of modular design and have 5/16" diameter holes on the standing surface. There shall be a minimum of (4) slots in each face to accommodate face mounting of components. Tenderdecks shall be manufactured from a single piece of low carbon 12 GA (.105") sheet steel conforming to ASTM specification A-569. The sheet shall be perforated then flanged formed and reinforced as necessary to ensure structural integrity. The unit shall then be TenderTuff-coated brown only. Tenderdecks shall be designed

so that all sides are flush with the outside edge of the supporting posts. Not applicable for Evos, Weevos or HealthBeat.

Rotationally Molded Polyethylene Parts: These parts shall be molded using prime compounded linear low-density polyethylene with a tensile strength of 2500 psi per ASTM D638 and with color and UV-stabilizing additives. Wall thickness varies by product from .187" (3/16") to .312" (5/16"). Five standard colors are available (Black only for HealthBeat).

Permalene Parts: These parts shall be manufactured from 3/4" high-density polyethylene that has been specially formulated for optimum UV stability and color retention. Products shall meet or exceed density of .960 G/cc per ASTM D1505, tensile strength of 2400 PSI per ASTM D638. Five standard solid colors are available. Some Permalene parts are available in a two-color product with (2) .100" thick exterior layers over a .550" interior core of a contrasting color. Eight standard two-color options are available. Not applicable for Evos or HealthBeat.

Footings: Unless otherwise specified, the bury on all footings shall be 34" below Finished Grade (FG) on all in-ground play events/posts. Other types of anchoring are available upon request.

Hardware Packages: All shipments shall include individual component-specific hardware packages. Each hardware package shall be labeled with the part number, description, a component diagram showing the appropriate component, package weight, a bar code linking the hardware package to the job number, assembler's name, date and time the package was assembled, work center number, and work order number.

Installation Documentation: All shipments shall include a notebook or packet of order-specific, step-by-step instructions for assembly of each component, including equipment assembly diagrams, estimated hours for assembly, footing dimensions, concrete quantity for direct bury components, fall height information, area required information and detailed material specifications.

Packing List: All shipments shall include a packing list for each skid/container, specifying the part numbers and quantities on each skid or within each container.

Packaging: PlayBooster posts shall be individually packaged in sturdy, water-resistant, mar-resistant cardboard boxes. Other components shall be individually wrapped or bulk wrapped to provide protection during shipment. Small parts and hardware packages will be placed in crates for shipment. The components and crates are then shrink-wrapped to skids (pallets) to ensure secure shipping.

Maintenance Kit: An order-specific maintenance kit shall be provided for each structure order. The kit will include a notebook or packet with a second set of installation documents and order-specific maintenance documentation with recommendations on how often to inspect, what to look for and what to do to keep the equipment in like-new condition. The kit also includes touch-up primer, appropriate

color touch-up paint, sandpaper, appropriate color touch-up PVC, graffiti remover and additional installation tools for the tamperproof fasteners.

Material Specifications:

164075B

Bobble Rider, Double Direct Bury

Bobble Rider: Weldment comprised of 1.315" O.D. RS20 (.080"-.090" wall) galvanized steel tubing, 2.375" O.D. RS20 (.095"-.105" wall) galvanized steel tubing, 3/8" HRPO steel plate, 1/4" HRPO steel plate, and 4" diameter 10 GA. (.135") low carbon steel ball. Finish: Powdercoat, color specified.

Spring: Weldment comprised of 5 5/8" diameter 13/16" tempered alloy steel coil. Finish: Powdercoat, black in color.

Footer: Weldment comprised of 3.500" O.D. RS20 (.120"-.130" wall) galvanized steel tubing and 1/4" x 10" x 17" sheet HRPO steel. Finish: Powdercoat, black in color.

Seat: Rotationally molded from U.V. stabilized linear low density polyethylene, black in color.

Fasteners: Primary fasteners shall be socketed and pinned tamperproof in design, stainless steel (SST) per ASTM F 879 unless otherwise indicated (see specific product installation/specifications).

100123B

TuffRiders* TuffRider, RhinoDino, Direct Bury

Leg: Weldment comprised of 3 1/2" O.D. RS-20 (.120" - .130") galvanized steel tubing and 1/4" HRPO zinc plated steel mounting plates.

Panels: Solid color Permalene backrest panel and seat panel, tan in color. Two color Permalene body panels and shield panel, green/tan in color.

Spring: Fabricated from 5 5/8" diameter 13/16" tempered alloy steel coil, with cast aluminum wedges A356 alloy placed in each end of spring. Finish: Powdercoat, color specified.

Base Plate: Fabricated from 1/4" x 10" diameter flat steel. Finish: Powdercoat, brown in color.

Footrest: Cast from 356-T6 aluminum alloy. Finish: Powdercoat, brown in color.

Brackets: Fabricated from formed 7 GA (.179") HRS. Finish: Powdercoat, brown in color.

Bolt Caps: Made from injection molded polypropylene, U.V. stabilized, white in color.

Fasteners: Primary fasteners shall be socketed and pinned tamperproof in design, stainless steel (SST) per ASTM F 879 unless otherwise indicated (see specific product installation/specifications).

100124B

TuffRiders* TuffRider, T-Rex, Direct Bury

Leg: Weldment comprised of 3 1/2" O.D. RS-20 (.120" - .130") galvanized steel tubing and 1/4" HRPO zinc plated steel mounting plates.

Panels: Solid color Permalene long brace, short brace, seat panel, footrest spacer tan in color. Two color permalene body panel green/tan in color.

Spring: Fabricated from 5 5/8" diameter 13/16" tempered alloy steel coil, with cast aluminum wedges A356 alloy placed in each end of spring. Finish: Powdercoat, color specified.

Base Plate: Fabricated from 1/4" x 10" diameter flat steel. Finish: Powdercoat, brown in color.

Footrest: Cast from 356-T6 aluminum alloy. Finish: Powdercoat, brown in color.

Brackets: Fabricated from formed 7 GA (.179") HRS. Finish: Powdercoat, brown in color.

Bolt Caps: Made from injection molded polypropylene, U.V. stabilized, white in color.

Fasteners: Primary fasteners shall be socketed and pinned tamperproof in design, stainless steel (SST) per ASTM F 879 unless otherwise indicated (see specific product installation/specifications).

Warranty: You have our word.

Landscape Structures Inc. warrants that all playstructures and/or equipment sold will conform in kind and in quality to the specifications manual for the products identified in the Acknowledgement of Order and will be free of defects in manufacturing and material. Seller further warrants:

100-Year Limited Warranty for all stainless steel fasteners, aluminum posts, clamps, beams and caps, against structural failure due to corrosion/natural deterioration or manufacturing defects. This warranty does not include any cosmetic issues or wear and tear from normal use.

15-Year Limited Warranty for all plastic and steel components, including TuffTimbers™, against structural failure due to corrosion/natural deterioration or manufacturing defects. TenderTuffR-coating against structural failure due to natural deterioration or manufacturing defects. (Except Wiggle Ladders, Chain

Ladders and Swing Chain). TuffTurfR against material or manufacturing defects when properly installed. CorocordR cable on Spacenet climbers against breakage.

10-Year Limited Warranty for all CoolToppersR structural steel frames and Mobius climbers against structural failure due to natural deterioration or manufacturing defects.

5-Year Limited Warranty for Corocord cables on Spacenet climbers and CoolToppersR fabric against natural deterioration or manufacturing defects. This warranty is limited to the design loads as stated in the specifications found in the technical information. The Natural ElementsTM climbers exterior GFRC material, against structural failure due to natural deterioration or manufacturing defects.

3-Year Limited Warranty for all other parts, ie: CableCoreTM products, Swing seats and hangers, Mobius climber handholds, Wiggle Ladders, Chain Ladders and Swing Chain, Track Ride trolleys and bumpers, all rocking equipment including Sway FunTM, PVC belting material, HealthBeat hydraulic cylinders, Seesaws, Wiggle Ring Bridge, etc. against failure due to corrosion/natural deterioration or manufacturing defects.

This warranty does not include any cosmetic issues or wear and tear from normal use.

The warranty stated above is valid only if the structures and/or equipment are erected in conformance with Landscape Structures' installation instructions and maintained according to the maintenance procedures furnished by Landscape Structures Inc. For a full text of the warranty, contact your local sales representative.

QUOTE SHEET

Quote No: 34759-1-1-3

Date: 05-19-09
By: GDW

Rep Organization: SERVICE SUPPLY
Contact Person: PAM WILLIAMSON

Project Title: CABWAYLINGO STATE PARK
Location: DUNLOW, WV
Style: Playbooster Posts: Aluminum
Age: 5-12 Unless Otherwise Noted.

Phone No:
Bury Type: Direct Bury

QTY	NO.	DESCRIPTION
-----	-----	-------------

POSTS

- 6 111404A 148 ALUM. POST D.B.
- 1 111404E 116 ALUM. POST D.B.

DECKS

- 1 111232A HEXAGON TENDERDECK

CLIMBERS

- 1 150975B CASCADE CLIMBER 72 DECK DB
- 1 148432B CORKSCREW W/PERM 72 DECK
- 1 126194A FISH NET CLIMBER
- 1 148434B LOOP POLE W/PERM 72 DECK
- 1 145624D VERTICAL ASCENT 72 DECK
- 1 116249D VERTICAL LADDER 72 DECK

ATTACHMENTS/CONNECTORS

- 1 148426B FIREPOLE W/PERM 72 DECK

NON STANDARD PRODUCT CHARGES

Weight & Cost of Playstructure Items
Concrete: 23.70 cu-ft, Footings: 16
Labor: 26.50 Man-Hours

INDEPENDENT COMPONENTS

INDEPENDENT SWINGS

- 1 122837A SGL POST SWING UNCOATED
Two Full Bucket Seats.

NON STANDARD PRODUCT CHARGES

- 1 34759 CUSTOM SWING
- 1 34759 S/S SLIDE

Weight & Cost of Independent Items
Concrete: 14.00 cu-ft, Footings: 2
Labor: 6.00 Man-Hours

Weight & Cost of Equipment

Estimated requirements for Equipment.

Concrete: 37.70 cu-ft, Footings: 18

Labor: 32.50 Man-Hours

Total Safety Zone Square Footage = 1665 sq ft

Page: 2

Date: 05-19-09

Project Title: CABWAYLINGO STATE PARK

Quote No: 34759-1-

1-3

Style: Playbooster

Posts: Aluminum

Bury Type: Direct Bury

Estimated Man-Hours do not include site preparation.

This quote is valid for 90 days. Purchase orders submitted with an expired quote are subject to price changes.

Custom freight quotes are valid for 30. Expired custom freight quotes are subject to changes.

Signed _____ Date _____

Material Specifications
Quote: 34759-1-1-3.QSd
5/20/2009

General Specifications: Material: All materials shall be structurally sound and suitable for safe play. Durability shall be ensured on all steel parts by the use of time-tested coatings such as zinc plating, galvanizing, ProShield finish, TenderTuff coating, etc. Colors shall be specified.

Fasteners: Primary fasteners shall be socketed and pinned tamperproof in design, stainless steel (SST) per ASTM F879 unless otherwise indicated (see specific product installation/specifications). All primary fasteners shall include a locking patch-type material that will meet the minimum torque requirements of IFI-125. Manufacturer to provide special tools for pinned tamperproof fasteners.

TenderTuff Coating: Metal components to be TenderTuff-coated shall be thoroughly cleaned in a hot phosphatizing pressure washer, then primed with a water-based thermosetting solution. Primed parts shall be preheated prior to dipping in UV-stabilized, liquid polyvinyl chloride (PVC), then salt cured at approximately 400 degrees. The finished coating shall be approximately .080" thick at an 85 durometer hardness and have a matte finish. Four standard colors are available (brown only for HealthBeat). Not applicable for Evos.

ProShield Finish: All metal components with ProShield finish shall be thoroughly cleaned and phosphatized through a five-stage power washer. Parts are then thoroughly dried, preheated and processed through a set of automatic powder spray guns where a minimum .002" of epoxy primer is applied. The parts are allowed to cool and then pass through a second set of automatic powder spray guns. A minimum .004" of architectural-grade Super-Durable polyester TGIC powder is applied. The parts are oven-cured at 400 degrees F metal temperature for 10-minutes. The average ProShield film thickness is .006".

ProShield is formulated and tested per the following ASTM standards. Each color must meet or exceed the ratings listed below:

- Hardness (D3363) rating 2H
- Impact (D2794) rating minimum 80 inch-pounds
- Salt Fog Resistance (B117 and D1654) 4,000 hours and rating 7 or greater
- UV Exposure (G154, 340 bulb) 3,000 hours, rating delta E of 2, and 90 percent gloss retention
- Adhesion (D3359, Method B) rating 5B

The Paint Line shall employ a "checkered" adhesion test daily.

Eighteen standard colors are available.

Decks: All Tenderdecks shall be of modular design and have 5/16" diameter holes on the standing surface. There shall be a minimum of (4) slots in each face to accommodate face mounting of components. Tenderdecks shall be manufactured from a single piece of low carbon 12 GA (.105") sheet steel conforming to ASTM specification A-569. The sheet shall be perforated then flanged formed and reinforced as necessary to ensure structural integrity. The unit shall then be TenderTuff-coated brown only. Tenderdecks shall be designed

so that all sides are flush with the outside edge of the supporting posts. Not applicable for Evos, Weevos or HealthBeat.

Rotationally Molded Polyethylene Parts: These parts shall be molded using prime compounded linear low-density polyethylene with a tensile strength of 2500 psi per ASTM D638 and with color and UV-stabilizing additives. Wall thickness varies by product from .187" (3/16") to .312" (5/16"). Five standard colors are available (Black only for HealthBeat).

Permalene Parts: These parts shall be manufactured from 3/4" high-density polyethylene that has been specially formulated for optimum UV stability and color retention. Products shall meet or exceed density of .960 G/cc per ASTM D1505, tensile strength of 2400 PSI per ASTM D638. Five standard solid colors are available. Some Permalene parts are available in a two-color product with (2) .100" thick exterior layers over a .550" interior core of a contrasting color. Eight standard two-color options are available. Not applicable for Evos or HealthBeat.

Footings: Unless otherwise specified, the bury on all footings shall be 34" below Finished Grade (FG) on all in-ground play events/posts. Other types of anchoring are available upon request.

Hardware Packages: All shipments shall include individual component-specific hardware packages. Each hardware package shall be labeled with the part number, description, a component diagram showing the appropriate component, package weight, a bar code linking the hardware package to the job number, assembler's name, date and time the package was assembled, work center number, and work order number.

Installation Documentation: All shipments shall include a notebook or packet of order-specific, step-by-step instructions for assembly of each component, including equipment assembly diagrams, estimated hours for assembly, footing dimensions, concrete quantity for direct bury components, fall height information, area required information and detailed material specifications.

Packing List: All shipments shall include a packing list for each skid/container, specifying the part numbers and quantities on each skid or within each container.

Packaging: PlayBooster posts shall be individually packaged in sturdy, water-resistant, mar-resistant cardboard boxes. Other components shall be individually wrapped or bulk wrapped to provide protection during shipment. Small parts and hardware packages will be placed in crates for shipment. The components and crates are then shrink-wrapped to skids (pallets) to ensure secure shipping.

Maintenance Kit: An order-specific maintenance kit shall be provided for each structure order. The kit will include a notebook or packet with a second set of installation documents and order-specific maintenance documentation with recommendations on how often to inspect, what to look for and what to do to keep the equipment in like-new condition. The kit also includes touch-up primer, appropriate

color touch-up paint, sandpaper, appropriate color touch-up PVC, graffiti remover and additional installation tools for the tamperproof fasteners.

(PB) General Specifications: Posts: Post length shall vary depending upon the intended use and shall be a minimum of 42" above the deck height. All posts shall be powdercoated to specified color. All posts shall have a "finished grade marker" positioned on the post identifying the 34" bury line required for correct installation and the top of the loose fill protective surfacing. Top caps for posts shall be aluminum die cast from 369.1 alloy and powdercoated to match the post color. All caps shall be factory installed and secured in place with (3) self sealing rivets. A molded low-density polyethylene cap, with drain holes, shall be pressed onto the bottom end of the post to increase the footing area.

Steel Posts: All steel PlayBooster posts are manufactured from 5" O.D. tubing with a wall thickness of .120" and shall be galvanized after rolling and shall have both the I.D. and the cut ends sprayed with a corrosion resistant coating.

Steel Post Mechanical Properties:

Yield Strength (min): 50,000 PSI
Tensile Strength (min): 55,000 PSI
% Elongation in 2 inches: 25
Modulus of Elasticity: 29.5 x 1,000,000 PSI

Aluminum Posts: All aluminum PlayBooster posts are manufactured from 6005-T5 extruded tubing conforming to ASTM B-221. Posts shall have a 5" outside diameter with a .125" wall thickness.

Aluminum Post Mechanical Properties:

Yield Strength (min): 35,000 PSI
Tensile Strength (min): 38,000 PSI
% Elongation in 2 inches: 10
Modulus of Elasticity: 10 x 1,000,000 PSI

Arch Posts: Aluminum arch posts shall be manufactured from 6005-T5 alloy. The arch shall be formed to a 21" center line radius to complement the 42" center to center module. The arch shall be of one continuous piece construction. There shall be no welds or additional pieces mechanically fastened to manufacture the arch. Each arch shall be designed to provide a minimum of 90 1/2" clear span from the deck to the inside of the arch at the radius peak. Arches shall be powdercoated to a specified color.

Clamps: All clamps, unless otherwise noted, shall be die cast using a 369.1 aluminum alloy and have the following mechanical properties:

Ultimate Tensile: 47,000 PSI
Yield Strength: 28,000 PSI
Elongation: 7% in 2 inches
Shear Strength: 29,000 PSI
Endurance Limit: 20,000 PSI

Each functional clamp assembly shall have an appropriate number of half clamps and shall be fastened to mating parts with (2) 3/8" x 1 1/8" pinned button head cap screws (SST) and (2) stainless steel (SST) recessed "T" nuts. A 1/4"

aluminum drive rivet w/stainless steel pin is used to ensure a secure fit to the post.

PlayBooster clamps have three functional applications and shall be named as follows:

- 1.) Offset hanger clamp assembly.
- 2.) Deck hanger clamp assembly.
- 3.) Hanger clamp assembly.

Material Specifications:

111404A

Posts For Decks 148"/72" Deck

Post: See PlayBooster (PB) General Specifications.

111404E

Posts For Decks 116"/40" Deck

Post: See PlayBooster (PB) General Specifications.

111232A

Decks Hexagon Tenderdeck, Brown Only

Hex Deck: Flange formed from 12 GA (.105") sheet steel conforming to ASTM A569. Standing surface is perforated with 5/16" diameter holes. Deck face has (4) slotted holes for face mounting components. The finished size measures 2 5/8" x 36 3/4" per each of the six sides for an overall dimension of 77 5/8" face to face. Finish: TenderTuff, brown in color.

Deck Brace: Fabricated from 3/8" x 1 3/4" x 28 1/2" long zinc plated steel strap.

Deck Hanger Clamp Assembly: Cast aluminum. Finish: Powdercoat, color specified.

Fasteners: Primary fasteners shall be socketed and pinned tamperproof in design, stainless steel (SST) per ASTM F 879 unless otherwise indicated (see specific product installation/specifications).

150975B

Cascade Climbers 64" - 72" Deck, (Available for Direct Bury Only)

Panels: Solid color Permalene, color specified.

Barrier: Weldment comprised of 1.125" O.D. x 11 GA (.120") steel tube per ASTM A513 with 203 or 303 stainless steel welded inserts with 5/8" internal threads and 1/4" tabs. Finish: TenderTuff, color specified.

Support Pipe: Weldment comprised of 2.375" O.D. RS40 (.130"-.140" wall) galvanized steel tube, 1/4" x 1 1/4" HR flat steel and 12 Ga. (.105") sheet HRPO steel. Finish: Powdercoat, color specified.

Clamps: Cast aluminum. Finish: Powdercoat, color specified.

Fasteners: Primary fasteners shall be socketed and pinned tamperproof in design, stainless steel (SST) per ASTM F 879 unless otherwise indicated (see specific product installation/specifications).

148432B

Corkscrews 56" - 72" Deck

Handhold Panel: Solid color Permalene, color specified.

Spacer Tube: Fabricated from 6061-T6 aluminum 1 1/8" O.D. x 1 1/4". Finish: Powdercoat, color specified.

Fasteners: Primary fasteners shall be socketed and pinned tamperproof in design, stainless steel (SST) per ASTM F 879 unless otherwise indicated (see specific product installation/specifications).

Offset Hanger Clamp Assembly: Cast aluminum. Finish: Powdercoat, color specified.

126194A

CableCore Climbing Cable Fish Net Climber, 16"-32" Deck

CableCore Cable: Made from 3/16" 7-19 galvanized aircraft cable. Coated with U.V. stabilized polyvinyl chloride (PVC) measuring 1" in diameter, red in color.

Hub/Cover: Formed from 12 GA (.105") HRPO low carbon sheet steel. Finish: Powdercoat, color specified.

30" Cable: Made from 3/16" 7-19 galvanized aircraft cable. Coated with U.V. stabilized polyvinyl chloride (PVC), red in color.

Footer: Fabricated from 1.315" O.D. RS-20 (.080" - .090") galvanized steel tubing. Finish: Powdercoat, red in color.

Fasteners: Primary fasteners shall be socketed and pinned tamperproof in design, stainless steel (SST) per ASTM F 879 unless otherwise indicated (see specific product installation/specifications).

Half Clamp: Cast aluminum. Finish: Powdercoat, color specified.

Beam: Weldment comprised of formed 2.375" O.D. RS-20 (.095" - .105") galvanized steel tubing and 1/4" x 3" wide steel clamps. Finish: Powdercoat, color specified.

148434B

Loop Poles 56" - 72" Deck

Loop Pole: Weldment comprised of 1.900" O.D. RS-20 (.090"-.100") galvanized steel tubing, and 1.315" O.D. RS-20 (.080"-.090") galvanized steel tubing. Finish: Powdercoat, color specified.

Handhold Panel: Solid color Permalene, color specified.

Spacer Tube: Fabricated from 6061-T6 aluminum 1 1/8" O.D. x 1 1/4". Finish: Powdercoat, color specified.

Fasteners: Primary fasteners shall be socketed and pinned tamperproof in design, stainless steel (SST) per ASTM F 879 unless otherwise indicated (see specific product installation/specifications).

Offset Hanger Clamp Assembly: Cast aluminum. Finish: Powdercoat, color specified.

145624D

Vertical Ascent Climber 72" Deck

Panels: Solid color Permalene, color specified.

Spacer Tube: Made from 6061-T6 aluminum 7/8" O.D. Finish: Powdercoat, color specified.

Clamps: Cast aluminum. Finish: Powdercoat, color specified.

Fasteners: Primary fasteners shall be socketed and pinned tamperproof in design, stainless steel (SST) per ASTM F 879 unless otherwise indicated (see specific product installation/specifications).

Made from Polyester Resin. Handholds measure approx. 5 3/4" long x 2 1/4" wide x 1 3/4" high.

116249D

Vertical Ladders, Deck To Ground Vertical Ladder, 64" - 72" Deck

Vertical Ladder: Weldment comprised of 1.125" O.D. x 11 GA (.120") steel tubing, 1.029" O.D. RS-20 (.070" - .080") and 3/16" x 2" wide steel flat plates. Finish: TenderTuff, color specified.

Footer: Fabricated from 1.315" O.D. RS-20 (.080" - .090") galvanized steel tubing. Finish: Powdercoat, color specified.

Handhold Panel: Solid color Permalene, color specified.

Spacer Tube: Made from 6061-T6 aluminum 7/8" O.D. x 1 11/16". Finish: Powdercoat, color specified.

Fasteners: Primary fasteners shall be socketed and pinned tamperproof in design, stainless steel (SST) per ASTM F 879 unless otherwise indicated (see specific product installation/specifications).

Offset Hanger Clamp Assembly: Cast aluminum. Finish: Powdercoat, color specified.

148426B

Firepoles 56" - 72" Deck

Firepole: Weldment comprised of 1.900" O.D. RS-20 (.090"-.100") galvanized steel tubing, and 1.315" O.D. RS-20 (.080"-.090") galvanized steel tubing. Finish: Powdercoat, color specified.

Handhold Panel: Solid color Permalene, color specified.

Spacer Tube: Fabricated from 6061-T6 aluminum 1 1/8" O.D. x 1 1/4". Finish: Powdercoat, color specified.

Fasteners: Primary fasteners shall be socketed and pinned tamperproof in design, stainless steel (SST) per ASTM F 879 unless otherwise indicated (see specific product installation/specifications).

Offset Hanger Clamp Assembly: Cast aluminum. Finish: Powdercoat, color specified.

122837A

Single Post Swings 2-Place, Uncoated Chain

Post: See PlayBooster (PB) General Specifications.

Beam: Weldment comprised of 2.375" O.D. RS-40 (.130" - .140") galvanized steel tubing, 3" wide zinc-plated steel clamps and 1 1/4" housings w/bronze bushings. Finish: Powdercoat, color specified.

Half Clamp: Cast aluminum. Finish: Powdercoat, color specified.

Chain Spacer: Made from white nylon measuring .080" x .785" O.D..

Chain: Steel 3/16" straight link chain, 800 lb. working load limit. Finish: Hot galvanized.

Belt Seat: Molded from UV stabilized black EPDM rubber encapsulating a weldment comprised of a 22 GA (.029") spring stainless steel sheet and (4) .105 thick stainless steel washers. The belt seat elliptical shape measures 7" wide x 26" long x .700" thick.

Fasteners: Primary fasteners shall be socketed and pinned tamperproof in design, stainless steel (SST) per ASTM F 879 unless otherwise indicated (see specific product installation/specifications).

Warranty: You have our word.

Landscape Structures Inc. warrants that all playstructures and/or equipment sold will conform in kind and in quality to the specifications manual for the products identified in the Acknowledgement of Order and will be free of defects in manufacturing and material. Seller further warrants:

100-Year Limited Warranty for all stainless steel fasteners, aluminum posts, clamps, beams and caps, against structural failure due to corrosion/natural deterioration or manufacturing defects. This warranty does not include any cosmetic issues or wear and tear from normal use.

15-Year Limited Warranty for all plastic and steel components, including TuffTimbers™, against structural failure due to corrosion/natural deterioration or manufacturing defects. TenderTuffR-coating against structural failure due to natural deterioration or manufacturing defects. (Except Wiggle Ladders, Chain Ladders and Swing Chain). TuffTurfR against material or manufacturing defects when properly installed. CorocordR cable on Spacenet climbers against breakage.

10-Year Limited Warranty for all CoolToppersR structural steel frames and Mobius climbers against structural failure due to natural deterioration or manufacturing defects.

5-Year Limited Warranty for Corocord cables on Spacenet climbers and CoolToppersR fabric against natural deterioration or manufacturing defects. This warranty is limited to the design loads as stated in the specifications found in the technical information. The Natural Elements™ climbers exterior GFRC material, against structural failure due to natural deterioration or manufacturing defects.

3-Year Limited Warranty for all other parts, ie: CableCore™ products, Swing seats and hangers, Mobius climber handholds, Wiggle Ladders, Chain Ladders and Swing Chain, Track Ride trolleys and bumpers, all rocking equipment including Sway Fun™, PVC belting material, HealthBeat hydraulic cylinders, Seesaws, Wiggle Ring Bridge, etc. against failure due to corrosion/natural deterioration or manufacturing defects.

This warranty does not include any cosmetic issues or wear and tear from normal use.

The warranty stated above is valid only if the structures and/or equipment are erected in conformance with Landscape Structures' installation instructions and maintained according to the maintenance procedures furnished by Landscape Structures Inc. For a full text of the warranty, contact your local

sales representative.

QUOTE SHEET

Quote No: 34759-1-1-4

Date: 05-19-09
By: GDW

Rep Organization: SERVICE SUPPLY
Contact Person: PAM WILLIAMSON

Project Title: CABWAYLINGO STATE PARK

Location: DUNLOW, WV

Phone No:

Style: No-Structure Bury Type: Direct Bury

Age: 5-12 Unless Otherwise Noted.

QTY	NO.	DESCRIPTION
-----	-----	-------------

NON STANDARD PRODUCT CHARGES
INDEPENDENT COMPONENTS

SPRING RIDERS

- 1 120871B AIRPLANE 2-SEAT (PERM) D.B.
- 1 126378B FIRE ENGINE (PERMALENE) D.B.

PLAYTHINGS

- 1 146813A SKY RAIL CLIMBER, DB ONLY

NON STANDARD PRODUCT CHARGES

- 1 34759 S/S SLIDE

Weight & Cost of Independent Items
Concrete: 28.00 cu-ft, Footings: 6
Labor: 10,50 Man-Hours

Weight & Cost of Equipment

Estimated requirements for Equipment.

Concrete: 28.00 cu-ft, Footings: 6
Labor: 10.50 Man-Hours

Total Safety Zone Square Footage = 1102 sq ft

Estimated Man-Hours do not include site preparation.

This quote is valid for 90 days. Purchase orders submitted with an expired quote are subject to price changes.

Custom freight quotes are valid for 30. Expired custom freight quotes are subject to changes.

Signed _____ Date _____

Material Specifications
Quote: 34759-1-1-4.QSd
5/20/2009

General Specifications: Material: All materials shall be structurally sound and suitable for safe play. Durability shall be ensured on all steel parts by the use of time-tested coatings such as zinc plating, galvanizing, ProShield finish, TenderTuff coating, etc. Colors shall be specified.

Fasteners: Primary fasteners shall be socketed and pinned tamperproof in design, stainless steel (SST) per ASTM F879 unless otherwise indicated (see specific product installation/specifications). All primary fasteners shall include a locking patch-type material that will meet the minimum torque requirements of IFI-125. Manufacturer to provide special tools for pinned tamperproof fasteners.

TenderTuff Coating: Metal components to be TenderTuff-coated shall be thoroughly cleaned in a hot phosphatizing pressure washer, then primed with a water-based thermosetting solution. Primed parts shall be preheated prior to dipping in UV-stabilized, liquid polyvinyl chloride (PVC), then salt cured at approximately 400 degrees. The finished coating shall be approximately .080" thick at an 85 durometer hardness and have a matte finish. Four standard colors are available (brown only for HealthBeat). Not applicable for Evos.

ProShield Finish: All metal components with ProShield finish shall be thoroughly cleaned and phosphatized through a five-stage power washer. Parts are then thoroughly dried, preheated and processed through a set of automatic powder spray guns where a minimum .002" of epoxy primer is applied. The parts are allowed to cool and then pass through a second set of automatic powder spray guns. A minimum .004" of architectural-grade Super-Durable polyester TGIC powder is applied. The parts are oven-cured at 400 degrees F metal temperature for 10-minutes. The average ProShield film thickness is .006".

ProShield is formulated and tested per the following ASTM standards. Each color must meet or exceed the ratings listed below:

- Hardness (D3363) rating 2H
- Impact (D2794) rating minimum 80 inch-pounds
- Salt Fog Resistance (B117 and D1654) 4,000 hours and rating 7 or greater
- UV Exposure (G154, 340 bulb) 3,000 hours, rating delta E of 2, and 90 percent gloss retention
- Adhesion (D3359, Method B) rating 5B

The Paint Line shall employ a "checkered" adhesion test daily.

Eighteen standard colors are available.

Decks: All Tenderdecks shall be of modular design and have 5/16" diameter holes on the standing surface. There shall be a minimum of (4) slots in each face to accommodate face mounting of components. Tenderdecks shall be manufactured from a single piece of low carbon 12 GA (.105") sheet steel conforming to ASTM specification A-569. The sheet shall be perforated then flanged formed and reinforced as necessary to ensure structural integrity. The unit shall then be TenderTuff-coated brown only. Tenderdecks shall be designed

so that all sides are flush with the outside edge of the supporting posts. Not applicable for Evos, Weevos or HealthBeat.

Rotationally Molded Polyethylene Parts: These parts shall be molded using prime compounded linear low-density polyethylene with a tensile strength of 2500 psi per ASTM D638 and with color and UV-stabilizing additives. Wall thickness varies by product from .187" (3/16") to .312" (5/16"). Five standard colors are available (Black only for HealthBeat).

Permalene Parts: These parts shall be manufactured from 3/4" high-density polyethylene that has been specially formulated for optimum UV stability and color retention. Products shall meet or exceed density of .960 G/cc per ASTM D1505, tensile strength of 2400 PSI per ASTM D638. Five standard solid colors are available. Some Permalene parts are available in a two-color product with (2) .100" thick exterior layers over a .550" interior core of a contrasting color. Eight standard two-color options are available. Not applicable for Evos or HealthBeat.

Footings: Unless otherwise specified, the bury on all footings shall be 34" below Finished Grade (FG) on all in-ground play events/posts. Other types of anchoring are available upon request.

Hardware Packages: All shipments shall include individual component-specific hardware packages. Each hardware package shall be labeled with the part number, description, a component diagram showing the appropriate component, package weight, a bar code linking the hardware package to the job number, assembler's name, date and time the package was assembled, work center number, and work order number.

Installation Documentation: All shipments shall include a notebook or packet of order-specific, step-by-step instructions for assembly of each component, including equipment assembly diagrams, estimated hours for assembly, footing dimensions, concrete quantity for direct bury components, fall height information, area required information and detailed material specifications.

Packing List: All shipments shall include a packing list for each skid/container, specifying the part numbers and quantities on each skid or within each container.

Packaging: PlayBooster posts shall be individually packaged in sturdy, water-resistant, mar-resistant cardboard boxes. Other components shall be individually wrapped or bulk wrapped to provide protection during shipment. Small parts and hardware packages will be placed in crates for shipment. The components and crates are then shrink-wrapped to skids (pallets) to ensure secure shipping.

Maintenance Kit: An order-specific maintenance kit shall be provided for each structure order. The kit will include a notebook or packet with a second set of installation documents and order-specific maintenance documentation with recommendations on how often to inspect, what to look for and what to do to keep the equipment in like-new condition. The kit also includes touch-up primer, appropriate

color touch-up paint, sandpaper, appropriate color touch-up PVC, graffiti remover and additional installation tools for the tamperproof fasteners.

Material Specifications:

120871B

TuffRiders* TuffRider, 2-Seat Airplane Rider, Direct Bury

Spring: Fabricated from 5 5/8" diameter 13/16" tempered alloy steel coil, with cast aluminum wedges A356 alloy placed in each end of spring. Finish: Powdercoat, color specified.

Base Leg: Weldment comprised of 3 1/2" O.D. RS-20 (.120" - .130") galvanized steel tubing and 1/4" x 10" x 20 1/2" HRPO zinc plated steel mounting plate.

Footrest: Cast from 356-T6 aluminum alloy. Finish: Powdercoat, brown in color.

Brackets: Fabricated from formed 7 GA (.179") HRS. Finish: Powdercoat, brown in color.

Bolt Caps: Made from injection molded polypropylene, U.V. stabilized, white in color.

Fasteners: Primary fasteners shall be socketed and pinned tamperproof in design, stainless steel (SST) per ASTM F 879 unless otherwise indicated (see specific product installation/specifications).

Panels: Solid color Permalene seat, wing, and top panel yellow in color and tires black in color. Two color Permalene body panel, steering wheel and propeller yellow/blue in color and propeller tan/blue in color.

126378B

TuffRiders* TuffRider, 2-Seat Fire Engine Rider, Direct Bury

Panels: Solid color Permalene seat & ladder yellow in color, footrest spacer & side panel red in color, steering wheel & wheels black in color and top panel red in color. Two color Permalene fire engine body red/yellow in color and hose yellow/red in color.

Spring: Fabricated from 5 5/8" diameter 13/16" tempered alloy steel coil, with cast aluminum wedges A356 alloy placed in each end of spring. Finish: Powdercoat, color specified.

Base Leg: Weldment comprised of 3 1/2" O.D. RS-20 (.120" - .130") galvanized steel tubing and 1/4" x 10" x 20 1/2" HRPO zinc plated steel mounting plate.

Footrest: Cast from 356-T6 aluminum alloy. Finish: Powdercoat, brown in color.

Brackets: Fabricated from formed 7 GA (.179") HRS. Finish: Powdercoat, brown in color.

Bolt Caps: Made from injection molded polypropylene, U.V. stabilized, white in color.

Fasteners: Primary fasteners shall be socketed and pinned tamperproof in design, stainless steel (SST) per ASTM F 879 unless otherwise indicated (see specific product installation/specifications).

146813A

Sky Rail, (Available for Direct Bury Only) -

Sky Rail: Weldment comprised of 1.900" O.D. RS-20 (.090" - .100") galvanized steel tubing per ASTM A500 and 1.029" O.D. RS-20 (.070" - .080") galvanized steel tubing per ASTM A500. Finish: Powdercoat, color specified.

Coupling: ANSI 535.0 (Almag 35). Finish: Powdercoat, color specified.

Fasteners: Primary fasteners shall be socketed and pinned tamperproof in design, stainless steel (SST) per ASTM F 879 unless otherwise indicated (see specific product installation/specifications).

Warranty: You have our word.

Landscape Structures Inc. warrants that all playstructures and/or equipment sold will conform in kind and in quality to the specifications manual for the products identified in the Acknowledgement of Order and will be free of defects in manufacturing and material. Seller further warrants:

100-Year Limited Warranty for all stainless steel fasteners, aluminum posts, clamps, beams and caps, against structural failure due to corrosion/natural deterioration or manufacturing defects. This warranty does not include any cosmetic issues or wear and tear from normal use.

15-Year Limited Warranty for all plastic and steel components, including TuffTimberTM, against structural failure due to corrosion/natural deterioration or manufacturing defects. TenderTuff^R-coating against structural failure due to natural deterioration or manufacturing defects. (Except Wiggle Ladders, Chain Ladders and Swing Chain). TuffTurf^R against material or manufacturing defects when properly installed. Corocord^R cable on Spacenet climbers against breakage.

10-Year Limited Warranty for all CoolToppers^R structural steel frames and Mobius climbers against structural failure due to natural deterioration or manufacturing defects.

5-Year Limited Warranty for Corocord cables on Spacenet climbers and CoolToppers^R fabric against natural deterioration or manufacturing defects. This warranty is

limited to the design loads as stated in the specifications found in the technical information. The Natural Elements™ climbers exterior GFRC material, against structural failure due to natural deterioration or manufacturing defects.

3-Year Limited Warranty for all other parts, ie: CableCore™ products, Swing seats and hangers, Mobius climber handholds, Wiggle Ladders, Chain Ladders and Swing Chain, Track Ride trolleys and bumpers, all rocking equipment including Sway Fun™, PVC belting material, HealthBeat hydraulic cylinders, Seesaws, Wiggle Ring Bridge, etc. against failure due to corrosion/natural deterioration or manufacturing defects.

This warranty does not include any cosmetic issues or wear and tear from normal use.

The warranty stated above is valid only if the structures and/or equipment are erected in conformance with Landscape Structures' installation instructions and maintained according to the maintenance procedures furnished by Landscape Structures Inc. For a full text of the warranty, contact your local sales representative.