



State of West Virginia
 Department of Administration
 Purchasing Division
 2019 Washington Street East
 Post Office Box 50130
 Charleston, WV 25305-0130

Request for Quotation

RFQ NUMBER
BEDDING09

PAGE
7

ADDRESS CORRESPONDENCE TO ATTENTION OF
JO ANN ADKINS 304-558-8802

*222100951 724-834-4134
 SEALY BEDDING CO
 PO BOX 1821
 GREENSBURG PA 15601

VENDOR

SHIP TO

ALL STATE AGENCIES
 AND POLITICAL SUBDIVISIONS
 VARIOUS LOCALES AS INDICATED
 BY ORDER

DATE PRINTED	TERMS OF SALE	SHIP VIA	FOB	FREIGHT TERMS
08/28/2008				

BID OPENING DATE: 09/17/2008 BID OPENING TIME 01:30PM

LINE	QUANTITY	UOP	CAT NO	ITEM NUMBER	UNIT PRICE	AMOUNT
<p>AND THAT SUCH PENALTY WILL BE PAID TO THE CONTRACTING AGENCY OR DEDUCTED FROM ANY UNPAID BALANCE ON THE CONTRACT OR PURCHASE ORDER.</p> <p>BY SUBMISSION OF THIS CERTIFICATE, BIDDER AGREES TO DISCLOSE ANY REASONABLY REQUESTED INFORMATION TO THE PURCHASING DIVISION AND AUTHORIZES THE DEPARTMENT OF TAX AND REVENUE TO DISCLOSE TO THE DIRECTOR OF PURCHASING APPROPRIATE INFORMATION VERIFYING THAT BIDDER HAS PAID THE REQUIRED BUSINESS TAXES, PROVIDED THAT SUCH INFORMATION DOES NOT CONTAIN THE AMOUNTS OF TAXES PAID NOR ANY OTHER INFORMATION DEEMED BY THE TAX COMMISSIONER TO BE CONFIDENTIAL.</p> <p>UNDER PENALTY OF LAW FOR FALSE SWEARING (WEST VIRGINIA CODE 61-5-3), BIDDER HEREBY CERTIFIES THAT THIS CERTIFICATE IS TRUE AND ACCURATE IN ALL RESPECTS; AND THAT IF A CONTRACT IS ISSUED TO BIDDER AND IF ANYTHING CONTAINED WITHIN THIS CERTIFICATE CHANGES DURING THE TERM OF THE CONTRACT, BIDDER WILL NOTIFY THE PURCHASING DIVISION IN WRITING IMMEDIATELY.</p>						

Bidder: Sealy, Inc.

Date: September 25, 2008

Signed: *David McLaw*

Title: Sealy Contract Sales Representative

RECEIVED

2008 SEP 22 A 10:01

PURCHASING DIVISION
STATE OF WV

* CHECK ANY COMBINATION OF PREFERENCE CONSIDERATION(S) IN EITHER "A" OR "B", OR BOTH "A" AND "B" WHICH YOU

SEE REVERSE SIDE FOR TERMS AND CONDITIONS

SIGNATURE	TELEPHONE	DATE
<i>David McLaw</i>		9-18-08
TITLE	FEIN	ADDRESS CHANGES TO BE NOTED ABOVE
<i>Sales Rep</i>		

WHEN RESPONDING TO RFQ, INSERT NAME AND ADDRESS IN SPACE ABOVE LABELED 'VENDOR'

GENERAL TERMS & CONDITIONS
REQUEST FOR QUOTATION (RFQ) AND REQUEST FOR PROPOSAL (RFP)

1. Awards will be made in the best interest of the State of West Virginia.
2. The State may accept or reject in part, or in whole, any bid.
3. All quotations are governed by the *West Virginia Code* and the *Legislative Rules* of the Purchasing Division.
4. Prior to any award, the apparent successful vendor must be properly registered with the Purchasing Division and have paid the required \$125 fee.
5. All services performed or goods delivered under State Purchase Order/Contracts are to be continued for the term of the Purchase Order/Contracts, contingent upon funds being appropriated by the Legislature or otherwise being made available. In the event funds are not appropriated or otherwise available for these services or goods, this Purchase Order/Contract becomes void and of no effect after June 30.
6. Payment may only be made after the delivery and acceptance of goods or services.
7. Interest may be paid for late payment in accordance with the *West Virginia Code*.
8. Vendor preference will be granted upon written request in accordance with the *West Virginia Code*.
9. The State of West Virginia is exempt from federal and state taxes and will not pay or reimburse such taxes.
10. The Director of Purchasing may cancel any Purchase Order/Contract upon 30 days written notice to the seller.
11. The laws of the State of West Virginia and the *Legislative Rules* of the Purchasing Division shall govern all rights and duties under the Contract, including without limitation the validity of this Purchase Order/Contract.
12. Any reference to automatic renewal is hereby deleted. The Contract may be renewed only upon mutual written agreement of the parties.
13. **BANKRUPTCY:** In the event the vendor/contractor files for bankruptcy protection, this Contract may be deemed null and void, and terminated without further order.
14. **HIPAA BUSINESS ASSOCIATE ADDENDUM:** The West Virginia State Government HIPAA Business Associate Addendum (BAA), approved by the Attorney General, and available online at the Purchasing Division's web site (<http://www.state.wv.us/admin/purchase/vrc/hipaa.htm>) is hereby made part of the agreement. Provided that, the Agency meets the definition of a Cover Entity (45 CFR §160.103) and will be disclosing Protected Health Information (45 CFR §160.103) to the vendor.
15. **WEST VIRGINIA ALCOHOL & DRUG-FREE WORKPLACE ACT:** If this Contract constitutes a public improvement construction contract as set forth in Article 1D, Chapter 21 of the West Virginia Code ("The West Virginia Alcohol and Drug-Free Workplace Act"), then the following language shall hereby become part of this Contract: "The contractor and its subcontractors shall implement and maintain a written drug-free workplace policy in compliance with the West Virginia Alcohol and Drug-Free Workplace Act, as set forth in Article 1D, Chapter 21 of the West Virginia Code. The contractor and its subcontractors shall provide a sworn statement in writing, under the penalties of perjury, that they maintain a valid drug-free work place policy in compliance with the West Virginia and Drug-Free Workplace Act. It is understood and agreed that this Contract shall be cancelled by the awarding authority if the Contractor: 1) Fails to implement its drug-free workplace policy; 2) Fails to provide information regarding implementation of the contractor's drug-free workplace policy at the request of the public authority; or 3) Provides to the public authority false information regarding the contractor's drug-free workplace policy."

INSTRUCTIONS TO BIDDERS

1. Use the quotation forms provided by the Purchasing Division.
2. **SPECIFICATIONS:** Items offered must be in compliance with the specifications. Any deviation from the specifications must be clearly indicated by the bidder. Alternates offered by the bidder as **EQUAL** to the specifications must be clearly defined. A bidder offering an alternate should attach complete specifications and literature to the bid. The Purchasing Division may waive minor deviations to specifications.
3. Complete all sections of the quotation form.
4. Unit prices shall prevail in case of discrepancy.
5. All quotations are considered F.O.B. destination unless alternate shipping terms are clearly identified in the quotation.
6. **BID SUBMISSION:** All quotations must be delivered by the bidder to the office listed below prior to the date and time of the bid opening. Failure of the bidder to deliver the quotations on time will result in bid disqualifications: Department of Administration, Purchasing Division, 2019 Washington Street East, P.O. Box 50130, Charleston, WV 25305-0130



State of West Virginia
 Department of Administration
 Purchasing Division
 2019 Washington Street East
 Post Office Box 50130
 Charleston, WV 25305-0130

Request for Quotation

RFQ NUMBER
BEDDING09

PAGE
9

ADDRESS CORRESPONDENCE TO ATTENTION OF
JO ANN ADKINS
304-558-8802

*222100951 724-834-4134

SEALY BEDDING CO
 PO BOX 1821

GREENSBURG PA 15601

RFQ 0022100951

SHIP TO

ALL STATE AGENCIES
 AND POLITICAL SUBDIVISIONS
 VARIOUS LOCALES AS INDICATED
 BY ORDER

DATE PRINTED 08/28/2008	TERMS OF SALE	SHIP VIA	FOB	FREIGHT TERMS
BID OPENING DATE: 09/17/2008		BID OPENING TIME 01:30PM		

LINE	QUANTITY	UOP	CAT. NO.	ITEM NUMBER	UNIT PRICE	AMOUNT

CONTACT PERSON (PLEASE PRINT CLEARLY):						
David M. Davis Sealy Contract Sales Representataive T-724-834-4134 F-724-834-4535 e-mail Dadrea@AOL.Com						
***** THIS IS THE END OF RFQ BEDDING09 ***** TOTAL:						

SEE REVERSE SIDE FOR TERMS AND CONDITIONS

SIGNATURE <i>David M. Davis</i>	TELEPHONE 724-834-4134
TITLE <i>Sales Rep.</i>	FEIN 34-1439399

ADDRESS CHANGES TO BE NOTED ABOVE

WHEN RESPONDING TO RFQ, INSERT NAME AND ADDRESS IN SPACE ABOVE LABELED 'VENDOR'

EXHIBIT 10

REQUISITION NO.:

ADDENDUM ACKNOWLEDGEMENT

I HEREBY ACKNOWLEDGE RECEIPT OF THE FOLLOWING CHECKED
ADDENDUM(S) AND HAVE MADE THE NECESSARY REVISIONS TO MY
PROPOSAL, PLANS AND/OR SPECIFICATION, ETC.

ADDENDUM NO.'S:

NO. 1 ..✓.....

NO. 2 ..✓.....

NO. 3 ..✓.....

NO. 4

NO. 5

I UNDERSTAND THAT FAILURE TO CONFIRM THE RECEIPT OF THE
ADDENDUM(S) MAY BE CAUSE FOR REJECTION OF BIDS. VENDOR
MUST CLEARLY UNDERSTAND THAT ANY VERBAL
REPRESENTATION MADE OR ASSUMED TO BE MADE DURING ANY
ORAL DISCUSSION HELD BETWEEN VENDOR'S REPRESENTATIVES
AND ANY STATE PERSONNEL IS NOT BINDING. ONLY THE
INFORMATION ISSUED IN WRITING AND ADDED TO THE
SPECIFICATIONS BY AN OFFICIAL ADDENDUM IS BINDING.

.....*David M. Davis*.....

SIGNATURE

.....*Sealy, Inc*.....

COMPANY

.....*9-25-08*.....

DATE



David M. Davis, Sealy Contract Representative
PO Box 1821 Greensburg PA 15601
T-724-834-4234 F-724-834-4535 e-mail Dadrea@AOL.Com

September 16, 2008,

Jo Ann Adkins
State of West Virginia
Department of Administration
Purchasing Division
2019 Washington St, E
Charleston, WV 25305-0130

Re: RFQ Bedding 09 Alternate Bid

Dear Ms. Adkins,

Thank you for the opportunity to participate in the West Virginia State Bedding Contract.

Sealy is a national leader in the committee to Green. *Environmental Initiatives* to improve sustainability of Sealy products include wood, steel and foams. Sealy has been using *Lean Manufacturing* methods since 2004. Our Environmental Initiatives statement is included.

Sealy meets or exceeds the bedding spec. Sealy uses both the patented Posturepedic offset coil that is double heat treated and Bonnel Coil per spec. All box springs in the RFQ are the Sealy Contract Torsion Bar Shock Absorber Box Spring. Box Springs quoted are the standard 9" heights; 7" box springs are also available at no additional cost. Sealy specification sheets for all items are included with this bid.

The item prices include delivery costs. Typical delivery is 3 weeks. All orders must be faxed to 724-834-4535 or e-mailed to Dadrea@AOL.Com. Sample items are available for bid evaluation.

All Sealy mattresses and box springs comply with 16 CRF 1633 (CAL TB 603), the federal fire standard.

As a courtesy, pricing for Contract Bed Frames & Bed Bases, delivered on Sealy trucks with the bedding, is included.

Best regards,

A handwritten signature in cursive script that reads "David M. Davis".

David M. Davis



David M. Davis, Sealy Contract Representative
PO Box 1821 Greensburg, PA 15601
T-724-834-4134 F-724-834-4535 e-mail Dadrea@AOL.Com

September 19, 2008

Jo Ann Adkins
State of West Virginia
Department of Administration
Purchasing Division
2019 Washington Street E
Charleston, WV 25305-0130

RE: RFQ BEDDING09 Additional Product

Dear Ms. Adkins,

As a courtesy, Sealy Bed Frames and Bed Bases are included. The steel market is volatile and pricing is effective for only 2008. Pricing is typical for hospitality properties. Pricing includes freight and tailgate delivery on Sealy truck at the time of bedding delivery.

Craft-Lock frames, manufactures by Mantua Bed Frames, require no tools for assembly. Strong design features include Wedge-lock, which becomes stronger with increased weight; double rail center supports; and recessed legs. ADA styles are available.

Sincerely,
A handwritten signature in cursive script that reads "David Davis".

David Davis

Bedding09
Pricing Pages

Category 1		Style (UHS) Ultra Hospitality Sets	
size	1-6 sets	7+-sets	Dynsty CSS Plush
	Single-sided	Single-sided	
38 X 75	\$ 271.00	\$ 268.00	
38 X 80	\$ 281.00	\$ 279.00	
53 x 75	\$ 338.00	\$ 335.00	
53 x 80	\$ 352.00	\$ 350.00	
60 x 80	\$ 384.00	\$ 382.00	
76 x 80	\$ 509.00	\$ 506.00	

size	1-6 Mat	7+-Mat	Dynsty CSS Plush
	Single-sided	Single-sided	
38 X 75	\$ 193.00	\$ 190.00	
38 X 80	\$ 200.00	\$ 198.00	
53 x 75	\$ 244.00	\$ 242.00	
53 x 80	\$ 252.00	\$ 249.00	
60 x 80	\$ 272.00	\$ 270.00	
76 x 80	\$ 346.00	\$ 344.00	

size	1-6 Box SP	7+Box Sp	Dynsty CSS Plush
	Single-sided	Single-sided	
38 X 75	\$ 83.00	\$ 81.00	
38 X 80	\$ 87.00	\$ 84.00	
53 x 75	\$ 99.00	\$ 96.00	
53 x 80	\$ 105.00	\$ 103.00	
60 x 80	\$ 112.00	\$ 110.00	
76 x 80	\$ 268.00	\$ 265.00	

Category 1		Style (PBS) Ultra Hospitality Sets	
size	1-6 sets	7+-sets	Celestial CSS Plush
	Single-sided	Single-sided	
38 X 75	\$ 257.00	\$ 255.00	
38 X 80	\$ 268.00	\$ 265.00	
53 x 75	\$ 323.00	\$ 321.00	
53 x 80	\$ 336.00	\$ 333.00	
60 x 80	\$ 367.00	\$ 364.00	
76 x 80	\$ 487.00	\$ 485.00	

size	1-6 Mat	7+-Mat	Celestial CSS Plush
	Single-sided	Single-sided	
38 X 75	\$ 177.00	\$ 175.00	
38 X 80	\$ 183.00	\$ 181.00	
53 x 75	\$ 227.00	\$ 224.00	
53 x 80	\$ 233.00	\$ 230.00	
60 x 80	\$ 256.00	\$ 254.00	
76 x 80	\$ 318.00	\$ 316.00	

size	1-6 Box S	7+-Box Sp	Celestial CSS Plush
	Single-sided	Single-sided	
38 X 75	\$ 86.00	\$ 83.00	
38 X 80	\$ 90.00	\$ 87.00	
53 x 75	\$ 102.00	\$ 100.00	
53 x 80	\$ 108.00	\$ 106.00	
60 x 80	\$ 115.00	\$ 113.00	
76 x 80	\$ 175.00	\$ 172.00	

Category 1		Style (SHS) Ultra Hospitality Sets	
size	1-6 sets	7+-sets	Hotel Supreme Cusion Firm
	Single-sided	Single-sided	
38 X 75	\$ 207.00	\$ 205.00	
38 X 80	\$ 216.00	\$ 214.00	
53 x 75	\$ 254.00	\$ 252.00	
53 x 80	\$ 269.00	\$ 266.00	
60 x 80	\$ 298.00	\$ 295.00	
76 x 80	\$ 401.00	\$ 398.00	

size	1-6 Mat	7+-Mat	Hotel Supreme CSS Plush
	Single-sided	Single-sided	
38 X 75	\$ 144.00	\$ 142.00	
38 X 80	\$ 151.00	\$ 148.00	
53 x 75	\$ 175.00	\$ 173.00	
53 x 80	\$ 187.00	\$ 185.00	
60 x 80	\$ 206.00	\$ 204.00	
76 x 80	\$ 269.00	\$ 266.00	

Category 1		Style (SHS) Ultra Hospitality Sets	
size	1-6 Box S	7+-Box Sp	Hotel Supreme Cusion Firm
38 X 75	\$ 68.00	\$ 66.00	
38 X 80	\$ 71.00	\$ 74.00	
53 x 75	\$ 85.00	\$ 82.00	
53 x 80	\$ 86.00	\$ 83.00	
60 x 80	\$ 97.00	\$ 94.00	
76 x 80	\$ 137.00	\$ 135.00	

Category II		Style (NHI) Nursing Home Innerspring	
size	1-6 sets	7+-sets	Banyan Cusion Firm
	Single-sided	Single-sided	
38 X 75	\$ 244.00	\$ 242.00	
38 X 80	\$ 257.00	\$ 255.00	
53 x 75	\$ 302.00	\$ 299.00	

	1-6 Mat	7+-Mat	Banyan Cusion Firm
size	Single-sided	Single-sided	
38 X 75	\$ 164.00	\$ 162.00	
38 X 80	\$ 173.00	\$ 171.00	
53 x 75	\$ 205.00	\$ 202.00	

	1-6 Box S	7+-Box Sp	Banyan Cusion Firm
size	Single-sided	Single-sided	
38 X 75	\$ 91.00	\$ 89.00	
38 X 80	\$ 98.00	\$ 95.00	
53 x 75	\$ 112.00	\$ 111.00	

Category II Style (EBI) Electric Bed Innerspring

NO BID

Category II Style (PRS) 6" Pressure Relief

NO BID

Category II Style (PRS) 5" Pressure Relief Foam

NO BID

Category III Style (DIM) Dormitory Innerspring Mattress

size	1-6 mat	7+-Mat	Hotel Supreme Cusion Firm
36 X 75	No Bid	No Bid	
36 X 80	No Bid	No Bid	
38 X 75	\$ 133.00	\$ 130.00	
38 X 80	\$ 137.00	\$ 134.00	

Category III Style (DM6) 6" Resilient Foam Mattress

NO BID

Category IV Style (DM5) 5" High Resilient Roam Mattress

NO BID

Category IV Style (DM5) 5" High Resilient Foam Mattress

NO BID

Category IV Style (DM4) 4" High Resilient Roam Mattress

NO BID

**Category V
Pillows**

NO BID

Fax No. 724-834-4535
Telephone No 724-834-4134
Toll Free No

Contact Coordinator: David Davis

Signature: *David M Davis*

e-Mail: Dadrea@AOL.Com

Date: 9-25-08

West Virginia State Bedding 2008 Contract

Category 1

Hospitality: Mattress, Box Spring (available as 7" or 9" height) or sets

Warranty: 10 years, non-prorated 10/10

Delivery: No extra charge

Minimum order charge: if applicable, included with pricing sheet

UHS Ultra Hospitality Sets

Mattress: Sealy Posturepedic CSS Dynasty Plush

Mattress ONLY Item #503123

Size Twin-30 Twin XLI -31 Full - 40 Full XL-41 Queen - 51 King- 63

Drop Measure: 12 ¼" Sealy Posturepedic Innerspring, 736 queen coil count unit, extends to all sides of the mattress with 5-turn, 14 gauge steel wire, triple offset, PostureTech®, made with double-tempered steel.* Each cylindrical coil is joined by the helical. All ends are mechanically crimped at each termination point to prevent spin out.

***TEMPERING:** unit is twice tempered. First each coil is individually tempered and then the entire assembled unit is stress relieved at 450 °F

PostureTech® Coil
Helical

215,000 to 250,000 psi
240,000 to 280 psi

Unicase Edge and Base:

Unicased™ Edge and base, with support channels, surround and lock into the entire perimeter of the mattress innerspring system and is thermo bonded to the UniCased™ Base with two-stage deflection for greater sleeping surface, uniform edge to edge, consistent firm seating around entire perimeter. Motion dampening and enhanced stability features are included. There are four (4) handles.

Insulation and Upholstery: A STAYTRUE™ quilt top consists of 1.0 oz. FlameGuard™ Fiber Lux® Fiber, 1 ½ X ½ " SuperSoft Sealy Foam®, convoluted Sealy Foam, ½" Sealy Foam® with Swift Tac Topper, Comfort layers consist of STAYTRUE™ 1 ¼" X ½" convoluted Sealy Foam®, 2" X 1" Pressure Point Materials and Versare insulator. A DuraFiber™ pad of 2.0 oz/sq ft wt is placed on each side of the spring. This pad consists of resin treated shredded textile clippings and/or natural fibers and prevents materials from pocketing into the coils. The insulator pad is fastened to the unit at six (6) distinct points. The spring unit for a smooth, tailored and straight finishes holds out the corners.

The multi-needle quilted construction is a composite consisting of a non-woven fabric backing, ¾" polyurethane foam.

Identification: Each mattress has a law label attached in compliance with legal requirements of the state in which it is manufactured. Manufacturing date, location and product and warranty codes are included.

Box Spring: 9" Standard Item # 603074 7" 603076

Warranty is ten (10) years non-prorated. 10/10

Size:

Twin-30 Twin XL-31 Full-40 FullXL-41 Queen-51 King - 61

Dust Cover:

The bottom of the box spring is enclosed by a non-woven, seamless sheeting which is staples to the perimeter of the frame.

Identification: Each Box Spring has a law label attached in compliance with legal requirements of the state in which it is manufactures. Manufacturing date, location and

Box spring:

Supporting the mattress is a fully functional Schock Abzorbler™ Plus Box Spring with weight deflection capabilities that extend mattress ComfortLife®. Metal Corner guards are installed for protection and safety. Torsion Modulars are 9 gauge steel and 3 gauge border rod.

The foundation frame is constructed of seasoned or kiln-dried spruce or its equivalent and is warp resistant. The foundation unit is permanently attached to the frame. The frame is square and flat with cross slats plus end slats. All corners are cut with a 2 3/8" radius and the bottom edges are chamfered with a 1/8 bevel.

All frames have center support rails. All end rails are reinforced with stiffeners to add to the rigidity of the frame. All wood stock is 1 1/16" minimum finished dimension. The end rails are 3.5" wide; the center rail and cross slats are 2.5" wide.

The frame is securely nailed or stapled and comes either glued or braced for diagonal rigidity.

Category 1

Mattress: Hotel Supreme

Hospitality: Mattress, Box Spring (available as 7" or 9" height) or sets

Warranty: 5 years, prorated 1/5

Delivery: No extra charge

Minimum order charge: if applicable, included with pricing sheet

SHS Standard Hospitality Set

Mattress: Hotel Supreme Cushion Firm

Mattress ONLY Item #414702

Size Twin-30 Twin XL -31 Full - 40 Full XL-41 Queen - 51 King- 63

Drop Measure: 312 Bonnell Full Innerspring, 312 full coil count unit, extends to all sides of the mattress with 5-turn, 13 gauge steel

StayTrue® Base

Base offers stability and added support,, 6 gauge borer wire

Insulation and Upholstery:

Quilt top: 1 oz. Sealy Fiber, 1 ½" SealyFoam®

Upholstery Layers: 1" SealyFoam®, ½" High Performance SealyFoam®, Double layer DuraCushion®Pad

Mattress Fabric: Style 3121, 53% Viscose, 47% Polyester Fire Retardancy 16CFR-1632.6

Border Fabric: Style 3124, 58% Viscose, 42% Polyester Fire Retardancy 12CFR-1632.6

Identification: Each mattress has a law label attached in compliance with legal requirements of the state in which it is manufactures. Manufacturing date, location and product and warranty codes are included.

Category II
Nursing Home

Mattress: Banyan Cushion Firm

Hospitality: Mattress, Box Spring (available as 5.5", 7" or 9" height) or sets

Warranty: ten (10) years, non-prorated 10/10

Delivery: No extra charge

Minimum order charge: if applicable, included with pricing sheet

NHI Nursing Home Innerspring

Mattress ONLY Item #503443

Size Twin-30 Twin XL -31 Full - 40

Drop Measure: 10"

Insulation and Upholstery:

Quilt top: 1 oz. Sealy Fiber, 1 ½" SealyFoam®

Upholstery Layers: 1" SealyFoam®, ½" High Performance SealyFoam®, Double layer
DuraCushion®Pad

Mattress Fabric: NONO~Pel™ Style 3202 Chelsea Somerset

Border Fabric: NONO~Pel™ Style 3202 Chelsea Somerset

Spec sheet attached

Identification: Each mattress has a law label attached in compliance with legal requirements of the state in which it is manufactured. Manufacturing date, location and product and warranty codes are included.



nano~tex™

INTELLIGENT FABRICS. BETTER LIVING.

NANO~PEL™ Technology Testing Document
Product: Polyester / Polypropylene Ticking
Production Performance Monitoring

All production lots of NANO~PEL™ technology treated fabric must be evaluated in such fashion as to ensure consistent performance of the NANO~TEX™ application.

Water and Oil Repellency

Each lot must be tested and perform as follows:

Original

<u>Test</u>	<u>Specification</u>	<u>Test Method</u>
Spray	90	AATCC 22
Oil Repellency	4	AATCC 118
Water / Alcohol	>6	N. Tex Method

Category III
Dormitory Innerspring

Style DIM

Mattress: Hotel Supreme Firm

Dormitory: Mattress

Warranty: one (1) years, non-prorated 1/1

Delivery: No extra charge

Minimum order charge: if applicable, included with pricing sheet

Dormitory mattress ONLY

Style # 514808

Size Twin-30 Twin XL -31 Full - 40
 38 X 75 38 X 80 54 X 75

Drop Measure: 6 1/2"

Insulation and Upholstery:

Quilt top: 1 oz. Sealy Fiber, 1 1/2" SealyFoam®

Upholstery Layers: 1/4" SealyFoam®, Miracle Mesh, DuraCushion®Pad

Mattress Fabric: NONO~Pel™ Style 3202 Chelsea Somerset

Border Fabric: NONO~Pel™ Style 3202 Chelsea Somerset

Spec sheet attached

Innerspring: 312 Bonnel, 5 turn, 13 gauge StayTrue® Base for stability and added support, 6 gauge wire

Identification: Each mattress has a law label attached in compliance with legal requirements of the state in which it is manufactured. Manufacturing date, location and product and warranty codes are included.

Box Spring: 9" Standard Item # 603074 7" 603076

Warranty is ten (10) years non-prorated. 10/10

Size:

Twin-30 Twin XL-31 Full-40

Dust Cover:

The bottom of the box spring is enclosed by a non-woven, seamless sheeting which is stapled to the perimeter of the frame.

Identification: Each Box Spring has a law label attached in compliance with legal requirements of the state in which it is manufactured. Manufacturing date, location and

Box spring:

Supporting the mattress is a fully functional Schock AbzorbTM Plus Box Spring with weight deflection capabilities that extend mattress ComfortLife[®]. Metal Corner guards are installed for protection and safety. Torsion Modulators are 9 gauge steel and 3 gauge border rod.

The foundation frame is constructed of seasoned or kiln-dried spruce or its equivalent and is warp resistant. The foundation unit is permanently attached to the frame. The frame is square and flat with cross slats plus end slats. All corners are cut with a 2 3/8" radius and the bottom edges are chamfered with a 1/8 bevel.

All frames have center support rails. All end rails are reinforced with stiffeners to add to the rigidity of the frame. All wood stock is 1 1/16" minimum finished dimension. The end rails are 3.5" wide; the center rail and cross slats are 2.5" wide.

The frame is securely nailed or stapled and comes either glued or braced for diagonal rigidity.

SHOCK ABZZORBER PLUS™ BOX SPRING

Sealy's patented, fully functional Shock Abzzorber Plus™ Box Spring, enhances comfort by amplifying perimeter firmness and extends Comfort Life® by deflecting weight from the mattress. 20% more steel provides better support than before.

Available in 9" and 7" heights.

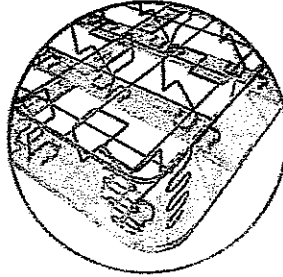

Patented Shock Abzzorber Plus™ Box Spring elements interlock to provide exceptional strength, while supporting and deflecting weight from the mattress.

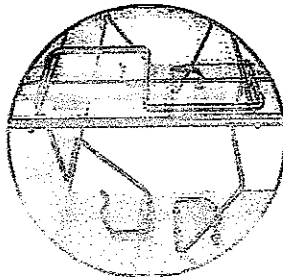

At the heart of the Shock Abzzorber Plus™ Box Spring are Torsion modules, which provide both the flex and the support to the box spring.

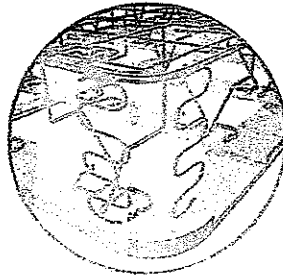

Dual corner modules are uniquely designed to provide additional stability to the box spring.

Box Spring: 9" Standard Item # 603074 7" 603076

Warranty is ten (10) years non-prorated. 10/10

Size:

Twin-30 Twin XL-31 Full-40 FullXL-41 Queen -51 King - 61

Dust Cover:

The bottom of the box spring is enclosed by a non-woven, seamless sheeting which is staples to the perimeter of the frame.

Identification: Each Box Spring has a law label attached in compliance with legal requirements of the state in which it is manufactures. Manufacturing date, location and

Box spring:

Supporting the mattress is a fully functional Schock Abzzorber™ Plus Box Spring with weight deflection capabilities that extend mattress ComfortLife®. Metal Corner guards are installed for protection and safety. Torsion Modulers are 9 gauge steel and 3 gauge border rod.

The foundation frame is constructed of seasoned or kiln-dried spruce or its equivalent and is warp resistant. The foundation unit is permanently attached to the frame. The frame is square and flat with cross slats plus end slats. All corners are cut with a 2 3/8" radius and the bottom edges are chamfered with a 1/8 bevel.

All frames have center support rails. All end rails are reinforced with stiffeners to add to the rigidity of the frame. All wood stock is 1 1/16" minimum finished dimension. The end rails are 3.5" wide; the center rail and cross slats are 2.5" wide.

The frame is securely nailed or stapled and comes either glued or braced for diagonal rigidity.

SHOCK ABZZORBER PLUS™ BOX SPRING

Sealy's patented, fully functional Shock Abzzorber Plus™ Box Spring, enhances comfort by amplifying perimeter firmness and extends Comfort Life® by deflecting weight from the mattress. 20% more steel provides better support than before.

Available in 9" and 7" heights.

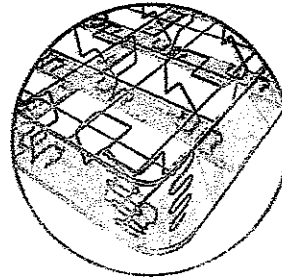

Patented Shock Abzzorber Plus™ Box Spring elements interlock to provide exceptional strength, while supporting and deflecting weight from the mattress.

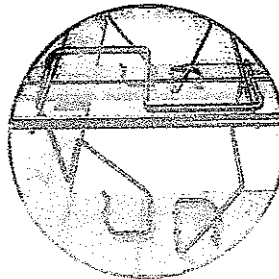

At the heart of the Shock Abzzorber Plus™ Box Spring are Torsion modules, which provide both the flex and the support to the box spring.

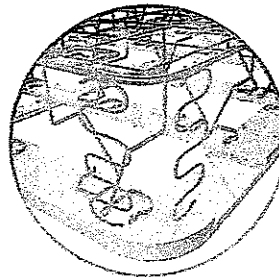

Dual corner modules are uniquely designed to provide additional stability to the box spring.

PBS Premium Hospitality Set

Mattress: Celestial CSS Plush

Mattress only Item #503105

Sizes Twin-31, twin-XL-31 Full-40 Full XL-41 Queen-51 King-63

Drop Measurement: 11.5 inches

Sealy Posturepedic Innerspring 600 coil count unit, extends to all sides of the mattress with 5-turn, 14 gauge high carbon steel wire, triple offset, 600 PostureTech®, made with heavy gauge double-tempered steel*. Each cylindrical coil is joined by the helical. All ends are mechanically crimped at each termination point to prevent spinout.

***Tempering:** Unit is twice-tempered. First each coil is individually tempered and then the entire assembled unit is stress relieved at 450°F. The tensile strength of the components are:

PostureTech Coils	215,000 to 250,000 psi
Helicals	240,000 to 280,000 psi

Unicased™ Edge and base, with support channels which surround and lock into the entire perimeter of the mattress innerspring system and is thermo-bonded to the UniCased™ Base with two-stage deflection for greater sleeping surface, uniform edge to edge, consistent firm seating around entire perimeter. There are no handles.

Insulation and Upholstery: A STAYTRUE™ quilt Top shall consist of 1.0 oz. FlameGuard™ FiberLux®Fiber, 1" SuperSoft Sealy Foam® (1.3 density) and ½" SealyFoam® (1.3 density). Comfort layers consist of ½" SealyFoam® 2' X 1" Pressure Point Materials (1.2 lb densit) and a mesh insulator.

A Dura Fiber™ pad of 2.0 oz/sq ft is placed on each side over the spring. This pad consists of resin treated shredded textile clippings and/or natural fibers and prevents filling materials from pocketing into the coils. The insulator pad is fastened to the unit at six distinct points. The corners are held out by the spring unit so that the tailor smooth and straight.

The multi-needle quilted construction is a composite consisting of a non-woven fabric backing, ¾ polyurethane foam

Identification: Each mattress has a law label attached in compliance with legal requirements of the state in which it is manufactured, manufacturing date, location, and product and warranty codes are included.

Box Spring: 9" Standard Item # 603074 7" 603076

Warranty is ten (10) years non-prorated. 10/10

Size:

Twin-30 Twin XL-31 Full-40 FullXL-41 Queen -51 King - 61

Dust Cover:

The bottom of the box spring is enclosed by a non-woven, seamless sheeting which is staples to the perimeter of the frame.

Identification: Each Box Spring has a law label attached in compliance with legal requirements of the state in which it is manufactures. Manufacturing date, location and

Box spring:

Supporting the mattress is a fully functional Schock Abzzorber™ Plus Box Spring with weight deflection capabilities that extend mattress ComfortLife®. Metal Corner guards are installed for protection and safety. Torsion Modulares are 9 gauge steel and 3 gauge border rod.

The foundation frame is constructed of seasoned or kiln-dried spruce or its equivalent and is warp resistant. The foundation unit is permanently attached to the frame. The frame is square and flat with cross slats plus end slats. All corners are cut with a 2 3/8" radius and the bottom edges are chamfered with a 1/8 bevel.

All frames have center support rails. All end rails are reinforced with stiffeners to add to the rigidity of the frame. All wood stock is 1 1/16" minimum finished dimension. The end rails are 3.5" wide; the center rail and cross slats are 2.5" wide.

The frame is securely nailed or stapled and comes either glued or braced for diagonal rigidity.

SHOCK ABZZORBER PLUS™ BOX SPRING

Sealy's patented, fully functional Shock Abzzorber Plus™ Box Spring, enhances comfort by amplifying perimeter firmness and extends Comfort Life® by deflecting weight from the mattress. 20% more steel provides better support than before.

Available in 9" and 7" heights.

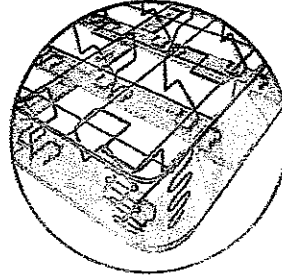

Patented Shock Abzzorber Plus™ Box Spring elements interlock to provide exceptional strength, while supporting and deflecting weight from the mattress.

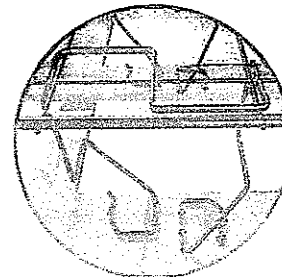

At the heart of the Shock Abzzorber Plus™ Box Spring are Torsion modules, which provide both the flex and the support to the box spring.

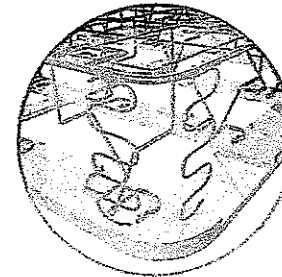

Dual corner modules are uniquely designed to provide additional stability to the box spring.

SHOCK ABZZORBER PLUS™ BOX SPRING

Sealy's patented, fully functional Shock Abzzorber Plus™ Box Spring, enhances comfort by amplifying perimeter firmness and extends Comfort Life® by deflecting weight from the mattress. 20% more steel provides better support than before.

Available in 9" and 7" heights.

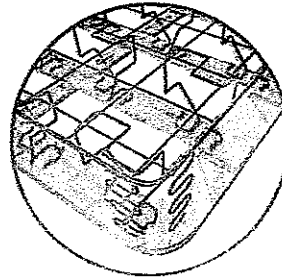

Patented Shock Abzzorber Plus™ Box Spring elements interlock to provide exceptional strength, while supporting and deflecting weight from the mattress.

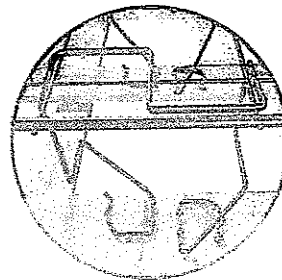

At the heart of the Shock Abzzorber Plus™ Box Spring are Torsion modules, which provide both the flex and the support to the box spring.

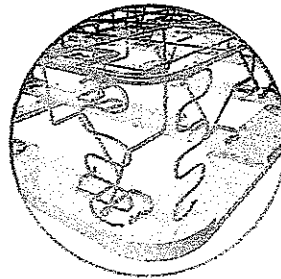

Dual corner modules are uniquely designed to provide additional stability to the box spring.



Posturepedic

David M. Davis, Sealy Sales Representative
T-724-834-4134 F-724-834-4535

PRICE LIST

Bed Frame

RUG ROLLERS

SP33R	Twin		4-Wide rug rollers	\$ 39.00
SP46R	Full	Head to foot center support	6-Wide rug rollers	\$ 53.00
SP50R	Queen	Head to foot center support	6-Wide rug rollers	\$ 55.50
SP66R	King	Head to foot center support	6-Wide rug rollers	\$ 57.50
SP60R	Cal King	Head to foot center support	6-Wide rug rollers	\$ 57.50

STEEL STEM GLIDES

SP33G	Twin		4-Steel stem glides	\$ 39.00
SP46G	Full	Head to foot center support	6-Steel stem glides	\$ 53.00
SP50G	Queen	Head to foot center support	6-Steel stem glides	\$ 55.50
SP66G	King	Head to foot center support	6-Steel stem glides	\$ 57.50
SP60G	Cal King	Head to foot center support	6-Steel stem glides	\$ 57.50

ADJUSTABLE GLIDES

SP33A	Twin		4-Adjustable glides	\$ 41.00
SP46A	Full	Head to foot center support	6-Adjustable glides	\$ 57.00
SP50A	Queen	Head to foot center support	6-Adjustable glides	\$ 59.50
SP66A	King	Head to foot center support	6-Adjustable glides	\$ 61.75
SP60A	Cal King	Head to foot center support	6-Adjustable glides	\$ 61.75

BRASS BALL-BEARING

ROLLERS

SP33B	Twin		4-Brass rug rollers	\$ 41.00
SP46B	Full	Head to foot center support	6-Brass rug rollers	\$ 58.00
SP50B	Queen	Head to foot center support	6-Brass rug rollers	\$ 60.00
SP66B	King	Head to foot center support	6-Brass rug rollers	\$ 62.50
SP60B	Cal King	Head to foot center support	6-Brass rug rollers	\$ 62.50

Posturepedic Features

1. Flush angle surfaces with no step between angle pieces eliminate noise due to box spring stress.
2. Recessed legs for extra clearance.
3. Rugged vinyl molded protective end caps.
4. Quick and easy wedge slot assembly, more than twice as strong as other premium bed frames.
5. Longest, strongest and heaviest bed frame available.
6. Lifetime warranty.

VISIT US ON THE WEB: www.sealybedframe.com

 Posturepedic Bed Frame

7900 Northfield Rd.
Walton Hills, OH 44146



Hotel Supreme Firm

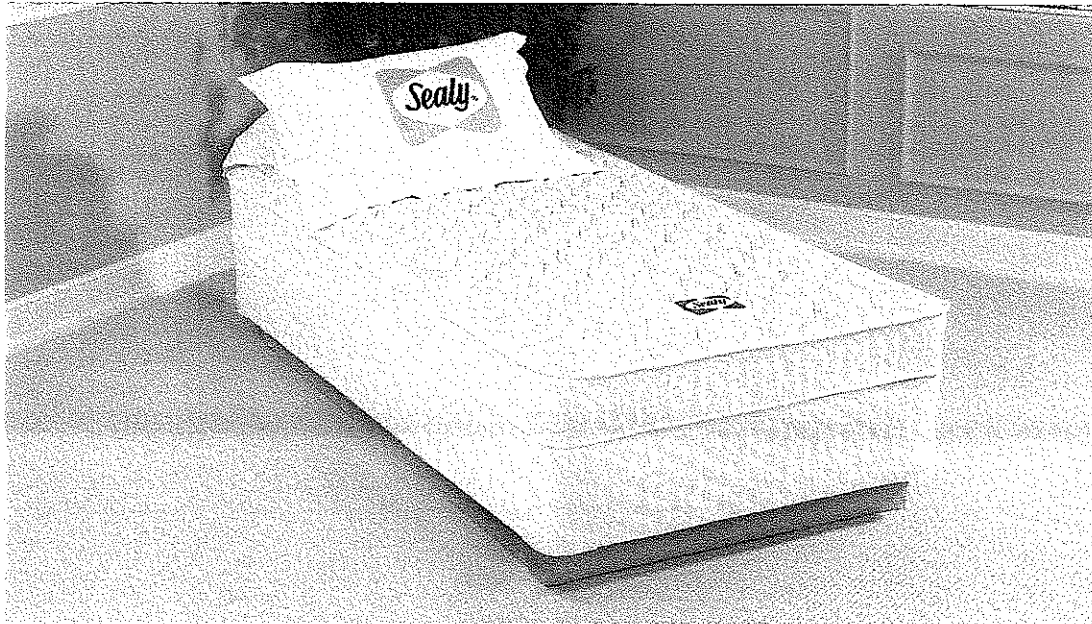

Quilt Top	1 oz. Sealy Fiber, 1/2" SealyFoam®
Upholstery Layers	1/4" Sealy Foam®, Miracle Mesh, DuraCushion® Pad
Innerspring	312 Bonnell, 5 Turn, 13 Gauge
Support System	StayTrue® Base for stability and added support, 6 gauge border wire

General Information	1/1 Warranty, Overall mattress height: 6 1/2"
---------------------	---

BANYAN

Cushion Firm

QUILT TOP

- FlameGuard™ Fiber
- .75" Regular Poly

COMFORT LAYERS

- 2" x 1" Zoned Convuluted Poly
- Mesh Insulator

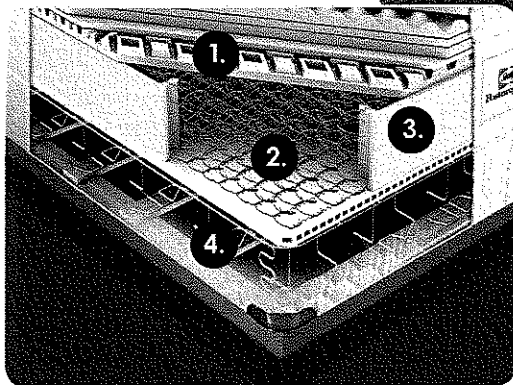

COMFORT SUPPORT SYSTEM

1. PRESSURE POINT MATERIALS

Advanced technology and materials reduce pressure points and provide relief from tossing and turning.

2. SEALY POSTUREPEDIC® INNERSPRING

Developed with orthopedic surgeons to respond to body weight with increasing, correct support.

3. UNICASED™ EDGE DESIGN

Provides strong seating edge, greater sleeping surface and uniform comfort edge-to-edge.

4. SHOCK ABZZORBER™ BOX SPRING

Deflects weight from mattress to extend Comfort Life®.

Drop Measurements – Height (in inches)

Bed Frame†	7.25"
Box Spring††	9"
Mattress Only (bottom to crown)	10"
Set (including frame) (Floor to mattress crown)	26.25"

† Standard bed frame height

†† Box Spring also available in 5.5" and 7" heights

WARRANTY: 10/10 non-prorated

Sleep systems meet the
16 CFR-1633 (CAL TB 603)
federal flammability standard.



Posturepedic

Support you trust. Comfort you'll love.™

800.707.3259 . www.sealycontract.com



Hotel Supreme Cushion Firm



Quilt Top	1 oz. Sealy Fiber, 1½" SealyFoam®
Upholstery Layers	1" SealyFoam®, ½" High Performance SealyFoam®, Double layer DuraCushion® Pad
Innerspring	312 Bonnell, 5 Turn, 13 Gauge
Support System	StayTrue® Base for stability and added support, 6 gauge border wire
Box Spring	Shock Abzzorber Plus® fully functional, with weight deflection capabilities – 9" standard, 7" optional
General Information	1/5 Warranty, Overall mattress height: 9"

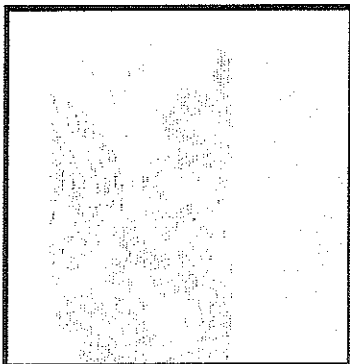

Mattress Fabric
 Style #: 3121
 Fiber Content:
 53% Viscose
 47% Polyester
 Fire Retardancy:
 16CFR-1632.6

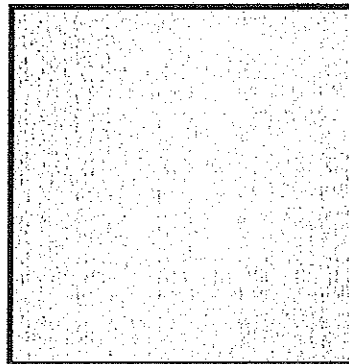

Border Fabric
 Style #: 3124
 Fiber Content:
 58% Viscose
 42% Polyester
 Fire Retardancy:
 16CFR-1632.6

Actual color and pattern of cover fabric is shown in above swatches. Other fabric options available for an upcharge.

Sealy's Comfort Support System

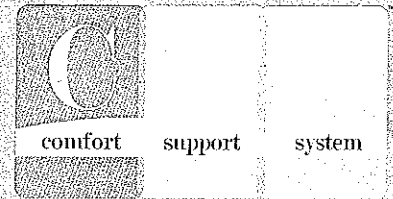

exclusively by  Posturepedic

1 PRESSURE POINT MATERIALS

Advanced technology and materials reduce pressure points and provide relief from tossing and turning.

2 SEALY POSTUREPEDIC® INNERSPRING

Extends to all sides of the mattress. Sealy's exclusive 5-turn, triple offset PostureTech® coil, made with heavy gauge double-tempered steel, features the Sense and Respond Support System® that responds to body weight with increasing, correct support.

3 UNICASED™ EDGE DESIGN

UniCased™ Edge surrounds and locks into the entire perimeter of the mattress innerspring system and is thermo-bonded to the UniCased™ Base with 2-stage deflection providing:

- A. Enhanced support and comfort performance of the Posturepedic innerspring
- B. Greater sleeping surface and uniform comfort edge-to-edge
- C. Motion dampening and enhanced stability
- D. Consistently firm seating edge around the entire mattress perimeter

4 SHOCK ABZZORBER™ BOX SPRING

Fully functional box spring with weight deflection capabilities that extend mattress Comfort Life®.

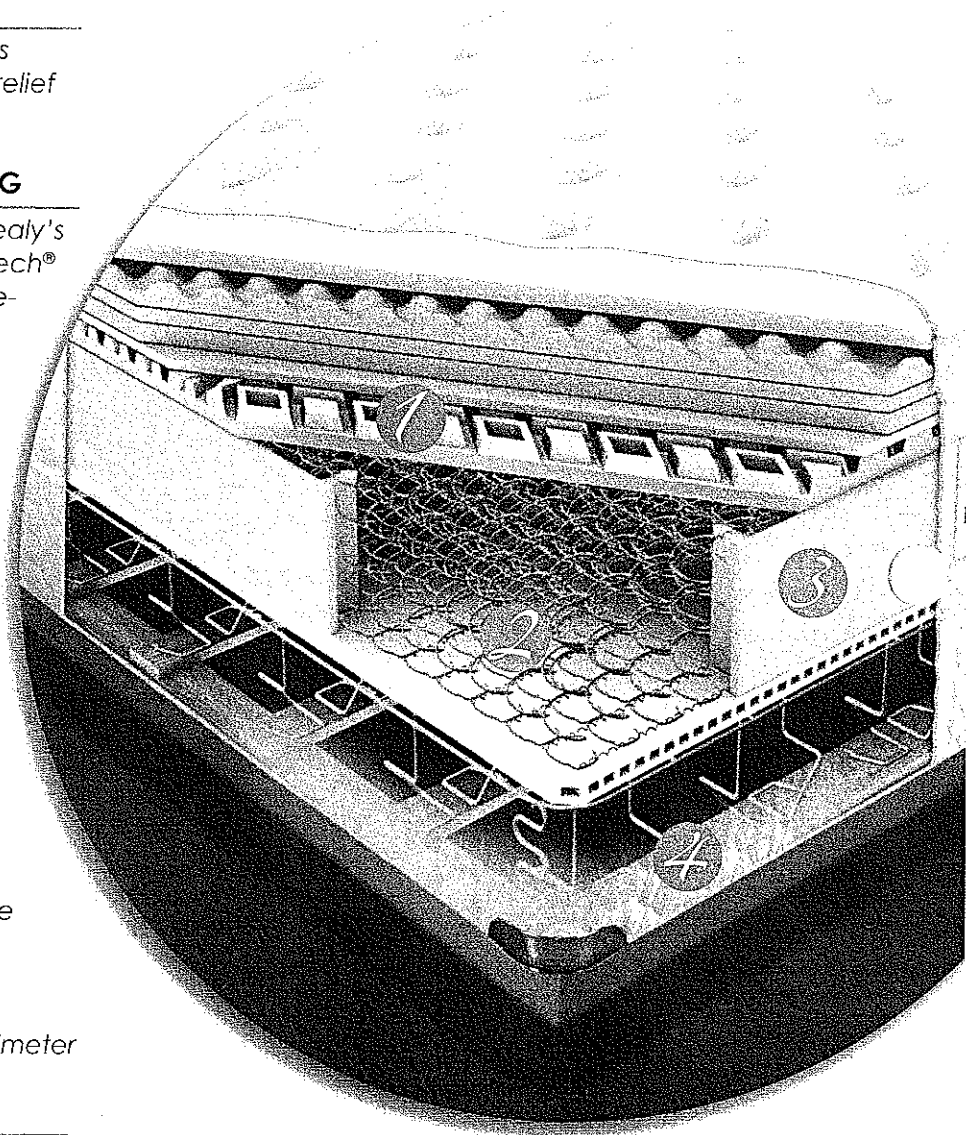

Maintenance-free construction so mattress never needs to be turned or rotated.

800-707-3259
www.sealycontract.com



Posturepedic

Support you trust. Comfort you'll love.™

SS
Standard Sleep.

PLUSK

STAYTRUE™ QUILT TOP

- 1.0 oz. FlameGuard™ FiberLux® Fiber
- 1½" x ½" SuperSoft Convoluted SealyFoam®
- ½" SealyFoam®

STAYTRUE™ COMFORT LAYERS

- 1¼" x ½" Convoluted SealyFoam®
- 2" x 1" Pressure Point Materials
- Versare Insulator

INNERSPRING:

736 PostureTech®
(Queen coil count)

SUPPORT SYSTEM:

UniCased™ Edge & Base
(with Support Channels)

BOX SPRING:

Shock Abzorber™

WARRANTY:

10/10 non-prorated

DROP MEASUREMENTS – HEIGHT

Bed Frame*	7¼"
Box Spring**	9"
Mattress Only (bottom to crown)	12¼"
Set (including frame) (Floor to mattress crown)	28½"

* Standard bed frame height

** Box Spring also available in 5.5" and 7" heights

Sealy Posturepedic
Support you trust. Comfort you'll love.™

800.707.3259

www.sealy.com



ADDITIONAL FEATURES

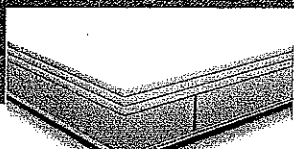

Inner-Tufted Comfort Layers
prevent shifting, ensuring long-lasting quality and durability.



Metal Corner Guards
protect box spring edges.

All Sealy Posturepedic CSS sleep systems meet the new 16 CFR 1633 (CAL TB-603) federal flammability standard.



Environmental Initiatives

As the world's largest bedding manufacturer, Sealy Corporation recognizes the importance of environmental sustainability and takes seriously its corporate responsibility for good stewardship in this effort. We produce high quality, durable sleep systems that provide our customers with the highest levels of sleep comfort and wellness.

Our goal is to reach an acceptable balance between sustainability and product quality, performance and durability, based upon the practical application of the most advanced technologies available. We are currently embarked on a two-fold approach to reduce our environmental footprint:

1. To ensure that our current operations and the operations of our suppliers are as environmentally friendly as possible.
2. To search for economically feasible ways to improve the sustainability of our products.

Listed below are steps that Sealy has taken to improve the environmental sustainability of its products.

WOOD*

Sealy's lumber resource is certified to SFI (Sustainable Forestry Initiative) or CSA (Canadian Standard Association) standards. This lumber company:

- Manages more land that is independently certified to sustainable forest management standards than any other company in the world.
- Reduced its greenhouse gas emissions by 10% since 2000.
- Reduced its energy consumption by 8% since 2003.
- 100% of the company's woodland will be certified ISO 14001 by the end of 2007. Today, over 95% has been achieved.

* Relevant Sealy Product: Box Spring (frame)

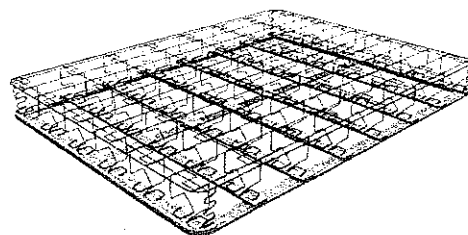

Box Spring

STEEL*

- 100% of the steel products in Sealy sleep systems come from recycled steel.
- Because of their patented design, Sealy innerspring units can be compressed instead of bailed, so that more innerspring units fit in a truckload. Fewer truckloads provide greater fuel efficiency and reduced emissions.

* Relevant Sealy Products: Mattress (innerspring), Box Spring (modules, center rails, grid tops, nails and staples).

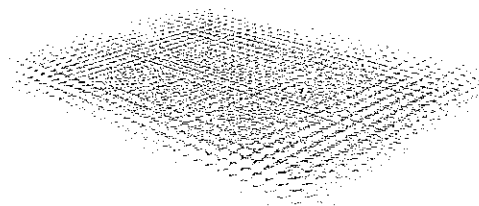

Innerspring

FOAMS*

- Sealy's foam supplier recycles 100% of its polyurethane scrap for use in the production of other consumer products (e.g. carpet).
- Sealy's insulator pads are made from 100% recycled textiles.

* Relevant Sealy Product: Mattress (comfort layers)

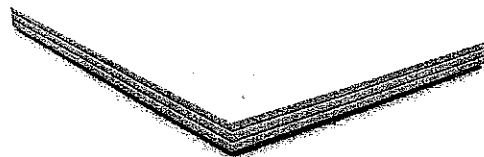

Comfort Layers

FIRE RETARDANT MATERIALS

Sealy chose to use only environmentally-friendly Fire Retardant materials to meet the new US Federal Standard 16 CFR 1633. By design, Sealy FR materials have inherent fire-retardant properties. As a result, no chemicals, including halogens, or harsh metals are used in Sealy FR materials.

LEAN MANUFACTURING

Sealy has been using Lean Manufacturing methods since 2004. Lean Manufacturing is the production of goods using less of everything compared to common mass production practices. Specific Sealy initiatives as they relate to Lean Manufacturing include:

1. Scrap Reduction

Sealy has reduced its scrap per piece produced by 64% from approximately 1.8 lbs per piece in June 2004 to approximately .65 lbs per piece in August 2007.

2. Recycling

- 100% of manufacturing scrap in Sealy plants is taken by Northstar Recycling Group to be recycled for other products. Scrap includes textiles, foams and plastics.

- Both wood and metal pallets are sent back to Sealy components plants for re-use.

3. Logistics

- Sealy uses a route optimization software system that streamlines delivery and minimizes the fuel use of its truck fleet.
- Sealy has consolidated transportation in North America where appropriate.
- Sealy has selected suppliers based on their proximity to Sealy manufacturing and components plants.

4. Non-Essential Materials Reduction

Sealy has minimized the use of secondary materials that are not critical to bed manufacturing and has developed environmentally preferable options (e.g. reduced corrugated packaging).

Scrap Lbs/Piece Produced

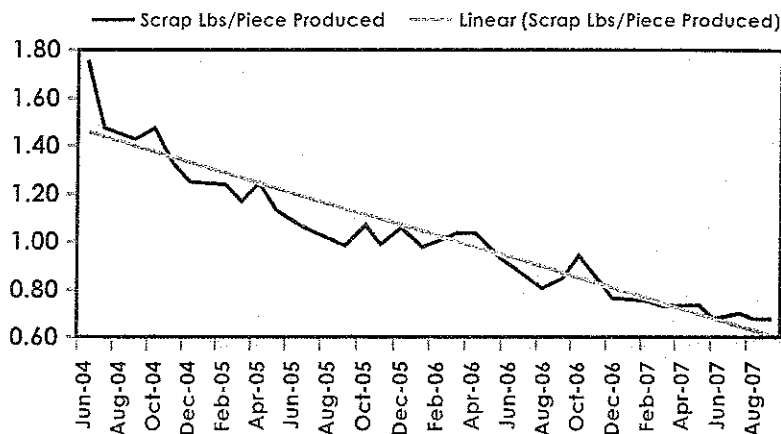

SECONDARY BEDDING

Sealy has set up an entire division to channel excess production to secondary bedding markets. This minimizes the amount of products and materials going to landfills, and includes:

- Sleep systems produced from excess raw materials
- Production overruns
- Off-specification sleep systems
- Prototypes and experimental sleep systems

S
table Sleep

PLUSH

STAYTRUE™ QUILT TOP

- 1.0 oz. FlameGuard™ FiberLux® Fiber
- 1" SuperSoft SealyFoam®
- ½" SealyFoam®

STAYTRUE™ COMFORT LAYERS

- ½" SealyFoam®
- 2" x 1" Pressure Point Materials
- Mesh Insulator

INNERSPRING:

736 PostureTech®
(Queen coil count)

SUPPORT SYSTEM:

UniCased™ Edge & Base
(with Support Channels)

BOX SPRING:

Shock Abzzorber™ Plus

WARRANTY:

10/10 non-prorated

DROP MEASUREMENTS – HEIGHT

Bed Frame*	7¼"
Box Spring**	9"
Mattress Only (bottom to crown)	11½"
Set [including frame] (Floor to mattress crown)	27¾"

* Standard bed frame height

** Box Spring also available in 5.5" and 7" heights

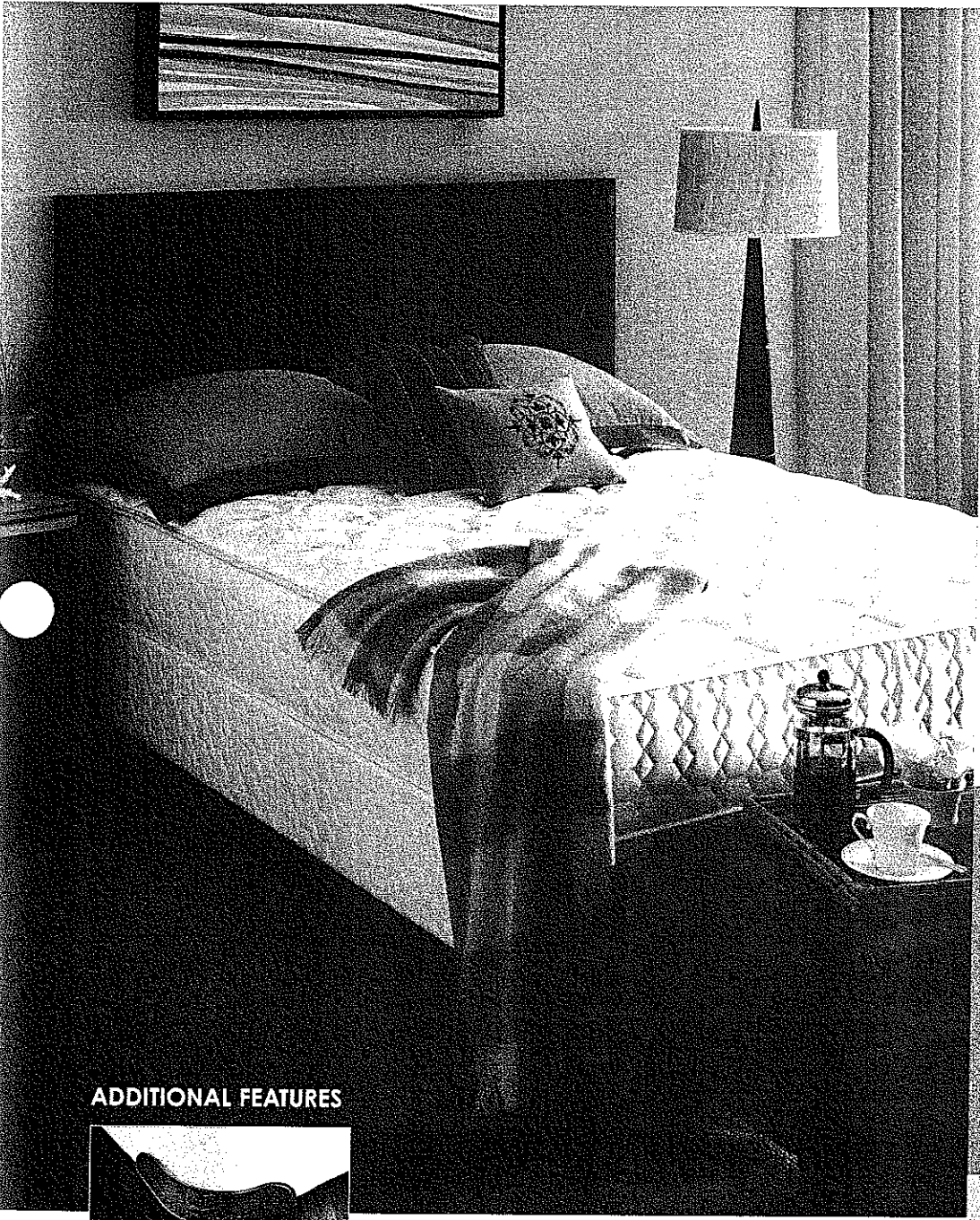

ADDITIONAL FEATURES



Metal Corner Guards
protect box
spring edges.

All Sealy Posturepedic CSS sleep systems meet the new 16 CFR 1633 (CAL TB-603) federal flammability standard.

Sealy Posturepedic
Support you trust. Comfort you'll love.™

What's Sealy's Comfort Support System?

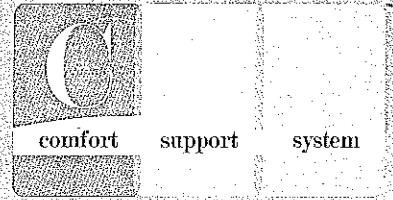

exclusively by  Posturepedic

Pressure Relieving Materials

Advanced technology and materials to reduce pressure points and provide relief from tossing and turning.

Sealy Posturepedic[™] Innerspring

Extends to all sides of the mattress. Sealy's exclusive 5-turn, triple offset PostureTech[®] coil, made with heavy gauge double-tempered steel, features the Sense and Respond Support System[®] that responds to body weight with increasing, correct support.

UniCased[™] Edge @ Base

UniCased[™] Edge surrounds and locks into the entire perimeter of the mattress innerspring system and is thermo-bonded to the UniCased[™] Base with 2-stage deflection providing:

- A. Enhanced support and comfort performance of the Posturepedic innerspring
- B. Greater sleeping surface and uniform comfort edge-to-edge
- C. Motion dampening and enhanced stability
- D. Consistently firm seating edge around the entire mattress perimeter

Supporting the Sealy Posturepedic CSS mattress is the fully functional **Shock Abzzorber[™] Plus** Box Spring with weight deflection capabilities that extend mattress Comfort Life[®].

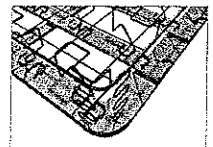

Maintenance-free construction so mattress never needs to be turned or rotated.

800.707.3259
www.sealy-contract.com



Posturepedic[®]

Support you trust. Comfort you'll love.[™]



SEALY MATTRESS COMPANY
P O Box 1821
Greensburg, PA 15601

DAVID M. DAVIS

Pennsylvania, Western Maryland
West Virginia, Western New York State
REGIONAL SALES
CONTRACT DIVISION

Email dadrea@aol.com

Office: 724-834-4134
FAX: 724-834-4535



CONTRACT BED FRAMES & BED BASES

BY MANTUA MANUFACTURING COMPANY

INNOVATOR OF PREMIUM QUALITY

BED FRAMES & BASES SINCE 1952

WHAT YOU SHOULD KNOW ABOUT BED FRAMES & BED BASES

*Protect your investment and enhance the performance
of Sealy hospitality sleep systems.*



OPTIMIZING GUEST SLEEP COMFORT

Hospitality mattresses, box springs and bed frames / bed bases operate as an interrelated system that can affect not only the life of the sleep system but also its ability to provide maximum guest comfort. The key functions of a well-coordinated hospitality sleep system are as follows:

Hospitality Mattress

Should provide orthopedically correct support and long-lasting comfort for the guest.

Hospitality Box Spring

Should work as a shock absorber to extend the Comfort Life of the mattress.

Hospitality Bed Frame or Bed Base

Should provide the support needed to match the critical structural elements of the box spring.

Sealy offers a variety of bed frames and bed bases designed and produced by Sealy to match the structural elements of the mattress. For more information on the benefits of a well-coordinated hospitality sleep system, please contact your Sealy representative.

**MORE THAN TWICE AS STRONG
AS OTHER HOSPITALITY
BED FRAMES**



Posturepedic® BED FRAME

The strongest, most technologically advanced bed frame design, created in collaboration with Sealy engineers to provide the perfect support for Sealy Posturepedic® sleep systems. Patented level-design construction for proper alignment and support of the box spring.

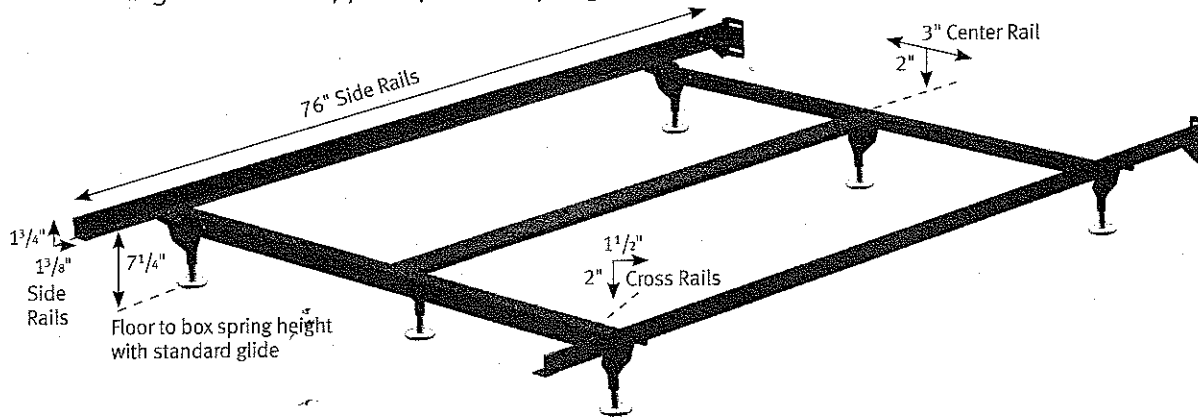

COMPONENT	DESCRIPTION	BENEFIT
Side rails	Wider, longer, stronger 1 3/4" x 1 3/8" x 76" high-carbon ribbed steel	Maximum strength and stability. Eliminates tipping when sitting at the foot of the bed
Cross rails	2" x 1 1/2" (extra-heavy), with wedge-notch assembly Level Design Construction (no step between angle joints)	Maximum strength and stability Support matches the critical structural elements of the box spring. Reduces box spring stress and the potential for noise.
Center support	Double 2" x 1 1/2" head-to-foot center rails on all sizes above Twin	Enhanced support for the box spring in critical areas
End caps	Rugged vinyl molded end caps at the ends of all side rails	Protection of box spring and prevention of injury
Legs	Patented self-leveling legs with wedge-notch assembly 6 recessed legs on all sizes above Twin	Stable footing on even and uneven surfaces and enhanced strength – the more weight applied, the stronger the frame becomes Improved safety and appearance
Glides	Steel glides with nylon pads standard <i>Option:</i> Adjustable threaded steel-stem glides that can lower the height 2 1/2" <i>Option:</i> 2 1/2" rug rollers, 2 with brake locks (7 1/2" floor to box spring height)	Stability Low-profile bed appearance Convenience – easy to move bed
Warranty	Lifetime limited warranty	Built to last a lifetime

KEY FEATURES



Self-Leveling Legs

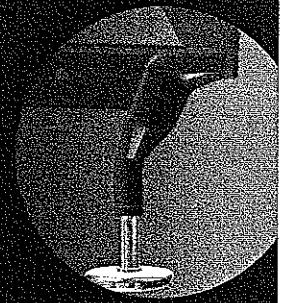

Recessed Legs

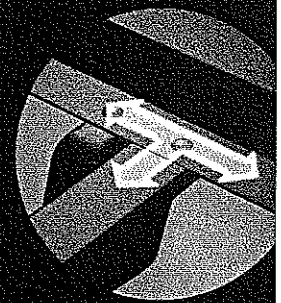

Level Design Construction

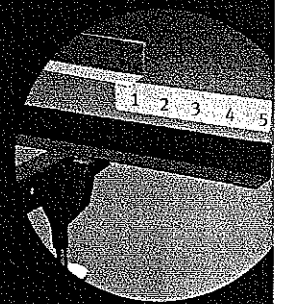

Extra Long Side Rails

**ADJUSTABLE HEIGHT
SETTINGS**

ADA ADJUSTABLE INSTA-LOCK BED FRAME

Available in high and low profile options for your special-needs guestrooms.*

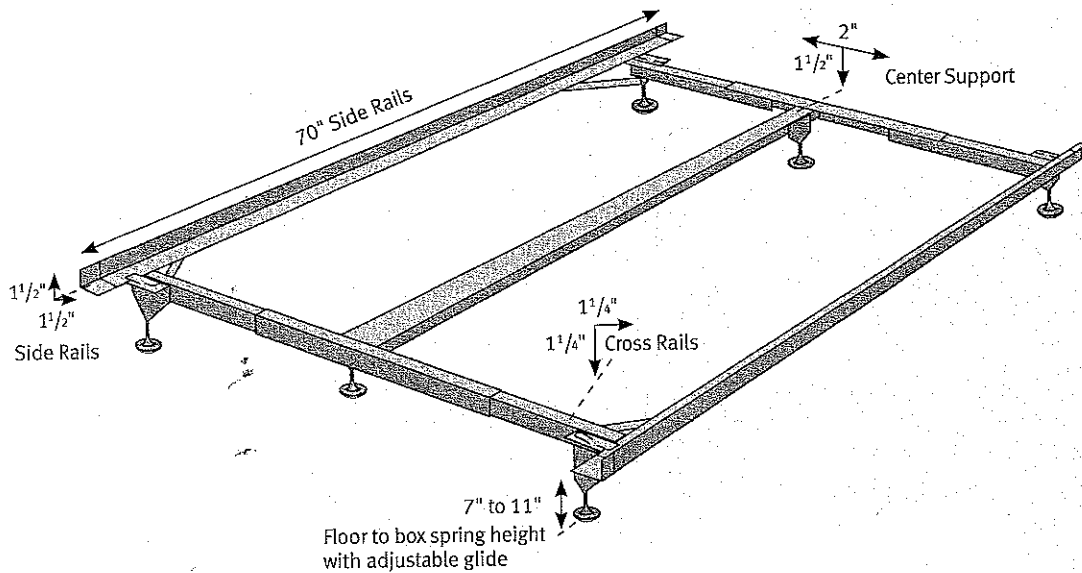

COMPONENT	DESCRIPTION	BENEFIT
Side rails	1 1/2" x 1 1/2" x 70" long side-angle construction	Dependable strength and support
Cross rails	1 1/4" x 1 1/4" sturdy one-size construction	Reliable fit for all sizes from Twin to Cal King
Center support	2" x 1 1/2" head-to-foot center rail	Added support for the box spring
End caps	Rugged vinyl molded end caps at the ends of all side rails	Protection of box spring and prevention of injury
Legs	4 corner strap braces 6 recessed legs	Enhanced leg strength and support Extra safety and clearance
Glides	Adjustable threaded steel-stem glides with nylon pads which provide a frame height of 7" to 11" from the floor	Extra height allows wheelchair wheels underneath
* Low Profile Option	3 1/2" height from floor to box spring – double 1 1/2" x 1 1/2" head-to-foot center rails, rug rollers, no corner straps	Lower overall bed height for easier access

KEY FEATURES

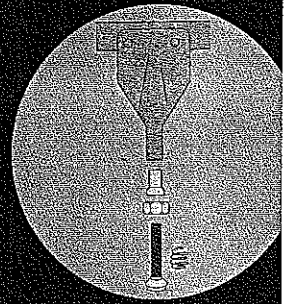

Adjustable Glides

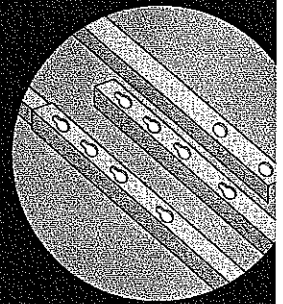

Insta-Lock Assembly

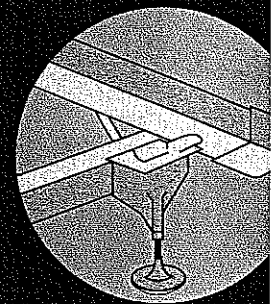

Recessed Legs

MANTUA BED FRAMES

QUALITY All Mantua Bed Frames are made of durable high-strength, high-carbon angle iron.
SAFETY All Mantua Bed Frame legs are recessed to prevent injury.
EASE OF ASSEMBLY All Mantua Bed Frames feature no-tools assembly.

STRONG AND DURABLE

CRAFTLOCK

BED FRAME

Easy-to-assemble Wedge-Lock design becomes stronger with increased weight.

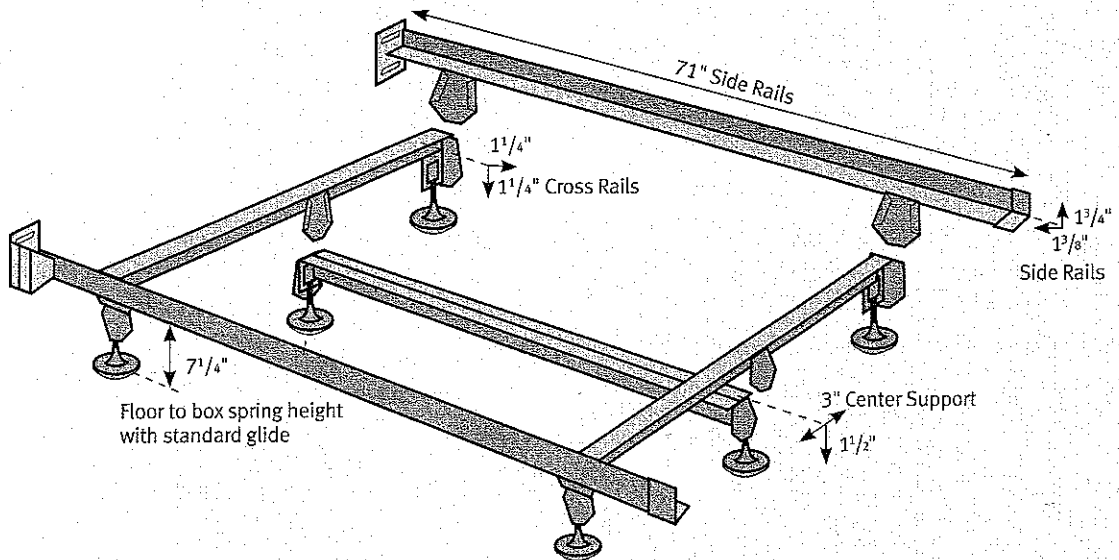

COMPONENT	DESCRIPTION	BENEFIT
Side rails	1 ³ / ₄ " x 1 ³ / ₈ " x 71" high-carbon ribbed steel side rails, featuring the Wedge-Lock Design	Long-lasting, sturdy support
Cross rails	1 ¹ / ₄ " x 1 ¹ / ₄ " Wedge-Lock Design	Enhanced strength – the more weight applied, the stronger the frame becomes
Center support	Double 1 ¹ / ₂ " x 1 ¹ / ₂ " head-to-foot center rail on Queen and King sizes	Added support for the box spring
End caps	Rugged vinyl molded end caps at the ends of all side rails	Protection of box spring and prevention of injury
Legs	6 recessed legs	Extra clearance and safety
Glides	Steel glides with nylon pads standard <i>Option: 2¹/₂" rug rollers, 2 with brake locks (7¹/₂" floor to box spring height)</i>	Stability Convenience – easy to move bed
Warranty	Lifetime limited warranty	Built to last a lifetime

KEY FEATURES

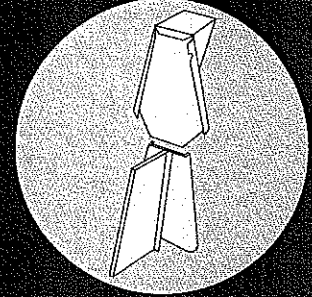

Wedge-Lock Design

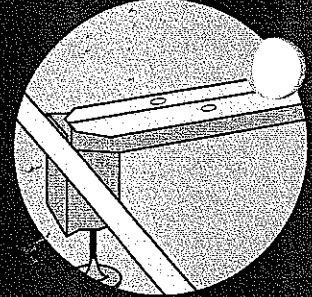

Double Rail Center Support

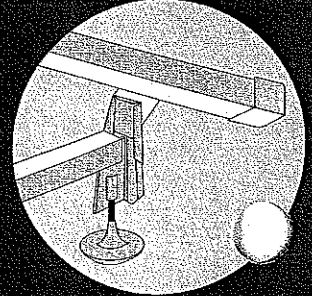

Recessed Legs

MANTUA BED FRAMES

QUALITY All Mantua Bed Frames are made of durable high-strength, high-carbon angle iron.
SAFETY All Mantua Bed Frame legs are recessed to prevent injury.
EASE OF ASSEMBLY All Mantua Bed Frames feature no-tools assembly.

**ADJUSTABLE
WIDTH SETTINGS**

DELUXE CLAMP STYLE BED FRAME

Readily adjusts to varying widths, for global or non-standard sizes and frame-mounted headboards.

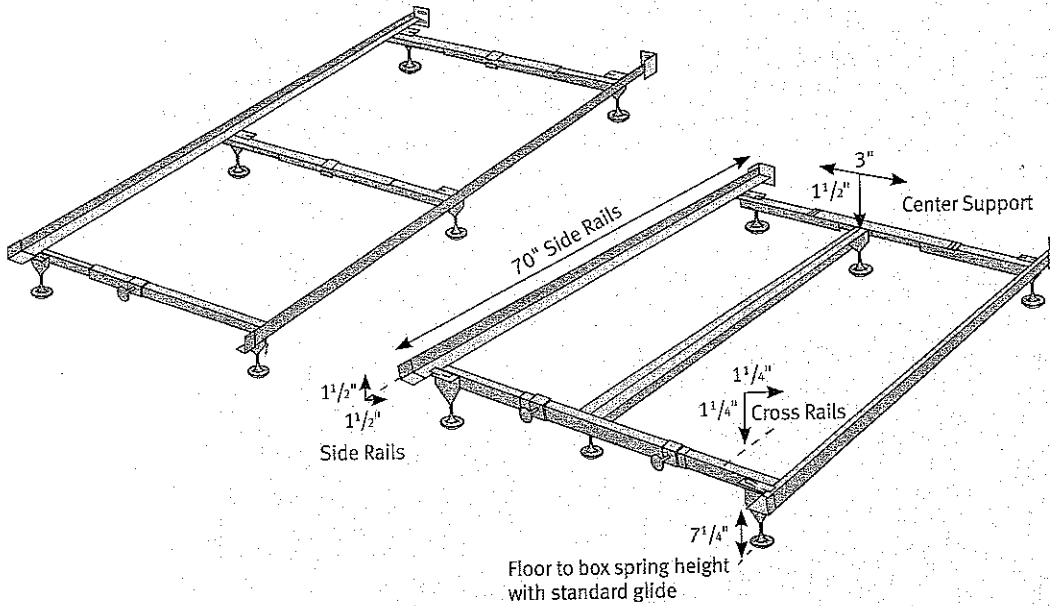

COMPONENT	DESCRIPTION	BENEFIT
Side rails	1 1/2" x 1 1/2" x 70" long side-angle construction	Dependable strength and support
Cross rails	Adjustable 1 1/4" x 1 1/4" cross support	Sturdy, reliable fit for global and custom sizes
Center support	Double 1 1/2" x 1 1/2" head-to-foot center rail on Queen and King sizes	Enhanced support for the box spring
End caps	Rugged vinyl molded end caps at the ends of all side rails	Protection of box spring and prevention of injury
Legs	6 recessed legs	Extra clearance and safety
Glides	Steel-stem glides with nylon pads standard	Stability

MANTUA BED FRAMES

QUALITY All Mantua Bed Frames are made of durable high-strength, high-carbon angle iron.

SAFETY All Mantua Bed Frame legs are recessed to prevent injury.

EASE OF ASSEMBLY All Mantua Bed Frames feature no-tools assembly.

KEY FEATURES

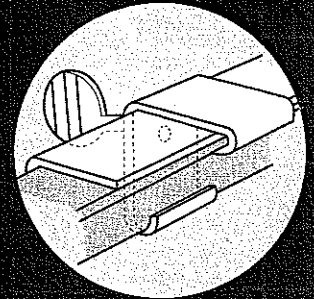

Heavy Duty Clamp Design

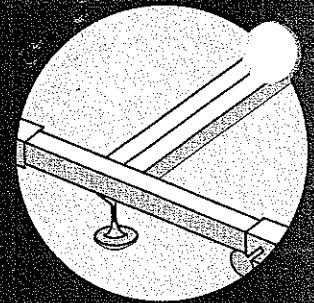

Adjustable Cross Support

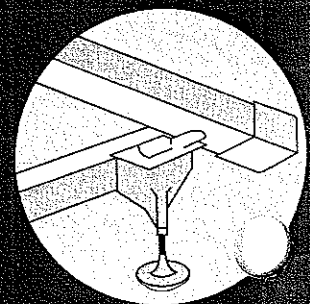

Recessed Legs

MANTUA WOOD-GRAIN BED BASE

with Moisture Guard

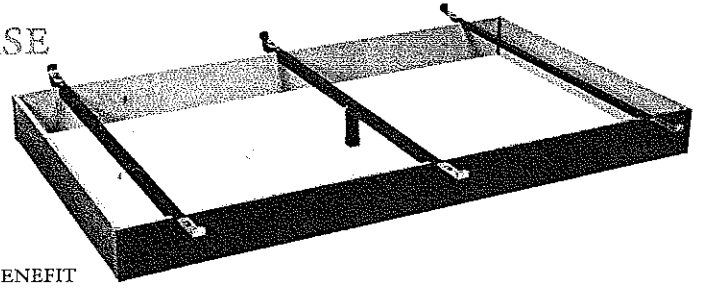

COMPONENT	DESCRIPTION	BENEFIT
Side panel length	Twin to King sizes, all with 72" side panels	Long-lasting, sturdy support
Side panel height	Available in 6", 7 1/2", and 10" heights	Option of low or high overall bed profile
Cross support	3 Heavy Duty angle-iron cross supports (with center legs on Full and Queen)	Sturdy, durable support for the box spring
Center support	King and California King sizes with head-to-foot center board	Enhanced support for the box spring
Brackets	Durable, adjustable metal box spring retainer brackets	Secure, firm fit – no box spring slippage
Characteristics	Rigid support system No-tools assembly	Extended life for the box spring Convenience – easy to assemble
Additional	Sealed <i>Moisture-Guard</i> bottom to prevent carpet shampoo moisture from seeping into baseboard	Extended life for the bed base – no moisture deterioration

MANTUA INTER-LOCK METAL BED BASE

Sturdy construction that won't bend or break under stress

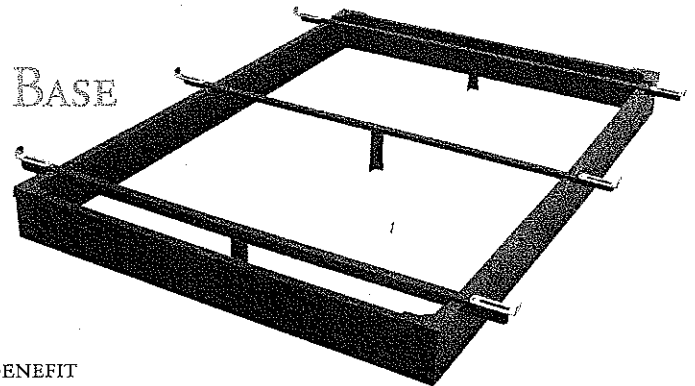

COMPONENT	DESCRIPTION	BENEFIT
Side panel length	Twin to King sizes, all with 72" side panels	Long-lasting, sturdy support
Side panel height	Available in 6", 7 1/2", and 10" heights	Option of low or high overall bed profile
Panel construction	Solid 18-gauge steel construction, with durable, rustproof finish	Solid, strong, durable, chip-proof and rustproof
Cross support	3 Heavy Duty angle-iron cross supports with center legs	Sturdy, durable support for the box spring
Brackets	Durable, adjustable metal box spring retainer brackets	Secure, firm fit – no box spring slippage
Characteristics	Rigid support system Quick, easy assembly. Very few parts. No tools required.	Extended life for the box spring Convenience – easy to assemble
Warranty	Lifetime limited warranty	Built to last a lifetime

RECYCLED MATERIALS

Mantua Manufacturing Company uses angle iron that has been formed from recycled railroad tracks in the production of its bed frames.

CUSTOM SIZES

Mantua will customize sizes to meet the specific needs of individual customers.
For additional information, please call (800) 333-8333.

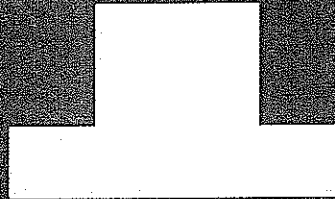

Mantua Manufacturing Company

Corporate Headquarters / Main Plant

7900 Northfield Road • Walton Hills, OH 44146

Toll free Phone: (800) 333-8333 • Toll free Fax: (800) 929-8014

Local Phone: (440) 232-8865 • Local Fax: (440) 232-5622

www.bedframes.com



It's made for sleep. It's a Sealy.™

Since 1952, Mantua Mfg. Co. has been the innovator of quality bed frames and accessories. Family owned and operated since its inception, Mantua serves customers in all fifty states, Canada, Mexico, Latin America and the Caribbean basin. With five manufacturing plants and multiple warehouse locations, we are ideally suited to serve both the largest national chains and the smallest individual retail stores and hospitality properties. Our reputation for personal service, efficiency, quality and integrity remains our foremost priority.

This brochure has been printed in an environmentally responsible manner on paper produced from sustainable forest resources.