



State of West Virginia
 Department of Administration
 Purchasing Division
 2019 Washington Street East
 Post Office Box 50130
 Charleston, WV 25305-0130

Request for Quotation

RFQ NUMBER
0890189

PAGE
1

ADDRESS CORRESPONDENCE TO ATTENTION OF
MICHAEL AUSTIN
304-558-2402

***709053211 304-372-9648**
WV SIGNAL & LIGHT INC
PO BOX 134

KENNA WV 25248

DIVISION OF HIGHWAYS
DISTRICT EIGHT
P.O. BOX 1516
US 219, NORTH PARSONS ROAD
ELKINS, WV
26241-1516 304-557-0215

DATE PRINTED	TERMS OF SALE	SHIP VIA	F.O.B.	FREIGHT TERMS
02/20/2009	NET 30	Best Way Ground	Dest	Included

BID OPENING DATE: **03/04/2009** BID OPENING TIME **01:30PM**

LINE	QUANTITY	UOP	CAT. NO.	ITEM NUMBER	UNIT PRICE	AMOUNT
0001	1	EA		968-83	L.S.	\$ 31,000.00
<p>MODIFY EXISTING TRAFFIC SIGNAL SYSTEM</p> <p>TO PROVIDE ALL EQUIPMENT, LABOR, AND MATERIAL NEEDED TO MODIFY THE EXISTING TRAFFIC SIGNAL SYSTEM AND INSTALL A RADAR ADVANCE DIGITAL DETECTION SYSTEM AT US 33 / US 250 NORTON, WEST VIRGINIA.</p> <p>THE WEST VIRGINIA DIVISION OF HIGHWAYS WILL PROVIDE SOME OF THE NECESSARY VIDEO DETECTION EQUIPMENT AND MATERIAL PER THE ATTACHED SPECIFICATIONS.</p> <p>EXHIBIT 5</p> <p>WEST VIRGINIA CODE 21-1D-5 PROVIDES THAT: ANY SOLICITATION FOR A PUBLIC IMPROVEMENT CONSTRUCTION CONTRACT REQUIRES EACH VENDOR THAT SUBMITS A BID FOR THE WORK TO SUBMIT AT THE SAME TIME AN AFFIDAVIT OF COMPLIANCE WITH THE BID. THE ENCLOSED DRUG-FREE WORKPLACE AFFIDAVIT MUST BE SIGNED AND SUBMITTED WITH THE BID AS EVIDENCE OF THE VENDOR'S COMPLIANCE WITH THE PROVISIONS OF ARTICLE 1D, CHAPTER 21 OF THE WEST VIRGINIA CODE. FAILURE TO SUBMIT THE SIGNED DRUG-FREE WORKPLACE AFFIDAVIT WITH THE BID SHALL RESULT IN DISQUALIFICATION OF SUCH BID.</p> <p>NOTICE TO PROCEED: THIS CONTRACT IS TO BE PERFORMED WITHIN 120 CALENDAR DAYS AFTER THE NOTICE TO PROCEED IS RECEIVED. UNLESS OTHERWISE SPECIFIED, THE FULLY EXECUTED PURCHASE ORDER WILL BE CONSIDERED NOTICE TO PROCEED.</p> <p>CANCELLATION: THE DIRECTOR OF PURCHASING RESERVES THE</p>						

RECEIVED
2009 MAR -4 PM 12:35
WV PURCHASING DIVISION

SEE REVERSE SIDE FOR TERMS AND CONDITIONS

SIGNATURE: *Vance Fitzsimmons* TELEPHONE: **304-372-9648** DATE: **3/3/09**

TITLE: *Sales Engineer* FEIN: **550646159** ADDRESS CHANGES TO BE NOTED ABOVE

WHEN RESPONDING TO RFQ, INSERT NAME AND ADDRESS IN SPACE ABOVE LABELED 'VENDOR'

**GENERAL TERMS & CONDITIONS
REQUEST FOR QUOTATION (RFQ) AND REQUEST FOR PROPOSAL (RFP)**

1. Awards will be made in the best interest of the State of West Virginia.
2. The State may accept or reject in part, or in whole, any bid.
3. All quotations are governed by the *West Virginia Code* and the *Legislative Rules* of the Purchasing Division.
4. Prior to any award, the apparent successful vendor must be properly registered with the Purchasing Division and have paid the required \$125 fee.
5. All services performed or goods delivered under State Purchase Order/Contracts are to be continued for the term of the Purchase Order/Contracts, contingent upon funds being appropriated by the Legislature or otherwise being made available. In the event funds are not appropriated or otherwise available for these services or goods, this Purchase Order/Contract becomes void and of no effect after June 30.
6. Payment may only be made after the delivery and acceptance of goods or services.
7. Interest may be paid for late payment in accordance with the *West Virginia Code*.
8. Vendor preference will be granted upon written request in accordance with the *West Virginia Code*.
9. The State of West Virginia is exempt from federal and state taxes and will not pay or reimburse such taxes.
10. The Director of Purchasing may cancel any Purchase Order/Contract upon 30 days written notice to the seller.
11. The laws of the State of West Virginia and the *Legislative Rules* of the Purchasing Division shall govern all rights and duties under the Contract, including without limitation the validity of this Purchase Order/Contract.
12. Any reference to automatic renewal is hereby deleted. The Contract may be renewed only upon mutual written agreement of the parties.
13. **BANKRUPTCY:** In the event the vendor/contractor files for bankruptcy protection, this Contract may be deemed null and void, and terminated without further order.
14. **HIPAA BUSINESS ASSOCIATE ADDENDUM:** The West Virginia State Government HIPAA Business Associate Addendum (BAA), approved by the Attorney General, and available online at the Purchasing Division's web site (<http://www.state.wv.us/admin/purchase/vrc/hipaa.htm>) is hereby made part of the agreement. Provided that, the Agency meets the definition of a Cover Entity (45 CFR §160.103) and will be disclosing Protected Health Information (45 CFR §160.103) to the vendor.
15. **WEST VIRGINIA ALCOHOL & DRUG-FREE WORKPLACE ACT:** If this Contract constitutes a public improvement construction contract as set forth in Article 1D, Chapter 21 of the West Virginia Code ("The West Virginia Alcohol and Drug-Free Workplace Act"), then the following language shall hereby become part of this Contract: "The contractor and its subcontractors shall implement and maintain a written drug-free workplace policy in compliance with the West Virginia Alcohol and Drug-Free Workplace Act, as set forth in Article 1D, Chapter 21 of the West Virginia Code. The contractor and its subcontractors shall provide a sworn statement in writing, under the penalties of perjury, that they maintain a valid drug-free work place policy in compliance with the West Virginia and Drug-Free Workplace Act. It is understood and agreed that this Contract shall be cancelled by the awarding authority if the Contractor: 1) Fails to implement its drug-free workplace policy; 2) Fails to provide information regarding implementation of the contractor's drug-free workplace policy at the request of the public authority; or 3) Provides to the public authority false information regarding the contractor's drug-free workplace policy."

INSTRUCTIONS TO BIDDERS

1. Use the quotation forms provided by the Purchasing Division.
2. **SPECIFICATIONS:** Items offered must be in compliance with the specifications. Any deviation from the specifications must be clearly indicated by the bidder. Alternates offered by the bidder as **EQUAL** to the specifications must be clearly defined. A bidder offering an alternate should attach complete specifications and literature to the bid. The Purchasing Division may waive minor deviations to specifications.
3. Complete all sections of the quotation form.
4. Unit prices shall prevail in case of discrepancy.
5. All quotations are considered F.O.B. destination unless alternate shipping terms are clearly identified in the quotation.
6. **BID SUBMISSION:** All quotations must be delivered by the bidder to the office listed below prior to the date and time of the bid opening. Failure of the bidder to deliver the quotations on time will result in bid disqualifications: Department of Administration, Purchasing Division, 2019 Washington Street East, P.O. Box 50130, Charleston, WV 25305-0130



State of West Virginia
 Department of Administration
 Purchasing Division
 2019 Washington Street East
 Post Office Box 50130
 Charleston, WV 25305-0130

Request for Quotation

RFQ NUMBER
0890189

PAGE
2

ADDRESS CORRESPONDENCE TO ATTENTION OF
MICHAEL AUSTIN 304-558-2402

SUZQ001

*709053211 304-372-9648
 WV SIGNAL & LIGHT INC
 PO BOX 134
 KENNA WV 25248

SHIP TO

DIVISION OF HIGHWAYS
 DISTRICT EIGHT
 P.O. BOX 1516
 US 219, NORTH PARSONS ROAD
 ELKINS, WV
 26241-1516 304-557-0215

DATE PRINTED	TERMS OF SALE	SHIP VIA	F.O.B.	FREIGHT TERMS
02/20/2009				

BID OPENING DATE: 03/04/2009 BID OPENING TIME 01:30PM

LINE	QUANTITY	UOP	CAT NO	ITEM NUMBER	UNIT PRICE	AMOUNT
<p>RIGHT TO CANCEL THIS CONTRACT IMMEDIATELY UPON WRITTEN NOTICE TO THE VENDOR IF THE MATERIALS OR WORKMANSHIP SUPPLIED ARE OF AN INFERIOR QUALITY OR DO NOT CONFORM WITH THE SPECIFICATIONS OF THE BID AND CONTRACT HERE IN.</p> <p>WAGE RATES: THE CONTRACTOR OR SUBCONTRACTOR SHALL PAY THE HIGHER OF THE U.S. DEPARTMENT OF LABOR MINIMUM WAGE RATES AS ESTABLISHED FOR RANDOLPH COUNTY, PURSUANT TO WEST VIRGINIA CODE 21-5A, ET, SEQ. (PREVAILING WAGE RATES APPLY TO THIS PROJECT)</p> <p>ARBITRATION: ANY REFERENCES MADE TO ARBITRATION OR INTEREST FOR PAYMENTS DUE (EXCEPT FOR ANY INTEREST REQUIRED BY STATE LAW) CONTAINED IN THIS CONTRACT OR IN ANY AMERICAN INSTITUTE OF ARCHITECTS DOCUMENTS PERTAINING TO THIS CONTRACT ARE HEREBY DELETED.</p> <p>WORKERS' COMPENSATION: VENDOR IS REQUIRED TO PROVIDE A CERTIFICATE FROM WORKERS' COMPENSATION IF SUCCESSFUL.</p> <p>ALL OF THE ITEMS CHECKED BELOW WILL BE A REQUIREMENT OF THIS CONTRACT:</p> <p>(XX) INSURANCE: SUCCESSFUL VENDOR SHALL FURNISH PROOF OF COMMERCIAL GENERAL LIABILITY INSURANCE PRIOR TO ISSUANCE OF CONTRACT. UNLESS OTHERWISE SPECIFIED IN THE BID DOCUMENTS, THE MINIMUM AMOUNT OF INSURANCE COVERAGE REQUIRED IS \$250,000.</p> <p>() BUILDERS RISK INSURANCE: SUCCESSFUL VENDOR SHALL FURNISH PROOF OF BUILDERS RISK - ALL RISK INSURANCE IN AN AMOUNT EQUAL TO 100% OF THE AMOUNT OF THE CONTRACT.</p> <p>(XX) BONDS: FIVE PERCENT (5%) OF THE TOTAL AMOUNT OF THE BID PAYABLE TO THE STATE OF WEST VIRGINIA, SHALL B</p>						

SEE REVERSE SIDE FOR TERMS AND CONDITIONS

SIGNATURE <i>Vance Fitzsummers</i>	TELEPHONE 304-372-9648	DATE 3/3/09
TITLE <i>Sales Engineer</i>	FEIN 550646159	ADDRESS CHANGES TO BE NOTED ABOVE

WHEN RESPONDING TO RFQ, INSERT NAME AND ADDRESS IN SPACE ABOVE LABELED 'VENDOR'



State of West Virginia
 Department of Administration
 Purchasing Division
 2019 Washington Street East
 Post Office Box 50130
 Charleston, WV 25305-0130

Request for Quotation

RFQ NUMBER:
0890189

PAGE:
3

ADDRESS CORRESPONDENCE TO ATTENTION OF:
**MICHAEL AUSTIN
 304-558-2402**

VENDOR

*709053211 304-372-9648
 WV SIGNAL & LIGHT INC
 PO BOX 134

 KENNA WV 25248

SHIP TO

DIVISION OF HIGHWAYS
 DISTRICT EIGHT
 P.O. BOX 1516
 US 219, NORTH PARSONS ROAD
 ELKINS, WV
 26241-1516 304-557-0215

DATE PRINTED 02/20/2009	TERMS OF SALE	SHIP VIA	F.O.B.	FREIGHT TERMS
-----------------------------------	---------------	----------	--------	---------------

BID OPENING DATE: **03/04/2009** BID OPENING TIME **01:30PM**

LINE	QUANTITY	UOP	CAT. NO.	ITEM NUMBER	UNIT PRICE	AMOUNT
<p>SUBMITTED WITH EACH BID AS A BID BOND. THE SUCCESSFUL BIDDER SHALL ALSO FURNISH A PERFORMANCE BOND AND LABOR/MATERIAL BOND FOR 100% OF THE AMOUNT OF THE CONTRACT. BONDS MAY BE PROVIDED IN THE FORM OF A CERTIFIED CHECK, IRREVOCABLE LETTER OF CREDIT, OR BOND FURNISHED BY A SOLVENT SURETY COMPANY AUTHORIZED TO DO BUSINESS IN THE STATE OF WEST VIRGINIA. A LETTER OF CREDIT SUBMITTED IN LIEU OF A BOND WILL ONLY BE ALLOWED FOR PROJECTS UNDER \$100,000. PERSONAL OR BUSINESS CHECKS ARE NOT ACCEPTABLE IN LIEU OF THE 5% BID BOND, PERFORMANCE BOND, OR LABOR AND MATERIAL BOND.</p> <p>() MAINTENANCE BOND: A TWO (2) YEAR MAINTENANCE BOND COVERING THE ROOFING SYSTEM WILL BE A REQUIREMENT OF THE SUCCESSFUL VENDOR.</p> <p>REV. 11/00</p> <p>EXHIBIT 7</p> <p>DOMESTIC ALUMINUM, GLASS & STEEL IN PUBLIC WORKS PROJECTS</p> <p>IN ACCORDANCE WITH WEST VIRGINIA CODE 5-19-1 ET., SEQ., EVERY CONTRACT FOR CONSTRUCTION, RECONSTRUCTION, ALTERATION, REPAIR, IMPROVEMENT OR MAINTENANCE OF PUBLIC WORKS, WHERE THE COST IS MORE THAN \$50,000 AND, IN THE CASE OF STEEL ONLY, WHERE THE COST OF STEEL IS MORE THAN \$50,000 OR WHERE MORE THAN 10,000 POUNDS OF STEEL ARE REQUIRED, THE STATE WILL ACCEPT ONLY ALUMINUM GLASS, OR STEEL PRODUCTS PRODUCED IN THE UNITED STATES. IN ADDITION, ITEMS OF MACHINERY OR EQUIPMENT PURCHASED FOR USE AT THE SITE OF PUBLIC WORKS SHALL BE MADE OF DOMESTIC ALUMINUM, GLASS OR STEEL, UNLESS THE COST OF THE PRODUCT IS LESS THAN \$50,000 OR LESS THAN 10,000</p>						

SEE REVERSE SIDE FOR TERMS AND CONDITIONS

SIGNATURE _____ TELEPHONE _____ DATE _____

TITLE _____ FEIN _____ ADDRESS CHANGES TO BE NOTED ABOVE

WHEN RESPONDING TO RFQ, INSERT NAME AND ADDRESS IN SPACE ABOVE LABELED 'VENDOR'



State of West Virginia
 Department of Administration
 Purchasing Division
 2019 Washington Street East
 Post Office Box 50130
 Charleston, WV 25305-0130

Request for Quotation

RFO NUMBER
0890189

PAGE
4

ADDRESS-CORRESPONDENCE TO ATTENTION OF:
MICHAEL AUSTIN 304-558-2402

*709053211 304-372-9648
 WV SIGNAL & LIGHT INC
 PO BOX 134

KENNA WV 25248

DIVISION OF HIGHWAYS
 DISTRICT EIGHT
 P.O. BOX 1516
 US 219, NORTH PARSONS ROAD
 ELKINS, WV
 26241-1516 304-557-0215

DATE PRINTED	TERMS OF SALE	SHIP VIA	F.O.B.	FREIGHT TERMS
02/20/2009				

BID OPENING DATE: **03/04/2009** BID OPENING TIME **01:30PM**

LINE	QUANTITY	UOP	CAT NO	ITEM NUMBER	UNIT PRICE	AMOUNT
				<p>POUNDS OF STEEL ARE USED IN PUBLIC WORKS PROJECTS.</p> <p>FOREIGN MADE ALUMINUM, GLASS OR STEEL PRODUCTS MAY BE ACCEPTED ONLY IF THE COST OF DOMESTIC PRODUCTS IS FOUND TO BE UNREASONABLE. SUCH COST IS UNREASONABLE IF IT IS 20% OR MORE HIGHER THAN THE BID PRICE FOR FOREIGN MADE PRODUCTS. IF THE DOMESTIC ALUMINUM, GLASS OR STEEL PRODUCTS TO BE SUPPLIED OR PRODUCED IN A "SUBSTANTIAL LABOR SURPLUS AREA", AS DEFINED BY THE UNITED STATES DEPARTMENT OF LABOR, FOREIGN PRODUCTS MAY BE SUPPLIED ONLY IF DOMESTIC PRODUCTS ARE 30% OR MORE HIGHER IN PRICE THAN THE FOREIGN MADE PRODUCTS.</p> <p>IF, PRIOR TO THE AWARD OF A CONTRACT UNDER THE ABOVE PROVISIONS, THE SPENDING OFFICER OF THE SPENDING UNIT DETERMINES THAT THERE EXISTS A BID FOR LIKE FOREIGN ALUMINUM, GLASS OR STEEL THAT IS REASONABLE AND LOWER THAN THE LOWEST BID DOMESTIC PRODUCTS, THE SPENDING OFFICE MAY REQUEST, IN WRITING, A REEVALUATION AND REDUCTION IN THE LOWEST BID FOR SUCH DOMESTIC PRODUCTS. ALL VENDORS MUST INDICATE IN THEIR BID IF THEY ARE SUPPLYING FOREIGN ALUMINUM, GLASS OR STEEL.</p> <p>REV. 3/88</p> <p>EXHIBIT 9</p> <p>NOTICE FOR ISSUANCE & ACKNOWLEDGEMENT OF CONSTRUCTION PROJECT ADDENDA</p> <p>THE ARCHITECT/ENGINEER AND/OR AGENCY SHALL BE REQUIRED TO ABIDE BY THE FOLLOWING SCHEDULE IN ISSUING CONSTRUCTION PROJECT ADDENDA FOR STATE AGENCIES:</p> <p>(1) THE ARCHITECT/ENGINEER SHALL PREPARE THE ADDENDUM</p>		

SEE REVERSE SIDE FOR TERMS AND CONDITIONS

SIGNATURE <i>Vance Fitzgerald</i>	TELEPHONE 304-372-9648	DATE 3/3/09
TITLE Sales Engineer	FEIN 550646159	ADDRESS CHANGES TO BE NOTED ABOVE

WHEN RESPONDING TO RFO, INSERT NAME AND ADDRESS IN SPACE ABOVE LABELED 'VENDOR'



State of West Virginia
 Department of Administration
 Purchasing Division
 2019 Washington Street East
 Post Office Box 50130
 Charleston, WV 25305-0130

Request for Quotation

RFQ NUMBER
0890189

PAGE
5

ADDRESS CORRESPONDENCE TO ATTENTION OF
**MICHAEL AUSTIN
 304-558-2402**

*709053211 304-372-9648
**WV SIGNAL & LIGHT INC
 PO BOX 134
 KENNA WV 25248**

**DIVISION OF HIGHWAYS
 DISTRICT EIGHT
 P.O. BOX 1516
 US 219, NORTH PARSONS ROAD
 ELKINS, WV
 26241-1516 304-557-0215**

DATE PRINTED	TERMS OF SALE	SHIP VIA	F.O.B.	FREIGHT TERMS
02/20/2009				

BID OPENING DATE: **03/04/2009** BID OPENING TIME **01:30PM**

LINE	QUANTITY	UOP	CAT. NO.	ITEM NUMBER	UNIT PRICE	AMOUNT
<p>AND A LIST OF ALL PARTIES THAT HAVE PROCURED DRAWINGS AND SPECIFICATIONS FOR THE PROJECT. THE ADDENDUM AND LIST SHALL BE FORWARDED TO THE BUYER IN THE STATE PURCHASING DIVISION. THE ARCHITECT/ENGINEER SHALL ALSO SEND A COPY OF THE ADDENDUM TO THE STATE AGENCY FOR WHICH THE CONTRACT IS ISSUED.</p> <p>(2) THE BUYER SHALL SEND THE ADDENDUM TO ALL INTERESTED PARTIES AND, IF NECESSARY, EXTEND THE BID OPENING DATE. ANY ADDENDUM SHOULD BE RECEIVED BY THE BUYER WITHIN FOURTEEN (14) DAYS PRIOR TO THE BID OPENING DATE.</p> <p>(3) ALL ADDENDA SHOULD BE FORMALLY ACKNOWLEDGED BY ALL BIDDERS AND SUBMITTED TO THE STATE PURCHASING DIVISION. THE SAME RULES AND REGULATIONS THAT APPLY TO THE ORIGINAL BIDDING DOCUMENT SHALL ALSO APPLY TO AN ADDENDUM DOCUMENT. THE ONLY EXCEPTION MAY BE FOR AN ADDENDUM THAT IS ISSUED FOR THE SOLE PURPOSE OF CHANGING A BID OPENING TIME AND/OR DATE.</p> <p>REV. 11/96</p> <p>EXHIBIT 10</p> <p>ADDENDUM ACKNOWLEDGEMENT</p> <p>I HEREBY ACKNOWLEDGE RECEIPT OF THE FOLLOWING CHECKED ADDENDUM(S) AND HAVE MADE THE NECESSARY REVISIONS TO MY PROPOSAL, PLANS AND/OR SPECIFICATION, ETC.</p> <p>ADDENDUM NOS. :</p> <p>NO. 1 <i>Vance Fitzsimmons</i></p>						

SEE REVERSE SIDE FOR TERMS AND CONDITIONS

SIGNATURE <i>Vance Fitzsimmons</i>	TELEPHONE 304-372-9648	DATE 3/3/09
TITLE Sales Engineer	FEIN 550646159	ADDRESS CHANGES TO BE NOTED ABOVE

WHEN RESPONDING TO RFQ, INSERT NAME AND ADDRESS IN SPACE ABOVE LABELED 'VENDOR'



State of West Virginia
 Department of Administration
 Purchasing Division
 2019 Washington Street East
 Post Office Box 50130
 Charleston, WV 25305-0130

Request for Quotation

RFQ NUMBER
 0890189

PAGE
 6

ADDRESS CORRESPONDENCE TO ATTENTION OF:
 MICHAEL AUSTIN
 304-558-2402

VENDOR

*709053211 304-372-9648
 WV SIGNAL & LIGHT INC
 PO BOX 134
 KENNA WV 25248

SHIP TO

DIVISION OF HIGHWAYS
 DISTRICT EIGHT
 P.O. BOX 1516
 US 219, NORTH PARSONS ROAD
 ELKINS, WV
 26241-1516 304-557-0215

DATE PRINTED 02/20/2009	TERMS OF SALE	SHIP VIA	F.O.B.	FREIGHT TERMS
----------------------------	---------------	----------	--------	---------------

BID OPENING DATE: 03/04/2009 BID OPENING TIME 01:30PM

LINE	QUANTITY	UOP	CAT NO	ITEM NUMBER	UNIT PRICE	AMOUNT
NO. 2				
NO. 3				
NO. 4				
NO. 5				
<p>I UNDERSTAND THAT FAILURE TO CONFIRM THE RECEIPT OF THE ADDENDUM(S) MAY BE CAUSE FOR REJECTION OF THE BIDS.</p> <p>VENDOR MUST CLEARLY UNDERSTAND THAT ANY VERBAL REPRESENTATION MADE OR ASSUMED TO BE MADE DURING ANY ORAL DISCUSSION HELD BETWEEN VENDOR'S REPRESENTATIVES AND ANY STATE PERSONNEL IS NOT BINDING. ONLY THE INFORMATION ISSUED IN WRITING AND ADDED TO THE SPECIFICATIONS BY AN OFFICIAL ADDENDUM IS BINDING.</p> <p><i>Vance J. Simmons</i> SIGNATURE <i>West Virginia Signal & Light, Inc.</i> COMPANY <i>3/3/09</i> DATE</p> <p>REV. 11/96</p> <p>CONTRACTORS LICENSE</p> <p>WEST VIRGINIA STATE CODE 21-11-2 REQUIRES THAT ALL PERSONS DESIRING TO PERFORM CONTRACTING WORK IN THIS STATE MUST BE LICENSED. THE WEST VIRGINIA CONTRACTORS LICENSING BOARD IS EMPOWERED TO ISSUE THE CONTRACTORS LICENSE. APPLICATIONS FOR A CONTRACTORS LICENSE MAY B</p>						

SEE REVERSE SIDE FOR TERMS AND CONDITIONS

SIGNATURE <i>Vance J. Simmons</i>	TELEPHONE 304-372-9648	DATE 3/3/09
TITLE Sales Engineer	FEIN 550646159	ADDRESS CHANGES TO BE NOTED ABOVE

WHEN RESPONDING TO RFQ, INSERT NAME AND ADDRESS IN SPACE ABOVE LABELED 'VENDOR'



State of West Virginia
 Department of Administration
 Purchasing Division
 2019 Washington Street East
 Post Office Box 50130
 Charleston, WV 25305-0130

Request for Quotation

RFQ NUMBER
0890189

PAGE
7

ADDRESS CORRESPONDENCE TO ATTENTION OF:
MICHAEL AUSTIN 304-558-2402

PURCHASER

*709053211 304-372-9648
 WV SIGNAL & LIGHT INC
 PO BOX 134

KENNA WV 25248

SHIP TO

DIVISION OF HIGHWAYS
 DISTRICT EIGHT
 P.O. BOX 1516
 US 219, NORTH PARSONS ROAD
 ELKINS, WV
 26241-1516 304-557-0215

DATE PRINTED	TERMS OF SALE	SHIP VIA	F.O.B	FREIGHT TERMS
02/20/2009				

BID OPENING DATE: 03/04/2009 BID OPENING TIME 01:30PM

LINE	QUANTITY	UOP	CAT NO.	ITEM NUMBER	UNIT PRICE	AMOUNT
<p>MADE BY CONTACTING THE WEST VIRGINIA DIVISION OF LABOR CAPITOL COMPLEX, BUILDING 3, ROOM 319, CHARLESTON, WV 25305. TELEPHONE: (304) 558-7890.</p> <p>WEST VIRGINIA STATE CODE 21-11-11 REQUIRES ANY PROSPECTIVE BIDDER TO INCLUDE THE CONTRACTORS LICENSE NUMBER ON THEIR BID.</p> <p>BIDDER TO COMPLETE:</p> <p>CONTRACTORS NAME: <i>West Virginia Signal & Light, Inc.</i></p> <p>CONTRACTORS LICENSE NO.: <i>WV000630</i></p> <p>THE SUCCESSFUL BIDDER WILL BE REQUIRED TO FURNISH A COPY OF THEIR CONTRACTORS LICENSE PRIOR TO ISSUANCE OF A PURCHASE ORDER/CONTRACT</p> <p>APPLICABLE LAW</p> <p>THE WEST VIRGINIA STATE CODE, PURCHASING DIVISION RULES AND REGULATIONS, AND THE INFORMATION PROVIDED IN THE "REQUEST FOR QUOTATION" ISSUED BY THE PURCHASING DIVISION IS THE SOLE AUTHORITY GOVERNING THIS PROCUREMENT.</p> <p>ANY INFORMATION PROVIDED IN SPECIFICATION MANUALS, OR ANY OTHER SOURCE, VERBAL OR WRITTEN, WHICH CONTRADICTS OR ALTERS THE INFORMATION PROVIDED FROM THE SOURCES AS DESCRIBED IN THE ABOVE PARAGRAPH IS VOID AND OF NO EFFECT.</p> <p>BANKRUPTCY: IN THE EVENT THE VENDOR/CONTRACTOR FILES FOR BANKRUPTCY PROTECTION, THIS CONTRACT IS AUTOMATICALLY NULL AND VOID, AND IS TERMINATED WITHOUT FURTHER ORDER.</p>						

SEE REVERSE SIDE FOR TERMS AND CONDITIONS			
SIGNATURE <i>Vance</i>	TELEPHONE 304-372-9648	DATE 3/3/09	
TITLE Sales Engineer	FEIN 550646159	ADDRESS CHANGES TO BE NOTED ABOVE	

WHEN RESPONDING TO RFQ, INSERT NAME AND ADDRESS IN SPACE ABOVE LABELED 'VENDOR'



State of West Virginia
 Department of Administration
 Purchasing Division
 2019 Washington Street East
 Post Office Box 50130
 Charleston, WV 25305-0130

Request for Quotation

RFO NUMBER
 0890189

PAGE
 8

ADDRESS CORRESPONDENCE TO ATTENTION OF
 MICHAEL AUSTIN
 304-558-2402

*709053211 304-372-9648
 WV SIGNAL & LIGHT INC
 PO BOX 134
 KENNA WV 25248

DIVISION OF HIGHWAYS
 DISTRICT EIGHT
 P.O. BOX 1516
 US 219, NORTH PARSONS ROAD
 ELKINS, WV
 26241-1516 304-557-0215

DATE PRINTED	TERMS OF SALE	SHIP VIA	F.O.B	FREIGHT TERMS
02/20/2009				

BID OPENING DATE: 03/04/2009 BID OPENING TIME 01:30PM

LINE	QUANTITY	UOP	CAT NO.	ITEM NUMBER	UNIT PRICE	AMOUNT
<p>REV. 1/2005</p> <p style="text-align: center;">NOTICE</p> <p>A SIGNED BID MUST BE SUBMITTED TO:</p> <p style="text-align: center;">DEPARTMENT OF ADMINISTRATION PURCHASING DIVISION BUILDING 15 2019 WASHINGTON STREET, EAST CHARLESTON, WV 25305-0130</p> <p>THE BID SHOULD CONTAIN THIS INFORMATION ON THE FACE OF THE ENVELOPE OR THE BID MAY NOT BE CONSIDERED:</p> <p>SEALED BID</p> <p>BUYER: 33</p> <p>REQ. NO.: 0890189</p> <p>BID OPENING DATE: -----</p> <p>BID OPENING TIME: -----</p> <p>PLEASE PROVIDE A FAX NUMBER IN CASE IT IS NECESSARY TO CONTACT YOU REGARDING YOUR BID:</p> <p style="text-align: center;">----- 304-372-9648 -----</p> <p>PLEASE PRINT OR TYPE NAME OF PERSON TO CONTACT CONCERNING THIS QUOTE: Vance Fitzsimmons</p>						

SEE REVERSE SIDE FOR TERMS AND CONDITIONS

SIGNATURE	TELEPHONE	DATE
TITLE	FERN	ADDRESS CHANGES TO BE NOTED ABOVE

WHEN RESPONDING TO RFQ, INSERT NAME AND ADDRESS IN SPACE ABOVE LABELED 'VENDOR'



State of West Virginia
 Department of Administration
 Purchasing Division
 2019 Washington Street East
 Post Office Box 50130
 Charleston, WV 25305-0130

Request for Quotation

RFQ NUMBER
0890189

PAGE
9

ADDRESS CORRESPONDENCE TO ATTENTION OF:
**MICHAEL AUSTIN
 304-558-2402**

VENDOR

*709053211 304-372-9648
 WV SIGNAL & LIGHT INC
 PO BOX 134

 KENNA WV 25248

SHIP TO

DIVISION OF HIGHWAYS
 DISTRICT EIGHT
 P.O. BOX 1516
 US 219, NORTH PARSONS ROAD
 ELKINS, WV
 26241-1516 304-557-0215

DATE PRINTED 02/20/2009	TERMS OF SALE	SHIP VIA	F.O.B.	FREIGHT TERMS
-----------------------------------	---------------	----------	--------	---------------

BID OPENING DATE: **03/04/2009** BID OPENING TIME **01:30PM**

LINE	QUANTITY	UOP	CAT. NO.	ITEM NUMBER	UNIT PRICE	AMOUNT
<i>Vance Fitzsimmons</i>						
***** THIS IS THE END OF RFQ 0890189 ***** TOTAL:						<u>\$31,000.⁰⁰</u>

SEE REVERSE SIDE FOR TERMS AND CONDITIONS

SIGNATURE <i>Vance Fitzsimmons</i>	TELEPHONE 304-372-9648	DATE 3/3/09
TITLE Sales Engineer	FEIN 550646159	ADDRESS CHANGES TO BE NOTED ABOVE

WHEN RESPONDING TO RFQ, INSERT NAME AND ADDRESS IN SPACE ABOVE LABELED 'VENDOR'



State of West Virginia
 Department of Administration
 Purchasing Division
 2019 Washington Street East
 Post Office Box 50130
 Charleston, WV 25305-0130

Request for Quotation

RFQ NUMBER
0890189

PAGE
1

ADDRESS CORRESPONDENCE TO ATTENTION OF
MICHAEL AUSTIN 304-558-2402

VENDOR
 *709053211 304-372-9648
 WV SIGNAL & LIGHT INC
 PO BOX 134
 KENNA WV 25248

SHIP TO
 DIVISION OF HIGHWAYS
 DISTRICT EIGHT
 P.O. BOX 1516
 US 219, NORTH PARSONS ROAD
 ELKINS, WV
 26241-1516 304-557-0215

DATE PRINTED	TERMS OF SALE	SHIP VIA	F.O.B.	FREIGHT TERMS
02/22/2009				

BID OPENING DATE: **03/04/2009** BID OPENING TIME **01:30PM**

LINE	QUANTITY	UOP	CAT. NO.	ITEM NUMBER	UNIT PRICE	AMOUNT
ADDENDUM NO. 1						
THE ATTACHED REVISED SUMMARY SHEET, PAGE 10, REPLACES PAGE 10 IN THE ORIGINAL REQUEST FOR QUOTATION.						
BID OPENING DATE AND TIME REMAINS 03/04/09 @1:30 P.M.						
NO OTHER CHANGES.						
0001	1	EA		968-83	L.S.	\$ 31,000. ⁰⁰
				MODIFY EXISTING TRAFFIC SIGNAL SYSTEM		
***** THIS IS THE END OF RFQ 0890189 ***** TOTAL:						\$ 31,000

SEE REVERSE SIDE FOR TERMS AND CONDITIONS		
SIGNATURE <i>John G. [Signature]</i>	TELEPHONE 304-372-9648	DATE 3/3/09
TITLE Sales Engineer	FEIN 550646159	ADDRESS CHANGES TO BE NOTED ABOVE

WHEN RESPONDING TO RFQ, INSERT NAME AND ADDRESS IN SPACE ABOVE LABELED 'VENDOR'

SUMMARY SHEET
 SIGNAL MODIFICATION
 US 33 AT US 250
 NORTON, RANDOLPH CO.

SG-1

THE CONTRACTOR SHALL NOTIFY THE WVDOH DISTRICT 8 TRAFFIC ENGINEER (MARK MORGAN - 304-637-0215) AND WVDOH DISTRICT 8 CONSTRUCTION ENGINEER (KYLE HALL /304-637-0215) AT LEAST 2 WEEKS PRIOR TO BEGINNING WORK

SIGNAL SUMMARY OF QUANTITIES					
ITEM NO.	DESCRIPTION	QUANTITY		COSTS	
		UNIT	TOTAL	UNIT COST	TOTAL COST
204001-000	MOBILIZATION	L.S.	1	L.S.	929. ⁰⁰
636011-001	TRAFFIC CONTROL DEVICE	UNIT	3,100	.01	31. ⁰⁰
636014-001	FLAGGER	HOUR	40	1. ⁰⁰	40. ⁰⁰
660002-020	TRAFFIC DETECTOR, VTDS, 01	LS	1	L.S.	7,500. ⁰⁰
660002-030	TRAFFIC DETECTOR, RADD 01	L.S.	1	L.S.	15,000. ⁰⁰
660007-001	MISCELLANEOUS SIGNAL, 01	L.S.	1	L.S.	7,500. ⁰⁰
TOTAL BID AMOUNT =					31,000. ⁰⁰

VIDEO TRAFFIC DETECTION SYSTEM (VTDS)
 SEE WORK DESCRIPTION NOTES
 A VIDEO TRAFFIC DETECTION SYSTEM (VTDS) IS TO BE INSTALLED FOR THIS INTERSECTION AS DESCRIBED IN THESE PLANS. THIS VIDEO WORK & MATERIAL SHALL BE BID PER INTERSECTION [660002-020, TRAFFIC DETECTORS VTDS, (*)]
 THIS INTERSECTION SYSTEM INCLUDES ALL NECESSARY CAMERAS, PROCESSING UNITS, CABLE (SEE WORK DESCRIPTION NOTES) AND RELATED HARDWARE TO MAKE FUNCTION PROPERLY. SEE VIDEO SPECIFICATIONS IN PROPOSAL AND DETAIL 'G' IN THESE PLANS..

RADAR ADVANCE DIGITAL DETECTOR (RADD)

THE RADAR ADVANCE DIGITAL DETECTION SYSTEM SHALL BE NON-INTRUSIVE AND EQUIVALENT TO THE 'WAVETRONIX SMARTSENSOR ADVANCE MODEL 200' OR AN APPROVED EQUAL AS DEEMED APPROPRIATE BY THE TRAFFIC ENGINEERING DIVISION.

A MANUFACTURER'S TECHNICAL REPRESENTATIVE SHALL BE AVAILABLE TO ASSIST WITH THE PHYSICAL INSTALLATION, ALIGNMENT AND AUTO-CALIBRATION OF EACH SUPPLIED RADD.

GENERAL NOTES
SIGNAL MODIFICATION
US 33 AT US 250
NORTON, RANDOLPH CO.

GENERAL NOTES

GOVERNING SPECIFICATIONS

1. THE WEST VIRGINIA DIVISION OF HIGHWAYS SPECIFICATIONS FOR ROADS AND BRIDGES ADOPTED 2000, THE WVDOH SUPPLEMENTAL SPECIFICATIONS DATED JANUARY 1, 2003, THE CONTRACT DOCUMENTS AND THE CONTRACT PLANS ARE THE GOVERNING PROVISIONS APPLICABLE TO THIS PROJECT.
- 1A. THE NATIONAL ELECTRICAL CODE, STANDARDS OF THE NATIONAL BOARD OF FIRE UNDERWRITERS FOR ELECTRICAL WIRING AND APPARATUS.

SIGNAL SYSTEMS

2. "INSTALLATION OF THIS SIGNAL SYSTEM SHALL ONLY BE CONSIDERED SUBSTANTIALLY COMPLETE WHEN ALL PRESCRIBED SIGNAL SYSTEMS FUNCTIONS AND ROADWAY DETECTION SYSTEMS ARE OPERATIONAL".

GENERAL NOTES

3. REPLACEMENT OF ALL CONCRETE AND ASPHALT SHALL BE DONE IN ACCORDANCE TO ORIGINAL DESIGN THICKNESS WHERE IT HAS BEEN DISTURBED OR REMOVED TO INSTALL POLES OR CONDUIT AT THE CONTRACTOR'S EXPENSE.
4. ALL AREAS ON THIS PROJECT WHICH HAVE BEEN SEEDED BY OTHERS AND WHICH ARE DISTURBED BY THE CONTRACTOR IN PERFORMING THE REQUIREMENTS OF THIS CONTRACT SHALL BE REPLACED TO THEIR ORIGINAL CONDITION BY APPROVED SEEDING AND MULCHING METHODS AND MATERIALS AS DIRECTED BY THE ENGINEER. NO ADDITIONAL COMPENSATION SHALL BE ALLOWED FOR THIS WORK.
5. THE INFORMATION SHOWN ON THESE DRAWINGS CONCERNING TYPE AND LOCATION OF UNDERGROUND UTILITIES IS NOT GUARANTEED TO BE ACCURATE OR ALL INCLUSIVE. THE CONTRACTOR IS RESPONSIBLE FOR MAKING HIS OWN DETERMINATION AS TO THE TYPE AND LOCATION OF UNDERGROUND UTILITIES AS MAY BE NECESSARY TO AVOID DAMAGE THERETO. ANY DAMAGE INCURRED SHALL BE REPAIRED AT THE CONTRACTOR'S EXPENSE.
7. COLOR CODING OF ELECTRICAL CONDUCTORS BY USE OF PHASE TAPE OR FIELD PAINT IS NOT ACCEPTABLE ON THIS PROJECT. CONDUCTORS MUST BE MANUFACTURER-COLORED, STRIPED OR RIGID-MARKED AS SPECIFIED.
8. THE VIDEO CABLE CONNECTION AT THE VIDEO CAMERA END MUST BE INSTALLED WITH A WEATHER PROOF BOOT FILLED WITH DIELECTRIC GREASE.

WORK DESCRIPTION NOTES
SIGNAL MODIFICATION
US 33 AT US 250
NORTON, RANDOLPH CO.

12

1. THIS IS AN EXISTING SIGNAL TO BE MODIFIED AS NOTED BELOW. EXISTING CONTROLLER IS AN ECONOLITE.
2. THE EXISTING CARD RACK DETECTORS SHALL BE REMOVED AND DELIVERED TO THE WVDOH CENTRAL SIGNAL SHOP ON DRY BRANCH ROAD NEAR CHARLESTON. THE EXISTING DETECTOR FEEDER CABLE SHALL BE REMOVED FROM THE SIGNAL CONTROLLER, OVERHEAD FACILITIES AND FROM SIGNAL POLE P1. BID THIS AS PART OF ITEM 660007-001(01).
3. THE CONTRACTOR SHALL SUPPLY AND INSTALL A 'RADAR ADVANCE DIGITAL DETECTION' SYSTEM (RADD) AS DETAILED IN THESE PLANS. THIS INCLUDES 2 RADD SENSORS, AS NEEDED INPUT CARDS, CABLE AND ALL OTHER HARWARE NECESSARY TO COMPLETE THIS RADD SYSTEM. BID ALL INSTALLATION AND MATERIAL FOR THE INSTALLATION OF THIS 'RADD' SYSTEM AS ITEM 660002-030, 01.
4. A VIDEO TRAFFIC DETECTION SYSTEM (VTDS) SHALL BE INSTALLED FOR THIS INTERSECTION AS DESCRIBED IN THESE PLANS. THE FOLLOWING VTDS MATERIAL TO BE FURNISHED BY WVDOH DISTRICT 8 (NOTIFY MARK MORGAN- DB TRAFFIC ENGINEER) AND PICKED UP BY CONTRACTOR AT THE DB HQS.ON US 219 NORTH OF ELKINS:
 - A) 2 EACH - ECONOLITE AUTOSCOPE RACK VISION VIDEO DETECTORS A/N ARVSIE S/N 1715 REV. A.
 - B) 2 EACH ECONOLITE AUTOSCOPE CAMERAS MODEL 703170 AIS WITH HARTING CONNECTOR (THIS ZOOM LENS SENSOR REQUIRES AIS ZOOM CONTROL RELEASE VERSION 8.14 OR LATER OR AUTOSCOPE SOFTWARE SUITE VERSION 8.13 A OR LATER)
 - C) 200LF VIDEO CAMERA CABLE #52 JSAICBL-P/V
5. THE DETECTOR RACK MUST BE REWIRED TO ACCEPT THE NEW VIDEO EQUIPMENT OR AS AN ALTERNATIVE A NEW RACK MAY BE SUPPLIED. BID AS PART OF ITEM 660002-020.
6. THE CONTRACTOR SHALL SUPPLY ALL OTHER VIDEO CABLE AND HARDWARE AS REQUIRED TO MAKE SYSTEM OPERATE PROPERLY. BID THE REQUIRED ADDITIONAL VIDEO MATERIAL AND THE INSTALLATION OF ALL VIDEO MATERIAL AS ITEM 660002-020, 01.
7. BID ALL OTHER NECESSARY CONTROLLER WORK AS PART OF ITEM 660007-001(01).
8. ALL OTHER EXISTING SIGNAL FACILITIES SHALL REMAIN AS IS.

TRAFFIC CONTROL NOTES
 SIGNAL MODIFICATION
 US 33 AT US 250
NORTON, RANDOLPH CO.

MAINTENANCE OF TRAFFIC NOTES

1. MAINTENANCE OF TRAFFIC SHALL BE IN ACCORDANCE WITH SECTION 636 OF THE WEST VIRGINIA DEPARTMENT OF TRANSPORTATION, DIVISION OF HIGHWAYS STANDARD SPECIFICATIONS ROADS AND BRIDGES, ADOPTED 2000, AND THE WEST VIRGINIA DEPARTMENT OF TRANSPORTATION, DIVISIONS OF HIGHWAYS SUPPLEMENTAL SPECIFICATIONS DATED JANUARY 1, 2003 AND THE "MANUAL ON TEMPORARY TRAFFIC CONTROL FOR STREETS AND HIGHWAYS" 2006 EDITION; WHICH IS MADE A PART OF THIS CONTRACT AND THE TRAFFIC PLAN FOR FOR INDIVIDUAL SEGMENTS AS DESCRIBED IN THESE PLANS.
2. REFLECTIVE SHEETING ON TEMPORARY TRAFFIC CONTROL DEVICES SHALL BE OF NEW CONDITION AT THE BEGINNING OF THE PROJECT LIFE. NIGHT VISIBILITY AND LEGIBILITY SHALL BE MAINTAINED. ALL WARNING SIGNS SHALL HAVE MINIMUM DIMENSIONS OF 48" X 48" UNLESS OTHERWISE NOTED. SIGN SIZES AND COLORS ARE SHOWN IN THE WEST VIRGINIA DIVISION OF HIGHWAYS SIGN FABRICATION MANUAL.
3. ACCESS TO ALL HOUSES AND BUSINESSES SHALL BE MAINTAINED AT ALL TIMES.
4. TRAFFIC SHALL BE MAINTAINED THROUGHOUT THE PROJECT AT ALL TIMES.
5. OPEN HOLES TO BE COVERED AND HAVE TYPE II BARRICADES w/TYPE 'A' LIGHTS. THERE IS NO SPECIFIC BID ITEM FOR TYPE 'A' LIGHTS SHALL BE BID INCIDENTAL TO ITEM 636011-001.
6. ALL SIGNS INDICATING "ROAD CONSTRUCTION" SHALL NOW READ "ROAD WORK". FOR EXAMPLE, THE W-20-1 "ROAD CONSTRUCTION NEXT MILES", SHALL READ "ROAD WORK NEXT MILES", AND G20-2 "END CONSTRUCTION" SHALL READ "END ROAD WORK".
7. ALL WORK THROUGH OUT THE LIFE OF THIS PROJECT SHALL BE CO-ORDINATED WITH THE AREA ACTIVITIES TO MINIMIZE EFFECTS ON TRAFFIC FLOW, ESPECIALLY FOR ANY 'SPECIAL EVENTS'. CONTRACTOR SHALL NOTE THESE 'SPECIAL EVENTS' IN ADVANCE TO MINIMIZE DISRUPTIONS.

SEQUENCE OF CONSTRUCTION

1. UNDERGROUND WORK - BASICALLY ALL CONDUIT, JUNCTION BOXES, POLE FOUNDATIONS, ETC.

NON-ROAD - USE CASE A3, E2 OR E3 WITHOUT TYPE 'B' LIGHTS FOR ONE, TWO OR THREE APPROACHES AS NECESSARY.

IN ROADWAY - USE CASES A6, E4 OR E6 AS APPROPRIATE.
 DO NOT CLOSE LANES OVERNIGHT.

NOTE: FOR PEDESTRIANS, INSTALL "WORKERS" (W21-1b) SIGNS, TYPE II BARRICADES OR DRUMS, CONSTRUCTION TAPE, AND TYPE 'A' LIGHT OR TYPE II BARRICADE OR DRUM FOR OVERNIGHT AS NECESSARY.

2. CONSTRUCTION OF INDIVIDUAL INTERSECTION.

DOWNTIME

IF NECESSARY, SIGNAL DOWNTIME SHALL BE LIMITED TO 2 HOURS. CONTRACTOR SHALL PROVIDE FLAGGING WITH THE PROPER SIGNING DURING THIS DOWNTIME

CONTRACTOR SHALL NOTIFY THE WVDOH DISTRICT 8 TRAFFIC ENGINEER PRIOR TO ANY SIGNAL DOWNTIME

SIGNAL DETAILS
SIGNAL MODIFICATION
US 33 AT US 250
NORTON, RANDOLPH CO.

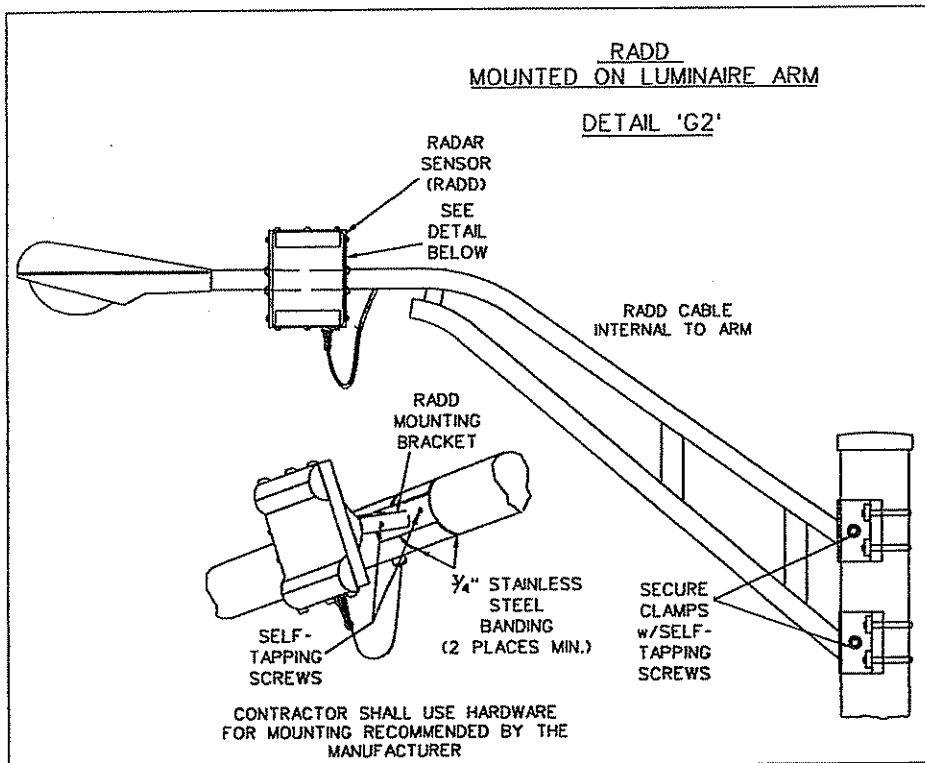
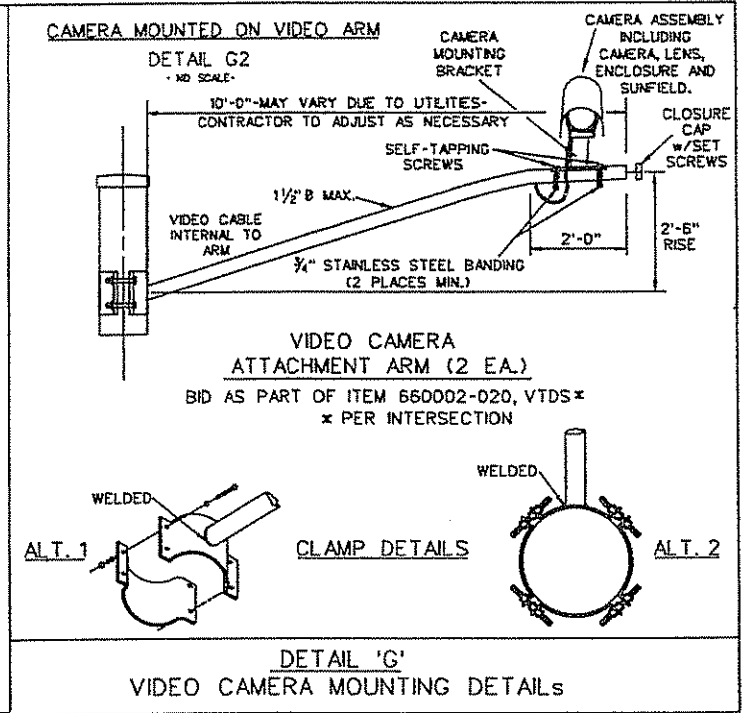
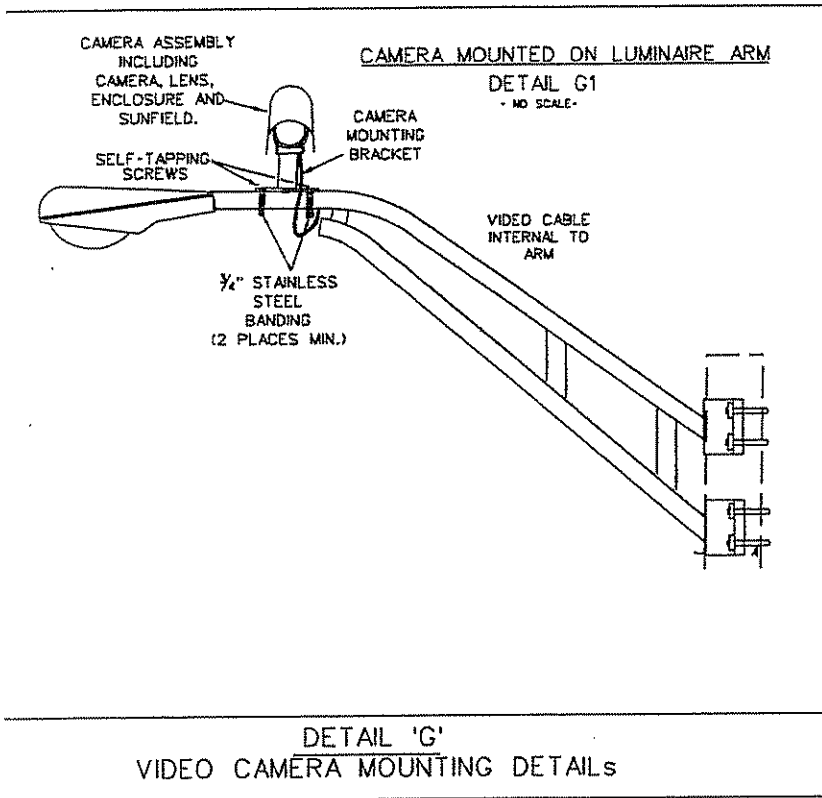

EQUIPMENT LIST & INFORMATION
 SIGNAL MODIFICATION
 US 33 AT US 250
NORTON, RANDOLPH CO.

ESTIMATE OF QUANTITIES

<u>LIST</u>	<u>QUANTITY</u>	<u>DESCRIPTION</u>
1	AS NEEDED	MISCELLANEOUS HARDWARE AND ITEMS
2	AS NEEDED	CONDUCTOR CABLE
3	2	'RADAR ADVANCE DIGITAL DETECTION' (RADD) SENSOR
4	AS NEEDED	'RADD' INPUT CARDS
5	AS NEEDED	'RADD' CABLE, 'RADD' HARDWARE & MISC. 'RADD' ITEMS
6	2 ✕	VIDEO IMAGE PROCESSING UNIT
7	AS NEEDED	VIDEO CABLE AND RELATED VIDEO HARDWARE (SEE NOTE)
8	2 ✕	VIDEO CAMERA (1 LUM. ARM MTD., 1 VIDEO ARM MTD.) - 660002-020, VTDS, 01
9	2	VIDEO ARMS

✕ - WVDOH SHALL SUPPLY TWO (2) VIDEO CAMERAS, TWO (2) VIDEO PROCESSING UNITS AND 200LF OF VIDEO CABLE. SEE 'WORK DESCRIPTION' NOTES.

EXISTING
DUAL RING PHASING
TO REMAIN AS IS

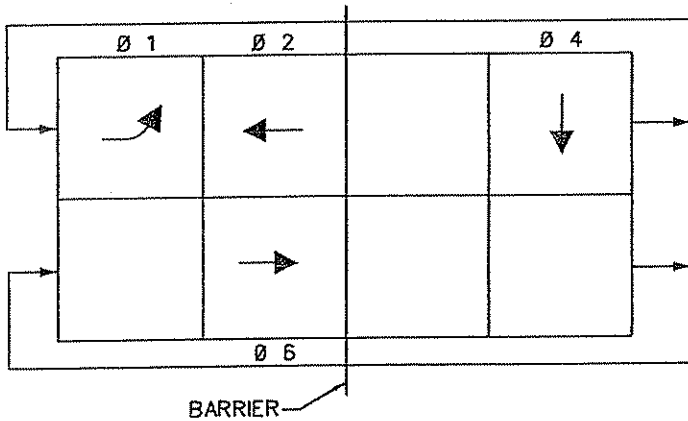

EXISTING
SIGNAL HEADS

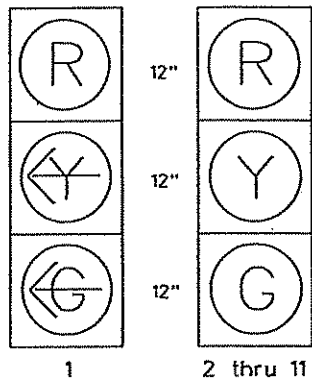

FLASH
SEQUENCE

HEAD NO.	FLASH
2, 3 4, 5 6, 10	Y
1, 7 8, 9, 11	R

POLE CHART
FOR INFORMATION ONLY

FOOTER OR POLE NO.	TYPE	UPRIGHT POLE			LOCATION	LUMINAIRE		
		POLE MOUNTED SIGNAL ATTACHMENT	HEIGHT	WALL GA.		SPREAD	LUM. MTC. HEIGHT	ANGLE "G"
		DIM "K" / DIM "L"		O. D.				
P1	C1	15' 3'-10"	30'	2 3/8" Ply 12"	EX. TO REMAIN	20'	36'6"	
P2	C1	15' 3'-10"	30'	2 3/8" Ply 12"	EX. TO REMAIN			
P3	C1	15' 3'-10"	30'	2 3/8" Ply 12"	EX. TO REMAIN			
P4	C1	15' 3'-10"	30'	2 3/8" Ply 12"	EX. TO REMAIN	20'	36'6"	

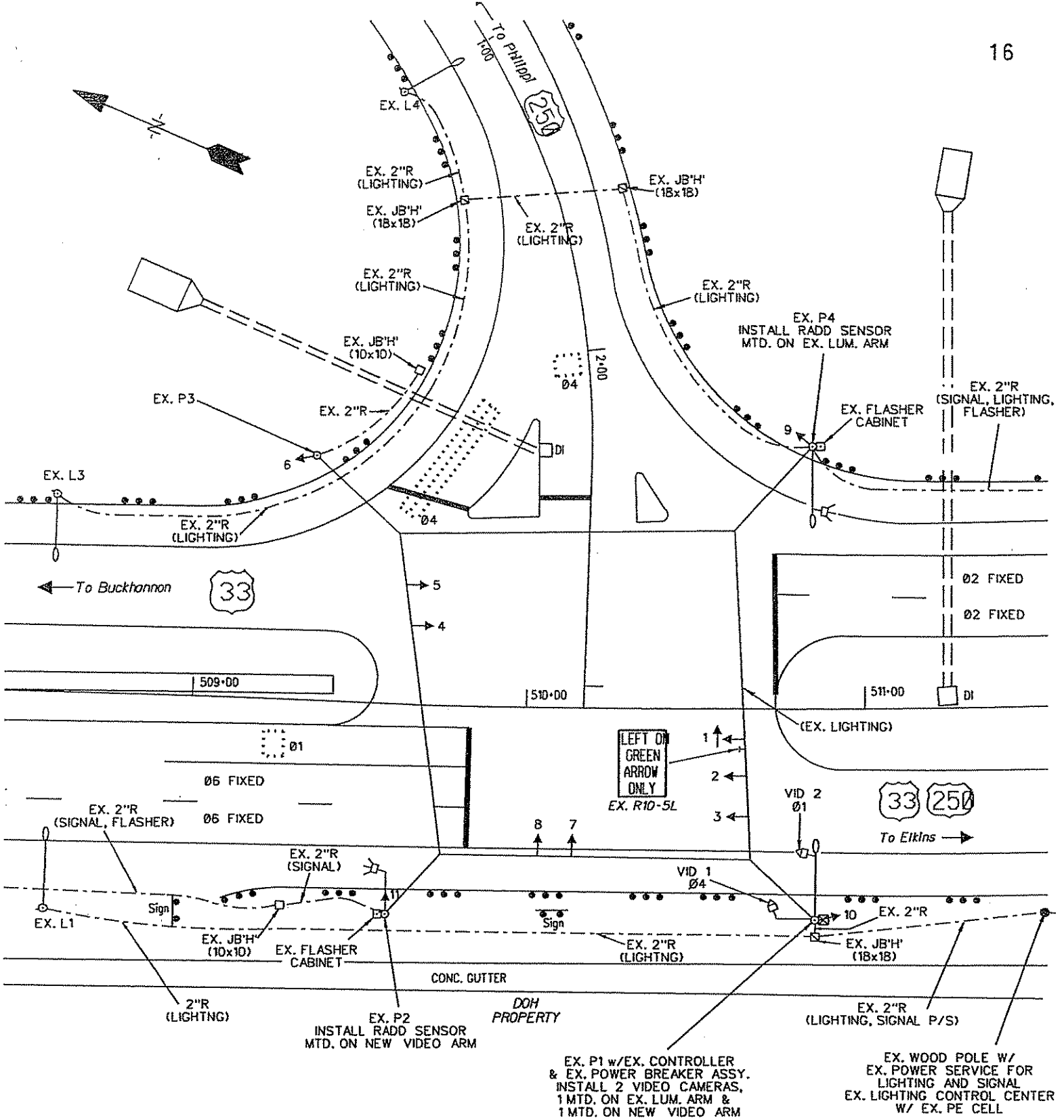

LEGEND

- ☒ CONTROLLER
- JUNCTION BOX (TYPE H)
- CONDUIT (EXISTING)
- SIGNAL POLE
- ➔ TRAFFIC SIGNAL HEAD
- ◌ LUMINAIRE
- ➔ VIDEO CAMERA
- ⋯ DETECTION ZONE
- ⚡ RADAR ADVANCED DETECTION SENSOR (RADD)

EX. P1 w/ EX. CONTROLLER & EX. POWER BREAKER ASSY. INSTALL 2 VIDEO CAMERAS, 1 MTD. ON EX. LUM. ARM & 1 MTD. ON NEW VIDEO ARM

EX. WOOD POLE W/ EX. POWER SERVICE FOR LIGHTING AND SIGNAL EX. LIGHTING CONTROL CENTER W/ EX. PE CELL

SCALE : 0 20'

**TRAFFIC SIGNAL DETECTION INSTALLATION
US 33 at US 250
NORTON, RANDOLPH CO.**

BID BOND

KNOW ALL MEN BY THESE PRESENTS, That we, the undersigned, West Virginia Signal and Light, Inc.
of Kenna, WV, as Principal, and Travelers Casualty and Surety Company
of America of Hartford, CT, a corporation organized and existing under the laws of the State of CT
with its principal office in the City of Hartford, as Surety, are held and firmly bound unto the State
of West Virginia, as Obligee, in the penal sum of Five Percent of Amount Bid (\$ 5%) for the payment of which,
well and truly to be made, we jointly and severally bind ourselves, our heirs, administrators, executors, successors and assigns.

The Condition of the above obligation is such that whereas the Principal has submitted to the Purchasing Section of the
Department of Administration a certain bid or proposal, attached hereto and made a part hereof, to enter into a contract in writing for
Traffic Signal Modification, Norton, WV

NOW THEREFORE,

- (a) If said bid shall be rejected, or
- (b) If said bid shall be accepted and the Principal shall enter into a contract in accordance with the bid or proposal attached
hereto and shall furnish any other bonds and insurance required by the bid or proposal, and shall in all other respects perform the
agreement created by the acceptance of said bid, then this obligation shall be null and void, otherwise this obligation shall remain in full
force and effect. It is expressly understood and agreed that the liability of the Surety for any and all claims hereunder shall, in no event,
exceed the penal amount of this obligation as herein stated.

The Surety, for the value received, hereby stipulates and agrees that the obligations of said Surety and its bond shall be in no
way impaired or affected by any extension of the time within which the Obligee may accept such bid, and said Surety does hereby
waive notice of any such extension.

IN WITNESS WHEREOF, Principal and Surety have hereunto set their hands and seals, and such of them as are corporations
have caused their corporate seals to be affixed hereunto and these presents to be signed by their proper officers, this
4th day of March, 2009.

Principal Corporate Seal

West Virginia Signal and Light, Inc.
(Name of Principal)

By: [Signature]
(Must be President or
Vice President)

PRESIDENT
(Title)

Surety Corporate Seal

Travelers Casualty and Surety Company of America
(Name of Surety)

By: [Signature]
Pamela V. Lanham Attorney-in-Fact

IMPORTANT – Surety executing bonds must be licensed in West Virginia to transact surety insurance. Corporate seals must be affixed,
and a power of attorney must be attached.



POWER OF ATTORNEY

Farmington Casualty Company
Fidelity and Guaranty Insurance Company
Fidelity and Guaranty Insurance Underwriters, Inc.
Seaboard Surety Company
St. Paul Fire and Marine Insurance Company

St. Paul Guardian Insurance Company
St. Paul Mercury Insurance Company
Travelers Casualty and Surety Company
Travelers Casualty and Surety Company of America
United States Fidelity and Guaranty Company

Attorney-In Fact No. 220306

Certificate No. 002551930

KNOW ALL MEN BY THESE PRESENTS: That Seaboard Surety Company is a corporation duly organized under the laws of the State of New York, that St. Paul Fire and Marine Insurance Company, St. Paul Guardian Insurance Company and St. Paul Mercury Insurance Company are corporations duly organized under the laws of the State of Minnesota, that Farmington Casualty Company, Travelers Casualty and Surety Company, and Travelers Casualty and Surety Company of America are corporations duly organized under the laws of the State of Connecticut, that United States Fidelity and Guaranty Company is a corporation duly organized under the laws of the State of Maryland, that Fidelity and Guaranty Insurance Company is a corporation duly organized under the laws of the State of Iowa, and that Fidelity and Guaranty Insurance Underwriters, Inc. is a corporation duly organized under the laws of the State of Wisconsin (herein collectively called the "Companies"), and that the Companies do hereby make, constitute and appoint

Andrew K. Teeter, Donna J. Price, Douglas P. Taylor, Kimberly L. Miles, C. Lee Jordan, Pamela V. Lanham, and Christopher A. Michel

of the City of Charleston, State of West Virginia, their true and lawful Attorney(s)-in-Fact, each in their separate capacity if more than one is named above, to sign, execute, seal and acknowledge any and all bonds, recognizances, conditional undertakings and other writings obligatory in the nature thereof on behalf of the Companies in their business of guaranteeing the fidelity of persons, guaranteeing the performance of contracts and executing or guaranteeing bonds and undertakings required or permitted in any actions or proceedings allowed by law.

IN WITNESS WHEREOF, the Companies have caused this instrument to be signed and their corporate seals to be hereto affixed, this 6th day of August, 2008.

Farmington Casualty Company
Fidelity and Guaranty Insurance Company
Fidelity and Guaranty Insurance Underwriters, Inc.
Seaboard Surety Company
St. Paul Fire and Marine Insurance Company

St. Paul Guardian Insurance Company
St. Paul Mercury Insurance Company
Travelers Casualty and Surety Company
Travelers Casualty and Surety Company of America
United States Fidelity and Guaranty Company



State of Connecticut
City of Hartford ss.

By: [Signature]
George W. Thompson, Senior Vice President

On this the 6th day of August, 2008, before me personally appeared George W. Thompson, who acknowledged himself to be the Senior Vice President of Farmington Casualty Company, Fidelity and Guaranty Insurance Company, Fidelity and Guaranty Insurance Underwriters, Inc., Seaboard Surety Company, St. Paul Fire and Marine Insurance Company, St. Paul Guardian Insurance Company, St. Paul Mercury Insurance Company, Travelers Casualty and Surety Company, Travelers Casualty and Surety Company of America, and United States Fidelity and Guaranty Company, and that he, as such, being authorized so to do, executed the foregoing instrument for the purposes therein contained by signing on behalf of the corporations by himself as a duly authorized officer.

In Witness Whereof, I hereunto set my hand and official seal. My Commission expires the 30th day of June, 2011.



[Signature]
Marie C. Tetreault, Notary Public

This Power of Attorney is granted under and by the authority of the following resolutions adopted by the Boards of Directors of Farmington Casualty Company, Fidelity and Guaranty Insurance Company, Fidelity and Guaranty Insurance Underwriters, Inc., Seaboard Surety Company, St. Paul Fire and Marine Insurance Company, St. Paul Guardian Insurance Company, St. Paul Mercury Insurance Company, Travelers Casualty and Surety Company, Travelers Casualty and Surety Company of America, and United States Fidelity and Guaranty Company, which resolutions are now in full force and effect, reading as follows:

RESOLVED, that the Chairman, the President, any Vice Chairman, any Executive Vice President, any Senior Vice President, any Vice President, any Second Vice President, the Treasurer, any Assistant Treasurer, the Corporate Secretary or any Assistant Secretary may appoint Attorneys-in-Fact and Agents to act for and on behalf of the Company and may give such appointee such authority as his or her certificate of authority may prescribe to sign with the Company's name and seal with the Company's seal bonds, recognizances, contracts of indemnity, and other writings obligatory in the nature of a bond, recognizance, or conditional undertaking, and any of said officers or the Board of Directors at any time may remove any such appointee and revoke the power given him or her; and it is

FURTHER RESOLVED, that the Chairman, the President, any Vice Chairman, any Executive Vice President, any Senior Vice President or any Vice President may delegate all or any part of the foregoing authority to one or more officers or employees of this Company, provided that each such delegation is in writing and a copy thereof is filed in the office of the Secretary; and it is

FURTHER RESOLVED, that any bond, recognizance, contract of indemnity, or writing obligatory in the nature of a bond, recognizance, or conditional undertaking shall be valid and binding upon the Company when (a) signed by the President, any Vice Chairman, any Executive Vice President, any Senior Vice President or any Vice President, any Second Vice President, the Treasurer, any Assistant Treasurer, the Corporate Secretary or any Assistant Secretary and duly attested and sealed with the Company's seal by a Secretary or Assistant Secretary; or (b) duly executed (under seal, if required) by one or more Attorneys-in-Fact and Agents pursuant to the power prescribed in his or her certificate or their certificates of authority or by one or more Company officers pursuant to a written delegation of authority; and it is

FURTHER RESOLVED, that the signature of each of the following officers: President, any Executive Vice President, any Senior Vice President, any Vice President, any Assistant Vice President, any Secretary, any Assistant Secretary, and the seal of the Company may be affixed by facsimile to any power of attorney or to any certificate relating thereto appointing Resident Vice Presidents, Resident Assistant Secretaries or Attorneys-in-Fact for purposes only of executing and attesting bonds and undertakings and other writings obligatory in the nature thereof, and any such power of attorney or certificate bearing such facsimile signature or facsimile seal shall be valid and binding upon the Company and any such power so executed and certified by such facsimile signature and facsimile seal shall be valid and binding on the Company in the future with respect to any bond or understanding to which it is attached.

I, Kori M. Johanson, the undersigned, Assistant Secretary, of Farmington Casualty Company, Fidelity and Guaranty Insurance Company, Fidelity and Guaranty Insurance Underwriters, Inc., Seaboard Surety Company, St. Paul Fire and Marine Insurance Company, St. Paul Guardian Insurance Company, St. Paul Mercury Insurance Company, Travelers Casualty and Surety Company, Travelers Casualty and Surety Company of America, and United States Fidelity and Guaranty Company do hereby certify that the above and foregoing is a true and correct copy of the Power of Attorney executed by said Companies, which is in full force and effect and has not been revoked.

IN TESTIMONY WHEREOF, I have hereunto set my hand and affixed the seals of said Companies this 4th day of March, 2009.

WARNING: THIS POWER OF ATTORNEY IS INVALID WITHOUT THE RED BORDER

Kori M. Johanson, Assistant Secretary



To verify the authenticity of this Power of Attorney, call 1-800-421-3880 or contact us at www.travelersbond.com. Please refer to the Attorney-In-Fact number, the above-named individuals and the details of the bond to which the power is attached.



State of West Virginia
DRUG FREE WORKPLACE CONFORMANCE AFFIDAVIT
West Virginia Code §21-1D-5

STATE OF WEST VIRGINIA,

COUNTY OF JACKSON, TO-WIT:

I, CHARLES L. MCBRYEN, after being first duly sworn, depose and state as follows:

- 1. I am an employee of West Virginia Signal & Light, inc.; and,
(Company Name)
- 2. I do hereby attest that West Virginia Signal & Light, inc.
(Company Name)

maintains a valid written drug free workplace policy and that such policy is in compliance with **West Virginia Code §21-1D-5**.

The above statements are sworn to under the penalty of perjury.

West Virginia Signal & Light, inc.
(Company Name)

By: [Signature]

Title: PRESIDENT

Date: 3/4/09

Taken, subscribed and sworn to before me this 4th day of March 2009.

By Commission expires June 18, 2014

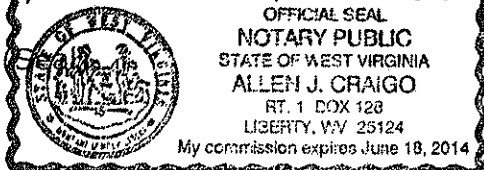

[Signature]
(Notary Public)

THIS AFFIDAVIT MUST BE SUBMITTED WITH THE BID IN ORDER TO COMPLY WITH WV CODE PROVISIONS. FAILURE TO INCLUDE THE AFFIDAVIT WITH THE BID SHALL RESULT IN DISQUALIFICATION OF THE BID.

STATE OF WEST VIRGINIA
Purchasing Division

PURCHASING AFFIDAVIT

VENDOR OWING A DEBT TO THE STATE:

West Virginia Code §5A-3-10a provides that: No contract or renewal of any contract may be awarded by the state or any of its political subdivisions to any vendor or prospective vendor when the vendor or prospective vendor or a related party to the vendor or prospective vendor is a debtor and the debt owed is an amount greater than one thousand dollars in the aggregate.

PUBLIC IMPROVEMENT CONTRACTS & DRUG-FREE WORKPLACE ACT:

If this is a solicitation for a public improvement construction contract, the vendor, by its signature below, affirms that it has a written plan for a drug-free workplace policy in compliance with Article 1D, Chapter 21 of the *West Virginia Code*. The vendor **must** make said affirmation with its bid submission. Further, public improvement construction contract may not be awarded to a vendor who does not have a written plan for a drug-free workplace policy in compliance with Article 1D, Chapter 21 of the *West Virginia Code* and who has not submitted that plan to the appropriate contracting authority in timely fashion. For a vendor who is a subcontractor, compliance with Section 5, Article 1D, Chapter 21 of the *West Virginia Code* may take place before their work on the public improvement is begun.

ANTITRUST:

In submitting a bid to any agency for the state of West Virginia, the bidder offers and agrees that if the bid is accepted the bidder will convey, sell, assign or transfer to the state of West Virginia all rights, title and interest in and to all causes of action it may now or hereafter acquire under the antitrust laws of the United States and the state of West Virginia for price fixing and/or unreasonable restraints of trade relating to the particular commodities or services purchased or acquired by the state of West Virginia. Such assignment shall be made and become effective at the time the purchasing agency tenders the initial payment to the bidder.

I certify that this bid is made without prior understanding, agreement, or connection with any corporation, firm, limited liability company, partnership or person or entity submitting a bid for the same materials, supplies, equipment or services and is in all respects fair and without collusion or fraud. I further certify that I am authorized to sign the certification on behalf of the bidder or this bid.

LICENSING:

Vendors must be licensed and in good standing in accordance with any and all state and local laws and requirements by any state or local agency of West Virginia, including, but not limited to, the West Virginia Secretary of State's Office, the West Virginia Tax Department, West Virginia Insurance Commission, or any other state agencies or political subdivision. Furthermore, the vendor must provide all necessary releases to obtain information to enable the Director or spending unit to verify that the vendor is licensed and in good standing with the above entities.

CONFIDENTIALITY:

The vendor agrees that he or she will not disclose to anyone, directly or indirectly, any such personally identifiable information or other confidential information gained from the agency, unless the individual who is the subject of the information consents to the disclosure in writing or the disclosure is made pursuant to the agency's policies, procedures and rules. Vendor further agrees to comply with the Confidentiality Policies and Information Security Accountability Requirements, set forth in <http://www.state.wv.us/admin/purchase/privacy/noticeConfidentiality.pdf>.

Under penalty of law for false swearing (*West Virginia Code* §61-5-3), it is hereby certified that the vendor affirms and acknowledges the information in this affidavit and is in compliance with the requirements as stated.

Vendor's Name: West Virginia Signal & Light, Inc.

Authorized Signature: Vance Fitzsimmons

Date: 3/3/09