



State of West Virginia  
 Department of Administration  
 Purchasing Division  
 2019 Washington Street East  
 Post Office Box 50130  
 Charleston, WV 25305-0130

# Request for Quotation

RFQ NUMBER  
**06900194**

PAGE  
**1**

ADDRESS CORRESPONDENCE TO ATTENTION OF:  
**MICHAEL AUSTIN**  
**304-558-2402**

VENDOR

\*709042451      304-425-8955  
 EASTERN VAULT COMPANY INC  
 PO BOX 1134  
  
 PRINCETON WV 24740

SHIP TO

DIVISION OF HIGHWAYS  
 JOBSITE  
 SEE SPECIFICATIONS

DATE PRINTED	TERMS OF SALE	SHIP VIA	F.O.B.	FREIGHT TERMS
12/14/2008	NET 30	OUR TRUCK	JOBSITE	NET 30

BID OPENING DATE: **01/14/2009**      BID OPENING TIME **01:30PM**

LINE	QUANTITY	UOP	CAT NO	ITEM NUMBER	UNIT PRICE	AMOUNT
0001	1	JB		210-16	\$ 149,671.20	\$ 149,671.20
PRESTRESSED CONCRETE BEAMS WITH ACCESSORIES  TO PROVIDE 1956 SF OF PRESTRESSED CONCRETE BEAMS WITH ACCESSORIES. THE BEAMS SHALL BE 42" DEEP X 36" WIDE X 81'-6" LONG. TWO (2) EXTERIOR BEAMS AND SIX (6) INTERIOR BEAMS ARE REQUIRED FOR STATE PROJECT S348-7-10.47, SUGAR CREEK BRIDGE, FOR THE WEST VIRGINIA DIVISION OF HIGHWAYS. PER THE ATTACHED SPECIFICATIONS AND DRAWINGS.  EXHIBIT 10  REQUISITION NO.: .....  ADDENDUM ACKNOWLEDGEMENT  I HEREBY ACKNOWLEDGE RECEIPT OF THE FOLLOWING CHECKED ADDENDUM(S) AND HAVE MADE THE NECESSARY REVISIONS TO MY PROPOSAL, PLANS AND/OR SPECIFICATION, ETC.  ADDENDUM NO.'S: NO. 1 ..... NO. 2 ..... NO. 3 ..... NO. 4 ..... NO. 5 .....						

**RECEIVED**  
 2009 JAN -6 A 9 26  
 PURCHASING DIVISION  
 STATE OF WV

SEE REVERSE SIDE FOR TERMS AND CONDITIONS

SIGNATURE *Brian P. Struble* **BRIAN P. STRUBLE**      TELEPHONE **304-425-8955**      DATE **12-27-08**

TITLE **GENERAL MANAGER**      FEIN **55-0520255**      ADDRESS CHANGES TO BE NOTED ABOVE

WHEN RESPONDING TO RFQ, INSERT NAME AND ADDRESS IN SPACE ABOVE LABELED 'VENDOR'

**GENERAL TERMS & CONDITIONS**  
**REQUEST FOR QUOTATION (RFQ) AND REQUEST FOR PROPOSAL (RFP)**

1. Awards will be made in the best interest of the State of West Virginia.
2. The State may accept or reject in part, or in whole, any bid.
3. All quotations are governed by the *West Virginia Code* and the *Legislative Rules* of the Purchasing Division.
4. Prior to any award, the apparent successful vendor must be properly registered with the Purchasing Division and have paid the required \$125 fee.
5. All services performed or goods delivered under State Purchase Order/Contracts are to be continued for the term of the Purchase Order/Contracts, contingent upon funds being appropriated by the Legislature or otherwise being made available. In the event funds are not appropriated or otherwise available for these services or goods, this Purchase Order/Contract becomes void and of no effect after June 30.
6. Payment may only be made after the delivery and acceptance of goods or services.
7. Interest may be paid for late payment in accordance with the *West Virginia Code*.
8. Vendor preference will be granted upon written request in accordance with the *West Virginia Code*.
9. The State of West Virginia is exempt from federal and state taxes and will not pay or reimburse such taxes.
10. The Director of Purchasing may cancel any Purchase Order/Contract upon 30 days written notice to the seller.
11. The laws of the State of West Virginia and the *Legislative Rules* of the Purchasing Division shall govern all rights and duties under the Contract, including without limitation the validity of this Purchase Order/Contract.
12. Any reference to automatic renewal is hereby deleted. The Contract may be renewed only upon mutual written agreement of the parties.
13. **BANKRUPTCY:** In the event the vendor/contractor files for bankruptcy protection, this Contract may be deemed null and void, and terminated without further order.
14. **HIPAA BUSINESS ASSOCIATE ADDENDUM:** The West Virginia State Government HIPAA Business Associate Addendum (BAA), approved by the Attorney General, and available online at the Purchasing Division's web site (<http://www.state.wv.us/admin/purchase/vrc/hipaa.htm>) is hereby made part of the agreement. Provided that, the Agency meets the definition of a Cover Entity (45 CFR §160.103) and will be disclosing Protected Health Information (45 CFR §160.103) to the vendor.
15. **WEST VIRGINIA ALCOHOL & DRUG-FREE WORKPLACE ACT:** If this Contract constitutes a public improvement construction contract as set forth in Article 1D, Chapter 21 of the West Virginia Code ("The West Virginia Alcohol and Drug-Free Workplace Act"), then the following language shall hereby become part of this Contract: "The contractor and its subcontractors shall implement and maintain a written drug-free workplace policy in compliance with the West Virginia Alcohol and Drug-Free Workplace Act, as set forth in Article 1D, Chapter 21 of the West Virginia Code. The contractor and its subcontractors shall provide a sworn statement in writing, under the penalties of perjury, that they maintain a valid drug-free work place policy in compliance with the West Virginia and Drug-Free Workplace Act. It is understood and agreed that this Contract shall be cancelled by the awarding authority if the Contractor: 1) Fails to implement its drug-free workplace policy; 2) Fails to provide information regarding implementation of the contractor's drug-free workplace policy at the request of the public authority; or 3) Provides to the public authority false information regarding the contractor's drug-free workplace policy."

---

**INSTRUCTIONS TO BIDDERS**

1. Use the quotation forms provided by the Purchasing Division.
2. **SPECIFICATIONS:** Items offered must be in compliance with the specifications. Any deviation from the specifications must be clearly indicated by the bidder. Alternates offered by the bidder as **EQUAL** to the specifications must be clearly defined. A bidder offering an alternate should attach complete specifications and literature to the bid. The Purchasing Division may waive minor deviations to specifications.
3. Complete all sections of the quotation form.
4. Unit prices shall prevail in case of discrepancy.
5. All quotations are considered F.O.B. destination unless alternate shipping terms are clearly identified in the quotation.
6. **BID SUBMISSION:** All quotations must be delivered by the bidder to the office listed below prior to the date and time of the bid opening. Failure of the bidder to deliver the quotations on time will result in bid disqualifications: Department of Administration, Purchasing Division, 2019 Washington Street East, P.O. Box 50130, Charleston, WV 25305-0130.



State of West Virginia  
 Department of Administration  
 Purchasing Division  
 2019 Washington Street East  
 Post Office Box 50130  
 Charleston, WV 25305-0130

# Request for Quotation

RFQ NUMBER  
**06900194**

PAGE  
**2**

ADDRESS CORRESPONDENCE TO ATTENTION OF  
**MICHAEL AUSTIN  
 304-558-2402**

**VENDOR**  
 \*709042451      304-425-8955  
 EASTERN VAULT COMPANY INC  
 PO BOX 1134  
  
 PRINCETON WV 24740

**SHIP TO**  
 DIVISION OF HIGHWAYS  
 JOBSITE  
 SEE SPECIFICATIONS

DATE PRINTED <b>12/14/2008</b>	TERMS OF SALE	SHIP VIA	FOB	FREIGHT TERMS
-----------------------------------	---------------	----------	-----	---------------

BID OPENING DATE: **01/14/2009**      BID OPENING TIME **01:30PM**

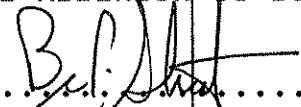
LINE	QUANTITY	UOP	CAT NO	ITEM NUMBER	UNIT PRICE	AMOUNT
<p>I UNDERSTAND THAT FAILURE TO CONFIRM THE RECEIPT OF THE ADDENDUM(S) MAY BE CAUSE FOR REJECTION OF BIDS.</p> <p>VENDOR MUST CLEARLY UNDERSTAND THAT ANY VERBAL REPRESENTATION MADE OR ASSUMED TO BE MADE DURING ANY ORAL DISCUSSION HELD BETWEEN VENDOR'S REPRESENTATIVES AND ANY STATE PERSONNEL IS NOT BINDING. ONLY THE INFORMATION ISSUED IN WRITING AND ADDED TO THE SPECIFICATIONS BY AN OFFICIAL ADDENDUM IS BINDING.</p> <p style="text-align: center;">             .....            SIGNATURE            EASTERN VAULT Co., Inc.            .....            COMPANY            12-27-08            .....            DATE         </p> <p>REV. 11/96</p> <p style="text-align: center;">NOTICE</p> <p>A SIGNED BID MUST BE SUBMITTED TO:</p> <p style="text-align: center;">             DEPARTMENT OF ADMINISTRATION              PURCHASING DIVISION              BUILDING 15              2019 WASHINGTON STREET, EAST              CHARLESTON, WV 25305-0130           </p> <p>THE BID SHOULD CONTAIN THIS INFORMATION ON THE FACE OF</p>						

SEE REVERSE SIDE FOR TERMS AND CONDITIONS

SIGNATURE	TELEPHONE	DATE
TITLE	FERN	ADDRESS CHANGES TO BE NOTED ABOVE

WHEN RESPONDING TO RFQ, INSERT NAME AND ADDRESS IN SPACE ABOVE LABELED 'VENDOR'



State of West Virginia  
 Department of Administration  
 Purchasing Division  
 2019 Washington Street East  
 Post Office Box 50130  
 Charleston, WV 25305-0130

# Request for Quotation

RFQ NUMBER
06900194

PAGE
3

ADDRESS CORRESPONDENCE TO ATTENTION OF
MICHAEL AUSTIN 304-558-2402

VENDOR

\*709042451 304-425-8955  
 EASTERN VAULT COMPANY INC  
 PO BOX 1134  
 PRINCETON WV 24740

STATE TO

DIVISION OF HIGHWAYS  
 JOBSITE  
 SEE SPECIFICATIONS

DATE PRINTED	TERMS OF SALE	SHIP VIA	F.O.B.	FREIGHT TERMS
12/14/2008				

BID OPENING DATE: **01/14/2009** BID OPENING TIME **01:30PM**

LINE	QUANTITY	UOP	CAT NO	ITEM NUMBER	UNIT PRICE	AMOUNT
<p>THE ENVELOPE OR THE BID MAY NOT BE CONSIDERED:            SEALED BID</p> <p>BUYER: 33            RFQ. NO.: 06900194</p> <p>BID OPENING DATE: -----            BID OPENING TIME: -----</p> <p>PLEASE PROVIDE A FAX NUMBER IN CASE IT IS NECESSARY TO CONTACT YOU REGARDING YOUR BID:            ----- 304-425-8955 -----</p> <p>CONTACT PERSON (PLEASE PRINT CLEARLY):            ----- BRIAN P. STRUBE -----</p> <p>***** THIS IS THE END OF RFQ 06900194 ***** TOTAL: <u>\$149,671.20</u></p>						

SEE REVERSE SIDE FOR TERMS AND CONDITIONS		
SIGNATURE	TELEPHONE	DATE
TITLE	FEIN	ADDRESS CHANGES TO BE NOTED ABOVE

WHEN RESPONDING TO RFQ, INSERT NAME AND ADDRESS IN SPACE ABOVE LABELED 'VENDOR'

### 1. DESCRIPTION

The beams shall be 42" deep X 36" wide X 81'-6" long.

Two (2) exterior beams and six (6) interior beams are required.

In addition to the beams the fabricator shall also supply in accordance with the attached plans all associated items included but not limited to the following.

Guardrail Posts and Hardware attached to the exterior beams; Bearing Pads; Anchor Dowels; Post Tensioning Bars with Nuts and Bearing Plates and 2 extra nuts; Sponge Rubber Joint Filler, Washers, and Grout Stop.

### 2. ACCEPTANCE

Cracks developing in a beam may be cause for rejection of the beam. Cracks that are not detrimental to the structural integrity of the beam, as determined by the Division of Highways, may be accepted under the following conditions:

- 1) Cracks of 0.004 inch or less shall be treated with a second coat of a Division of Highways approved concrete sealer.
  - 2) Cracks of greater than 0.004 inch shall be treated by a Division of Highways approved epoxy injection methods.
- All concrete sealer and epoxy injection required for acceptance shall be performed at no additional cost to the Division of Highways.

### 3. DELIVERY

ALL BEAMS AND ACCESSORIES SHALL BE DELIVERED TO THE PROJECT SITE DURING THE WEEK OF JULY 20, 2009.

Upon receipt of a Purchase Order the Vendor shall submit shop drawings to the District Bridge Engineer within fifteen (15) calendar days. Shop drawings must be approved by the Division of Highways prior to the manufacture of any beam sections.

Should the Vendor fail to meet the above delivery schedule, liquidated damages will be assessed in accordance with Section 108.7 of the current Division of Highways Standard Specifications Roads and Bridges.

Sites for delivery of beam sections and accessories under this contract shall be accessible to equipment that is normally and customarily used for transportation of beam sections. Delivery will not be required where gross vehicle loaded weights will exceed the legal road or bridge load. Upon receipt of an approved Purchase Order, the Vendor must notify the District Bridge Engineer within ten (10) calendar days if delivery under the terms of this contract cannot be performed due to weight restrictions or roadway geometrics.

Prior to delivery, all Beams, Accessories and Optional Items shall be tested and accepted in accordance with Section 603 of the Division of Highways Standard Specifications Roads and Bridges adopted 1993, as modified by the July 1, 1998 Supplemental Specifications.

### 4. PARTIAL PAYMENT OF APPROVED BEAMS

Upon completion of manufacture and approval by the Division of Highways of all beams specified on Purchase Order, the vendor may invoice and the Division will pay for the cost of manufacturing the beams, not to exceed 65% of the total cost of the delivered beams. Partial payment for the beams shall be subject to the following conditions:

- a. The vendor must request partial payment and furnish an official invoice for the manufactured and approved beams.
- b. The partial payment invoice shall be accompanied by a surety bond equal to the invoiced amount guaranteeing delivery of all items specified on the Purchase Order.
- c. The vendor shall furnish a statement of approved beams condition and exact storage location.
- d. The vendor shall furnish a legal right-of-entry onto the storage site to Division of Highways' employees and/or agents for the purpose of inspecting, sampling, testing and removing any or all Beams.
- e. The vendor shall certify that the stored beams are suitably marked and identified as property of the Division of Highways and will not be for any purpose not designated by the Division.

No.	1
DATE	11/87
BY	EL
CHKD BY	TLR
TITLE	

Butyl Waterproofing Membrane  
12" Wide Centered Along Full  
Length of Beam & Backwall

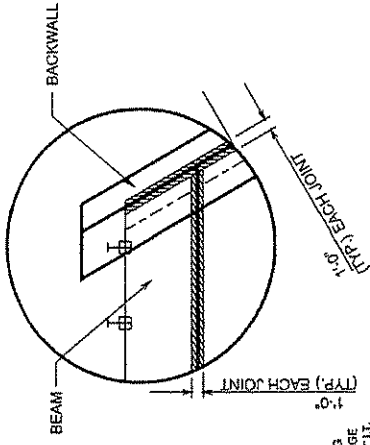

### JOINT WATERPROOFING DETAIL

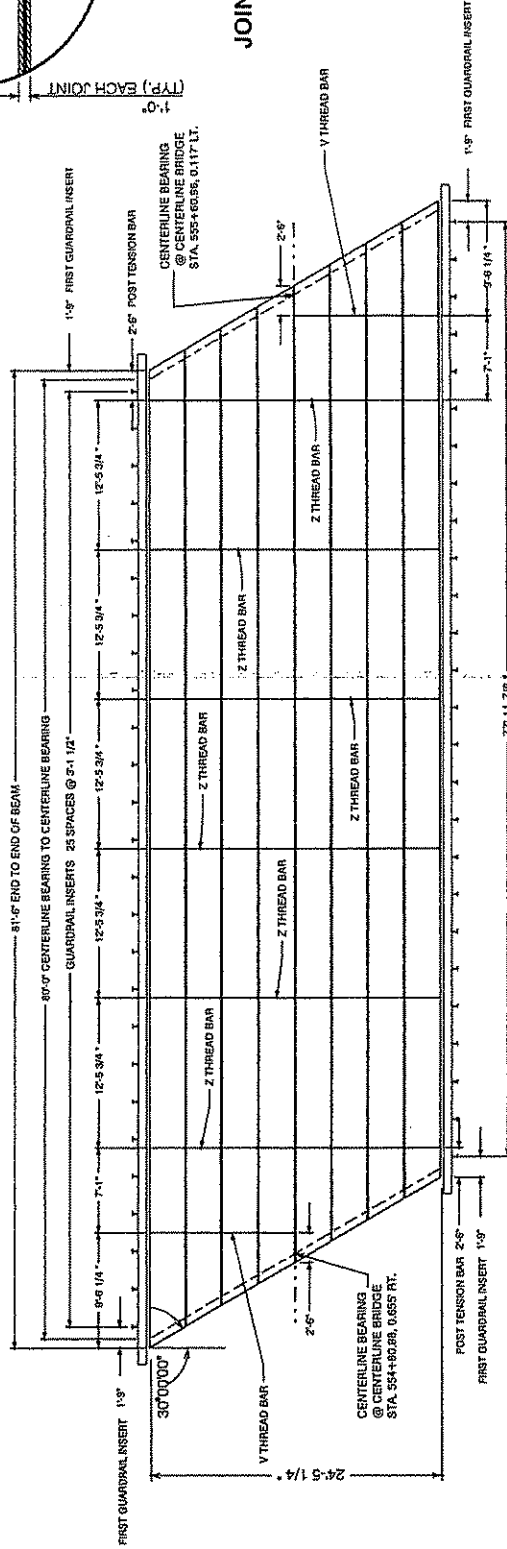

**DECK PLAN**

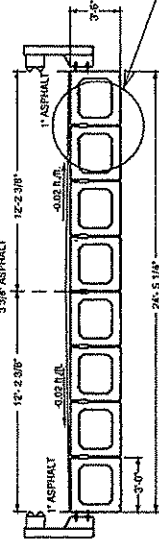

**TYPICAL BRIDGE DECK SECTION**

Grout stop must be removed and  
grout inspected for voids prior to  
post-tensioning. Any voids deeper  
than 2" from the bottom of the beams  
must be re-grouted in a manner  
acceptable to the project engineer.



SUGAR CREEK BRIDGE OVER SUGAR CREEK TYLER COUNTY	
C.R. 17	BEAM LAYOUT
DATE	BY
REVISION	NO.

PROJECT NUMBER	DISTRICT	COUNTY	SHEET TOTAL
STATE	FEDERAL	TYLER	12 21
348-7-18-A7	N/A		

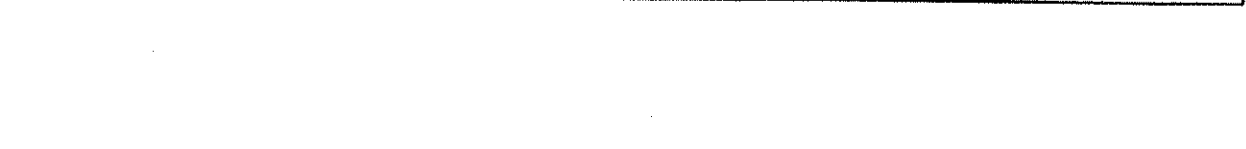
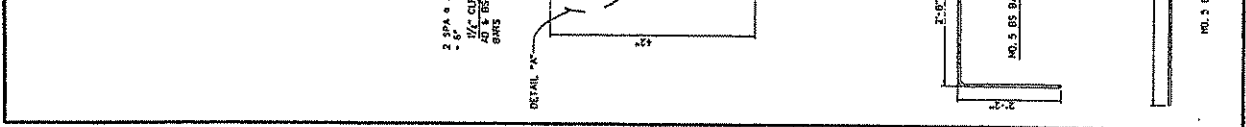
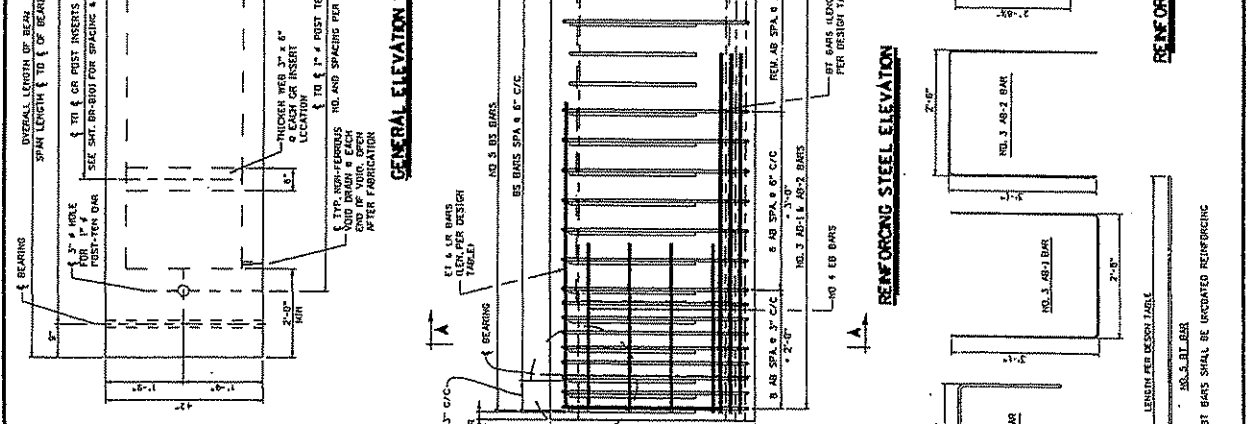
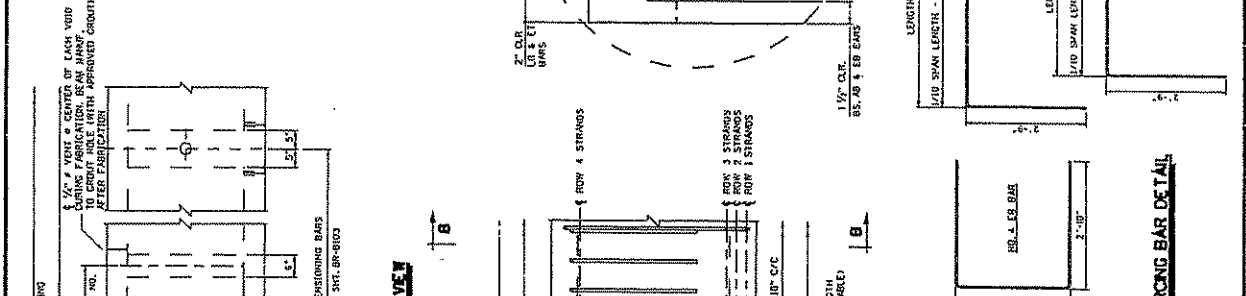
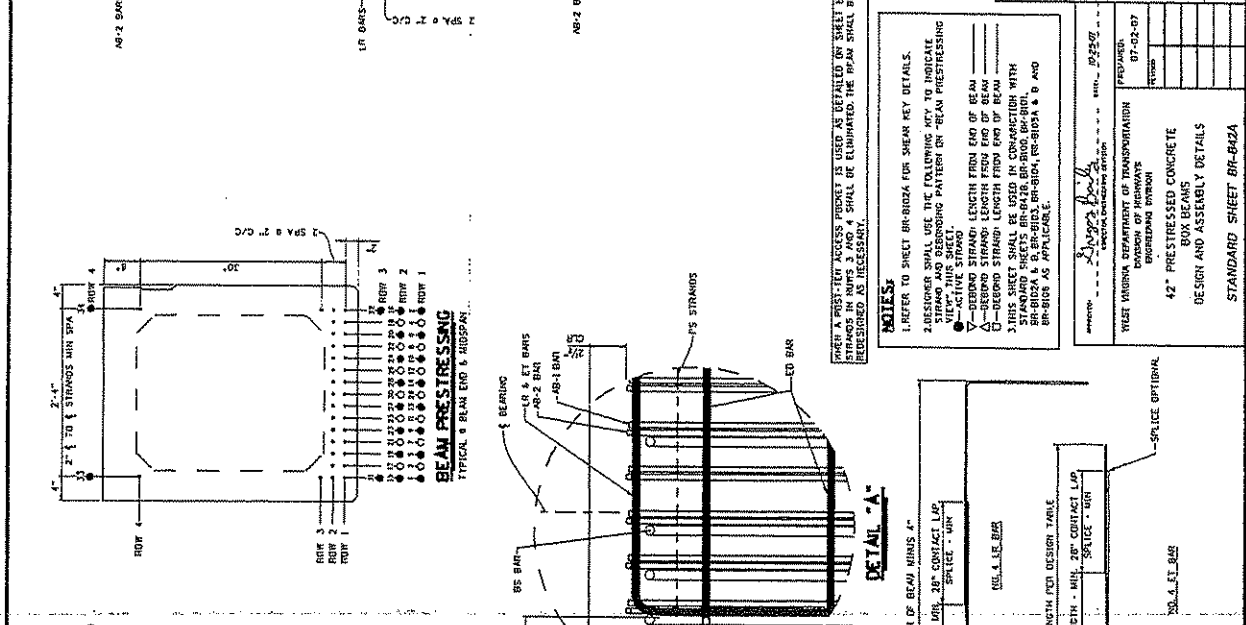

**NOTES:**

- REFER TO SHEET BR-B22A FOR SHEAR KEY DETAILS.
- DESIGNER SHALL USE THE FOLLOWING KEY TO INDICATE STRANDS AND DETERMINE PATTERN ON "BEAM PRESTRESSING STRANDS IN NUMS 3 AND 4 SHALL BE ELIMINATED, THE PLAN SHALL BE REDESIGNED AS NECESSARY.
- KEY:

WEST VIRGINIA DEPARTMENT OF TRANSPORTATION  
 ENGINEERING DIVISION

SUGAR CREEK BRIDGE  
 OVER SUGAR CREEK  
 TYLER CO. C.R. 7

DESIGNED BY: 10/22/77  
 CHECKED BY: 10/22/77  
 REVISIONS: 10/22/77  
 DATE: 09-68  
 SCALE: 1/8" = 1'-0"  
 SHEET NO. 12 OF 21  
 DRAWING NO. 10227

42" PRESTRESSED CONCRETE  
 BOX BEAMS  
 DESIGN AND ASSEMBLY DETAILS  
 STANDARD SHEET BR-B22A

DESIGN DATA FOR 42" DEPTH ADJACENT BOX BEAM

STATE PROJECT NUMBER 5318-7-10-41  
 DRAWING PROJECT NUMBER N/A  
 COUNTY TYLER  
 SHEET NO. 13  
 TOTAL SHEETS 27

MIN. CONCRETE STRENGTH @ RELEASE - 5000 PSI  
 MIN. CONCRETE STRENGTH @ 28 DAYS - 8000 PSI  
 INITIAL PULL/STRAND - 33,820 LBS  
 CROSS-SECTION AREA/STRAND - 0.167 SQ. IN.

SPAN LENGTH & TO & BEARING	76'-0"	78'-0"	80'-0"	82'-0"	84'-0"	86'-0"	88'-0"	90'-0"	92'-0"	94'-0"	96'-0"	98'-0"	100'-0"
OVERALL LENGTH OF BEAM	77'-6"	79'-6"	81'-6"	83'-6"	85'-6"	87'-6"	89'-6"	91'-6"	93'-6"	95'-6"	97'-6"	99'-6"	101'-6"
NO. OF 270 KSI, 1/2" x 4 LOW-RELAXATION STRANDS, AREA/STRAND - 0.167 SQ. IN.	10	20	20	20	20	20	20	20	20	20	20	20	20
ROW 1	14,266.00	14,266.00	14,266.00	14,266.00	14,266.00	14,266.00	14,266.00	14,266.00	14,266.00	14,266.00	14,266.00	14,266.00	14,266.00
ROW 2	15,162.00	15,162.00	15,162.00	15,162.00	15,162.00	15,162.00	15,162.00	15,162.00	15,162.00	15,162.00	15,162.00	15,162.00	15,162.00
ROW 3	31,524.00	31,524.00	31,524.00	31,524.00	31,524.00	31,524.00	31,524.00	31,524.00	31,524.00	31,524.00	31,524.00	31,524.00	31,524.00
ROW 4	33,334.00	33,334.00	33,334.00	33,334.00	33,334.00	33,334.00	33,334.00	33,334.00	33,334.00	33,334.00	33,334.00	33,334.00	33,334.00
UNSTRESSING FORCE IMMEDIATELY AFTER STRAND RELEASE, (PL KIPS/BEAM)	65	65	65	65	65	65	65	65	65	65	65	65	65
EFFECTIVE PRESTRESSING FORCE AFTER ALL LOSSES, (PL KIPS/BEAM)	53	53	53	53	53	53	53	53	53	53	53	53	53
REQUIRED FACTORED MOMENT & STRENGTH, (PL FT-KIPS/BEAM)	100	100	100	100	100	100	100	100	100	100	100	100	100
FACTORED FLEXURAL RESISTANCE, (PL FT-KIPS/BEAM)	200	200	200	200	200	200	200	200	200	200	200	200	200
TOTAL NO. OF BEARING STRANDS	2	2	2	2	2	2	2	2	2	2	2	2	2
REQUIRED STRAND POSITION FROM EACH END	5.0	5.0	5.0	5.0	5.0	5.0	5.0	5.0	5.0	5.0	5.0	5.0	5.0
NUMBER & LENGTH #1 ET TOP TENSION BARS @ EACH END	3 #4	3 #4	3 #4	3 #4	3 #4	3 #4	3 #4	3 #4	3 #4	3 #4	3 #4	3 #4	3 #4
NUMBER & LENGTH #5 BT BOTTOM TENSION BARS @ EACH END	3 #5	3 #5	3 #5	3 #5	3 #5	3 #5	3 #5	3 #5	3 #5	3 #5	3 #5	3 #5	3 #5
DESIGN CAMBER (POSITIVE UP)	0.36	0.36	0.36	0.36	0.36	0.36	0.36	0.36	0.36	0.36	0.36	0.36	0.36
# OF INSERTS REQ'D	0.04	0.04	0.04	0.04	0.04	0.04	0.04	0.04	0.04	0.04	0.04	0.04	0.04
END OF BEAM TO # OF FIRST INSERT	1'-9"	1'-9"	1'-9"	1'-9"	1'-9"	1'-9"	1'-9"	1'-9"	1'-9"	1'-9"	1'-9"	1'-9"	1'-9"
SEE NOTE 6	3'-1 1/2"	3'-1 1/2"	3'-1 1/2"	3'-1 1/2"	3'-1 1/2"	3'-1 1/2"	3'-1 1/2"	3'-1 1/2"	3'-1 1/2"	3'-1 1/2"	3'-1 1/2"	3'-1 1/2"	3'-1 1/2"
WEIGHT OF TYPICAL BEAM INCLUDING DIMENSION ITEMS	5.98	5.98	5.98	5.98	5.98	5.98	5.98	5.98	5.98	5.98	5.98	5.98	5.98

NOTES

1. BEAM WEIGHTS LISTED IN THE DESIGN TABLE ARE BASED ON ZERO SKEW, 2 FT. LONG ENDOCK AND DIAPHRAGMS SPACED @ 15 FT C/C. WEIGHTS FOR SKEWED BEAMS, LONGER ENDOCKS AND ADDITIONAL DIAPHRAGMS SHOULD BE ADJUSTED ACCORDINGLY.
2. DESIGNER SHOULD NOTE THAT DATA IN STANDARD TABLE IS BASED ON EVEN SPAN LENGTHS. FOR NON-STANDARD BEAMS AND ZERO SKEW, SUPERIMPOSED DEAD LOADS INCLUDE TYPE F PARAPET (221 PLF) AND A FWS OF 50 PSF. FOR NON-STANDARD BEAMS DATA SHOULD BE VERIFIED AND IF REQUIRED NEW DESIGN DATA ENTERED INTO BLANK COLUMNS. IN NO CASE SHALL THE STANDARD DESIGN TABLE BE ALTERED.
3. PREDICTED DESIGN CAMBER VALUES LISTED IN THE TABLE ARE BASED ON EMPIRICAL FORMULAS AND AS SUCH ARE APPROXIMATE. FOR MEMBERS WITH SPAN-TO-DEPTH RATIOS AT OR EXCEEDING 20, THE TOLERANCE VALUES LISTED IN APPENDIX B OF PCI MANUAL FOR QUALITY CONTROL, MAY-1988, MAY BE USED FOR COMPARISON TO PREDICTED DESIGN VALUES SHOULD BE EVALUATED UNDER CONDITIONS WITHIN 72 HOURS OF RELEASE. ADDITIONALLY, CAMBER SHOULD BE EVALUATED UNDER CONDITIONS THAT MINIMIZE THE EFFECT OF TEMPERATURE VARIATION.
4. DESIGNER, FABRICATOR, AND ERECTOR SHALL BE AWARE THAT SKEWED END BEAMS MAY TWIST OR WARP, CAUSING UNEVEN BEAM SEATING AT THE BEARINGS. THE CONTRACTOR IS REQUIRED TO CORRECT AT THE TIME OF ERECTION, BEFORE THE BEAMS ARE SECURED IN PLACE. METHOD OF CORRECTION SHALL PROVIDE AN EVEN, TOTAL BEARING SURFACE LEVEL AND BEARING CAPACITY. CORRECTIONS SHALL BE MADE BY THE FABRICATOR SHALL NOTIFY THE CONTRACTOR AND DESIGNER. IF CORRECTIONS ARE REQUIRED PRIOR TO SHIPMENT.
5. MAXIMUM BEAM SKEW SHALL BE 30 DEGREES.
6. DESIGNER INPUT VALUES OF NUMBER OF INSERTS, DISTANCE FROM END OF BEAM TO # FIRST INSERT, AND # SECOND INSERT, ABOVE VALUES SHALL BE BASED ON THE REQUIRED R-3" CONCRETE POST SPACING ACROSS THE BEAMS.
7. THIS SHEET SHALL BE USED IN CONJUNCTION WITH STANDARD SHEETS BR-842A, BR-802, BR-801, BR-802A & B, BR-803, BR-804, BR-804A & B AND BR-805 AS APPLICABLE.

WEST VIRGINIA DEPARTMENT OF TRANSPORTATION  
 DIVISION OF HIGHWAYS  
 ENGINEERING DIVISION

SUGAR CREEK BRIDGE  
 OVER SUGAR CREEK  
 TYLER CO. C.R. 7  
 DESIGN TABLE FOR 42"  
 PRESTRESSED BOX BEAM  
 STANDARD SHEET BR-842B

10227





SHEET NO.	PROJECT NUMBER	FEEDBACK PROJECT NUMBER	SHEET TITLE	QUANTITY	SHEET NO.
5548-3-10-47	N/A	N/A	6	TYLER	15

DESCRIPTION	UNIT	VALUE	REMARKS
SPICAL BEAM LENGTH	A	8' 1" - 6"	
SPAN LENGTH, PARALLEL TO BEARING	B	80' - 0"	
BEARING CENTERLINE TO FACE OF BEAM	C	24' - 5 1/4"	
ROADWAY WIDTH TO FACE OF PARAPET	D	24' - 4 1/2"	
NUMBER OF BEAMS REQUIRED	B		
BEAM SIZE (WIDTH x DEPTH)		3' - 0" x 42"	
MINIMUM BEARING DEPTH	E	30"	
PERPENDICULAR DISTANCE FROM FACE OF BEAM TO BEARING	F	7 1/2"	
HUB BEARING COURSE REQUIRED (YES/NO)	YES		
PROPOSED OR BEARING COURSE	G	3 3/4"	
THICKNESS OF BEARING COURSE	H	1"	
11-2 BRIDGE DIMENSION SYSTEM	YES		
FABRICATOR TO SUPPLY 11-2 BRIDGE DIMENSION SYSTEM	YES		
FABRICATOR TO SUPPLY 11-2 BRIDGE DIMENSION SYSTEM	NO		
NUMBER OF CHORDAL BEAMS	26		
NUMBER OF CHORDAL BEAMS	NO		
NUMBER OF BRAGS REQUIRED	NO		
NUMBER OF BRAGS REQUIRED	0		
10" CURB REQUIRED (YES/NO)	NO		

WEST VIRGINIA DEPARTMENT OF TRANSPORTATION  
DIVISION OF HIGHWAYS  
ENGINEERING DIVISION

SUGAR CREEK BRIDGE  
OVER SUGAR CREEK  
TYLER CO. C.R. 7  
PRESTRESSED CONCRETE BEAM  
DESIGN & ASSEMBLY NOTES

10/27

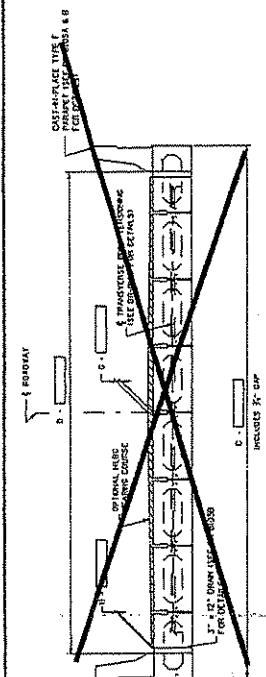

TYPICAL CROSS-SECTION WITH PARAPET OR CURB

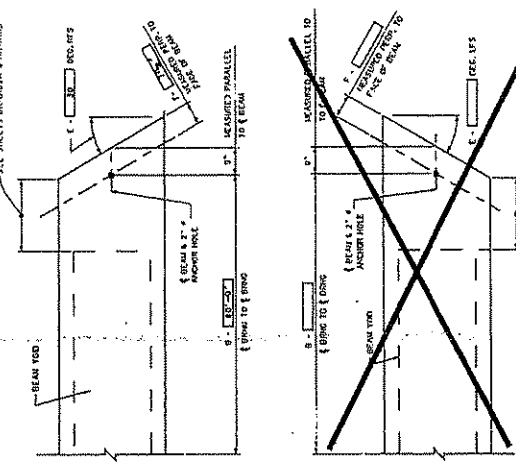

BEAM PLAN VIEW - SKEWED ENDS

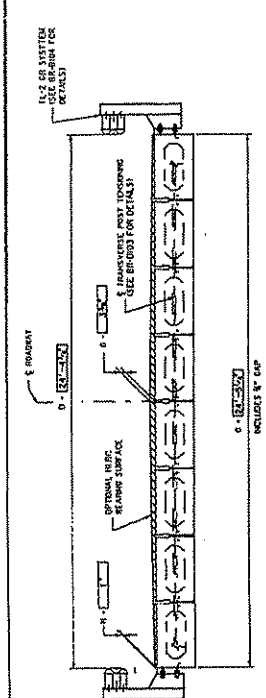

TYPICAL CROSS-SECTION WITH CHORD RAIL

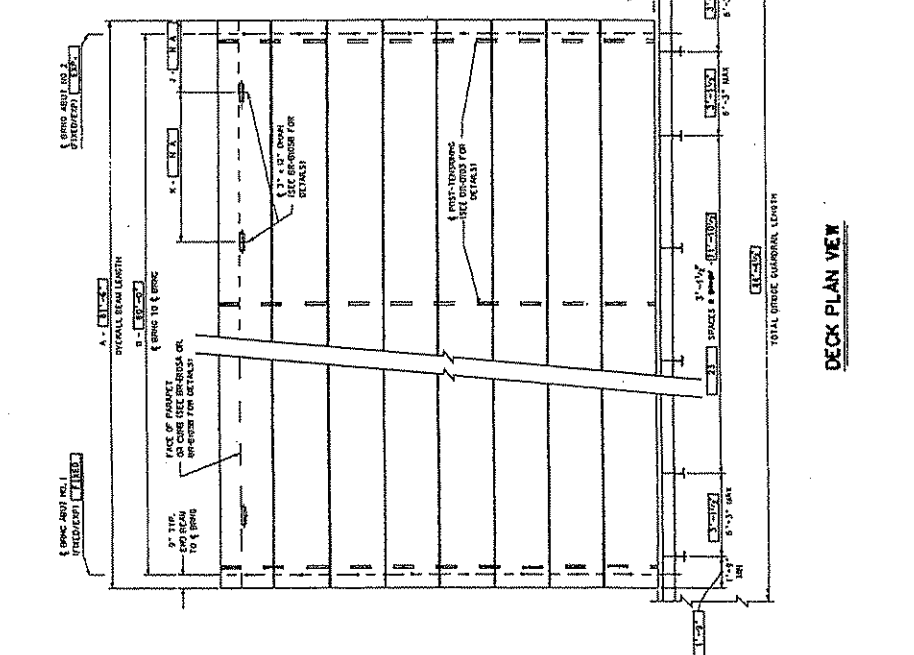

DECK PLAN VIEW

ITEM NO.	DESCRIPTION	UNITS	QUANTITY
6500P	PRESTRESSED CONCRETE FOR BEAM	LF	652

WEST VIRGINIA DEPARTMENT OF TRANSPORTATION  
DIVISION OF HIGHWAYS  
ENGINEERING DIVISION

DESIGN AND ASSEMBLY NOTES

STANDARD SHEET BR-0101

- NOTES:
1. EACH BEAM COURSE CHORDAL IS TO BE SUPPLIED BY THE BEAM FABRICATOR. COST OF ALL BEAM CHORDAL ITEMS TO INCLUDE POINTS, PINS, ELEMENTS, ATTACHMENT HARDWARE, AND MATERIALS TO BE USED IN NEW BRIDGE PRESTRESSED CONCRETE BOX BEAM.
  2. THIS SHEET SHALL BE USED IN CONSTRUCTION WITH STANDARD SHEETS BR-0101A & B THRU BR-0106 & B, BR-0106A & B, BR-0103, BR-0104, BR-0104A & B AND BR-0106.

STATE	COUNTY	TITLE	SHEET TOTAL
PROJECT NUMBER	PROJECT NUMBER	DATE	NO. SHEETS
5348-7-10-47	N/A	6	16
		TYLER	27

7. 4 STRAND LTRG LGDS EMBEDDED FLUSH WITH BOTTOM OF 2" O.D. A MINIMUM OF 25 KNOTS. THE NUMBER OF STRANDS PER SHE SHALL BE DETERMINED BY THE FABRICATOR.

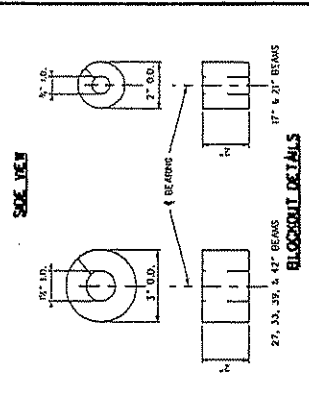
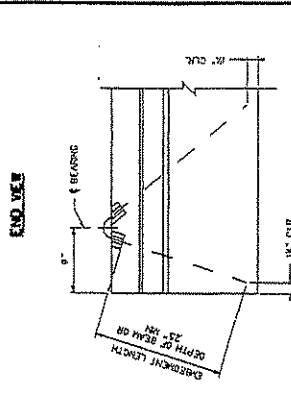
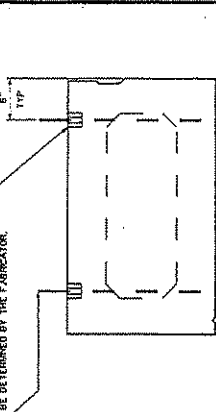

WEST VIRGINIA DEPARTMENT OF TRANSPORTATION DIVISION OF HIGHWAYS ENGINEERING DIVISION	
DESIGNED BY: T87	DRAWN BY: T87
CHECKED BY: T87	REVIEWED BY: T87
DATE: 8-28-88	SCALE:
SHEET NO. 27	C.R. 7
BRIDGE NO. 10227	PRE-STRESSED CONCRETE BEAM SKEWED END REINFORCING MISC. DESIGN AND ASSEMBLY DETAILS

AT FIELD OF 11' 2" ANCHOR W/ 2" DIA. PORTLAND CEMENT ANCHOR MEETING THE REQUIREMENTS OF 508-SECT. 145.3. 5/16" DIA. JOINT FILLER MEETING THE REQUIREMENTS OF 508-SECT. 708.3.

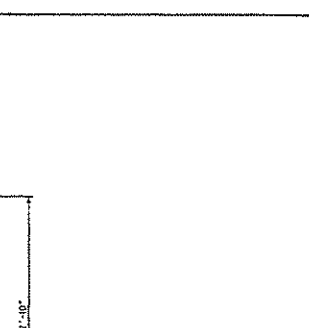
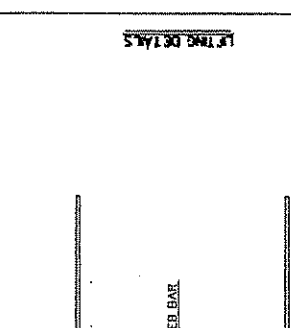
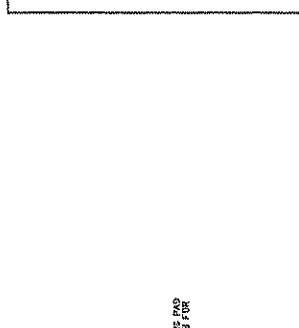

PREPARED BY: T87	DATE: 07-02-07
WEST VIRGINIA DEPARTMENT OF TRANSPORTATION DIVISION OF HIGHWAYS ENGINEERING DIVISION	
PRESTRESSED CONCRETE BEAM SKEWED END REINFORCING MISC. DESIGN AND ASSEMBLY DETAILS	
STANDARD SHEET BR-1102A	

SEAL JOINT WITH HOT POUR EPDM RUBBER SEALANT MEETING THE REQUIREMENTS OF 508-SECT. 709.3. MIN. DEPTH OF SEAL 1" MIN.

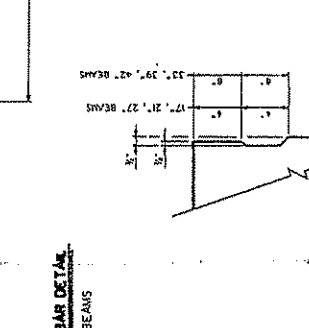
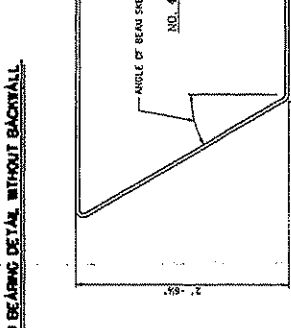
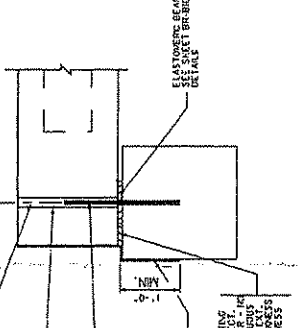

WEST VIRGINIA DEPARTMENT OF TRANSPORTATION DIVISION OF HIGHWAYS ENGINEERING DIVISION	
DESIGNED BY: T87	DATE: 07-02-07
CHECKED BY: T87	REVIEWED BY: T87
DATE: 8-28-88	SCALE:
SHEET NO. 27	C.R. 7
BRIDGE NO. 10227	PRE-STRESSED CONCRETE BEAM SKEWED END REINFORCING MISC. DESIGN AND ASSEMBLY DETAILS

SEAL JOINT WITH HOT POUR EPDM RUBBER SEALANT MEETING THE REQUIREMENTS OF 508-SECT. 709.3. MIN. DEPTH OF SEAL 1" MIN.

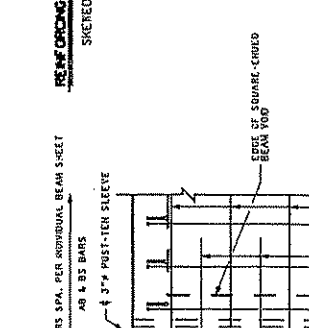
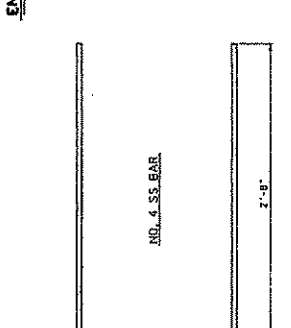
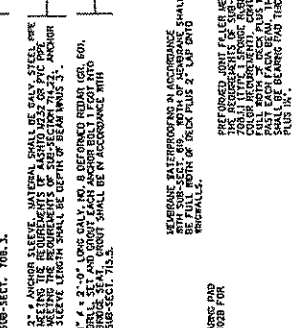

WEST VIRGINIA DEPARTMENT OF TRANSPORTATION DIVISION OF HIGHWAYS ENGINEERING DIVISION	
DESIGNED BY: T87	DATE: 07-02-07
CHECKED BY: T87	REVIEWED BY: T87
DATE: 8-28-88	SCALE:
SHEET NO. 27	C.R. 7
BRIDGE NO. 10227	PRE-STRESSED CONCRETE BEAM SKEWED END REINFORCING MISC. DESIGN AND ASSEMBLY DETAILS

SEAL JOINT WITH HOT POUR EPDM RUBBER SEALANT MEETING THE REQUIREMENTS OF 508-SECT. 709.3. MIN. DEPTH OF SEAL 1" MIN.

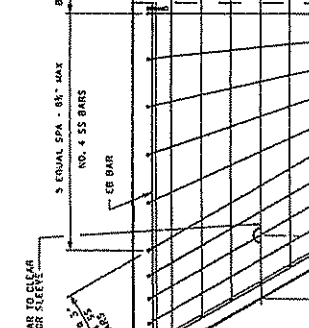
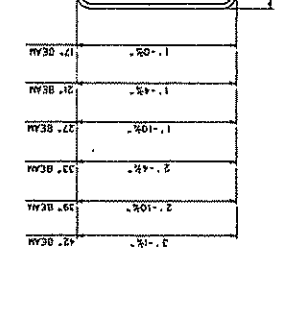
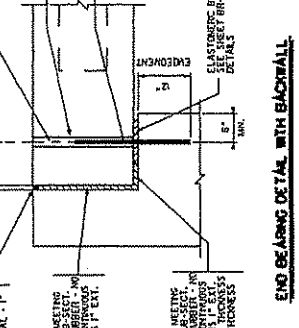

WEST VIRGINIA DEPARTMENT OF TRANSPORTATION DIVISION OF HIGHWAYS ENGINEERING DIVISION	
DESIGNED BY: T87	DATE: 07-02-07
CHECKED BY: T87	REVIEWED BY: T87
DATE: 8-28-88	SCALE:
SHEET NO. 27	C.R. 7
BRIDGE NO. 10227	PRE-STRESSED CONCRETE BEAM SKEWED END REINFORCING MISC. DESIGN AND ASSEMBLY DETAILS

SEAL JOINT WITH HOT POUR EPDM RUBBER SEALANT MEETING THE REQUIREMENTS OF 508-SECT. 709.3. MIN. DEPTH OF SEAL 1" MIN.



WEST VIRGINIA DEPARTMENT OF TRANSPORTATION DIVISION OF HIGHWAYS ENGINEERING DIVISION	
DESIGNED BY: T87	DATE: 07-02-07
CHECKED BY: T87	REVIEWED BY: T87
DATE: 8-28-88	SCALE:
SHEET NO. 27	C.R. 7
BRIDGE NO. 10227	PRE-STRESSED CONCRETE BEAM SKEWED END REINFORCING MISC. DESIGN AND ASSEMBLY DETAILS





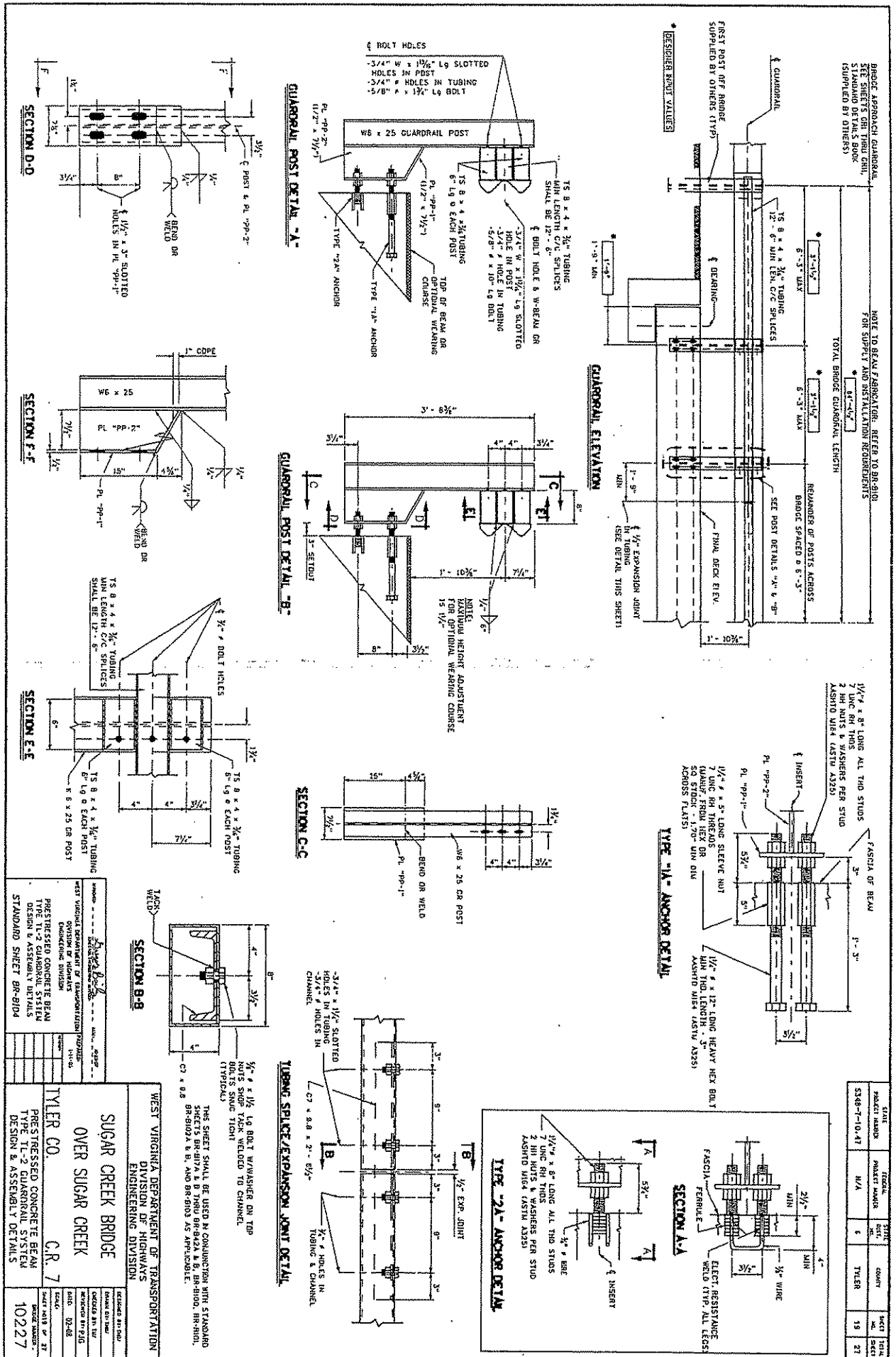

1/2"  $\phi$  6" LONG ALL THD STUDS  
2 HR NUTS & WASHERS PER STUD  
ASHTD WIRE (ASTM A325)

1/2"  $\phi$  x 5" LONG HEAVY HEX BOLT  
7 LONG HR THROUS  
NO STOPPED END OR  
45 $\circ$  MIN DIA  
ACROSS FLAT

ITEM	QUANTITY	UNIT	TOTAL
PROJECT NUMBER	6		
PROJECT NAME	6		
DATE	6		
DIST.	6		
TYLER	19		27

WEST VIRGINIA DEPARTMENT OF TRANSPORTATION  
DIVISION OF HIGHWAYS  
ENGINEERING DIVISION

DESIGNED BY	TYLER CO.
CHECKED BY	C.R. 7
DATE	10-22-77
PROJECT	SUGAR CREEK BRIDGE OVER SUGAR CREEK
DESCRIPTION	PRESTRESSED CONCRETE BEAM TYPE 11-2 GUARDRAIL SYSTEM DESIGN & ASSEMBLY DETAILS
STANDARD SHEET	BR-810A
WORK NUMBER	10227

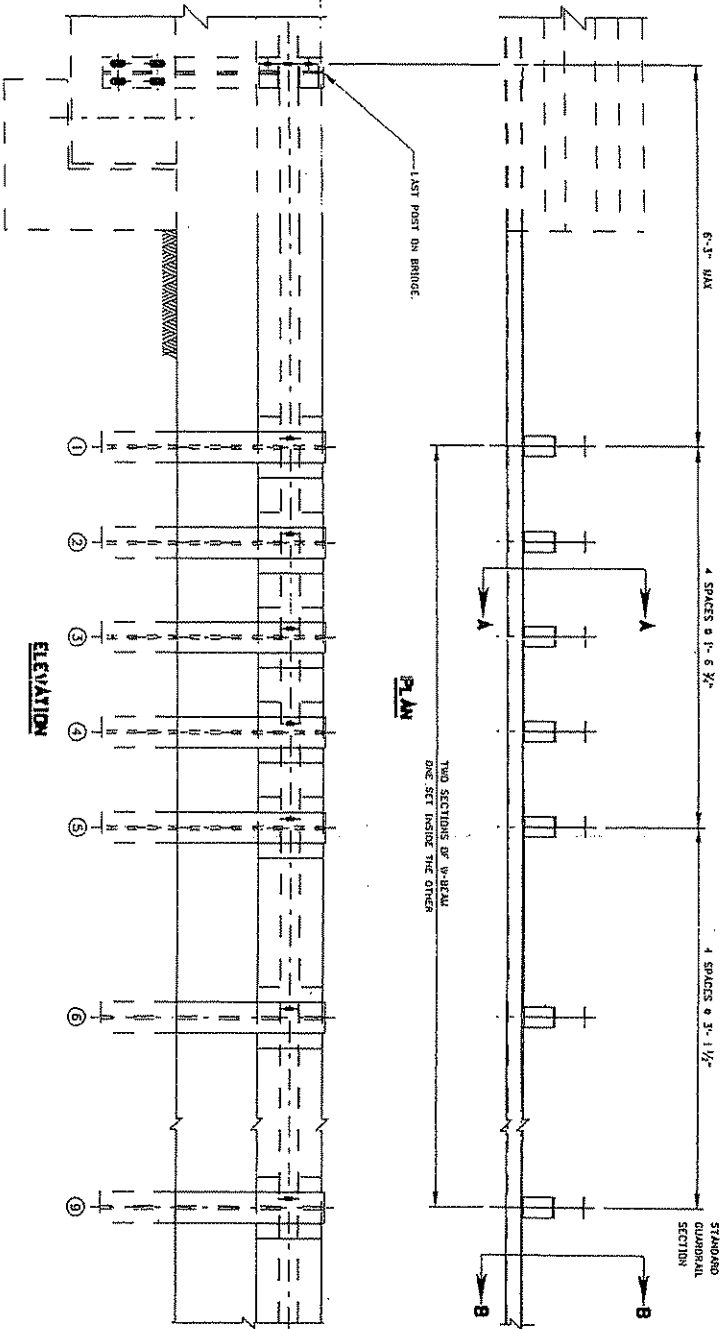

SECTION A-A

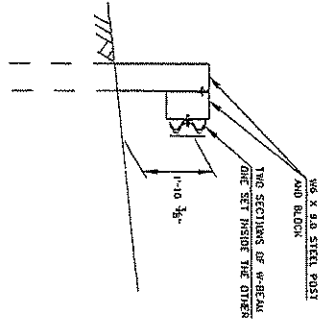

SECTION B-B

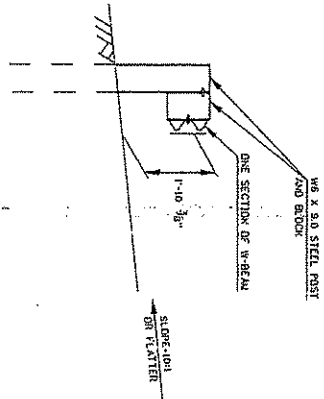

PROJECT NUMBER		DISTRICT	COUNTY	SHEET NO.	TOTAL
STATE	FEDERAL				
3348-7-18-47	N/A	6	TYLER	20	27

**NOTES**

1. THIS GUARDRAIL TRANSITION IS APPROPRIATE FOR CONNECTION TO GUARDRAIL ON BRIDGE.
2. W-BEAM IS NOT BOLTED TO POSTS AT POSTS 2 THROUGH 4 AND POST 6.
3. SEE STANDARD SHEET BR-B104 FOR ANCHOR DETAILS.
4. THERE IS NO SEPARATE PAY ITEM FOR THIS CONNECTION AND ALL COMPONENTS AS DETAILED HEREIN SHALL BE INCLUDED IN THE CONTRACT PRICE FOR GUARDRAIL.

THIS SHEET SHALL BE USED IN CONNECTION WITH STANDARD SHEETS BR-B17A & B TYPED DR-B12A & B, BR-B100, BR-B101, BR-B102A & B, BR-B103 AND BR-B104 AS APPLICABLE.

DESIGNED BY	DATE
CHECKED BY	DATE
APPROVED BY	DATE
WEST VIRGINIA DEPARTMENT OF TRANSPORTATION DIVISION OF HIGHWAYS ENGINEERING DIVISION	
PROJECT NO. 3348-7-18-47 DATE 07-02-07	
CONTRACT NO. 3348-7-18-47 SECTION 103 GUARDRAIL SYSTEMS SECTION 103 GUARDRAIL SYSTEMS	
STANDARD SHEET BR-B106	

WEST VIRGINIA DEPARTMENT OF TRANSPORTATION  
DIVISION OF HIGHWAYS  
ENGINEERING DIVISION

SUGAR CREEK BRIDGE  
OVER SUGAR CREEK

TYLER CO. C.R. 7

TYPE 1L-2 GUARDRAIL TRANSITION

SCALE 1/4" = 1'

DATE 02-03

PROJ. NO. 10227

VENDOR PREFERENCE CERTIFICATE

Certification and application\* is hereby made for Preference in accordance with West Virginia Code, §5A-3-37. (Does not apply to construction contracts). West Virginia Code, §5A-3-37, provides an opportunity for qualifying vendors to request (at the time of bid) preference for their residency status. Such preference is an evaluation method only and will be applied only to the cost bid in accordance with the West Virginia Code. This certificate for application is to be used to request such preference. The Purchasing Division will make the determination of the Resident Vendor Preference, if applicable.

- 1. Application is made for 2.5% resident vendor preference for the reason checked: Bidder is an individual resident vendor and has resided continuously in West Virginia for four (4) years immediately preceding the date of this certification; or, Bidder is a partnership, association or corporation resident vendor and has maintained its headquarters or principal place of business continuously in West Virginia for four (4) years immediately preceding the date of this certification; or 80% of the ownership interest of Bidder is held by another individual, partnership, association or corporation resident vendor who has maintained its headquarters or principal place of business continuously in West Virginia for four (4) years immediately preceding the date of this certification; or, Bidder is a nonresident vendor which has an affiliate or subsidiary which employs a minimum of one hundred state residents and which has maintained its headquarters or principal place of business within West Virginia continuously for the four (4) years immediately preceding the date of this certification; or,
2. Application is made for 2.5% resident vendor preference for the reason checked: Bidder is a resident vendor who certifies that, during the life of the contract, on average at least 75% of the employees working on the project being bid are residents of West Virginia who have resided in the state continuously for the two years immediately preceding submission of this bid; or,
3. Application is made for 2.5% resident vendor preference for the reason checked: Bidder is a nonresident vendor employing a minimum of one hundred state residents or is a nonresident vendor with an affiliate or subsidiary which maintains its headquarters or principal place of business within West Virginia employing a minimum of one hundred state residents who certifies that, during the life of the contract, on average at least 75% of the employees or Bidder's affiliate's or subsidiary's employees are residents of West Virginia who have resided in the state continuously for the two years immediately preceding submission of this bid; or,
4. Application is made for 5% resident vendor preference for the reason checked: Bidder meets either the requirement of both subdivisions (1) and (2) or subdivision (1) and (3) as stated above; or,
5. Application is made for 3.5% resident vendor preference who is a veteran for the reason checked: Bidder is an individual resident vendor who is a veteran of the United States armed forces, the reserves or the National Guard and has resided in West Virginia continuously for the four years immediately preceding the date on which the bid is submitted; or,
6. Application is made for 3.5% resident vendor preference who is a veteran for the reason checked: Bidder is a resident vendor who is a veteran of the United States armed forces, the reserves or the National Guard, if, for purposes of producing or distributing the commodities or completing the project which is the subject of the vendor's bid and continuously over the entire term of the project, on average at least seventy-five percent of the vendor's employees are residents of West Virginia who have resided in the state continuously for the two immediately preceding years.

Bidder understands if the Secretary of Revenue determines that a Bidder receiving preference has failed to continue to meet the requirements for such preference, the Secretary may order the Director of Purchasing to: (a) reject the bid; or (b) assess a penalty against such Bidder in an amount not to exceed 5% of the bid amount and that such penalty will be paid to the contracting agency or deducted from any unpaid balance on the contract or purchase order.

By submission of this certificate, Bidder agrees to disclose any reasonably requested information to the Purchasing Division and authorizes the Department of Revenue to disclose to the Director of Purchasing appropriate information verifying that Bidder has paid the required business taxes, provided that such information does not contain the amounts of taxes paid nor any other information deemed by the Tax Commissioner to be confidential.

Under penalty of law for false swearing (West Virginia Code, §61-5-3), Bidder hereby certifies that this certificate is true and accurate in all respects; and that if a contract is issued to Bidder and if anything contained within this certificate changes during the term of the contract, Bidder will notify the Purchasing Division in writing immediately.

Bidder: EASTERN VAULT CO., INC. Signed: [Signature]
Date: 12-27-08 Title: GENERAL MANAGER

\*Check any combination of preference consideration(s) indicated above, which you are entitled to receive.



STATE OF WEST VIRGINIA  
Purchasing Division**PURCHASING AFFIDAVIT****VENDOR OWING A DEBT TO THE STATE:**

*West Virginia Code* §5A-3-10a provides that: No contract or renewal of any contract may be awarded by the state or any of its political subdivisions to any vendor or prospective vendor when the vendor or prospective vendor or a related party to the vendor or prospective vendor is a debtor and the debt owed is an amount greater than one thousand dollars in the aggregate.

**PUBLIC IMPROVEMENT CONTRACTS & DRUG-FREE WORKPLACE ACT:**

*West Virginia Code* §21-1D-5 provides that: Any solicitation for a public improvement construction contract shall require each vendor that submits a bid for the work to submit at the same time an affidavit that the vendor has a written plan for a drug-free workplace policy in compliance with Article 1D, Chapter 21 of the West Virginia Code. A public improvement construction contract may not be awarded to a vendor who does not have a written plan for a drug-free workplace policy in compliance with Article 1D, Chapter 21 of the West Virginia Code and who has not submitted that plan to the appropriate contracting authority in timely fashion. For a vendor who is a subcontractor, compliance with Section 5, Article 1D, Chapter 21 of the West Virginia Code may take place before their work on the public improvement is begun.

**ANTITRUST:**

In submitting a bid to any agency for the state of West Virginia, the bidder offers and agrees that if the bid is accepted the bidder will convey, sell, assign or transfer to the state of West Virginia all rights, title and interest in and to all causes of action it may now or hereafter acquire under the antitrust laws of the United States and the state of West Virginia for price fixing and/or unreasonable restraints of trade relating to the particular commodities or services purchased or acquired by the state of West Virginia. Such assignment shall be made and become effective at the time the purchasing agency tenders the initial payment to the bidder.

I certify that this bid is made without prior understanding, agreement, or connection with any corporation, firm, limited liability company, partnership or person or entity submitting a bid for the same materials, supplies, equipment or services and is in all respects fair and without collusion or fraud. I further certify that I am authorized to sign the certification on behalf of the bidder or this bid.

**LICENSING:**

Vendors must be licensed and in good standing in accordance with any and all state and local laws and requirements by any state or local agency of West Virginia, including, but not limited to, the West Virginia Secretary of State's Office, the West Virginia Tax Department, West Virginia Insurance Commission, or any other state agencies or political subdivision. Furthermore, the vendor must provide all necessary releases to obtain information to enable the Director or spending unit to verify that the vendor is licensed and in good standing with the above entities.

**CONFIDENTIALITY:**

The vendor agrees that he or she will not disclose to anyone, directly or indirectly, any such personally identifiable information or other confidential information gained from the agency, unless the individual who is the subject of the information consents to the disclosure in writing or the disclosure is made pursuant to the agency's policies, procedures and rules. Vendors should visit [www.state.wv.us/admin/purchase/privacy](http://www.state.wv.us/admin/purchase/privacy) for the Notice of Agency Confidentiality Policies.

Under penalty of law for false swearing (*West Virginia Code* §61-5-3), it is hereby certified that the vendor acknowledges the information in this said affidavit and is in compliance with the requirements as stated.

Vendor's Name: EASTERN VAULT CO., INC.

Authorized Signature:  Date: 12-27-08