



State of West Virginia
 Department of Administration
 Purchasing Division
 2019 Washington Street East
 Post Office Box 50130
 Charleston, WV 25305-0130

Request for Quotation

RFQ NUMBER
AGR0711

PAGE
1

ADDRESS CORRESPONDENCE TO ATTENTION OF:
RON PRICE
304-558-0492

RFQ COPY
 TYPE NAME/ADDRESS HERE

VENDOR

Middletown Tractor Sales
2032 Fairmont Avenue
Fairmont, WV 26554

SHIP TO

DEPARTMENT OF AGRICULTURE
 LAND SECTION
 HUTTONSVILLE STATE FARM
 ROUTE 219/250 SOUTH
 HUTTONSVILLE, WV
 26273 304-558-2222

DATE PRINTED	TERMS OF SALE	SHIP VIA	F.O.B.	FREIGHT TERMS
07/09/2006				

BID OPENING DATE: **08/02/2006** BID OPENING TIME **01:30PM**

LINE	QUANTITY	UOP	CAT. NO.	ITEM NUMBER	UNIT PRICE	AMOUNT
0001	2	EA		100-05	**See Addendum #1**	
	FORAGE BOXES MILLER PRO, MODEL #5300-18F, OR EQUAL SPECS: BOX LENGTH: 18" MIN. 977 CU. FT. CAPACITY MIN. INSIDE WIDTH: 88" MIN. INSIDE HEIGHT: 97" MIN, 4" OPTIONAL HIGHER ROOF OVERALL WIDTH: 109", OVERALL LENGTH: 256" WEIGHT WITH ROOF: 4310 LBS. MAIN APRON PRINTLE CHAIN, #667X. 4 PER BOX 15000# PULL EACH LEFT CROSSOVER DISCHARGE/FRONT UNLOAD, CLEAR OUTDOOR CROSSOVER WIDTH: 22" CROSSOVER APRON: CA 550 ROLLER CHAIN W/WELDED SLOTS 18" CROSSFEED CONVEYOR, OPT. EXTENSION/FOLD UP SPRING 3 - 18" DIA. DRUM STYLE UNLOAD AUGERS, 2" TINES SAFETY CLUTCH, QUICK RELEASE PUSH BAR 540 RPM PTO DRIVE BOX HOLD DOWN KIT 4 SPEED GEAR SHIFT, SYNCHONIZED TRANSMISSION INDEPENDENT FEATHER CLUTCH CROP CLEAR RAFTERLESS ROOF FORAGE BOX MOUNTED ON 15 TON TANDEM 6 WHEEL WAGON (NEW TIRES) 1. MINIMUM WT. 1324 LBS. 2. 2 3/4" SPINDLE DIA. 3. 8 BOLT HUBS 4. ADJUSTABLE SPRING ASSIST EASY LIFT TELEPOLE 5. 14L X 16 TIRES MIN. 6. TAPERED BALL JOINT AUTOMATIC TYPE STEERING					

SEE REVERSE SIDE FOR TERMS AND CONDITIONS

SIGNATURE <i>J. Boyers</i>	TELEPHONE	DATE
TITLE	FEIN	ADDRESS CHANGES TO BE NOTED ABOVE

**GENERAL TERMS & CONDITIONS
REQUEST FOR QUOTATION (RFQ) AND REQUEST FOR PROPOSAL (RFP)**

1. Awards will be made in the best interest of the State of West Virginia.
2. The State may accept or reject in part, or in whole, any bid.
3. All quotations are governed by the *West Virginia Code* and the *Legislative Rules* of the Purchasing Division.
4. Prior to any award, the apparent successful vendor must be properly registered with the Purchasing Division and have paid the required \$125.00 registration fee.
5. All services performed or goods delivered under State Purchase Orders/Contracts are to be continued for the term of the Purchase Order/Contract, contingent upon funds being appropriated by the Legislature or otherwise being made available. In the event funds are not appropriated or otherwise available for these services or goods, this Purchase Order/Contract becomes void and of no effect after June 30.
6. Payment may only be made after the delivery and acceptance of goods or services.
7. Interest may be paid for late payment in accordance with the *West Virginia Code*.
8. Vendor preference will be granted upon written request in accordance with the *West Virginia Code*.
9. The State of West Virginia is exempt from federal and state taxes and will not pay or reimburse such taxes.
10. The Director of Purchasing may cancel any Purchase Order/Contract upon 30 days written notice to the seller.
11. The laws of the State of West Virginia and the *Legislative Rules* of the Purchasing Division shall govern all rights and duties under the Contract, including without limitation the validity of this Purchase Order/Contract.
12. Any reference to automatic renewal is hereby deleted. The Contract may be renewed only upon mutual written agreement of the parties.
13. **BANKRUPTCY:** In the event the vendor/contractor files for bankruptcy protection, this contract is automatically null and void, and is terminated without further order.
14. **HIPAA Business Associate Addendum** - The West Virginia State Government HIPAA Business Associate Addendum (BAA), approved by the Attorney General, and available online at the Purchasing Division's web site (<http://www.state.wv.us/admin/purchase/vrc/hipaa.htm>) is hereby made part of the agreement. Provided that, the Agency meets the definition of a Covered Entity (45 CFR §160.103) and will be disclosing Protected Health Information: (45 CFR §160.103) to the vendor.

INSTRUCTIONS TO BIDDERS

1. Use the quotation forms provided by the Purchasing Division.
2. **SPECIFICATIONS:** Items offered must be in compliance with the specifications. Any deviation from the specifications must be clearly indicated by the bidder. Alternates offered by the bidder as **EQUAL** to the specifications must be clearly defined. A bidder offering an alternate should attach complete specifications and literature to the bid. The Purchasing Division may waive minor deviations to specifications.
3. Complete all sections of the quotation form.
4. Unit prices shall prevail in cases of discrepancy.
5. All quotations are considered F.O.B. destination unless alternate shipping terms are clearly identified in the quotation.
6. **BID SUBMISSION:** All quotations must be delivered by the bidder to the office listed below prior to the date and time of the bid opening. Failure of the bidder to deliver the quotations on time will result in bid disqualifications.

SIGNED BID TO:

Department of Administration
Purchasing Division
2019 Washington Street East
Post Office Box 50130
Charleston, WV 25305-0130



State of West Virginia
 Department of Administration
 Purchasing Division
 2019 Washington Street East
 Post Office Box 50130
 Charleston, WV 25305-0130

Request for Quotation

RFO NUMBER
AGR0711

PAGE
2

ADDRESS CORRESPONDENCE TO ATTENTION OF:
RON PRICE 304-558-0492

RFQ COPY
 TYPE NAME/ADDRESS HERE

Middletown Tractor Sales
2032 Fairmont Avenue
Fairmont, WV 26554

DEPARTMENT OF AGRICULTURE
 LAND SECTION
 HUTTONSVILLE STATE FARM
 ROUTE 219/250 SOUTH
 HUTTONSVILLE, WV
 26273 304-558-2222

DATE PRINTED	TERMS OF SALE	SHIP VIA	F.O.B.	FREIGHT TERMS
07/09/2006				

BID OPENING DATE	08/02/2006	BID OPENING TIME	01:30PM
------------------	------------	------------------	---------

LINE	QUANTITY	UOP	CAT NO	ITEM NUMBER	UNIT PRICE	AMOUNT
7.				TELEPOLE ADJUST 24" FOR HOOKUP		
<p>ALL ITEMS FOB DESTINATION (TO BE DELIVERED, ASSEMBLED, AND DEMONSTRATED AT THE HUTTONSVILLE STATE FARM</p> <p>AGENCY CONTACT PERSONS: DWAYNE O'DELL, ASST. DIRECTOR MARKETING & DEVELOPMENT DIVISION, 304-558-2210, OR MARK PRITT, MANAGER HUTTONSVILLE FARM, 304-335-6070.</p> <p>QUESTIONS CONCERNING THE SPECIFICATIONS SHOULD BE SUBMITTED IN WRITING BY 4:00 PM ON 7/21/06 TO:</p> <p>RON PRICE PURCHASING DIVISION 2019 WASHINGTON STREET EAST CHARLESTON, WV 25305 FAX: 304-558-4115 EMAIL: RPRICE@WVADMIN.GOV</p> <p>THE MODEL/BRAND/SPECIFICATIONS NAMED HEREIN ESTABLISH THE ACCEPTABLE LEVEL OF QUALITY ONLY AND ARE NOT INTENDED TO REFLECT A PREFERENCE OR FAVOR ANY PARTICULAR BRAND OR VENDOR. VENDORS WHO ARE BIDDING ALTERNATES SHOULD SO STATE AND INCLUDE PERTINENT LITERATURE AND SPECIFICATIONS. FAILURE TO PROVIDE INFORMATION FOR ANY ALTERNATES MAY BE GROUNDS FOR REJECTION OF THE BID. THE STATE RESERVES THE RIGHT TO WAIVE MINOR IRREGULARITIES IN BIDS OR SPECIFICATIONS IN ACCORDANCE WITH SECTION 148-1-4(F) OF THE WEST VIRGINIA LEGISLATIVE RULES AND REGULATIONS.</p> <p>VENDOR PREFERENCE CERTIFICATE</p> <p>CERTIFICATION AND APPLICATION* IS HEREBY MADE FOR PREFERENCE IN ACCORDANCE WITH WEST VIRGINIA CODE, 5A-3-37 (DOES NOT APPLY TO CONSTRUCTION CONTRACTS).</p>						

SEE REVERSE SIDE FOR TERMS AND CONDITIONS

SIGNATURE	TELEPHONE	DATE
LE	FEIN	ADDRESS CHANGES TO BE NOTED ABOVE



State of West Virginia
 Department of Administration
 Purchasing Division
 2019 Washington Street East
 Post Office Box 50130
 Charleston, WV 25305-0130

Request for
 Quotation

RFP NUMBER
 AGR0711

PAGE
 3

ADDRESS CORRESPONDENCE TO ATTENTION OF
 RON PRICE
 304-558-0492

V
E
N
D
O
R

RFQ COPY
 TYPE NAME/ADDRESS HERE

S
H
I
P
T
O

DEPARTMENT OF AGRICULTURE
 LAND SECTION
 HUTTONSVILLE STATE FARM
 ROUTE 219/250 SOUTH
 HUTTONSVILLE, WV
 26273 304-558-2222

DATE PRINTED	TERMS OF SALE	SHIP VIA	FOB	FREIGHT TERMS
07/09/2006				

OPENING DATE 08/02/2006 BID OPENING TIME 01:30PM

LINE	QUANTITY	UOP	CAT NO.	ITEM NUMBER	UNIT PRICE	AMOUNT
<p>A. APPLICATION IS MADE FOR 2.5% PREFERENCE FOR THE REASON CHECKED:</p> <p>() BIDDER IS AN INDIVIDUAL RESIDENT VENDOR AND HAS RESIDED CONTINUOUSLY IN WEST VIRGINIA FOR FOUR (4) YEARS IMMEDIATELY PRECEDING THE DATE OF THIS CERTIFICATION; OR</p> <p>(X) BIDDER IS A PARTNERSHIP, ASSOCIATION OR CORPORATION RESIDENT VENDOR AND HAS MAINTAINED ITS HEAD-QUARTERS OR PRINCIPAL PLACE OF BUSINESS CONTINUOUSLY IN WEST VIRGINIA FOR FOUR (4) YEARS IMMEDIATELY PRECEDING THE DATE OF THIS CERTIFICATION; OR 80% OF THE OWNERSHIP INTEREST OF BIDDER IS HELD BY ANOTHER INDIVIDUAL, PARTNERSHIP, ASSOCIATION OR CORPORATION RESIDENT VENDOR WHO HAS MAINTAINED ITS HEADQUARTERS OR PRINCIPAL PLACE OF BUSINESS CONTINUOUSLY IN WEST VIRGINIA FOR FOUR (4) YEARS IMMEDIATELY PRECEDING THE DATE OF THIS CERTIFICATION; OR</p> <p>() BIDDER IS A CORPORATION NONRESIDENT VENDOR WHICH HAS AN AFFILIATE OR SUBSIDIARY WHICH EMPLOYS A MINIMUM OF ONE HUNDRED STATE RESIDENTS AND WHICH HAS MAINTAINED ITS HEADQUARTERS OR PRINCIPAL PLACE OF BUSINESS WITHIN WEST VIRGINIA CONTINUOUSLY FOR THE FOUR (4) YEARS IMMEDIATELY PRECEDING THE DATE OF THIS CERTIFICATION.</p> <p>B. APPLICATION IS MADE FOR 2.5% PREFERENCE FOR THE REASON CHECKED:</p> <p>(X) BIDDER IS A RESIDENT VENDOR WHO CERTIFIES THAT, DURING THE LIFE OF THE CONTRACT, ON AVERAGE AT LEAST 75% OF THE EMPLOYEES WORKING ON THE PROJECT BEING BID ARE RESIDENTS OF WEST VIRGINIA WHO HAVE RESIDED IN</p>						

SEE REVERSE SIDE FOR TERMS AND CONDITIONS

ATURE	TELEPHONE	DATE
<i>J. Boyer</i>		
FEIN	ADDRESS CHANGES TO BE NOTED ABOVE	



State of West Virginia
 Department of Administration
 Purchasing Division
 2019 Washington Street East
 Post Office Box 50130
 Charleston, WV 25305-0130

Request for Quotation

RFQ NUMBER
AGR0711

PAGE
4

ADDRESS CORRESPONDENCE TO ATTENTION OF
RON PRICE 304-558-0492

RFQ COPY
 TYPE NAME/ADDRESS HERE

VENDOR

Middletown Tractor Sales
2032 Fairmont Avenue
Fairmont, WV 26554

SHIP TO

DEPARTMENT OF AGRICULTURE
 LAND SECTION
 HUTTONSVILLE STATE FARM
 ROUTE 219/250 SOUTH
 HUTTONSVILLE, WV
 26273 304-558-2222

DATE PRINTED	TERMS OF SALE	SHIP VIA	F.O.B.	FREIGHT TERMS
07/09/2006				

BID OPENING DATE: 08/02/2006 BID OPENING TIME: 01:30PM

LINE	QUANTITY	UOP	CAT NO.	ITEM NUMBER	UNIT PRICE	AMOUNT
<p>THE STATE CONTINUOUSLY FOR THE TWO YEARS IMMEDIATELY PRECEDING SUBMISSION OF THIS BID; OR () BIDDER IS A NONRESIDENT VENDOR EMPLOYING A MINIMUM OF ONE HUNDRED STATE RESIDENTS OR IS A NONRESIDENT VENDOR WITH AN AFFILIATE OR SUBSIDIARY WHICH MAINTAINS ITS HEADQUARTERS OR PRINCIPAL PLACE OF BUSINESS WITHIN WEST VIRGINIA EMPLOYING A MINIMUM OF ONE HUNDRED STATE RESIDENTS WHO CERTIFIES THAT, DURING THE LIFE OF THE CONTRACT, ON AVERAGE AT LEAST 75% OF THE EMPLOYEES OR BIDDERS' AFFILIATE'S OR SUBSIDIARY'S EMPLOYEES ARE RESIDENTS OF WEST VIRGINIA WHO HAVE RESIDED IN THE STATE CONTINUOUSLY FOR THE TWO YEARS IMMEDIATELY PRECEDING SUBMISSION OF THIS BID.</p> <p>BIDDER UNDERSTANDS IF THE SECRETARY OF TAX & REVENUE DETERMINES THAT A BIDDER RECEIVING PREFERENCE HAS FAILED TO CONTINUE TO MEET THE REQUIREMENTS FOR SUCH PREFERENCE, THE SECRETARY MAY ORDER THE DIRECTOR OF PURCHASING TO: (A) RESCIND THE CONTRACT OR PURCHASE ORDER ISSUED; OR (B) ASSESS A PENALTY AGAINST SUCH BIDDER IN AN AMOUNT NOT TO EXCEED 5% OF THE BID AMOUNT AND THAT SUCH PENALTY WILL BE PAID TO THE CONTRACTING AGENCY OR DEDUCTED FROM ANY UNPAID BALANCE ON THE CONTRACT OR PURCHASE ORDER.</p> <p>BY SUBMISSION OF THIS CERTIFICATE, BIDDER AGREES TO DISCLOSE ANY REASONABLY REQUESTED INFORMATION TO THE PURCHASING DIVISION AND AUTHORIZES THE DEPARTMENT OF TAX AND REVENUE TO DISCLOSE TO THE DIRECTOR OF PURCHASING APPROPRIATE INFORMATION VERIFYING THAT BIDDER HAS PAID THE REQUIRED BUSINESS TAXES, PROVIDED THAT SUCH INFORMATION DOES NOT CONTAIN THE AMOUNTS OF TAXES PAID NOR ANY OTHER INFORMATION DEEMED BY THE TAX COMMISSIONER TO BE CONFIDENTIAL.</p>						

SEE REVERSE SIDE FOR TERMS AND CONDITIONS

GNATURE	TELEPHONE	DATE
<i>J.A. Boyer</i>		

TLE	FEIN	ADDRESS CHANGES TO BE NOTED ABOVE



State of West Virginia
 Department of Administration
 Purchasing Division
 2019 Washington Street East
 Post Office Box 50130
 Charleston, WV 25305-0130

Request for
Quotation

RFQ NUMBER
AGR0711

PAGE
5

ADDRESS CORRESPONDENCE TO ATTENTION OF:
RON PRICE
304-558-0492

VENDOR

RFQ COPY
 TYPE NAME/ADDRESS HERE

SHIP TO

DEPARTMENT OF AGRICULTURE
 LAND SECTION
 HUTTONSVILLE STATE FARM
 ROUTE 219/250 SOUTH
 HUTTONSVILLE, WV
 26273 304-558-2222

DATE PRINTED 07/09/2006	TERMS OF SALE	SHIP VIA	F.O.B.	FREIGHT TERMS
-----------------------------------	---------------	----------	--------	---------------

OPENING DATE: **08/02/2006** BID OPENING TIME **01:30PM**

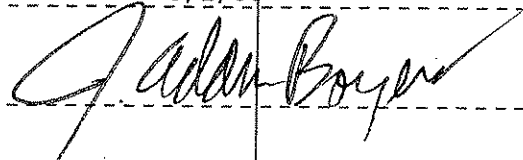
LINE	QUANTITY	UOP	CAT NO.	ITEM NUMBER	UNIT PRICE	AMOUNT
<p>UNDER PENALTY OF LAW FOR FALSE SWEARING (WEST VIRGINIA CODE 61-5-3), BIDDER HEREBY CERTIFIES THAT THIS CERTIFICATE IS TRUE AND ACCURATE IN ALL RESPECTS; AND THAT IF A CONTRACT IS ISSUED TO BIDDER AND IF ANYTHING CONTAINED WITHIN THIS CERTIFICATE CHANGES DURING THE TERM OF THE CONTRACT, BIDDER WILL NOTIFY THE PURCHASIN DIVISION IN WRITING IMMEDIATELY.</p> <p style="text-align: center;">Middletown Tractor Sales</p> <p>BIDDER: -----</p> <p>DATE: <u>8/1/06</u> -----</p> <p>SIGNED:  -----</p> <p>TITLE: <u>VP</u> -----</p> <p>* CHECK ANY COMBINATION OF PREFERENCE CONSIDERATION(S) IN EITHER "A" OR "B", OR BOTH "A" AND "B" WHICH YOU ARE ENTITLED TO RECEIVE. YOU MAY REQUEST UP TO THE MAXIMUM 5% PREFERENCE FOR BOTH "A" AND "B". (REV. 12/00)</p> <p style="text-align: center;">NOTICE</p> <p>A SIGNED BID MUST BE SUBMITTED TO:</p> <p style="text-align: center;">DEPARTMENT OF ADMINISTRATION PURCHASING DIVISION BUILDING 15 2019 WASHINGTON STREET, EAST CHARLESTON, WV 25305-0130</p>						

SEE REVERSE SIDE FOR TERMS AND CONDITIONS

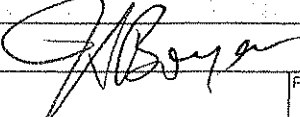
ATURE		TELEPHONE	DATE
FEIN	ADDRESS CHANGES TO BE NOTED ABOVE		



State of West Virginia
 Department of Administration
 Purchasing Division
 2019 Washington Street East
 Post Office Box 50130
 Charleston, WV 25305-0130

Request for Quotation

RFQ NUMBER
AGR0711

PAGE
6

ADDRESS CORRESPONDENCE TO ATTENTION OF
RON PRICE
304-558-0492

RFQ COPY

TYPE NAME/ADDRESS HERE

VENDOR

Middletown Tractor Sales
2032 Fairmont Avenue
Fairmont, WV 26554

SHIP TO

DEPARTMENT OF AGRICULTURE
 LAND SECTION
 HUTTONSVILLE STATE FARM
 ROUTE 219/250 SOUTH
 HUTTONSVILLE, WV
 26273 304-558-2222

DATE PRINTED	TERMS OF SALE	SHIP VIA	FOB	FREIGHT TERMS
07/09/2006				

BID OPENING DATE	08/02/2006	BID OPENING TIME	01:30PM
------------------	------------	------------------	---------

LINE	QUANTITY	UOP	CAT NO.	ITEM NUMBER	UNIT PRICE	AMOUNT
------	----------	-----	---------	-------------	------------	--------

THE BID SHOULD CONTAIN THIS INFORMATION ON THE FACE OF THE ENVELOPE OR THE BID MAY NOT BE CONSIDERED:

SEALED BID

BUYER: 41

RFQ. NO.: AGR0711

BID OPENING DATE AND TIME

PLEASE PROVIDE A FAX NUMBER IN CASE IT IS NECESSARY TO CONTACT YOU REGARDING YOUR BID:

-----304-366-4698-----

CONTACT PERSON (PLEASE PRINT CLEARLY):

-----Steve Cronin-----

***** THIS IS THE END OF RFQ AGR0711 ***** TOTAL: \$35,287.00

SEE REVERSE SIDE FOR TERMS AND CONDITIONS

SIGNATURE	TELEPHONE	DATE
<i>J. Boyer</i>		
FEIN	ADDRESS CHANGES TO BE NOTED ABOVE	



State of West Virginia
 Department of Administration
 Purchasing Division
 2019 Washington Street East
 Post Office Box 50130
 Charleston, WV 25305-0130

Request for Quotation

RFQ NUMBER
 AGR0711

PAGE
 1

ADDRESS CORRESPONDENCE TO ATTENTION OF:
 RON PRICE
 304-558-0492

RFQ COPY
 TYPE NAME/ADDRESS HERE

VENDOR

MIDDLETOWN TRACTOR SALES
 2032 FAIRMONT AVENUE
 FAIRMONT, WV 26554

SHIP TO

DEPARTMENT OF AGRICULTURE
 LAND SECTION
 HUTTONSVILLE STATE FARM
 ROUTE 219/250 SOUTH
 HUTTONSVILLE, WV 26273
 304-558-2222

DATE PRINTED	TERMS OF SALE	SHIP VIA	F.O.B.	FREIGHT TERMS
07/14/2006	Net 30	Our Truck	Destination	Prepaid

BID OPENING DATE: 08/02/2006 BID OPENING TIME 01:30PM

LINE	QUANTITY	UOP	CAT. NO.	ITEM NUMBER	UNIT PRICE	AMOUNT
				ADDENDUM NO. 1		
				PAGE 1 - SPECS		
				BOX LENGTH: READS: 18" MIN.		
				TO READ: 18' MIN.		
				BID OPENING DATE AND TIME REMAINS THE SAME.		
				NO OTHER CHANGES.		
0001	2	EA		100-05	\$17,643.50	\$35,287.00
				FORAGE BOXES		
				***We are bidding per your specifications the Miller Pro, Model #5300-18F. In addition to your specifications, this unit will also have an 18 ton running gear.		
				***** THIS IS THE END OF RFQ AGR0711 ***** TOTAL:		\$35,287.00

SEE REVERSE SIDE FOR TERMS AND CONDITIONS

SIGNATURE: *J. Addison Boyers* TELEPHONE: 304-366-4690 DATE: 8/1/06

TITLE: VP FEIN: 550547175 ADDRESS CHANGES TO BE NOTED ABOVE

MILLER PRO

5300 Series Forage Boxes

Front, Rear & Front/Rear Unload • Receiver Boxes • Truck Mount • Running Gear

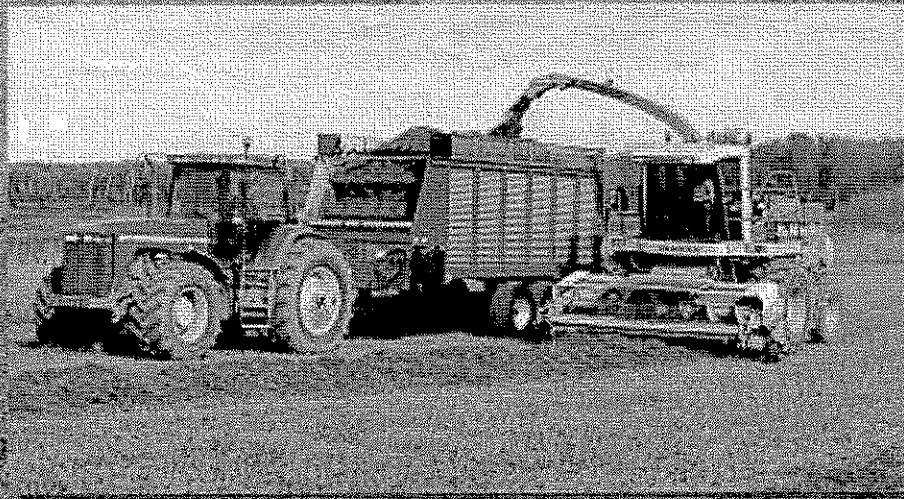
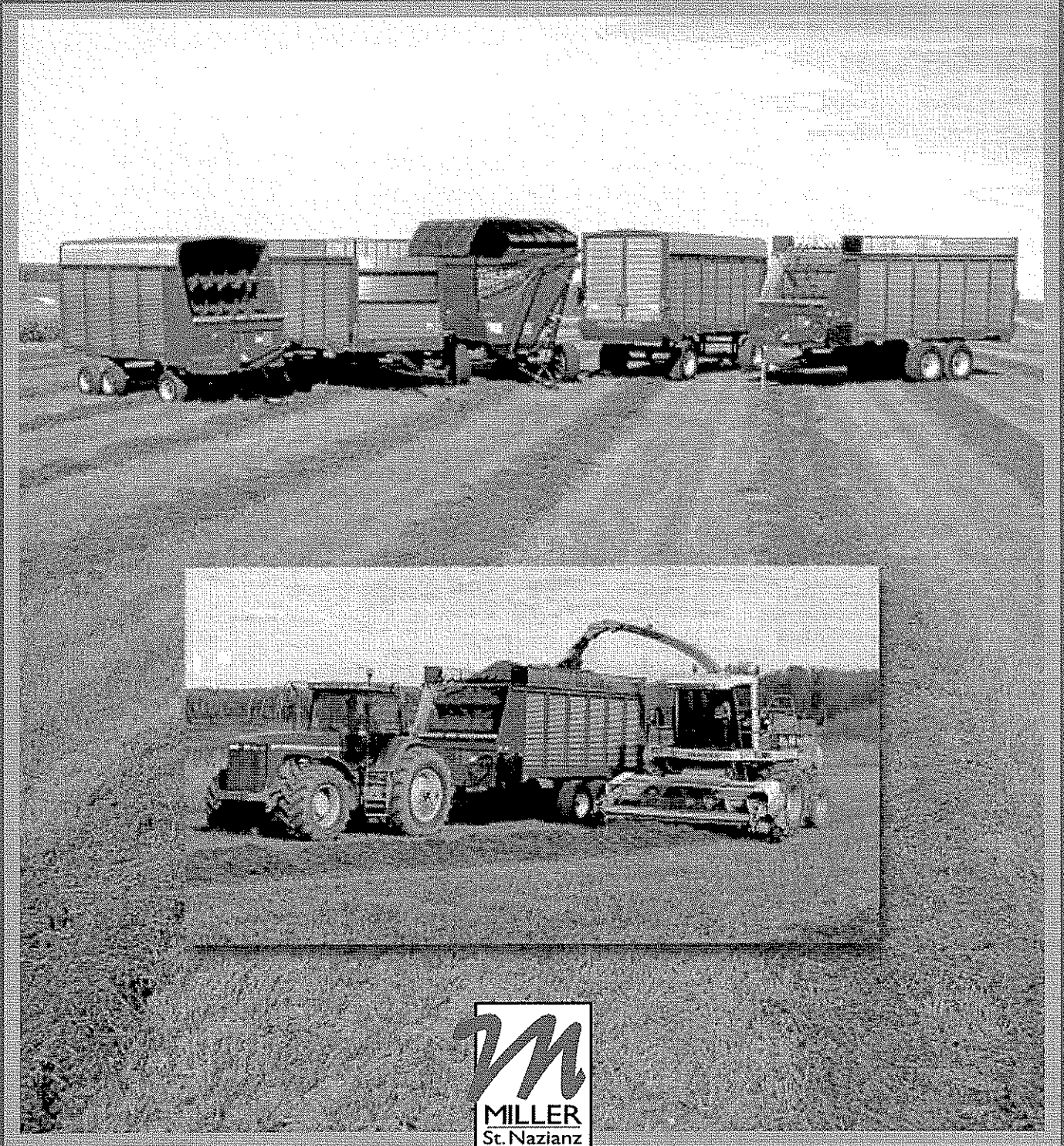

MILLER PRO

5300 Series

Improving forage quality... with high capacity harvesting

Today's high capacity forage harvesting requires bigger forage boxes and faster ways of getting the job done. Miller Pro offers receiver boxes for both truck and trailer mount to meet these needs. They can be side loaded with Miller Pro high lift dump boxes, or can run behind or along side self-propelled forage harvesters. Miller Pro offers an extensive line of forage handling equipment to help you bring in higher quality forage, and get it into your silos, bunkers or bags faster.

A growing line...

You'll find more models to choose from, plus new configurations to add convenience to your work. The entire line is available either with roofs or as open top models. Truck mount and trailer models add more choices to fill every need.

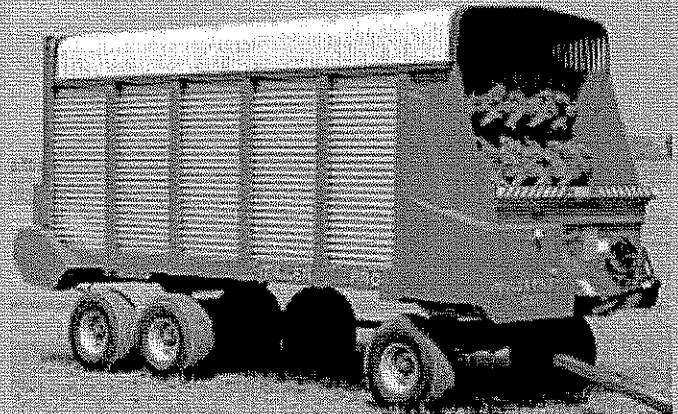

Higher capacity...

The entire line is available in box lengths up to 20 feet. Optional 4" higher roof or side extensions add even more capacity. Heavy weight constructed running gear is available in either single or tandem axle wagons or tandem axle trailers.



Receiver Boxes

Receiver boxes are ideal for top filling because there are no obstructions such as rafters or supports in the center of the box. The sides are reinforced with both a heavy "Z" shaped side sill and a massive structural beam going full length on the top edge of both sides along with a cross support at the front and rear of the forage box. The side stakes are the largest in the industry measuring an impressive 5" x 2-1/2" in size.

Side Extensions and 4th Beater

The receiver boxes can be fitted with side extensions to increase the load capacity. With the side extensions it is recommended that an optional fourth beater be added to ensure a smooth flow of material to the blower.

Trailer Mounted Receiver Boxes

The MILLER PRO 5300 receiver box mounted on a tandem axle trailer is an ideal way to handle the needs of having to fill bags and upright silos along with bunker silos while obtaining a smooth ride with good trailing and maneuverability. It is not uncommon to be able to **travel one or two gears faster** in field conditions than with a conventional steerable wagon.

PTO drive lines can remain attached to the tractor. You can start the PTO before leaving the tractor **saving two trips in and out of your tractor cab** not having to attach and detach the PTO drive line while at the blower or bagger. While using in a bunker situation it is not necessary to leave the tractor at all.

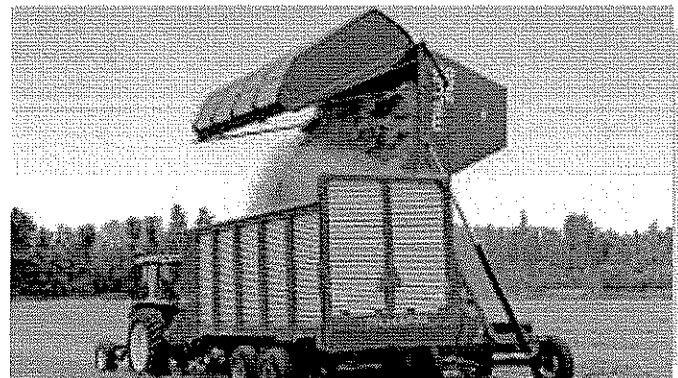

MILLER PRO

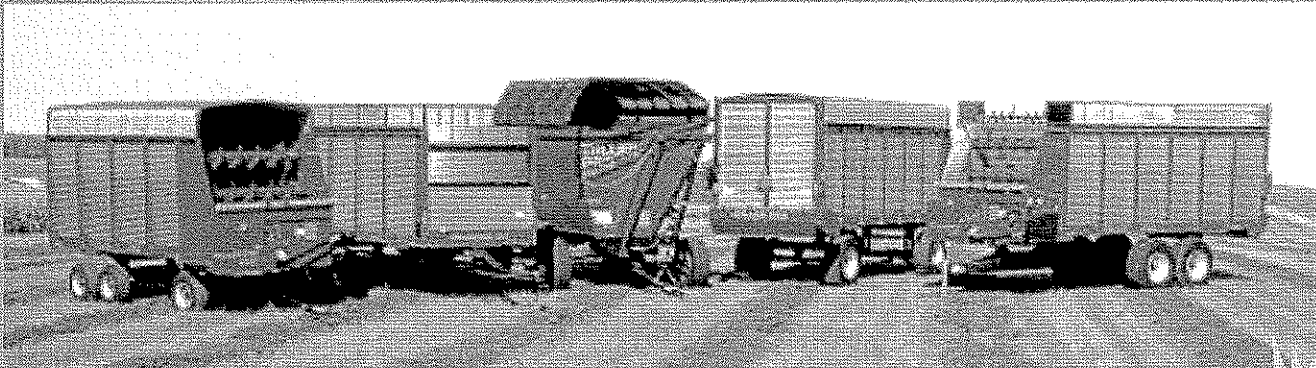

5300 Series Highlights

The Miller Pro forage box is well recognized for its exceptional performance, reliability and long-lasting durability.

- **Excellence in design**, state-of-the-art manufacturing, highest quality materials plus exceptional fit and finish
- **Longest forage handling line in the industry** including front unload, front/rear combination models, rear unload, receiver boxes, forage blowers and high lift dump boxes
- **Ease of control**, designed for safer operation
- **Unitized high strength steel box with Field Flex™** design
- **4-speed shift-under-load enclosed gear transmission**
- **Independent feathering clutches** for optimum control
- **Smooth feeding metering augers**
- **Crop Clear™** ratterless roof

Superior strength
EX-TEN® steel is
67% stronger than
conventional steel, more capable
of handling the stress of heavy
loads and long years of service.

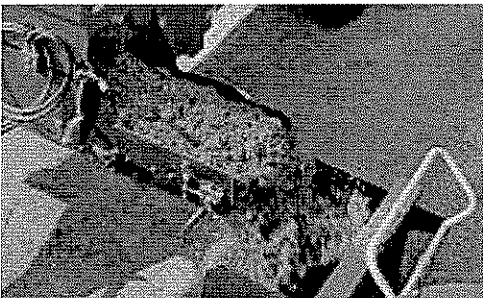
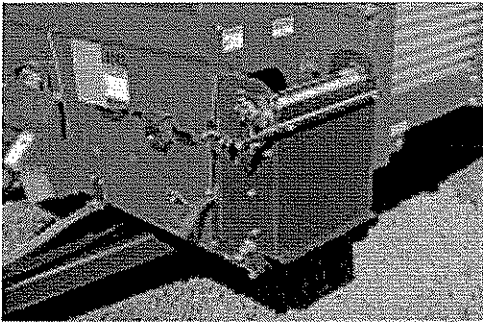

Fold Down Cross Conveyor Extension

An optional 18" (30" overall) fold down cross conveyor extension makes it very easy to approach the blower, especially with today's large tractors. The fold down extension can also be used for bunk feeding. A spring assist makes it quick and easy to fold. When folded the extension closes off the cross conveyor opening.



Truck Mount Forage Boxes

The complete line of MILLER PRO forage boxes is available in truck mount versions. Drive systems can be either hydraulic or mechanical. These boxes can be front unload, rear unload or front/rear unload, with or without roofs, side extensions or fourth beater.

A solid foundation to carry the load. Unitized Construction

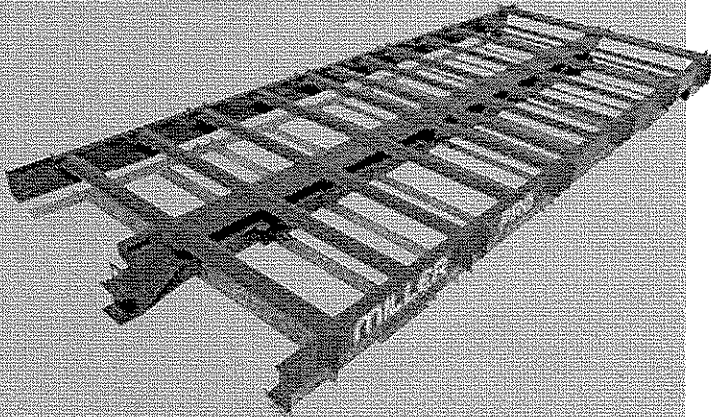

FLEXIBLE ENGINEERED CONSTRUCTION

● *Field Flex™* design provides integral strength, with dynamic tolerance to flex as terrain and load varies. Steel unibody design provides an excellent strength-to-weight ratio and a lower center of gravity. Proven in the roughest, wettest conditions to withstand stresses caused by changing loads and field conditions.

UNITIZED UNDERSTRUCTURE

● Foundation of the 5300 forage box. Four side and center stringers run full length... and combine with other formed high strength steel frame members to make a durable integrated assembly. This design distributes loads evenly over the box's full length, and provides a balance of rigidity and flexibility that assures long life under tough field conditions.

UNITIZED STEEL BOX

● Exclusive design incorporates the latest in engineering and manufacturing methods to break the technology barrier and to revolutionize forage box design. Backed by a 10 year warranty.

FULL LENGTH SIDE SHEETS

● Made of tough corrugated 20 gauge aluminized steel. Contributes to the integral strength of the box assembly.

FULL LENGTH STEEL STRINGERS

● Formed from EX-TEN® heavy duty alloy—67% stronger than conventional steel.

MASSIVE STEEL UPRIGHTS

● Multiple 90° bends create 4-sided uprights with twice the strength of others, and present a smoother, cleaner appearance.

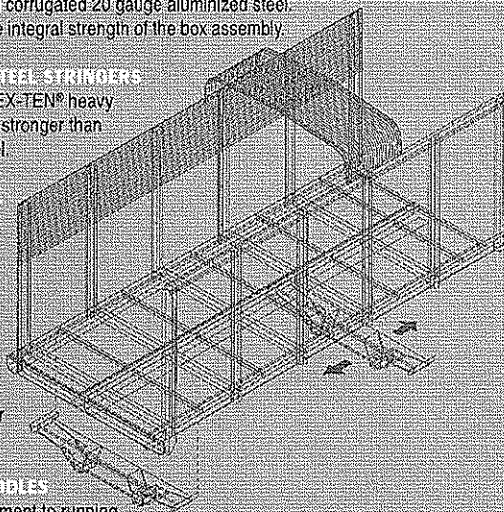

MOUNTING SADDLES

● Provide attachment to running gear or truck frame. The rear saddle can be moved to insure correct weight distribution for single or tandem axle. Reinforced rubber pads are positioned between bottom of saddle and wagon or trailer frame.

CLUTTER FREE DESIGN

● Removes bulky wood and steel structures for a clean and open appearance...and a lower center of gravity.

ONE PIECE SILL

● Runs full length to support the roof adding to unitized box integrity.

Unique dual feathering clutches. Maximum control. Easy operation.

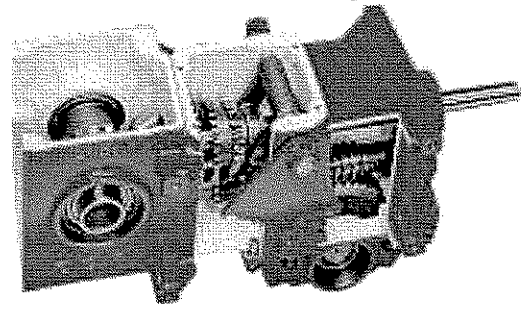

4-Speed Shift-Under-Load Synchronized Gear Transmission

● Exclusive. Provides a simple and positive gear-to-gear drive for smooth unloading under all crop conditions. Massive bronze worm gear and rugged gear train operate inside a sealed oil bath. Beefy design includes heavy drive collar, large output shaft and heavy detent springs.

● Consistency of speeds is a major advantage of our 4-speed positive gear transmission. Control is smooth and predictable. Cleanout is faster with speeds up to 13 ft/min. Variable speed drives on other boxes cause the apron speed to fluctuate as a result of the ever-changing load.

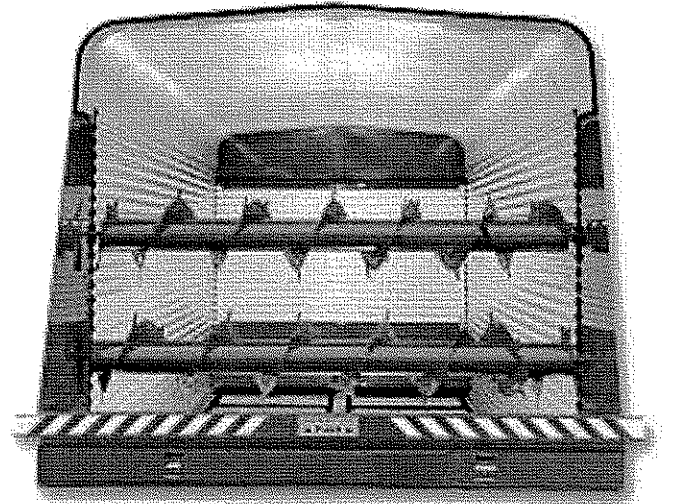

Crop Clear™ rafterless roof.

● Allows unobstructed rafter-free crop loading and unloading. Corrugated and formed heavy gauge aluminized steel has superior strength, appearance and corrosion resistance. Heavy duty roof edge protector. Removable in sections for loading combined corn.

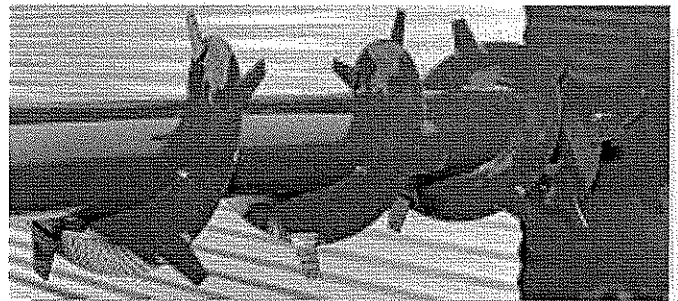

18" Metering Augers

● Provide the most uniform feed flow in the industry. Large diameter prevents undercutting. Welded chipper tines start easily in tightly packed loads. Top auger setback practically eliminates carryover and enhances unloading performance by creating a smooth flowing waterfall of crop.

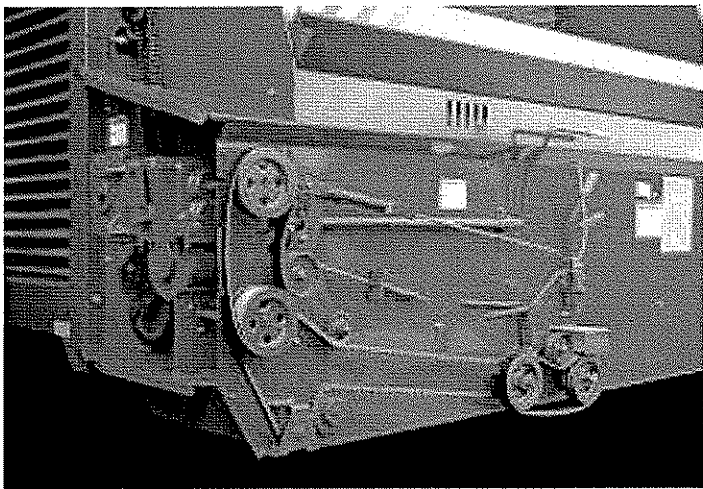

Front Drive System

The front drive chain is spring loaded to ensure the proper tension and eliminates chain whip.

Independent Drives for Auger and Outfeed — Unequaled Crop Unloading Control

● Exclusive feathering clutch system coupled with a shift-under-load 4-speed gear box lets the operator start extra full loads smoothly, and provide positive, direct unloading speeds.

Outfeed Feathering Clutch

● Allows the operator to feather the outfeed apron to help start heavy loads slowly, without producing clumps that can block your forage blower. This clutch is also the quick-release safety clutch. The PTO turns freely for easy hookup.

Metering Auger Feathering Clutch

● Allows the operator to feather the augers to clean them, without bringing the load forward. Single handle allows operator to stop and/or feather the augers to ease a big clump into the outfeed. No other forage box has this user-friendly system...some have no beater clutch at all.

Centralized Operator Controls

- Provides easy access to unloading controls from either side
- Neutral gear placed between all speeds
- Safety clutches easy to reset
- Low sight holes for good visibility

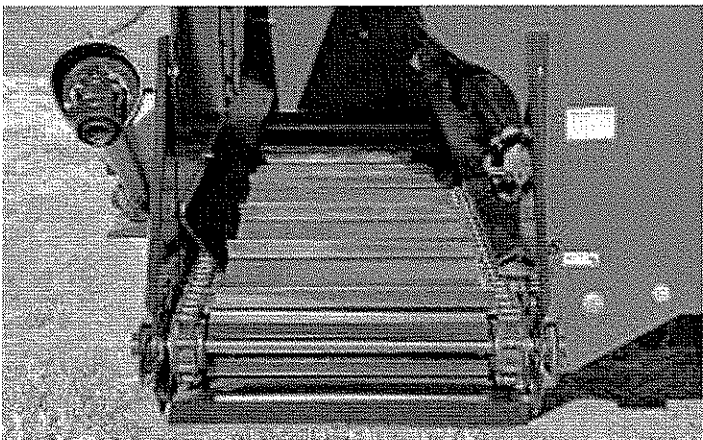

Cross Conveyor Chain Restraints

● Reduces potential residue buildup over full length of cross conveyor.

Removable Cleanout Panel

● Bottom of unit pan has access panel for easy seasonal cleanout of material.

Drive Line Safety Shields Swing Open

● Shielding on gearbox and belt drive systems is smaller, more secure and provides easier access. Front hinge prevents panels from catching the wind during transport if accidentally left unlatched.

Heavy Duty Needle Bearing

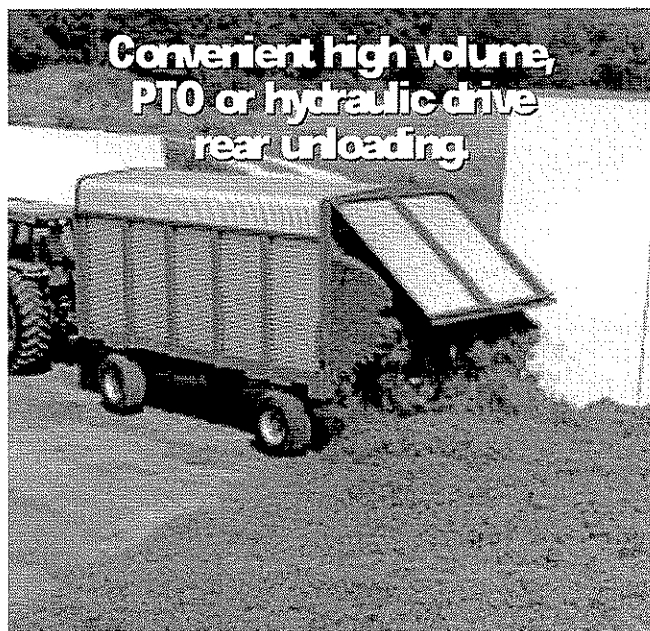

PTO or Hydraulic Drive

● PTO drive unloads in as little as 30 seconds. Hydraulic drive unloading time varies with tractor hydraulics.

Box Floor

● Is 5/8" pressure treated marine grade plywood. Front/rear unload boxes have super slippery poly clad floor to reduce friction and stress in either direction.

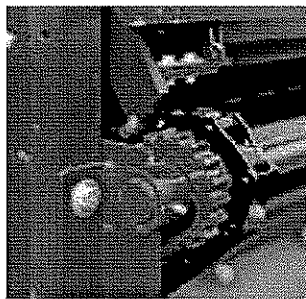

Automatic Rear Door

● Opens automatically when unloading apron is engaged. Closes and relocks when box is empty without having operator leave the tractor.

Unobstructed Unloading

● Rear door hinge point is as high as the roof so tops of loads aren't shaved off.

Oven Cured Primary & Finish Coating

● Assures superior corrosion protection, and creates the best appearance of any forage box on the market.



Front/Rear Unload • 2 Direction Drive

● Unloading direction is easy to change and requires no tools. Simply move a drive coupler from the front shaft to the rear shaft, or vice versa. No need for time-consuming changing of drive chains.



Transport Safety

All Miller Pro forage boxes have as standard equipment 2 amber flashing and 2 red tail lamps, along with a slow moving vehicle sign and amber and red reflective tape marking the sides and rear of the forage box.

MILLER PRO

Running Gear...

wagons & trailers, single & tandem axles

Superior Stability and Tracking

Dynamic flexibility of the open-bottomed steel C-section center reach eliminates the need for a sloppy collar, used in round tube designs. Reaches are made of EX-TEN® steel, 67% stronger than conventional steel to insure high strength along with flexibility. Combine this with 80" wide stance and ball joint automotive type steering, and the result is the farming industry's most steady-towing running gear. Tandem rear axle models increase stability on rough terrain.

Easy Setup and Maintenance

The adjustable wheelbase and the optional bolster width kit allow you to adapt the gear for most farm transport needs. The telepole extends a full 24" for easy tractor hookup.

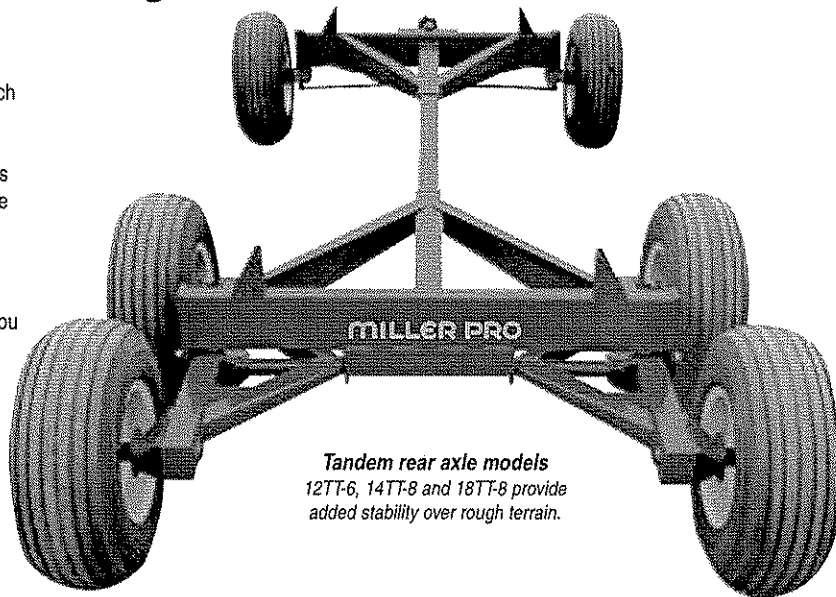

Tandem rear axle models 12TT-6, 14TT-8 and 18TT-8 provide added stability over rough terrain.

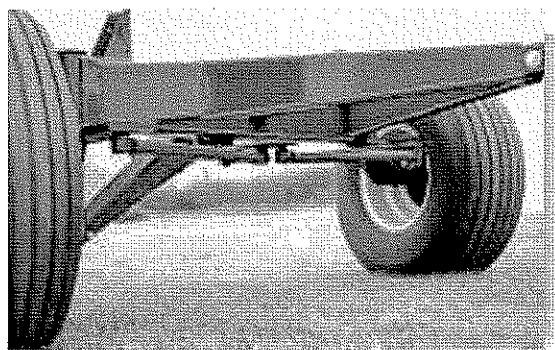

Tapered Ball Joint Automotive Type Steering and replaceable bronze bushings at all pivot areas have grease fittings at all pivot points. Tapered heat treated sleeves welded to the steering arms minimize loosening wear.

Rugged Engineered Design

Heavy duty tubular and formed steel components and weldments put strength and flexibility at critical points. Electrostatically applied, oven dried paint finishes resist corrosion. Wheel hubs and spindles are configured to meet load capacity requirements.

Hub and Spindle

configuration, along with wheel and tire ratings determine capacity. 6-bolt hubs fit the 2" spindles, and heavier duty 8-bolt hubs fit 2 1/4", 2 3/4" and 3" spindles.

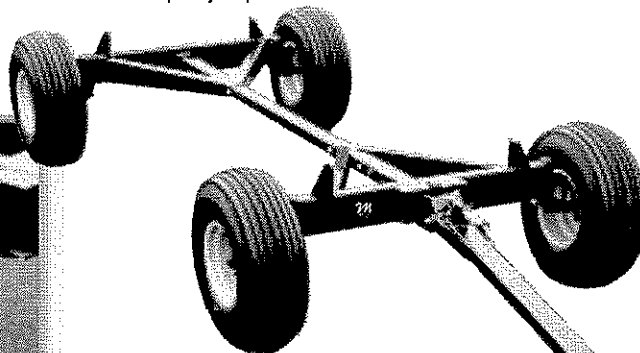

Single rear axle models 12T-8, 15T-8 and 17T-8 are rugged, yet economical.

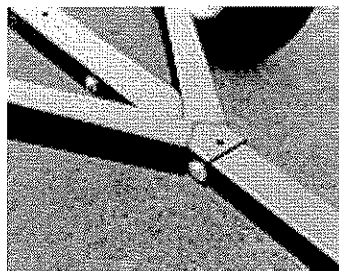

C-Section Center Reach fits snugly into formed steel channels of bolster weldments for length adjustment.

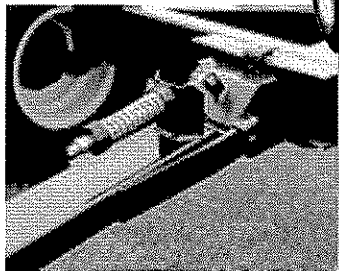

Easy-Lift Spring counterbalances telepole for reduced effort when hitching to tractor.

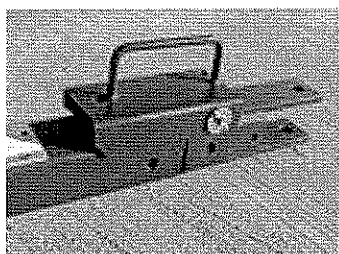

Extendable Telepole has a convenient handle at the hitch. 96" standard length. Extends 24" for easy hookup.

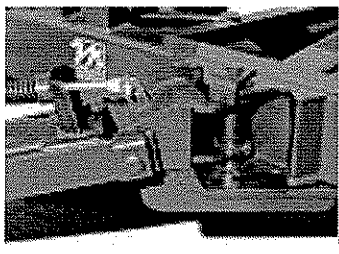

Machined pivot pins versus bolts insure continued close tolerances. All pivot pins are set in replaceable bronze bushings with grease fittings for longer life.

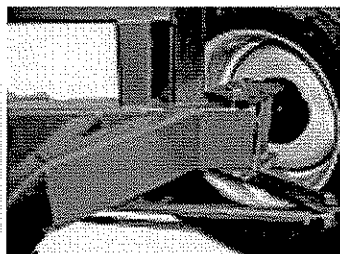

All models have short turning radius



Trunion steering for 17 ton model

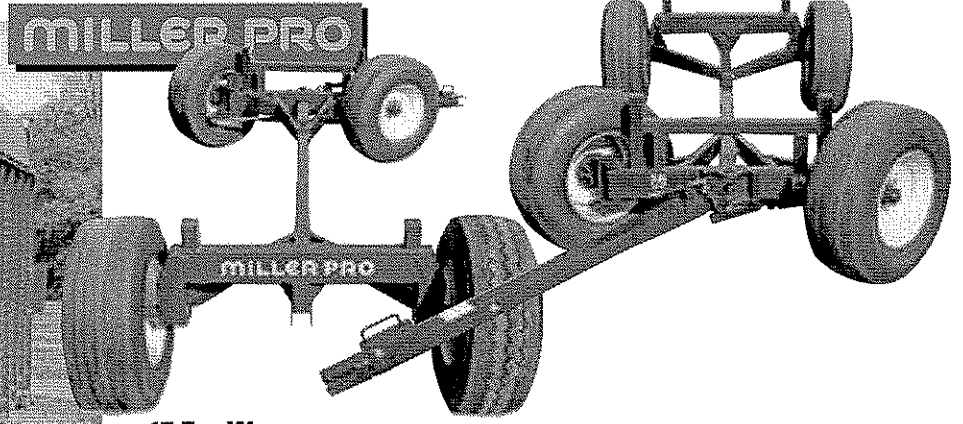
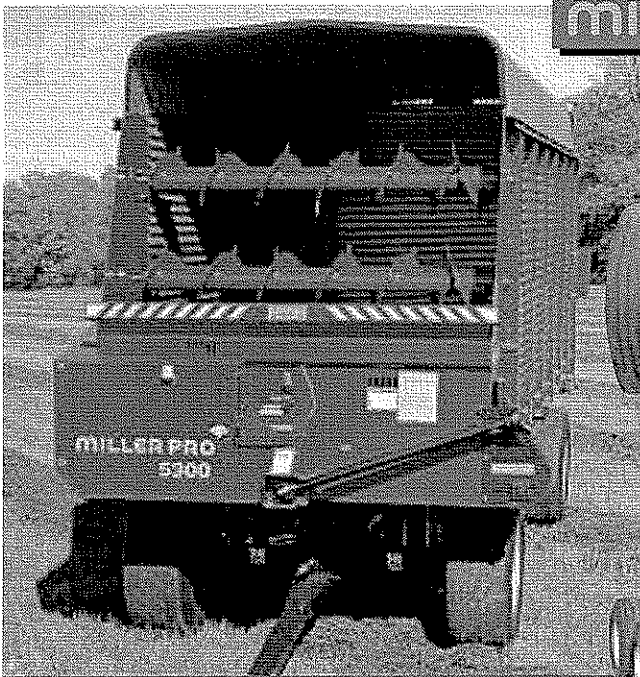

17 Ton Wagon

The 17 ton wagon was designed specifically for use with forage boxes. MILLER PRO has designed this wagon to accept large tires such as 4.45 x 22.5 super single truck tires while still keeping the majority of the tire under the forage box while maintaining an impressive 56 degree turning radius. Riser kits are not needed with this wagon!

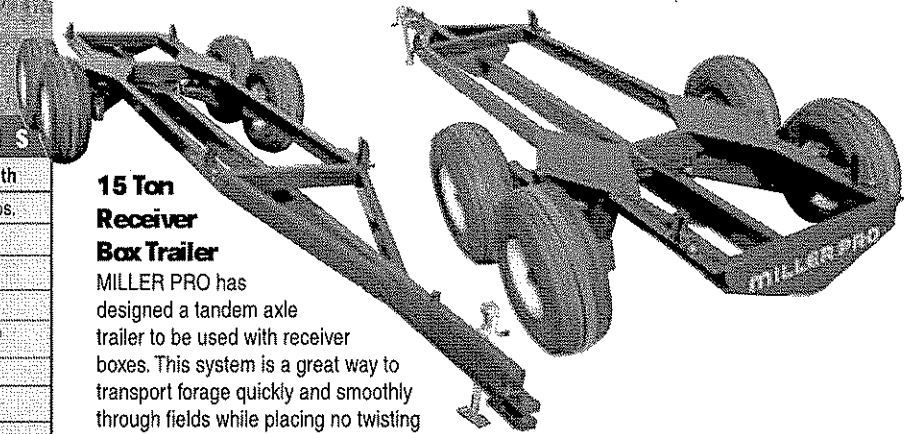

15 Ton Receiver Box Trailer

MILLER PRO has designed a tandem axle trailer to be used with receiver boxes. This system is a great way to transport forage quickly and smoothly through fields while placing no twisting strain at all on the forage box while going through waterways and field approaches. In normal field conditions it is possible to go a gear or two faster than with a conventional steerable wagon!

TRAILER SPECIFICATIONS

Trailer Type	Standard Length	XL Length
Rated capacity	30,000 lbs.	30,000 lbs.
Approx. height with 16.5 x 22.5 tires	33"	33"
Overall length	270"	293"
Length from pin hole to oscillation	213"	231"
Tread Width	81-3/4"	81-3/4"
Spindle diameter	2-3/4"	2-3/4"
Hubs	8-bolt	8-bolt
Bolster stake width	42"	42"
Bolster stake adjustment fore & aft Bolster stakes adjust at 3-3/4" intervals	113.5" to 154.5"	135.5" to 184.5"

WAGON SPECIFICATIONS

Models	12TT-6	12T-8	14TT-8	15T-8	17T-8	18TT-8
ASAE rated cap. (tons)	12	12	14	15	17	18
Approx. weight w/o tires	1,262 lbs.	938 lbs.	1,324 lbs.	1,230 lbs.	1,490 lbs.	1,822 lbs.
Approx. weight w/ tires	1,484 lbs.	1,086 lbs.	1,546 lbs.	1,520 lbs.	2,553 lbs. **	2,380 lbs.
Height	26" from bolster to ground with 12.5Lx15" tires			32" w/14Lx16.1"	37 1/2" w/425x22.5"	32" w/14Lx16.1"
Tread width	80"	80"	80"	80"	81"	80"
Spindle diameter	2"	2 1/4"	2 1/4"	2 1/4"	3"	2 3/4"
Hubs	6-bolt	8-bolt	8-bolt	8-bolt	8-bolt	8-bolt
Bolster stake spacing	42" is standard — Kit to reduce spacing to 38" is optional					
Adjustable extending hitch for telepole	96" extra long telepole for forage boxes 77" is available for bale racks and gravity boxes					
Easy-lift telepole	Adjustable spring assist is standard					
Wheelbase, adjustable with C-section reach	Standard — 105" to 150" Options include: 90" to 120" or 150" to 180"				147" to 177"	same as 15 ton
Turning radius	60Y	60Y*	60Y	57Y	56Y**	57Y
Tandem	Yes	No	Yes	No	No	Yes
Inertia hydraulic brakes	N/A	Opt.	Opt.	Opt.	Opt.	Opt.
Rear hitch point	No	Yes	No	Yes	No	No
Options	Standard wheel is 15" x 10" Multiple sizes and ratings of wheels and tires are available. 38" Bolster Kit: see Bolster stake spacing above. Safety Chain: recommended for highway towing.					
* 55Y w/16.5 x 16.1 tires						
** W/425 x 22.5 tires						

The trailer is extremely well built with a massive main beam (heavy wall structural steel tubing) running the full length of the trailer. This supports a heavy framework of structural steel tubing which easily supports the full weight of the load.

FORAGE BOX Peace of Mind Warranty

2 year warranty on entire box

5 year warranty on gear box/transmission

5 year warranty on feathering clutch belts

5 year warranty on 667H or 667X main apron chain

10 year warranty on the box structure

Ask your Miller Pro Dealer for a copy of the actual warranty. It's the best in the industry.

MILLER PRO

5300 SERIES SPECIFICATIONS

Unloading Configuration	Front Unload			Front/Rear		Rear Unload	
MODEL No.	5300 - 16F	5300 - 18F	5300 - 20F	5300 - 18F/R	5300 - 20F/R	5300 - 18R	5300 - 20R
Box size floor length	16 ft	18 ft	20 ft	18 ft	20 ft	18 ft	20 ft
Capacity w/roof ASAE std	866 cu ft	977 cu ft	1085 cu ft	981 cu ft	1090 cu ft	1002 cu ft	1113 cu ft
Capacity less roof ASAE std	713 cu ft	805 cu ft	894 cu ft	810 cu ft	900 cu ft	822 cu ft	913 cu ft
Capacity less roof with side extensions struck ASAE std	866 cu ft	977 cu ft	1085 cu ft	981 cu ft	1090 cu ft	1002 cu ft	1113 cu ft
Inside width	88"						
Inside height w/std roof	93"						
Inside height w/4" higher roof	97"						
Overall width	109"	109"	109"	109"	109"	104"	104"
Overall height w/std roof	115"						
Overall height w/side extension	112-1/2"						
Overall length	232"	256"	280"	271"	295"	243"	264"
Weight w/roof	4100 lbs	4310 lbs	4720 lbs	5050 lbs.	5460 lbs	3690 lbs	4070 lbs
Main apron pintle chain	#667H 4 per box @ 10,000 lb min. pull each						
Optional apron pintle chain	#667X 4 per box @ 15,000 lb min. pull each						
Crossfeed delivery	Left or right			Left only			
Crossfeed apron width	22"			22"			
Crossfeed conveyor apron	CA 550 roller chain with welded slats						
Crossfeed clean-out door	Yes			Yes			
Crossfeed conveyor ext. - std	12" stationary			12" stationary			
Crossfeed conveyor ext. - optional	18" fold up with spring assist (30" overall)						
Unloading metering augers	Three 18" diameter drum style with 2" tines						
Safety clutch	Quick release push bar at front Cable on outfeed side- quick re-engage						
Power source - front unload	540 RPM PTO drive - optional hyd. motor drive						
Power source - rear unload	PTO or hyd. drive						
Box hold down kit	Std						
Transport lights	Std						
Rear door latch	Positive spring loaded - pins in notch						
4" higher roof	Optional on all models						
Side extension kit	Optional on all models						
Fourth beater	Optional on all models with side extensions						

MILLER PRO reserves the right to change its products or the description at any time without notice or obligation. MP0103 ©2003 Miller-St. Nazianz, Inc. Some equipment is shown in this brochure with safety shields open or removed. Never operate equipment with safety shields open or removed.



HAY BUDDY®
POWER MERGER

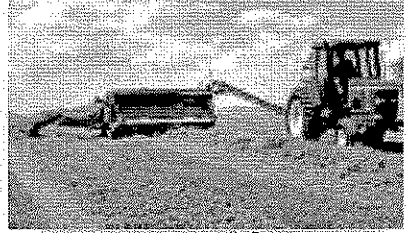

AVALANCHE® SINGLE
PICKUP POWER MERGER

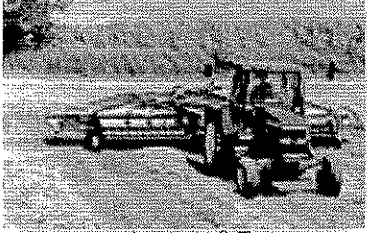

AVALANCHE® TWIN
PICKUP POWER MERGER

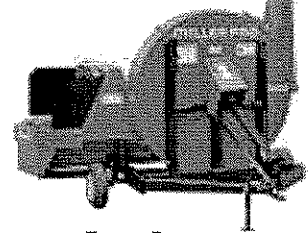

FORAGE BLOWERS



SINGLE & TWIN ROTARY RAKES



Proudly serving
agriculture for over
100 years.

Miller Pro...a Miller-St. Nazianz, Inc. company
511 E. Main St., St. Nazianz, WI 54232-0127
(800) 247-5557 www.millerstn.com

See our website for the dealer serving your area.

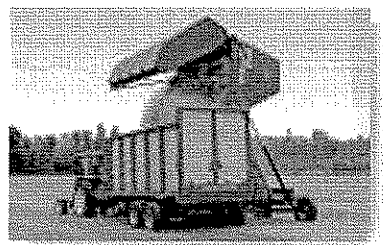

HIGH LIFT DUMP BOXES

AFFIDAVIT

West Virginia Code §5A-3-10a states:

No contract or renewal of any contract may be awarded by the state or any of its political subdivisions to any vendor or prospective vendor when the vendor or prospective vendor or a related party to the vendor or prospective vendor is a debtor and the debt owned is an amount greater than one thousand dollars in the aggregate.

DEFINITIONS:

"Debt" means any assessment, premium, penalty, fine, tax or other amount of money owed to the state or any of its political subdivisions because of a judgment, fine, permit violation, license assessment, defaulted workers' compensation premium, penalty or other assessment presently delinquent or due and required to be paid to the state or any of its political subdivisions, including any interest or additional penalties accrued thereon.

"Debtor" means any individual, corporation, partnership, association, limited liability company or any other form or business association owing a debt to the state or any of its political subdivisions.

"Political subdivision" means any county commission; municipality; county board of education; any instrumentality established by a county or municipality; any separate corporation or instrumentality established by one or more counties or municipalities, as permitted by law; or any public body charged by law with the performance of a government function or whose jurisdiction is coextensive with one or more counties or municipalities.

"Related party" means a party, whether an individual, corporation, partnership, association, limited liability company or any other form or business association or other entity whatsoever, related to any vendor by blood, marriage, ownership or contract through which the party has a relationship of ownership or other interest with the vendor so that the party will actually or by effect receive or control a portion of the benefit, profit or other consideration from performance of a vendor contract with the party receiving an amount that meets or exceeds five percent of the total contract amount.

EXCEPTION:

The prohibition of this section does not apply where a vendor has contested any tax administered pursuant to chapter eleven of this code, workers' compensation premium, permit fee or environmental fee or assessment and the matter has not become final or where the vendor has entered into a payment plan or agreement and the vendor is not in default of any of the provisions of such plan or agreement.

LICENSING:

The vendor must be licensed in accordance with any and all state requirements to do business with the state of West Virginia.

CONFIDENTIALITY:

The vendor agrees that he or she will not disclose to anyone, directly or indirectly, any such personally identifiable information or other confidential information gained from the agency, unless the individual who is the subject of the information consents to the disclosure in writing or the disclosure is made pursuant to the agency's policies, procedures and rules. Vendors should visit www.state.wv.us/admin/purchase/privacy for the Notice of Agency Confidentiality Policies.

Under penalty of law for false swearing (West Virginia Code, §61-5-3), it is hereby certified that the vendor acknowledges the information in this said affidavit and are in compliance with the requirements as stated.

Vendor's Name: Middletown Tractor Sales

Authorized Signature: _____

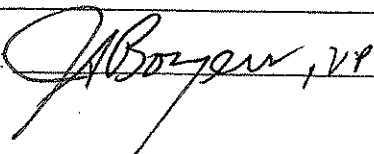

Date: 8/1/06