



State of West Virginia
 Department of Administration
 Purchasing Division
 2019 Washington Street East
 Post Office Box 50130
 Charleston, WV 25305-0130

Request for Quotation

REQ NUMBER
DEP13569

PAGE
1

ADDRESS CORRESPONDENCE TO ATTENTION OF
**CHUCK BOWMAN
 304-558-2157**

VENDOR

RFQ COPY
 TYPE NAME/ADDRESS HERE

501151933

**MIDWAY RECLAMATION, LLC.
 P.O. BOX 308
 WEST MILFORD, WV 26451**

SHIP TO

**ENVIRONMENTAL PROTECTION
 DEPT. OF
 OFFICE OF SPECIAL RECLAMATION
 105 S. RAILROAD STREET
 PHILIPPI, WV
 26416-9998 304-457-3219**

DATE PRINTED 08/30/2006	TERMS OF SALE	SHIP VIA	F.O.B.	FREIGHT TERMS
-----------------------------------	---------------	----------	--------	---------------

BID OPENING DATE: **10/05/2006** BID OPENING TIME **01:30PM**

LINE	QUANTITY	UOP	CAT NO.	ITEM NUMBER	UNIT PRICE	AMOUNT
0001	1	JB		962-73		155,000.00
<p>RECLAMATION: RESTORATION OF WATER</p> <p>THE PURCHASING DIVISION, ON BEHALF OF THE AGENCY, THE WEST VIRGINIA DEPARTMENT OF ENVIRONMENTAL PROTECTION'S OFFICE OF SPECIAL RECLAMATION, IS SOLICITING BIDS FOR THE PROJECT SPECIFIED BELOW AND IN THE ATTACHED SPECIAL RECLAMATION/BOND FORFEITURE PROJECT</p> <p>THE PURPOSE OF THE CONTRACT IS TO PERFORM WATER RECLAMATION ON THE MINING OPERATION OF GOLDEN PRODUCTS CO. NOW UNDER REVOKED PERMIT NUMBER(S) S-1009-88.</p> <p>THE RECLAMATION SHALL BE PERFORMED UNDER THE GUIDANCE AND GENERAL SUPERVISION OF THE AGENT ASSIGNED TO THE PROJECT FOR THE STATE OF WEST VIRGINIA, DEPARTMENT OF ENVIRONMENTAL PROTECTION.</p> <p>A MANDATORY ON SITE PREBID CONFERENCE SHALL BE HELD ON 09/12/06 @ 10:00 AM. FAILURE TO ATTEND THE PREBID CONFERENCE WILL RESULT IN BID DISQUALIFICATION.</p> <p>THE CONTRACTOR SHALL PROVIDE ALL LABOR, MATERIALS, EQUIPMENT AND OTHER NECESSARY SERVICES SO AS TO ACCOMPLISH THE ITEMS AS SPECIFIED IN THIS CONTRACT. PROJECT IS LOCATED NEAR DELMAR, WV, MONONGALIA COUNTY AND CONSISTS OF APPROXIMATELY 6.0 ACRES.</p> <p>PROJECT CONTACT PERSON:</p>						

SEE REVERSE SIDE FOR TERMS AND CONDITIONS

SIGNATURE <i>Nancy S. Somers</i>	TELEPHONE 304-745-3652	DATE 10-05-06
TITLE OWNER	FEIN 33-1135400	ADDRESS CHANGES TO BE NOTED ABOVE

WHEN RESPONDING TO RFQ, INSERT NAME AND ADDRESS IN SPACE ABOVE LABELED 'VENDOR'

**GENERAL TERMS & CONDITIONS
REQUEST FOR QUOTATION (RFQ) AND REQUEST FOR PROPOSAL (RFP)**

1. Awards will be made in the best interest of the State of West Virginia.
2. The State may accept or reject in part, or in whole, any bid.
3. All quotations are governed by the *West Virginia Code* and the *Legislative Rules* of the Purchasing Division.
4. Prior to any award, the apparent successful vendor must be properly registered with the Purchasing Division and have paid the required \$125.00 registration fee.
5. All services performed or goods delivered under State Purchase Orders/Contracts are to be continued for the term of the Purchase Order/Contract, contingent upon funds being appropriated by the Legislature or otherwise being made available. In the event funds are not appropriated or otherwise available for these services or goods, this Purchase Order/Contract becomes void and of no effect after June 30.
6. Payment may only be made after the delivery and acceptance of goods or services.
7. Interest may be paid for late payment in accordance with the *West Virginia Code*.
8. Vendor preference will be granted upon written request in accordance with the *West Virginia Code*.
9. The State of West Virginia is exempt from federal and state taxes and will not pay or reimburse such taxes.
10. The Director of Purchasing may cancel any Purchase Order/Contract upon 30 days written notice to the seller.
11. The laws of the State of West Virginia and the *Legislative Rules* of the Purchasing Division shall govern all rights and duties under the Contract, including without limitation the validity of this Purchase Order/Contract.
12. Any reference to automatic renewal is hereby deleted. The Contract may be renewed only upon mutual written agreement of the parties.
13. **BANKRUPTCY:** In the event the vendor/contractor files for bankruptcy protection, this contract is automatically null and void, and is terminated without further order.
14. **HIPAA Business Associate Addendum -** The West Virginia State Government HIPAA Business Associate Addendum (BAA), approved by the Attorney General, and available online at the Purchasing Division's web site (<http://www.state.wv.us/admin/purchase/vrc/hipaa.htm>) is hereby made part of the agreement. Provided that, the Agency meets the definition of a Covered Entity (45 CFR §160.103) and will be disclosing Protected Health Information (45 CFR §160.103) to the vendor.

INSTRUCTIONS TO BIDDERS

1. Use the quotation forms provided by the Purchasing Division.
2. **SPECIFICATIONS:** Items offered must be in compliance with the specifications. Any deviation from the specifications must be clearly indicated by the bidder. Alternates offered by the bidder as **EQUAL** to the specifications must be clearly defined. A bidder offering an alternate should attach complete specifications and literature to the bid. The Purchasing Division may waive minor deviations to specifications.
3. Complete all sections of the quotation form.
4. Unit prices shall prevail in cases of discrepancy.
5. All quotations are considered F.O.B. destination unless alternate shipping terms are clearly identified in the quotation.
6. **BID SUBMISSION:** All quotations must be delivered by the bidder to the office listed below prior to the date and time of the bid opening. Failure of the bidder to deliver the quotations on time will result in bid disqualifications.

SIGNED BID TO:

Department of Administration
Purchasing Division
2019 Washington Street East
Post Office Box 50130
Charleston, WV 25305-0130

2008-07-10

2008-07-10



State of West Virginia
 Department of Administration
 Purchasing Division
 2019 Washington Street East
 Post Office Box 50130
 Charleston, WV 25305-0130

Request for Quotation

RFQ NUMBER
DEP13569

PAGE
3

ADDRESS CORRESPONDENCE TO ATTENTION OF:
**CHUCK BOWMAN
 304-558-2157**

RFQ COPY
 TYPE NAME/ADDRESS HERE

501151933

**MIDWAY RECLAMATION, LLC.
 P.O. BOX 308
 WEST MILFORD, WV 26451**

**ENVIRONMENTAL PROTECTION
 DEPT. OF
 OFFICE OF SPECIAL RECLAMATION
 105 S. RAILROAD STREET
 PHILIPPI, WV
 26416-9998 304-457-3219**

DATE PRINTED 08/30/2006	TERMS OF SALE	SHIP VIA	F.O.B.	FREIGHT TERMS
BID OPENING DATE: 10/05/2006		BID OPENING TIME		01:30PM

LINE	QUANTITY	UOP	CAT. NO.	ITEM NUMBER	UNIT PRICE	AMOUNT
				HEARTH, BASIC OXYGEN, ELECTRIC FURNACE, BESSEMER OR OTHER STEEL MAKING PROCESS.		
				C. "UNITED STATES" MEANS THE UNITED STATES OF AMERICA AND INCLUDES ALL TERRITORY, CONTINENTAL OR INSULAR, SUBJECT TO THE JURISDICTION OF THE UNITED STATES.		
2.				THE DIRECTOR OF THE PURCHASING DEPARTMENT MAY, IN WRITING, AUTHORIZE THE USE OF FOREIGN STEEL PRODUCTS IF:		
				A. THE COST FOR EACH CONTRACT ITEM USED DOES NOT EXCEED ONE TENTH OF ONE PERCENT (.1%) OF THE TOTAL CONTRACT COST OR TWO THOUSAND FIVE HUNDRED DOLLARS (\$2,500.00), WHICHEVER IS GREATER. FOR THE PURPOSES OF THIS SECTION, THE COST IS THE VALUE OF THE STEEL PRODUCT AS DELIVERED TO THE PROJECT OR,		
				B. THE DIRECTOR OF THE PURCHASING DIVISION DETERMINES THAT SPECIFIED STEEL MATERIALS ARE NOT PRODUCED IN THE UNITED STATES IN SUFFICIENT QUANTITY OR OTHERWISE ARE NOT REASONABLY AVAILABLE TO MEET CONTRACT REQUIREMENTS.		
3.				A CONTRACTOR WHO USES STEEL PRODUCTS IN VIOLATION OF THIS SECTION MAY BE SUBJECT TO CIVIL PENALTIES PURSUANT TO W. VA. CODE SECTION 5A-3-56.		
				REV. 10/01/01		
				EXHIBIT 5		
				NOTICE TO PROCEED: THIS CONTRACT IS TO BE PERFORMED		

SEE REVERSE SIDE FOR TERMS AND CONDITIONS.

SIGNATURE <i>Nancy S. Somers</i>	TELEPHONE 304-745-3652	DATE 10-05-06
TITLE OWNER	FEIN 33-1135400	ADDRESS CHANGES TO BE NOTED ABOVE

WHEN RESPONDING TO RFQ, INSERT NAME AND ADDRESS IN SPACE ABOVE LABELED 'VENDOR'



State of West Virginia
 Department of Administration
 Purchasing Division
 2019 Washington Street East
 Post Office Box 50130
 Charleston, WV 25305-0130

Request for Quotation

RFQ NUMBER
DEP13569

PAGE
4

ADDRESS CORRESPONDENCE TO ATTENTION OF
**CHUCK BOWMAN
 304-558-2157**

VENDOR

RFQ COPY
 TYPE NAME/ADDRESS HERE

501151933

**MIDWAY RECLAMATION, LLC.
 P.O. BOX 308
 WEST MILFORD, WV 26451**

SHIP TO

**ENVIRONMENTAL PROTECTION
 DEPT. OF
 OFFICE OF SPECIAL RECLAMATION
 105 S. RAILROAD STREET
 PHILIPPI, WV
 26416-9998 304-457-3219**

DATE PRINTED 08/30/2006	TERMS OF SALE	SHIP VIA	F.O.B.	FREIGHT TERMS
-----------------------------------	---------------	----------	--------	---------------

BID OPENING DATE: **10/05/2006** BID OPENING TIME **01:30PM**

LINE	QUANTITY	UOP	CAT. NO.	ITEM NUMBER	UNIT PRICE	AMOUNT
<p>WITHIN 365 CALENDAR DAYS AFTER THE NOTICE TO PROCEED IS RECEIVED. UNLESS OTHERWISE SPECIFIED, THE FULLY EXECUTED PURCHASE ORDER WILL BE CONSIDERED NOTICE TO PROCEED.</p> <p>CANCELLATION: THE DIRECTOR OF PURCHASING RESERVES THE RIGHT TO CANCEL THIS CONTRACT IMMEDIATELY UPON WRITTEN NOTICE TO THE VENDOR IF THE MATERIALS OR WORKMANSHIP SUPPLIED ARE OF AN INFERIOR QUALITY OR DO NOT CONFORM WITH THE SPECIFICATIONS OF THE BID AND CONTRACT HERE IN.</p> <p>WAGE RATES: THE CONTRACTOR OR SUBCONTRACTOR SHALL PAY THE HIGHER OF THE U.S. DEPARTMENT OF LABOR MINIMUM WAGE RATES AS ESTABLISHED FOR MONONGALIA COUNTY, PURSUANT TO WEST VIRGINIA CODE 21-5-1, ET, SEQ.</p> <p>ARBITRATION: ANY REFERENCES MADE TO ARBITRATION OR INTEREST FOR PAYMENTS DUE (EXCEPT FOR ANY INTEREST REQUIRED BY STATE LAW) CONTAINED IN THIS CONTRACT OR IN ANY AMERICAN INSTITUTE OF ARCHITECTS DOCUMENTS PERTAINING TO THIS CONTRACT ARE HEREBY DELETED.</p> <p>WORKERS' COMPENSATION: VENDOR IS REQUIRED TO PROVIDE A CERTIFICATE FROM WORKERS' COMPENSATION IF SUCCESSFUL.</p> <p>ALL OF THE ITEMS CHECKED BELOW WILL BE A REQUIREMENT OF THIS CONTRACT:</p> <p>(XX) INSURANCE: SUCCESSFUL VENDOR SHALL FURNISH PROOF OF COMMERCIAL GENERAL LIABILITY INSURANCE PRIOR TO ISSUANCE OF CONTRACT. UNLESS OTHERWISE SPECIFIED IN THE BID DOCUMENTS, THE MINIMUM AMOUNT OF INSURANCE COVERAGE REQUIRED IS \$250,000.</p> <p>() BUILDERS RISK INSURANCE: SUCCESSFUL VENDOR SHALL</p>						

SEE REVERSE SIDE FOR TERMS AND CONDITIONS

SIGNATURE <i>Nancy S. Somers</i>	TELEPHONE 304-745-3652	DATE 10-05-06
TITLE OWNER	FEIN 33-1135400	ADDRESS CHANGES TO BE NOTED ABOVE

WHEN RESPONDING TO RFQ, INSERT NAME AND ADDRESS IN SPACE ABOVE LABELED 'VENDOR'



State of West Virginia
 Department of Administration
 Purchasing Division
 2019 Washington Street East
 Post Office Box 50130
 Charleston, WV 25305-0130

Request for Quotation

RFQ NUMBER
DEP13569

PAGE
6

ADDRESS CORRESPONDENCE TO ATTENTION OF:
CHUCK BOWMAN
304-558-2157

RFQ COPY
 TYPE NAME/ADDRESS HERE

501151933

MIDWAY RECLAMATION, LLC.
P.O. BOX 308
WEST MILFORD, WV 26451

ENVIRONMENTAL PROTECTION
DEPT. OF
OFFICE OF SPECIAL RECLAMATION
105 S. RAILROAD STREET
PHILIPPI, WV
26416-9998 304-457-3219

DATE PRINTED 08/30/2006	TERMS OF SALE	SHIP VIA	F.O.B.	FREIGHT TERMS
-----------------------------------	---------------	----------	--------	---------------

BID OPENING DATE: **10/05/2006** BID OPENING TIME **01:30PM**

LINE	QUANTITY	UOP	CAT. NO.	ITEM NUMBER	UNIT PRICE	AMOUNT
<p>STEEL ARE REQUIRED, THE STATE WILL ACCEPT ONLY ALUMINUM GLASS, OR STEEL PRODUCTS PRODUCED IN THE UNITED STATES. IN ADDITION, ITEMS OF MACHINERY OR EQUIPMENT PURCHASED FOR USE AT THE SITE OF PUBLIC WORKS SHALL BE MADE OF DOMESTIC ALUMINUM, GLASS OR STEEL, UNLESS THE COST OF THE PRODUCT IS LESS THAN \$50,000 OR LESS THAN 10,000 POUNDS OF STEEL ARE USED IN PUBLIC WORKS PROJECTS.</p> <p>FOREIGN MADE ALUMINUM, GLASS OR STEEL PRODUCTS MAY BE ACCEPTED ONLY IF THE COST OF DOMESTIC PRODUCTS IS FOUND TO BE UNREASONABLE. SUCH COST IS UNREASONABLE IF IT IS 20% OR MORE HIGHER THAN THE BID PRICE FOR FOREIGN MADE PRODUCTS. IF THE DOMESTIC ALUMINUM, GLASS OR STEEL PRODUCTS TO BE SUPPLIED OR PRODUCED IN A "SUBSTANTIAL LABOR SURPLUS AREA", AS DEFINED BY THE UNITED STATES DEPARTMENT OF LABOR, FOREIGN PRODUCTS MAY BE SUPPLIED ONLY IF DOMESTIC PRODUCTS ARE 30% OR MORE HIGHER IN PRICE THAN THE FOREIGN MADE PRODUCTS.</p> <p>IF, PRIOR TO THE AWARD OF A CONTRACT UNDER THE ABOVE PROVISIONS, THE SPENDING OFFICER OF THE SPENDING UNIT DETERMINES THAT THERE EXISTS A BID FOR LIKE FOREIGN ALUMINUM, GLASS OR STEEL THAT IS REASONABLE AND LOWER THAN THE LOWEST BID DOMESTIC PRODUCTS, THE SPENDING OFFICE MAY REQUEST, IN WRITING, A REEVALUATION AND REDUCTION IN THE LOWEST BID FOR SUCH DOMESTIC PRODUCTS. ALL VENDORS MUST INDICATE IN THEIR BID IF THEY ARE SUPPLYING FOREIGN ALUMINUM, GLASS OR STEEL.</p> <p>REV. 3/88</p> <p>EXHIBIT 9</p> <p>NOTICE FOR ISSUANCE & ACKNOWLEDGEMENT OF CONSTRUCTION PROJECT ADDENDA</p>						

SEE REVERSE SIDE FOR TERMS AND CONDITIONS

SIGNATURE <i>Nancy S. Somers</i>	TELEPHONE 304-745-3652	DATE 10-05-06
TITLE OWNER	FEIN 33-1135400	ADDRESS CHANGES TO BE NOTED ABOVE

WHEN RESPONDING TO RFQ, INSERT NAME AND ADDRESS IN SPACE ABOVE LABELED 'VENDOR'



State of West Virginia
 Department of Administration
 Purchasing Division
 2019 Washington Street East
 Post Office Box 50130
 Charleston, WV 25305-0130

Request for Quotation

RFQ NUMBER
DEP13569

PAGE
7

ADDRESS CORRESPONDENCE TO ATTENTION OF:
CHUCK BOWMAN
304-558-2157

RFQ COPY
 TYPE NAME/ADDRESS HERE

501151933

MIDWAY RECLAMATION, LLC
P.O. BOX 308
WEST MILFORD, WV 26451

ENVIRONMENTAL PROTECTION
DEPT. OF
OFFICE OF SPECIAL RECLAMATION
105 S. RAILROAD STREET
PHILIPPI, WV
26416-9998 **304-457-3219**

DATE PRINTED	TERMS OF SALE	SHIP VIA	F.O.B.	FREIGHT TERMS
08/30/2006				

BID OPENING DATE: **10/05/2006** BID OPENING TIME: **01:30PM**

LINE	QUANTITY	UOP	CAT NO	ITEM NUMBER	UNIT PRICE	AMOUNT
<p>THE ARCHITECT/ENGINEER AND/OR AGENCY SHALL BE REQUIRED TO ABIDE BY THE FOLLOWING SCHEDULE IN ISSUING CONSTRUCTION PROJECT ADDENDA FOR STATE AGENCIES:</p> <p>(1) THE ARCHITECT/ENGINEER SHALL PREPARE THE ADDENDUM AND A LIST OF ALL PARTIES THAT HAVE PROCURED DRAWINGS AND SPECIFICATIONS FOR THE PROJECT. THE ADDENDUM AND LIST SHALL BE FORWARDED TO THE BUYER IN THE STATE PURCHASING DIVISION. THE ARCHITECT/ENGINEER SHALL ALSO SEND A COPY OF THE ADDENDUM TO THE STATE AGENCY FOR WHICH THE CONTRACT IS ISSUED.</p> <p>(2) THE BUYER SHALL SEND THE ADDENDUM TO ALL INTERESTED PARTIES AND, IF NECESSARY, EXTEND THE BID OPENING DATE. ANY ADDENDUM SHOULD BE RECEIVED BY THE BUYER WITHIN FOURTEEN (14) DAYS PRIOR TO THE BID OPENING DATE.</p> <p>CIRCUMSTANCES.</p> <p>(3) ALL ADDENDA SHOULD BE FORMALLY ACKNOWLEDGED BY ALL BIDDERS AND SUBMITTED TO THE STATE PURCHASING DIVISION AND THE STATE AUDITOR'S OFFICE. THE SAME RULES AND REGULATIONS THAT APPLY TO THE ORIGINAL BIDDING DOCUMENT SHALL ALSO APPLY TO AN ADDENDUM DOCUMENT. THE ONLY EXCEPTION MAY BE FOR AN ADDENDUM THAT IS ISSUED FOR THE SOLE PURPOSE OF CHANGING A BID OPENING TIME AND/OR DATE.</p> <p>REV. 11/96</p> <p>EXHIBIT 10</p> <p>ADDENDUM ACKNOWLEDGEMENT</p> <p>I HEREBY ACKNOWLEDGE RECEIPT OF THE FOLLOWING CHECKED</p>						

SEE REVERSE SIDE FOR TERMS AND CONDITIONS

SIGNATURE: *Nancy S. Somers* TELEPHONE: **304-745-3652** DATE: **10-05-06**

TITLE: **OWNER** FEIN: **33-1135400** ADDRESS CHANGES TO BE NOTED ABOVE

WHEN RESPONDING TO RFQ, INSERT NAME AND ADDRESS IN SPACE ABOVE LABELED 'VENDOR'



State of West Virginia
 Department of Administration
 Purchasing Division
 2019 Washington Street East
 Post Office Box 50130
 Charleston, WV 25305-0130

Request for Quotation

RFQ NUMBER
DEP13569

PAGE
8

ADDRESS CORRESPONDENCE TO ATTENTION OF:
CHUCK BOWMAN
304-558-2157

VENDOR

RFQ COPY
 TYPE NAME/ADDRESS HERE

501151933
MIDWAY RECLAMATION, LLC.
P.O. BOX 308
WEST MILFORD, WV 26451

SHIP TO

ENVIRONMENTAL PROTECTION
DEPT. OF
OFFICE OF SPECIAL RECLAMATION
105 S. RAILROAD STREET
PHILIPPI, WV
26416-9998 304-457-3219

DATE PRINTED 08/30/2006	TERMS OF SALE	SHIP VIA	F.O.B.	FREIGHT TERMS
-----------------------------------	---------------	----------	--------	---------------

BID OPENING DATE: **10/05/2006** BID OPENING TIME **01:30PM**

LINE	QUANTITY	UOP	CAT. NO.	ITEM NUMBER	UNIT PRICE	AMOUNT
ADDENDUM(S) AND HAVE MADE THE NECESSARY REVISIONS TO MY PROPOSAL, PLANS AND/OR SPECIFICATION, ETC. ADDENDUM NOS.: NO. 1 NO. 2 NO. 3 NO. 4 NO. 5 I UNDERSTAND THAT FAILURE TO CONFIRM THE RECEIPT OF THE ADDENDUM(S) MAY BE CAUSE FOR REJECTION OF THE BIDS. <i>Nancy S. Somers</i> SIGNATURE MIDWAY RECLAMATION LLC COMPANY 10-05-2006 DATE REV. 11/96 CONTRACTORS LICENSE WEST VIRGINIA STATE CODE 21-11-2 REQUIRES THAT ALL PERSONS DESIRING TO PERFORM CONTRACTING WORK IN THIS STATE MUST BE LICENSED. THE WEST VIRGINIA CONTRACTORS LICENSING BOARD IS EMPOWERED TO ISSUE THE CONTRACTORS LICENSE. APPLICATIONS FOR A CONTRACTORS LICENSE MAY BE MADE BY CONTACTING THE WEST VIRGINIA DIVISION OF LABOR						

SEE REVERSE SIDE FOR TERMS AND CONDITIONS

SIGNATURE <i>Nancy S. Somers</i>	TELEPHONE 304-745-3652	DATE 10-05-06
TITLE OWNER	FEIN 33-1135400	ADDRESS CHANGES TO BE NOTED ABOVE

WHEN RESPONDING TO RFQ, INSERT NAME AND ADDRESS IN SPACE ABOVE LABELED 'VENDOR'



State of West Virginia
 Department of Administration
 Purchasing Division
 2019 Washington Street East
 Post Office Box 50130
 Charleston, WV 25305-0130

Request for Quotation

RFQ NUMBER
DEP13569

PAGE
9

ADDRESS CORRESPONDENCE TO ATTENTION OF:
CHUCK BOWMAN 304-558-2157

VENDOR

RFQ COPY
 TYPE NAME/ADDRESS HERE

501151933

MIDWAY RECLAMATION, LLC
 P.O. BOX 308
 WEST MILFORD, WV 26451

SHIP TO

ENVIRONMENTAL PROTECTION
 DEPT. OF
 OFFICE OF SPECIAL RECLAMATION
 105 S. RAILROAD STREET
 PHILIPPI, WV
 26416-9998 304-457-3219

DATE PRINTED	TERMS OF SALE	SHIP VIA	F.O.B.	FREIGHT TERMS
08/30/2006				

BID OPENING DATE: **10/05/2006** BID OPENING TIME **01:30PM**

LINE	QUANTITY	UOP	CAT. NO.	ITEM NUMBER	UNIT PRICE	AMOUNT
CAPITOL COMPLEX, BUILDING 3, ROOM 319, CHARLESTON, WV 25305. TELEPHONE: (304) 558-7890. WEST VIRGINIA STATE CODE 21-11-11 REQUIRES ANY PROSPECTIVE BIDDER TO INCLUDE THE CONTRACTORS LICENSE NUMBER ON THEIR BID. BIDDER TO COMPLETE: CONTRACTORS NAME: ... <u>MIDWAY RECLAMATION LLC</u> CONTRACTORS LICENSE NO.: <u>WV040515</u> THE SUCCESSFUL BIDDER WILL BE REQUIRED TO FURNISH A COPY OF THEIR CONTRACTORS LICENSE PRIOR TO ISSUANCE OF A PURCHASE ORDER/CONTRACT APPLICABLE LAW THE WEST VIRGINIA STATE CODE, PURCHASING DIVISION RULES & REGULATIONS, PURCHASING DIVISION POLICY STATEMENTS, AND THE INFORMATION PROVIDED IN THE "REQUEST FOR QUOTATION" ISSUED BY THE PURCHASING DIVISION IS THE SOLE AUTHORITY GOVERNING THIS PROCUREMENT. ANY INFORMATION PROVIDED IN SPECIFICATION MANUALS, OR ANY OTHER SOURCE, VERBAL OR WRITTEN, WHICH CONTRADICTS OR ALTERS THE INFORMATION PROVIDED FROM THE SOURCES AS DESCRIBED IN THE ABOVE PARAGRAPH IS VOID AND OF NO EFFECT. FOR AGENCY USE ONLY: 9202 A SIGNED BID MUST BE SUBMITTED TO:						

SEE REVERSE SIDE FOR TERMS AND CONDITIONS

SIGNATURE	<i>Nancy S. Somers</i>	TELEPHONE	304-745-3652	DATE	10-05-06
TITLE	OWNER	FEIN	33-1135400	ADDRESS CHANGES TO BE NOTED ABOVE	

WHEN RESPONDING TO RFQ, INSERT NAME AND ADDRESS IN SPACE ABOVE LABELED 'VENDOR'

BUYER CB-23	PAGE 011	REQ. OR PO NO. DEP 13569
SPENDING UNIT WEST VIRGINIA DEPARTMENT OF ENVIRONMENTAL PROTECTION/SPECIAL RECLAMATION		

WV-36a STATE OF WEST VIRGINIA
 Rev. 1/29/02 PURCHASING CONTINUATION SHEET
 VENDOR: **MIDWAY RECLAMATION LLC**

SCOPE OF WORK

The successful bidder shall provide appropriate equipment, materials, labor and any technical services needed for the successful reclamation of GOLDEN PRODUCTS COMPANY, Permit S-1009-88, and any disturbance associated with such operation. The General Performance Standards (GPS) shall apply to all items in Scope of Work.

Work necessary on this site will include the following items, but is not limited to these:

1. Upon mobilization to the site, which will be directed in a written Notice to Proceed, the access roads shall be developed in accordance with bid item #6 & #7. If, fuel and lubricants are to be stored on site, bid item #2 shall be in place before fuel is delivered. The project sign is to be obtained and installed.
2. Storm water management in the form as described in bid item #3 shall be installed (described locations).
3. Revegetation and soil improvements are required for areas designated at pre-bid meeting. Reclamation is to be according to the attached specifications, plans, and clarifying discussions at the Pre-Bid Conference.
4. Upgrade existing road.
5. Construct new access road.
6. Construct haul road (for transport of limestone for limestone drains).
5. Construct limestone bed according to plans and specifications.
6. Construct limestone drains according to plans and specifications.
7. Construct settling pond.
8. Construct riprap ditches or open limestone channels.
9. Construct seep collectors.
10. Vegetate disturbed areas with seed, lime, and fertilizer.
11. Any other site specific items required.

I, David B. McCoy, the undersigned, hereby certify¹ that this Reclamation Plan is correct and shows to the best of my knowledge and belief all the information required by the surface mining laws of the State of West Virginia. The source of information was the approved mining and reclamation plan contained in the forfeited surface mine permit, existing site conditions and information contained in the WV DEP, Inspection and Enforcement files.

David B. McCoy
 Registered Professional Engineer WV No. 14375

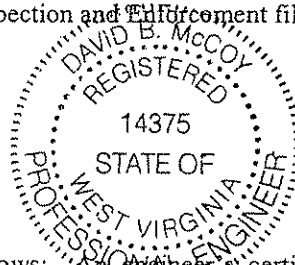

Date: 8-8-2006

¹ The term "certify" as used herein is defined as follows: An Engineer's certification of conditions is a declaration of professional judgment. It does not constitute a warranty or guarantee, either expressed or implied.

MIDWAY RECLAMATION, LLC.
P.O. BOX 308
WEST MILFORD, WV 26451

BUYER CB-23	PAGE 012	REQ. OR PO NO. DEP 13569
SPENDING UNIT WEST VIRGINIA DEPARTMENT OF ENVIRONMENTAL PROTECTION/SPECIAL RECLAMATION		

WV-36a STATE OF WEST VIRGINIA
Rev. 1/29/02 PURCHASING CONTINUATION SHEET
VENDOR: MIDWAY RECLAMATION LLC

ITEM NO.	QUANTITY	DESCRIPTION	UNIT PRICE	AMOUNT
BID SCHEDULE				
PERMIT NAME: <u>GOLDEN PRODUCTS COMPANY</u>				
PERMIT NUMBER(S): <u>S-1009-88</u>				
1.0	LUMP SUM	<u>MOBILIZATION/DEMobilIZATION/PROJECT SIGN</u> (5% Total Bid Maximum for this permit)	LUMP SUM	\$ <u>8000.00</u>
2.0	LUMP SUM	<u>SPILL CONTAINMENT AREA (S.C.A.)</u> (\$1,000.00 Maximum Bid for this permit)	LUMP SUM	\$ <u>500.00</u>
3.0	<u>600</u> LF	<u>HAYBALE DIKE</u> (Max. Bid \$5.00 Per LF)	\$ <u>5.00</u> PER LF	\$ <u>3000.00</u>
4.0	LUMP SUM	<u>CLEAR AND GRUB</u>	LUMP SUM	\$ <u>2000.00</u>
5.0	NO BID ITEM	<u>UTILITIES</u>	NO BID ITEM	
6.0	LUMP SUM	<u>UPGRADE EXISTING ROAD</u>	LUMP SUM	\$ <u>5,500.00</u>
7.0	<u>450</u> LF	<u>CONSTRUCT NEW ACCESS ROAD</u>	\$ <u>18.00</u> PER LF	\$ <u>8,100.00</u>
8.0	<u>440</u> LF	<u>CONSTRUCT HAUL ROAD</u>	\$ <u>14.00</u> PER LF	\$ <u>6,160.00</u>
9.0	<u>56</u> LF	<u>8-INCH SDR 35 PVC CULVERTS</u>	\$ <u>10.00</u> PER LF	\$ <u>560.00</u>
10.0	<u>60</u> LF	<u>12-INCH HDPE CULVERT</u>	\$ <u>19.00</u> PER LF	\$ <u>1,140.00</u>
11.0	<u>40</u> LF	<u>24-INCH HDPE CULVERT</u>	\$ <u>40.00</u> PER LF	\$ <u>1,600.00</u>
12.0	<u>340</u> LF	<u>SEEP COLLECTOR</u>	\$ <u>26.00</u> PER LF	\$ <u>8,840.00</u>
13.0	LUMP SUM	<u>INCLINED LIMESTONE BED</u>	LUMP SUM	\$ <u>21,000.00</u>
14.0	<u>750</u> LF	<u>LIMESTONE DRAIN</u>	\$ <u>50.00</u> PER LF	\$ <u>37,500.00</u>

MIDWAY RECLAMATION, LLC.
P.O. BOX 308
WEST MILFORD, WV 26451

BUYER CB-23	PAGE 013	REQ. OR PO NO. DEP 13569
SPENDING UNIT WEST VIRGINIA DEPARTMENT OF ENVIRONMENTAL PROTECTION/SPECIAL RECLAMATION		

WV-36a STATE OF WEST VIRGINIA
Rev. 1/29/02 PURCHASING CONTINUATION SHEET
VENDOR: MIDWAY RECLAMATION LLC

ITEM NO.	QUANTITY	DESCRIPTION	UNIT PRICE	AMOUNT
15.0	650 LF	<u>TRAPEZOIDAL DITCH</u>	\$ <u>40.00</u> PER LF	\$ <u>26,000.00</u>
16.0	200 LF	<u>V-DITCH</u>	\$ <u>25.00</u> PER LF	\$ <u>5,000.00</u>
17.0	LUMP SUM	<u>SETTLING POND</u>	LUMP SUM	\$ <u>2,500.00</u>
18.0	LUMP SUM	<u>6 INCH SCH. 35 PVC PIPING, FITTINGS, VALVE</u>	LUMP SUM	\$ <u>5,000.00</u>
19.0		<u>REVEGETATION</u>		
19.1	6 AC	<u>AGRICULTURAL LIME</u>	\$ <u>700.00</u> PER ACRE	\$ <u>4,200.00</u>
19.2	6 AC	<u>FERTILIZER</u>	\$ <u>500.00</u> PER ACRE	\$ <u>3,000.00</u>
19.3	6 AC	<u>MULCH</u>	\$ <u>500.00</u> PER ACRE	\$ <u>3,000.00</u>
19.4	6 AC	<u>VEGETATIVE SPECIES</u>	\$ <u>400.00</u> PER ACRE	\$ <u>2,400.00</u>
		TOTAL PERMIT <u>S-1009-88</u>		\$ <u>155,000.00</u>

BUYER CB-23	PAGE 014	REQ. OR PO NO. DEP 13569
SPENDING UNIT WEST VIRGINIA DEPARTMENT OF ENVIRONMENTAL PROTECTION/SPECIAL RECLAMATION		

WV-36a STATE OF WEST VIRGINIA
 Rev. 1/29/02 PURCHASING CONTINUATION SHEET
 VENDOR: **MIDWAY RECLAMATION LLC**

BID ITEM TECHNICAL SPECIFICATIONS

1.0 MOBILIZATION/DEMobilIZATION/PROJECT SIGN

PROJECT SIGN

A project sign shall be obtained or manufactured and installed as indicated on the attached specifications and details. Payment for this sign shall be incidental to the mobilization item. No separate payment will be made.

MOBILIZATION

This work shall consist of the performance of construction preparatory operations, including the movement of personnel, equipment and other facilities to the project site necessary to begin work on a substantial phase of the contract.

DEMobilIZATION

Prior to demobilization, an inspection shall be conducted by the Department of Environmental Protection and the contractor to insure compliance with contract performance. Once compliance is ascertained, demobilization activities can be initiated and completed. Demobilization shall be totally completed before the invoice for payment shall be processed.

PAYMENT

The lump sum bid for this item shall not exceed 5% of the total bid for this permit. Payment shall be made in two 50% amounts, one upon completion of the mobilization and project sign items and the second payment at the completion of demobilization. No deduction shall be made nor shall any increase be made in the lump sum item amount, regardless of decreases or increases in the final total contract amount or any other reason.

2.0 SPILL CONTAINMENT AREA (S.C.A.)

Spill containment measures shall be used for fuel and lubricant storage areas. All containers, barrels, buckets, cans, etc., are to be legally disposed of off site. Used lubricants are to be disposed of according to state law to minimize pollution to the local surface and ground water supplies. Spills are the responsibility of the contractor and need immediate clean up and maintained at no expense to the State. This S.C.A. shall be constructed in accordance with the typical drawing specification. (See Attachment) Alternate containment measures will be considered for approval by the Program Manager if acceptable results can be shown. Fuel tanks manufactured with secondary containment are desirable. Minimum secondary containment is 110 percent. (Bid limited to \$1,000.00 maximum).

3.0 HAYBALE DIKE

Disturbed areas, which have storm water runoff that does not pass through a sediment control structure, shall utilize the following method to manage storm water runoff: Max. Bid of \$5.00/LF of Hay Bale Dike.

1. All bales shall be placed on the contour.
2. Bales shall be placed in a row with ends tightly abutting the adjacent bales.
3. Bales shall be securely anchored in place by stakes or rebar driven through the bales. Rebar to be removed at the direction of DEP. The first stake in each bale shall be driven toward previously laid bale to force the bales together. Construction of sumps may become necessary to supplement the hay bale dikes.

BUYER CB-23	PAGE 015	REQ. OR PO NO. DEP 13569
SPENDING UNIT WEST VIRGINIA DEPARTMENT OF ENVIRONMENTAL PROTECTION/SPECIAL RECLAMATION		

WV-36a STATE OF WEST VIRGINIA
 Rev. 1/29/02 PURCHASING CONTINUATION SHEET
 VENDOR: **MIDWAY RECLAMATION LLC**

4.0 CLEAR AND GRUB

All vegetative cover (trees, shrubs, bushes etc.) within the entire work area shall be removed to bare ground. It is the contractor's responsibility to obtain all necessary permits and to follow state guidelines for burning and proper disposal of vegetative materials. A majority of the area, where the passive treatment system will be constructed, is on private property; therefore, it is imperative that the contractor in conjunction with the on-site DEP representative cooperate with the landowner to identify construction limits and property lines. Any timber cut in the clear and grub area that the landowner wishes to retain shall be de-limbed and stockpiled.

5.0 UTILITIES

This is a no bid item. A natural gas line is buried across the property, and the contractor shall be responsible for having the utility company locate and flag any buried lines at the construction site. The new road construction shall cross over a buried natural gas line, which is near an above ground marker. This marker may need to be relocated 10' to 20' away from the roadway to prevent any future damage to the marker. It shall be the responsibility of the contractor to coordinate with the utility company to have the marker relocated.

6.0 UPGRADE EXISTING ROAD

Access to the construction site will be through the driveway for the Davis's residence. The contractor shall maintain the driveway (~530 LF) during the reclamation process to provide access on a well-drained surface. A three (3) inch minimum layer of 1.5 inch crusher run limestone shall be placed on the road during construction. The access road shall be maintained to drain and provide a road surface free of excessive mud and standing waters at all times while work is in progress. Upon completion of all reclamation activities, a final layer of 3/4 inch crusher run limestone shall be placed in a two (2) inch minimum layer on the existing road. Dust-control measures may be necessary if hauling creates airborne material. A roadside vegetated ditch may need to be established along portions of this road, and shall be incidental with this bid item.

7.0 CONSTRUCT NEW ACCESS ROAD

This required road will be approximately 450 LF. Accompanying plans show the details of the construction of the road. The contractor shall provide all services, materials, construction layout, equipment, or other materials necessary to execute the work. Payment shall be for completed length of road.

SITE PREPARATION

Any areas with soft unsuitable foundation materials shall be undercut to remove this material. The material removed shall be disposed of within the construction area at a site agreed to between the contractor and the DEP on site representative. Construction stake out shall be completed as necessary to complete that phase of the work being undertaken. Payment for the construction stakeout is to be included in the road price. No separate payment will be made for construction stake out.

ROAD CONSTRUCTION

Suitable foundation material shall be placed in compacted layers not to exceed six (6) inches in thickness to obtain the desired grade and alignment. Compaction equipment is to be approved by DEP on site representative. Filter Fabric (Tyvar 3401, Mirafi 500X, or equivalent) shall be placed over the completed foundation and covered with a six (6) inch minimum layer of No. 1 limestone (3½ to 1½ inches). The No. 1 stone shall then be covered with 1½ inch crusher run limestone so that the surface is choked off and a two (2) inch minimum layer remains on top. The completed road shall have a minimum width of twelve (12) feet and the surface shall be crowned and sloped to

BUYER CB-23	PAGE 016	REQ. OR PO NO. DEP 13569
SPENDING UNIT WEST VIRGINIA DEPARTMENT OF ENVIRONMENTAL PROTECTION/SPECIAL RECLAMATION		

WV-36a STATE OF WEST VIRGINIA
 Rev. 1/29/02 PURCHASING CONTINUATION SHEET
 VENDOR: **MIDWAY RECLAMATION LLC**

both sides a minimum of 24-horizontal to 1-vertical. Any fill sections, if used, shall not impound water. Payment shall be made at the unit price for the measured length completed.

The total length of roadside ditch shall be along the entire length of the newly constructed road. A roadside drainage ditch shall be established along the hillside of the road, and shall be free draining to any culverts crossing under the road. The ditch shall be vegetated and constructed as indicated in the New Access Road drawing.

8.0 CONSTRUCT HAUL ROAD

A road will be required to gain access to the limestone drain construction area and shall be 440 LF length. The road shall be constructed according to the attached typical plans, cross-section, specifications, and as discussed at the Pre-Bid Showing. The roadside ditch for this bid item shall be constructed as detailed in the V- Ditch bid item #16, beginning at the intersection of the limestone drain and ending at the switch-back in the haul road. The remainder of the roadside ditch shall be constructed as indicated in the New Haul Road drawing.

9.0 8-INCH SDR 35 PVC CULVERTS

Culverts shall be 8-inch SDR 35 PVC, bell & spigot, fourteen (14) foot joint type with gasket joints. Two pipes shall be installed side-by-side and perpendicular to the road. The location of culverts shall be at the low point in the Davis residence roadway, as determined and approved by the on-site DEP representative.

The culverts shall be installed in a trench excavated in solid undisturbed ground or formed by compacted earth. Due to existing site conditions, the culverts will require minimal cover and shall be approved upon installation by the on-site DEP. Payment shall be for completed length of culverts.

10.0 12-INCH HDPE CULVERT

Culvert shall be HDPE, dual wall smooth interior corrugated twenty (20) foot joint type. The pipe joints shall be silt-tight and the pipe shall meet ASTM D3350 manufacturing standards.

Culverts installed in sloped areas of the access road shall cross the road at a 30 degree angle downgrade with a minimum grade of three percent (3%) from inlet to outlet. Where culverts are placed in the dip of the road the pipe shall be installed perpendicular to the road.

Culvert inlet end shall be protected by a headwall of stable non-erodible material and the slope at the outlet shall be protected with an apron of rock riprap, energy dissipater or other designated material. The culvert shall be installed in a trench excavated in solid undisturbed ground or formed by compacted earth.

The culvert shall be imbedded in a formed trench to a depth no less than 1/10 the outside diameter of the pipe. Selected backfill material shall be placed around the culvert in four (4) inch layers and thoroughly compacted by means of hand tamping or manually directed power tampers or plate vibrators.

The culvert shall be covered with a minimum of twelve (12) inches or one-half the culvert diameter whichever is greater. One culvert shall be placed near the beginning of the Davis residence roadway, and the other two culverts shall be placed along the new access road and the new haul road. The location of the culverts shall be approved by the on-site DEP representative. Payment shall be for completed length of culverts.

11.0 24-INCH HDPE CULVERT

Culvert shall be HDPE, dual wall smooth interior corrugated twenty (20) foot joint type. The pipe joints shall be silt-tight and the pipe shall meet ASTM D3350 manufacturing standards.

The culvert is replacing an existing culvert. Due to existing site conditions, the angle with respect to the road will require adjustment upon installation. The final angle will be determined upon installation. The culvert shall have a minimum grade of three percent (3%) from inlet to outlet. Culvert inlet end shall be protected by a headwall of stable non-erodible material and the slope at the outlet shall be protected with an apron of rock riprap, energy dissipater or other designated material. The culvert shall be installed in a trench excavated in solid undisturbed

BUYER CB-23	PAGE 017	REQ. OR PO NO. DEP 13569
SPENDING UNIT WEST VIRGINIA DEPARTMENT OF ENVIRONMENTAL PROTECTION/SPECIAL RECLAMATION		

WV-36a STATE OF WEST VIRGINIA
 Rev. 1/29/02 PURCHASING CONTINUATION SHEET
 VENDOR: **MIDWAY RECLAMATION LLC**

ground or formed by compacted earth.

The culvert shall be imbedded in a formed trench to a depth no less than 1/10 the outside diameter of the pipe. Selected backfill material shall be placed around the culvert in four (4) inch layers and thoroughly compacted by means of hand tamping or manually directed power tampers or plate vibrators.

The culvert shall be covered with a minimum of six (6) inches. The location of the culverts shall be approved by the on-site DEP representative. The existing culvert shall remain the property of the landowner, after removal and replacement with the new culvert. Payment shall be for completed length of culverts.

12.0 SEEP COLLECTOR

Provide all materials and construct the seep conveyance drain according to the attached typical plans, cross-section, specifications, and as discussed at the Pre-Bid Showing. Payment for the seep conveyance drain shall be by the measured linear foot installed.

13.0 INCLINED LIMESTONE BED

Provide all materials and construct the inclined limestone bed according to the attached typical plans, cross-section, specifications, and as discussed at the Pre-Bid Showing. Inlet, outlet, and baffle elevations are critical for proper flow patterns and function of this treatment system. Take all precautions to ensure that the design elevations are met. Survey station numbers 1 and 291 on the attached plan view drawings must be used to set all required elevations.

The bed shall have a top width of approximately sixty (60) feet, a top length of one hundred twenty (120) feet and a total excavation volume of approximately 49,014 cubic feet. The bed shall have a maximum water depth of approximately 5.85 ft. with a top berm height of 8.5 ft. Side slopes shall be one horizontal to one vertical (1h:1v). Embankments shall be constructed in compacted lifts with no lift exceeding six (6) inches. All stones exceeding 6 inches shall be removed from the embankment material prior to being placed. Excess spoil material excavated from the limestone bed area shall be relocated to the old pond fill area as indicated on the attached Design Drawing, and as discussed at the Pre-Bid Showing.

The size of limestone shall be AASHTO #3 (2 ½ to 1 inches). The limestone bed shall have five baffles constructed of treated lumber and 40 mil. HDPE liner material. See the detail drawings for the limestone bed, inlet skimmer board, and the baffle construction. The limestone bed, skimmer board, and baffles are a lump sum bid item. The limestone bed outlet header piping and the by-pass piping system shall be paid under bid item #18.

14.0 LIMESTONE DRAIN

Provide all materials and construct the limestone drain according to the attached typical plans, cross-section, specifications, and as discussed at the Pre-Bid Showing. The limestone drain shall be six (6) feet wide by six (6) feet in depth or until solid coal pavement is reached, which ever is less. The size of limestone shall be AASHTO #1 (3 ½ to 1 ½ inches). Payment for the limestone drain shall be by the measured linear foot installed.

15.0 TRAPEZOIDAL DITCH

Provide all materials, excavate and construct the trapezoidal ditch as indicated on the attached typical plans, cross-section, specifications, and as discussed at the Pre-Bid Showing. R-5 limestone riprap shall be used in construction of the ditch. Ditches shall be free draining upon completion of construction. The length of channel may be adjusted to meet on site conditions. This type of ditch shall be located before the inclined limestone bed and shall be used for the emergency exit channels for the inclined limestone bed and settling pond. Payment shall be made by the linear foot.

BUYER CB-23	PAGE 018	REQ. OR PO NO. DEP 13569
SPENDING UNIT WEST VIRGINIA DEPARTMENT OF ENVIRONMENTAL PROTECTION/SPECIAL RECLAMATION		

WV-36a STATE OF WEST VIRGINIA
 Rev. 1/29/02 PURCHASING CONTINUATION SHEET
 VENDOR: **MIDWAY RECLAMATION LLC**

16.0 V-DITCH

Provide all materials, excavate and construct the V-ditch as indicated on the attached typical plans, cross-section, specifications, and as discussed at the Pre-Bid Showing. R-5 limestone riprap shall be used in construction of the ditch. Ditches shall be free draining upon completion of construction. The length of channel will be approximately 200 lf. This ditch line will also serve as the roadside ditch for a portion of the haul road. Its terminal end will lead into a 12-inch culvert that will be installed under the haul road. The 12-inch culvert is included under bid item #10. The length of ditch may be adjusted to meet on site conditions. Payment shall be made by the linear foot.

17.0 SETTLING POND

One settling pond shall be constructed. The pond shall have a top width of approximately forty (40) feet, a top length of eighty (80) feet and a total excavation volume of approximately 12,971 cubic feet. The pond shall have a water depth of approximately 6 ft. with 2 ft. of freeboard. Side slopes shall be two horizontal to one vertical (2h:1v). Embankments shall be constructed in compacted lifts with no lift exceeding six (6) inches. All stones exceeding 6 inches shall be removed from the embankment material prior to being placed. The embankment along the inlet pipe shall have a two feet by five feet bench cut so that the discharge pipe from the limestone bed centers the bench. Remove all vegetation during clearing & grubbing operations. Excess spoil material excavated from the settling pond area shall be relocated to the old pond fill area as indicated on the attached Design Drawing, and as discussed at the Pre-Bid Showing. The settling pond is a lump sum bid item. The settling pond outlet spillway shall be paid for under the trapezoidal ditch bid item #15.

18.0 6-INCH SCH. 35 PVC PIPING, FITTINGS, VALVE

Six (6) inch PVC SDR-35 line (gasket joint type) shall be provided. Installation is to be according to the manufacturer's recommendations. Provide all materials, equipment, excavation and personnel necessary for installation of the header outlet pipe of the inclined limestone bed to the settling pond and the by-pass piping and valve. A 6-inch diameter MJ gate valve shall be placed on the SDR 35 pipe. The valve will be operated with a 2-inch valve key, so a solid piece of pipe shall be used to extend to the ground surface with a cap. The purchase of an appropriate length valve key shall be included with this bid item. The pipe shall be buried with a minimum of two and one-half (2.5') feet of cover to avoid freezing. Cleanouts, molded elbows, caps, coupler fittings, wyes, and valve shall be incidental to this lump sum bid item.

19.0 REVEGETATION

The actual seeding date, within the work performance period, shall be at the discretion of the contractor, but a permanent vegetative cover must be established. Verification of materials used shall be required for payment. Seed bed preparation, unless otherwise approved, shall be conducted by industrial disks, or tracking with heavy equipment with cleat marks across slope and parallel to the final contours. The surface shall be tracked, track to track. Seeding shall commence after seedbed preparation on a loose and uncompacted soil and with the approval of the Department of Environmental Protection. Contractor shall provide equipment as necessary to secure approval of the seedbed. Revegetation activities shall be carried out in a continuous, concurrent, timely and uniform manner. Failure to do this may result in nonpayment for portions of or the entire Revegetation item. Hydroseeding or broadcast seeding with the approved species is acceptable. The application rate may be increased but the ratio is to remain constant, but no additional monetary compensation will be awarded. Areas outside the limits of construction, disturbed by the contractor, shall be revegetated by the contractor at no expense to DEP. Water utilized for hydroseeding shall be free of injurious or other toxic substances harmful to plant life. The source of water is subject to the approval of the DEP Specialist. It shall be the vendor's responsibility to repeat the procedures under REVEGETATION until a permanent vegetation is established. The acreage quantities in this contract are for bidding purposes only.

BUYER CB-23	PAGE 019	REQ. OR PO NO. DEP 13569
SPENDING UNIT WEST VIRGINIA DEPARTMENT OF ENVIRONMENTAL PROTECTION/SPECIAL RECLAMATION		

WV-36a STATE OF WEST VIRGINIA
 Rev. 1/29/02 PURCHASING CONTINUATION SHEET
 VENDOR: **MIDWAY RECLAMATION LLC**

A warranty period of one (1) year shall commence upon completion and payment of the revegetation item of the contract. No payment will be made for additional seeding necessary to comply with warranty requirements. The warranty period will be extended for one (1) year from the date of the last augmented seeding done by the contractor. The performance bond and labor and materials bond shall remain in effect throughout the warranty period. The Standards for Evaluating Vegetative Cover as presented in Title 38, CSR2, Section 9 of the West Virginia Surface Mining Reclamation Regulations will apply.

Equipment for the retracking/scarification to eliminate rills and gullies shall be mobilized and utilized to produce slopes consistent with the regrading and topsoiling bid item prior to warranty reseeding. No additional payment will be made by DEP for this warranty work.

19.1 AGRICULTURAL LIME

Use of blends and low-grade agricultural liming materials shall require prior approval. Lime shall be spread as soon as possible after delivery to site. Lime shall be applied evenly and uniformly distributed over the treated area. Lime shall be thoroughly mixed into the soil material. Lime subjected to adverse conditions before spreading will be deemed unacceptable. Failure to complete this phase shall result in nonpayment of this bid item.

Lime Applied at 10 ton/acre.

19.2 FERTILIZER

Fertilizer rates given for REVEGETATION are for 1,000 lbs. of 10-20-20 per acre. These rates are minimum and for bidding purposes.

Fertilizer shall be applied evenly and uniformly distributed over the treated area. Common complete fertilizers that meet the minimum standards are acceptable.

19.3 MULCH

Acceptable mulch for this project is wood fiber, hay, or straw.

Mulch: Wood Fiber @ 1.0 Ton/Acre

Hay or straw mulch may be substituted at a rate of 2.0 Ton/Acre

BUYER CB-23	PAGE 20	REQ. OR PO NO. DEP 13569
SPENDING UNIT WEST VIRGINIA DEPARTMENT OF ENVIRONMENTAL PROTECTION/SPECIAL RECLAMATION		

WV-36a STATE OF WEST VIRGINIA
 Rev. 1/29/02 PURCHASING CONTINUATION SHEET
 VENDOR: **MIDWAY RECLAMATION LLC**

19.4 VEGETATIVE SPECIES

Seeding rate required is for pure live seed (pls) in pounds per acre. The use of annuals or cover crops will not be considered for vegetative success.

NORTH MIX

<u>VEGETATIVE SPECIES</u> ¹	RATE/ACRE ¹
Orchard Grass	@ 15 lbs/acre
Birdsfoot Trefoil ²	@ 15 lbs/acre
Yellow Sweet Clover	@ 5 lbs/acre
Red Clover	@ 10 lbs/acre
Ky 31 Fescue	@ 15 lbs/acre
Foxtail Millet ³	@ 12 lbs/acre
Wheat or Rye ⁴	@ 50 lbs/acre

1. Seeding rate suggested is for pure live seed (pls) in pounds per acre.
2. Herbaceous legumes must be treated with the appropriate bacterium before seeding.
3. Spring mix.
4. Fall mix.

BUYER CB-23	PAGE 021	REQ. OR PO NO. DEP 13569
SPENDING UNIT WEST VIRGINIA DEPARTMENT OF ENVIRONMENTAL PROTECTION/SPECIAL RECLAMATION		

WV-36a STATE OF WEST VIRGINIA
 Rev. 1/29/02 PURCHASING CONTINUATION SHEET
 VENDOR: **MIDWAY RECLAMATION LLC**

BID PREPARATION INFORMATION

HISTORICAL INFORMATION

Prospective bidders may review files at the West Virginia Department of Environmental Protection, Charleston, WV office, or the Regional West Virginia Department of Environmental Protection Office at 105 South Railroad St., Philippi, WV 26416. These files may contain additional information not included in the contract. Documents including, but not limited to, permit applications, permits, inspection reports, environmental documents, permit violation history, geological and geotechnical information, probable hydrologic consequences, maps, modifications, NPDES information and other related data. Copies may be obtained upon request and payment of copying fees.

EXAMINATION OF BID PACKAGE AND SITE OF WORK

The bidder is required to examine, carefully, the bid package (plans, specifications, supplemental specifications, contract forms, etc.) and the site of the work contemplated. The submission of a bid shall be considered prima facie evidence that the bidder has made such examination and has judged for and satisfied themselves as to the character, quantity, and quality of work to be performed and the materials required to be furnished under the contract.

PREBID CONFERENCE

Only the prospective bidders on the sign-in sheet in attendance for the entire Pre-Bid Conference will be eligible to submit bids for consideration of this project.

VIDEO

The information given at the pre-bid showing by the project contact person or the assigned person shall be documented on video tape and shall be an integral part of this contract's requirements, but will not supersede the written contract.

INTENT OF CONTRACT

The intent of the contract is for the reclamation/restoration of forfeited mine lands as required by West Virginia Department of Environmental Protection. The contractor is to provide for the construction and completion in every detail of the work described. The Contractor shall furnish all labor, materials, equipment, tools, transportation, and supplies required to complete the work in accordance with the Plans, Specifications, and terms of the Contract.

Should any misunderstanding arise as to the intent or meaning of the Contract, or any discrepancy appear, the decision of the Director of Division of Land Restoration shall be final.

BUYER CB-23	PAGE 022	REQ. OR PO NO. DEP 13569
SPENDING UNIT WEST VIRGINIA DEPARTMENT OF ENVIRONMENTAL PROTECTION/SPECIAL RECLAMATION		

WV-36a STATE OF WEST VIRGINIA
 Rev. 1/29/02 PURCHASING CONTINUATION SHEET
 VENDOR: **MIDWAY RECLAMATION LLC**

GENERAL PERFORMANCE STANDARDS

INTRODUCTION

The performance standards and non-compliance penalties which govern special reclamation-bond forfeiture projects are in Chapter 22A, Article 3, of the Code of West Virginia and subsequent rules and regulations. The following performance standards are of a general nature and do not represent all the performance standards applicable to a special reclamation-bond forfeiture project. However, some or all of these standards will pertain to each project.

BACKFILLING

1. Unless otherwise noted, the highwall shall be eliminated and the disturbed area graded to the approximate original contour.
2. The material used to backfill and eliminate the highwall shall be sufficiently compacted so as to insure stability of the backfill throughout the warranty period.
3. The land above the highwall shall not be disturbed unless otherwise directed.
4. The best available material to support vegetation, sufficient to establish a permanent vegetative cover and to achieve the approved post mining land use, shall be used.

BLASTING

The performance standards of the blasting regulations must be adhered to.

LIFE OF CONTRACT

The purchase order contract becomes effective on the starting date as specified in the notice to proceed as issued by the Department of Environmental Protection. This contract extends for a period of one (1) year and may be renewed until such "reasonable time" thereafter as is necessary to complete the payment. A responsible Contractor's Agent shall be on the site at all working times who demonstrates a knowledge of mined land reclamation, contract requirements and responds to DEP (owner) inspections.

WORK PERFORMANCE PERIOD

The work performance period is a defined portion of the contract in which all items shall be completed. The work performance period is to be performed within 365 calendar days. Extensions may be granted based upon contractor's performance, weather conditions and site-specific site conditions.

NOTICE TO PROCEED

A notice to proceed shall be issued to the Contractor by the project contact person for the Department of Environmental Protection. Actual construction may only begin after a Notice to Proceed is given and as specified. Such notice shall specify the starting date of the Purchase Order, the work performance period, and the completion date of the work performance period.

PRE-CONSTRUCTION CONFERENCE

The Contractor in possession of the awarded purchase order shall schedule a Pre-Construction Conference on the site within ten (10) days after receiving the Notice To Proceed. The Contractor's foreman or the on-the-ground supervisor must attend.

BUYER CB-23	PAGE 023	REQ. OR PO NO. DEP 13569
SPENDING UNIT WEST VIRGINIA DEPARTMENT OF ENVIRONMENTAL PROTECTION/SPECIAL RECLAMATION		

WV-36a STATE OF WEST VIRGINIA
 Rev. 1/29/02 PURCHASING CONTINUATION SHEET
 VENDOR: **MIDWAY RECLAMATION LLC**

GENERAL SUPERVISION - This contract is under the general supervision of the West Virginia Department of Environmental Protection's contact person for the purpose of contract compliance, inspection only. Contractor shall supervise work being conducted at all times. All services rendered by the Engineer/Contact Person consist of professional opinions and recommendations made in accordance with generally accepted engineering practice. Under no circumstances is it the intent of the Engineer/Contact Person to directly control the physical activities of the Contractor or their worker's accomplishment of work on this project.

CONTRACTOR RESPONSIBILITY

The contractor is responsible for compliance with all aspects of this written contract. No changes will be honored without prior approval from the Program Supervisor.

SILENCE OF SPECIFICATIONS

The apparent silence of these Specifications, Supplemental Specifications, plans and Special Provisions as to any detail, or the apparent omission from them of a detailed description concerning any point shall be regarded as meaning that only material and workmanship of acceptable quality are to be used.

LAWS TO BE OBSERVED

The Contractor shall keep fully informed of all Federal and State laws, all local laws, ordinances, and regulations and all orders and decrees of bodies or tribunals having any jurisdiction or authority, which in any manner affect those engaged or employed on the work, or which in any way affect the conduct of the work. The Contractor shall at all times observe and comply with all such laws, ordinances, regulations, orders and decrees; and shall protect and indemnify the State and its representatives against any claim or liability arising from or based on the violation of any such laws, ordinances, regulations, orders, or decrees, whether by themselves, their subcontractors or their employees.

PERMITS, LICENSES AND TAXES

The Contractor shall procure all permits and licenses, pay all charges, fees, and taxes, and give all notices necessary and incidental to the due and lawful prosecution of the work.

CONCURRENT RECLAMATION

Reclamation of this project shall commence at a definite point as defined and shall progress from that point with total reclamation to include backfilling, grading/regrading, and revegetation. Changes may be granted based upon weather or differing site conditions with prior approval.

BUYER CB-23	PAGE 024	REQ. OR PO NO. DEP 13569
SPENDING UNIT WEST VIRGINIA DEPARTMENT OF ENVIRONMENTAL PROTECTION/SPECIAL RECLAMATION		

WV-36a STATE OF WEST VIRGINIA
Rev. 1/29/02 PURCHASING CONTINUATION SHEET
VENDOR: **MIDWAY RECLAMATION LLC**

WATER QUALITY CONTROL

Shall commence with initial start-up of the project and remain in effect for the extent of the backfilling, regrading and revegetation activity. DEP obtains a storm water permit for each project from the Water Resources Division. (General Water Pollution Control Permit WVO115924) The Contractor is responsible for performing the best management practices. Adequate facilities shall be installed, operated and maintained using the best management practices of the U.S. Environmental Protection Agency's Non-Point Source (NPS) Program for sediment control during the active reclamation. The contractor shall take any and all steps necessary to prevent erosion or silting problems from occurring and to minimize pollution or sedimentation of the stream. If any such problems develop, the contractor shall be responsible to take immediate corrective action. No separate payment for this work will be honored. All impounded waters which require removal during reclamation, shall be pumped with appropriate measures taken to prevent erosion from the discharge. The contractor shall be responsible for treatment of said waters to meet pH standards. The water shall be discharged only when the quality meets a pH equivalent to the pH of the receiving stream but not less than 6.0.

DIFFERING SITE CONDITIONS

During the progress of the work, if subsurface or latent physical conditions are encountered at the site differing materially from those indicated in the contract or if unknown physical conditions of an unusual nature, differing materially from those ordinarily encountered and generally recognized as inherent in the work provided by the contract, are encountered at the site, the party discovering such conditions shall promptly notify the other party in writing of the specific differing conditions before they are disturbed and before the affected work is performed.

Upon written notification, the Engineer/Contact Person will investigate the conditions, and if determined that the conditions materially differ and cause an increase or decrease in the cost or time required for the performance of any work under the contract, an adjustment, excluding loss of anticipated profits, will be made and the contract modified in writing accordingly. The Engineer/Contact Person will notify the Contractor of DEP's determination whether or not an adjustment of the contract is warranted.

No contract adjustment which results in a benefit to the Contractor will be allowed unless the Contractor has provided the required written notice.

No contract adjustment will be allowed under this clause for any effects caused on unchanged work.

HANDLING AND STORAGE OF MATERIALS

Materials which are stored on site, before utilization, shall be stored so as to assure the preservation of their quality and fitness for the work. Stored materials, even though approved before storage, may be inspected again prior to their use in the work. Damaged or deteriorated materials shall be removed and replaced by materials meeting the original specifications.

Aggregate stockpiles shall be made on ground that is denuded of vegetation, hard, and well drained. Removal of aggregate from the stockpile shall be done in a manner which will not result in the inclusion of foreign material into the aggregate. The use of the aggregate will determine if exceptions are permitted.

All materials shall be handled in such a manner as to preserve their quality and fitness for the work.

MAINTENANCE DURING CONSTRUCTION

The contractor shall maintain the work during construction and until the project is accepted. All cost of maintenance work during construction and before the project is accepted shall be included in the unit or lump sum prices on the various pay items.

BUYER CB-23	PAGE 025	REQ. OR PO NO. DEP 13569
SPENDING UNIT WEST VIRGINIA DEPARTMENT OF ENVIRONMENTAL PROTECTION/SPECIAL RECLAMATION		

WV-36a STATE OF WEST VIRGINIA
 Rev. 1/29/02 PURCHASING CONTINUATION SHEET
 VENDOR: **MIDWAY RECLAMATION LLC**

FINAL INSPECTION

A final inspection meeting by the Department of Environmental Protection's Specialist and the contractor is required for the construction phase and prior to demobilization.

ACREAGE QUANTITIES

The acreage quantities in this contract are for bidding purpose and are set (definite) number for the project area as specified at the pre-bid showing. Only surveyed acreage's through figures the Contractor and/or the State develops will be honored to alter these acreage numbers.

PAYMENT

Invoices must be submitted on prescribed Department of Environmental Protection, Special Reclamation Program forms and include verification. Certified contractor payrolls for operators directly involved in this project and a current workers compensation certificate must accompany each invoice for payment. Verification of wage rates may include employee interviews. Invoices shall be signed in blue ink so that it is easy to verify that document is an original.

MOBILIZATION/DEMobilIZATION shall be invoiced at fifty percent (50%) with the first invoice and the last 50% invoiced after demobilization and acceptance of the road abandonment or final invoice. Demobilization must have written approval.

SPILL CONTAINMENT AREA shall not exceed \$1,000.00 and will be payable in two payments. The first fifty percent (50%) payable with the first invoice and the remainder payable when all fuel tanks, containers and etc., are removed from the site.

Lump sum items shall be percentage payments based on work completed at time of invoice and paid upon acceptance by the Department of Environmental Protection.

Unit items shall be invoiced by specified units completed and accepted by the DEP.

FAILURE TO COMPLETE ON TIME AND LIQUIDATED DAMAGES

Time is an essential element of the Contract and it is important that the work be completed within the time specified. The cost to the Department of the administration of the Contract, including engineering, inspection and supervision, will increase as the time required to complete the work is increased.

The work performance period as specified in the contract's Notice to Proceed shall be complied with or result in liquidated damages. Such damages shall be assessed at an amount of two hundred and fifty dollars (\$250.00) per day for each and every day beyond the work performance period as specified in the Notice to Proceed. The total amount of daily charges will be deducted from any moneys due the Contractor, not as a penalty but as liquidated damages.

BUYER CB-23	PAGE 026	REQ. OR PO NO. DEP 13569
SPENDING UNIT WEST VIRGINIA DEPARTMENT OF ENVIRONMENTAL PROTECTION/SPECIAL RECLAMATION		

WV-36a STATE OF WEST VIRGINIA
 Rev. 1/29/02 PURCHASING CONTINUATION SHEET
 VENDOR: **MIDWAY RECLAMATION LLC**

REVEGETATION AND WARRANTY

The seeding date shall be at the discretion of the contractor once an approved seedbed has been prepared. In all cases a permanent vegetative cover capable of supporting the post-mining land use must be established. A warranty period of one (1) year shall commence upon completion and payment of the revegetation item of the contract. No payment will be made for additional seeding necessary to comply with warranty requirements. The warranty period will be extended for one (1) year from the date of the last augmented seeding done by the contractor. The performance bond and labor and materials bond shall remain in effect throughout the warranty period. The Standards for Evaluating Vegetative Cover as presented in Title 38, CSR2, Section 9 of the West Virginia Surface Mining Reclamation Regulations will apply.

Equipment for the retracking/scarification to eliminate rills and gullies shall be mobilized and utilized to produce slopes consistent with the regrading and topsoiling bid item prior to warranty reseeding. No additional payment will be made by DEP for this warranty work.

Water utilized for hydroseeding shall be free of injurious or other toxic substances harmful to plant life. The source of water is subject to the approval of the DEP contact person.

CONTRACT NON-COMPLIANCE

If in the opinion of the Department of Environmental Protection the contract is not in compliance with any line item specification, that portion of the project shall cease until a compliance schedule and understanding is demonstrated in writing and accepted by the Director of Division of Land Restoration.

CONTRACT DELETIONS

Any line item, or any portion thereof, may be deleted when determined by the project contact person that such line item, or portion thereof, is deemed unnecessary for the successful reclamation of this project. No claim for loss of anticipated profits will be considered.

CANCELLATION

The performance of work under contract may be terminated by the State in whole, or from time to time in part whenever the State shall determine that such termination is in the best interest of the State. Any such termination shall be effected by delivery to the Contractor of a Notice of Termination specifying the extent to which performance of work under the Contract is terminated and the date upon which such termination becomes effective.

When contracts, or any portion thereof, are terminated before completion of all items of work in the Contract, payment will be made for the actual number of units or items of work completed and accepted at the contract unit price. No claim for loss of anticipated profits will be considered. Reimbursement for organization of the work, when not otherwise included in the Contract, and moving equipment to and from the job will be considered where the volume of work completed and accepted is too small to compensate the Contractor for these expenses under the contract unit prices, the intent being that an equitable settlement will be made with the Contractor.

Termination of the Contract or a portion thereof shall not relieve the Contractor of his responsibilities for the completed work, nor shall it relieve his surety of it's obligation for and concerning any just claims arising out of the work performed.

This contract may be cancelled in whole or in part in writing by the Director of Purchasing, without prejudice to any other right or remedy it may have, provided that the contractor is given not less than thirty (30) calendar days written notice, (delivered by certified mail, return receipt requested) of intent to terminate. This contract objective is to comply with the reclamation laws of this state and must be expedient to meet the time requirements for reclamation of revoked surface mine permits.

BUYER CB-23	PAGE 027	REQ. OR PO NO. DEP 13569
SPENDING UNIT WEST VIRGINIA DEPARTMENT OF ENVIRONMENTAL PROTECTION/SPECIAL RECLAMATION		

WV-36a STATE OF WEST VIRGINIA
 Rev. 1/29/02 PURCHASING CONTINUATION SHEET
 VENDOR: MIDWAY RECLAMATION LLC

S

Attn:

A

Re: Notice to Proceed
 Permit Name: _____
 Permit No. _____
 Purchase Order No.: DEP

Dear :

M

The purpose of this letter is to express our appreciation for your work in advance and to recognize a reclamation partnership project. The official starting date for the above mentioned purchase order is . The work performance period must be completed by . The contract life of one year is provided to accomplish all line items and to process all payments within that period.

You must schedule a pre-construction conference on site within ten (10) days after receiving this notice to proceed. It is then mandatory that construction begins within ten (10) days of the pre-construction conference and continues diligently until completion of the project. Please contact this office to schedule the pre-construction conference. The foreman, superintendent, or on-the-ground supervisor must be in attendance at this conference.

Failure to comply with this notice to proceed will cause termination of the contract and forfeiture of your performance bond.

If you have any questions please feel free to contact this office.

L

Sincerely,

E

BUYER CB-23	PAGE 028	REQ. OR PO NO. DEP 13569
SPENDING UNIT WEST VIRGINIA DEPARTMENT OF ENVIRONMENTAL PROTECTION/SPECIAL RECLAMATION		

WV-36a STATE OF WEST VIRGINIA
Rev. 1/29/02 PURCHASING CONTINUATION SHEET
VENDOR: **MIDWAY RECLAMATION LLC**

General Requirements

Project Construction Sign

Work Required

The work to be performed under this Section consists of providing all labor, material and equipment necessary to install a project sign as indicated on the detail included herein and as specified herein.

Materials

- (a) Paint. Paint for the project sign shall be one (1) coat Exterior-Grade Wood Primer- Sealer, and two (2) coats Exterior-Grade Enamel by Glidden or equivalent.
- (b) Wood. Sign face shall be 3/4" X 4' X 8' Marine Exterior plywood, and posts and cross braces shall be treated.
- (c) Hardware. All hardware shall be manufactured from good, commercial-quality material and be rust resistant such as galvanized coated.

Execution

- (a) Project Sign. The signboard shall be cut to the dimensions shown on the details herein. The sign shall be painted with one (1) coat of primer and two (2) coats of white enamel. All exterior cut edges shall be smooth sanded prior to painting. All edges shall be double primed. The letters, border and strips shall be painted as shown on the detail drawing.

The Contractor shall bolt the sign to posts and provide required cross bracing. The posts and sign shall be erected and posts set in gravel base, as shown on the drawings. One (1) sign is required and is to be located at the direction of WVDEP.

- (b) Payment. Payment for the work which shall include installation of the project sign shall be incidental to the lump sum bid item for "Mobilization/Demobilization"

Note: No construction work shall commence prior to the project sign being installed.

STATE OF WEST VIRGINIA
DEPARTMENT OF ENVIRONMENTAL PROTECTION

Division of Land Restoration
Office of Special Reclamation

Project Cost: \$XXX,XXX.00
Funding provided by the Special Reclamation Coal Tax paid by WV Coal Mine Companies

Permit Name
Permit Number

Contractor: Joe Smith Contracting Project Start Date: 01/01/01



Joe Manchin, III
Governor



Stephanie Timmermeyer,
Cabinet Secretary



Ken Ellison,
Director

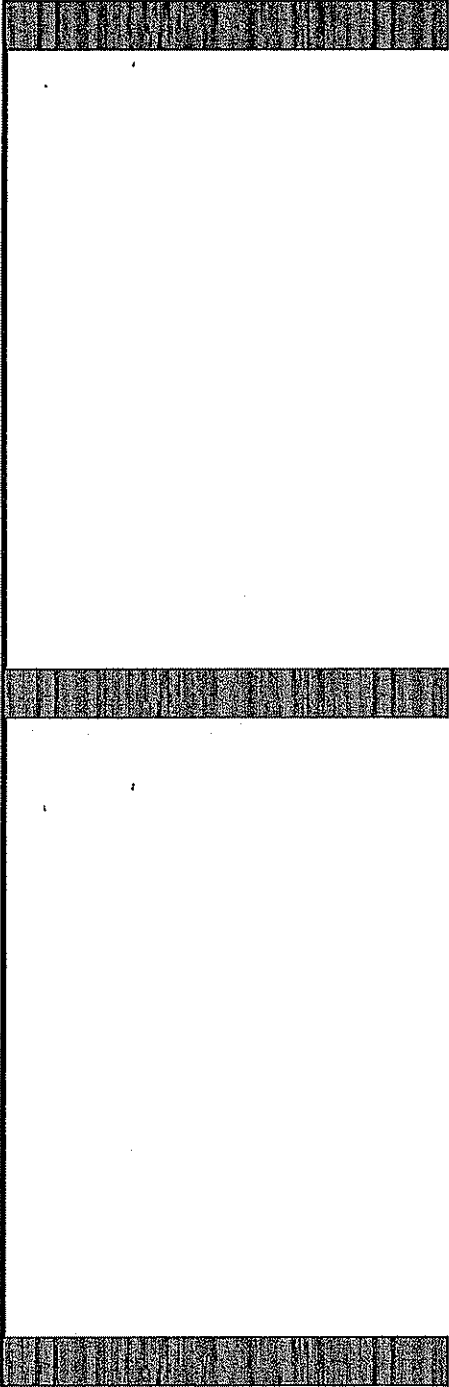

77 1/4"

27 3/4"

18"

2 1/4"

17 1/4"

1 1/2"

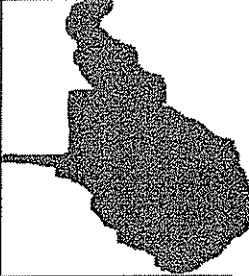

STATE OF WEST VIRGINIA
DEPARTMENT OF ENVIRONMENTAL PROTECTION

Division of Land Restoration
Office of Special Reclamation

Joe Manchin, III
Governor



Stephanie Timmermeyer,
Cabinet Secretary



Ken Ellison,
Director

Project Cost: \$XXX,XXX.00
Funding provided by the Special Reclamation Coal Tax paid by WV Coal Mine Companies

Permit Name
Permit Number
Contractor: Joe Smith Contracting
Project Start Date: 01/01/01

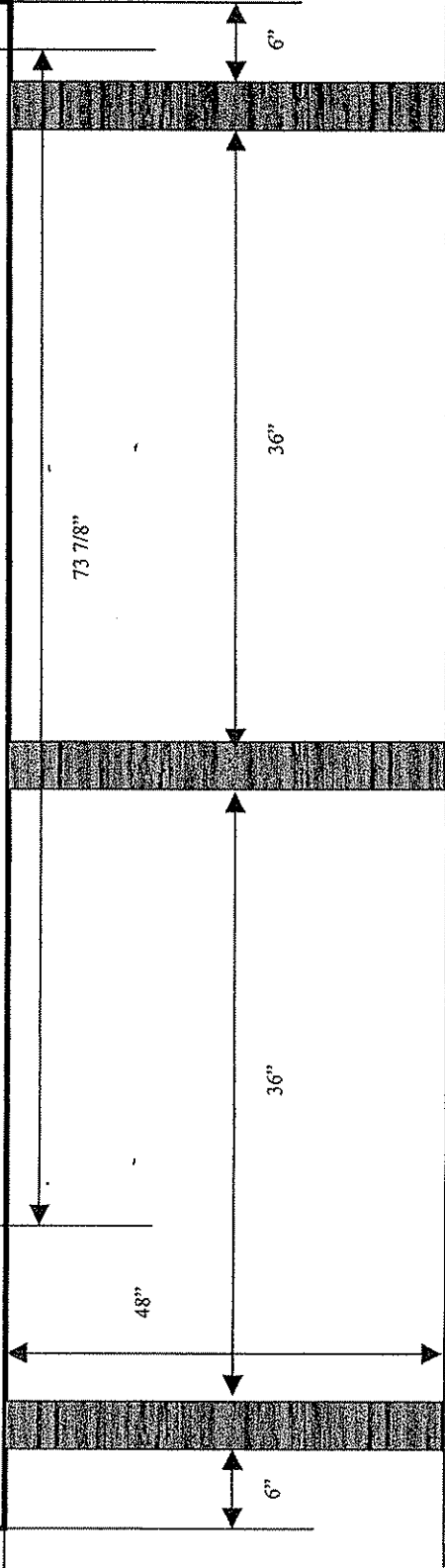

48"

73 7/8"

36"

36"

6"

6"

2 1/4"

96"



STATE OF WEST VIRGINIA
DEPARTMENT OF ENVIRONMENTAL PROTECTION

Division of Land Restoration
Office of Special Reclamation

Joe Manchin, III
Governor

Project Cost: \$XXX,XXX.00
Funding provided by the Special Reclamation Coal Tax paid by WV Coal Mine Companies



Stephanie Timmermeyer,
Cabinet Secretary



Ken Ellison,
Director

Permit Name
Permit Number
Contractor: Joe Smith Contracting
Project Start Date: 01/01/01

81 3/8"

7 7/8"

9 3/8"

5 1/4"

48"



1 1/2" Joe Manchin, III
1/4" Governor



1" Stephanie Timmermeyer,
1/4" Cabinet Secretary



1" Ken Ellison,
1/4" Director

6" STATE OF WEST VIRGINIA
2 1/4" DEPARTMENT OF ENVIRONMENTAL PROTECTION

3 3/4" Division of Land Restoration
2 1/4" Office of Special Reclamation

3 3/4" Project Cost: \$XXX,XXX.00
1 1/4" Funding provided by the Special Reclamation Coal Tax paid by WV Coal Mine Companies

2 1/4" Permit Name

1 1/4" Permit Number

4 7/8" Contractor: Joe Smith Contracting
1 1/4" Project Start Date: 01/01/01



- NOTES:**
- 1.) SIGN BOARD TO BE 3/4" x 4' x 8' MARINE PLYWOOD.
 - 2.) SIGN BOARD COLOR IS WHITE AND LETTER COLORS ARE DARK GREEN.
 - 3.) TREATED 2" x 4" CROSS BRACE LET INTO POSTS.
 - 4.) MOUNT SIGN TO POSTS USING 3/8" x 5" GALVANIZED CARRIAGE BOLTS.
 - 5.) USE 4" x 4" x 12' TREATED POSTS.
 - 6.) LOCATION DETERMINED BY WVDEP.

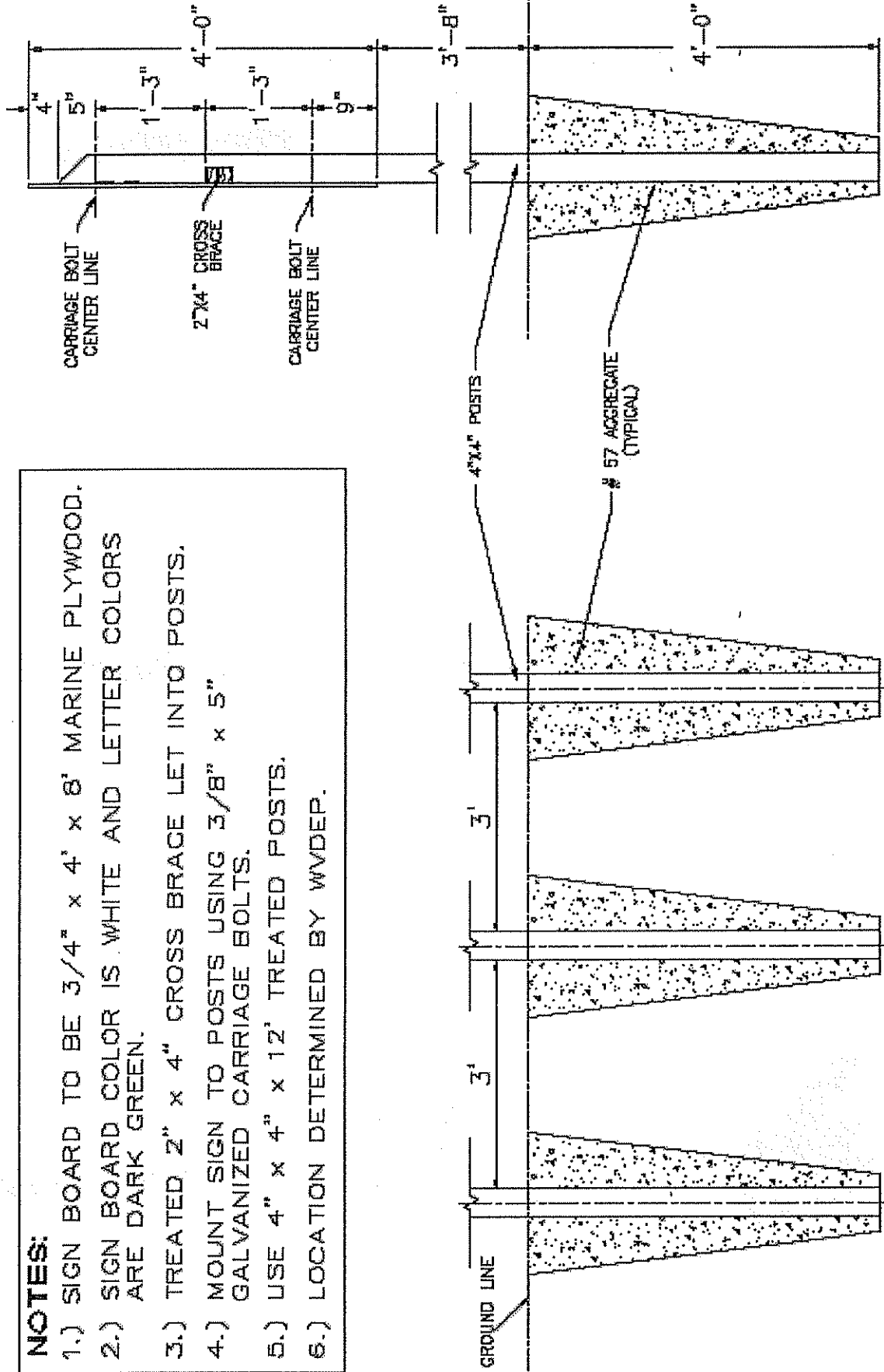

PROJECT SIGN
NOT TO SCALE

**GOLDEN
PRODUCTS
PERMIT NO.
S-1009-88**

CB-23

PAGE

034 DEP 13569

LOCATION MAP

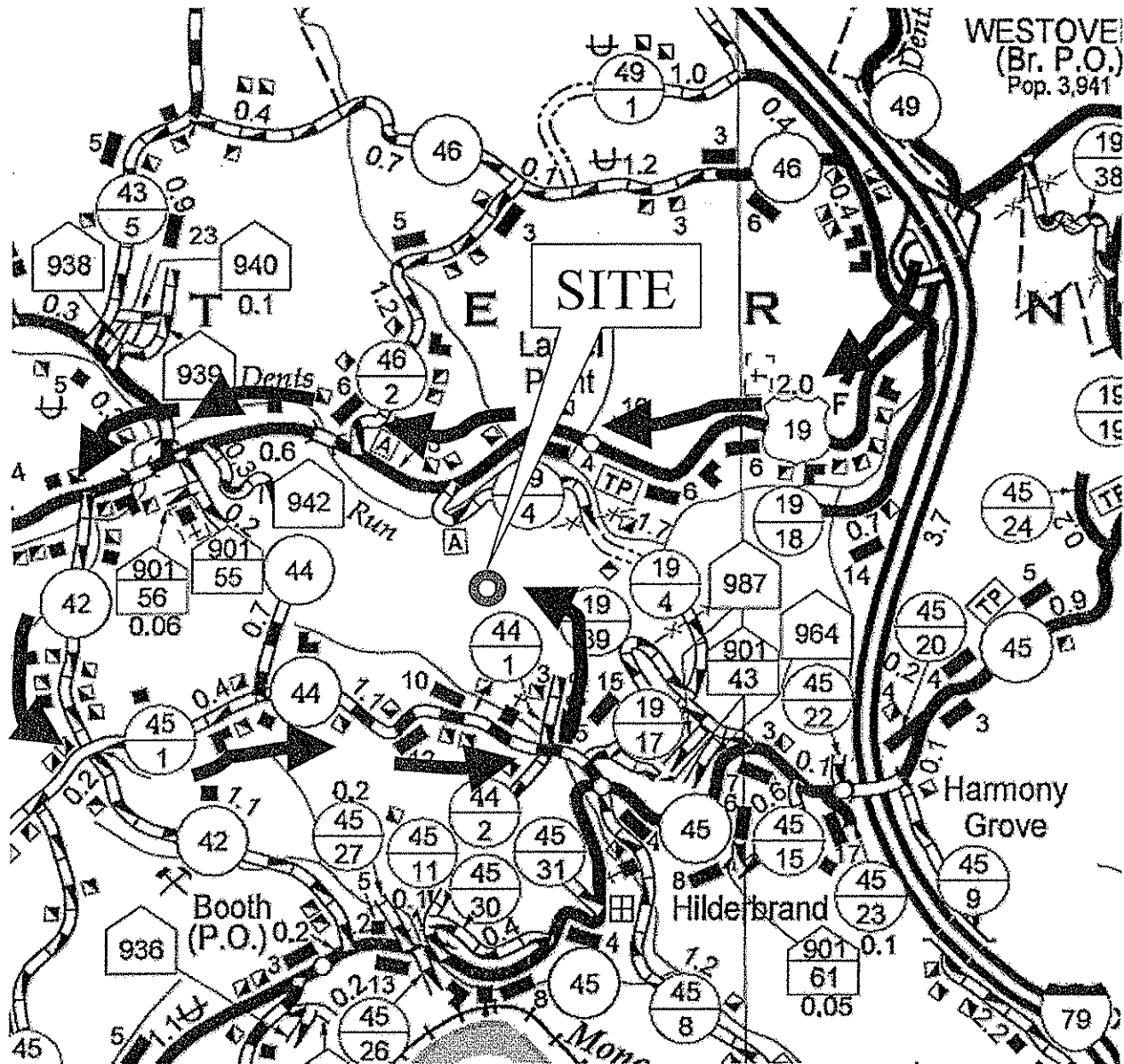

At the Westover I-79 Exit, turn South on US Route 19 and go past the Morgantown Mall entrance road. Travel 3.2 miles South then turn left onto County Route 42 (Glory Barn Rd.) and travel 0.8 miles. Turn left onto County Route 45/1 and travel 1.5 miles. Turn left onto County Route 44/1 and travel 500 feet to the site.

EXISTING SITE CONDITIONS

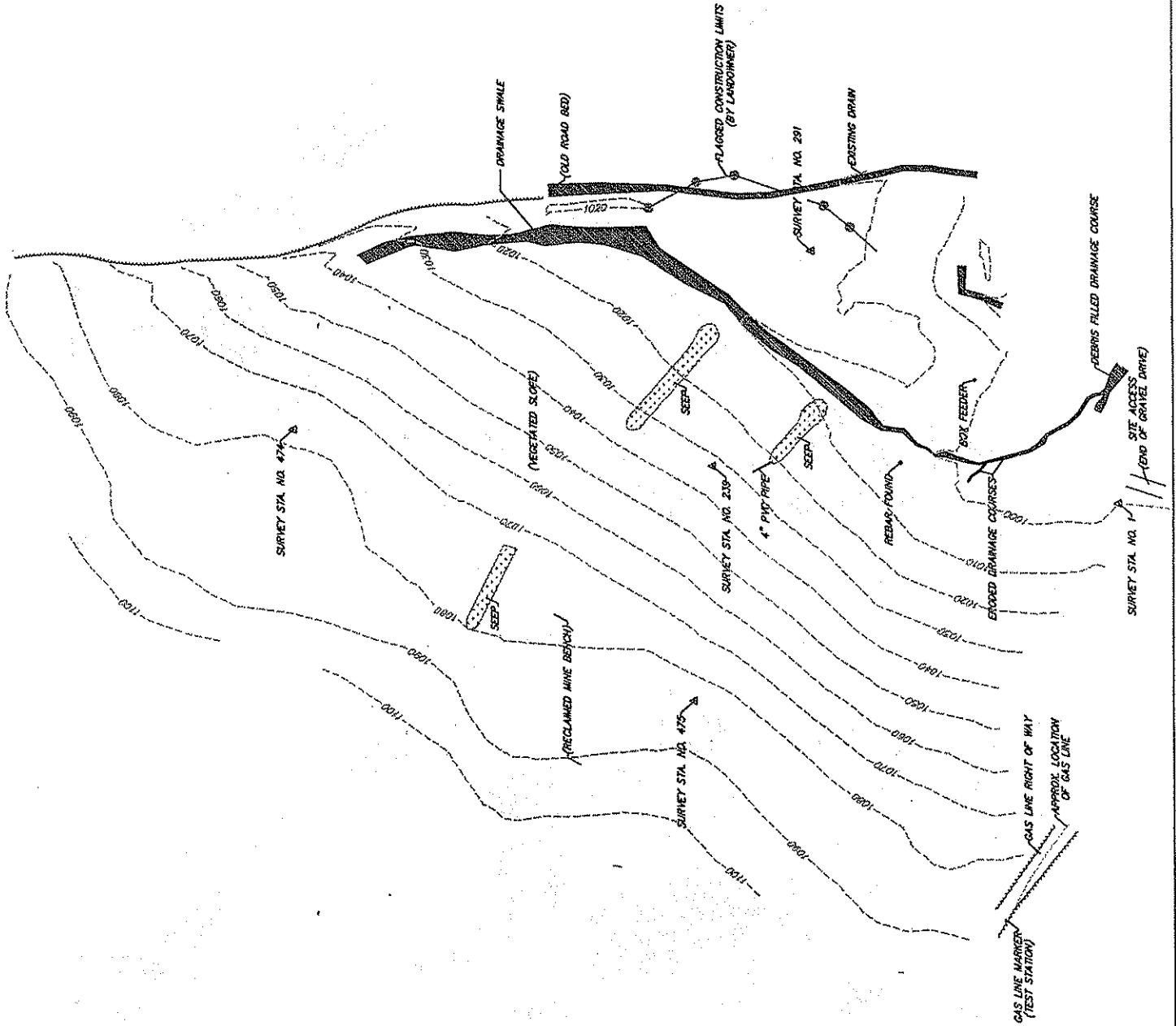

CAP

DESIGN - PLAN VIEW

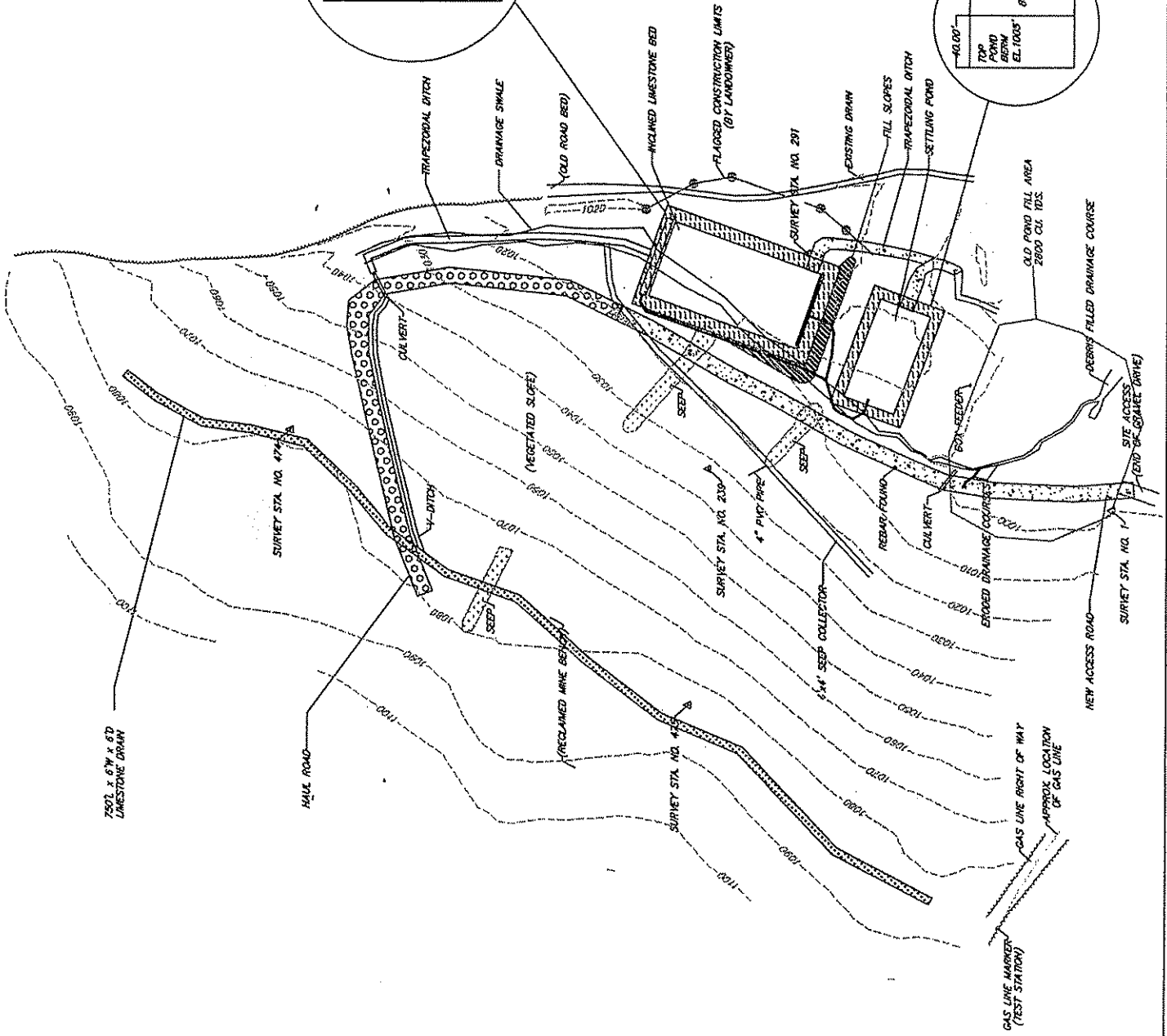
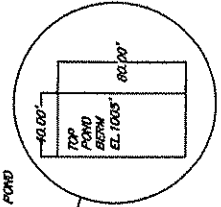
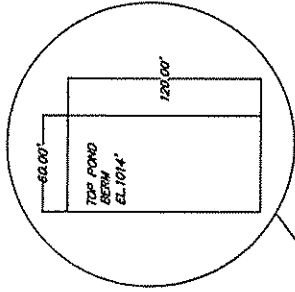

SEDIMENT CONTROL DETAIL

NOT TO SCALE

ANGLE FIRST STAKE TOWARD
PREVIOUSLY LAID BALES

BOUND BALES PLACED ON CONTOUR

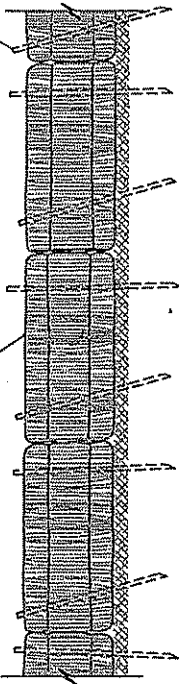

2' x 2' STAKES MINIMUM OF 1' INTO GROUND

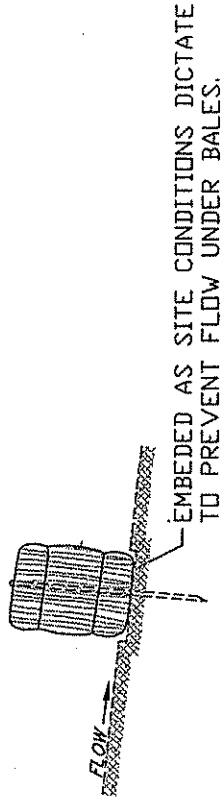

EMBEDDED AS SITE CONDITIONS DICTATE
TO PREVENT FLOW UNDER BALES.

ANCHORING DETAIL

END VIEW

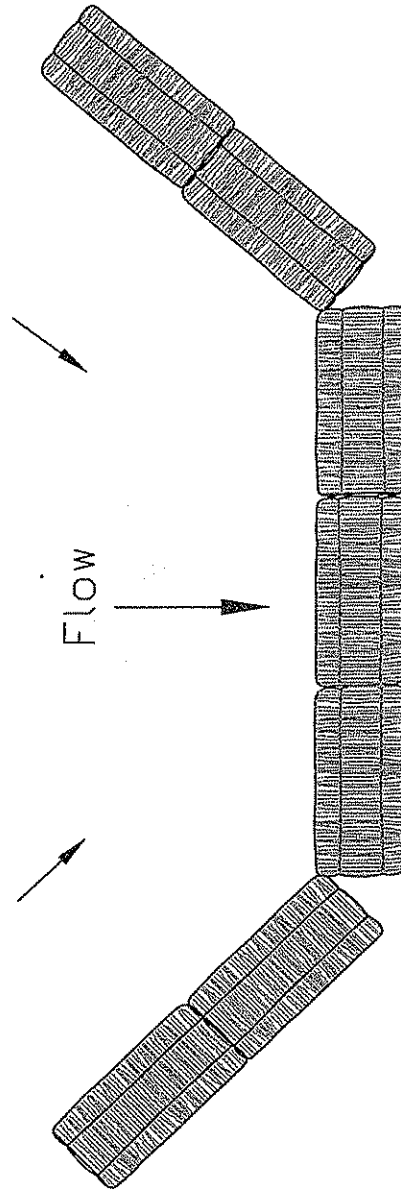

DESIGN TO FIT SITE CONDITIONS

SEDIMENT BARRIER
TOP VIEW

SPILL CONTAINMENT

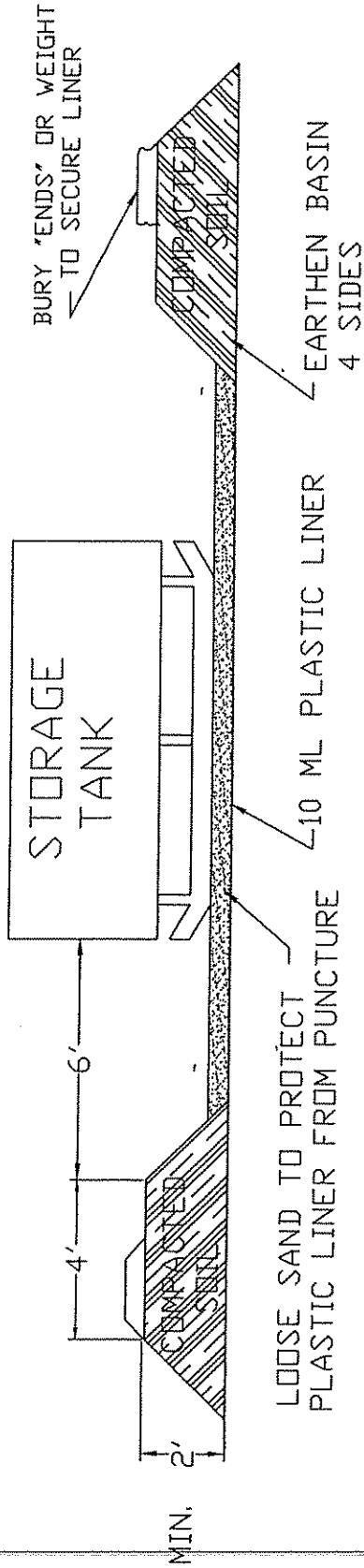

SELECTED HEIGHT OF EARTHEN BERM IS TO BE A TWO (2') FOOT MINIMUM OR ONE HUNDRED TEN PERCENT (110%) OF THE CAPACITY OF THE TANK(S) TOTAL VOLUME WITHIN THE BERM. A SIX (6") INCH FREEBOARD MUST BE INCLUDED.

NOTE: A TWO INCH (2") WATER REMOVAL DRAIN SHALL BE LOCATED AT THE LOWEST POINT IN THE BOTTOM OF THE CONTAINMENT VOLUME. IT SHALL CONNECT TO A NORMALLY CLOSED VALVE OUTSIDE THE DIKE. THE VALVE SHALL BE MANUALLY OPERATED AND PROTECTED FROM UNAUTHORIZED OPERATION. RAINWATER CONTAINED WITHIN THIS DIKE SHALL BE EXAMINED PRIOR TO RELEASE TO ENSURE THAT HARMFUL QUANTITIES OF FUELS AND LUBRICANTS ARE NOT DISCHARGED. ALTERNATE METHODS OF WATER REMOVAL WILL BE CONSIDERED FOR APPROVAL.

TANKS WITH SECONDARY CONTAINMENT MAY BE USED AS AN ALTERNATIVE.

NEW ACCESS ROAD

NEW ACCESS ROAD

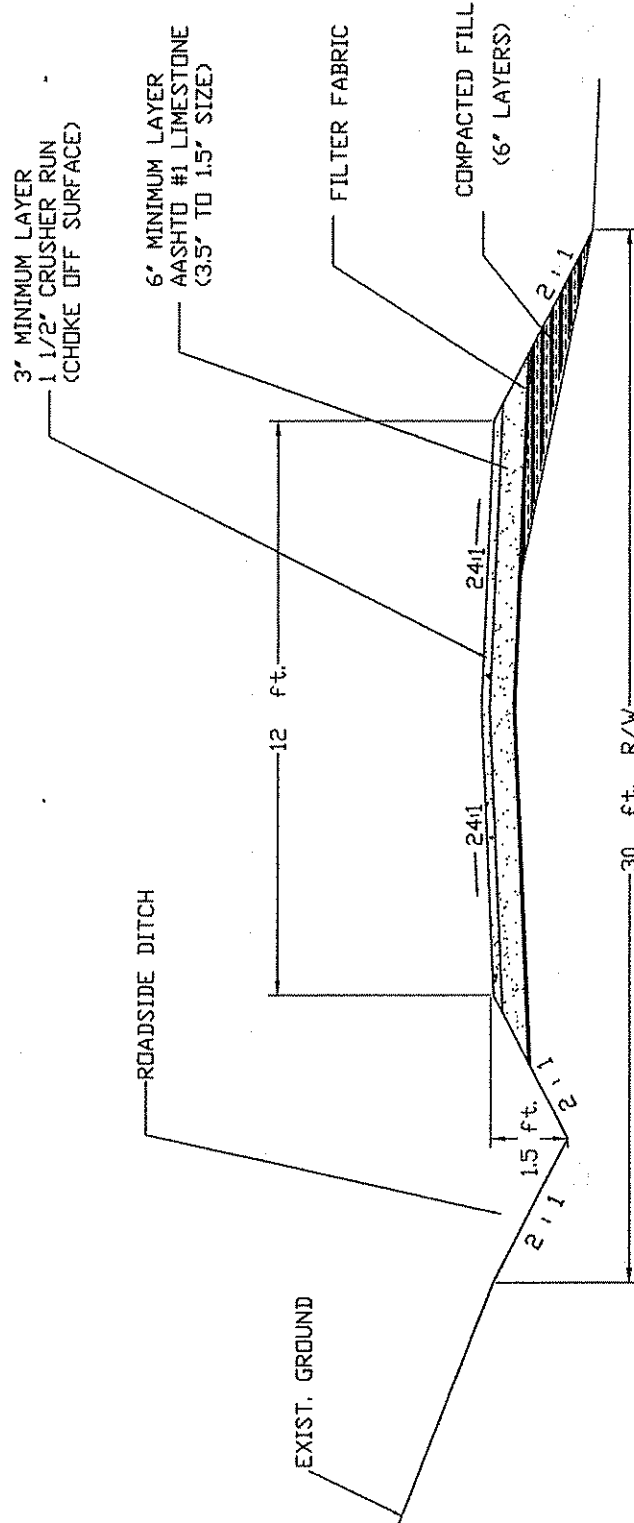

TYPICAL SECTION

NEW HAUL ROAD

BUYER CB-23	PAGE 040	REQ. or P.D. No. DEP 13569
NEW HAUL ROAD		

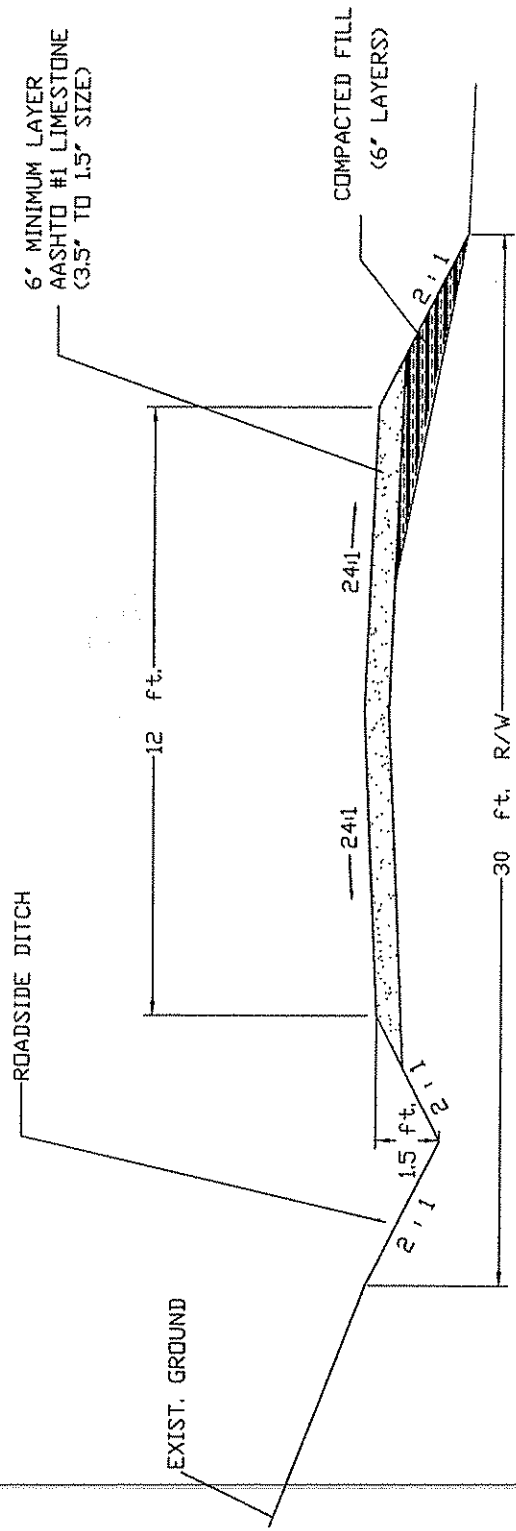

TYPICAL SECTION

SEEP COLLECTOR

SEEP COLLECTOR

WRAP WITH FILTER FABRIC (NONWOVEN)
TYPAR 3401 or EQUIVALENT

3" TO 6" STONE
NON-CALCAREOUS
(R-3 SIZE)

WRAP BOTTOM AND SIDE
WITH 30 MIL. PVC LINER

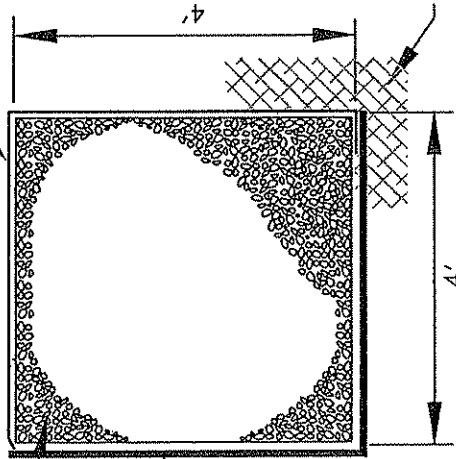

TO BE INSTALLED ON COMPETENT
MATERIAL AS APPROVED BY THE
ON-SITE DEP INSPECTOR.

END VIEW

NOT TO SCALE

INCLINED LIMESTONE BED

INCLINED LIMESTONE BED
 PLAN VIEW

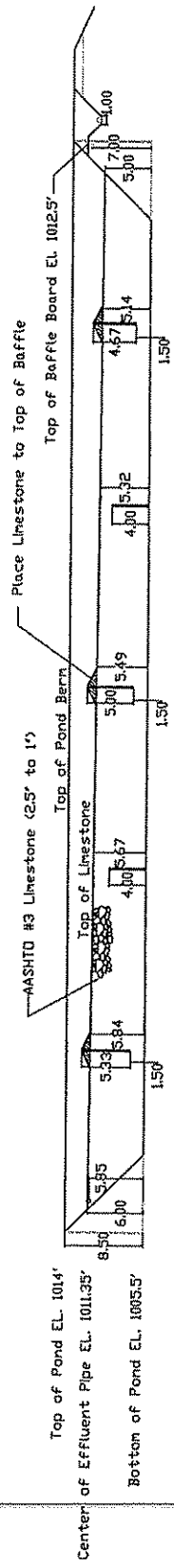
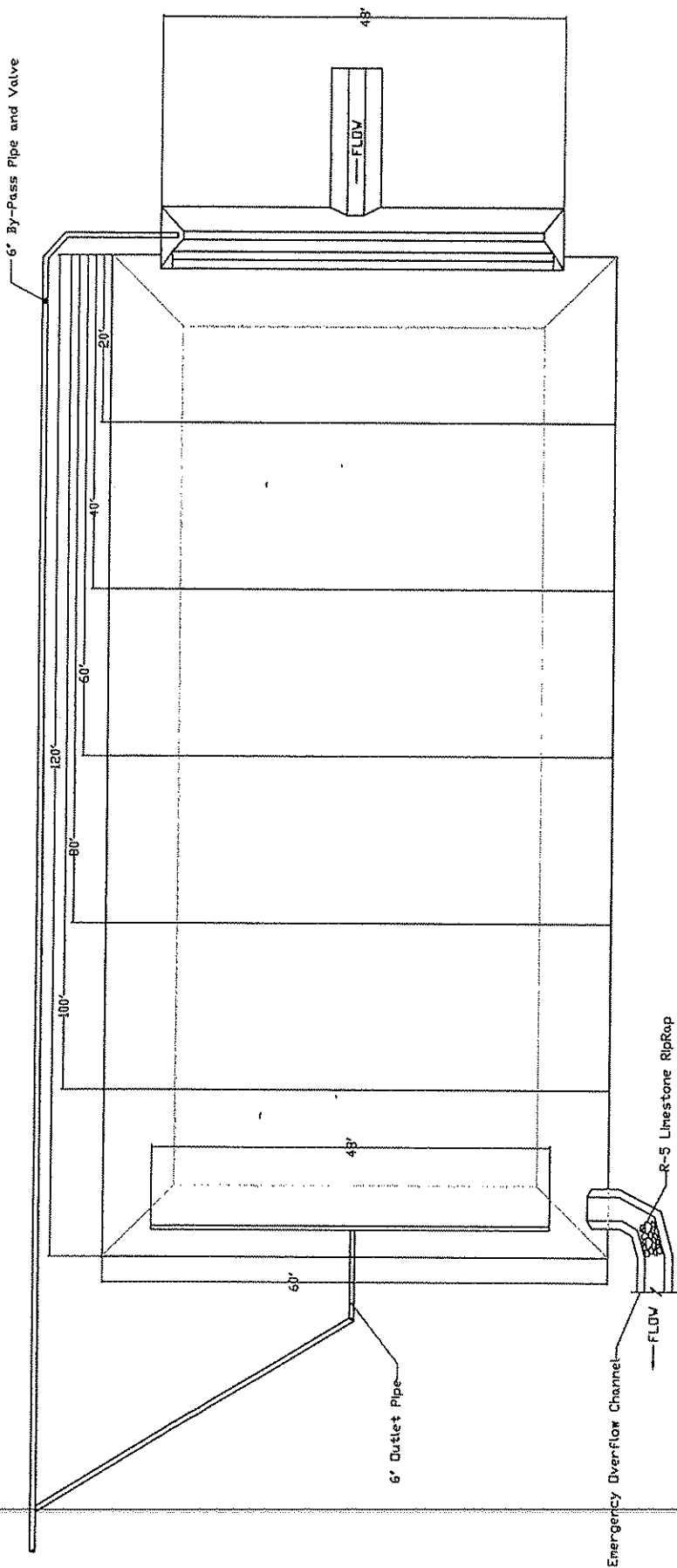

Outlet	Baffle 5	Baffle 4	Baffle 3	Baffle 2	Baffle 1	Inlet	Baffle Board
Measurement from Bottom of Pond Up	5.83'	5.67'	5.50'	5.32'	5.17'	5.00'	7.00'
From Bottom to Top of Rock	5.84'	5.67'	5.49'	5.32'	5.14'	5.00'	7.00'
From Pond Bottom to Bottom of Baffle	1.50'	4.00'	1.50'	4.00'	1.50'	5.00'	7.00'
Height of Baffle	5.33'	4.00'	5.00'	4.00'	4.67'	5.00'	7.00'

NOT TO
 SCALE

SIDE VIEW

LIMESTONE BED INLET AND
HEADER PIPE DETAILS

LIMESTONE BED INLET DETAILS

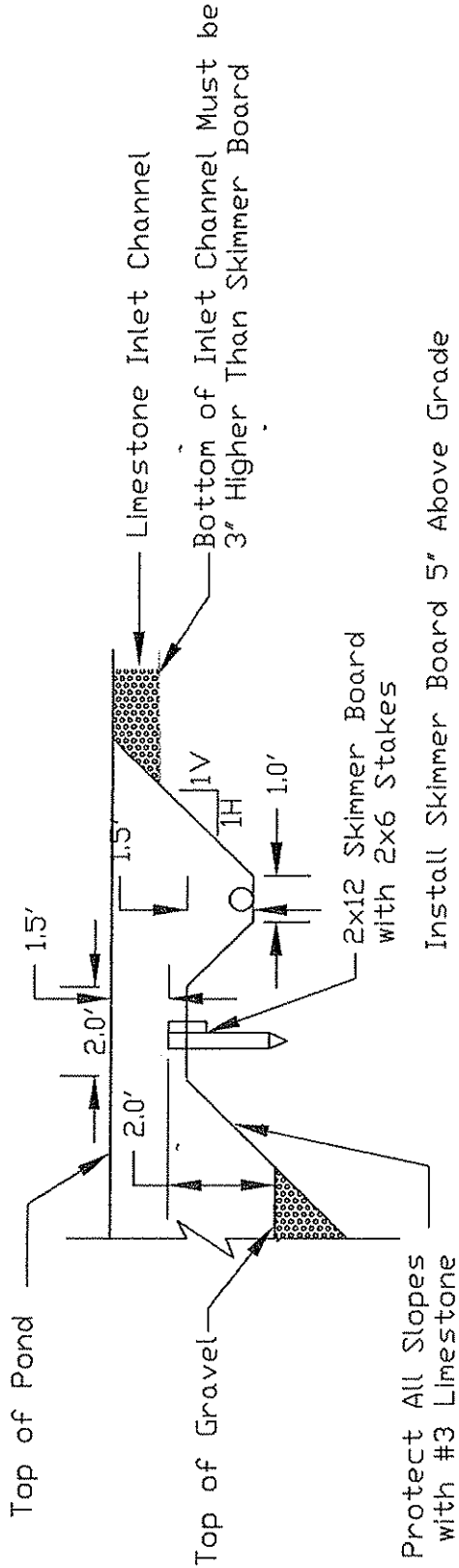

HEADER OUTLET PIPE DETAILS

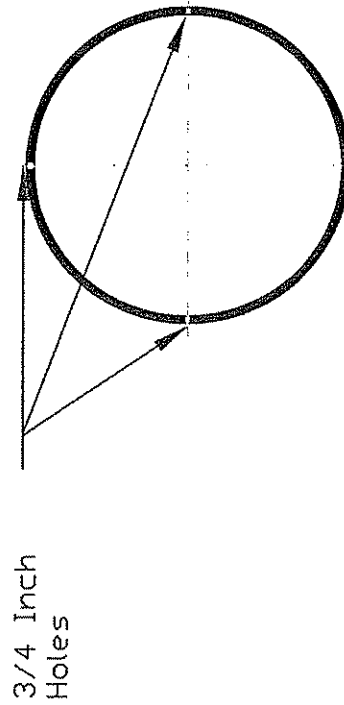

6 INCH DIAMETER PIPE PERFORATIONS

Use 3/4 Inch Diameter Holes for 6 Inch Pipe, on Top and Sides.
Hole Spacing Shall Be 1 Foot on Center Along the Length of Pipe.
Pipe Ends Shall Have Threaded Caps for Cleanouts.

Not To Scale

BAFFLE AND SKIMMER BOARD DETAILS

BAFFLE DETAILS

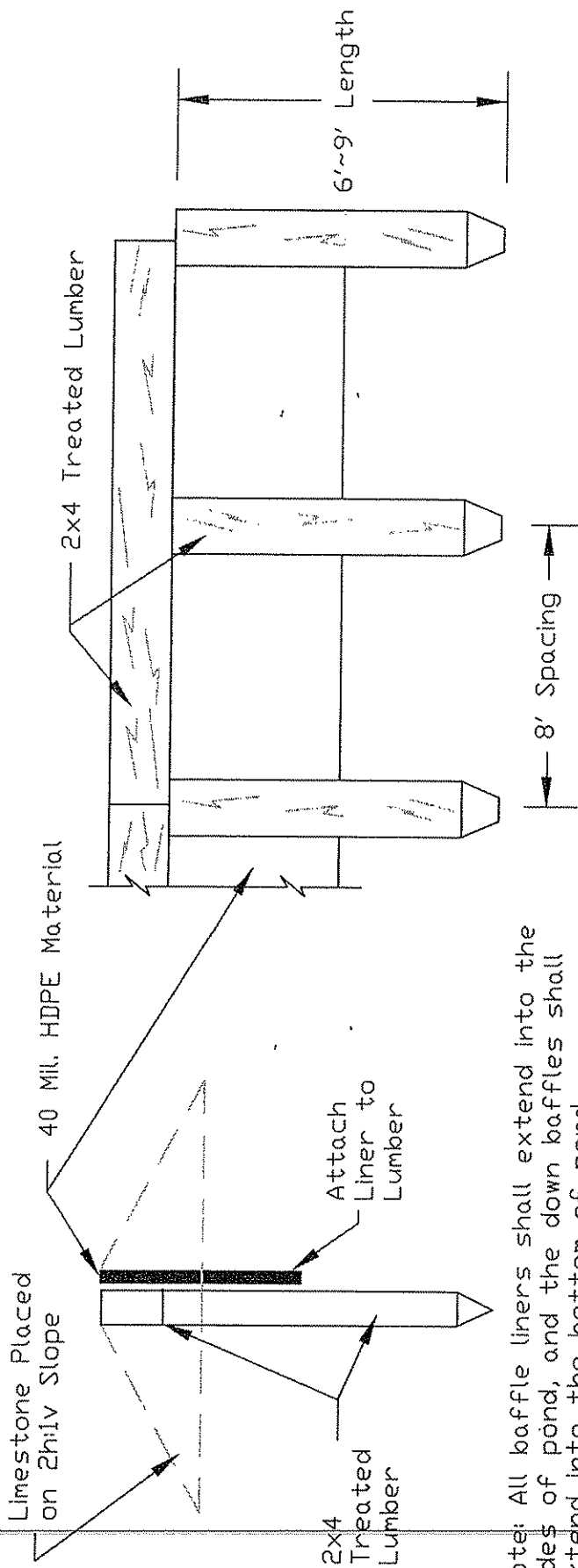

Note: All baffle liners shall extend into the sides of pond, and the down baffles shall extend into the bottom of pond.

SKIMMER BOARD DETAILS

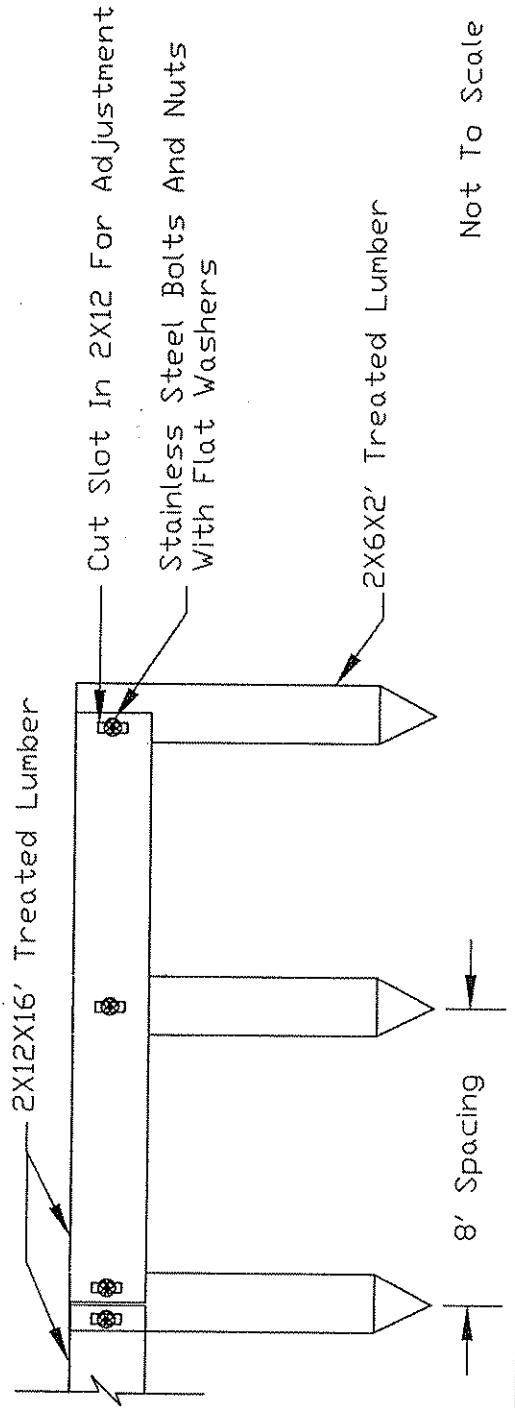

Not To Scale

SETTLING POND

SETTLING POND

PLAN VIEW

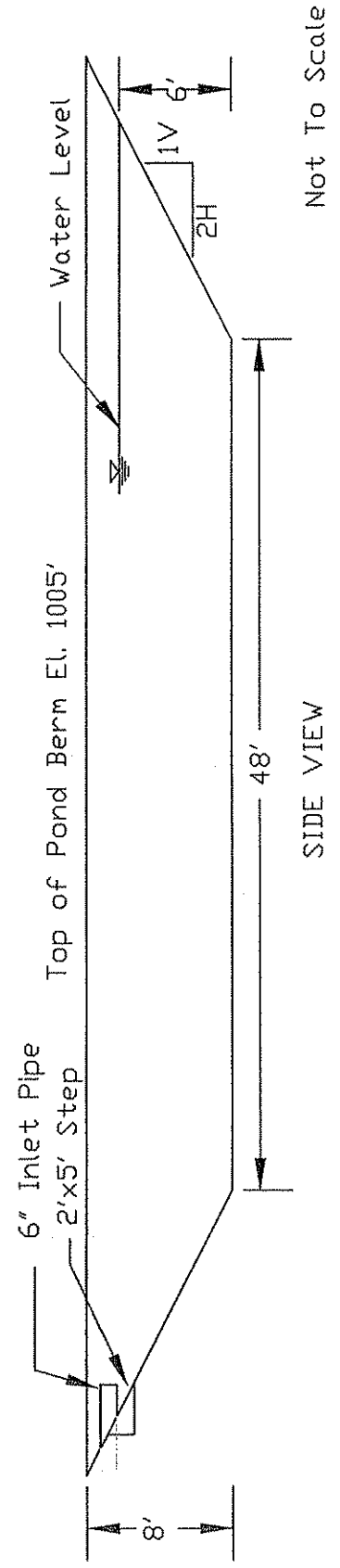
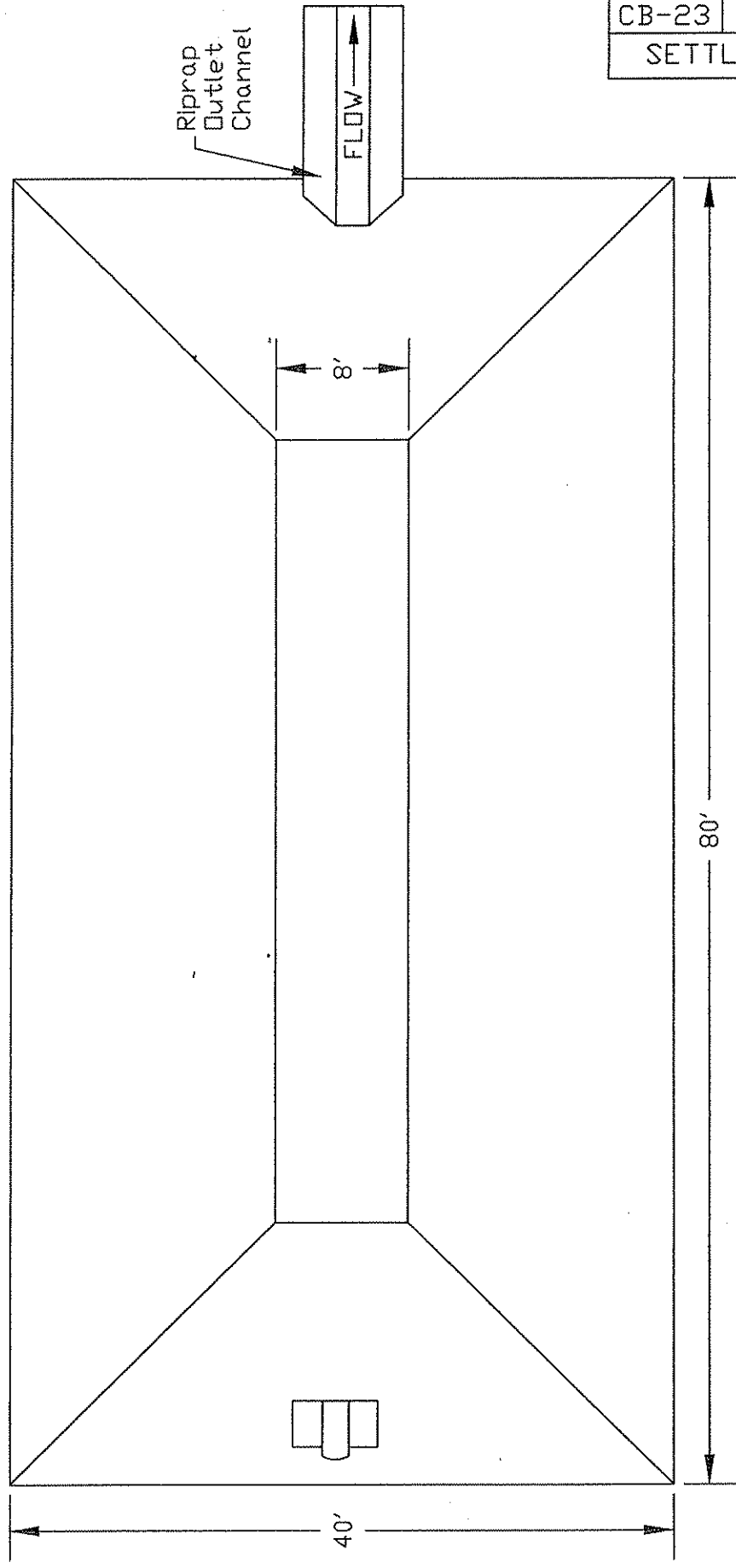

Not To Scale

SIDE VIEW

TRAPEZOIDAL - DITCH

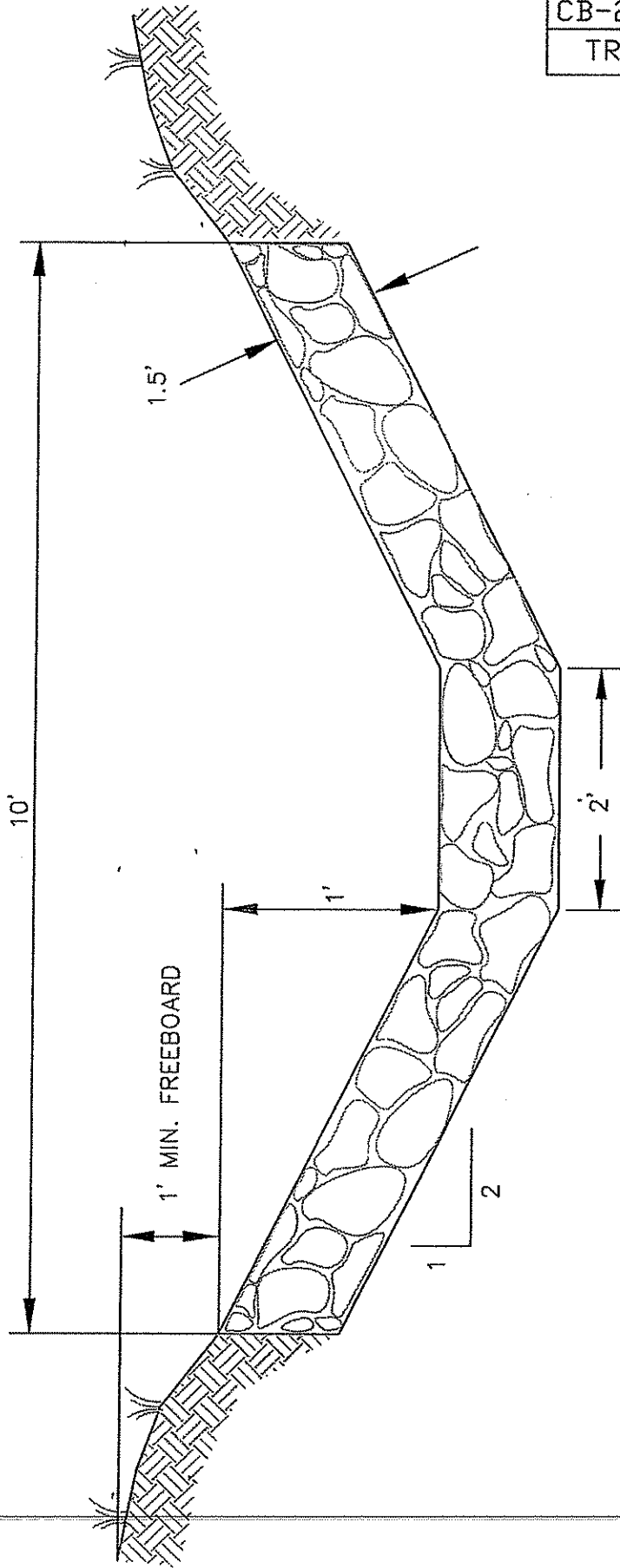

NOT TO SCALE

PAYMENT SHALL BE FOR ACTUAL LENGTH OF DITCH CONSTRUCTED.

R-5 RIPRAP (STANDARD) UNLESS OTHERWISE NOTED, RIPRAP SHALL BE DURABLE ROCK PLACED IN A 1.5 FOOT BLANKET. TWENTY-FIVE (25%) OF THE ROCK WILL BE OF 18 INCHES OR LARGER, THE REMAINING SEVENTY-FIVE (75%) SHALL BE WELL GRADED MATERIAL (MINIMUM 3 INCHES TO MAXIMUM 15 INCHES) OF SUFFICIENT ROCK SMALL ENOUGH TO FILL THE VOIDS BETWEEN THE LARGER ROCK. SHALE SHALL NOT BE USED FOR RIPRAP. IF RIPRAP STABILITY IS QUESTIONABLE, DURABILITY SHALL BE DETERMINED BY THE SODIUM SULPHATE TEST ASTM C 88/AASHTO T 104-77.

TRAPEZOIDAL - DITCH

V - DITCH

V - DITCH

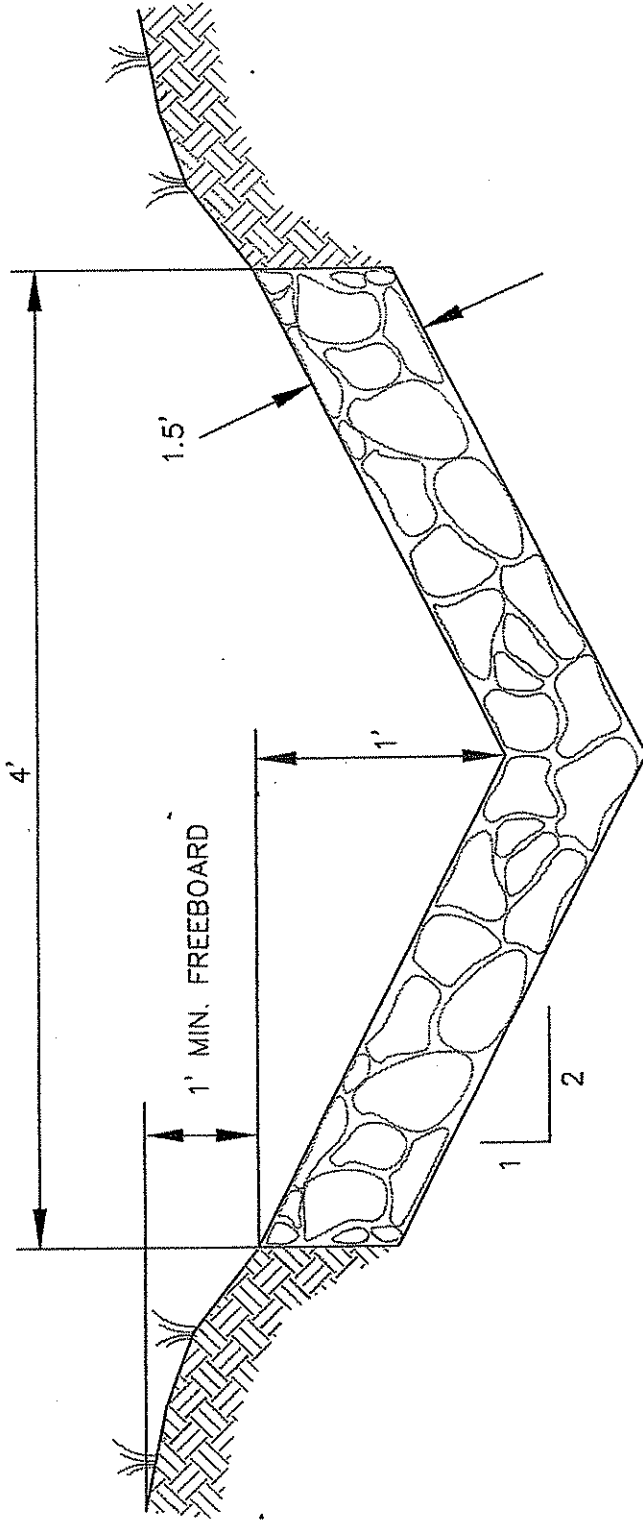

NOT TO SCALE

PAYMENT SHALL BE FOR ACTUAL LENGTH OF DITCH CONSTRUCTED.

R-5 RIPRAP (STANDARD) UNLESS OTHERWISE NOTED, RIPRAP SHALL BE DURABLE ROCK PLACED IN A 1.5 FOOT BLANKET. TWENTY-FIVE (25%) OF THE ROCK WILL BE OF 18 INCHES OR LARGER, THE REMAINING SEVENTY-FIVE (75%) SHALL BE WELL GRADED MATERIAL (MINIMUM 3 INCHES TO MAXIMUM 15 INCHES) OF SUFFICIENT ROCK SMALL ENOUGH TO FILL THE VOIDS BETWEEN THE LARGER ROCK. SHALE SHALL NOT BE USED FOR RIPRAP. IF RIPRAP STABILITY IS QUESTIONABLE, DURABILITY SHALL BE DETERMINED BY THE SODIUM SULPHATE TEST ASTM C 88/AASHTO T 104-77.

BID BOND

148

KNOW ALL MEN BY THESE PRESENTS, That we, the undersigned, _____
of _____, _____, as Principal, and _____
of _____, _____, a corporation organized and existing under the laws of the State of _____
with its principal office in the City of _____, as Surety, are held and firmly bound unto the State
of West Virginia, as Obligee, in the penal sum of _____ (\$ _____) for the payment of which,
well and truly to be made, we jointly and severally bind ourselves, our heirs, administrators, executors, successors and assigns.

The Condition of the above obligation is such that whereas the Principal has submitted to the Purchasing Section of the
Department of Administration a certain bid or proposal, attached hereto and made a part hereof, to enter into a contract in writing for

NOW THEREFORE,

(a) If said bid shall be rejected, or

(b) If said bid shall be accepted and the Principal shall enter into a contract in accordance with the bid or proposal attached
hereto and shall furnish any other bonds and insurance required by the bid or proposal, and shall in all other respects perform the
agreement created by the acceptance of said bid, then this obligation shall be null and void, otherwise this obligation shall remain in full
force and effect. It is expressly understood and agreed that the liability of the Surety for any and all claims hereunder shall, in no event,
exceed the penal amount of this obligation as herein stated.

The Surety, for the value received, hereby stipulates and agrees that the obligations of said Surety and its bond shall be in no
way impaired or affected by any extension of the time within which the Obligee may accept such bid, and said Surety does hereby
waive notice of any such extension.

IN WITNESS WHEREOF, Principal and Surety have hereunto set their hands and seals, and such of them as are corporations
have caused their corporate seals to be affixed hereto and these presents to be signed by their proper officers, this
_____ day of _____, 20____.

Principal Corporate Seal

(Name of Principal)

By _____
(Must be President or
Vice President)

(Title)

Surety Corporate Seal

(Name of Surety)

Attorney-in-Fact

IMPORTANT - Surety executing bonds must be licensed in West Virginia to transact surety insurance. Corporate seals must be affixed.
Power of attorney must be attached.

BID BOND PREPARATION INSTRUCTIONS

AGENCY _____ (A)
 RFQ/RFP# _____ (B)

149

Bid Bond

- (A) WV State Agency
(Stated on Page 1 "Spending Unit")
Request for Quotation Number (upper right corner of page #1)
 - (C) Your Company Name
 - (D) City, Location of your Company
 - (E) State, Location of your Company
 - (F) Surety Corporate Name
 - (G) City, Location of Surety
 - (H) State, Location of Surety
 - (I) State of Surety Incorporation
 - (J) City of Surety Incorporation
 - (K) Minimum amount of acceptable bid bond is 5% of total bid. You may state "5% of bid" or a specific amount on this line in words.
 - (L) Amount of bond in figures
 - (M) Brief Description of scope of work
 - (N) Day of the month
 - (O) Month
 - (P) Year
 - (Q) Name of Corporation
 - (R) Raised Corporate Seal of Principal
 - (S) Signature of President or Vice President
 - (T) Title of person signing
 - (U) Raised Corporate Seal of Surety
 - (V) Corporate Name of Surety
 - (X) Signature of Attorney in Fact of the Surety
- NOTE: Dated, Power of Attorney with Raised Surety Seal must accompany this bid bond.

KNOW ALL MEN BY THESE PRESENTS, That we, the undersigned, _____ (C) of _____ (D), _____ (E) as Principal, and _____ (F) of _____ (G), _____ (H), a corporation organized and existing under the laws of the State of _____ (I) with its principal office in the City of _____ (J), as Surety, are held and firmly bound unto The State of West Virginia, as Obligee, in the penal sum of _____ (K) (\$ _____ (L)) for the payment of which, well and truly to be made, we jointly and severally bind ourselves, our heirs, administrators, executors, successors and assigns.

The Condition of the above obligation is such that whereas the Principal has submitted to the Purchasing Section of the Department of Administration a certain bid or proposal, attached hereto and made a part hereof to enter into a contract in writing for _____ (M)

NOW THEREFORE.

- (a) If said bid shall be rejected, or
- (b) If said bid shall be accepted and the Principal shall enter into a contract in accordance with the bid or proposal attached hereto and shall furnish any other bonds and insurance required by the bid or proposal, and shall in all other respects perform the agreement created by the acceptance of said bid then this obligation shall be null and void, otherwise this obligation shall remain in full force and effect. It is expressly understood and agreed that the liability of the Surety for any and all claims hereunder shall, in no event, exceed the penal amount of this obligation as herein stated

The Surety for value received, hereby stipulates and agrees that the obligations of said Surety and its bond shall be in no way impaired or affected by any extension of time within which the Obligee may accept such bid: and said Surety does hereby waive notice of any such extension.

IN WITNESS WHEREOF, Principal and Surety have hereunto set their hands and seals, and such of them as are corporations have caused their corporate seals to be affixed hereto and these presents to be signed by their proper officers, this _____ (N) day of _____ (O), 20 _____ (P).

Principal Corporate Seal

(R)

 (Name of Principal)
 By _____
 (Must be President or Vice President)

 Title

Surety Corporate Seal

(U)

 (Name of Surety)

(X)

Attorney-in-Fact

IMPORTANT - Surety executing bonds must be licensed in West Virginia to transact surety insurance. Corporate seals must be affixed, a power of attorney must be attached.

BID BOND

KNOW ALL MEN BY THESE PRESENTS, That we, the undersigned, Midway Reclamation, LLC.
_____ of West Milford, WV, as Principal, and United States Surety
Compan of Timonium, MD, a corporation organized and existing under the laws of the State of _____
MD with its principal office in the City of Timonium, as Surety, are held and firmly bound unto the State
of West Virginia, as Obligee, in the penal sum of Five Percent of Amount Bid (\$ 5%) for the payment of which,
well and truly to be made, we jointly and severally bind ourselves, our heirs, administrators, executors, successors and assigns.

The Condition of the above obligation is such that whereas the Principal has submitted to the Purchasing Section of the
Department of Administration a certain bid or proposal, attached hereto and made a part hereof, to enter into a contract in writing for
RFQ No. DEP13569 - AML Project in Monongalia County, WV - According to Plans and Specifications

NOW THEREFORE,

- (a) If said bid shall be rejected, or
- (b) If said bid shall be accepted and the Principal shall enter into a contract in accordance with the bid or proposal attached
hereto and shall furnish any other bonds and insurance required by the bid or proposal, and shall in all other respects perform the
agreement created by the acceptance of said bid, then this obligation shall be null and void, otherwise this obligation shall remain in full
force and effect. It is expressly understood and agreed that the liability of the Surety for any and all claims hereunder shall, in no event,
exceed the penal amount of this obligation as herein stated.

The Surety, for the value received, hereby stipulates and agrees that the obligations of said Surety and its bond shall be in no
way impaired or affected by any extension of the time within which the Obligee may accept such bid, and said Surety does hereby
waive notice of any such extension.

IN WITNESS WHEREOF, Principal and Surety have hereunto set their hands and seals, and such of them as are corporations
have caused their corporate seals to be affixed hereunto and these presents to be signed by their proper officers, this
5th day of October, 2006.

Principal Corporate Seal

Midway Reclamation, LLC.
(Name of Principal)

By: Nancy L. Somers
(Must be President or
Vice President)

OWNER
(Title)

Surety Corporate Seal

United States Surety Company
(Name of Surety)

By: Gregory T. Gordon
Attorney-in-Fact
Gregory T. Gordon, WV Resident Agent

UNITED STATES SURETY COMPANY

Power of Attorney Number

45847

KNOWN ALL MEN BY THESE PRESENTS: That United States Surety Company (the "Company"), a corporation organized and existing under the laws of the State of Maryland, does hereby constitute and appoint: **Patricia Ann Fincke, Gregory T. Gordon, Larry D. Kerr, Allan L. McVey, Patricia A. Moye, Tammy M. Lloyd**

of the City of Charleston, State of West Virginia, its true and lawful Attorney(s)-in-Fact, each in their separate capacity if more than one is named above, to sign its name as surety to, and to execute, seal and acknowledge any and all bonds, undertakings, contracts and other written instruments in the nature thereof of the Company in its business of providing suretyship; guaranteeing the performance of contracts; and executing or guaranteeing bonds and undertakings required or permitted in any actions or proceedings allowed by law, subject to the following limitations:

No single bond shall obligate the Company in excess of the sum of Three Million Dollars (\$3,000,000).

This Power of Attorney is granted under and by authority of the following Resolutions adopted by the Board of Directors of United States Surety Company on the 29th day of July, 1996.

IN WITNESS WHEREOF, United States Surety Company has caused these presents to be signed by its proper officers, and its corporate seal to be hereunto affixed this 19th day of July, 2005.

Richard E. Klein, President



Carol T. Nevin, Assistant Secretary



STATE OF MARYLAND
BALTIMORE COUNTY

SS:

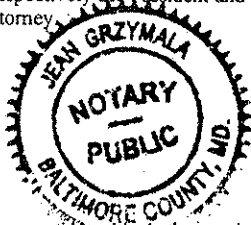
On this 19th day of July, A. D. 2005, before me personally came Richard E. Klein, President of the United States Surety Company, and Carol T. Nevin, Assistant Secretary of said Company, with both of whom I am personally acquainted, who being by me severally duly sworn, said, that they, the said Richard E. Klein and Carol T. Nevin were respectively the President and Assistant Secretary of the United States Surety Company, the corporation described in and which executed the foregoing Power of Attorney.

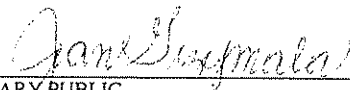

(Signed)

NOTARY PUBLIC
My Commission expires the 1st day in December, 2008.

RESOLVED, that in connection with the surety insurance business of the Company, all bonds, undertakings, contracts and other instruments relating to said business may be signed, executed, and acknowledged by persons or entities appointed as Attorney(s)-in-Fact pursuant to any Power of Attorney issued in accordance with these resolutions ("Powers of Attorney"). All Powers of Attorney for and on behalf of the Company shall be executed in the name and on behalf of the Company, either by the Chair, the President, a Vice President jointly with the Secretary or an Assistant Secretary, under their respective designations. The signature of such officers may be engraved, printed or lithographed. The signatures of such officers and the seal of the Company may be also be affixed by facsimile to any Power of Attorney or to any certificate relating thereto appointing Attorney(s)-in-Fact, for purposes only of executing and attesting bonds and undertakings and other writings obligatory in the nature thereof. Subject to any limitations set forth therein and unless such Power of Attorney is subsequently revoked, any such Power of Attorney or certificate bearing such facsimile signature or facsimile seal shall be valid and binding upon the Company, and any such Power of Attorney so executed and certified by such facsimile signature and facsimile seal shall be valid and binding upon the Company with respect to any bond or undertaking to which it is validly attached.

RESOLVED, that Attorney(s)-in-Fact shall have the power and authority, subject to the terms and limitations of the Power of Attorney issued to them and unless subsequently revoked, to execute and deliver on behalf of the Company and to attach the seal of the Company to any and all bonds and undertakings, and other writings obligatory in the nature thereof, and any such instrument executed by such Attorney(s)-in-Fact shall be as binding upon the Company as if signed by the Company's Chair, the President, a Vice President, and sealed and attested to by the Corporate Secretary or an Assistant Secretary.

I, Carol T. Nevin, Assistant Secretary of United States Surety Company, do hereby certify that the foregoing is a true excerpt from the Resolution of the said Company as adopted by its Board of Directors on the 29th day of July, 1996, and that this Resolution is in full force and effect.

I, the undersigned Assistant Secretary of United States Surety Company, do hereby certify that the foregoing Power of Attorney is in full force and affect and has not been revoked.

In testimony whereof, I have hereunto set my hand and the seal of United States Surety Company on this 5th day of October, 2006.



Carol T. Nevin, Assistant Secretary

CONTRACTOR LICENSE

Authorized by the

West Virginia Contractor Licensing Board

Number: WV040515

Classification:

GENERAL ENGINEERING

MIDWAY RECLAMATION LLC
PO BOX 308
WEST MILFORD, WV 26451

Date Issued

APRIL 13, 2006

Expiration Date

APRIL 13, 2007

Authorized Company Signature

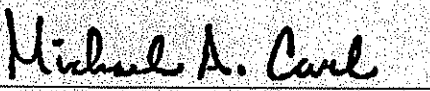
Chair, West Virginia Contractor
Licensing Board

WEST VIRGINIA
CONTRACTOR
LICENSING
BOARD

This license, or a copy thereof, must be posted in a conspicuous place at every construction site where work is being performed. This license number must appear in all advertisements, on all bid submissions and on all fully executed and binding contracts. This license cannot be assigned or transferred by licensee. Issued under provisions of West Virginia Code, Chapter 21, Article 11.



PRODUCER:

BrickStreet Mutual Insurance Company
4700 MacCorkle Ave., S.E.
Charleston, WV 25304

CERTIFICATE HOLDER:

MIDWAY RECLAMATION LLC
POST OFFICE BOX 308
WEST MILFORD, WEST VIRGINIA, 26451

INSURED:

MIDWAY RECLAMATION LLC
POST OFFICE BOX 308
WEST MILFORD, WEST VIRGINIA, 26451

CERTIFICATE OF INSURANCE

The policy of insurance listed below has been issued to the insured named above for the policy period and coverage indicated. This certificate is issued as a matter of information only and confers no rights upon the certificate holder. This certificate does not amend, extend or alter the coverage afforded by the policy below. Coverage is contingent on the insured's compliance with policy conditions and premium payment.

If the policy is canceled before the expiration date, BrickStreet Insurance Company will endeavor to mail a written notice to the certificate holder within 30 days of cancellation. Failure to mail the notice shall impose no obligation or liability of any kind upon BrickStreet Insurance Company.

POLICY NUMBER: WC10200367-01

CERTIFICATE ISSUED: 08/07/2006

POLICY EFFECTIVE DATE: 07/26/2006

POLICY EXPIRATION DATE: 01/01/2007

WORKERS COMPENSATION AND EMPLOYERS LIABILITY

LIMITS / COVERAGE

WORKERS COMPENSATION - STATUTORY LIMITS

EMPLOYERS LIABILITY LIMITS:

BODILY INJURY BY ACCIDENT:	\$ 100,000.00	EACH ACCIDENT
BODILY INJURY BY DISEASE:	\$ 500,000.00	POLICY LIMIT
BODILY INJURY BY DISEASE:	\$ 100,000.00	EACH EMPLOYEE

**WV BROAD FORM EMPLOYERS LIABILITY ENDORSEMENT -
COVERAGE FOR WV CODE 23-4-2(d)(2)(II)**

**FEDERAL COAL MINE HEALTH AND SAFETY ACT COVERAGE ENDORSEMENT -
COVERAGE FOR WV CODE 23-4b-1 - FEDERAL BLACK LUNG COVERAGE**

SPECIAL PROVISIONS IF ANY:

CERTIFICATE OF INSURANCE

The insurance Company indicated below certifies that the Insurance afforded by the policy numbered and described below is in force as the effective date of this certificate. This Certificate of Insurance does not amend, extend or otherwise alter the Terms and Conditions of Insurance coverage contained in any policy or policies numbered and described below.

Certificate Holder's Name and Address:

**STATE OF WEST VIRGINIA
DEPT. OF ADMINISTRATION
STATE CAPITAL COMPLEX
2019 WASHINGTON ST. EAST
CHARLESTON, WV 25305**

Insured's Name and Address:

**MIDWAY RECLAMATION LLC
PO BOX 308
WEST MILFORD, WV 26451**

TYPE OF INSURANCE	POLICY NUMBER AND ISSUING COMPANY	POLICY EFFECTIVE DATE	POLICY EXPIRATION DATE	LIMITS OF LIABILITY (*Limits at Inception)
GENERAL LIABILITY <input checked="" type="checkbox"/> Premises - Operations <input checked="" type="checkbox"/> Products - Completed Operations <input checked="" type="checkbox"/> Personal & Advertising Injury <input checked="" type="checkbox"/> Medical Expense <input checked="" type="checkbox"/> Fire Damage Legal <input type="checkbox"/> Other Liability <input type="checkbox"/> Garage Liability - Premises	9247PR517122-3002 NATIONWIDE MUTUAL INSURANCE COMPANY	08/04/06	08/04/07	General Aggregate* \$ 2,000,000 Pr. Comp. OP. Agg.* \$ 1,000,000 Each Occurrence \$ 1,000,000 Any One Person/Org. \$ 1,000,000 Any One Person \$ 5,000 Any One Fire \$ 100,000 Each Accident Aggregate*
AUTOMOBILE LIABILITY # <input type="checkbox"/> Business Auto <input type="checkbox"/> Garage <input type="checkbox"/> Owned <input type="checkbox"/> Hired <input type="checkbox"/> Non-Owned # Fill-in either Combined Single Limits or Split Limits	NATIONWIDE INSURANCE COMPANY			Bodily Injury (Each Person) \$ (Each Accident) \$ Property Damage (Each Accident) \$ Combined Single Limit \$
<input type="checkbox"/> EXCESS LIABILITY Umbrella Form	NATIONWIDE INSURANCE COMPANY			Each Occurrence \$ Aggregate* \$
<input type="checkbox"/> Workers Compensation and <input type="checkbox"/> Employers' Liability	NATIONWIDE INSURANCE COMPANY			Statutory Limits Bodily Injury by Accident \$ Ea. Accident Bodily Injury by Disease \$ Each Employee Bodily Injury by Disease \$ Policy Limit

Insurance in force only for hazards indicated by X.

Description of Operations/Locations/Vehicles/Restrictions/Special Item

RECLAMATION OF ABANDONED MINE LANDS

Date Certificate Issued: 08/04/06

Authorized Representative:
Countersigned at:

MIKE TOMES
1400 JOHNSON AVE., STE. 1C
BLAKE CENTER
BRIDGEPORT, WV 26330



A F F I D A V I T

050

West Virginia Code §5A-3-10a states:

No contract or renewal of any contract may be awarded by the state or any of its political subdivisions to any vendor or prospective vendor when the vendor or prospective vendor or a related party to the vendor or prospective vendor is a debtor and the debt owned is an amount greater than one thousand dollars in the aggregate.

DEFINITIONS:

"Debt" means any assessment, premium, penalty, fine, tax or other amount of money owed to the state or any of its political subdivisions because of a judgment, fine, permit violation, license assessment, defaulted workers' compensation premium, penalty or other assessment presently delinquent or due and required to be paid to the state or any of its political subdivisions, including any interest or additional penalties accrued thereon.

"Debtor" means any individual, corporation, partnership, association, limited liability company or any other form or business association owing a debt to the state or any of its political subdivisions.

"Political subdivision" means any county commission; municipality; county board of education; any instrumentality established by a county or municipality; any separate corporation or instrumentality established by one or more counties or municipalities, as permitted by law; or any public body charged by law with the performance of a government function or whose jurisdiction is coextensive with one or more counties or municipalities.

"Related party" means a party, whether an individual, corporation, partnership, association, limited liability company or any other form or business association or other entity whatsoever, related to any vendor by blood, marriage, ownership or contract through which the party has a relationship of ownership or other interest with the vendor so that the party will actually or by effect receive or control a portion of the benefit, profit or other consideration from performance of a vendor contract with the party receiving an amount that meets or exceeds five percent of the total contract amount.

EXCEPTION:

The prohibition of this section does not apply where a vendor has contested any tax administered pursuant to chapter eleven of this code, workers' compensation premium, permit fee or environmental fee or assessment and the matter has not become final or where the vendor has entered into a payment plan or agreement and the vendor is not in default of any of the provisions of such plan or agreement.

LICENSING:

The vendor must be licensed in accordance with any and all state requirements to do business with the state of West Virginia.

CONFIDENTIALITY:

The vendor agrees that he or she will not disclose to anyone, directly or indirectly, any such personally identifiable information or other confidential information gained from the agency, unless the individual who is the subject of the information consents to the disclosure in writing or the disclosure is made pursuant to the agency's policies, procedures and rules. Vendors should visit www.state.wv.us/admin/purchase/privacy for the Notice of Agency Confidentiality Policies.

Under penalty of law for false swearing (West Virginia Code, §61-5-3), it is hereby certified that the vendor acknowledges the information in this said affidavit and are in compliance with the requirements as stated.

Vendor's Name: MIDWAY RECLAMATION LLC

Authorized Signature: Nancy S. Somers Date: 10-05-06