

HON

2017 List Pricer

Effective Date January 1, 2017

Supersedes HON List Pricer Dated January 1, 2016

Furniture Types

FC/CG.....	57%
STC.....	54%
SGC.....	57%
SSC.....	57%
FSF.....	57%
FSD.....	57%
SYSACC.....	56%



**CAPITOL
BUSINESS
INTERIORS**



HON FULL LIFETIME WARRANTY

YOUR HON FULL LIFETIME WARRANTY

Every time you purchase a HON product, you're making an investment in your future. We're proud to play a part in that future, and you can trust us to do our best for as long as you need us.

The HON Full Lifetime Warranty is our assurance to you that the HON desks, workstations, seating, tables, or storage you purchase will be free from defective material or workmanship for the life of the product.

In the unlikely event that any HON product or component covered by the HON Full Lifetime Warranty should fail under normal workplace use as a result of defective material or workmanship, HON promises to repair it. If we are unable to repair it, we will replace it with comparable product, or if preferred, we will refund the purchase price.

WHAT'S COVERED BY THE HON FULL LIFETIME WARRANTY?

Your HON Full Lifetime Warranty applies to product manufactured after January 1, 2011. All HON product lines, materials, and components are covered by the HON Full Lifetime Warranty except for the items described below.

The specific product lines, materials, and components listed below are covered under HON's Full 12-Year, Full 10-Year, and Full 5-Year Warranties (from date of purchase).

HON'S FULL 12-YEAR WARRANTY

- Electrical components (LED task lights, lamps and ballasts are not covered)
- Seating *ilira*®-stretch
- Seating controls
- Pneumatic Cylinders
- Wood Seating
- Accessories
- Laminate Surfaces
- Veneer Surfaces

HON'S FULL 10-YEAR WARRANTY

- Soothe™ Patient Recliner Mechanism

HON'S FULL 5-YEAR WARRANTY

- All LED task lights
- Panel and seating textiles
- Electric Height Adjustable Bases (Including Memory Control)
- Directional™ Desktop Sit-to-Stand
- Soothe™ Patient Recliner Central Lock Mechanism
- Soothe™ Patient Recliner Pivoting Arm

These warranties apply to HON products sold within the United States of America, U.S. Territories, and Canada, as well as U.S. Military and Federal Agency purchases (regardless of location).

IS ANYTHING NOT COVERED?

There are a few exclusions to the HON Full Lifetime Warranty and to the 12-, 10-, and 5-year warranties. These exclusions are:

- All *basyx* by HON® products (these products are covered under a separate *basyx* by HON® warranty).
- Color-fastness or matching of colors, woodgrains, or textures occurring in wood, leather, or other materials that naturally exhibit inherent color variations.
- Customer's own materials (COM) selected by and used at the request of the user.
- Modifications or attachments to the product that are not approved by The HON Company and product failures resulting from such modifications or attachments.
- Product normal wear and tear, which are to be expected over the course of ownership.
- Products that were not installed, used, or maintained in accordance with product instructions and warnings.
- Products used for rental purposes.
- Damage caused by cleaning chemicals.
- Dye transfer caused by external contaminants (including clothing and accessory dyes such as those used on denim jeans) may migrate to lighter colors. This phenomenon is increased by humidity and temperature and is irreversible.

WARRANTY REQUESTS OR QUESTIONS?

Your HON dealer is our mutual partner in supporting your warranty requests. To obtain service under this warranty, please contact your HON dealer. If you are not sure who your dealer is, please call HON Customer Support at 800.833.3964.

THAT'S YOUR HON FULL LIFETIME WARRANTY AS AN OWNER OF HON PRODUCT, THE WARRANTY EXPLAINED HERE IS YOUR SOLE AND EXCLUSIVE REMEDY. THERE ARE SOME EXCEPTIONS IF YOU PURCHASED THE PRODUCT FOR HOME OR PERSONAL USE WHICH ARE EXPLAINED BELOW. TO THE EXTENT ALLOWED BY LAW, THE HON COMPANY MAKES NO OTHER WARRANTY, EITHER EXPRESS OR IMPLIED, INCLUDING ANY WARRANTY OF MERCHANTABILITY OR FITNESS FOR A PARTICULAR PURPOSE. THE HON COMPANY WILL NOT BE LIABLE FOR ANY CONSEQUENTIAL OR INCIDENTAL DAMAGES.

A WORD ABOUT PURCHASES FOR HOME OR PERSONAL USE

Please note, this section only applies if you purchased your HON product for your home or for your own personal or family use. HON's warranties give you specific legal rights and you may have other rights, which vary from state to state. As a consumer purchaser, the complete exclusion of implied warranties noted in the above paragraph does not apply to you, however, to the extent allowed by applicable state law, the implied warranties are limited to the applicable term of the warranty. Some states do not allow the exclusion or limitation of incidental or consequential damages, so the above exclusion or limitation may not apply to you.

LIMITED 5-YEAR WARRANTY

The HON Company promises to repair or replace any *basyx* by HON® product or component that is found to be defective in material or workmanship within five (5) years from the date of original purchase so long as you, the original purchaser, still own it. This is your sole and exclusive remedy. This warranty is subject to the provisions below. It applies to product manufactured after January 1, 2013.

Limitations:

- Upholstery on chairs is warranted for two years from date of purchase.
- Damage caused by the carrier in-transit is handled under separate terms.

Exclusions:

This warranty does not apply and no other warranty applies to:

- Normal wear and tear, which are to be expected over the course of ownership.
- Modifications or attachments to the product that are not approved by The HON Company.
- Products that were not installed, used or maintained in accordance with product instructions and warnings.
- Products used for rental purposes.

Seating Usage

Normal commercial use for seating is identified as the equivalent of a single shift, forty-(40) hour workweek. To the extent that a seating product is used in a manner exceeding this, the applicable warranty period will be reduced in a pro-rata manner.

A word about color variations, fabrics and finishes:

The HON Company does not warrant the color-fastness or matching of colors, grains or textures of covering materials.

Customer's Own Material (COM)

Not available on *basyx* by HON® product.

TO THE EXTENT ALLOWED BY LAW, THE HON COMPANY MAKES NO OTHER WARRANTY, EITHER EXPRESS OR IMPLIED, INCLUDING ANY WARRANTY OF MERCHANTABILITY OR FITNESS FOR A PARTICULAR PURPOSE. THE HON COMPANY WILL NOT BE LIABLE FOR ANY CONSEQUENTIAL OR INCIDENTAL DAMAGES.

Notice to purchasers for home or personal use:

Federal law does not permit the exclusion of certain implied warranties for consumer products. Therefore, if you are purchasing this product for home or personal use, the exclusion of implied warranties noted in the above paragraph does not apply to you. Some states do not allow the exclusion or limitation of incidental or consequential damages, so the above limitation or exclusion may not apply to you. This warranty gives you specific legal rights, and you may also have other rights which vary from state to state.

This warranty applies only to products sold within the United States of America and the Commonwealth of Canada.

To obtain service under this warranty:

Your *basyx* by HON® Dealer is our mutual partner in supporting your warranty requests. By following the procedures outlined below, you can be assured of the best level of service. Please note: Consent of The HON Company must be obtained before any warranty work is performed. To obtain consent, please take the following steps:

1. Contact the Dealer from whom the product was purchased within 30 days of discovery of the defect. Be prepared to affirm that you are the original purchaser of the product and to provide the serial number(s) from the product in question.
2. Your Dealer will gather all pertinent information regarding the claim, inspect the product and contact a HON Company customer service representative. (Please allow a reasonable amount of time for inspection and review.)
3. If The HON Company affirms that the product in question is eligible under the conditions of the warranty as stated above, the customer service representative or another representative of the Company will determine whether to provide replacement parts, authorize repairs or replace the product.

LIST PRICER — Effective Date: January 1, 2017

- Software support packages furnished to the customer, either by The HON Company or by another source, which support the sale of HON products are superseded by printed pricelists.
- All dimensions shown in this publication are nominal.
- All illustrations and specifications in this publication are based on the latest product information available at the time of print. For the most recent version, please visit the HON Ready Portal.
- Pricing is subject to change without notice.
- All orders are subject to prices in effect at the time of order.
- Ordering information appears at the beginning of a section complete with examples on how to specify. These specifying information pages are referenced at the bottom center of product pages.
- HON Full Lifetime Warranty applies unless otherwise noted.
- HON nationwide customer service: Phone: (800) 833-3964

HON LIST PRICER — TABLE OF CONTENTS

INTRODUCTION

HON Full Lifetime Warranty	IFC
basyx by HON® Limited Warranty	1
Table of Contents	2-3
Ordering Information	4
MyProjects	4
Integrated Design Solutions	5
Tailored Solutions Ordering Information	6-7
Partnership Textile Information	8
Paint Program	9
Legend and Environmental Statement	10
HON Daily, Customer Support Contact Information and GSA Contract Information	11
HON Product Additions	12
HON Product Discontinuities	13-14

DESKS

Veneer Desks	
Centerpiece™ Veneer — Ordering/Design Information	16-18
Centerpiece™ Veneer — Ordering/Specification Information	19
Centerpiece™ Typicals	20-22
Centerpiece™ Desks	23-24
Centerpiece™ Peninsulas	25
Centerpiece™ Conference Runoffs	26
Centerpiece™ Credenzas	27
Centerpiece™ Returns	28
Centerpiece™ Bridges	28
Centerpiece™ Stack-on Storage	29
Centerpiece™ Tackboards	30
Centerpiece™ Wall Mount Storage	31
Centerpiece™ Tackboards	32
Centerpiece™ Storage	33-35
Centerpiece™ Components — Worksurfaces	36
Centerpiece™ Components — Modesty Panels	37
Centerpiece™ Components — Supports	38-39
Centerpiece™ Components — Pedestals	40-41
Centerpiece™ Conference Tables	42-43
Centerpiece™ Buffet Credenza	44
Centerpiece™ Occasional Tables	44
Centerpiece™ Accessories	45
Centerpiece™ Accessories — Task Lights	46

Laminate Desks

Laminate Desks Ordering Information	48-49
Features Offered on HON Laminate Casegoods	50
Concinnity™ Ordering Information	51
Concinnity™ Ordering Specification/Model Logic	52-53
Concinnity™ Laminate Design/Materials Information	54-55
Concinnity™ Laminate Ordering/Specification Information	56-57
Concinnity™ Cord Management	58
Concinnity™ Typicals	59-61
Concinnity™ Desks	62
Concinnity™ Peninsulas	63
Concinnity™ Corner Unit	64
Concinnity™ Credenzas	65
Concinnity™ Low Credenzas	66
Concinnity™ Returns	67
Concinnity™ Bridges	67
Concinnity™ Stack-on Storage Applications	68
Concinnity™ Stack-on Storage	69-72
Concinnity™ Wall Mount Storage Applications	74-75
Concinnity™ Wall Mount Storage	76-78
Concinnity™ Bookcase Hutches	79
Concinnity™ Reception Stations	80
Concinnity™ Mobile Pedestals	81
Concinnity™ Lateral Files	82
Concinnity™ Storage Cabinets	83
Concinnity™ Wardrobes	84
Concinnity™ Storage Towers	85
Concinnity™ Bookcases	86
Concinnity™ Components	89
Concinnity™ Components — Worksurfaces	90-91
Concinnity™ Components — Supports	92
Concinnity™ Components	93
Concinnity™ Components — Modesty/Back Panels	95-96
Concinnity™ Modesty/Back Panels	97
Concinnity™ Components — Supports	98
Concinnity™ Kneespace Clearance End Panels	98
Concinnity™ Components — Supports	99-101
Concinnity™ Components — Privacy Screens	102
Concinnity™ Privacy Screens	103
Concinnity™ Components — Supports	104-107
Concinnity™ Components — Pedestal Tops	108
Concinnity™ Components — Pedestal Back Panels	109
Concinnity™ Accessories	111-112
Concinnity™ Accessories — Cable Management & Electrical	113
Concinnity™ Accessories — Paper Organizers	114
Concinnity™ Paper Organizer Compatibility	115
Concinnity™ Accessories — Lock Kits	116
Concinnity™ Accessories — Task Lights	117
Concinnity™ Accessories — Keyboard Platforms	118

Concinnity™ Accessories — Monitor Arms	118
Concinnity™ Accessories — Desktop Sit-to-Stand	119
101 Series™	122-123
101 Series™ Accessories	124

Park Avenue Collection® Laminate Ordering/Design

Information	127-128
Park Avenue Collection® Laminate Wood Desks — Typicals	129-130
Park Avenue Collection® Laminate Wood Desks	131-132
Park Avenue Collection® Shared Components and Accessories	133-140
Park Avenue Collection® Laminate Desks Modular Components	141-148
Park Avenue Collection® Laminate Conference Tables	149
Valido® — Typicals	150-151
Valido® Laminate Modular Desks	152
Valido® Modular Credenzas	153
Valido® Modular Returns	154
Valido® Laminate Modular Components	155-156
Valido® Laminate Wood Desks — Full Pedestals	157-158
Valido® Laminate Wood Desks — 3/4 Pedestals	159-160
Valido® Shared Components & Accessories	161-174

Voi® Ordering Information

Voi® Laminate Typicals	176-178
Voi® Specifying/Design Guide	179-183
Voi® Laminate Worksurfaces — Rectangle	184-185
Voi® Worksurface Supports	186
Voi® Standing-Height Worksurface Supports	187
Voi® Laminate Support/Power-Ready Support Pedestals	188
Voi® Laminate Support/Power-Ready Support Storage	189
Voi® Standing-Height Laminate Support	190
Voi® Modesty Panels	191
Voi® Privacy Screens	192-193
Voi® Laminate Overhead Storage	194
Voi® Laminate Overhead and Stack-on Storage	195
Voi® Laminate Shared Overhead Storage Components	196
Voi® Overhead Storage Supports/Accessories	197
Voi® Laminate Stack-on Storage — Built-up	198
Voi® Laminate Low Credenzas	199
Voi® Laminate Power-Ready Low Credenzas	200
Voi® Laminate Credenzas	201
Voi® Laminate Mobile Storage	202
Voi® Laminate Storage	203
Voi® Laminate Storage Towers	204-205
Voi® Laminate Bookcases	206
Voi® Accessories	207-208
Voi® Electrical	209
Voi® Hardwire Electrical Components	210
Voi® Software Electrical Components	210
Voi® Electrical Components	211

10500 Series™ — Typicals	212-213
10500 Series™ Laminate Modular Components	214-218
10500 Series™ Worksurfaces	219
10500 Series™ Worksurface Supports	220-222
Coordinate™ Height Adjustable Base	223
10500 Series™ Shared Components	224
10500 Series™ Laminate Modular Components	225-226
10500 Series™ Laminate Wood Desks — Full Pedestals	227-228
10500 Series™ Laminate Wood Desks — 3/4 Pedestals	229
10500 Series™ Shared Components & Accessories	230-234
10500 Series™ Storage	235
10500 Series™ Shared Components & Accessories	236-241
10500 Series™ Laminate Occasional Tables	242
10500 Series™ Storage	243
10500 Series™ Shared Components & Accessories	244-247
10700 Series™ — Typicals	248-249
10700 Series™ Laminate Modular Components	250-255
10700 Series™ Laminate Wood Desks — Full Pedestals	256-257
10700 Series™ Laminate Wood Desks — 3/4 Pedestals	258-259
10700 Series™ Shared Components and Accessories	260-270
94000 Series™ — Typicals	271
94000 Series™ Laminate Wood Desks	272-275
basyx by HON® BL Series	276-278
basyx by HON® Manage® Laminate Desks Typicals	279
basyx by HON® Manage® Laminate Desks Worksurfaces	280
basyx by HON® Manage® Laminate Desks	281-282
Steel Desks Ordering Information	283-284
Mentor® Series Steel Desks	285-286
Metro Classic Series Steel Desks	287
34000 Series Steel Desks	288
38000 Series™ — Typicals	289-290
38000 Series™ Steel Desks — 3/4 Pedestals	291
38000 Series™ Modular Desks	292
38000 Series™ Shared Components and Accessories	293-294
38000 Series™ Steel Stack-on Units	295-296

WORKSTATIONS

Abode™ Ordering Information	297
Abode™	298-299
Abode™ Desks — Typicals	300-302
Abode™ — Typicals	303-304
Abode™ Components	305-307

Abound® Ordering Information	309-311
Abound® Typicals	312-313
Abound® Open Base Typicals	314
Abound® Frames Overview	315-318
Abound® Connector Overview	319
Abound® Tile Overview	320
Abound® Specifying/Design Guide	321-322
Abound® Panel Frames	323
Abound® Open Base Panel Frames	324
Abound® Stacking Panel Frames	325
Abound® Stiffener Supports	326
Abound® Door Panel	327
Abound® Sliding Door	328
Abound® Connectors / Finished Ends / Wall Starter Kits	329-331
Wall Hanger Bars / Off-Module Bracket	332
Abound® Tackable Acoustical Tiles	333-334
Abound® Power/Data Fabric Tiles	335-336
Abound® Hard-surface Tiles	337
Abound® Glass Tiles	338-339
Abound® Frameless Glass	340
Abound® Pass-thru Tiles	341
Abound® Slotted Tool Tiles / Systems Paper Management Support Bar	342
Systems Paper Management Accessories	343
Abound® Markerboard Tiles	344
Abound® Painted Metal Tiles	345
Abound® Plains Tile	346
Abound® Custom Material Bracket Kit	347
Accelerate® Ordering Information	349-351
Accelerate® Typicals	352-354
Accelerate® Panels Overview	355
Accelerate® Working with Panels	356
Accelerate® Connector Overview	357
Accelerate® Tackable Raceway Panels	358
Accelerate® Non-Tackable Raceway Panels	359
Accelerate® Top-Tier Glass Panels	360
Accelerate® Non-Tackable Top-Tier Glass Panels	361
Accelerate® Panel Door	362
Accelerate® Top Caps	363
Accelerate® Stacking Panels	364
Accelerate® Frameless Glass	365
Accelerate® Connectors	366
Accelerate® Variable Height Finished End and Wall Starter Kits	367
Systems Overhead and Shelves Specifying	368-369
Systems Overhead and Shelves	370
Systems ETA Overheads and Shelves	371
Systems Overhead Storage / Laminate Front Overhead Storage	372
Voi® Overhead Storage	373
Voi® Overhead and Stack-on Storage	374
Voi® Shared Overhead Storage Components	375
Overhead Accessories	376-377
Abound® Electrical and Data	378-380
Accelerate® Electrical and Data	381-382
Systems Electrical and Data	383
Systems Electrical Specifying Information	384-386
Working with Cable Management	387
Systems Electrical and Data	388
Systems Electrical Components	389-391
Systems Electrical and Data	392
Systems Working with Worksurfaces and Supports	393-394
Systems Worksurfaces — Primary	395-396
Systems Worksurfaces — Wave	397
Systems Worksurfaces — Wedge	398
Systems Worksurfaces — Corner	399-400
Systems Worksurfaces — Split Top	401
Systems Worksurfaces — 120 Degree Corner	402
Systems Worksurfaces — Corner Cove	403
Systems Worksurfaces — Jetty / Peninsula	404
Systems Worksurfaces — Half Round / Quarter Round / 60° Wedge	405
Systems Countertops — Straight and Corner	406-407
Systems Shelves — Corner Shelves	408
Coordinate™ Height Adjustable Base	409
Coordinate™ Accessories	409
Coordinate™ Worksurfaces	410-411
Coordinate™ Shared Components	412
basyx by HON® Height Adjustable Base	413
HON® Worksurfaces	413
Systems Worksurface Supports	414-415
Worksurface Brackets	416
Systems Worksurface Supports	417
Standing-Height Worksurface Supports	418
Systems Standard Height Support Pedestals	419
Voi® Laminate Support Pedestals	420
Voi® Laminate Support Storage	421
Paper Management / Markerboards	422
Task Lights	423
Electrical Accessories	423
Optional Accessories — Monitor Arm	424
Optional Accessories — Keyboard Platforms	425
Optional Accessories — Desktop Sit-to-Stand	426
Versé® Panel System	427-430

For information regarding HON registered and unregistered trademarks, please go to hon.com/protected-marks. Haworth®, Herman Miller®, Knoll®, and Steelcase® are registered trademarks of their respective owners and use of the marks do not imply affiliation or endorsement of The HON Company or its products.

- ▶ Software support packages furnished to the customer, either by The HON Company or by another source, which support the sale of HON products are superseded by printed pricelists.
- ▶ All dimensions shown in this publication are nominal.
- ▶ All illustrations and specifications in this publication are based on the latest product information available at the time of print. For the most recent version, please visit the HON Ready Portal.
- ▶ Pricing is subject to change without notice.
- ▶ All orders are subject to prices in effect at the time of order.
- ▶ Ordering information appears at the beginning of a section complete with examples on how to specify. These specifying information pages are referenced at the bottom center of product pages.
- ▶ HON Full Lifetime Warranty applies unless otherwise noted.
- ▶ HON nationwide customer service: Phone: (800) 833-3964

















HON LIST PRICER — TABLE OF CONTENTS

STORAGE & FILES			
Overview of Personal Storage and Pedestals	431		
HON Lateral Files at a glance	432		
HON Vertical Files at a glance	433		
Storage and Files Ordering Information	434-435		
Brigade® Standard Height Pedestals	436		
Brigade® 800 Series Lateral Files	437-438		
Brigade® 700 Series Lateral Files	439-440		
Brigade® 600 Series Lateral Files	441-442		
Brigade® 600 Series Shelf Files	443		
Brigade® Metal Overfiles	444		
Brigade® Steel Bookcases	445		
Brigade® Storage Cabinets	446		
Contain® Metal Storage	447		
Contain® Metal Credenzas	448		
Contain® Footed Metal Credenzas	449		
Contain® Metal Credenzas with Laminate Fronts	450		
Contain® Footed Metal Credenzas with Laminate Fronts	451		
Contain® Metal Credenzas Accessories	452-453		
Contain® Metal Personal Towers	454		
Contain® Metal Side Access Towers	455		
Contain® Metal Personal Towers with Laminate Fronts	456		
Contain® Metal Side Access Towers with Laminate Fronts	457		
Contain® Footed Metal Personal Towers	458		
Contain® Footed Metal Side Access Towers	459		
Contain® Footed Metal Personal Towers with Laminate Fronts	460		
Contain® Footed Metal Side Access Towers with Laminate Fronts	461		
Contain® Metal Pedestals	462		
Contain® Footed Metal Pedestals	463		
Contain® Metal Pedestals with Laminate Fronts	464		
Contain® Footed Metal Pedestals with Laminate Fronts	465		
Flagship® Hanging and Standard Height Pedestals	466		
Flagship® Mobile Pedestals	467		
Flagship® 18" Deep Lateral Files with Drawers	468		
Flagship® Lateral File with Storage	469		
Flagship® Bookcases	470		
Flagship® Storage Cabinets	470		
Flagship® File Centers	471-473		
FlameSafe® Fire-Resistant Files	474		
500 Series Lateral Files	475		
210 Series Vertical Files — 28 1/2"D	476		
310 Series Vertical Files — 26 1/2"D	477		
H320 Series Vertical Files — 26 1/2"D	477		
510 Series Vertical Files — 25"D	478		
Pedestal Accessories	479-480		
Lateral File Accessories	481		
Vertical File Accessories	482		
10500 Series™ Laminate Bookcases	483		
1870/1890 Series Laminate Bookcases	484		
basyx by HON® Mobile Pedestals	485		
basyx by HON® Storage Cabinets	485		
basyx by HON® 400 Series Lateral Files	485		
basyx by HON® BL Series	486		
basyx by HON® Manage®	487		
SEATING			
Upholstery Color Combinations for all Seating Models	488-497		
Seating Features	499		
Fire Code/Compliant Seating	501-503		
Wood Seating Ordering Information	504-505		
Cambia™ — 2150 Series	506		
Cambia™ — 2160 Series	507		
Convera™ Lounge	508-509		
Invitation® — 2110 Series	510		
Laurus™ Wood Guest Seating	511		
Park Avenue Collection® — 5000 Series	512		
Pillow-Soft® — 2190 Series	513		
Riley™ Seating Specifying Information	514		
Riley™ Series	515		
Riley™ Series Healthcare	516		
Riley™ Series	517		
Versant® Tandem Wood Seating/Tables	518		
Versant® Tandem Wood Seating	519		
2400 Series	520		
6540 Series	521		
6550 Series	521		
Steel Seating — Ordering Information	522-523		
Accommodate™ Seating	524-526		
Adjustable Task/Lab Stools	527		
Boda™ Seating	528		
Ceres® — Series	529		
ComfortTask® — 5900 Series	530		
Endorse™ Seating Features	531		
Endorse™ Seating Dimensions	532		
Endorse™ Seating	533-536		
Endorse™ Stools	537		
Endorse™ Series Arm Packs	538		
Endorse™ Headrest	538		
Endorse™ Lounge Seating	539		
Endorse™ Tables	540		
Flock® Collaborative Seating	541-543		
Flock® Mini Cube and Cylinder Seating	544		
Flock® Dual Fabric Collaborative Seating	545-546		
Flock® Collaborative Seating	547		
Flock® Dual Fabric Mini Cube and Cylinder Seating	548		
Flock® Collaborative Tables Ordering Information	549		
Flock® Collaborative Solutions Table Specifying Information	550		
Flock® Collaborative Veneer and Laminate Table Tops	551		
Flock® Collaborative Table Bases	552		
Flock® Collaborative Tables	553		
Flock® Collaborative Accessories	554		
Folding Chairs	555		
Gamut® — 2070 Series	556		
Grove™ Seating	557-560		
Grove™ Dual Fabric Seating	561-563		
Grove™ Seating	564		
GuestStacker® — 4030 Series	565		
Ignition® Seating	566-570		
Ignition® Series Arm Packs	571		
Invitation® Lounge	572		
Lota®	573-574		
Motivate® Task Chairs	575		
Motivate® High-Density Sled Base Chairs	576		
Motivate® 4-Leg Chairs	577		
Motivate® Nesting/Stacking Flex-Back Chairs	578		
Motivate® Chair with Tablet Arm	579		
Motivate® Flex-Back Chair with Tablet Arm	580		
Nucleus® — Series Seating	581-582		
High Density Olson Stack® — 4040 Series	583		
Pagoda® — 4070/4090 Series	584-586		
Park Avenue Collection® Lounge Seating	587		
Park Avenue Collection® — 5020 Series	588		
Perpetual® Nesting Chairs	589		
Pillow-Soft® — 2090 Series	590		
Purpose® Seating	591-593		
Quotient™ Seating	594		
Solutions Seating® — 4000 Series	595		
Solve™ Seating	596-599		
Solve™ Accessories	600		
Soothe™ Seating	601		
Soothe™ Dual Fabric Seating	602		
Soothe™ Bench Seating	603		
Soothe™ Tables	604		
Soothe™ Brackets	604		
Soothe™ Patient Recliner Specifying Information	605		
Soothe™ Recliners	606		
Volt® — 5700 Series	607		
Volt® — 5710 Series	608		
Volt® — 5720 Series	609		
Volt® — 5730 Series	610		
7700 Series	611		
7800 Series	612-613		
basyx by HON® Mesh Chairs	614-617		
basyx by HON® Executive Big and Tall Chairs	618		
basyx by HON® Executive Chairs	619-621		
basyx by HON® Wood Executive Chairs	622		
basyx by HON® Task Chairs	623		
basyx by HON® Active Seating	624		
basyx by HON® Mesh Nesting Chairs	625		
basyx by HON® Mesh Guest Seating	626		
basyx by HON® Guest Seating	627-628		
basyx by HON® Wood Guest Chairs	629		
basyx by HON® Modular Lounge Seating	630		
basyx by HON® Cantilever Tables	630		
basyx by HON® Contemporary Lounge Seating	631		
basyx by HON® Contemporary Occasional Tables	631		
basyx by HON® Club/Lounge Seating	632		
TABLES			
Tables Ordering Information	633		
Arrange™ Café Tables Ordering Information	634		
Arrange™ Café Table Tops	635		
Arrange™ Café Table Bases	636		
Arrange™ Café Accessories	637		
Build™ Ordering Information	638		
Build™ Configurations	639-641		
Build™ Tables	642		
Coordinate™ Height Adjustable Base	643		
Coordinate™ Accessories	643		
Coordinate™ Worksurfaces	644-645		
Coordinate™ Shared Components	646		
Directional™ Desktop Sit-to-Stand	647		
Endorse™ Tables	648		
Flock® Collaborative Tables Ordering Information	649		
Flock® Collaborative Solutions Table Specifying Information	650		
Flock® Collaborative Veneer and Laminate Table Tops	651		
Flock® Collaborative Table Bases	652		
Flock® Collaborative Tables	653		
Flock® Collaborative Accessories	654		
Hospitality Tables — Tops	655-656		
Hospitality Tables — Bases	657		
Hospitality Cabinets	658-659		
Huddle Multi-Purpose Tables	660		
Huddle — Typicals	661		
Huddle Multi-Purpose Table Tops	662-663		
Huddle Multi-Purpose Table Bases	664		
Huddle Table Accessories	665		
Cable Management	665		
Interlink IQ Electrical	666		
4-Trac Electrical System	667-668		
Laminate Occasional Tables	669		
Motivate® Tables Specifying Information	670		
Motivate® Fixed Height Tables	671		
Motivate® Nesting Tables	672		
Motivate® Adjustable Height Tables	673		
Motivate® Folding Tables	674		
Motivate® Shared Components	675		
Interlink IQ Electrical	676		
4-Trac Electrical System	677-679		
Preside® Ordering Information	680		
Preside® Specifying Information	681-686		
Preside® Grommet Cutout Placement	687		
Preside® Base Clearance Dimensions	688		
Preside® — Typicals	689		
Preside® Veneer Table Tops	690-691		
Preside® Veneer Tables — Bases	692-695		
Preside® Veneer Shared Components	696-697		
Preside® Laminate Table Tops	698-699		
Preside® Laminate Tables — Bases	700-703		
Preside® Collaborative Tables	704		
Preside® Laminate Storage	705-706		
Modular Components	707		
Modular Components — Back Panels	707		
Wall Mount Storage	708		
Preside® Laminate Shared Components	709		
Cable Management	709		
Preside® Table Power Accessories	710-711		
Preside® Laminate Tables	712		
Preside® Laminate Tables — Pre-defined Typicals	712		
66000 Series/The StationMaster®	713		
Utility Tables	714		
basyx by HON® BL Laminate Conference Tables	715		
basyx by HON® BL Modular Conference Tables	715		
basyx by HON® Contemporary Occasional Tables	716		
basyx by HON® Laminate Occasional Tables	716		
basyx by HON® Cantilever Tables	716		
basyx by HON® Multi-Purpose Tables	717		
basyx by HON® Height Adjustable Base	718		
HON® Worksurfaces	718		
EDUCATION/LEARNING			
Cross Reference by Application	719-720		
Cafeteria Tables	721-722		
SmartLink® Ordering Information	723		
SmartLink® Specifying Information	724-729		
SmartLink® Student Desks	730		
SmartLink® Value Series Student Desks	731		
SmartLink® Student Accessories	732		
SmartLink® Chairs	733-734		
SmartLink® Teacher Stations	735		
SmartLink® Teacher Station Accessories	735		
SmartLink® Modular Storage	736-737		
SmartLink® Modular Storage and Accessories	738		
SmartLink® Wall Rail System	739		
SmartLink® Wall Rail System Accessories	740		
ACCESSORIES			
Accessories Ordering Information	741		
Cable Management	742		
Core Removable Lock Kits	743		
Corner Sleeves	744		
CPU Holder/Monitor Arms	745		
Directional™ Desktop Sit-to-Stand	746		
Electrical	747-748		
Keyboard Platforms	749-750		
Optional Accessories — Center Drawers	751		
Task Lights	752		
Touch-up Paint	753		
BUNDLES			
Bundles	754		
Volt® Bundles Typicals	755-757		
10500 Series™ Bundles Typicals	758-760		
10700 Series™ Bundles Typicals	761-762		
38000 Desks Bundles Typicals	763-764		
basyx by HON® Manage® Bundles Typicals	765-766		
basyx by HON® Laminate Desks Bundles Typicals	767-768		
INDEX			
Cross Reference by model number	769		
Information on Ordering Parts	IBC		

For information regarding HON registered and unregistered trademarks, please go to hon.com/protected-marks. Haworth®, Herman Miller®, Knoll®, and Steelcase® are registered trademarks of their respective owners and use of the marks do not imply affiliation or endorsement of The HON Company or its products.

Legend

The following icons are used throughout this publication.

-  Meets or exceeds ANSI/BIFMA and ISTA performance standards.
-  HON "One Key" Interchangeable core removable locks. Refer to page 743.
-  Caution
-  Easy to assemble.
-  Shippable by small-package carrier.
-  Omit core removable lock option available. Allows keyed-alike workstations. Refer to page 743.
-  Wheel-chair compatible.
-  Soft-tread caster option available.
-  Product shipped two to a carton.
-  Product shipped four to a carton.
-  Fire Code
-  Core Product Line
-  Product scheduled for discontinuation.
-  Fabric/upholstery/surface material de-emphasized, effective date as noted. Not carded. View online at honready.hon.com.
-  Indicates product that is not included on GSA contracts.
-  Indicates New product.

Environmental Statement

CLEARING THE AIR.

In 2006, The HON Company became the world's first office furniture manufacturer to have products certified by the Indoor Advantage™ Program. Virtually all manufactured products emit chemical compounds into the air. Indoor Advantage evaluates these compounds to help improve the air quality within enclosed indoor environments.

Developed by Scientific Certification Systems (SCS), Indoor Advantage subjects products to specific indoor air quality standards. Further, Indoor Advantage tests individual components as well as overall assemblies, and provides detailed analysis of a comprehensive range of all chemicals rather than simple pass/fail for only the most common. This enables us to help our suppliers reduce the environmental impact of their products and processes, too.

SCS offers two levels of certification:



Indoor Advantage™ certifies conformance with LEED-CI criteria for EQ4-5, as well as BIFMA X7.1 Low-Emitting Furniture and Seating.

On the level™

level, the BIFMA e3 sustainability standard, was developed in response to the increasing demand for proof that manufacturers are living up to their environmental claims. level Certification is based on four sustainability attributes: Materials, Energy and Atmosphere, Human and Ecosystem Health, and Social Responsibility. The HON Company has received level™ 2 certification for 60 product lines. That means more than 80 percent of our product volume has earned this important certification.



The level certification is a multi-attribute certification label for products that have met environmental, social and quality standards.

the sustainability certification program for furniture

Laminate Casegoods and Systems are certified as a typical workstation. Individual models contribute to the overall workstation certification.

Products that meet these specifications are identified throughout this publication with the following icons:



► The listings below are intended to show product, fabric, and finish additions from your 1/1/2016 HON List Pricer.

NEW ADDITIONS: PRODUCTS, FABRICS AND FINISHES

Desks	Effective Date	Fabrics and Finishes	Effective Date
101 Series™	January 2017	Chair Fabric	
Centerpiece™	January 2017	Grade 1	
Concinnity™	August 2016	Dapper DAPR	August 2016
<i>basyx</i> by HON®		Grade 2	
BL Expansion	October 2016	Seed SED	February 2017
		Spin Seating SPNN	August 2016
Storage	Effective Date	Grade 4	
Flagship® 20"D Pedestals	June 2016	Blip SCFSBLP	August 2016
<i>basyx</i> by HON®		Hive SCFSHVE	August 2016
Mobile Pedestals	October 2016	Sprint SCFSSPT	August 2016
		Grade 5	
Seating	Effective Date	Outlander SCFSOUT	August 2016
Accommodate™	March 2016	Poika SCFSPLK	August 2016
Flock® Mini	August 2016	Riddle SCFSRID	August 2016
Grove™	August 2016	Sentry-HC SCFSSEN	August 2016
Solve™ Expansion	October 2016	Sequence SCFSSEQ	August 2016
<i>basyx</i> by HON®		Tribeca SCFSTRB	August 2016
HVL205	January 2017	Grade 10	
HVL215	October 2016	Concentric SCFSCNC	August 2016
HVL515	October 2016	Grade 11	
HVL528	October 2016	Natural World SCFSNAT	August 2016
HVL538	October 2016	Grade 12	
HVL995	October 2016	Helix SCFSHLX	August 2016
HVLPERCH	January 2017	Lava SCFSLAV	August 2016
Volt® 5730 Series	January 2017	Ripple SCFSRIP	August 2016
Lota® 2290 Series	January 2017	ilira®-stretch M4 Mesh	
		Charcoal IC	October 2016
		Chai IH	October 2016
		Navy IY	October 2016
Tables	Effective Date	Workstation Fabrics	
Arrange™	March 2016	Grade A	
Build™	October 2016	Reflections REF	February 2017
Coordinate™ 3-Leg Height Adjustable Base	April 2016	Grade B	
Coordinate™ Corner Cove Worksurfaces	February 2016	Spin SPIN	August 2016
Coordinate™ Accessories	February 2016	Terrain TRRN	August 2016
Preside® Expansion	October 2016	Coast COA	February 2017
		Laminate	
Accessories	Effective Date	Grade L1	
Directional™ Desktop Sit-to-Stand	November 2016	Loft LOFT	January 2017
Power Modules	September 2016	Grade L2	
Power and Data Center	September 2016	Lowell Ash LLA1	February 2017
Grommet Accessory	November 2016	Phantom Ecru LPE1	February 2017
		Portico Teak LPT1	February 2017
		Natural Recon LNR1	February 2017
		Skyline Walnut LSW1	February 2017

Desks	Effective Date	Workstations	Effective Date
Accessories Model HLSLWMTRAY	July 1, 2016	Abound® Supports Model HOLEG18	January 3, 2017
Accessories Models H9000, H90150, HHD2R2D, HMAPWRMOD	January 3, 2017	Crash Rail Bracket Kit Model HSBB1	July 1, 2017
Announce® Series	February 28, 2017	Worksurfaces	January 3, 2017
Arrive® Series Models HVW3624, HVW629X	January 3, 2017	Models HLSLR2472L, HLSLR2472R, HLSLR3072L, HLSLR3072R, HWR2448LP, HWR2448LPN, HWR2448LSP, HWR2448LST, HWR2448LT, HWR2448LTN, HWR2448RP, HWR2448RPN, HWR2448RSP, HWR2448RST, HWR2448RT, HWR2448RTN, HWR2454LP, HWR2454LPN, HWR2454LSP, HWR2454LST, HWR2454LT, HWR2454LTN, HWR2454RP, HWR2454RPN, HWR2454RSP, HWR2454RST, HWR2454RT, HWR2454RTN, HWR2460LP, HWR2460LPN, HWR2460LSP, HWR2460LST, HWR2460LT, HWR2460LTN, HWR2460RP, HWR2460RPN, HWR2460RSP, HWR2460RST, HWR2460RT, HWR2460RTN, HWR2466LP, HWR2466LPN, HWR2466LSP, HWR2466LST, HWR2466LT, HWR2466LTN, HWR2466RP, HWR2466RPN, HWR2466RSP, HWR2466RST, HWR2466RT, HWR2466RTN, HWR2472LP, HWR2472LPN, HWR2472LSP, HWR2472LST, HWR2472LT, HWR2472LTN, HWR2472RP, HWR2472RPN, HWR2472RSP, HWR2472RST, HWR2472RT, HWR2472RTN, HWR3048LP, HWR3048LPN, HWR3048LSP, HWR3048LST, HWR3048LT, HWR3048LTN, HWR3048RP, HWR3048RPN, HWR3048RSP, HWR3048RST, HWR3048RT, HWR3048RTN, HWR3054LP, HWR3054LPN, HWR3054LSP, HWR3054LST, HWR3054LT, HWR3054LTN, HWR3054RP, HWR3054RPN, HWR3054RSP, HWR3054RST, HWR3054RT, HWR3054RTN, HWR3060LP, HWR3060LPN, HWR3060LSP, HWR3060LST, HWR3060LT, HWR3060LTN, HWR3060RP, HWR3060RPN, HWR3060RSP, HWR3060RST, HWR3060RT, HWR3060RTN, HWR3066LP, HWR3066LPN, HWR3066LSP, HWR3066LST, HWR3066LT, HWR3066LTN, HWR3066RP, HWR3066RPN, HWR3066RSP, HWR3066RST, HWR3066RT, HWR3066RTN, HWR3072LP, HWR3072LPN, HWR3072LSP, HWR3072LST, HWR3072LT, HWR3072LTN, HWR3072RP, HWR3072RPN, HWR3072RSP, HWR3072RST, HWR3072RT, HWR3072RTN, HWS246018LP, HWS246018LPN, HWS246018LSP, HWS246018LST, HWS246018LT, HWS246018LTN, HWS246018RP, HWS246018RPN, HWS246018RSP, HWS246018RST, HWS246018RT, HWS246018RTN, HWS246618LP, HWS246618LPN, HWS246618LSP, HWS246618LST, HWS246618LT, HWS246618LTN, HWS246618RP, HWS246618RPN, HWS246618RSP, HWS246618RST, HWS246618RT, HWS246618RTN, HWS246624LP, HWS246624LPN, HWS246624LSP, HWS246624LST, HWS246624LT, HWS246624LTN, HWS246624RP, HWS246624RPN, HWS246624RSP, HWS246624RST, HWS246624RT, HWS246624RTN, HWS247218LP, HWS247218LPN, HWS247218LSP, HWS247218LST, HWS247218LT, HWS247218LTN, HWS247218RP, HWS247218RPN, HWS247218RSP, HWS247218RST, HWS247218RT, HWS247218RTN, HWS247224LP, HWS247224LPN, HWS247224LSP, HWS247224LST, HWS247224LT, HWS247224LTN, HWS247224RP, HWS247224RPN, HWS247224RSP, HWS247224RST, HWS247224RT, HWS247224RTN, HWS247230LP, HWS247230LPN, HWS247230LSP, HWS247230LST, HWS247230LT, HWS247230LTN, HWS247230RP, HWS247230RPN, HWS247230RSP, HWS247230RST, HWS247230RT, HWS247230RTN, HWS306018LP, HWS306018LPN, HWS306018LSP, HWS306018LST, HWS306018LT, HWS306018LTN, HWS306018RP, HWS306018RPN, HWS306018RSP, HWS306018RST, HWS306018RT, HWS306018RTN, HWS306618LP, HWS306618LPN, HWS306618LSP, HWS306618LST, HWS306618LT, HWS306618LTN, HWS306618RP, HWS306618RPN, HWS306618RSP, HWS306618RST, HWS306618RT, HWS306618RTN, HWS306624LP, HWS306624LPN, HWS306624LSP, HWS306624LST, HWS306624LT, HWS306624LTN, HWS306624RP, HWS306624RPN, HWS306624RSP, HWS306624RST, HWS306624RT, HWS306624RTN, HWS307218LP, HWS307218LPN, HWS307218LSP, HWS307218LST, HWS307218LT, HWS307218LTN, HWS307218RP, HWS307218RPN, HWS307218RSP, HWS307218RST, HWS307218RT, HWS307218RTN, HWS307224LP, HWS307224LPN, HWS307224LSP, HWS307224LST, HWS307224LT, HWS307224LTN, HWS307224RP, HWS307224RPN, HWS307224RSP, HWS307224RST, HWS307224RT, HWS307224RTN, HWS307230LP, HWS307230LPN, HWS307230LSP, HWS307230LST, HWS307230LT, HWS307230LTN, HWS307230RP, HWS307230RPN, HWS307230RSP, HWS307230RST, HWS307230RT, HWS307230RTN	
Arrive® Series basyx by HON® BW Series	February 28, 2017		
Laminate Accessories Models HCRESCENTB3, HSWEEP2, HSWEEP3	January 3, 2017		
Mentor® Models HA88231, HA88235R, HA88236L, HA88251R, HA88263R, HA88265R, HA88266L, HA88962, HA88976	January 3, 2017		
Park Avenue Collection® Laminate Models HPM801G, HPM802G, HPM804G, HPM806G	January 3, 2017		
Park Avenue Collection® Laminate Series	July 1, 2017		
Park Avenue Collection® Veneer Models HPA100U, HPA101U	July 25, 2016		
Park Avenue Collection® Veneer Models HPA727X, HPA753L, HPA753R, HPA990G, HPA991G, HPA992G, HPA993G	January 3, 2017		
Park Avenue Collection® Veneer Series	February 28, 2017		
Voi® Laminate Models HLSL2060LD0PWR, HLSL2060LD2PWR, HLSL2060LD4PWR, HLSL2060S4PWR, HLSL2072LD0PWR, HLSL2072LD2PWR, HLSL2072LD4PWR, HLSL2072S4PWR, HLSL2430MFPWR, HLSLD246030, HLSLD246630, HLSLD247230, HSLD306024, HSLD306624, HSLD307224, HSLPMBSOI, HSLR2472L, HSLR2472R, HSLR3072L, HSLR3072R, HSLW045LPWR, HSLW045RPWR, HSLW046LPWR, HSLW046RPWR, HSLW085LPWR, HSLW085RPWR, HSLW086LPWR, HSLW086RPWR, HSLW445LPWR, HSLW445RPWR, HSLW446LPWR, HSLW446LPWR, HSLW446RPWR, HSLW446RPWR, HSLW485LPWR, HSLW485RPWR, HSLW486LPWR, HSLW486RPWR	July 1, 2016		
Voi® Veneer Models HLSV1436BH, HLSV1436D, HLSV1436S, HLSV1442D, HLSV1442S, HLSV1448D, HLSV1448S, HLSV1460D, HLSV1460M, HLSV1460S, HLSV1466D, HLSV1466M, HLSV1466S, HLSV1472D, HLSV1472M, HLSV1472S, HLSV1478D, HLSV1478M, HLSV1478S, HLSV2016MP2, HLSV2028B, HLSV2028F, HLSV2036SC, HLSV2060LD0, HLSV2060LD2, HLSV2060LD4, HLSV2060LL2, HLSV2060LR2, HLSV2060S4, HLSV2072LD0, HLSV2072LD2, HLSV2072LD4, HLSV2072LL2, HLSV2072LR2, HLSV2072S4, HLSV2430L, HLSV2430MF, HLSV2436L2, HLSV2436L4, HLSV2436SC, HLSVR2036, HLSVR2042, HLSVR2048, HLSVR2054, HLSVR2060, HLSVR2066, HLSVR2072, HLSVR2436, HLSVR2442, HLSVR2448, HLSVR2454, HLSVR2460, HLSVR2466, HLSVR2472, HLSVR2484, HLSVR3048, HLSVR3054, HLSVR3060, HLSVR3066, HLSVR3072, HLSVR3084, HLSVR3660, HLSVR3666, HLSVR3672, HLSVW446LP, HLSVW446RP	July 1, 2016		
10500 Series™ Models H105090, H105340, H105883R	January 3, 2017		
10700 Series™ Models H107401R, H107402L, H107725RX, H107726LX, H107820, H107835X, H107836X, H107837X	July 1, 2016		
10700 Series™ Models H10750, H10795	January 3, 2017		

STYLING

- Lustrous finish provides exceptional depth, clarity, and durability.
- Clean, uninterrupted lines and precise fits; no gaps.
- All end, modesty, and back panels, as well as drawer and door fronts, feature vertical grain.
- Formal, full height modesty panels on factory-configured (i.e., built-up; assembled) desks, credenzas, and returns.
- Drawer and door fronts over end panels.
- Top-between-end panels (behind door fronts) on stack-on and wall mount storage, and 68¼"H & 81¼"H storage and combination storage cabinets, wardrobes, and towers.
- Option choices include:
 - Handle design
 - Worksurface grommet
 - Wood or frosted doors on overhead storage
 - Finish (worksurface/chassis/drawer front/door as single option)

CONSTRUCTION

- Chassis & Pedestal Construction
 - All wood pedestals are made with veneer end panels and fronts which are constructed with ¾" thick balanced 3-ply panels.
 - End panels are connected with an inset top, back, and bottom cross-tie which is made of 11/16" thick 45lb particleboard. Panels are secured with cam fasteners in conjunction with pressed hardwood biscuits that are adhered with PVA (white polyvinyl acetate) glue.
 - A threaded steel glide plate is attached to the inset bottom panel on the pedestal to provide a durable connection between the glide and the bottom of the pedestal.
 - Steel glide plates are attached to single end panels with screws. End panels are pre-bored to accept the stem of the glide.
- Overhead / Storage Construction
 - All wood panels are constructed with ¾" thick balanced 3-ply panels.
 - Top, end, and bottom panels are secured with cam fasteners in conjunction with pressed hardwood biscuits that are adhered with PVA (white polyvinyl acetate) glue.
 - All units have inset back panels; backs are unfinished and covered gatorply material.
 - Back panels are connected using pocket bores and wood screws.
 - Stack-on storage attaches to worksurface with double-sided adhesive tape.
 - Wall mount cabinets are mounted to the wall with a spade and "z" bracket attachment method. Steel barrel nuts and spade brackets are securely mounted through the back of wall mount cabinets.
- All units ship with a "z" bracket. This bracket is mounted to the wall by field installers.
- Wall mount cabinet attachment requires individual cabinets be secured by a minimum of two wall mounting locations/studs.
- The cabinets are designed for interior and perimeter walls that are constructed with wood or metal studs. Installers are responsible for selecting and supplying appropriate fasteners for all conditions.
- The HON Company is not responsible for any liabilities resulting from wall mounted cabinets that are not properly installed per instructions.
- Hinges
 - Units with doors include 95° self-closing hinges. Hinges are adjustable.
- Filing
 - The file hanging system is an integral part of the drawer.
 - A highly durable black plastic extrusion is securely fastened into a route on the top of the drawer.
 - The extrusion, coupled with steel rails, allow side to side and front to back filing in file and lateral drawers.
 - The plastic extrusion was designed to promote optimum filing capacity within the drawer while providing a reliable and maintenance free filing system.
- Aluminum Frame Frosted Glass Doors
 - Extruded aluminum mitered frame is clear anodized silver aluminum.
 - Frame is 7/8" thick and 1¾" high. Frosted glass is inset within the frame.
 - All frosted glass should be cleaned with a soft lint free cloth and non-ammonia based cleaner only.
- Height Adjustable Worksurfaces
 - Worksurfaces are actual widths. A 1" clearance gap is required for any height adjustable top on all sides.
 - Moving worksurfaces can collide with other components. It is important to ensure free range of motion prior to operating the table.
 - Adjacent worksurfaces need to be self supporting. A wall mount bracket may be used.

MATERIALS

- Veneer and Finish
 - Natural veneer is subject to nature's quality control. Each species will exhibit difference in grain pattern and tone. This is to be expected and, in fact, contributes to the beauty and individuality of each product. Flat Cut veneers emphasize the variations of wood by exhibiting cathedrals in the grain pattern. **Worksurfaces, desktops, and table tops are protected by an advanced UV-cured finish coating in an Open Pore low sheen finish, applied by state-of-the-art finishing equipment.** The finish meets the EPA's stringent requirements for VOC emissions and air quality. Cured in a specially designed ultra-violet oven, the finish fuses to the wood, forming a durable shield that provides a high level of scratch, stain, chemical, and heat resistance, plus a high level of clarity. Regular dusting and occasional cleaning are recommended to maintain your wood finish. To clean, dampen a soft cloth with lukewarm water and gently wipe the wood in the direction of the grain. A mild solution of Murphy's oil soap and water may also be used. Avoid cleaners with oil, waxes, or silicones as they may create a hazy look.
 - Wood owes its inherent beauty to variations in color, grain, and texture; therefore, these variations are not considered defects. There may be minor variations from one piece of furniture to the next even though they are ordered and finished at the same time. Exposure to light and the aging process will cause a darkening of natural wood products. Light finishes on wood products do not mask the natural characteristics of wood. The HON Company does not guarantee the exact matching of grain, pattern, and color. Finishes do not cover any of the natural characteristics of the wood, including nature's colorations and pitch pockets. Merchandise will not be replaced because of these natural variations.
- All exposed surfaces utilize select plain sliced Cherry, Maple, or Walnut veneers. Veneers are carefully selected and slip-matched to assure balance and consistency.
- Finish process provides exceptional depth, clarity, durability, and chemical-resistance throughout the life of the product.
- Eight rich finishes to choose from — Bourbon Cherry, Cognac, Harvest, Mahogany, Mocha, Natural Maple, Pinnacle, and Shaker Cherry.
- Tops / Worksurfaces
 - 1³/₁₆" thick balanced 3-ply panels with 45lb. particleboard substrate
 - Flat edge detail
 - 3³/₃₂" thick natural solid external hardwood band on the user sides

- Tops connect to the chassis with wood screws through the inset top panel of the pedestals and steel angle brackets.

SUSTAINABILITY

- LEED EQ compliant finishes.
- Open pore low sheen water base UV finish on writable worksurfaces.
- Low-emitting, low sheen, solvent based conversion varnish finish on non-writing surfaces.
- 84.7% post-industrial and 1.8% post-consumer recycled content; overall recycled content factor of 44% (based on ANSI/BIFMA private office freestanding casegood workstation system configuration A2.2.5).

PRODUCT AND PACKAGE TESTING

- Meets or exceeds ANSI/BIFMA and ISTA performance standards.

DRAWER SPECIFICATIONS

- Drawers
 - All drawers are 5-sided construction, which allows easy drawer alignment or replacement of drawer fronts. Drawer fronts are attached with screws for easy removal.
 - Drawer fronts feature matched veneer within each pedestal set.
 - The drawers are miterfold construction and are fastened together with dowel joinery for maximum drawer strength.
 - The drawer side material is 3-ply 12mm vinyl-wrapped particleboard in a natural cherry color.
 - The bottom material is a 3-ply substrate consisting of vinyl-wrapped high-density fiberboard core.
 - Optional pencil tray is available for order.
- Drawer Slides
 - Box and file drawers feature full extension, precision steel ball bearing suspensions for a smooth, quiet range of motion; the slides are load rated for 100 lbs.
 - Fully progressive action with dampened start/stop.
 - Lateral file suspensions are load rated for 150 lbs and include an anti-tip mechanism that prevents more than one drawer from being opened at the same time.
 - Suspensions are silver, steel, roll-formed, zinc plated, and high-grade.
 - All suspensions are warranted for the lifetime of the product.

LEVELING GLIDES

- Glides provide 1¹/₈" of vertical leveling adjustment to compensate for uneven floors. Glide bottom is durable non-rust nylon.

	3 ³ / ₃₂ " Softened Edge	1mm Square Edge
Desk Tops	User & Approach	Ends
Extension Tops	User & Approach	Ends
Runoff Tops	User & Approach	Ends
Bridge Tops	User	Back and Ends
Credenza Tops	User	Back and Ends
Return Tops	User	Back and Ends

CORE REMOVABLE LOCKS

- Satin (silver) face locks are standard on **desk, credenza, return, stack-on and wall mount storage with doors, mobile pedestal, bookcase hutch with door, lateral file, bookcase with lateral file, storage cabinet with lateral file, wardrobe, wardrobe/storage cabinet, storage tower, and modular pedestal models**. Each pedestal is independently locked.
- Locks are factory installed. Lock is option SA.
- On individual models that have multiple locks, such as a double pedestal desk and storage tower, the locks are keyed alike.
- Models with hinged door below the worksurface do not lock. This includes: Hinged Door Full Storage Credenza, Modular Hinged Door Pedestal, and Hinged Door Cabinets.
- Glass doors do not lock.
- Hinged doors on 5 high laterals do not lock.
- Keying
 - Keying is random from the factory.
 - Locks feature a removable cylinder (core) that can be interchanged as needed; allows all furniture pieces within an individual workstation to be accessed with one key for convenience, and allows locks to be differentiated between workstations and offices for security. Makes re-keying quick and easy.
 - For field installable lock core kits, specify HF27S (satin) or HF27B (black) plus the key number.

CORD MANAGEMENT

- Capabilities include optional worksurface grommets.
- Desks specified with worksurface grommets include cutout in kneewell side of pedestal(s) to route and hide cords.
- Under worksurface wire managers are sold separately. These units hide and route cords horizontally around a station.
- Grommet
 - 2-piece round plastic grommet. Grommet cap is inset in a plastic sleeve. Sleeve measures 3" outside dimension x 1" thick.
 - Cap has two cord access holes. Black plastic finish only.
 - Component can be replaced with grommet-mount power hub (HGRMTAC) or power/USB hub (HGRMTUSB2).

Product	Number of Grommets	Grommet(s) Location
Desks	2	Back Left and Right
Credenza	1	Back Center
Return	1	Back Corner Opposite of Pedestal
Bridge	1	Back Center
Peninsula	1	User Side Back Corner
Modular Worksurface	1	Back Left, Back Center, or Back Right

ACCESSORIES

- Veneer center drawer (HVPACCD26)
- Pencil tray (HVPPT15)
- Lock kits:
 - Removable lock core (HF27B) - black - for stack-on and wall mounted storage with locking doors only
 - Removable lock core (HF27S) - satin - for stack-on and wall mounted storage with locking doors only
- Cord management:
 - Field installable grommets (HFLDGRMT3, HFLDGRMT4, HFLDGRMT)
 - Cable troughs (HCTROUGH17/HCTROUGH1710, HCTROUGH36/HCTROUGH3610)
- Electric accessories (sized to replace worksurface grommet):
 - Power hub, 3" diameter grommet mount (HGRMTAC)
 - Power/USB hub, 3" diameter grommet mount (HGRMTUSB2)
 - 4" x 8" Rectangle Grommet/Pop-up Port (HTPWGRGROM1) for rectangle conference table tops
- Lighting:
 - Task lights for stack-on and wall mounted storage (HH870960, HH870942, HH870930)
 - LED task lights for stack-on and wall mounted storage (HLED17AS, HLED31AS, HLED17A, HLED31A, HLED17AUO, HLED31AUO, HLEDOSA)
 - Desktop task lights (HLED1, HLED10C, HLED2)
- Computer accessories:
 - Keyboard platforms (H1706, H2107, H2516, H4022, HE4022, H4028, H4029)
 - Monitor arms (H5210, H5220)
- Mobile Pedestal Cushion (HPSEAT24ND)

WORKSURFACE / TOP EDGE DETAIL

Designator	Profile	
G	Flat, square	

DRAWER / DOOR DECORATIVE HANDLES

- Two handle style options, each available in silver.
- Distinct, easy to grasp designs.
- Handles are metal.
- The hole spacing is 128mm.
- The handle style has to be specified on drawer fronts (desk/credenza/return, mobile and modular pedestals), lateral file drawer fronts, the doors of the storage cabinet, storage/file cabinet, storage cabinet/lateral file, wardrobe/storage cabinet, wardrobe/bookcase, and storage tower.
- NOTE: Decorative handles are not used on the doors of stack-on storage units or wall mounted storage cabinets.

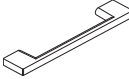
Designator	Handle Style	
A	Beam	
D	Bridge	

CORD MANAGEMENT GROMMETS

- Grommets — 3” round, black.

LOCK FINISH

- Locks — Satin face (for field installable lock kit, use model HF27S).

SILVER COLORWAY

- The following finish options are coordinating silver colorways: Satin, Satin Nickel, and Matte Chrome.

VENEER FINISHES / SPECIES

- All exposed surfaces utilize select plain sliced Cherry, Maple, or Walnut veneers.
- These veneers are carefully selected and slip-matched to assure balance and consistency.

Finish	Wood Species
Bourbon Cherry (H)	Cherry
Cognac (COGN)	Cherry
Harvest (C)	Maple
Mahogany (N)	Walnut
Mocha (MOCH)	Cherry
Natural Maple (D)	Maple
Pinnacle (PINC)	Walnut
Shaker Cherry (F)	Cherry

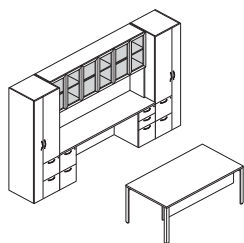
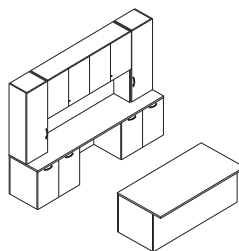

Table Desk/Credenza/Storage
138"W x 108"D

Qty.	Model #	Description	List Price	Price Extension
1	HVPTDR3672-WW	Table Desk with Four Metal Legs 72"W x 36"D x 29 1/8"H	\$2,415	\$ 2,415
1	HVPMWR2490-W	Rectangle Worksurface 90"W x 24"D	\$ 907	\$ 907
1	HVPMMPW2415-3W	Pedestal, Box/File 15 1/16"W x 24"D x 28"H	\$1,158	\$ 1,158
1	HVPMMPW2415-2W	Pedestal, File/File 15 1/16"W x 24"D x 28"H	\$1,158	\$ 1,158
1	HVPMCF90-W	Credenza Modesty Panel 90"W	\$ 624	\$ 624
1	HVPSMC2H90-WG	Stack-on Storage 90"W x 15"D x 52 1/16"H	\$4,449	\$ 4,449
1	HVPUTC6H24R-WW	Storage Tower, Right 24"W x 24"D x 81 1/4"H	\$4,471	\$ 4,471
1	HVPUTC6H24L-WW	Storage Tower, Left 24"W x 24"D x 81 1/4"H	\$4,471	\$ 4,471
TOTAL:			\$19,653	



Desk/Credenza/Storage
108"W x 108"D

Qty.	Model #	Description	List Price	Price Extension
1	HVPDR03672-32WW	Double Pedestal Desk, Rectangle Top 72"W x 36"D x 29 1/8"H	\$2,973	\$ 2,973
1	HVPMWR24108-W	Rectangle Worksurface 108"W x 24"D	\$1,250	\$ 1,250
2	HVPMMPW2436-5W	Storage Cabinet Pedestal 36"W x 24"D x 28"H	\$1,323	\$ 2,646
1	HVPMCF108-W	Credenza Modesty Panel 108"W	\$ 944	\$ 944
1	HVPSTF2H18R-WW	Bookcase Hutch, Right 18"W x 15"D x 52 1/16"H	\$1,498	\$ 1,498
1	HVPSTF2H18L-WW	Bookcase Hutch, Left 18"W x 15"D x 52 1/16"H	\$1,498	\$ 1,498
1	HVPSMC2H72-WW	Stack-on Storage 72"W x 15"D x 52 1/16"H	\$3,208	\$ 3,208
TOTAL:			\$14,017	

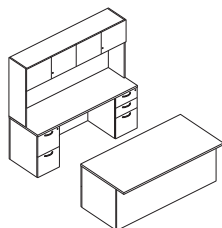

Desk/Credenza/Storage
72"W x 108"D

Qty.	Model #	Description	List Price	Price Extension
1	HVPDR03672-32WW	Double Pedestal Desk, Rectangle Top 72"W x 36"D x 29 1/8"H	\$2,973	\$2,973
1	HVPDPC2472-22WW	Credenza with Kneespace, File/File 72"W x 24"D x 29 1/8"H	\$2,775	\$2,775
1	HVPSMC1H72-WW	Stack-on Storage 72"W x 15"D x 39 1/8"H	\$2,592	\$2,592
TOTAL:			\$8,340	

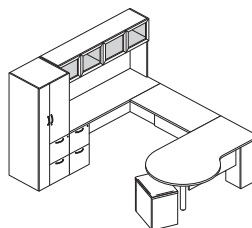

"U" Workstation with Peninsula
96"W x 114"D

Qty.	Model #	Description	List Price	Price Extension
1	HVPXBH3072-WW	P-Shape Peninsula, Right, 1/2 Modesty 72"W x 30/42"D x 29 1/8"H	\$2,391	\$ 2,391
1	HVPBRG2448-WW	Bridge 48"W x 24"D x 29 1/8"H	\$ 931	\$ 931
1	HVPSPC2472L-2WW	Single Pedestal Credenza, Left, File/File 72"W x 24"D x 29 1/8"H	\$2,331	\$ 2,331
1	HVPMMPD2415-6WW	Mobile Pedestal, Box/File 15 1/2"W x 21 3/4"D x 22 1/8"H	\$1,285	\$ 1,285
1	HPSEAT24ND	Pedestal Seat Cushion 15"W x 22 1/8"D x 2"H	\$ 176	\$ 176
1	HVPSMC1H72-WG	Stack-on Storage 72"W x 15"D x 39 1/8"H	\$2,748	\$ 2,748
1	HVPUTC5H24L-WW	Storage Tower, Left 24"W x 24"D x 68 1/4"H	\$3,910	\$ 3,910
TOTAL:			\$13,772	

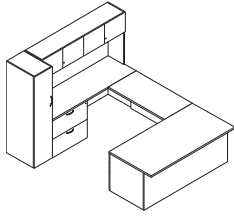

"U" Workstation with Desk
72"W x 108"D

Qty.	Model #	Description	List Price	Price Extension
1	HVPDR03672R-3WW	Single Pedestal Desk, Right, Rectangle Top 72"W x 36"D x 29 1/8"H	\$2,683	\$ 2,683
1	HVPBRG2448-WW	Bridge 48"W x 24"D x 29 1/8"H	\$ 931	\$ 931
1	HVPCLF2472L-4WW	Single Pedestal Credenza, Left, Lateral File 72"W x 24"D x 29 1/8"H	\$2,754	\$ 2,754
1	HVPSMC1H72-WW	Stack-on Storage 72"W x 15"D x 39 1/8"H	\$2,592	\$ 2,592
1	HVPCLS5H15L-WW	Wardrobe, Left 16"W x 24"D x 68 1/4"H	\$2,232	\$ 2,232
TOTAL:			\$11,192	

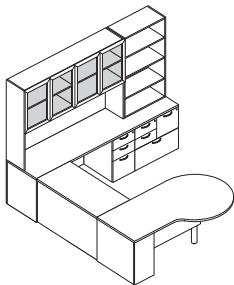

"U" Workstation with Peninsula
102"W x 114"D

Qty.	Model #	Description	List Price	Price Extension
1	HVPXDH3072-WW	P-Shape Peninsula, Left, 1/2 Modesty 72"W x 30/42"D x 29 1/8"H	\$2,391	\$ 2,391
1	HVPBRG2448-WW	Bridge 48"W x 24"D x 29 1/8"H	\$ 931	\$ 931
1	HVPMWR24102-W	Rectangle Worksurface 102"W x 24"D	\$1,085	\$ 1,085
1	HVPMPW2430-MFRW	Multi File Pedestal, Right 30"W x 24"D x 28"H	\$1,451	\$ 1,451
1	HVPMEP24-W	End Panel 3/4"W x 23 1/8"D	\$ 313	\$ 313
1	HVPMCF102-W	Credenza Modesty Panel 102"W	\$ 788	\$ 788
1	HVPMPW2415-3W	Pedestal, Box/Box/File 15 1/16"W x 24"D x 28"H	\$1,158	\$ 1,158
1	HVPSMC2H72-WG	Stack-on Storage 72"W x 15"D x 52 1/16"H	\$3,435	\$ 3,435
1	HVPSTN2H30-WN	Bookcase Hutch, Open 30"W x 15"D x 52 1/16"H	\$1,548	\$ 1,548
TOTAL:			\$13,100	

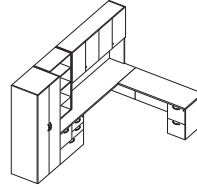

"L" Workstation
138"W x 84"D

Qty.	Model #	Description	List Price	Price Extension
1	HVPMWR24102-W	Rectangle Worksurface 102"W x 24"D	\$1,085	\$ 1,085
1	HVPMPW2430-MFLW	Multi File Pedestal, Left 30"W x 24"D x 28"H	\$1,451	\$ 1,451
1	HVPMEP24-W	End Panel 3/4"W x 23 1/8"D	\$ 313	\$ 313
1	HVPMCF102-W	Credenza Modesty Panel 102"W	\$ 788	\$ 788
1	HVPRTN2460R-2WW	Return, Right, File/File 60"W x 24"D x 29 1/8"H	\$2,011	\$ 2,011
1	HVPSMC2H72-WW	Stack-on Storage 72"W x 15"D x 52 1/16"H	\$3,208	\$ 3,208
1	HVPSTN2H30-WN	Bookcase Hutch, Open 30"W x 15"D x 52 1/16"H	\$1,548	\$ 1,548
1	HVPCLD6H30-DW	Wardrobe/Cabinet 36"W x 24"D x 81 1/4"H	\$4,373	\$ 4,373
TOTAL:			\$14,777	

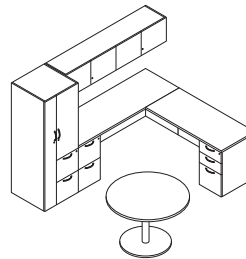

"L" Workstation
108"W x 108"D

Qty.	Model #	Description	List Price	Price Extension
1	HVPUTC5H24L-WW	Storage Tower, Left 24"W x 24"D x 68 1/4"H	\$3,910	\$ 3,910
1	HVPSPC2472L-2WW	Single Pedestal Credenza, Left, File/File 72"W x 24"D x 29 1/8"H	\$2,331	\$ 2,331
1	HVPMWR2454-W	Rectangle Worksurface 54"W x 24"D	\$ 627	\$ 627
1	HVPMPW2415-3W	Pedestal, Box/Box/File 15 1/16"W x 24"D x 28"H	\$1,158	\$ 1,158
1	HVPMRF54-W	Return Modesty Panel 54"W	\$ 450	\$ 450
1	HVPWMC1H72-WW	Wall Mount Storage 72"W x 15"D x 14 1/16"H	\$2,413	\$ 2,413
1	HVPTRD42-W	Round Top 42" Diameter Disc Base	\$1,427	\$ 1,427
1	HVPMDISC24-LD	24" Diameter	\$ 867	\$ 867
TOTAL:			\$13,183	

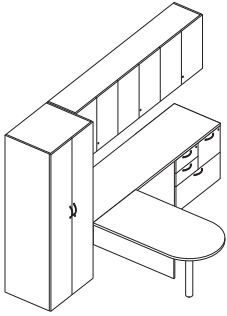

**Storage Wall with
Conference Runoff**
126"W x 78"D

Qty.	Model #	Description	List Price	Price Extension
1	HVPMWR2490-W	Rectangle Worksurface 90"W x 24"D	\$ 907	\$ 907
1	HVPMPW2430-MFRW	Multi File Pedestal, Right 30"W x 24"D x 28"H	\$1,451	\$ 1,451
1	HVPMEP24-W	End Panel ¾"W x 23½"D	\$ 313	\$ 313
1	HVPMCF90-W	Credenza Modesty Panel 90"W	\$ 624	\$ 624
1	HVPRRH3054L-WW	Bullet Runoff, Left, with Column Leg 54"W x 30"D x 29½"H	\$1,183	\$ 1,183
1	HVPWMC2H90-WW	Wall Mount Storage 90"W x 15"D x 27½"H	\$3,900	\$ 3,900
1	HVPCLD6H30-DW	Wardrobe/Cabinet 36"W x 24"D x 81¼"H	\$4,373	\$ 4,373
TOTAL:			\$12,751	

► **NEW!** Centerpiece™ Series available January 2017.

► Drawers operate on high quality steel ball-bearing suspensions to ensure quiet, smooth, long-lasting operation.

► Full extension box and file drawers allow complete and easy access to all contents.

► Filing capabilities for 72"W desks are front-to-back letter filing and side-to-side letter or legal filing.
► File drawers standard with hangrails.

► See page 45 for veneer center drawer.
► For removable lock core kits, see model HF27S on page 45.

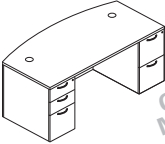
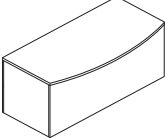
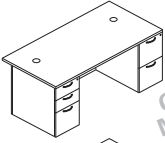
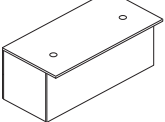
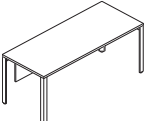
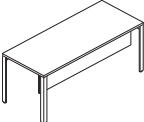

	Description	Model	Ship		
			Weight	Cube	List
 	Double Pedestal Desk — Bow Top 72"W x 36"D x 29 1/8"H NOTES: 6" conference overhang on approach side. Pedestal depth is 6" less than top depth. Single piece modesty panels. Kneespace between double pedestals on 72"W desks is 42".	HVPDB03672-32WW	430	54.3	\$3567
	 	Double Pedestal Desk — Rectangle Top 72"W x 36"D x 29 1/8"H NOTES: 6" conference overhang on approach side. Pedestal depth is 6" less than top depth. Single piece modesty panels. Kneespace between double pedestals on 72"W desks is 42".	HVPDR03672-32WW	435	54.3
 	Table Desk with Four Metal Legs 72"W x 36"D x 29 1/8"H 72"W x 30"D x 29 1/8"H NOTES: Horizontal, side-to-side grain direction. Includes 1/2 modesty panel. 6" conference overhang on approach side. Four metal legs; available in black (P) or silver (PR6).	HVPTDR3672-WW HVPTDR3072-WW	180 172	7.6 6.5	\$2415 \$2290

How to specify	1st Option	2nd Option	3rd Option	4th Option
Select Model Number from above H V P D B 0 3 6 7 2 - 3 2 W W .	Select Edge Profile G Square Edge	Select Handle A Beam in Silver D Bridge in Silver	Select Grommet GP Grommet(s) Black X No Grommet	Select Finish H Bourbon Cherry COGN Cognac C Harvest N Mahogany MOCH Mocha D Natural Maple PINC Pinnacle F Shaker Cherry
H V P D R 0 3 6 7 2 - 3 2 W W .	G .	A .	X .	N

How to specify	1st Option	2nd Option	3rd Option
Select Model Number from above H V P T D R 3 6 7 2 - W W .	Select Edge Profile G Square Edge	Select Leg Color PR6 Silver P Black	Select Finish H Bourbon Cherry COGN Cognac C Harvest N Mahogany MOCH Mocha D Natural Maple PINC Pinnacle F Shaker Cherry
	G .	P .	P I N C

Icon Legend on page 10

Centerpiece™ Desks

Not on GSA Contract



- ▶ **NEW!** Centerpiece™ Series available January 2017.
- ▶ Right pedestal desk to be specified with left pedestal return or bridge and left pedestal credenza.
- ▶ Left pedestal desk to be specified with right pedestal return or bridge and right pedestal credenza.
- ▶ Kneespace between end panel and pedestal:
66" width desk = 51"
72" width desk = 57"
- ▶ See page 45 for veneer center drawer.
▶ For removable lock core kits, see model HFZ7S on page 45.

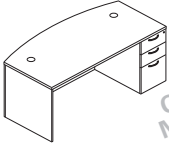
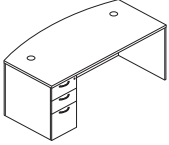
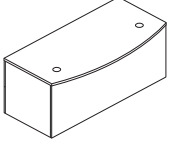

	Description	Model	Ship		
			Weight	Cube	List
 <p><i>Open Market</i></p> <p>HVPDB03672R-3WW shown</p>	Single Pedestal Desk — Bow Top				
	72"W x 36"D x 29 1/8"H, Right	HVPDB03672R-3WW	285	43.7	\$3119
	72"W x 36"D x 29 1/8"H, Left	HVPDB03672L-3WW	285	54.3	\$3119
 <p>HVPDB03672L-3WW shown</p>					
					

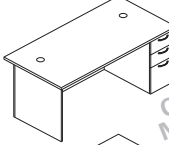
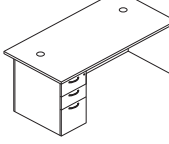
	Description	Model	Ship		
			Weight	Cube	List
 <p><i>Open Market</i></p>	Single Pedestal Desk — Rectangle Top				
	72"W x 36"D x 29 1/8"H, Right (shown)	HVPDR03672R-3WW	290	54.3	\$2683
	72"W x 30"D x 29 1/8"H, Right	HVPDRF3072R-3WW	300	36.4	\$2545
	66"W x 30"D x 29 1/8"H, Right	HVPDRF3066R-3WW	280	33.4	\$2461
	72"W x 36"D x 29 1/8"H, Left (shown)	HVPDR03672L-3WW	290	54.3	\$2683
	72"W x 30"D x 29 1/8"H, Left	HVPDRF3072L-3WW	300	46.0	\$2545
	66"W x 30"D x 29 1/8"H, Left	HVPDRF3066L-3WW	280	42.3	\$2461

NOTES: 30"D desks have a flush modesty panel; no overhang on approach-side.

How to specify	1st Option	2nd Option	3rd Option	4th Option
Select Model Number from above	Select Edge Profile	Select Handle	Select Grommet	Select Finish
	G Square Edge	A Beam in Silver D Bridge in Silver	GP Grommet(s) Black X No Grommet	H Bourbon Cherry COGN Cognac C Harvest N Mahogany MOCH Mocha D Natural Maple PINC Pinnacle F Shaker Cherry
H V P D B O 3 6 7 2 R - 3 W W .	G .	D .	G P .	D

Icon Legend on page 10

- ▶ **NEW!** Centerpiece™ Series available January 2017.
- ▶ Available in bullet or P-shaped tops.
- ▶ Right peninsula for use with left pedestal return or bridge and left pedestal credenza.
- ▶ Left peninsula for use with right pedestal return or bridge and right pedestal credenza.
- ▶ 1/2-height modesty panel.
- ▶ 6" conference overhang on approach side.
- ▶ Peninsulas include metal support column; available in black or silver.

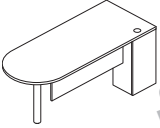
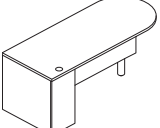

	Description	Model	Ship		
			Weight	Cube	List
 <i>HVPXRH3072R-WW shown</i>	Peninsula with 1/2 Modesty Panel 72"W x 30"D x 29 1/8"H, Bullet Shape with Support Column, Right	HVPXRH3072R-WW	150	36.4	\$1935
	72"W x 30"D x 29 1/8"H, Bullet Shape with Support Column, Left	HVPXRH3072L-WW	150	36.4	\$1935
 <i>HVPXRBH3072R-WW shown</i>	72"W x 30/42"D x 29 1/8"H, P-Shape with Support Column, Right	HVPXRBH3072R-WW	154	46.0	\$2391
	72"W x 30/42"D x 29 1/8"H, P-Shape with Support Column, Left	HVPXRDH3072R-WW	154	46.0	\$2391

Open Market

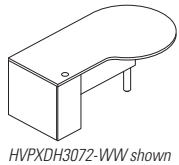
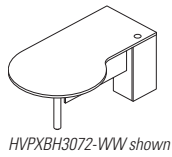
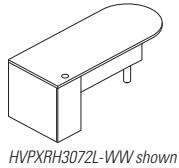

How to specify	1st Option	2nd Option	3rd Option	4th Option
Select Model Number from above H V P X R H 3 0 7 2 R - W W .	Select Edge Profile G Square Edge	Select Grommet GP Grommet(s) Black X No Grommet	Select Column Color PR6 Silver Black P Black	Select Finish H Bourbon Cherry COGN Cognac C Harvest N Mahogany MOCH Mocha D Natural Maple PINC Pinnacle F Shaker Cherry
	G .	X .	P R 6 .	F

Icon Legend on page 10



Centerpiece™ Conference Runoffs

Not on GSA Contract



- ▶ **NEW!** Centerpiece™ Series available January 2017.
- ▶ Worksurface extension solution attaches perpendicular to credenzas.
- ▶ Bullet and rectangle worksurface shapes.
- ▶ Vertical, front-to-back grain direction on worksurface.
- ▶ 3" diameter metal support column included with bullet worksurface.
- ▶ Two metal support legs included with rectangle worksurface.
- ▶ Column and legs available in black or silver.
- ▶ Units ship unassembled, field assembly required.
- ▶ Conference runoffs include worksurface connection bracket.

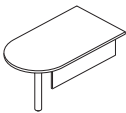

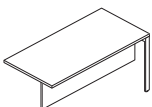
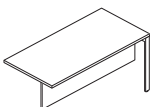
Description		Model	Ship Weight	Cube	List
 <i>HVPRRH3054R-WW shown</i>	Bullet Conference Runoff with 1/2 Modesty Panel 60"W x 30"D x 29 1/8"H, with Support Column, Right	HVPRRH3060R-WW E♦A	54	5.4	\$1250
	54"W x 30"D x 29 1/8"H, with Support Column, Right	HVPRRH3054R-WW E♦A	49	4.9	\$1183
 <i>HVPRRH3054L-WW shown</i>	60"W x 30"D x 29 1/8"H, with Support Column, Left	HVPRRH3060L-WW E♦A	54	5.4	\$1250
	54"W x 30"D x 29 1/8"H, with Support Column, Left	HVPRRH3054L-WW E♦A	49	4.9	\$1183
 <i>HVPRRL3060L-WW shown</i>	Rectangle Conference Runoff with 1/2 Modesty Panel 60"W x 30"D x 29 1/8"H, with Metal Legs, Right	HVPRRL3060R-WW E♦A	60	5.4	\$1431
	54"W x 30"D x 29 1/8"H, with Metal Legs, Right	HVPRRL3054R-WW E♦A	55	4.9	\$1385
 <i>HVPRRL3060L-WW shown</i>	60"W x 30"D x 29 1/8"H, with Metal Legs, Left	HVPRRL3060L-WW E♦A	60	5.4	\$1431
	54"W x 30"D x 29 1/8"H, with Metal Legs, Left	HVPRRL3054L-WW E♦A	55	4.9	\$1385

How to specify	1st Option	2nd Option	3rd Option
Select Model Number from above H V P R R H 3 0 6 0 R - W W . G .	Select Edge Profile G Square Edge	Select Column/Leg Color PR6 Silver P Black	Select Finish H Bourbon Cherry MOCH Mocha COGN Cognac D Natural Maple C Harvest PINC Pinnacle N Mahogany F Shaker Cherry M O C H

ABJ E♦A Icon Legend on page 10

▶ **NEW!** Centerpiece™ Series available January 2017.

▶ Drawers operate on high quality steel ball-bearing suspensions to ensure quiet, smooth, long-lasting operation.

▶ Full extension drawers allow complete and easy access to all contents.
▶ File drawers standard with hangrails.

▶ For removable lock core kits, see model HF27S on page 45.

⚠ **The credenza models listed on this page have an unfinished back panel; they are intended for use against a wall. For a finished back panel, specify credenzas using modular components.**

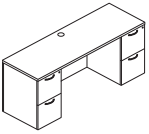
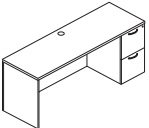
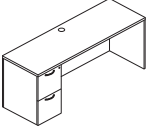
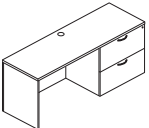
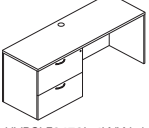

	Description	Model	Ship Weight	Cube	List
 Open Market	Credenza with Kneespace 72"W x 24"D x 29 1/8"H NOTES: For use behind a desk or as a stand-alone storage piece. Four locking file drawers, 2-left, 2-right. 60" and 66"W sizes can be specified using modular components.	HVPDPC2472-22WW	280	37.6	\$2775
 Open Market	Single Pedestal Credenza 72"W x 24"D x 29 1/8"H, Right 66"W x 24"D x 29 1/8"H, Right 72"W x 24"D x 29 1/8"H, Left 66"W x 24"D x 29 1/8"H, Left NOTES: Primary use is as part of a U-shaped workstation with a single pedestal desk and a bridge. Two locking file drawers. Modular component options include sizes wider than 72" and box/box/file pedestal storage.	HVPSPC2472R-2WW HVPSPC2466R-2WW HVPSPC2472L-2WW HVPSPC2466L-2WW	275 255 275 255	37.6 34.6 37.6 34.6	\$2331 \$2187 \$2331 \$2187
 Open Market	Credenza with Lateral File 84"W x 24"D x 29 1/8"H, Right 78"W x 24"D x 29 1/8"H, Right 72"W x 24"D x 29 1/8"H, Right 84"W x 24"D x 29 1/8"H, Left 78"W x 24"D x 29 1/8"H, Left 72"W x 24"D x 29 1/8"H, Left NOTES: Primary use is as part of a U-shaped workstation with a single pedestal desk and a bridge. Storage file measures 30"W. T-Support included with 84"W size; for unsupported worksurface span greater than 48"W. Modular options include components for credenza with 36"W lateral file.	HVPCLF2484R-4WW HVPCLF2478R-4WW HVPCLF2472R-4WW HVPCLF2484L-4WW HVPCLF2478L-4WW HVPCLF2472L-4WW	345 330 315 345 330 315	43.6 40.7 37.6 43.7 40.7 37.6	\$3088 \$2871 \$2754 \$3088 \$2871 \$2754
 Open Market	Credenza with Two Lateral Files 72"W x 24"D x 29 1/8"H 60"W x 24"D x 29 1/8"H NOTES: Four locking lateral file drawers, 2-left, 2-right.	HVPFSC2472-44WW HVPFSC2460-44WW	310 240	37.6 31.6	\$3710 \$3339
 Open Market	Credenza with Two Storage Cabinets 72"W x 24"D x 29 1/8"H 60"W x 24"D x 29 1/8"H NOTES: Two side-by-side cabinets. Hinged doors; doors do not lock.	HVPFSC2472-55WW HVPFSC2460-55WW	280 210	37.6 31.6	\$2884 \$2595

How to specify	1st Option	2nd Option	3rd Option	4th Option
Select Model Number from above	Select Edge Profile G Square Edge	Select Handle A Beam in Silver D Bridge in Silver	Select Grommet GPC Grommet Black X No Grommet Do NOT specify for models: HVPFSC2472-44WW, HVPFSC2460-44WW, HVPFSC2472-55WW, HVPFSC2460-55WW	Select Finish H Bourbon Cherry COGN Cognac C Harvest N Mahogany MOCH Mocha D Natural Maple PINC Pinnacle F Shaker Cherry
	H V P D P C 2 4 7 2 - 2 2 WW . G .	D .	G P C .	D

Icon Legend on page 10

Centerpiece™ Returns

Not on GSA Contract



- ▶ **NEW!** Centerpiece™ Series available January 2017.
- ▶ Right returns to be specified with left pedestal desks and peninsulas.
- ▶ Left returns to be specified with right pedestal desks and peninsulas.
- ▶ Worksurface has vertical, front-to-back grain direction.
- ▶ Finished back panel is standard on both factory-configured models and returns built with modular components.
- ▶ 66" and 72"W sizes, and alternative storage configurations, can be specified using modular components.
- ▶ Returns standard with two file drawers; handrails included.
- ▶ Returns include worksurface connection bracket.
- ▶ For removable lock core kits, see model HF27S on page 45.

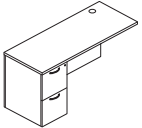

Description	Model	Ship		
		Weight	Cube	List
 <p><i>Open Market</i></p> <p>Return 60"W x 24"D x 29½"H, Right 54"W x 24"D x 29½"H, Right 48"W x 24"D x 29½"H, Right 42"W x 24"D x 29½"H, Right</p> <p><i>HVPRTN2460R-2WW shown</i></p>	HVPRTN2460R-2WW	235	31.6	\$2011
	HVPRTN2454R-2WW	220	28.6	\$1947
	HVPRTN2448R-2WW	205	25.6	\$1891
	HVPRTN2442R-2WW	190	22.6	\$1842
 <p><i>Open Market</i></p> <p>60"W x 24"D x 29½"H, Left 54"W x 24"D x 29½"H, Left 48"W x 24"D x 29½"H, Left 42"W x 24"D x 29½"H, Left</p> <p><i>HVPRTN2460L-2WW shown</i></p>	HVPRTN2460L-2WW	235	31.6	\$2011
	HVPRTN2454L-2WW	220	28.6	\$1947
	HVPRTN2448L-2WW	205	25.6	\$1891
	HVPRTN2442L-2WW	190	22.6	\$1842

How to specify	1st Option	2nd Option	3rd Option	4th Option
Select Model Number from above	Select Edge Profile	Select Handle	Select Grommet	Select Finish
	G Square Edge	A Beam in Silver D Bridge in Silver	GP Grommet Black X No Grommet	H Bourbon Cherry COGN Cognac C Harvest N Mahogany MOCH Mocha D Natural Maple PINC Pinnacle F Shaker Cherry
H V P R T N 2 4 6 0 R - 2 W W . G .	G .	D .	G P .	D

Centerpiece™ Bridges

Not on GSA Contract

- ▶ **NEW!** Centerpiece™ Series available January 2017.
- ▶ Available with full modesty panel or with no modesty panel.
- ▶ Worksurface has vertical, front-to-back grain direction to align with desk and credenza grain.
- ▶ Finished back panel.
- ▶ Modesty panel units ship unassembled, field assembly required.
- ▶ Bridges include worksurface connection brackets.

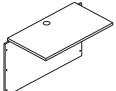
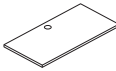

Description	Model	Ship		
		Weight	Cube	List
 <p><i>Open Market</i></p> <p>Bridge with Full Modesty Panel 48"W x 24"D x 29½"H 42"W x 24"D x 29½"H</p> <p><i>HVPBRG2442-WW shown</i></p>	HVPBRG2448-WW E♦A	75	4.4	\$ 931
	HVPBRG2442-WW E♦A	67	3.9	\$ 893
 <p><i>Open Market</i></p> <p>Bridge with No Modesty Panel 48"W x 24"D x 29½"H 42"W x 24"D x 29½"H</p> <p><i>HVPBRX2448-WW shown</i></p>	HVPBRX2448-WW E♦A	75	4.4	\$ 739
	HVPBRX2442-WW E♦A	67	3.9	\$ 701

How to specify	1st Option	2nd Option	3rd Option
Select Model Number from above	Select Edge Profile	Select Grommet	Select Finish
	G Square Edge	GP Grommet Black X No Grommet	H Bourbon Cherry COGN Cognac C Harvest N Mahogany MOCH Mocha D Natural Maple PINC Pinnacle F Shaker Cherry
H V P B R G 2 4 4 8 - W W . G .	G .	G P .	C

E♦A Icon Legend on page 10

- ▶ **NEW!** Centerpiece™ Series available January 2017.
- ▶ Available with wood or aluminum frame frosted glass doors.

- ▶ Wood door models are standard with locks; lock finish is satin. Frosted door units do not lock.
- ▶ Doors equipped with self-closing hinges; hinges are adjustable.
- ▶ Two height options, single (39" H) and double (52" H).

- ▶ Double height cabinets include standard fixed shelf.
- ▶ Inside dimensions (width varies with cabinet): 1 high standard - D = 13 3/8", H = 12 1/4"; 2 high standard - D = 13 3/8", H = 25 1/8".
- ▶ Distance from bottom of cabinet to worksurface is 24 1/2" on all units.

- ▶ Connect to worksurface with double-sided adhesive tape.
- ▶ Lighting options available. See page 46.
- ▶ 2" diameter pass-through hole in back panel to route task light cord.

- ▶ Units have an unfinished back and are intended for use against a wall.
- ▶ Ship assembled.
- ▶ See page 30 for tackboards.

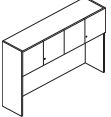
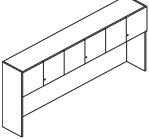
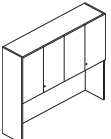
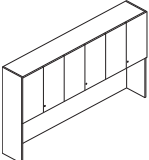
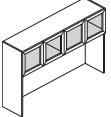
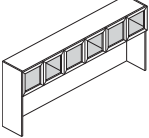
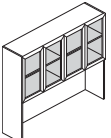
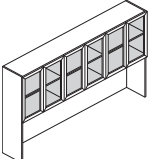

	Description	Model	Ship Weight	Cube	List
 HVPSMC1H60-WW shown  HVPSMC1H90-WW shown	Open Market Stack-on Storage — Wood Doors — 39" H 96"W x 14 3/4"D x 39 1/8"H — 6 Doors 90"W x 14 3/4"D x 39 1/8"H — 6 Doors 84"W x 14 3/4"D x 39 1/8"H — 6 Doors 78"W x 14 3/4"D x 39 1/8"H — 4 Doors 72"W x 14 3/4"D x 39 1/8"H — 4 Doors 66"W x 14 3/4"D x 39 1/8"H — 4 Doors 60"W x 14 3/4"D x 39 1/8"H — 4 Doors	HVPSMC1H96-WW	210	42.8	\$3633
		HVPSMC1H90-WW	199	40.2	\$3316
		HVPSMC1H84-WW	187	37.6	\$3027
		HVPSMC1H78-WW	170	35.0	\$2765
		HVPSMC1H72-WW	159	32.4	\$2592
		HVPSMC1H66-WW	147	29.8	\$2422
		HVPSMC1H60-WW	135	27.2	\$2260
 HVPSMC2H60-WW shown  HVPSMC2H90-WW shown	Open Market Stack-on Storage — Wood Doors — 52" H 90"W x 14 3/4"D x 52 1/16"H — 6 Doors 84"W x 14 3/4"D x 52 1/16"H — 6 Doors 78"W x 14 3/4"D x 52 1/16"H — 4 Doors 72"W x 14 3/4"D x 52 1/16"H — 4 Doors 66"W x 14 3/4"D x 52 1/16"H — 4 Doors 60"W x 14 3/4"D x 52 1/16"H — 4 Doors	HVPSMC2H90-WW	302	52.5	\$4111
		HVPSMC2H84-WW	280	49.1	\$3750
		HVPSMC2H78-WW	255	45.7	\$3422
		HVPSMC2H72-WW	240	42.3	\$3208
		HVPSMC2H66-WW	225	39.0	\$2992
		HVPSMC2H60-WW	210	35.6	\$2792
		 HVPSMC1H60-WG shown  HVPSMC1H90-WG shown	Open Market Stack-on Storage — Frosted Doors/Silver Frame — 39" H 90"W x 14 3/4"D x 39 1/8"H — 6 Doors 72"W x 14 3/4"D x 39 1/8"H — 4 Doors 60"W x 14 3/4"D x 39 1/8"H — 4 Doors	HVPSMC1H90-WG	199
HVPSMC1H72-WG	159			32.4	\$2748
HVPSMC1H60-WG	135			27.2	\$2378
 HVPSMC2H60-WG shown  HVPSMC2H90-WG shown	Open Market Stack-on Storage — Frosted Doors/Silver Frame — 52" H 90"W x 14 3/4"D x 52 1/16"H — 6 Doors 72"W x 14 3/4"D x 52 1/16"H — 4 Doors 60"W x 14 3/4"D x 52 1/16"H — 4 Doors	HVPSMC2H90-WG	302	52.5	\$4449
		HVPSMC2H72-WG	240	42.3	\$3435
		HVPSMC2H60-WG	210	35.6	\$2971

How to specify	1st Option	2nd Option
Select Model Number from above H V P S M C 1 H 9 6 - W W . S A .	Select Lock SA Satin Do NOT specify on models with frosted doors	Select Finish H Bourbon Cherry MOCH Mocha COGN Cognac D Natural Maple C Harvest PINC Pinnacle N Mahogany F Shaker Cherry

Icon Legend on page 10

Centerpiece™ Tackboards

Not on GSA Contract



▶ **NEW!** Centerpiece™ Series available January 2017.

▶ Tackboards include latch and hook tape for attachment to stack-on storage back panel.

▶ Available in HON Group panel fabric grades A and B.

⚠ **Upcharges may apply to different fabric grades.**

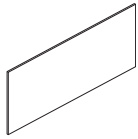

Open Market

Description

Model

Ship Weight

Cube

List

Tackboard for use with Stack-on Storage
 47³/₃₂"W x 5⁵/₈"D x 23³/₈"H - for 96"W (qty. 2)
 88³/₁₆"W x 5⁵/₈"D x 23³/₈"H - for 90"W
 82³/₁₆"W x 5⁵/₈"D x 23³/₈"H - for 84"W
 76³/₁₆"W x 5⁵/₈"D x 23³/₈"H - for 78"W
 70³/₁₆"W x 5⁵/₈"D x 23³/₈"H - for 72"W
 64³/₁₆"W x 5⁵/₈"D x 23³/₈"H - for 66"W
 58³/₁₆"W x 5⁵/₈"D x 23³/₈"H - for 60"W

HVPTKS96	34	6.8	\$ 499
HVPTKS90	32	6.4	\$ 468
HVPTKS84	30	6.0	\$ 436
HVPTKS78	29	5.6	\$ 404
HVPTKS72	27	5.1	\$ 372
HVPTKS66	25	4.7	\$ 341
HVPTKS60	23	4.3	\$ 309

How to specify

Select Model Number from above

H | V | P | T | K | S | 9 | 6 | .

1st Option

Select Fabric

See pages 310-311

A | P | N | 1 | 5

Icon Legend on page 10

- ▶ **NEW!** Centerpiece™ Series available January 2017.
- ▶ Available with wood or aluminum frame frosted glass doors.
- ▶ Wood door models are standard with locks; lock finish is satin. Frosted door units do not lock.
- ▶ For removable lock core kits, see model HF27S on page 45.

- ▶ Doors equipped with self-closing hinges; hinges are adjustable.
- ▶ Single-height 14¹¹/₁₆" and double-height 27⁵/₈".
- ▶ Double-height cabinets include standard fixed shelf.
- ▶ Inside dimensions (width varies with cabinet): 1 high standard - D = 13¹³/₁₆", H = 12¹/₄"; 2 high standard - D = 13¹³/₁₆", H = 25¹/₈".







- ▶ For task lights, see page 46.
- ▶ Units have an unfinished back.
- ▶ Connect to wall with steel spade and "z" clip method; mounted to the wall by field installers.

⚠ **The cabinets are designed for interior and perimeter walls that are constructed with wood or metal studs. Installers are responsible for selecting and supplying appropriate fasteners for all conditions.**

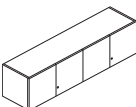
⚠ **HON Company is not responsible for any liabilities resulting from wall mounted cabinets that are not properly installed.**

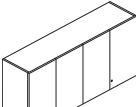
⚠ **Wall mount cabinet attachment requires individual cabinets be secured by a minimum of two wall mounting locations/studs.**

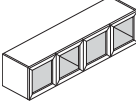

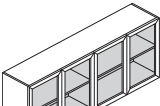
	Description	Model	Ship Weight	Cube	List		
 HVPWMC1H36-WW shown  HVPWMC1H60-WW shown	Open Market Wall Mount Storage — Wood Doors — 14 ³ / ₄ "H 108"W x 14 ³ / ₄ "D x 14 ¹¹ / ₁₆ "H — 6 Doors 102"W x 14 ³ / ₄ "D x 14 ¹¹ / ₁₆ "H — 6 Doors 96"W x 14 ³ / ₄ "D x 14 ¹¹ / ₁₆ "H — 6 Doors 90"W x 14 ³ / ₄ "D x 14 ¹¹ / ₁₆ "H — 6 Doors 84"W x 14 ³ / ₄ "D x 14 ¹¹ / ₁₆ "H — 6 Doors 78"W x 14 ³ / ₄ "D x 14 ¹¹ / ₁₆ "H — 4 Doors 72"W x 14 ³ / ₄ "D x 14 ¹¹ / ₁₆ "H — 4 Doors 66"W x 14 ³ / ₄ "D x 14 ¹¹ / ₁₆ "H — 4 Doors 60"W x 14 ³ / ₄ "D x 14 ¹¹ / ₁₆ "H — 4 Doors 36"W x 14 ³ / ₄ "D x 14 ¹¹ / ₁₆ "H — 2 Doors	HVPWMC1H108-WW	158	20.2	\$3332		
		HVPWMC1H102-WW	149	19.1	\$3210		
		HVPWMC1H96-WW	142	18.0	\$3092		
		HVPWMC1H90-WW	135	16.9	\$2924		
		HVPWMC1H84-WW	126	15.8	\$2742		
		HVPWMC1H78-WW	115	14.7	\$2572		
		HVPWMC1H72-WW	105	13.6	\$2413		
		HVPWMC1H66-WW	94	12.5	\$2253		
		HVPWMC1H60-WW	85	11.4	\$2106		
		HVPWMC1H36-WW	53	7.1	\$1410		
 HVPWMC2H36-WW shown  HVPWMC2H60-WW shown	Open Market Wall Mount Storage — Wood Doors — 27 ⁵ / ₈ "H 90"W x 14 ³ / ₄ "D x 27 ⁵ / ₈ "H — 6 Doors 84"W x 14 ³ / ₄ "D x 27 ⁵ / ₈ "H — 6 Doors 78"W x 14 ³ / ₄ "D x 27 ⁵ / ₈ "H — 4 Doors 72"W x 14 ³ / ₄ "D x 27 ⁵ / ₈ "H — 4 Doors 66"W x 14 ³ / ₄ "D x 27 ⁵ / ₈ "H — 4 Doors 60"W x 14 ³ / ₄ "D x 27 ⁵ / ₈ "H — 4 Doors 36"W x 14 ³ / ₄ "D x 27 ⁵ / ₈ "H — 2 Doors	HVPWMC2H90-WW	237	29.3	\$3900		
		HVPWMC2H84-WW	218	27.4	\$3601		
		HVPWMC2H78-WW	201	25.5	\$3302		
		HVPWMC2H72-WW	186	23.6	\$2982		
		HVPWMC2H66-WW	167	21.7	\$2783		
		HVPWMC2H60-WW	150	19.8	\$2598		
		HVPWMC2H36-WW	93	12.3	\$1730		
		 HVPWMC1H36-WG shown  HVPWMC1H60-WG shown	Open Market Wall Mount Storage — Frosted Doors/Silver Frame — 14 ³ / ₄ "H 108"W x 14 ³ / ₄ "D x 14 ¹¹ / ₁₆ "H — 6 Doors 90"W x 14 ³ / ₄ "D x 14 ¹¹ / ₁₆ "H — 6 Doors 72"W x 14 ³ / ₄ "D x 14 ¹¹ / ₁₆ "H — 4 Doors 60"W x 14 ³ / ₄ "D x 14 ¹¹ / ₁₆ "H — 4 Doors 36"W x 14 ³ / ₄ "D x 14 ¹¹ / ₁₆ "H — 2 Doors	HVPWMC1H108-WG	158	20.2	\$3577
				HVPWMC1H90-WG	135	16.9	\$3119
				HVPWMC1H72-WG	105	13.6	\$2546
HVPWMC1H60-WG	94			11.4	\$2203		
HVPWMC1H36-WG	53			7.1	\$1425		
 HVPWMC2H36-WG shown  HVPWMC2H72-WG shown	Open Market Wall Mount Storage — Frosted Doors/Silver Frame — 27 ⁵ / ₈ "H 90"W x 14 ³ / ₄ "D x 27 ⁵ / ₈ "H — 6 Doors 72"W x 14 ³ / ₄ "D x 27 ⁵ / ₈ "H — 4 Doors 60"W x 14 ³ / ₄ "D x 27 ⁵ / ₈ "H — 4 Doors 36"W x 14 ³ / ₄ "D x 27 ⁵ / ₈ "H — 2 Doors			HVPWMC2H90-WG	237	29.3	\$4213
		HVPWMC2H72-WG	186	23.6	\$3185		
		HVPWMC2H60-WG	150	19.8	\$2752		
		HVPWMC2H36-WG	93	12.3	\$1780		

How to specify	1st Option	2nd Option
Select Model Number from above H V P W M C 1 H 1 0 8 - W W .	Select Lock SA Satin Do NOT specify on models with frosted doors	Select Finish H Bourbon Cherry MOCH Mocha COGN Cognac D Natural Maple C Harvest PINC Pinnacle N Mahogany F Shaker Cherry P I N C

⚠ Icon Legend on page 10

Centerpiece™ Tackboards

Not on GSA Contract

HON

► **NEW!** Centerpiece™ Series available January 2017.

► Available in HON Group panel fabric grades A and B.

► Easy to install; includes mounting hardware.

⚠ **Upcharges may apply to different fabric grades.**

A B J

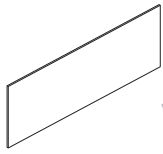

Open Market

Description

Tackboard for use with Wall Mount Storage

72"W x 5/8"D x 24 3/8"H

48"W x 5/8"D x 24 3/8"H

42"W x 5/8"D x 24 3/8"H

36"W x 5/8"D x 24 3/8"H

30"W x 5/8"D x 24 3/8"H

NOTES:

- For 60" Wall Mount Storage use Tackboard HVPTKW30 x 2
- For 66" Wall Mount Storage use Tackboard HVPTKW30 and HVPTKW36
- For 72" Wall Mount Storage use Tackboard HVPTKW72
- For 78" Wall Mount Storage use Tackboard HVPTKW36 and HVPTKW42
- For 84" Wall Mount Storage use Tackboard HVPTKW42 x 2
- For 90" Wall Mount Storage use Tackboard HVPTKW30 x 3
- For 96" Wall Mount Storage use Tackboard HVPTKW48 x 2
- For 102" Wall Mount Storage use Tackboard HVPTKW36 x 2 and HVPTKW30
- For 108" Wall Mount Storage use Tackboard HVPTKW36 x 3

Model

Ship Weight

Cube

List

HVPTKW72

30

5.8

\$ 372

HVPTKW48

28

5.4

\$ 317

HVPTKW42

26

4.9

\$ 299

HVPTKW36

24

4.5

\$ 268

HVPTKW30

16

2.8

\$ 268

How to specify

Select Model Number from above

H | V | P | T | K | W | 7 | 2 | .

1st Option

Select Fabric

See pages 310-311

A | P | N | 1 | 5 |

A B J



Icon Legend on page 10

▶ **NEW!** Centerpiece™ Series available January 2017.

▶ Full extension drawers allow complete and easy access to all contents.

▶ File drawers standard with hangrails.
▶ For removable lock core kits, see model HF27S on page 45.

⚠ **Bookcases, lateral files, and storage cabinets have an unfinished back panel; they are intended for use against a wall.**

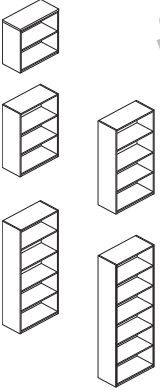
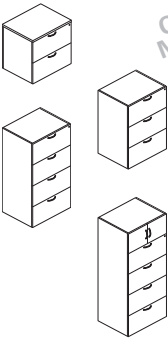
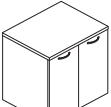

	Description	Model	Ship Weight	Cube	List
 Open Market	Mobile Pedestal, Box/File 15½"W x 21¾"D x 22½"H NOTES: Rolls easily on four casters (2 locking and 2 non-locking) to provide convenient, flexible placement of personal storage needs. Box and file locking storage drawers; interchangeable core removable lock makes re-keying quick and easy. Seat cushion model HPSEAT24ND is optional. Cushion adds 1" to the height of the pedestal. Unit with cushion will fit below 29½"H worksurfaces. Ship fully assembled.	HVPMPD2415-6WW	91	5.7	\$1285
 Open Market	Bookcase 30⅞"W x 14⅞"D x 29⅞"H, 2 Shelves 30"W x 14"D x 41⅞"H, 3 Shelves 30"W x 14"D x 55⅞"H, 4 Shelves 30"W x 14"D x 68¼"H, 5 Shelves 30"W x 14"D x 81¼"H, 6 Shelves 36⅞"W x 14⅞"D x 29⅞"H, 2 Shelves 36"W x 14"D x 41⅞"H, 3 Shelves 36"W x 14"D x 55⅞"H, 4 Shelves 36"W x 14"D x 68¼"H, 5 Shelves 36"W x 14"D x 81¼"H, 6 Shelves NOTES: All shelves are fixed. 6-shelf (81¼"H) bookcase must be attached to wall. 2-shelf models have a 1⅞" thick top; 3-, 4-, 5-, and 6-shelf models have a ¾" top. All units have an unfinished back. Ship fully assembled.	HVPBKN2H30-WW HVPBKN3H30-WW HVPBKN4H30-WW HVPBKN5H30-WW HVPBKN6H30-WW HVPBKN2H36-WW HVPBKN3H36-WW HVPBKN4H36-WW HVPBKN5H36-WW HVPBKN6H36-WW	74 101 127 152 212 94 121 152 177 237	10.5 14.5 19.0 23.1 27.4 12.5 17.1 22.4 27.3 32.3	\$1055 \$1137 \$1445 \$1695 \$1947 \$1107 \$1297 \$1610 \$1874 \$2041
 Open Market	Lateral File 30⅞"W x 24"D x 29⅞"H, 2 Drawers 30"W x 24"D x 41⅞"H, 3 Drawers 30"W x 24"D x 55⅞"H, 4 Drawers 30"W x 24"D x 68¼"H, 4 Drawers, 1 Cabinet 36⅞"W x 24"D x 29⅞"H, 2 Drawers 36"W x 24"D x 41⅞"H, 3 Drawers 36"W x 24"D x 55⅞"H, 4 Drawers 36"W x 24"D x 68¼"H, 4 Drawers, 1 Cabinet NOTES: Available with two-, three-, and four-drawers, plus four-drawers with a storage cabinet. Mechanical interlock inhibits the extension of more than one drawer from opening at a time. Includes counterweight to inhibit tipping. Drawers lock; interchangeable core removable lock makes re-keying quick and easy. Doors on 68¼"H do not lock. 2-drawer models have a 1⅞" thick top; 3- and 4-drawer models and the 4-drawer cabinet have a ¾" top. All units have an unfinished back. Ship fully assembled.	HVPLFS2H30-4WW HVPLFS3H30-4WW HVPLFS4H30-4WW HVPLFS5H30-4WW HVPLFS2H36-4WW HVPLFS3H36-4WW HVPLFS4H36-4WW HVPLFS5H36-4WW	156 201 58 291 179 230 281 332	16.6 23.0 30.0 36.7 19.7 27.2 35.5 43.3	\$1686 \$2340 \$4006 \$2620 \$1940 \$2919 \$4503 \$3001
 Open Market	Storage Cabinet 30⅞"W x 24"D x 29⅞"H 36⅞"W x 24"D x 29⅞"H NOTES: Includes one fixed shelf. Doors do not lock. All units have an unfinished back. Ship fully assembled.	HVPSCF2430-5WW HVPSCF2436-5WW	123 143	16.6 19.6	\$1446 \$1489

HVPSCF2430-5WW shown

How to specify	Select Model Number from above	1st Option Select Edge Profile	2nd Option Select Handle	3rd Option Select Finish
	H V P M P D 2 4 1 5 - 6 WW . G .	G Square Edge Only specify for models: HVPMPD2415-6WW, HVPBKN2H30-WW, HVPBKN2H36-WW, HVPLFS2H30-4WW, HVPLFS2H36-4WW	A Beam in Silver D Bridge in Silver Do NOT specify on bookcase models.	H Bourbon Cherry COGN Cognac C Harvest N Mahogany MOCH Mocha D Natural Maple PINC Pinnacle F Shaker Cherry

Icon Legend on page 10

▶ **NEW!** Centerpiece™ Series available January 2017.

▶ For removable lock core kits, see model HF27S on page 45.

⚠ **Models on this page have an unfinished back and are intended for use against a wall.**



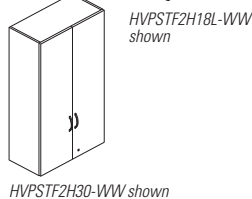

Description	Model	Ship		
		Weight	Cube	List
 Bookcase Hutch — Open — No Door(s) 18"W x 14"D x 39 1/8"H 30"W x 14"D x 39 1/8"H 36"W x 14"D x 39 1/8"H 18"W x 14"D x 52 1/16"H 30"W x 14"D x 52 1/16"H 36"W x 14"D x 52 1/16"H NOTES: 39 1/8"H unit has two shelves; 52 1/16"H unit has three shelves. Shelves are fixed. Secures to worksurface with double-sided adhesive tape. Units have an unfinished back and are intended for use against a wall. Ship assembled.	HVPSTN1H18-WN	56	8.7	\$ 914
	HVPSTN1H30-WN	92	13.7	\$1238
	HVPSTN1H36-WN	100	16.1	\$1333
	HVPSTN2H18-WN	70	11.3	\$1143
	HVPSTN2H30-WN	97	17.8	\$1548
	HVPSTN2H36-WN	111	21.1	\$1665

 Bookcase Hutch — Wood Door(s) 18"W x 14 3/4"D x 52 1/16"H, Hinged Right 18"W x 14 3/4"D x 52 1/16"H, Hinged Left 30"W x 14 3/4"D x 52 1/16"H 36"W x 14 3/4"D x 52 1/16"H NOTES: 3 fixed shelves. Secures to worksurface with double-sided adhesive tape. Standard with lock in satin (SA) finish. Units have an unfinished back and are intended for use against a wall. Ship assembled.	HVPSTF2H18R-WW	90	11.8	\$1498
	HVPSTF2H18L-WW	90	11.8	\$1498
	HVPSTF2H30-WW	126	18.6	\$1795
	HVPSTF2H36-WW	146	22.0	\$1947

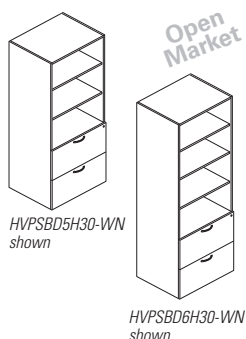

 Bookcase with Lateral File 30"W x 24"D x 68 1/4"H 30"W x 24"D x 81 1/4"H NOTES: Open bookcase above two lateral file drawers. Two height options. Shelves are fixed. Locking drawers; interchangeable core removable locks make re-keying quick and easy. All units have an unfinished back. Ship fully assembled.	HVPSBD5H30-WN	282	36.7	\$3380
	HVPSBD6H30-WN	328	43.3	\$3869



 Storage Cabinet with Lateral File 30"W x 24"D x 68 1/4"H 30"W x 24"D x 81 1/4"H NOTES: Hinged door cabinet above two lateral file drawers. Two height options. Cabinet on 68 1/4"H includes two shelves; 81 1/4"H has three shelves. Shelves are fixed. Locking doors and drawers; interchangeable core removable locks make re-keying quick and easy. All units have an unfinished back. Ship fully assembled.	HVPSBD5H30-WW	297	36.7	\$3657
	HVPSBD6H30-WW	343	43.3	\$4114

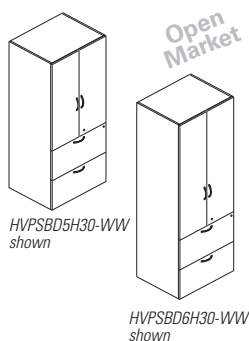

How to specify	1st Option	2nd Option
Select Model Number from above H V P S T F 2 H 1 8 R - W W . A .	Select Handle A Beam in Silver D Bridge in Silver Do NOT specify for Open Bookcase Hutch models	Select Finish H Bourbon Cherry COGN Cognac C Harvest N Mahogany H MOCH Mocha D Natural Maple PINC Pinnacle F Shaker Cherry

Icon Legend on page 10

► **NEW!** Centerpiece™ Series available January 2017.

► For removable lock core kits, see model HF27S on page 45.

⚠ **Models on this page have an unfinished back and are intended for use against a wall.**

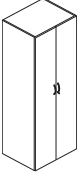
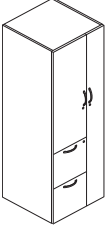

	Description	Model	Ship Weight	Cube	List
 <p>Open Market</p>	Wardrobe				
	15 ¹¹ / ₁₆ "W x 24"D x 68 ¹ / ₄ "H, Hinged Right	HVPCLS5H15R-WW	121	20.8	\$2232
	15 ¹¹ / ₁₆ "W x 24"D x 68 ¹ / ₄ "H, Hinged Left	HVPCLS5H15L-WW	121	20.8	\$2232
	18 ¹¹ / ₁₆ "W x 24"D x 81 ¹ / ₄ "H, Hinged Right (shown)	HVPCLS6H18R-WW	158	28.5	\$2543
	18 ¹¹ / ₁₆ "W x 24"D x 81 ¹ / ₄ "H, Hinged Left	HVPCLS6H18L-WW	158	28.5	\$2543
NOTES: Doors have lock; interchangeable core removable lock makes re-keying quick and easy. 68 ¹ / ₄ "H unit has a coat rod. 81 ¹ / ₄ "H size includes coat rod and 1 fixed shelf. All units have an unfinished back. Ship fully assembled.					
 <p>Open Market</p>	Wardrobe/Storage Cabinet				
	30"W x 24"D x 68 ¹ / ₄ "H	HVPCLD5H30-DW	238	36.7	\$3551
	30"W x 24"D x 81 ¹ / ₄ "H (shown)	HVPCLD6H30-DW	286	43.3	\$4373
NOTES: Mixed storage design features a wardrobe closet on the left and storage cabinet with shelves on the right. Two height options. 68 ¹ / ₄ "H unit has wardrobe and four 15"W shelves. 81 ¹ / ₄ "H size includes wardrobe and six 15"W shelves. All shelves are fixed. Doors have lock; interchangeable core removable lock makes re-keying quick and easy. Units have an unfinished back. Ship fully assembled.					
 <p>Open Market</p>	Storage Tower				
	24"W x 24"D x 68 ¹ / ₄ "H, Wardrobe Hinged Right, Cabinet and File/File Left (shown)	HVPUTC5H24R-WW	269	30.0	\$3910
	24"W x 24"D x 68 ¹ / ₄ "H, Wardrobe Hinged Left, Cabinet and File/File Right	HVPUTC5H24L-WW	269	30.0	\$3910
	24"W x 24"D x 81 ¹ / ₄ "H, Wardrobe Hinged Right, Cabinet and File/File Left	HVPUTC6H24R-WW	317	32.9	\$4471
	24"W x 24"D x 81 ¹ / ₄ "H, Wardrobe Hinged Left, Cabinet and File/File Right	HVPUTC6H24L-WW	317	32.9	\$4471
NOTES: Versatile design includes a wardrobe closet, storage cabinet, and two file drawers. Two height options. Wardrobe has full-height door and contains coat rod. Cabinet on 68 ¹ / ₄ "H includes two shelves; 81 ¹ / ₄ "H has three shelves. Shelves are fixed. Locking doors and drawers; interchangeable core removable locks make re-keying quick and easy. All units have an unfinished back. Ship fully assembled.					

How to specify	1st Option	2nd Option								
<p>Select Model Number from above</p> <p>H V P C L S 5 H 1 5 R - W W .</p>	<p>Select Handle</p> <p>A Beam in Silver D Bridge in Silver</p> <p>D .</p>	<p>Select Finish</p> <table border="0"> <tr> <td>H Bourbon Cherry</td> <td>MOCH Mocha</td> </tr> <tr> <td>COGN Cognac</td> <td>D Natural Maple</td> </tr> <tr> <td>C Harvest</td> <td>PINC Pinnacle</td> </tr> <tr> <td>N Mahogany</td> <td>F Shaker Cherry</td> </tr> </table> <p>C </p>	H Bourbon Cherry	MOCH Mocha	COGN Cognac	D Natural Maple	C Harvest	PINC Pinnacle	N Mahogany	F Shaker Cherry
H Bourbon Cherry	MOCH Mocha									
COGN Cognac	D Natural Maple									
C Harvest	PINC Pinnacle									
N Mahogany	F Shaker Cherry									

Icon Legend on page 10

▶ **NEW!** Centerpiece™ Series available January 2017.

▶ For worksurface supports and pedestals, see pages 36-41.

▶ 48"-72"W x 24"-30"D tops can be used with the Coordinate™ Height Adjustable Base (see page 38).

⚠ **Unsupported spans of greater than 48"W require a T-Support.**

⚠ **Worksurface connection bracket sold separately — see model HVPWBRK below.**

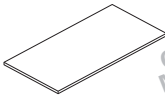

	Description	Model	Ship		
			Weight	Cube	List
 <p>Open Market</p>	Modular Desk Worksurface — Rectangle — Horizontal Woodgrain				
	72"W x 30"D	HVPDWRA3072-W	67	6.0	\$ 783
	66"W x 30"D	HVPDWRA3066-W	61	5.5	\$ 761
	60"W x 30"D	HVPDWRA3060-W	56	5.0	\$ 716
	54"W x 30"D	HVPDWRA3054-W	50	4.5	\$ 700
	48"W x 30"D	HVPDWRA3048-W	45	4.0	\$ 673

NOTES: Horizontal, side-to-side grain direction. Component tops do not include a flat bracket to connect adjoining worksurfaces; model HVPMDWBRK must be ordered separately. Can be used with 23¹/₈"D modular support pedestal. Grommets should not be specified over modular pedestals. Unsupported spans greater than 48"W require a T-Support. 48"-72"W x 30"D tops can be used with the Coordinate™ Height Adjustable Base.

 <p>Open Market</p> <p>HVPMWR2472-W shown</p>	Modular Credenza and Return Worksurface — Rectangle — Horizontal Woodgrain				
	108"W x 24"D	HVPMWR24108-W	78	7.8	\$1250
	102"W x 24"D	HVPMWR24102-W	72	7.4	\$1085
	96"W x 24"D	HVPMWR2496-W	68	7.0	\$ 951
	90"W x 24"D	HVPMWR2490-W	64	6.5	\$ 907
	84"W x 24"D	HVPMWR2484-W	60	6.1	\$ 860
	78"W x 24"D	HVPMWR2478-W	56	5.7	\$ 792
	72"W x 24"D	HVPMWR2472-W	52	5.3	\$ 725
	66"W x 24"D	HVPMWR2466-W	48	4.9	\$ 694
	60"W x 24"D	HVPMWR2460-W	44	4.4	\$ 671
	54"W x 24"D	HVPMWR2454-W	39	4.0	\$ 627
	48"W x 24"D	HVPMWR2448-W	35	3.6	\$ 587
	42"W x 24"D	HVPMWR2442-W	30	3.2	\$ 547
	36"W x 24"D	HVPMWR2436-W	26	2.7	\$ 532
30"W x 24"D	HVPMWR2430-W	22	2.3	\$ 512	

NOTES: Horizontal, side-to-side grain direction. Component tops do not include a flat bracket to connect adjoining worksurfaces; model HVPMDWBRK must be ordered separately. Grommets should not be specified over modular pedestals. Unsupported spans greater than 48"W require a T-Support. 48"-72"W x 24"D tops can be used with the Coordinate™ Height Adjustable Base.

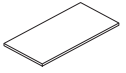
 <p>Open Market</p> <p>HVPDWRA2448V-W shown</p>	Modular Credenza, Return, and Bridge Worksurface — Rectangle — Vertical Woodgrain				
	48"W x 30"D	HVPDWRA3048V-W	30	3.2	\$ 673
	48"W x 24"D	HVPDWRA2448V-W	26	2.7	\$ 587
	42"W x 24"D	HVPDWRA2442V-W	22	2.3	\$ 547

NOTES: Vertical, front-to-back grain direction. Component tops do not include a flat bracket to connect adjoining worksurfaces; model HVPMDWBRK must be ordered separately. Unsupported spans greater than 48"W require a T-Support. Grommets should not be specified over modular pedestals. 48"W tops can be used with the Coordinate™ Height Adjustable Base.

 <p>Open Market</p>	Modular Worksurface Connection Bracket				
16 ¹ / ₂ "W x 3 ¹ / ₄ "D x 1 ¹ / ₈ "H	HVPWBRK	2	0.3	\$ 69	

NOTES: Flat brackets to connect adjoining worksurfaces. Component tops do not include a connection bracket; model HVPMDWBRK must be ordered separately. No need to specify.

SPECIFYING EXAMPLE: HVPWBRK

How to specify	1st Option	2nd Option	3rd Option
Select Model Number from above	Select Edge Profile	Select Grommet	Select Finish
	G Square Edge	GPL Grommet Black Left GPC Grommet Black Center GPR Grommet Black Right X No Grommet	H Bourbon Cherry COGN Cognac C Harvest N Mahogany MOCH Mocha D Natural Maple PINC Pinnacle F Shaker Cherry
H V P D W R A 3 0 7 2 - W .	G .	G P C .	C

Icon Legend on page 10

► **NEW!** Centerpiece™ Series available January 2017.

► Provide approach-side kneespace privacy for user.

⚠ **Modular modesty panels have veneer finish on both the user and approach sides.**

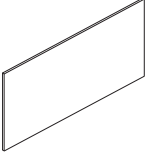

	Description	Model	Ship		List
			Weight	Cube	
 <i>HVPMCF60-W shown</i> Open Market	Modular Credenza Modesty Panel				
	For 108"W	HVPMCF108-W	53	8.9	\$ 944
	For 102"W	HVPMCF102-W	50	8.4	\$ 788
	For 96"W	HVPMCF96-W	47	8.0	\$ 685
	For 90"W	HVPMCF90-W	44	7.5	\$ 624
	For 84"W	HVPMCF84-W	41	7.0	\$ 567
	For 78"W	HVPMCF78-W	38	6.5	\$ 541
	For 72"W	HVPMCF72-W	35	6.0	\$ 514
	For 66"W	HVPMCF66-W	32	5.5	\$ 488
	For 60"W	HVPMCF60-W	29	5.1	\$ 463
NOTES: For use in modular credenza applications only. Widths 60"-108". Provide approach-side kneespace privacy for user seated at credenza. Formal, full-length, 27 ¹⁵ / ₁₆ "H panel extends from the underside of the worksurface to the floor. Veneer finish on both sides.					

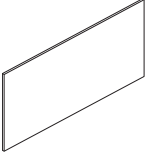
 <i>HVPMRF60-W shown</i> Open Market	Modular Return Modesty Panel				
	For 72"W	HVPMRF72-W	35	6.0	\$ 514
	For 66"W	HVPMRF66-W	32	5.6	\$ 488
	For 60"W	HVPMRF60-W	29	5.1	\$ 475
	For 54"W	HVPMRF54-W	26	4.6	\$ 450
	For 48"W	HVPMRF48-W	23	4.1	\$ 429
	For 42"W	HVPMRF42-W	20	3.6	\$ 408
NOTES: For use in modular return applications only. Widths 42"-72". Provide approach-side kneespace privacy for user seated at return. Formal, full-length, 27 ¹⁵ / ₁₆ "H panel extends from the underside of the worksurface to the floor. Veneer finish on both sides.					

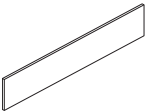
 <i>HVPDMHA60-W shown</i> Open Market	10" Hanging Modesty Panel				
	For 72"W	HVPDMHA72-W	13	1.9	\$ 604
	For 66"W	HVPDMHA66-W	12	1.8	\$ 580
	For 60"W	HVPDMHA60-W	11	1.6	\$ 549
	For 54"W	HVPDMHA54-W	9	1.4	\$ 521
For 48"W	HVPDMHA48-W	8	1.2	\$ 494	
NOTES: For use with 48"-72"W rectangle worksurfaces. Compatible with worksurfaces supported by the Coordinate™ Height Adjustable Electric Base. Secures to underside of worksurface; includes attachment hardware. Veneer finish on both sides.					

How to specify	1st Option								
Select Model Number from above H V P M C F 1 0 8 - W . N 	Select Finish <table border="0"> <tr> <td>H Bourbon Cherry</td> <td>MOCH Mocha</td> </tr> <tr> <td>COGN Cognac</td> <td>D Natural Maple</td> </tr> <tr> <td>C Harvest</td> <td>PINC Pinnacle</td> </tr> <tr> <td>N Mahogany</td> <td>F Shaker Cherry</td> </tr> </table>	H Bourbon Cherry	MOCH Mocha	COGN Cognac	D Natural Maple	C Harvest	PINC Pinnacle	N Mahogany	F Shaker Cherry
H Bourbon Cherry	MOCH Mocha								
COGN Cognac	D Natural Maple								
C Harvest	PINC Pinnacle								
N Mahogany	F Shaker Cherry								



Centerpiece™ Components — Supports

GSA SIN as Noted



- ▶ **NEW!** Centerpiece™ Series available January 2017.
- ▶ ¾", L- and T-Shaped end panels support the end of a component worksurface where there is no modular pedestal.

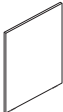
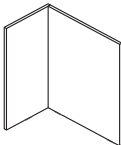

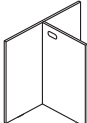
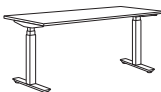
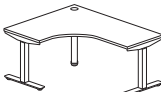
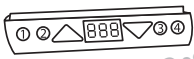
	Description	Model	Ship Weight	Cube	List
	<p>End Panel ¾"W x 23⅞"D x 28"H</p> <p>NOTES: Required for use with a full, 27⅕"H modesty panel.</p>	HVPMEP24-W	11.0	0.3	\$ 313
	<p>L-Shaped End Panel 15⅞"W x 23⅞"D x 28"H</p> <p>NOTES: Intended to be used in no modesty panel applications. Non-handed design.</p>	HVPMLS24-W	25.0	1.6	\$ 514
	<p>Support Brace ¾"W x 12"D x 28"H</p> <p>NOTES: Intermediate support required when a worksurface with a modesty panel has an unsupported span of greater than 48"W.</p>	HVPMSP12-W	9.0	0.1	\$ 171
	<p>T-Support Brace 8"W x 23¾"D x 28"H</p> <p>NOTES: Intermediate support required when a worksurface without a modesty panel has an unsupported span of greater than 48"W.</p>	HVPMSP13-W	9.0	0.6	\$ 311
	<p>T-Shaped End Panel 29⅞"W x 18"D x 28"H</p> <p>NOTES: T-Support can be used as an end support in peninsula-type applications or as a worksurface junction support.</p>	HVPM SJ24-W	20.0	2.2	\$ 484
 <i>Base shown with worksurface attached.</i>	<p>Height Adjustable Base – 3 Stage 24"D Feet and Worksurface Brackets</p> <p>NOTES: Support option for 24" and 30"D rectangle worksurfaces. Worksurfaces are ordered separately, see model listing on page 36.</p> <p>⚠ Available in silver finish only, no specification needed. Suggested coordinated paint, Platinum Metallic.</p>	HHAB3S24F E⚡	80.0	2.8	\$1250
 <i>Base shown with worksurface attached.</i>	<p>3-Leg Height Adjustable Base – 3 Stage 24"D Feet and Worksurface Brackets</p> <p>NOTES: Supports two rectangular worksurfaces to create a height-adjustable L-shaped configuration. Accepts worksurface sizes between 24"D x 48"W and 36"D x 72"W. Accommodates combined components comprising a maximum L-layout footprint of 6' x 6' (72"W x 72"D), examples include 72"W x 30"D with 42"W x 24"D and 72"W x 24"D with 48"W x 24"D.</p> <p>⚠ Available in silver finish only, no specification needed. Suggested coordinated paint, Platinum Metallic.</p>	HHAB3S3C24F E⚡	102.0	4.4	\$1700
	<p>Height Adjustable Base – Optional Memory Control</p> <p>⚠ Available in black finish only, no specification needed. Memory controller includes digital display and four memory presets.</p>	HHABMEM	0.5	0.4	\$ 75

How to specify	1st Option								
<p>Select Model Number from above</p> <p>H V P M E P 2 4 - W .</p>	<p>Select Finish</p> <table border="0"> <tr> <td>H Bourbon Cherry</td> <td>MOCH Mocha</td> </tr> <tr> <td>COGN Cognac</td> <td>D Natural Maple</td> </tr> <tr> <td>C Harvest</td> <td>PINC Pinnacle</td> </tr> <tr> <td>N Mahogany</td> <td>F Shaker Cherry</td> </tr> </table> <p>F</p>	H Bourbon Cherry	MOCH Mocha	COGN Cognac	D Natural Maple	C Harvest	PINC Pinnacle	N Mahogany	F Shaker Cherry
H Bourbon Cherry	MOCH Mocha								
COGN Cognac	D Natural Maple								
C Harvest	PINC Pinnacle								
N Mahogany	F Shaker Cherry								

Icon Legend on page 10

► **NEW!** Centerpiece™ Series available January 2017.

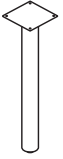
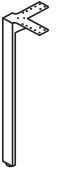
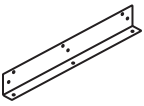

	Description	Model	Ship Weight	Cube	List
 <p><i>Open Market</i></p>	Support Column 3" Diameter NOTES: Available in powder coat black or silver.	HVPCOLUMN3	7	0.6	\$ 182
 <p><i>Open Market</i></p>	Table Leg 2 1/4"W x 2 1/4"D x 28"H NOTES: Light scale metal support. Available in powder coat black or silver.	HVPLEGMTL-LD	5	0.5	\$ 207
 <p><i>Open Market</i></p> <p>HVPWLBK24 shown</p>	Worksurface Wall Mount Bracket For 30" For 24" NOTES: Can be used in place of an end panel to support a worksurface. Cannot be used as a support when placing a stack-on storage unit on worksurface over bracket; must have two full-sized floor supports when using stack-on storage. Finish option not required. SPECIFYING EXAMPLE: HVPWLBK30	HVPWLBK30 HVPWLBK24	2 2	0.3 0.3	\$ 77 \$ 77

How to specify	Select Model Number from above H V P C O L U M N 3 .	1st Option Select Column Color PR6 Silver P Black P R 6
----------------	---	--

How to specify	Select Model Number from above H V P L E G M T L - L D .	1st Option Select Leg Color PR6 Silver P Black P
----------------	---	---

Icon Legend on page 10

▶ **NEW!** Centerpiece™ Series available January 2017.

▶ For removable lock core kits, see model HF27S on page 45.

⚠ **Pedestals are not fully enclosed and require a component top/worksurface and modesty panel or pedestal back, both of which must be ordered separately.**

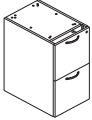
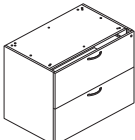
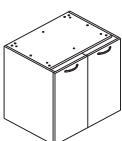
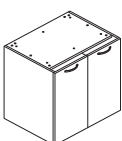

	Description	Model	Ship Weight	Cube	List
 <i>HVPMPW2415-3W shown</i>	<p>15¹¹/₁₆"W Pedestals 15¹¹/₁₆"W x 24"D x 28"H, Box/Box/File 15¹¹/₁₆"W x 24"D x 28"H, File/File</p> <p>NOTES: Non-handed, interchangeable design reconfigures easily. For use under 24" and 30"D rectangle worksurfaces; when used to support a 30"D top, there is a 6" approach-side overhang. Drawers lock; interchangeable core removable lock makes re-keying quick and easy. File drawers include hangrails to accept folders in letter or legal size. For use with component top and modesty/back panels. Pedestals are not fully enclosed and require a component top/worksurface and modesty panel or a pedestal back, both of which must be ordered separately. Ship fully assembled.</p>	HVPMPW2415-3W	100	7.5	\$1158
		HVPMPW2415-2W	100	7.5	\$1158
 <i>HVPMPW2415-2W shown</i>					
 <i>HVPMPW2436-4W shown</i>	<p>Lateral File Pedestal 30"W x 24"D x 28"H 36"W x 24"D x 28"H</p> <p>NOTES: Two locking file drawers; drawers include hangrails to accept folders in letter or legal size. For use under 24"D rectangle worksurface. Includes counterweight to inhibit tipping. Drawers lock; interchangeable core removable lock makes re-keying quick and easy. Top and back are open and require top and back panel components — ordered separately. Ship fully assembled.</p>	HVPMPW2430-4W	160	13.4	\$1280
		HVPMPW2436-4W	190	11.7	\$1455
 <i>HVPMPW2436-4W shown</i>					
 <i>HVPMPW2430-5W shown</i>	<p>Storage Cabinet Pedestal 30"W x 24"D x 28"H 36"W x 24"D x 28"H</p> <p>NOTES: Hinged door cabinet includes one fixed shelf. For use under 24"D rectangle worksurface. Doors do not lock. Top and back are open and require top and back panel components — ordered separately. Ship fully assembled.</p>	HVPMPW2430-5W	145	13.4	\$1148
		HVPMPW2436-5W	175	15.9	\$1323





How to specify	1st Option	2nd Option								
<p>Select Model Number from above</p> <p>H V P M P W 2 4 1 5 - 3 W . A .</p>	<p>Select Handle</p> <p>A Beam in Silver D Bridge in Silver</p>	<p>Select Finish</p> <table border="0"> <tr> <td>H Bourbon Cherry</td> <td>MOCH Mocha</td> </tr> <tr> <td>COGN Cognac</td> <td>D Natural Maple</td> </tr> <tr> <td>C Harvest</td> <td>PINC Pinnacle</td> </tr> <tr> <td>N Mahogany</td> <td>F Shaker Cherry</td> </tr> </table> <p>P I N C</p>	H Bourbon Cherry	MOCH Mocha	COGN Cognac	D Natural Maple	C Harvest	PINC Pinnacle	N Mahogany	F Shaker Cherry
H Bourbon Cherry	MOCH Mocha									
COGN Cognac	D Natural Maple									
C Harvest	PINC Pinnacle									
N Mahogany	F Shaker Cherry									

Icon Legend on page 10

► **NEW!** Centerpiece™ Series available January 2017.

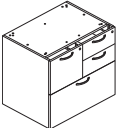
⚠ **Pedestal back panels have veneer finish on the user approach side.**

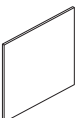
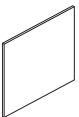

	Description	Model	Ship Weight	Cube	List
 <i>HVPMPW2430-MFLW shown</i>	<p>Multi File Pedestal 31½"W x 24"D x 28"H, Top File Drawer, Right 31½"W x 24"D x 28"H, Top File Drawer, Left</p> <p>NOTES: Versatile four drawer design features one lateral file, one vertical file, and two drawers for supplies. Units are handed left or right by top vertical file drawer location in relation to user. For use under 24"D rectangle worksurface. Drawers lock; interchangeable core removable lock makes re-keying quick and easy. Top and back are open and require top and back panel components — ordered separately. Ship fully assembled.</p>	HVPMPW2430-MFRW	160	13.8	\$1451
		HVPMPW2430-MFLW	160	13.8	\$1451
 <i>HVPMBP15-W shown</i>	<p>Pedestal Back Panel For 15"W For 30"W For Multi File For 36"W</p> <p>NOTES: Veneer finished panel encloses the rear of modular support pedestals, which come standard with an open, unfinished back. 15" model for use with box/box/file or file/file pedestal. 30" model for use with lateral file or hinged door pedestal. 36" model for use with lateral file or hinged door pedestal. MF model for use with multi file pedestal.</p>	HVPMBP15-W	7	1.5	\$ 318
		HVPMBP30-W	14	2.7	\$ 337
		HVPMBP30-MFW	14	2.8	\$ 337
		HVPMBP36-W	17	3.1	\$ 366
 <i>HVPMBP30-W shown</i>					
 <i>HVPMBP30-MFW shown</i>					
 <i>HVPMPF-W shown</i>	<p>Filler Strip 7½"W x ¾"D</p> <p>NOTES: Suggested to be used when pedestal, without a finished back panel, is positioned against a wall; strip fills gap between pedestal and wall.</p>	HVPMPF-W	1	0.8	\$ 57

How to specify	1st Option	2nd Option								
<p>Select Model Number from above</p> <p>H V P M P W 2 4 3 0 - M F R W . A .</p>	<p>Select Handle</p> <p>A Beam in Silver D Bridge in Silver</p>	<p>Select Finish</p> <table border="0"> <tr> <td>H Bourbon Cherry</td> <td>MOCH Mocha</td> </tr> <tr> <td>COGN Cognac</td> <td>D Natural Maple</td> </tr> <tr> <td>C Harvest</td> <td>PINC Pinnacle</td> </tr> <tr> <td>N Mahogany</td> <td>F Shaker Cherry</td> </tr> </table> <p>P I N C</p>	H Bourbon Cherry	MOCH Mocha	COGN Cognac	D Natural Maple	C Harvest	PINC Pinnacle	N Mahogany	F Shaker Cherry
H Bourbon Cherry	MOCH Mocha									
COGN Cognac	D Natural Maple									
C Harvest	PINC Pinnacle									
N Mahogany	F Shaker Cherry									

How to specify	1st Option								
<p>Select Model Number from above</p> <p>H V P M B P 1 5 - W .</p> <p>H V P M P F - W .</p>	<p>Select Finish</p> <table border="0"> <tr> <td>H Bourbon Cherry</td> <td>MOCH Mocha</td> </tr> <tr> <td>COGN Cognac</td> <td>D Natural Maple</td> </tr> <tr> <td>C Harvest</td> <td>PINC Pinnacle</td> </tr> <tr> <td>N Mahogany</td> <td>F Shaker Cherry</td> </tr> </table> <p>M O C H</p> <p>M O C H</p>	H Bourbon Cherry	MOCH Mocha	COGN Cognac	D Natural Maple	C Harvest	PINC Pinnacle	N Mahogany	F Shaker Cherry
H Bourbon Cherry	MOCH Mocha								
COGN Cognac	D Natural Maple								
C Harvest	PINC Pinnacle								
N Mahogany	F Shaker Cherry								

Icon Legend on page 10

Centerpiece™ Conference Tables

GSA SIN as Noted



▶ **NEW!** Centerpiece™ Series available January 2017.

▶ Tops and bases are ordered separately and shipped in separate cartons.
▶ Occasional Tables are shown on page 44.

⚠ **If cord grommets are specified in a rectangle table top, pop-up power port model HTPWRGROM1 must be specified and ordered separately.**

⚠ **If cord grommets are specified in rectangle or round tops, the 18" Diameter cylinder base with cord management access door — model HVPWCYL18WM — must be used.**

⚠ **For table bases, use listings on page 43 only.**

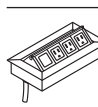

Description	Model	Ship Weight	Cube	List
 <p>Rectangle Conference Table Top 144"L x 48"W — 2 pieces 120"L x 48"W — 2 pieces 96"L x 48"W — 1 piece</p> <p>Open Market</p> <p>HPVTRT48120-W shown</p> <p>HPVTRT4896-W shown</p> <p>NOTES: Grain direction — 96"L x 48"W — long grain (end-to-end), 120"L x 48"W — short grain (side-to-side), 144"L x 48"W — short grain (side-to-side). Model HTPWRGROM1 must be specified separately when tops are ordered with "G1" cutout for grommets — 96"L x 48"W — specify (1) HTPWRGROM1, 120"L x 48"W — specify (2) HTPWRGROM1, 144"L x 48"W — specify (2) HTPWRGROM1.</p>	HVPTRT48144-W	320	19.5	\$3659
	HVPTRT48120-W	290	16.3	\$2934
	HVPTRT4896-W	260	13.2	\$2253
 <p>Pop-up Port</p> <ul style="list-style-type: none"> Fits into 4" x 8" cutout. Specify G1 cutout in table top. Pop-up Port provides three power ports and one blank data receptacle. Sits flush with worksurface when closed. Finish is anodized aluminum. Includes 6' cord with three-prong plug. <p>SIN 711-11</p>	HTPWRGROM1	5	0.3	\$ 343

 <p>Open Market</p> <p>HVPTRD42-W shown</p>	Round Top				
	48" Diameter	HVPTRD48-W	80	6.8	\$1699
	42" Diameter	HVPTRD42-W	70	5.3	\$1427
	36" Diameter	HVPTRD36-W	60	4.0	\$1250
<p>NOTES: When grommet option is specified, 3" diameter black grommet is included and positioned in middle of top. For 3" grommet mount options, see the power hub (HGRMTAC) and power/USB hub (HGRMTUSB2) models on page 46.</p>					

How to specify	1st Option	2nd Option	3rd Option
<p>Select Model Number from above</p> <p>H V P T R T 4 8 1 4 4 - W .</p>	<p>Select Edge Profile</p> <p>G Square Edge</p> <p>G .</p>	<p>Select Grommet</p> <p>G1 4" x 8" Grommet Cutouts X No Grommet</p> <p>X .</p>	<p>Select Finish</p> <p>H Bourbon Cherry COGN Cognac C Harvest N Mahogany</p> <p>MOCH Mocha D Natural Maple PINC Pinnacle F Shaker Cherry</p> <p>P I N C</p>

How to specify	1st Option	2nd Option	3rd Option
<p>Select Model Number from above</p> <p>H V P T R D 4 8 - W .</p>	<p>Select Edge Profile</p> <p>G Square Edge</p> <p>G .</p>	<p>Select Grommet</p> <p>GP Grommet Black X No Grommet</p> <p>G P .</p>	<p>Select Finish</p> <p>H Bourbon Cherry COGN Cognac C Harvest N Mahogany</p> <p>MOCH Mocha D Natural Maple PINC Pinnacle F Shaker Cherry</p> <p>C O G N</p>





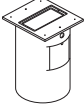
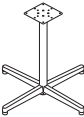

Icon Legend on page 10

► **NEW!** Centerpiece™ Series available January 2017.

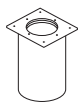
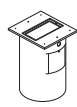
⚠ **If cord grommets are specified in rectangle or round conference table tops, the 18" Diameter cylinder base with cord management access door — model HVPWCYL18WM — must be used.**

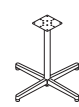
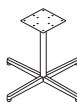
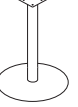

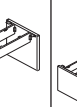
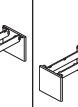
	Description	Model	Ship Weight	Cube	List
 <i>Open Market</i> HVPWCYL18WM shown	Cylinder Base 18" Diameter 18" Diameter, with Cord Management Access Door NOTES: Available with and without cord management access door.	HVPWCYL18 HVPWCYL18WM	50.0 50.0	7.7 7.7	\$1317 \$2333
	Panel Base 58"W x 30"D x 27¾"H 82"W x 30"D x 27¾"H 106"W x 30"D x 27¾"H NOTES: Veneer panel bases feature dual support beams; field assembly required.	HVPWSL4896 HVPWSL48120 HVPWSL48144	108.0 124.0 142.0	4.1 5.3 5.3	\$3436 \$4287 \$4501
 <i>Open Market</i>	Metal X-Base For 36" and 42" Round Tops For 48" Round Tops NOTES: X-base column is 2¼" diameter.	HVPBSMTL33X-LD HVPBSMTL38X-LD	22.0 23.0	23.3 30.1	\$ 693 \$ 743
	Metal Disc Base For 36" Round Tops For 42" and 48" Round Tops, and Rectangle Conference Tops NOTES: Metal disc base available with 18" and 24" bottom plate; vertical column is 4" diameter.	HVPMDISC18-LD HVPMDISC24-LD	7.9 13.0	31.0 45.0	\$ 740 \$ 867

											
		18" Diameter Cylinder Base	18" Diameter Cylinder Base with Cord Management Access Door	2¼"W x 2¼"D x 28"H Table Leg	33"D Metal X-Base	38"D Metal X-Base	18" Diameter Disc Base	24" Diameter Disc Base	58"W Panel Base	82"W Panel Base	106"W Panel Base
		HVPWCYL18	HVPWCYL18WM	HVPLEGMTL-LD	HVPBSMTL33X-LD	HVPBSMTL38X-LD	HVPMDISC18-LD	HVPMDISC24-LD	HVPWSL4896	HVPWSL48120	HVPWSL48144
HVPTRD36-W	36" Dia Round Top	1	1	4	1		1				
HVPTRD42-W	42" Dia Round Top	1	1	4	1			1			
HVPTRD48-W	48" Dia Round Top	1	1	4		1		1			
HVPTRT4896-W	96"L x 48"W Rectangle Top — 1 piece	2	2					2	1		
HVPTRT48120-W	120"L x 48"W Rectangle Top — 2 pieces	3	3					3		1	
HVPTRT48144-W	144"L x 48"W Rectangle Top — 2 pieces	3	3					3			1

How to specify	Select Model Number from above H V P W C Y L 1 8 .	1st Option Select Finish H Bourbon Cherry MOCH Mocha COGN Cognac D Natural Maple C Harvest PINC Pinnacle N Mahogany F Shaker Cherry H
----------------	---	--

How to specify	Select Model Number from above H V P B S M T L 3 3 X - L D .	1st Option Select Leg Color PR6 Silver P Black P R 6
----------------	---	---

Icon Legend on page 10

Centerpiece™ Buffet Credenza

Not on GSA Contract



► **NEW!** Centerpiece™ Series available January 2017.

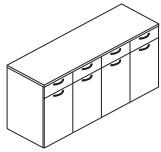

Open Market

HVPCBF2474-WW shown

Description	Model	Ship Weight	Cube	List
Buffet Credenza 24"W x 73 ³ / ₈ "D x 34 ³ / ₁₆ "H NOTES: Worksurface positioned at buffet height for easy reach. Includes one fixed shelf behind each set of doors. Drawers and doors do not lock.	HVPCBF2474-WW	365	35.1	\$4013

Centerpiece™ Occasional Tables

Not on GSA Contract

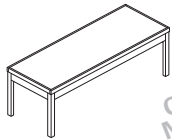

HVPTO2448L16 shown



HVPTO2424L16 shown



HVPTO2424L21 shown

Open Market

Description	Model	Ship Weight	Cube	List
Occasional Tables				
48"L x 24"W x 16"H, Coffee Table	HVPTO2448L16	51	15.1	\$1480
24"L x 24"W x 16"H, In-Line Table	HVPTO2424L16	30	8.0	\$1199
24"L x 24"W x 21"H, End Table	HVPTO2424L21	41	10.1	\$1268
NOTES: Selection features a coffee table and two side tables. Legs are constructed of solid hardwood. Legs are attached to table with steel corner brackets and lag bolts. Metal tack glides are standard. Legs require customer attachment.				

How to specify	1st Option	2nd Option	3rd Option
Select Model Number from above H V P C B F 2 4 7 4 - WW .	Select Edge Profile G Square Edge	Select Handle A Beam in Silver D Bridge in Silver	Select Finish H Bourbon Cherry COGN Cognac C Harvest N Mahogany MOCH Mocha D Natural Maple PINC Pinnacle F Shaker Cherry
	G .	D .	D

How to specify	1st Option
Select Model Number from above H V P T O 2 4 2 4 L 1 6 .	Select Finish H Bourbon Cherry COGN Cognac C Harvest N Mahogany MOCH Mocha D Natural Maple PINC Pinnacle F Shaker Cherry
	N

Icon Legend on page 10

► **NEW!** Centerpiece™ Series available January 2017.

- For keyed alike locks:
 - Order standard product which will be shipped with factory installed locks and random numbered cores.
 - Order the appropriate quantity of like numbered cores required for each workstation or keyed area.
 - Simply replace the factory installed cores with the replacement cores after product has been installed.
- To install new core:
 - Lock must be in the unlocked position.
 - Insert core removal key and pull core straight out.
 - Insert new core with core removable key, hold core into lock and withdraw core removal key.
 - Retain original core for future use.
- To provide normal lead times, key numbers cannot be specified on HON products at time of order. This also eliminates need for tagging and tracking each product's lock number during installation.

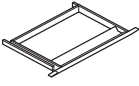
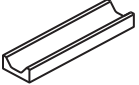
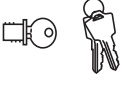

	Description	Model	Ship Weight	Cube	List
 Open Market	Center Drawer 26"W x 22"D x 2 1/4"H NOTES: Inside drawer dimensions: 20 1/16"W x 11 7/16"D x 1 1/2"H. Minimum clearance for mounting: 25 5/8"W x 19"D x 2 1/4"H. For use with desks, peninsulas, credenzas, and returns. Ball-bearing slide suspensions. Includes pencil tray. Specify finish.	HVPACCD26	20.0	2.3	\$ 489
 Open Market	Pencil Tray 12 2/32"W x 3"D x 1 1/4"H NOTES: Designed for use inside box drawers. SPECIFYING EXAMPLE: HVPPT15	HVPPT15	1.0	0.2	\$ 66
 Open Market	Removable Lock Core Kit Satin • Specify quantity of each key number from 101E to 225E. • Includes: 1-core, 2-keys, 1-core removal tool, and instructions. NOTES: If key number isn't specified, number will be at random.	HF27S	0.2	0.02	\$ 28

HOW TO ORDER CORE REMOVABLE LOCK KITS:

Specify: Model Number.X
Key Number

Examples: HF27S.X121E
HF27S.X (Key number not specified)

NOTES: Key orders without numbers specified will be keyed at random.
Numbers 101E-225E are available.

SAMPLE ORDER:

Quantity	Model	Key Code
4	HF27S.	X121E

How to specify	1st Option								
Select Model Number from above H V P A C C D 2 6 .	Select Finish <table border="0"> <tr> <td>H Bourbon Cherry</td> <td>MOCH Mocha</td> </tr> <tr> <td>COGN Cognac</td> <td>D Natural Maple</td> </tr> <tr> <td>C Harvest</td> <td>PINC Pinnacle</td> </tr> <tr> <td>N Mahogany</td> <td>F Shaker Cherry</td> </tr> </table>	H Bourbon Cherry	MOCH Mocha	COGN Cognac	D Natural Maple	C Harvest	PINC Pinnacle	N Mahogany	F Shaker Cherry
H Bourbon Cherry	MOCH Mocha								
COGN Cognac	D Natural Maple								
C Harvest	PINC Pinnacle								
N Mahogany	F Shaker Cherry								



- ▶ Task lights are designed for use with stack-on storage and wall mounted storage cabinets.
- ▶ Task lights feature a new slim profile and electronic ballast for increased energy efficiency.



Open Market

Description**Model****Ship Weight****Cube****List****Recessed Task Lights — For Stack-on and Wall Mounted Storage Cabinets**

- Color: Black.
- Slim profile design.
- Mount to stack-on storage and wall mounted storage cabinets (see pages 135-136 and 147).
- Electronic ballast for increased energy efficiency.
- T5 bulb, included, which contains less mercury.
- 9-foot black cord and switch off right rear corner.

22⁷/₈"W x 3¹¹/₁₆"D x 1¹/₈"H

Chicago code version (with fused plug)

HH870930

7.0

0.60

\$ 205

34⁵/₈"W x 3¹¹/₁₆"D x 1¹/₈"H

Chicago code version (with fused plug)

HH870930CH

7.0

0.60

\$ 268

HH870942

10.0

0.90

\$ 222

HH870942CH

10.0

0.90

\$ 282

46¹/₂"W x 3¹¹/₁₆"D x 1¹/₈"H

Chicago code version (with fused plug)

HH870960

12.0

1.10

\$ 240

HH870960CH

12.0

1.10

\$ 300

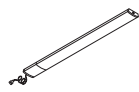

SIN 711-1

LED Task Lights — For Stack-on and Wall Mounted Storage Cabinets

17" LED Light with Power Supply (Single)

31" LED Light with Power Supply (Single)

17" LED Light with Power Supply for Daisy-chain (Starter)

31" LED Light with Power Supply for Daisy-chain (Starter)

17" LED Light with 8" Jumper Cord for Daisy-chain (Follower)

31" LED Light with 8" Jumper Cord for Daisy-chain (Follower)

Undercabinet Occupancy Sensor with 1" End to End Connector

NOTES: To use the daisy chain application, must start with model HLED17A or HLED31A. No finish specification required. Attaches magnetically to underside of overhead storage, or attaches with provided screws or double-sided tape. Occupancy sensor attaches to a single or starter LED light and will automatically turn the light off after no motion is detected for 30 minutes. Just like all the LED light models, the occupancy sensor features a soft-touch on/off switch. LED task lights have a lifetime of 50,000 hours and have a dimmer feature that allows the user to adjust the amount of light output.

HLED17AS

1.2

0.05

\$ 374

HLED31AS

1.5

0.09

\$ 503

HLED17A

1.0

0.05

\$ 411

HLED31A

1.4

0.09

\$ 553

HLED17AUO

1.0

0.03

\$ 335

HLED31AUO

1.0

0.05

\$ 448

HLEDOSA

0.2

0.01

\$ 78



SIN 711-1

Articulating Desk Lamp

Articulating Desk Lamp w/ Occupancy Sensor

HLED1

1.2

6.5

\$ 350

HLED10C

1.2

6.5

\$ 428



SIN 711-1

Task Desk Lamp**HLED2**

0.7

3.0

\$ 303

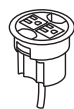

SIN 71-302

Power Hub, 3" Grommet Mount

- Brings the ease of plug-and-play to the desktop.
- Fits in 3" round grommet holes.
- Two grounded AC power outlets.
- Two cord pass-through holes in cap.
- Includes 6' cord with three-prong plug.
- UL Listed.

HGRMTAC

1.3

0.2

\$ 100

▲ Available in black only (no color designation so use .X – Specify: HGRMTAC.X).

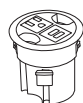

Open Market

Power/USB Hub, 3" Grommet Mount

- Brings the ease of plug-and-play to the desktop.
- Fits in 3" round grommet holes.
- One grounded AC power outlet and 2 USB ports.
- Two cord pass-through holes in cap.
- Includes 6' cord with three-prong plug.
- UL Listed.

HGRMTUSB2

1.3

0.2

\$ 198

▲ Available in black only (no color designation so use .X – Specify: HGRMTUSB2.X).

How to specify

Select Model Number
from above

H | H | 8 | 7 | 0 | 9 | 3 | 0



Icon Legend on page 10

Laminate Desks Ordering Information

▶ Edge banding on patterned laminates matches the laminate base selected.

▶ For 10500 Series™ worksurface models, the finish specification options include matching the top and edge band colors or choosing a two-tone combination.

▶ LAMINATE DESKS
SPECIFY: Model Number.
Laminate
EXAMPLE: H105413.NN
▶ WORKSURFACES
SPECIFY: Model Number.
Top Laminate
Edgeband

▶ All specifications in this publication are based on the latest product information available at the time of print.

△ Tops with a patterned color are not available with a matching edge band.

Laminate Finishes Availability — Laminate Desks

		Park Avenue Laminate ©	Valido/11500 ©	10700 ©	10500 ©	94000
L1 LAMINATES		CODES				
Woodgrain	Bourbon Cherry	HH	•	•	•	•
	Cognac	COGNCOGN	•	•	•	•
	Harvest	CC	•	•	•	•
	Mahogany	NN	•	•	•	•
	Mocha	MOCHMOCH	•	•	•	•
	Natural Maple	DD	•	•	•	•
	Pinnacle	PINCPINC	•	•	•	•
	Shaker Cherry	FF	•	•	•	•
Solid	Black	PP		•		•
	Brilliant White	WHITWHIT		•		•
	Charcoal	SS		•		•
	Loft NEW! 1/2/2017	LOFT				•
Patterned Top	Grey Tigris	L6(*)		•		•
	Sheer Mesh	A5(*)		•		•
	Silver Mesh	B9(*)		•		•
	Canyon Zephyr	K9(*)		•		•
	Desert Zephyr	K8(*)		•		•
L2 LAMINATES		CODES				
Woodgrain	Lowell Ash NEW! 1/30/2017	LLA1				•
	Natural Recon NEW! 1/30/2017	LNR1				•
	Phantom Ecu NEW! 1/30/2017	LPE1				•
	Portico Teak NEW! 1/30/2017	LPT1				•
	Skyline Walnut NEW! 1/30/2017	LSW1				•

Must specify both top and edgeband options for worksurfaces. First laminate designator is for the worksurface color, the second is for the edge color.
SPECIFYING EXAMPLE: H105B3072.NN

(*) Patterned top laminates are available with the following base/edge banding laminate selection: C, COGN, D, F, H, LOFT, MOCH, N, P, PINC, S, or WHIT.
Edge banding will match base laminate selected.

SPECIFYING EXAMPLE: H105413.L6N

The following 10500 Series™ products are not available as two-tone and require only one color code:

- Modular pedestals — box/file, box/box/file, file/file, lateral file, multi file, and cabinet (also applies to Valido/11500 Series).
- Access strip and end panel kits
- Modesty panel for peninsulas
- Back enclosures
- Wall mounted open shelf
- Reception stations for return
- T-shaped end panels
- L-shaped end panels

Patterned Top

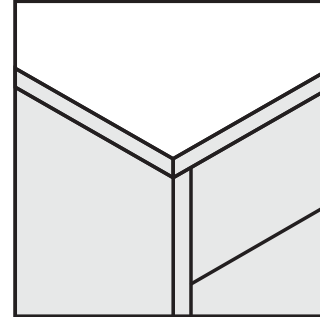

Edge Band Around Top / Laminate Base

▶ Edge banding on two-tone laminates matches top, base is a different laminate color.

▶ A complete selection of Conference Room and Occasional Tables is shown under Tables on pages 643-646 and 655-669.

▶ LAMINATE DESKS SPECIFY: Model Number. Laminate EXAMPLE: H10596.HP

▶ All specifications in this publication are based on the latest product information available at the time of print.

Laminate Finishes Availability — Laminate Desks

		Valid to 11500 ©	10500 ©
L1 LAMINATES		CODES	
Two-Tone Top/Base	Black/Brilliant White	PWHIT	• •
	Black/Charcoal	PS	• •
	Black/Loft NEW! 1/30/2017	PLOFT	• •
	Bourbon Cherry/Black	HP	• •
	Bourbon Cherry/Brilliant White	HWHIT	• •
	Bourbon Cherry/Charcoal	HS	• •
	Bourbon Cherry/Loft NEW! 1/30/2017	HLOFT	• •
	Brilliant White/Black	WHITP	• •
	Brilliant White/Bourbon Cherry	WHITH	• •
	Brilliant White/Charcoal	WHITS	• •
	Brilliant White/Cognac	WHITCOGN	• •
	Brilliant White/Harvest	WHITC	• •
	Brilliant White/Loft NEW! 1/30/2017	WHITLOFT	• •
	Brilliant White/Mahogany	WHITN	• •
	Brilliant White/Mocha	WHITMOCH	• •
	Brilliant White/Natural Maple	WHITD	• •
	Brilliant White/Pinnacle	WHITPINC	• •
	Brilliant White/Shaker Cherry	WHITF	• •
	Charcoal/Black	SP	• •
	Charcoal/Brilliant White	SWHIT	• •
	Charcoal/Loft NEW! 1/30/2017	SLOFT	• •
	Cognac/Black	COGNP	• •
	Cognac/Brilliant White	COGNWHIT	• •
	Cognac/Charcoal	COGNS	• •
	Cognac/Loft NEW! 1/30/2017	COGNLOFT	• •
	Harvest/Black	CP	• •
	Harvest/Brilliant White	CWHIT	• •
	Harvest/Charcoal	CS	• •
	Harvest/Loft NEW! 1/30/2017	CLOFT	• •
	Loft/Black NEW! 1/30/2017	LOFTP	• •
	Loft/Brilliant White NEW! 1/30/2017	LOFTWHIT	• •
	Loft/Charcoal NEW! 1/30/2017	LOFTS	• •
	Mahogany/Black	NP	• •
	Mahogany/Brilliant White	NWHIT	• •
	Mahogany/Charcoal	NS	• •
	Mahogany/Loft NEW! 1/30/2017	NLOFT	• •
	Mocha/Black	MOCHP	• •
	Mocha/Brilliant White	MOCHWHIT	• •
	Mocha/Charcoal	MOCHS	• •
	Mocha/Loft NEW! 1/30/2017	MOCHLOFT	• •
	Natural Maple/Black	DP	• •
	Natural Maple/Brilliant White	DWHIT	• •
	Natural Maple/Charcoal	DS	• •
	Natural Maple/Loft NEW! 1/30/2017	DLOFT	• •
	Pinnacle/Black	PINCP	• •
Pinnacle/Brilliant White	PINCWHIT	• •	
Pinnacle/Charcoal	PINCS	• •	
Pinnacle/Loft NEW! 1/30/2017	PINCLOFT	• •	
Shaker Cherry/Black	FP	• •	
Shaker Cherry/Brilliant White	FWHIT	• •	
Shaker Cherry/Charcoal	FS	• •	
Shaker Cherry/Loft NEW! 1/30/2017	FLOFT	• •	
L2 LAMINATES		CODES	
Two-Tone Top/Base	Brilliant White/Lowell Ash NEW! 1/30/2017	WHITLLA1	• •
	Brilliant White/Natural Recon NEW! 1/30/2017	WHITLNR1	• •
	Brilliant White/Phantom Ecru NEW! 1/30/2017	WHITLPE1	• •
	Brilliant White/Portico Teak NEW! 1/30/2017	WHITLPT1	• •
	Brilliant White/Skyline Walnut NEW! 1/30/2017	WHITLSW1	• •
	Lowell Ash/Black NEW! 1/30/2017	LLA1P	• •
	Lowell Ash/Brilliant White NEW! 1/30/2017	LLA1WHIT	• •
	Lowell Ash/Charcoal NEW! 1/30/2017	LLA1S	• •
	Lowell Ash/Loft NEW! 1/30/2017	LLA1LOFT	• •
	Natural Recon/Black NEW! 1/30/2017	LNR1P	• •
	Natural Recon/Brilliant White NEW! 1/30/2017	LNR1WHIT	• •
	Natural Recon/Charcoal NEW! 1/30/2017	LNR1S	• •
	Natural Recon/Loft NEW! 1/30/2017	LNR1LOFT	• •
	Phantom Ecru/Black NEW! 1/30/2017	LPE1P	• •
	Phantom Ecru/Brilliant White NEW! 1/30/2017	LPE1WHIT	• •
	Phantom Ecru/Charcoal NEW! 1/30/2017	LPE1S	• •
	Phantom Ecru/Loft NEW! 1/30/2017	LPE1LOFT	• •
	Portico Teak/Black NEW! 1/30/2017	LPT1P	• •
	Portico Teak/Brilliant White NEW! 1/30/2017	LPT1WHIT	• •
	Portico Teak/Charcoal NEW! 1/30/2017	LPT1S	• •
	Portico Teak/Loft NEW! 1/30/2017	LPT1LOFT	• •
	Skyline Walnut/Black NEW! 1/30/2017	LSW1P	• •
	Skyline Walnut/Brilliant White NEW! 1/30/2017	LSW1WHIT	• •
	Skyline Walnut/Charcoal NEW! 1/30/2017	LSW1S	• •
	Skyline Walnut/Loft NEW! 1/30/2017	LSW1LOFT	• •

Two-Tone Laminate Top / Edge Banding

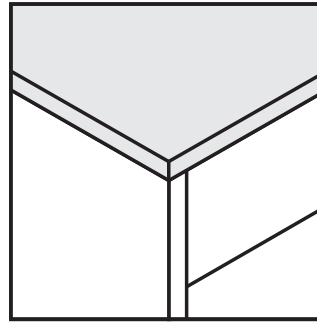

Laminate Base

Two-tone laminates: Top and edge banding are the same, base is different laminate color. The following 10500 Series™ products are not available as two-tone. They are one color and require only one color code:

- Modular pedestals — box/file, box/box/file, file/file, lateral file, multi file, and cabinet (also applies to Valido/11500 Series).
- Access strip and end panel kits
- Back enclosures
- Wall mounted open shelf
- Reception stations for return
- T-shaped end panels
- L-shaped end panels

Storage chassis that are specified in L2 laminates and are longer than 60"W will ship with back panels that are horizontal grain.

Features Offered on HON Laminate Casegoods

	10500	10700	Valido	Park Avenue	Concinnity	94000
Worksurfaces						
• Scratch, stain and spill-resistant surface over durable 1/8" solid core high performance particleboard	•	•		•	•	
• Scratch, stain and spill-resistant surface over extra-thick 1/2" solid core high performance particleboard			•			
• Scratch, stain and spill-resistant high gloss surface over durable 1/8" solid core high performance particleboard						•
• Contoured hardwood accent trim		•				•
• User-friendly waterfall-shaped edges and rounded corners improves worker comfort		•				
• Edge profile options				•	•	
Chassis Construction						
• European-designed fastening system – Precision, metal-to-metal, fasteners eliminate need for external cleats or exposed screws; enables tops or end panels to be interchanged or replaced	•	•	•	•	•	•
• Inner frame constructed using mortise and tenon joinery for superior structural strength and precisely positioning/securing the pedestal to the modesty panel; endures frequent moving/handling; ensures a longer product life cycle.	•	•	•			•
• All fasteners and dowels are positioned by computer to maintain rigorous dimensional standards	•	•	•	•	•	•
• End panels on base units and stack-ons feature PVC bottom edge banding for added strength and to seal out moisture	•	•	•	•	•	•
Drawer Construction						
• Steel ball-bearing drawer suspensions for smooth, quiet, long-lasting operation	•	•	•	•	•	•
• 5-sided drawer construction for added strength and easy alignment or replacement of drawer fronts	•	•	•	•	•	•
• Full extension box and file drawers	•	•	•	•	•	•
• Hangrails provided in all file drawers for side-to-side letter, legal, A4 or EDP filing; and front-to-back for letter filing	•	•	•	•	•	•
Amenities						
• Conference overhang (select models) provides visitor's kneespace on approach side of desk for meetings	•	•	•	•	•	•
• Formal, full height modesty panels	•	•	•	•	•	•
• Short modesty panel option for easy access to wall electrical outlets	•	•	•		•	
• Patented, side-mounted drawer handles provide good ergonomics and clean appearance	•	•				
• Antique brass drawer handles						•
• Decorative drawer/door handle design and finish options			•	•	•	
• Vertical grain direction on drawer fronts and modesty panels				•	•	•
• Upscale mixed material door options (select models) on overhead storage	•	•	•	•	•	•
• Adjustable hex leveling glides to level furniture without lifting	•	•		•	•	•
• Pullout reference/writing shelf provides additional worksurface space						•
• Interchangeable lock cores (allow multiple units to be keyed alike)	•	•	•	•	•	•
• Central locking on desks (one lock secures all drawers)						•
• Cord management (standard) to route and hide wires and cables	•	•	•	•	•	•
• Cord management options on modular components (worksurfaces, end and modesty panels, pedestals)					•	
Configuration Options						
• Components for efficient "U" and "L" shaped workstation layouts	•	•	•	•	•	•
• Peninsulas and corner units	•	•	•	•	•	
• Worksurfaces or shells up to 96"W	•				•	
• Standing, 42"H desking solutions	•				•	
• Overheads sized to span multiple base units	•	•	•	•	•	•
• Reception station/transaction counter	•	•	•	•	•	•
• Light scale styling, including worksurface components with O-leg supports	•				•	
• Two-tone color options	•		•		•	
Storage Options						
• 3/4 pedestals provide increased budget flexibility	•	•	•			
• Full desktop-to-floor pedestals maximize storage space	•	•	•	•	•	•
• Modular components/storage with precise, custom cabinet-like fits				•	•	
• Modular shells w/ a variety of storage-pedestal solutions	•	•	•			
• Back wall storage in conventional (65") and executive (78") heights					•	
• Overheads, storage cabinets, wardrobes, lateral files, and bookcases	•	•	•	•	•	•
Companion Products						
• Matching conference tables	•		•	•	•	•
• Coordinating conference tables		•				
Endorsements						
• Meets or exceeds current ANSI/BIFMA and ISTA standards	•	•	•	•	•	•
• Meets SCS Indoor Advantage Certification (see page 10).	•	•	•	•	•	•
• level® certified in conformance with the BIFMA e3 furniture sustainability standard	•	•	•	•	•	•

		Worksurfaces	Chassis	Drawer and Door Fronts	End, Modesty, and Back Panels	O-, Post-, and T-Leg Metal Legs
L1 LAMINATES		CODES				
Woodgrain	Bourbon Cherry	H	•	•	•	•
	Cognac	COGN	•	•	•	•
	Harvest	C	•	•	•	•
	Mahogany	N	•	•	•	•
	Mocha	MOCH	•	•	•	•
	Natural Maple	D	•	•	•	•
	Pinnacle	PINC	•	•	•	•
	Shaker Cherry	F	•	•	•	•
Solid	Black	P	•	•	•	•
	Brilliant White	WHIT	•	•	•	•
	Charcoal	S	•	•	•	•
	Loft	LOFT	•	•	•	•
Patterned	Sheer Mesh	A5	•			
	Silver Mesh	B9	•			
L2 LAMINATES		CODES				
Woodgrain	Lowell Ash	LLA1	•	•	•	•
	Natural Recon	LNR1	•	•	•	•
	Phantom Ecu	LPE1	•	•	•	•
	Portico Teak	LPT1	•	•	•	•
	Skyline Walnut	LSW1	•	•	•	•
PAINTS/WORKSURFACE GROMMETS		CODES				
Core	Black	P	•			•
	Platinum Metallic	T1	•			•
HANDLE/LOCK FINISHES		CODES				
Core	Black	P		•		
	Satin	SA		•		

SILVER COLORWAY: The following finish options are coordinating silver colorways — Satin, Satin Nickel, Matte Chrome, Platinum, and Platinum Metallic.

		Edge Profiles "B" and "V"	Edge Profile "G"
EDGE BAND COLORS		CODES	
Woodgrain	Bourbon Cherry	H	• •
	Cognac	COGN	• •
	Harvest	C	• •
	Lowell Ash	DL	•
	Mahogany	N	• •
	Mocha	MOCH	• •
	Natural Maple	D	• •
	Natural Recon	NR	•
	Phantom Ecu	PE	•
	Pinnacle	PINC	• •
	Portico Teak	DP	•
	Shaker Cherry	F	• •
	Skyline Walnut	SW	•
Solid	Black	P	•
	Brilliant White	WHIT	•
	Charcoal	S	•
	Loft	LOFT	•

Pattern laminates do not have a matching edgeband color; they are available with a woodgrain or solid color edge.

DESKS	
Double Pedestal Desk	Model Edge Profile + Edge Color Handle Worksurface Grommet Finish Worksurface Color Chassis Color Drawer Front Color
Single Pedestal Desk (Left & Right)	Model Edge Profile + Edge Color Handle Worksurface Grommet Finish Worksurface Color Chassis Color Drawer Front Color
CREDENZAS	
Credenza w/ Storage	Model Edge Profile + Edge Color Handle Worksurface Grommet Finish Worksurface Color Chassis Color Drawer/Door Front Color
Credenza w/ Kneespace	Model Edge Profile + Edge Color Handle Worksurface Grommet Finish Worksurface Color Chassis Color Drawer Front Color
Credenza w/ Lateral File (Left & Right)	Model Edge Profile + Edge Color Handle Worksurface Grommet Finish Worksurface Color Chassis Color Drawer Front Color
Single Pedestal Credenza (Left & Right)	Model Edge Profile + Edge Color Handle Worksurface Grommet Finish Worksurface Color Chassis Color Drawer Front Color
Credenzas - Low/Bench-Height	Model Edge Profile + Edge Color Handle Top Color Chassis Color Drawer Front Color
RETURNS	
Return (Left & Right)	Model Edge Profile + Edge Color Handle Worksurface Grommet Finish Worksurface Color Chassis Color Drawer Front Color
BULLET PENINSULA	
Bullet Peninsula	Model Edge Profile + Edge Color Worksurface Color Chassis Color
BRIDGES	
Bridge	Model Edge Profile + Edge Color Worksurface Grommet Finish Worksurface Color Chassis Color
CORNER UNITS	
Corner Unit	Model Edge Profile + Edge Color Worksurface Grommet Finish Worksurface Color Chassis Color
JETTY PENINSULAS	
Jetty Peninsula	Model Edge Profile + Edge Color Worksurface Grommet Finish Worksurface Color Chassis Color
STACK-ON STORAGE	
Stack-On Storage w/ Laminate Doors	Model Chassis Color Door Front Color
Stack-On Storage w/ Laminate Locking Doors	Model Lock Finish Chassis Color Door Front Color
Stack-On Storage w/ Frosted Doors	Model Chassis Color
Stack-On Storage w/ Sliding Door	Model Chassis Color Door Front Color
Stack-On Space Saver End Panels	Model Laminate Color
WALL MOUNTED STORAGE	
Wall Mounted Storage w/ Laminate Doors	Model Chassis Color Door Front Color
Wall Mounted Storage w/ Laminate Locking Doors	Model Lock Finish Chassis Color Door Front Color
Wall Mounted Storage w/ Frosted Doors	Model Chassis Color
Wall Mounted Storage w/ Sliding Door	Model Chassis Color Door Front Color
BOOKCASE HUTCHES	
Bookcase Hutch - No Doors/Open	Model Laminate Color
Bookcase Hutch w/ Laminate Doors	Model Handle Chassis Color Door Front Color
Bookcase Hutch w/ Frosted Doors	Model Laminate Color
RECEPTION STATIONS	
Reception Station	Model Edge Profile Edge Color Counter Color Chassis Color
LATERAL FILES & STORAGE CABINETS	
Lateral File	Model Edge Profile + Edge Color Handle Top Color Chassis Color Drawer Front Color
Storage Cabinet – 78½” and 64¾”H	Model Handle Chassis Color Door Front Color
Storage Cabinet – 29½”H	Model Edge Profile + Edge Color Handle Top Color Chassis Color Door Front Color
Storage/File Cabinet – No Doors/Open	Model Handle Chassis Color Drawer Front Color
Storage/File Cabinet w/ Laminate Door	Model Handle Chassis Color Door & Drawer Front Color
Lateral File/Storage Cabinet	Model Handle Chassis Color Door & Drawer Front Color
WARDROBES	
Wardrobe/Storage Cabinet	Model Handle Chassis Color Door Front Color
Wardrobe/Bookcase	Model Handle Chassis Color Door Front Color

STORAGE TOWERS	
24"W Storage Tower	Model Handle Chassis Color Door & Drawer Front Color
18"W Storage Tower	Model Handle Chassis Color Door Front Color
BOOKCASES	
Bookcase	Model Edge Profile and Edge Color Top Color Chassis Color
Bookcase w/ Coat Hooks	Model Laminate Color
WORKSURFACES	
Rectangle Worksurface	Model Edge Profile + Edge Color Grommet Worksurface Color
Bow Worksurface	Model Edge Profile + Edge Color Grommet Worksurface Color
Bullet Worksurface	Model Edge Profile + Edge Color Grommet Worksurface Color
Extended Corner Worksurface	Model Edge Profile + Edge Color Worksurface Grommet Worksurface Color End Panel Color
PANELS & LEGS	
27 ⁷ / ₈ "H Modesty/Back Panels	Model Grommet Laminate Color
10"H Modesty/Back Panels	Model Laminate Color
Full Back Panel for Pedestals – 30" & 36"W x 27 ⁷ / ₈ "H	Model Grommet Laminate Color
Full Back Panel for Pedestals – 9 ¹ / ₂ ", 15 ³ / ₄ ", & 18"W	Model Laminate Color
Full Back Panel for Pedestals – 9 ¹ / ₂ " & 15 ³ / ₄ "W x 40 ³ / ₈ "H	Model Laminate Color
Low Back Panel for Pedestal	Model Laminate Color
Laminate End Panel – 1 ¹ / ₈ "W x 28 ¹ / ₂ " or 41"H	Model Grommet Laminate Color
Laminate End Panel – 1 ¹ / ₈ "W x 7"H	Model Laminate Color
Laminate End Panel – L-Shape	Model Grommet Laminate Color
Laminate End Panel – T-Shape	Model Laminate Color
Laminate End Panel – Kneespace Clearance	Model Laminate Color
Laminate End Panel – Support Brace	Model Laminate Color
Metal O-Leg	Model Paint Color
PEDESTALS	
Pedestal – Narrow Box/Box/File	Model Handle Grommet Chassis Color Drawer Front Color
Pedestal – Narrow File/File	Model Handle Grommet Chassis Color Drawer Front Color
Pedestal – Box/Box/File	Model Handle Grommet Chassis Color Drawer Front Color
Pedestal – File/File	Model Handle Grommet Chassis Color Drawer Front Color
Pedestal – Lateral File	Model Handle Grommet Chassis Color Drawer Front Color
Pedestal – Shelf/Box/Box/Lateral File	Model Handle Grommet Chassis Color Drawer Front Color
Pedestal – Storage Cabinet	Model Handle Grommet Chassis Color Door Front Color
Pedestal – Bookcase Pedestal	Model Grommet Chassis Color
Pedestal – Bookcase End Support	Model Chassis Color
Mobile Pedestal – Box/Box/File, File/File, Box/File	Model Handle Chassis Color Drawer Front Color
Mobile Pedestal – 30"W Shelf/File/Storage	Model Edge Profile + Edge Color Handle Top Color Chassis Color Drawer/Door Front Color
Pedestal Tops	Model Edge Profile + Edge Color Top Color
ACCESSORIES	
Laminate Center Drawer	Model Laminate Color
Collaborative Desk Shelf	Model Laminate Color
Wall Mount Markerboard	Model
Wall Mount Tackboard	Model Fabric
Field Installable Grommet	Model
Lock Core Kit	Model

STYLING AND CONSTRUCTION

- Conventional desking or light scale components.
- Clean, uninterrupted lines and precise fits; no gaps.
- All end, modesty, and back panels, as well as drawer and door fronts, that are specified in a woodgrain color, feature vertical grain; drawer fronts are vertically-aligned, continuous grain and are matched sets.
- All desk, credenza, and return models feature full-to-the-floor pedestals to maximize storage space.
- Factory-configured (i.e., built-up; assembled) 72"W desks can be specified with breakfront or recessed modesty panels.
- Formal, full height modesty panels on factory-configured (i.e., built-up; assembled) desks, credenzas, and returns; modular components available with full or 10" modesty panels.
- Drawer and door fronts over end panels.
- Back panel-over-end panel on desks, credenzas, returns, mobile pedestals, 29½"H lateral files and storage cabinets, and full-length modesty panels for modular pedestals.
- Top-between-end panels on stack-on and wall mount storage, 66⅝"H & 79½"H storage and combination storage cabinets, wardrobes and towers.
- Option choices include:
 - Edge profile and edge color
 - Handle design
 - Handle/worksurface grommet/lock face finish
 - Worksurface color
 - Chassis color
 - Drawer front/door color
- **IMPORTANT NOTE:** Designed and sized to coordinate with 65"H Accelerate® Panels.
 - Desks, credenzas, returns, 2-drawer lateral files, and 29½"H storage cabinets, plus 35¼"H stack-on storage or bookcase hutch, are 64¾"H.
 - Additional solutions ≤65"H include the following: storage cabinet, storage/file cabinet, storage cabinet/lateral file, 18" and 36"W wardrobe/storage cabinets, wardrobe/bookcase, storage tower, and 5-shelf bookcase.

MATERIALS

- Easy-care, scratch-, spill- and stain-resistant thermal-fused laminate (TFL) over solid core, high performance particleboard;
 - Component model thickness: 1⅛" worksurfaces and end panels; ¾" modesty panel and drawer/door fronts.
- Durable, impact-resistant banding protects edges.
- Bottom of end panels on base units and stack-ons feature edge banding for added strength and to seal out moisture.
- HPL worksurfaces are available via special request.

DRAWER SPECIFICATIONS

- Operate on steel ball-bearing slides to ensure smooth, quiet, long-lasting operation.
- Full extension drawers allow complete access to contents.
- Drawers feature 5-sided construction for added strength and easy alignment or replacement of drawer fronts.
- File drawers include integrated hangrails for side-to-side letter or legal filing; and front-to-back for letter filing.
- One molded black pencil tray is included in each box/box/file pedestal.
- Drawer fronts are edge banded on all four sides.

CORE REMOVABLE LOCKS

- All drawers/doors lock on the following products:
 - All desk, credenza, and return pedestals (Note: The lock is on the face of the pedestal)
 - Stack-on and wall mount storage with laminate locking doors ("LL" models)
 - Wall mount storage with sliding door
 - Mobile pedestals
 - Lateral files
 - Storage cabinets
 - Storage/file cabinet
 - Storage cabinet/lateral file
 - Wardrobe/storage cabinets
 - Storage towers
 - Modular pedestals
- On products that are equipped with two locks, the locks are keyed alike:
 - Double pedestal desks
 - Credenza with storage
 - Credenzas with kneespace
 - Low credenzas with four drawers
 - Storage and combination storage/file cabinets
 - Storage towers
 - Stack-on and wall mount storage 60" - 78"W
- Lock faces are available in black or satin.
- Locks feature a removable cylinder (core) that can be interchanged as needed; allows all furniture pieces within an individual workstation to be accessed with one key for convenience, and allows locks to be differentiated between workstations and offices for security. Makes re-keying quick and easy.
 - Keyed alike cores must be ordered separately by specification of the key number. For all products, except stack-on and wall mounted storage, the removable lock core kits are HF23B for Black and HF23S for Satin (Silver).
 - **EXCEPTION - IMPORTANT - NOTE:** The removable lock core kit for stack-on and wall mounted storage is model HF27B (Black) or HF27S (Satin).

CORD MANAGEMENT

- Cord management grommets and pass-through cutouts, for routing and hiding wires and cables, are standard in a pre-determined location on a number of factory-configured (i.e., built-up; assembled) products:
 - Two grommets are located in the tops of desks and credenzas; one grommet is located in the top of returns, bridges, jetty peninsulas, and corner units.
 - All desk, credenza, and return pedestals are designed with two cord pass-through grommets, one per side; end panels of single pedestal desks and single pedestal credenzas feature one cord pass-through grommet.
 - Pass-through in the sides of pedestals and end panels enable the routing of cords below the worksurface and connections between workstations.
 - A pass-through grommet, to facilitate reaching wall electrical outlets, is located in the back panels of credenza with storage, credenza with kneespace, single pedestal credenzas, credenzas with 36" lateral file, returns and bridges.
- See chart on page 58 for cord management options. Worksurfaces/ tops, end and modesty panels, and pedestals can be specified with or without grommets.
- Grommets on worksurfaces are sized to accept optional grommet mount power hub (HGRMTAC) and USB (HGRMTUSB2) models.
- Grommet color/shape/size:
 - Worksurfaces, Black or Platinum, Round, 3" diameter hole with a 3½" plastic cap.
 - Back/modesty panels, Black, Round, 2½" diameter hole with a 3" plastic cap.
 - End panels and pedestal sides, Black, Half-round, 1¾" diameter hole with a 2" x 2½" plastic cap.

LEVELING GLIDES

- Adjustable hex glides to compensate for uneven floors; allow furniture to be easily leveled without lifting the unit.
 - Glides have a 1¼" adjustable range.
 - The hex adjustment is on the foot of the glide for all products except for the 9½", 15¾", and 18"W modular pedestals, in which case it is on the top of the glide stem.

IMPORTANT — OTHER

- Products ship fully assembled, unless otherwise noted (Note: **E♦A** — easy-to-assemble — items are designated in the "DESCRIPTIONS").
- All models must meet or exceed ANSI/BIFMA & ISTA performance standards.
- Products covered by HON Limited Lifetime Warranty.
- Indoor Advantage™ Gold. Indoor Air Quality Certified to SCS-EC10.3-2014 v3.0.
- BIFMA level® 2 certified. Conforms to ANSI/BIFMA e32014e Furniture Sustainability Standard.

WORKSURFACE/TOP EDGE DETAILS

- Three options; two contoured profiles and one smooth, flat edge.
- For beaded (B) and tri-oval (V) edge shapes, tops are profiled on the user and approach sides, and flat on the ends; the flat edges allow side-by-side placement of worksurfaces without gaps. The only exceptions are return, bridge, and rectangle worksurface with vertical grain models, tops on these items are profiled on the user's side and flat banded on the approach side and ends.
 - Bookcases have profiled edge on the front, user side only.
 - The reception station transaction counter and the L-reception station with transaction counter (for the desk) models, have profiled edgeband on the approach and user sides.
 - The L-reception station with the transaction counter models, on which the counter runs around the entire perimeter of the L-configuration, have a profiled edge on the front of the transaction counter on the desk approach side only.

Edge Options: Profiles Designator

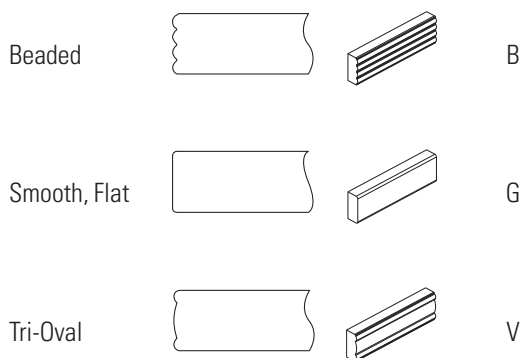

WORKSURFACE EDGE COLORS

- Woodgrain and solid color laminates can be specified with a matching, complementary, or contrasting edgeband color; options include:
 - Matching the worksurface edge to a common worksurface, chassis, and drawer front color.
 - Matching the worksurface edge to the worksurface laminate and selecting a different laminate color for the chassis.
 - Matching the worksurface edge to the chassis laminate and selecting a different laminate color for the worksurface.
- Beaded (B) and tri-oval (V) edges are available in L1 woodgrain colors only.
- The smooth, flat (G) edge is available in woodgrain and solid colors.
- Pattern laminates do not have a matching edgeband color; the patterns are available with a woodgrain or solid color edge.

WORKSURFACE LAMINATES	CODES	EDGE BAND OPTIONS					
		Any Woodgrain	Black (P)	Brilliant White (WHIT)	Charcoal (S)	Loft (LOFT)	
Woodgrain	Bourbon Cherry	H	•	•	•	•	•
	Cognac	COGN	•	•	•	•	•
	Harvest	C	•	•	•	•	•
	Lowell Ash	LLA1	•	•	•	•	•
	Mahogany	N	•	•	•	•	•
	Mocha	MOCH	•	•	•	•	•
	Natural Maple	D	•	•	•	•	•
	Natural Recon	LNR1	•	•	•	•	•
	Phantom Ecru	LPE1	•	•	•	•	•
	Pinnacle	PINC	•	•	•	•	•
	Portico Teak	LPT1	•	•	•	•	•
	Shaker Cherry	F	•	•	•	•	•
	Skyline Walnut	LSW1	•	•	•	•	•
Solid	Black	P	•	•	•	•	•
	Brilliant White	WHIT	•	•	•	•	•
	Charcoal	S	•	•	•	•	•
	Loft	LOFT	•	•	•	•	•
Pattern	Sheer Mesh	A5	•	•	•	•	•
	Silver Mesh	B9	•	•	•	•	•

DRAWER/DOOR DECORATIVE HANDLES

- Three handle style options, each available in Satin or Black finish.
- Distinct, easy to grasp designs.
- Handles are metal.
- The hole spacing is 128mm.
- The handle style/finish has to be specified on drawer fronts (desk/ credenza/return, mobile and modular pedestals), lateral file drawer fronts, the doors of the storage cabinet, storage/file cabinet, storage cabinet/lateral file, wardrobe/storage cabinet, wardrobe/bookcase, and storage tower.
 - NOTE: Decorative handles are not used on the doors of stack-on storage units or wall mounted storage cabinets.
 - Bookcase hutches with frosted doors are equipped with a push latch release.

Handle Options	Finish	Designator
Cylinder	Satin	A
Cylinder	Black	B
Canopy	Satin	C
Canopy	Black	D
Loop	Satin	E
Loop	Black	F

- NOTE: The Linear and Arch field installable drawer/door handle kit models can be attached using 128mm hole spacing.

CORD MANAGEMENT GROMMETS

- Grommets are standard on desk, credenza, return, bridge, jetty peninsula, and corner unit models. Specification logic includes the grommet finish for tops; choose from Black (P) or Platinum (T1). Grommets in modesty and end panels are Black only.
- Grommets are optional on modular component worksurfaces, full-length (27⁷/₈"H) modesty panels, end panels (1¹/₈", L-shaped) and the sides of support storage pedestals. On worksurfaces, choose from Black (P), Platinum (T1), or no grommet(s) (X). On modesty, end, and side panels the options are grommet Black (P) or no grommet (X).
- See cord management chart on page 58 for details.

LOCK FINISH

- Finish is determined by, and automatically aligned with, the handle finish specified. If there is no decorative handle on the product, such as on locking stack-on or wall mount storage models, the lock finish is specified separately in the option string.
 - When specification is required, the lock finish options are Black (P) or Satin (SA).
- Removable, interchangeable lock core kits must be ordered separately:
 - For all models, except stack-on and wall mount storage, specify model HF23B (Black) or HF23S (Satin), and the specific key number required.
 - For stack-on and wall mount storage, specify model HF27B (Black) or HF27S (Satin), and the specific key number required.

SILVER COLORWAY

- The following finish options are coordinating Silver colorways: Satin, Satin Nickel, Matte Chrome, Platinum, and Platinum Metallic.

LAMINATE COLORS

- Palette choices include eight (13) woodgrain, four (4) solid, and two (2) pattern colors.

Woodgrain

Bourbon Cherry	H
Cognac	COGN
Harvest	C
Lowell Ash	LLA1
Mahogany	N
Mocha	MOCH
Natural Maple	D
Natural Recon	LNR1
Phantom Ecru	LPE1
Pinnacle	PINC
Portico Teak	LPT1
Shaker Cherry	F
Skyline Walnut	LSW1

Solid Color

Black	P
Brilliant White	WHIT
Charcoal	S
Loft	LOFT

Pattern

Sheer Mesh	A5
Silver Mesh	B9

- Worksurface, chassis and drawer/door fronts are specified separately to enable a single, color-matched visual, or a complementary or contrasting, multi-tone aesthetic.
- Worksurfaces/tops are available in woodgrain, solid, or pattern laminate colors.
- Chassis and drawer fronts are available in woodgrain or solid laminate colors.
- Pattern colors are available on worksurface tops only.

Worksurface

Bourbon Cherry	H
Cognac	COGN
Harvest	C
Lowell Ash	LLA1
Mahogany	N
Mocha	MOCH
Natural Maple	D
Natural Recon	LNR1
Phantom Ecru	LPE1
Pinnacle	PINC
Portico Teak	LPT1
Shaker Cherry	F
Skyline Walnut	LSW1
Black	P
Brilliant White	WHIT
Charcoal	S
Loft	LOFT
Sheer Mesh	A5
Silver Mesh	B9

Chassis

Bourbon Cherry	H
Cognac	COGN
Harvest	C
Lowell Ash	LLA1
Mahogany	N
Mocha	MOCH
Natural Maple	D
Natural Recon	LNR1
Phantom Ecru	LPE1
Pinnacle	PINC
Portico Teak	LPT1
Shaker Cherry	F
Skyline Walnut	LSW1
Black	P
Brilliant White	WHIT
Charcoal	S
Loft	LOFT

Drawer/Door

Bourbon Cherry	H
Cognac	COGN
Harvest	C
Lowell Ash	LLA1
Mahogany	N
Mocha	MOCH
Natural Maple	D
Natural Recon	LNR1
Phantom Ecru	LPE1
Pinnacle	PINC
Portico Teak	LPT1
Shaker Cherry	F
Skyline Walnut	LSW1
Black	P
Brilliant White	WHIT
Charcoal	S
Loft	LOFT

- Two-tone color options allow specification of different, complementary laminate combinations:

Color #1

Top
Top and Drawer Fronts
Top and Chassis

Color #2

Chassis and Drawer Fronts
Chassis
Drawer Fronts

- Modesty panels and the backs of storage chassis that are specified in L2 laminates and wider than 60"W will ship as horizontal grain.

	GROMMET	# OF GROMMETS	LOCATION	CUTOUT SHAPE	MATERIAL	COLOR/FINISH
BUILT-UP/FACTORY-CONFIGURED						
DESK						
Top	Standard/Fixed Location	2	Back Left & Right	3" Round	Plastic	Black or Platinum
End Panel	Standard/Fixed Location	2 (1 per EP)	Top Back Corner	1¾" Round	Plastic	Black
Modesty/Back	Not Available	0	N/A	N/A	N/A	N/A
CREENZA						
Top	Standard/Fixed Location	2	Back Left & Right	3" Round	Plastic	Black or Platinum
End Panel	Standard/Fixed Location	2 (1 per EP)	Top Back Corner	1¾" Round	Plastic	Black
Modesty/Back	Standard/Fixed Location	1	Top Center	2½" Round	Plastic	Black
RETURN						
Top	Standard/Fixed Location	1	Top Center	3" Round	Plastic	Black or Platinum
End Panel	Standard/Fixed Location	1	Top Back Corner	1¾" Round	Plastic	Black
Modesty/Back	Standard/Fixed Location	1	Top Center	2½" Round	Plastic	Black
BRIDGE						
Top	Standard/Fixed Location	1	Back Center	3" Round	Plastic	Black or Platinum
Modesty/Back	Standard/Fixed Location	1	Top Center	2½" Round	Plastic	Black
BULLET PENINSULA						
Top	Not Available	0				
End Panel	Not Available; Pass-Thru in Brace Panel	0				
JETTY PENINSULA						
Top	Standard/Fixed Location	1	Back, Approach-Side Corner	3" Round	Plastic	Black or Platinum
End Panel	Not Available; Pass-Thru Standard in Brace Panel	0				
CORNER UNIT						
Top	Standard/Fixed Location	1	Back Corner	3" Round	Plastic	Black or Platinum
Modesty/Back	Not Available; Pass-Thru Standard in Brace Panels	0				
Stack-on	Standard/Fixed Location	1	1¼" Side-to-Side Gap at Top or Bottom of Back Panel, Below Cabinet			
MODULAR COMPONENTS — WORKSURFACES						
Rectangle – 60" to 96"W	Optional – Specify: Black (P) or Platinum (T1) or None (X)	2	Back Left & Right	3" Round	Plastic	Black or Platinum
Rectangle – 30" to 54"W	Optional – Specify: Black (P) or Platinum (T1) or None (X)	1	Back Center	3" Round	Plastic	Black or Platinum
Bullet Shape	Optional – Specify: Black (P) or Platinum (T1) or None (X)	1	Centered Along EP; Over Brace Leg Cutout	3" Round	Plastic	Black or Platinum
Ext. Corner	Optional – Specify: Black (P) or Platinum (T1) or None (X)	1	Back Corner of Top and Long End Panel	3" Round	Plastic	Black or Platinum
MODULAR COMPONENTS — MODESTY PANELS						
Full Length – ≥30"W	Optional – Specify: Black (P) or None (X)	1	Top Center	2½" Round	Plastic	Black
10"	No	0				
MODULAR COMPONENTS — END PANELS						
1⅞" Thick	Optional – Specify: Black (P) or None (X)	1	Top Back Corner	1¾" Round	Plastic	Black
T-Shaped	No	0				
L-Shaped	Optional – Specify: Black (P) or None (X)	1	Top or Bottom Centered	1¾" Round	Plastic	Black
MODULAR COMPONENTS – STORAGE PEDESTALS						
Pedestal	Optional – Specify: Black (P) or None (X)	2 (1 per EP)	Top Back Corner	1¾" Round	Plastic	Black

NOTE: If customer wants a desk, credenza, return, or bridge without grommets, they can specify modular components.

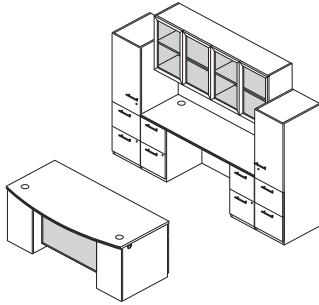

Desk — Credenza — Storage

Qty.	Model #	Description	List Price	Price Extension
1	HNL3672DPBBF	Double Pedestal Desk, Bow Top, Breakfront Frosted Modesty Panel 72"W x 36"D x 29½"H	\$2,629	\$2,629
1	HNL2472DPK	Credenza with Kneespace 72"W x 24"D x 29½"H	\$1,650	\$1,650
1	HNL2972FD	Wall Mount Storage, Frosted Doors with Silver Frame 72"W x 15"D x 28½"H	\$2,199	\$2,199
1	HNL241865SFLR	Storage/File Cabinet, Hinged Right 18"W x 24"D x 64¾"H	\$1,579	\$1,579
1	HNL241865SFL	Storage/File Cabinet, Hinged Left 18"W x 24"D x 64¾"H	\$1,579	\$1,579
TOTAL:			\$9,636	

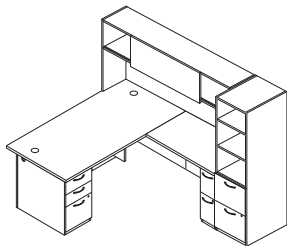

L-Workstation

Qty.	Model #	Description	List Price	Price Extension
1	HNL3672LPRB	Left Pedestal Desk, Rectangle Top, Breakfront Modesty Panel 72"W x 36"D x 29½"H	\$1,734	\$1,734
1	HNLRC2442V	Rectangle Worksurface with Vertical Grain 42"W x 24"D	\$ 222	\$ 222
1	HNL231028PFF	Narrow File/File Pedestal 9½"W x 23⅞"D x 28½"H	\$ 625	\$ 625
1	HNLMP4228	Modesty/Back Panel—Full Length 42"W x 27⅞"H	\$ 184	\$ 184
1	HNL3678SD	Stack-on Storage, Sliding Door 78"W x 15"D x 35¼"H	\$1,149	\$1,149
1	HNL241865SFX	Storage/File Cabinet, Open Shelves 18"W x 24"D x 64¾"H	\$1,499	\$1,499
TOTAL:			\$5,413	

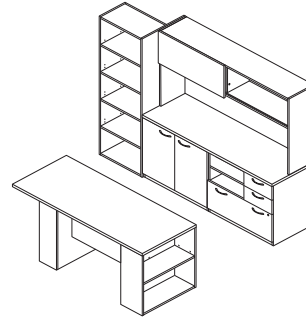

Desk — Credenza — Storage

Qty.	Model #	Description	List Price	Price Extension
1	HNLRC3072	Rectangle Worksurface 72"W x 30"D	\$ 384	\$ 384
1	HNL291028PBBF	Narrow Box/Box/File Pedestal 9½"W x 29⅞"D x 28½"H	\$ 699	\$ 699
1	HNLBP1028	Full Back Panel—For 9½"W Pedestal 9½"W x 27⅞"H	\$ 112	\$ 112
1	HLSL3614L	Laminate Floating Modesty Panel 36"W x 14"H	\$ 156	\$ 156
1	HNL123028BKE	Bookcase End Support 12"W x 30"D x 28½"H	\$ 459	\$ 459
1	HNLRC2472	Rectangle Worksurface 72"W x 24"D	\$ 319	\$ 319
1	HNL233628PSL	Shelf/Box/Box/Lateral File Pedestal 36"W x 23⅞"D x 28½"H	\$1,129	\$1,129
1	HNL233628PSC	Storage Cabinet Pedestal 36"W x 23⅞"D x 28½"H	\$ 734	\$ 734
1	HNLMP7228	Modesty/Back Panel—Full Length 72"W x 27⅞"H	\$ 257	\$ 257
1	HNL3672SD	Stack-on Storage, Sliding Door 72"W x 15"D x 35¼"H	\$1,115	\$1,115
1	HNL2424BK5CL	Bookcase with Coat Hooks, 5-Shelf, Left 24"W x 24"D x 64¾"H	\$ 868	\$ 868
TOTAL:			\$6,232	

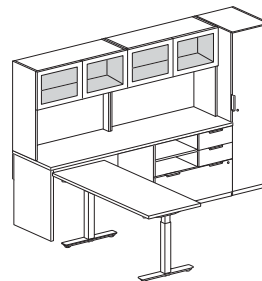

L-Workstation with Height-Adjustable Desk — Open Plan

Qty.	Model #	Description	List Price	Price Extension
1	HNLRC2460	Rectangle Worksurface 60"W x 24"D	\$ 284	\$ 284
1	HHAB3S24F	Height Adjustable Base	\$1,250	\$1,250
1	HNLRC2484	Rectangle Worksurface 84"W x 24"D	\$ 430	\$ 430
1	HNLEP2428L	End Panel, Left 1⅞"W x 23⅞"D x 28½"H	\$ 184	\$ 184
1	HNL233628PSL	Shelf/Box/Box/Lateral File Pedestal 36"W x 23⅞"D x 28½"H	\$1,129	\$1,129
1	HNLMP8410	Modesty/Back Panel—Short 84"W x 10"H	\$ 314	\$ 314
1	HNLB3618	Low Back Panel—For 28½"H Pedestal 36"W x 18"H	\$ 134	\$ 134
2	HNL3642FD	Stack-on Storage, Frosted Doors with Silver Frame 42"W x 15"D x 35¼"H	\$1,209	\$2,418
1	HNL3605SSEP	Space Saver End Panels for Stack-on Storage ¾"W x 14¼"D x 35¼"H	\$ 342	\$ 342
1	HNL241865WLR	Wardrobe/Storage Cabinet, Hinged Right 18"W x 24"D x 64¾"H	\$1,442	\$1,442
TOTAL:			\$7,927	

Concinnity™ Typical

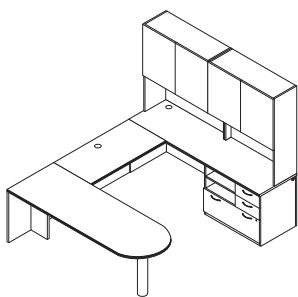

U-Workstation with 84"W Worksurface

Qty.	Model #	Description	List Price	Price Extension
1	HNLBU3084	Bullet Worksurface 84"W x 30"D	\$ 545	\$ 545
1	HNLTEP3028	T-Shaped End Panel — For Bullet Worksurface 11 5/8"W x 29 1/8"D x 28 1/2"H	\$ 319	\$ 319
1	HPC190X	Support Column — For Bullet Worksurface 4 1/2" Diameter	\$ 144	\$ 144
1	HNL2448BF	Bridge 48"W x 24"D x 29 1/2"H	\$ 405	\$ 405
1	HNLRC2484	Rectangle Worksurface 84"W x 24"D	\$ 430	\$ 430
1	HNLEP2428L	End Panel, Left 1 1/8"W x 23 1/8"D x 28 1/2"H	\$ 184	\$ 184
1	HNL233628PSL	Shelf/Box/Box/Lateral File Pedestal 36"W x 23 1/8"D x 28 1/2"H	\$1,129	\$1,129
1	HNLMP8428	Modesty/Back Panel—Full Length 84"W x 27 1/8"H	\$ 314	\$ 314
2	HNL4942LD	Stack-on Storage, Laminate Doors 42"W x 15"D x 48 5/8"H	\$1,095	\$2,190
1	HNL4905SSEP	Space Saver End Panels for Stack-on Storage 3/4"W x 14 1/4"D x 48 5/8"H	\$ 464	\$ 464
TOTAL:			\$6,124	

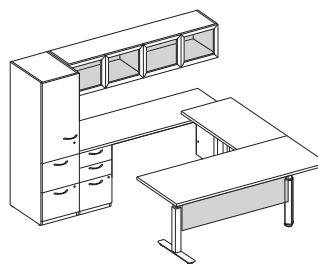

U-Workstation with Height-Adjustable L-Worksurface

Qty.	Model #	Description	List Price	Price Extension
1	HNLRC3072	Rectangle Worksurface 72"W x 30"D	\$ 384	\$ 384
1	HNLRC2442V	Rectangle Worksurface with Vertical Grain 42"W x 24"D	\$ 222	\$ 222
1	HHAB3S3C24F	Height Adjustable Base, 3-Leg	\$1,700	\$1,700
1	HLSL6014MM	Mixed Material Floating Modesty Panel 60"W x 14"H	\$ 984	\$ 984
1	HNLRC2472	Rectangle Worksurface 72"W x 24"D	\$ 319	\$ 319
1	HNLEP2428R	End Panel, Right 1 1/8"W x 23 1/8"D x 28 1/2"H	\$ 184	\$ 184
1	HNL231628PBBF	Box/Box/File Pedestal 15 1/4"W x 23 1/8"D x 28 1/2"H	\$ 647	\$ 647
1	HNLB1618	Low Back Panel—For 15 3/4"W Pedestal 15 3/4"W x 18"H	\$ 114	\$ 114
1	HNLMP7210	Modesty/Back Panel—Short 72"W x 10"H	\$ 257	\$ 257
1	HNL1572FD	Wall Mount Storage, Frosted Doors with Silver Frame 72"W x 15"D x 15"H	\$1,649	\$1,649
1	HNL241865SFL	Storage/File Cabinet, Hinged Left 18"W x 24"D x 64 3/4"H	\$1,579	\$1,579
TOTAL:			\$8,039	

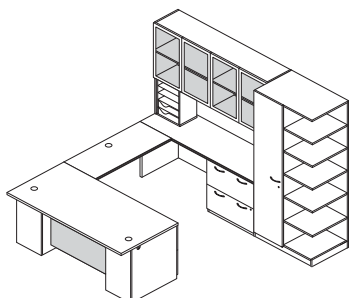

U-Workstation

Qty.	Model #	Description	List Price	Price Extension
1	HNL3672LPRBF	Left Pedestal Desk, Rectangle Top, Breakfront Frosted Modesty Panel 72"W x 36"D x 29 1/2"H	\$2,184	\$2,184
1	HNLRC2448V	Rectangle Worksurface with Vertical Grain 48"W x 24"D	\$ 239	\$ 239
1	HNLMP4810	Modesty/Back Panel—Short 48"W x 10"H	\$ 199	\$ 199
1	HNL2472RLC	Right Credenza with Lateral File 72"W x 24"D x 29 1/2"H	\$1,437	\$1,437
1	HNL4972FD	Stack-on Storage, Frosted Doors with Silver Frame 72"W x 15"D x 48 5/8"H	\$2,390	\$2,390
1	HLVPM1	Vertical Paper Manager	\$ 298	\$ 298
1	HNL243679WLBR	Wardrobe Left, Bookcase Right 36"W x 24"D x 78 1/8"H	\$2,299	\$2,299
TOTAL:			\$9,046	

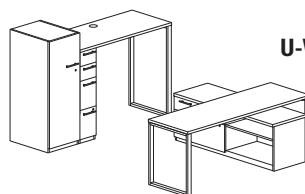

U-Workstation with Sitting and Standing-Height Worksurfaces — Open Plan

Qty.	Model #	Description	List Price	Price Extension
1	HNLRC2472	Rectangle Worksurface 72"W x 24"D	\$ 319	\$ 319
2	HLSL24280	O-Leg Support for 24"D Worksurface 24"D x 28 1/2"H	\$ 279	\$ 558
1	HLSL25SC78	External Support Channel for 72"W Worksurface	\$ 92	\$ 92
1	HNL206021LD2	Low Credenza, Drawers Left, Bookcase Right 60"W x 20"D x 21 1/2"H	\$1,147	\$1,147
1	HNLRC2454	Rectangle Worksurface 54"W x 24"D	\$ 259	\$ 259
1	HLSL24410	Standing-Height O-Leg Support for 24"D Worksurface 24"D x 41"H	\$ 375	\$ 375
1	HNL231041PBBF	Narrow Box/Box/File/File Pedestal 9 1/2"W x 23 1/8"D x 41"H	\$1,199	\$1,199
1	HNLPB1041	Full Back Panel—For 41"H Pedestal 9 1/2"W x 40 5/8"H	\$ 124	\$ 124
1	HNL241850TLL	Storage Tower, Hinged Left 18"W x 24"D x 50"H	\$1,129	\$1,129
TOTAL:			\$5,202	

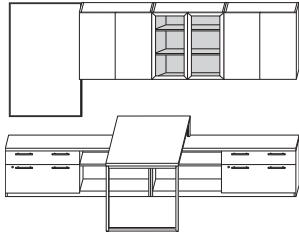

Workstation with Workwall — Open Plan

Qty.	Model #	Description	List Price	Price Extension
1	HNLRC3072	Rectangle Worksurface 72"W x 30"D	\$ 384	\$ 384
1	HLSL30280	O-Leg Support for 30"D Worksurface 30"D x 28½"H	\$ 310	\$ 310
1	HLSL3070	O-Leg Support over Low Credenza 30"D x 7"H	\$ 239	\$ 239
1	HLSLZ5SC78	External Support Channel for 72"W Worksurface	\$ 92	\$ 92
1	HNL206021RD2	Low Credenza, Drawers Right, Bookcase Left 60"W x 20"D x 21½"H	\$1,147	\$1,147
1	HNL206021LD2	Low Credenza, Drawers Left, Bookcase Right 60"W x 20"D x 21½"H	\$1,147	\$1,147
2	HNL2930LD	Wall Mount Storage, Laminate Doors 30"W x 15"D x 48⅝"H	\$ 742	\$1,484
1	HNL2930FD	Wall Mount Storage, Frosted Doors with Silver Frame 30"W x 15"D x 48⅝"H	\$1,192	\$1,192
1	HNL4930WB	Wall Mount Markerboard 30"W x 48⅝"H	\$ 197	\$ 197
TOTAL:			\$6,192	

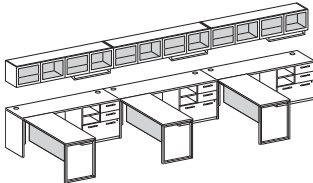

L-Workstations — Open Plan

Qty.	Model #	Description	List Price	Price Extension
3	HNLRC2448V	Rectangle Worksurface with Vertical Grain 48"W x 24"D	\$ 239	\$ 717
3	HLSL24280	O-Leg Support for 48"W x 24"D Worksurface 24"D x 28½"H	\$ 279	\$ 837
3	HLSL4214MM	Mixed Material Floating Modesty Panel 42"W x 14"H	\$ 716	\$ 2,148
3	HNLRC2472	Rectangle Worksurface 72"W x 24"D	\$ 319	\$ 957
3	HNLLEP2428L	L-Shaped End Panel, Left 15¼"W x 24"D x 28½"H	\$ 299	\$ 897
3	HNL233028PSL	Shelf/Box/Box/Lateral File Pedestal 30"W x 23⅝"D x 28½"H	\$1,107	\$ 3,321
3	HNLMP3028	Modesty/Pedestal Back Panel 30"W x 27⅝"H	\$ 157	\$ 471
3	HNL1572FD	Wall Mount Storage, Frosted Doors with Silver Frame 72"W x 15"D x 15"H	\$1,649	\$ 4,947
3	HHPS1	Hanging Paper Shelf	\$ 175	\$ 525
TOTAL:			\$14,820	

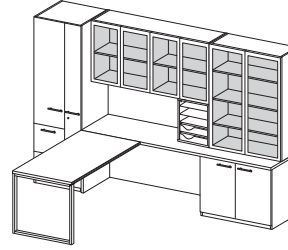

Workstation with Workwall — Open Plan

Qty.	Model #	Description	List Price	Price Extension
1	HNLRC2448V	Rectangle Worksurface with Vertical Grain 48"W x 24"D	\$ 239	\$ 239
1	HLSL24280	O-Leg Support for 48"W x 24"D Worksurface 24"D x 28½"H	\$ 279	\$ 279
1	HNLRC2496	Rectangle Worksurface 96"W x 24"D	\$ 464	\$ 464
1	HNL233628PSC	Storage Cabinet Pedestal 36"W x 23⅝"D x 28½"H	\$ 734	\$ 734
1	HNLEP2428L	End Panel, Left 1½"W x 23⅝"D x 28½"H	\$ 184	\$ 184
1	HNLMP9628	Modesty/Back Panel—Full Length 96"W x 27⅝"H	\$ 389	\$ 389
1	HNL4936BHFD	Bookcase Hutch, Frosted Doors with Silver Frame 36"W x 15"D x 48⅝"H	\$1,569	\$1,569
1	HNL2960FD	Wall Mount Storage, Frosted Doors with Silver Frame 60"W x 15"D x 28½"H	\$2,069	\$2,069
1	HLVPM1	Vertical Paper Manager	\$ 298	\$ 298
1	HNL242465TLR	Storage Tower, Wardrobe Right, Cabinet Left 24"W x 24"D x 78⅝"H	\$2,029	\$2,029
TOTAL:			\$8,254	

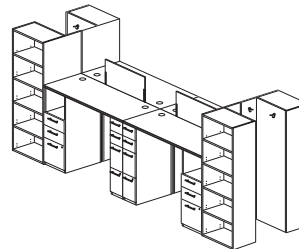

Standing-Height — Teaming Workstation — Open Plan

Qty.	Model #	Description	List Price	Price Extension
4	HNLRC2460	Rectangle Worksurface 60"W x 24"D	\$ 284	\$ 1,136
4	HNL231641PSBBF	Shelf/Box/Box/File Pedestal 15¾"W x 23⅝"D x 41"H	\$1,364	\$ 5,456
4	HNLPB1641	Full Back Panel—For 15¾"W Pedestal 15¾"W x 40¾"H	\$ 138	\$ 552
4	HNL231041PBFBF	Narrow Box/Box/File/File Pedestal 9½"W x 23⅝"D x 41"H	\$1,199	\$ 4,796
4	HNLPB1041	Full Back Panel—For 9½"W Pedestal 9½"W x 40¾"H	\$ 124	\$ 496
2	HLSL2830	Above/Below Privacy Screen, Frosted 30"W x 28"H	\$ 707	\$ 1,414
2	HNL2424BK5CR	5-Shelf Bookcase with Coat Hooks, Right 24"W x 24"D x 64¾"H	\$ 868	\$ 1,736
2	HNL2424BK5CL	5-Shelf Bookcase with Coat Hooks, Left 24"W x 24"D x 64¾"H	\$ 868	\$ 1,736
TOTAL:			\$17,322	

Concinnity™ Desks

Not on GSA Contract



- ▶ Feature full-to-the-floor pedestals to maximize storage space.
- ▶ Double pedestal desks have 3/2 drawer configuration (box/box/file on left pedestal, file/file on right pedestal).
- ▶ Single pedestal desks have a box/box/file pedestal.
- ▶ One molded black pencil tray is included in each box/box/file pedestal.
- ▶ 72"W models are available with Rectangle- or bow-shaped tops.
- ▶ Bow top desk models measure 36"D at the crest and 30"D along the end panels.
- ▶ Formal breakfront or recessed modesty panel.
- ▶ Breakfront desk features a floating modesty panel which can be specified in laminate or frosted material. Floating design provides space for optional pull-out collaborative shelf for visitors. See page 111.
- ▶ Recessed modesty panel design has a full-width conference overhang, providing workspace and knee-space for guests.
- ▶ 66"W and 60"W desks have a flush modesty panel (i.e., no conference overhang).
- ▶ Two cord management grommets, for routing and hiding wires and cables, are located in desktops.
- ▶ Grommets can be replaced with optional Power (model HGRMTAC) or USB Hub (HGRMTUSB2).
- ▶ Pedestal sides and end panels are standard with pass-through grommets to enable the routing of cords below the worksurface, and connections between workstations.
- ▶ Specification logic includes the grommet finish for tops; choose from Black (P) or Platinum (T1). Side grommets on pedestal are black only.
- ▶ See "Modular Components" for cord management options. Worksurfaces/tops, end and modesty panels, and pedestals can be specified with or without grommets.
- ▶ Finish of pedestal lock(s) is determined by, and aligned with, the handle finish specified.
- ▶ Adjustable hex leveling glides.
- ▶ Ship fully assembled.



Description	Approach Side Overhang	Model	Ship Weight	Cube	L1 List	L2 Upcharges			
						Worksurfaces	Chassis	Fronts	
Double Pedestal Desk — Bow Top									
72"W x 36"D x 29½"H, Recessed Modesty Panel	6"	HNL3672DPBR	298	51.8	\$2097	\$ 25	\$ 50	\$ 20	
72"W x 36"D x 29½"H, Breakfront Modesty Panel	6-12"	HNL3672DPBB	282	51.8	\$2179	\$ 25	\$ 50	\$ 20	
72"W x 36"D x 29½"H, Breakfront Frosted Modesty Panel	6-12"	HNL3672DPBBF	266	51.8	\$2629	\$ 25	\$ 50	\$ 20	

NOTES: For laminate center drawer, see page 111. For pull-out collaborative shelf, for desks with breakfront modesty panel, see page 111.

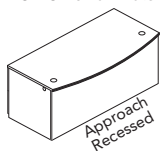
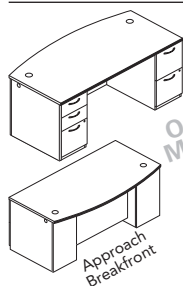

Double Pedestal Desk — Rectangle Top								
72"W x 36"D x 29½"H, Rectangle Top, Recessed Modesty Panel	6"	HNL3672DPRR	292	51.8	\$1774	\$ 25	\$ 50	\$ 20
66"W x 30"D x 29½"H, Rectangle Top, Flush Modesty Panel		HNL3066DPRF	267	40.2	\$1669	\$ 20	\$ 45	\$ 20
60"W x 30"D x 29½"H, Rectangle Top, Flush Modesty Panel		HNL3060DPRF	257	40.2	\$1559	\$ 20	\$ 45	\$ 20
72"W x 36"D x 29½"H, Rectangle Top, Breakfront Modesty Panel	6-12"	HNL3672DPRB	287	51.8	\$1974	\$ 25	\$ 50	\$ 20
72"W x 36"D x 29½"H, Rectangle Top, Breakfront Frosted Modesty Panel	6-12"	HNL3672DPRBF	270	51.8	\$2424	\$ 25	\$ 50	\$ 20

NOTES: For laminate center drawer, see page 111. For pull-out collaborative shelf, for desks with breakfront modesty panel, see page 111.

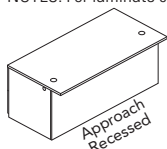
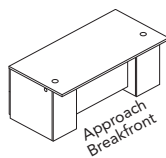
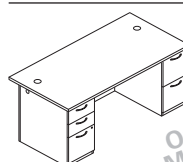

Single Pedestal Desk — Bow Top								
72"W x 36"D x 29½"H, Right, Recessed Modesty Panel (shown)	6"	HNL3672RPBR	238	51.8	\$1684	\$ 25	\$ 40	\$ 10
72"W x 36"D x 29½"H, Left, Recessed Modesty Panel	6"	HNL3672LPBR	238	51.8	\$1684	\$ 25	\$ 35	\$ 10
72"W x 36"D x 29½"H, Right, Breakfront Modesty Panel	6-12"	HNL3672RPBB	237	51.8	\$1899	\$ 25	\$ 35	\$ 10
72"W x 36"D x 29½"H, Left, Breakfront Modesty Panel	6-12"	HNL3672LPBB	237	51.8	\$1899	\$ 25	\$ 35	\$ 10
72"W x 36"D x 29½"H, Right, Breakfront Frosted Modesty Panel	6-12"	HNL3672RPBBF	221	51.8	\$2349	\$ 25	\$ 35	\$ 10
72"W x 36"D x 29½"H, Left, Breakfront Frosted Modesty Panel	6-12"	HNL3672LPBBF	221	51.8	\$2349	\$ 25	\$ 35	\$ 10

NOTES: For laminate center drawer, see page 111. For pull-out collaborative shelf, for desks with breakfront modesty panel, see page 111.

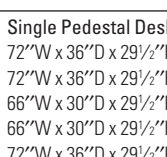
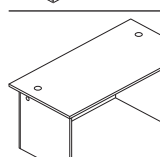
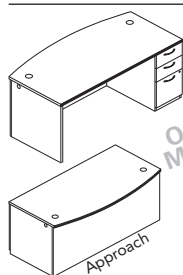

Single Pedestal Desk — Rectangle Top								
72"W x 36"D x 29½"H, Right, Recessed Modesty Panel (shown)	6"	HNL3672RPRR	242	51.8	\$1454	\$ 25	\$ 40	\$ 10
72"W x 36"D x 29½"H, Left, Recessed Modesty Panel	6"	HNL3672LPRR	242	51.8	\$1454	\$ 25	\$ 40	\$ 10
66"W x 30"D x 29½"H, Right, Flush Modesty Panel		HNL3066RPRF	217	40.2	\$1419	\$ 20	\$ 35	\$ 10
66"W x 30"D x 29½"H, Left, Flush Modesty Panel		HNL3066LPRF	217	40.2	\$1419	\$ 20	\$ 35	\$ 10
72"W x 36"D x 29½"H, Right, Breakfront Modesty Panel	6-12"	HNL3672RPRB	242	51.8	\$1734	\$ 25	\$ 40	\$ 10
72"W x 36"D x 29½"H, Left, Breakfront Modesty Panel	6-12"	HNL3672LPRB	242	51.8	\$1734	\$ 25	\$ 40	\$ 10
72"W x 36"D x 29½"H, Right, Breakfront Frosted Modesty Panel	6-12"	HNL3672RPRBF	225	51.8	\$2184	\$ 25	\$ 40	\$ 10
72"W x 36"D x 29½"H, Left, Breakfront Frosted Modesty Panel	6-12"	HNL3672LPRBF	225	51.8	\$2184	\$ 25	\$ 40	\$ 10

NOTES: For laminate center drawer, see page 111. For pull-out collaborative shelf, for desks with breakfront modesty panel, see page 111.

How to specify

Select Model Number from above	1st Option Select Edge Profile and Edge Color	2nd Option Select Handle	3rd Option Select Worksurface Grommet Finish	4th Option Select Worksurface Color	5th Option Select Chassis Color	6th Option Select Drawer Front Color
	See page 51	A Cylinder – Satin B Cylinder – Black C Canopy – Satin D Canopy – Black E Loop – Satin F Loop – Black	P Black T1 Platinum	See page 51	See page 51	See page 51
H N L 3 6 7 2 D P B R .	B H .	E .	T 1 .	H .	H .	H .

Icon Legend on page 10



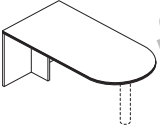

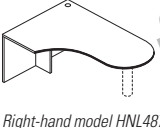
Description	Model	Ship Weight	Cube	L1 List	L2 Upcharges	
					Worksurface	Chassis
 <p>Bullet Peninsula with End Panel 72"W x 36"D x 29½"H 72"W x 30"D x 29½"H 66"W x 30"D x 29½"H</p> <p>NOTES: For use in "U" or "L" shaped furniture layouts; not to be used freestanding. Comprised of top and end/brace panels (Note: Must specify support column; sold separately). Cord routing notch in the brace panel. Adjustable hex leveling glides. For cord grommet options, see "Modular Components". Options include center drawers and modesty panels. Modesty panel is available in laminate or frosted material. Ships E♦A.</p> <p>⚠ Not designed to be used freestanding.</p>	HNL3672BUEP E♦A	131	6.6	\$ 814	\$ 20	\$ 25
	HNL3072BUEP E♦A	112	5.6	\$ 709	\$ 20	\$ 25
	HNL3066BUEP E♦A	105	5.1	\$ 635	\$ 20	\$ 25

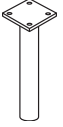
 <p>Jetty Peninsula with End Panel 72"W x 30/48"D x 29½"H, Right 72"W x 30/48"D x 29½"H, Left 72"W x 30/42"D x 29½"H, Right 72"W x 30/42"D x 29½"H, Left</p> <p>NOTES: Worksurface designed and sized to efficiently serve as both a computing and conferencing space. Two sizes, 42"D and 48"D. The 48"D unit is specifically intended to be used with the 48"D extended corner modular top/back components to form a two-piece U-shaped workstation with a 42" cockpit area. For use in "U" or "L" shaped furniture layouts; not to be used freestanding. Comprised of top and end/brace panels (Note: Must specify support column; sold separately). One cord management grommet in the top; cord routing notch in the brace panel. Adjustable hex leveling glides. Field installable modesty panel is optional. Ships E♦A.</p> <p>⚠ Not designed to be used freestanding.</p>	HNL4872JREP E♦A	147	8.9	\$ 979	\$ 30	\$ 25
	HNL4872JLEP E♦A	147	8.9	\$ 979	\$ 30	\$ 25
	HNL4272JREP E♦A	134	17.0	\$ 909	\$ 30	\$ 25
	HNL4272JLEP E♦A	134	17.0	\$ 909	\$ 30	\$ 25

Description	Model	Ship Weight	Cube	List
 <p>Support Column for Bullet and Jetty Peninsulas 4½" Diameter. Specify: HPC190X.P. Black only.</p>	HPC190X	12	1.0	\$ 144
<p>Support Column for Bullet and Jetty Peninsulas 4½" Diameter. Specify: HPC191X.X. Available in Silver only.</p>	HPC191X	12	1.0	\$ 144

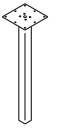
⚠ **Support Column must be specified/ordered with Bullet and Jetty peninsulas.**

Description	Model	Ship Weight	Cube	List Price by Paint Grade	
				Core	Metallics
 <p>Post Leg Base 28½"H x 2" square</p> <p>NOTES: Can only be used as the outbound support in a peninsula or island extension worksurface application. Glides have 2" of adjustability. Ship 1/pack.</p> <p>SPECIFYING EXAMPLE: HLSL28P.T1</p>	HLSL28P	15	1.0	\$ 256	\$ 260

Description	Model	Ship Weight	Cube	List	
				Core	Metallics
 <p>Field Installable Modesty Panel for Bullet and Jetty Peninsulas, Laminate (Vertical Grain) 50¼"W x ¾"Thick x 18"H</p> <p>NOTES: Center drawer model H1522 can be used in conjunction with laminate modesty panel model HPC180W. Cord pass-through notch in top corner.</p> <p>SPECIFYING EXAMPLE: HPC180W.H</p>	HPC180W	28	3.6	\$ 194	
 <p>Field Installable Modesty Panel for Bullet and Jetty Peninsulas, Frosted with Silver Frame 50¼"W x ¾"Thick x 18"H</p> <p>⚠ Cord pass-through notch is not available on the Frosted/Silver model HPC180G. Notch is on laminate model HPC180W only. ⚠ Center drawers not designed to be used with the frosted/silver modesty panel model HPC180G.</p>	HPC180G	33	1.5	\$ 629	

NOTE: See pages 133 through 140 for shared components.

How to specify	1st Option	2nd Option	3rd Option
Select Model Number from above H N L 3 6 7 2 B U E P .	Select Edge Profile and Edge Color See page 51 B H .	Select Worksurface Color See page 51 H .	Select Chassis Color See page 51 H

How to specify	1st Option	2nd Option	3rd Option	4th Option
Select Model Number from above H N L 4 8 7 2 J R E P .	Select Edge Profile and Edge Color See page 51 B H .	Select Worksurface Grommet Finish P Black T1 Platinum P .	Select Worksurface Color See page 51 H .	Select Chassis Color See page 51 H

Icon Legend on page 10

Concinnity™ Corner Unit

Not on GSA Contract



► For Extended Corner Worksurface sizes, see "Modular Components" on page 91.

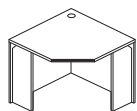

Open Market

Description	Model	Ship Weight	Cube	L1 List	L2 Upcharges	
					Worksurface	Chassis
Corner Unit 24"W x 36"D x 24" x 29½"H NOTES: Designed for use with 24"D returns or bridges. Can be used freestanding. Can be used with two 36"W modular returns to achieve an efficient 6' x 6' layout. One cord management grommet in the top; cord routing notches in the leg panels. The worksurface grommet can be replaced with optional power (model HGRMTAC) or USB (model HGRMTUSB2) hub. Adjustable hex leveling glides. When connected to a 42"W return or modular return, the 78"W stack-on storage unit spans the total depth dimension (78"D). When connected to a 36"W modular return, the 72"W stack-on storage unit spans the total depth dimension (72"D). Ships E♦A.	HNL3636CU E♦A	109	26.4	\$ 857	\$ 15	\$ 20

How to specify	1st Option	2nd Option	3rd Option	4th Option
Select Model Number from above H N L 3 6 3 6 C U .	Select Edge Profile and Edge Color See page 51 B H .	Select Worksurface Grommet Finish P Black T1 Platinum P .	Select Worksurface Color See page 51 H .	Select Chassis Color See page 51 H

E♦A Icon Legend on page 10

► Optional 72"W, 66"W and 60"W stack-on sizes maximize storage space.

► Two cord management grommets, for routing and hiding wires and cables, are located in top.
 ► Modesty panel and pedestal grommets are black only.

► A cord pass-through grommet is located in the sides of the pedestal and top center of the back (modesty panel) to facilitate reaching wall electrical outlets.

► Specification logic includes the grommet finish for tops; choose from Black (P) or Platinum (T1).

► Worksurfaces/tops, end and modesty panels, and pedestals can be specified with or without grommets. See "Modular Components" on page 58 for cord management options.
 ► For paper organizers, see page 114.

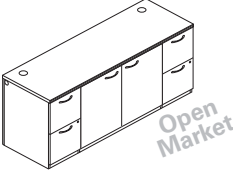
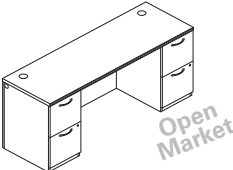
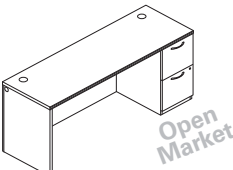
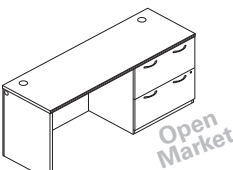

Description	Model	Ship Weight	Cube	L1 List	L2 Upcharges		
					Worksurfaces	Chassis	Fronts
 <p>Credenza with Storage 72"W x 24"D x 29½"H</p> <p>NOTES: For use behind a desk or as a standalone storage piece. Four file drawers, 2-left, 2-right and one storage cabinet with hinged doors. One adjustable shelf, which adjusts in 2½" increments, behind doors. Drawers lock. Finish of locks is determined by, and aligned with, the handle finish specified. Storage cabinet doors are non-locking. Worksurface grommets can be replaced with optional Power (model HGRMTAC) or USB (model HGRMTUSB2) hub.</p>	HNL2472DPS	323	35.6	\$2182	\$ 20	\$ 45	\$ 40
 <p>Credenza with Kneespace 72"W x 24"D x 29½"H 66"W x 24"D x 29½"H 60"W x 24"D x 29½"H</p> <p>NOTES: For use behind a desk or as a standalone storage piece. Four locking file drawers, 2-left, 2-right. Finish of locks is determined by, and aligned with, the handle finish specified. Worksurface grommets can be replaced with optional Power (model HGRMTAC) or USB (model HGRMTUSB2) hub.</p>	HNL2472DPK HNL2466DPK HNL2460DPK	247 239 230	35.6 32.7 29.9	\$1650 \$1575 \$1549	\$ 20 \$ 20 \$ 20	\$ 40 \$ 40 \$ 35	\$ 20 \$ 20 \$ 20
 <p>Credenza, Single Pedestal 72"W x 24"D x 29½"H, Right 72"W x 24"D x 29½"H, Left</p> <p>NOTES: Primary use is as part of a connected U-shaped workstation with a bridge and single pedestal desk. Two locking file drawers. Finish of lock determined by, and aligned with, the handle finish specified. Worksurface grommets can be replaced with optional Power (model HGRMTAC) or USB (model HGRMTUSB2) hub. Can be used with modular or mobile pedestals.</p>	HNL2472RP HNL2472LP	199 199	35.6 35.6	\$1315 \$1315	\$ 20 \$ 20	\$ 35 \$ 35	\$ 10 \$ 10
 <p>Credenza with Lateral File 72"W x 24"D x 29½"H, Right 72"W x 24"D x 29½"H, Left</p> <p>NOTES: Storage file measures 30"W (36"W can be specified using modular components). Mechanical interlock inhibits the extension of more than one drawer at a time. Finish of lock is determined by, and aligned with, the handle finish specified. Worksurface grommets can be replaced with optional Power (model HGRMTAC) or USB (model HGRMTUSB2) hub. Can be used with modular or mobile pedestals.</p>	HNL2472RLC HNL2472LLC	245 245	35.6 35.6	\$1437 \$1437	\$ 20 \$ 20	\$ 35 \$ 35	\$ 20 \$ 20

How to specify	1st Option	2nd Option	3rd Option	4th Option	5th Option	6th Option
Select Model Number from above	Select Edge Profile and Edge Color	Select Handle	Select Worksurface Grommet Finish	Select Worksurface Color	Select Chassis Color	Select Drawer Front Color
	See page 51	A Cylinder – Satin B Cylinder – Black C Canopy – Satin D Canopy – Black E Loop – Satin F Loop – Black	P Black T1 Platinum	See page 51	See page 51	See page 51
H N L 2 4 7 2 D P S .	B H .	E .	T 1 .	H .	H .	H .

Icon Legend on page 10

Concinnity™ Low Credenzas

GSA SIN as Noted



- ▶ Versatile, space-saving solutions double as a compact storage unit and convenient bench seat.
- ▶ When combined with 29½”H workspaces, the 21½”H credenzas can be positioned to create multi-level, overlapping surfaces that optimize floor space, organization and display needs.
- ▶ The distinct, clean horizontal planes provide a light scale, layered look.
- ▶ Low-heights help facilitate team collaboration.
- ▶ Finish of lock(s) is determined by, and aligned with, the handle finish specified.
- ▶ Overlapping surfaces can be supported by a 28½”H or 7”H O-leg or 7”H laminate end panel.

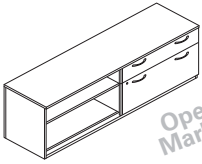
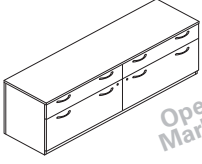
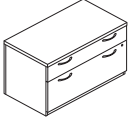

Description	Model	Ship		L1 List	L2 Upcharges		
		Weight	Cube		Worksurfaces	Chassis	Fronts
 <p>Low Credenza (Bench-Height) 72”W x 20”D x 21½”H, Drawers Right, Bookcase Left (shown) 72”W x 20”D x 21½”H, Drawers Left, Bookcase Right 60”W x 20”D x 21½”H, Drawers Right, Bookcase Left 60”W x 20”D x 21½”H, Drawers Left, Bookcase Right</p> <p>Open Market</p>	HNL207221RD2	219	21.6	\$1277	\$ 15	\$ 25	\$ 20
	HNL207221LD2	219	21.6	\$1277	\$ 15	\$ 25	\$ 20
	HNL206021RD2	187	18.1	\$1147	\$ 15	\$ 20	\$ 20
	HNL206021LD2	187	18.1	\$1147	\$ 15	\$ 20	\$ 20
NOTES: Combination storage design comprised of two locking drawers (1-box/supply and 1-file) plus a bookcase. File drawers include integrated hangrails for letter- or legal-sized folders. Bookcase has one adjustable shelf; adjusts in 2½” increments.							
 <p>Low Credenza, 2 Box/2 File 72”W x 20”D x 21½”H 60”W x 20”D x 21½”H</p> <p>Open Market</p>	HNL207221D4	308	21.6	\$1554	\$ 15	\$ 25	\$ 40
	HNL206021D4	260	18.1	\$1377	\$ 15	\$ 20	\$ 40
NOTES: Four locking drawers (2-box/supply and 2-file). File drawers include integrated hangrails for letter- or legal-sized folders.							
 <p>Low Credenza, Box/File 36”W x 20”D x 21½”H 30”W x 20”D x 21½”H</p> <p>Open Market</p>	HNL203621D2	143	11.8	\$ 899	\$ 10	\$ 15	\$ 20
	HNL203021D2	121	10.0	\$ 845	\$ 10	\$ 15	\$ 20
NOTES: Unit contains two drawers, one box and one lateral file.							

Description	Model	Ship		Options					
		Weight	Cube	1	2	3	4	5	6
 <p>Credenza Cushion 36”W x 20”D x 1”H for 72” and 36”W Low Credenzas 30”W x 20”D x 1”H for 60” and 30”W Low Credenzas</p> <p>SIN 711-3</p>	HLSL2036CH2	11	2.2	\$ 354	\$ 392	\$ 430	\$ 469	\$ 518	\$ 568
	HLSL2030CH2	9	1.9	\$ 328	\$ 364	\$ 400	\$ 436	\$ 482	\$ 529
NOTES: See pages 488-497 and 522-523 for available fabrics. Seat cushions are optional; HLSL2036CH2 for 72” and 36”W, HLSL2030CH2 for 60” and 30”W. SPECIFYING EXAMPLE: HLSL2036CH2.AB10									

How to specify	1st Option	2nd Option	3rd Option	4th Option	5th Option
Select Model Number from above H N L 2 0 7 2 2 1 R D 2 . B H .	Select Edge Profile and Edge Color See page 51 B H .	Select Handle A Cylinder – Satin B Cylinder – Black C Canopy – Satin D Canopy – Black E Loop – Satin F Loop – Black E .	Select Top Color See page 51 H .	Select Chassis Color See page 51 H .	Select Drawer Front Color See page 51 H

Icon Legend on page 10

► For paper organizers, see page 114.



Description	Model	Ship Weight	Cube	L1 List	L2 Upcharges		
					Worksurfaces	Chassis	Fronts
Return							
48"W x 24"D x 29½"H, Right (shown)	HNL2448RP	141	24.8	\$ 942	\$ 15	\$ 15	\$ 10
48"W x 24"D x 29½"H, Left	HNL2448LP	141	24.8	\$ 942	\$ 15	\$ 15	\$ 10
42"W x 24"D x 29½"H, Right	HNL2442RP	132	22.0	\$ 903	\$ 15	\$ 15	\$ 10
42"W x 24"D x 29½"H, Left	HNL2442LP	132	22.0	\$ 903	\$ 15	\$ 15	\$ 10

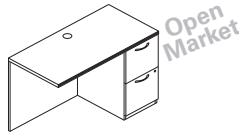

NOTES: For L-shaped workstations. Connects to single pedestal desk, peninsula (bullet or jetty), or component worksurface with end panel. Drawers lock. Finish of lock is determined by, and aligned with, the handle finish specified. Formal, full-height modesty panel. One cord grommet in top for routing and hiding wires and cables. One cord pass-through grommet is located in the sides of the pedestal and top center of the back (modesty panel) to facilitate reaching wall electrical outlets. Specification logic includes the grommet finish for tops; choose from Black (P) or Platinum (T1). Modesty panel and pedestal grommets are black only. Edge banding on 42"W and 48"W returns is profiled on the user's side and flat on the back (approach side) and ends. Woodgrain direction on worksurface runs vertical (i.e., front-to-back). Smaller and larger return sizes can be specified using modular worksurface and modesty panel components. Optional stack-on solutions maximize storage space. Ship fully assembled.

See chart on page 58 for cord management options. Worksurfaces/tops, end and modesty panels, and pedestals can be specified with or without grommets. For easy access to wall electrical outlets, options include a short (10") modesty panel or no back panel.

How to specify	1st Option	2nd Option	3rd Option	4th Option	5th Option	6th Option
Select Model Number from above	Select Edge Profile and Edge Color	Select Handle	Select Worksurface Grommet Finish	Select Worksurface Color	Select Chassis Color	Select Drawer Front Color
	See page 51	A Cylinder – Satin B Cylinder – Black C Canopy – Satin D Canopy – Black E Loop – Satin F Loop – Black	P Black T1 Platinum	See page 51	See page 51	See page 51
H N L 2 4 4 8 R P .	B H .	E .	T 1 .	H .	H .	H .



Description	Model	Ship Weight	Cube	L1 List	L2 Upcharges		
					Worksurfaces	Chassis	Fronts
Bridge							
48"W x 24"D x 29½"H	HNL2448BF E♦A	71	3.0	\$ 405	\$ 15	\$ 15	N/A
42"W x 24"D x 29½"H	HNL2442BF E♦A	62	2.5	\$ 387	\$ 15	\$ 15	N/A

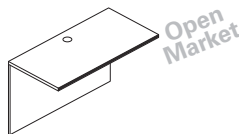

NOTES: For U-shaped workstation layouts. Connects single pedestal desk, peninsula (bullet or jetty), or component worksurface to corner unit or to single pedestal credenza, credenza with lateral file, or rectangle worksurface. Formal, full-height modesty panel. One cord grommet in top for routing and hiding wires and cables. One cord pass-through grommet in top center of back (modesty panel). Specification logic includes the grommet finish for tops; choose from Black (P) or Platinum (T1). Clear inside depth 22⅞"D. Edge banding on 42"W and 48"W bridges is profiled on the user's side and flat on the back (approach side) and ends. Woodgrain direction on worksurface runs vertical (i.e., front-to-back). Additional sizes, including 30"W and 36"W for use with corner or extended corner units, as well as jetty peninsulas, can be specified using modular worksurface and modesty panel components. Ship **E♦A** — quick, simple assembly.

See chart on page 58 for cord management options. Worksurfaces/tops and modesty panels can be specified with or without grommets. For easy access to wall electrical outlets, options include a short (10") modesty panel or no back panel.

How to specify	1st Option	2nd Option	3rd Option	4th Option
Select Model Number from above	Select Edge Profile and Edge Color	Select Worksurface Grommet Finish	Select Worksurface Color	Select Chassis Color
	See page 51	P Black T1 Platinum	See page 51	See page 51
H N L 2 4 4 8 B F .	B H .	P .	H .	H .

E♦A Icon Legend on page 10

STACK-ON STORAGE APPLICATIONS

78"W

- Spans full-width of 78"W modular credenza or return.
- Spans total depth dimension of "L" workstation configurations comprised of:
 - 48"W return or modular return attached to a 36"D single pedestal desk with a bow front (78"D).
 - Note: The 36"D single pedestal desk with bow front is 30"D along end panel.
 - 48"W return or modular return attached to a 30"D single pedestal desk, modular desk, or bullet peninsula (78"D).
 - 42"W return or modular return attached to a 36"D single pedestal desk with rectangle top, modular desk, or bullet peninsula (78"D).
 - 42"W return or modular return attached to a 36" corner unit or 36"D extended corner unit (78"D).
 - 36"W modular return attached to a 42"D jetty peninsula (78"D).
 - 30"W modular return attached to a 48"D jetty peninsula (78"D).
 - 30"W modular return attached to a 48"D extended corner unit (78"D).

72"W

- Spans full-width of 72"W desks with rectangle top, credenzas, extended corner units, or modular desk, credenza, or return.
- Spans total depth dimension of "L" workstation configurations comprised of:
 - 48"W return or modular return attached to a 24"D single pedestal credenza or modular credenza (72"D).
 - 42"W return or modular return attached to a 36"D single pedestal desk with a bow front (72"D).
 - Note: The 36"D single pedestal desk with bow front is 30"D along end panel.
 - 42"W return or modular return attached to a 30"D single pedestal desk, modular desk, or bullet peninsula (72"D).
 - 36"W modular return attached to a 36"D single pedestal desk with rectangle top, modular desk, or bullet peninsula (72"D).
 - 36"W modular return attached to a 36" corner unit or 36"D extended corner unit (72"D).
 - 30"W modular return attached to a 42"D jetty peninsula (72"D).

66"W

- Spans full-width of 66"W desk, credenza, or modular desk, credenza, or return.
- Spans total depth dimension of "L" workstation configurations comprised of:
 - 42"W return or modular return attached to a 24"D single pedestal credenza or modular credenza (66"D).
 - 36"W modular return attached to a 30"D single pedestal desk, bullet peninsula, or modular desk (66"D).
 - 36"W modular return attached to a 36"D single pedestal desk with a bow front (66"D).
 - Note: The 36"D single pedestal desk with bow front is 30"D along end panel.
 - 30"W modular return attached to a 36"D single pedestal desk with rectangle top or modular desk (66"D).
 - 30"W modular return attached to a 36" corner unit (66"D).

60"W

- Spans full-width of 60"W desk, credenza, or modular desk, credenza, or return.
- Spans total depth dimension of "L" workstation configurations comprised of:
 - 36"W modular return attached to a 24"D single pedestal credenza or modular credenza (60"D).
 - 30"W modular return attached to a 30"D single pedestal desk or modular desk (60"D).

48"W

- Spans full-width of 48"W return, modular return, or modular desk or credenza.
- Spans full-depth of the 48"D jetty peninsula or extended corner unit.

42"W

- Spans full-width of 42"W return, modular return, or modular desk or credenza.
- Spans full-depth of 42"D jetty peninsula.

36"W

- Spans full-width of 36"W modular return, modular desk or credenza, two drawer lateral file, or 29½"H storage cabinet with doors.
- Spans full-depth of 36"D desks with rectangle top, bullet peninsula, extended corner unit, or 36" corner unit.

OPTIONS INCLUDE:

- Door/Storage Options:

Door(s)	Standard-Height	Executive-Height
Laminate	•	•
Laminate Locking	•	•
Frosted/Silver	•	•
Sliding	•	•

- Available in 35¼" or 78⅞"H; when positioned on 29½"H base unit, heights respectively align with 64¾" and 78⅞"H storage- and wardrobe-type cabinets.
- Paper organizers for stack-on and wall mounted storage cabinets (see application and compatibility information on page 115).
- Fabric-Covered Tackboards:
 - Sized ¾" narrower than the stack-on storage back enclosure, allowing ¾" on each side to route task light cords.
 - Includes adhesive latch & hook tape for attachment to stack-on storage back panel and fasteners for wall mount applications.
 - Available in HON Group panel fabric grades A and B.
- Markerboards:
 - HLSL1530SOMB: 29½"W x 12½"H panel attaches to 60" and 66"W stack-on and wall mounted storage with sliding door models with double-sided tape.
 - HLSL1536SOMB: 35½"W x 12½"H panel attaches to 72" and 78"W stack-on and wall mounted storage with sliding door models with double-sided tape.
- Markerboards will not fit on stack-on storage laminate or laminate locking door models.
- Task Lights:
 - Attach to underside of stack-on and wall mount storage cabinets.
 - Fluorescent or LED options.
 - Tackboard and fluorescent and LED task light solutions, by model, for each stack-on storage size:

Stack-on Storage	Tackboard	Fluorescent Task Light	LED Task Light
78"W	H90057	HH870960, HH870960CH	HLED31A, HLED31AU0
72"W	H90056	HH870960, HH870960CH	HLED31A, HLED31AU0
66"W	H90055	HH870960, HH870960CH	HLED31A, HLED17AU0
60"W	H90054	HH870960, HH870960CH	HLED31A, HLED17AU0
48"W	H90053	HH870942, HH870942CH	HLED31AS
42"W	H90052	HH870942, HH870942CH	HLED31AS
36"W	H90051	HH870930, HH870930CH	HLED17AS

- ▶ Convenient off-the-worksurface storage requires no additional floor space.
- ▶ 35 1/4" H stack-on storage models ship fully assembled.
- ▶ Fully enclosed back provides privacy; includes a 1 1/4", full-width pass-through for 3-prong electrical plugs; facilitates routing cords and reaching wall electrical outlets.
- ▶ Lower back panel can be attached with cord pass-through at bottom next to the worksurface or at top for close proximity to task light cord.
- ▶ Lower back panel can be removed to facilitate collaboration in teaming configurations.
- ▶ Valance hides task light.
- ▶ Vertical clearance for computer monitor is 20".
- ▶ Laminate vertical paper organizer (HLVPM1) sized to fit below storage compartments.
- ▶ Can be specified in seven widths (36", 42", 48", 60", 66", 72", and 78"W) and two heights, standard (35 1/4"H) or executive (48 5/8"H).
- ▶ Available with laminate doors, frosted/silver doors, or sliding door.
- ▶ Doors are sized to overlap the top, end panels and light valance, to provide a clean design.
- ▶ Laminate and frosted/silver door units are equipped with self-closing, adjustable hinges.
- ▶ Laminate hinged door units are available with or without a lock.
- ▶ For tackboards, see page 72.
- ▶ For task lights, see page 117.
- ▶ For paper organizers, see page 114.

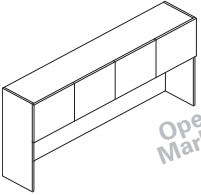

Description	Model	Ship Weight	Cube	L1 List	L2 Upcharges	
					Chassis	Fronts
 <p>Stack-on Storage, Laminate Doors</p> <p>78"W x 15"D x 35 1/4"H — 4 doors, 2 compartments</p> <p>72"W x 15"D x 35 1/4"H — 4 doors, 2 compartments</p> <p>66"W x 15"D x 35 1/4"H — 4 doors, 2 compartments</p> <p>60"W x 15"D x 35 1/4"H — 4 doors, 2 compartments</p> <p>48"W x 15"D x 35 1/4"H — 3 doors, 2 compartments</p> <p>42"W x 15"D x 35 1/4"H — 2 doors, 1 compartment</p> <p>36"W x 15"D x 35 1/4"H — 2 doors, 1 compartment</p>	HNL3678LD	173	31.8	\$1199	\$ 45	\$ 20
	HNL3672LD	162	29.0	\$1149	\$ 35	\$ 20
	HNL3666LD	151	26.7	\$1134	\$ 35	\$ 20
	HNL3660LD	139	24.3	\$1034	\$ 35	\$ 20
	HNL3648LD	117	19.6	\$ 933	\$ 30	\$ 10
	HNL3642LD	100	18.1	\$ 909	\$ 30	\$ 10
	HNL3636LD	88	15.3	\$ 769	\$ 30	\$ 10

 <p>Stack-on Storage, Laminate Locking Doors</p> <p>78"W x 15"D x 35 1/4"H — 4 doors, 2 compartments</p> <p>72"W x 15"D x 35 1/4"H — 4 doors, 2 compartments</p> <p>66"W x 15"D x 35 1/4"H — 4 doors, 2 compartments</p> <p>60"W x 15"D x 35 1/4"H — 4 doors, 2 compartments</p> <p>48"W x 15"D x 35 1/4"H — 3 doors, 2 compartments</p> <p>42"W x 15"D x 35 1/4"H — 2 doors, 1 compartment</p> <p>36"W x 15"D x 35 1/4"H — 2 doors, 1 compartment</p>	HNL3678LL	173	31.8	\$1279	\$ 45	\$ 20
	HNL3672LL	162	29.0	\$1229	\$ 35	\$ 20
	HNL3666LL	151	26.7	\$1214	\$ 35	\$ 20
	HNL3660LL	139	24.3	\$1114	\$ 35	\$ 20
	HNL3648LL	117	19.6	\$ 973	\$ 30	\$ 10
	HNL3642LL	100	18.1	\$ 949	\$ 30	\$ 10
	HNL3636LL	88	15.3	\$ 809	\$ 30	\$ 10

▲ **Lock available in Black (P) or Satin (SA) finish. Lock is core removable. Keyed alike cores must be ordered separately. For stack-on and wall mount storage with locking hinged doors, specify model HF27B (Black) or HF27S (Satin) and the key number, see page 116. Model HNL3648LL has one lock, which secures two of the three doors.**

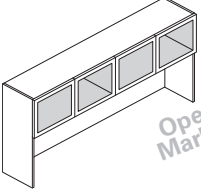
 <p>Stack-on Storage, Frosted Doors with Silver Frame</p> <p>78"W x 15"D x 35 1/4"H — 4 doors, 2 compartments</p> <p>72"W x 15"D x 35 1/4"H — 4 doors, 2 compartments</p> <p>66"W x 15"D x 35 1/4"H — 4 doors, 2 compartments</p> <p>60"W x 15"D x 35 1/4"H — 4 doors, 2 compartments</p> <p>48"W x 15"D x 35 1/4"H — 3 doors, 2 compartments</p> <p>42"W x 15"D x 35 1/4"H — 2 doors, 1 compartment</p> <p>36"W x 15"D x 35 1/4"H — 2 doors, 1 compartment</p>	HNL3678FD	153	31.8	\$1799	\$ 45	N/A
	HNL3672FD	143	29.0	\$1749	\$ 35	N/A
	HNL3666FD	134	26.7	\$1734	\$ 35	N/A
	HNL3660FD	124	24.3	\$1634	\$ 35	N/A
	HNL3648FD	104	19.6	\$1383	\$ 30	N/A
	HNL3642FD	89	18.1	\$1209	\$ 30	N/A
	HNL3636FD	79	15.3	\$1069	\$ 30	N/A

▲ **Frosted/silver door units do not have a lock option.**

How to specify	Select Model Number from above H N L 3 6 7 2 L D .	1st Option Select Chassis Color See page 51 H .	2nd Option Select Door Front Color See page 51 H
----------------	---	---	--

How to specify	Select Model Number from above H N L 3 6 7 2 L L .	1st Option Select Lock Finish See page 51 P .	2nd Option Select Chassis Color See page 51 H .	3rd Option Select Door Front Color See page 51 H
----------------	---	---	---	--

How to specify	Select Model Number from above H N L 3 6 7 2 F D .	1st Option Select Chassis Color See page 51 H
----------------	---	---

▲ Icon Legend on page 10

Concinnity™ Stack-on Storage

Not on GSA Contract



- ▶ Convenient off-the-worksurface storage requires no additional floor space.
- ▶ 35 1/4" H stack-on storage models ship fully assembled.
- ▶ Fully enclosed back provides privacy; includes a 1 1/4", full-width pass-through for 3-prong electrical plugs; facilitates routing cords and reaching wall electrical outlets.
- ▶ Lower back panel can be attached with cord pass-through at bottom next to the worksurface or at top for close proximity to task light cord.
- ▶ Lower back panel can be removed to facilitate collaboration in teaming configurations.
- ▶ Valance hides task light.
- ▶ Vertical clearance for computer monitor is 20".
- ▶ Laminate vertical paper organizer (HLVPM1) sized to fit below storage compartments.
- ▶ Can be specified in seven widths (36", 42", 48", 60", 66", 72", and 78"W) and two heights, standard (35 1/4"H) or executive (48 3/8"H).
- ▶ Available with laminate doors, frosted/silver doors, or sliding door.
- ▶ Doors are sized to overlap the top, end panels and light valance, to provide a clean design.
- ▶ Laminate and frosted/silver door units are equipped with self-closing, adjustable hinges.
- ▶ Laminate hinged door units are available with or without a lock.
- ▶ For tackboards, see page 72.
- ▶ For task lights, see page 117.
- ▶ For paper organizers, see page 114.

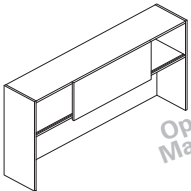

Description	Model	Ship		L1 List	L2 Upcharges	
		Weight	Cube		Chassis	Fronts
 <p>Stack-on Storage, Sliding Door 78"W x 15"D x 35 1/4"H 72"W x 15"D x 35 1/4"H 66"W x 15"D x 35 1/4"H 60"W x 15"D x 35 1/4"H 48"W x 15"D x 35 1/4"H</p> <p>Open Market</p> <p>NOTES: Sliding door units have one door per cabinet; standard with black lock, which is located on inside vertical support panel. Sliding door availability limited to select sizes.</p>	HNL3678SD	161	31.8	\$1149	\$ 45	\$ 20
	HNL3672SD	151	29.0	\$1115	\$ 35	\$ 20
	HNL3666SD	141	26.7	\$1027	\$ 35	\$ 20
	HNL3660SD	131	24.3	\$ 999	\$ 35	\$ 20
	HNL3648SD	110	19.6	\$ 944	\$ 30	\$ 20

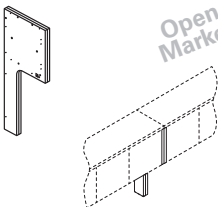
 <p>Stack-on Space Saver End Panels 3/4"W x 14 1/4"D x 35 1/4"H</p> <p>Open Market</p> <p>NOTES: Two field installable end panels (1-right; 1-left) for use in ganging two stack-on storage units. Combining stack-on allows users to span longer worksurfaces, including 84" (2 - 42"W), 96" (2 - 48"W), 120" (2 - 60"W), and 144" (2 - 72"W). Narrow, space-saving panel size replaces the full 15"D end panels to expand worksurface space. The 4 1/4" right end panel is to replace the standard 15"D right end panel on one stack-on storage unit, the 4 1/4" left end panel is to replace the standard 15"D left end panel on a separate, adjacent stack-on storage unit that is in linear alignment with the first unit. Kit includes: (2) narrow end panel supports; European-style fasteners; dowels; joint connector bolts with sleeve nuts (for ganging stack-on storage units). Can be used to connect up to two stack-on storage units in a line (requires 1 kit). Can be specified in a woodgrain or solid laminate color only.</p> <p>SPECIFYING EXAMPLE: HNL3605SSEP</p>	HNL3605SSEP	14	1.7	\$ 342	\$ 15	N/A
--	--------------------	----	-----	--------	-------	-----

How to specify	1st Option	2nd Option
<p>Select Model Number from above</p> <p>H N L 3 6 7 2 S D .</p>	<p>Select Chassis Color</p> <p>See page 51</p> <p>H .</p>	<p>Select Door Front Color</p> <p>See page 51</p> <p>H </p>

Icon Legend on page 10

- ▶ Convenient off-the-worksurface storage requires no additional floor space.
- ▶ 48 $\frac{3}{4}$ "H units have a fixed, intermittent shelf; storage space above and below the shelf is 12 $\frac{3}{4}$ ".
- ▶ Product applications are detailed on page 68.
- ▶ Fully enclosed back provides privacy; includes a 1/4", full-width pass-through for 3-prong electrical plugs; facilitates routing cords and reaching wall electrical outlets.
- ▶ Lower back panel can be attached with cord pass-through at bottom next to the worksurface or at top for close proximity to task light cord.
- ▶ Lower back panel can be removed to facilitate collaboration in teaming configurations.
- ▶ Valance hides task light.
- ▶ Vertical clearance for computer monitor is 20".
- ▶ Laminate vertical paper organizer (HLVPM1) sized to fit below storage compartments.
- ▶ Can be specified in seven widths (36", 42", 48", 60", 66", 72", and 78"W) and two heights, standard (35 $\frac{1}{4}$ "H) or executive (48 $\frac{3}{4}$ "H).
- ▶ Available with laminate doors, frosted/silver doors, or sliding door.
- ▶ Doors are sized to overlap the top, end panels and light valance, to provide a clean design.
- ▶ Laminate and frosted/silver door units are equipped with self-closing, adjustable hinges.
- ▶ Laminate hinged door units are available with or without a lock.
- ▶ For tackboards, see page 72.
- ▶ For task lights, see page 117.
- ▶ For paper organizers, see page 114.

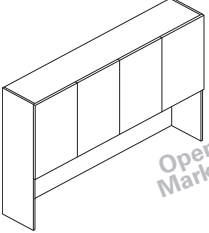

Description	Model	Ship Weight	Cube	L1 List	L2 Upcharges	
					Chassis	Fronts
 <p>Stack-on Storage, Laminate Doors</p> <p>78"W x 15"D x 48$\frac{3}{4}$"H — 4 doors, 2 compartments</p> <p>72"W x 15"D x 48$\frac{3}{4}$"H — 4 doors, 2 compartments</p> <p>66"W x 15"D x 48$\frac{3}{4}$"H — 4 doors, 2 compartments</p> <p>60"W x 15"D x 48$\frac{3}{4}$"H — 4 doors, 2 compartments</p> <p>48"W x 15"D x 48$\frac{3}{4}$"H — 3 doors, 2 compartments</p> <p>42"W x 15"D x 48$\frac{3}{4}$"H — 2 doors, 1 compartment</p> <p>36"W x 15"D x 48$\frac{3}{4}$"H — 2 doors, 1 compartment</p>	HNL4978LD E◆A	264	31.3	\$1619	\$ 60	\$ 40
	HNL4972LD E◆A	243	29.1	\$1490	\$ 50	\$ 40
	HNL4966LD E◆A	229	26.8	\$1408	\$ 50	\$ 40
	HNL4960LD E◆A	212	24.5	\$1309	\$ 50	\$ 40
	HNL4948LD	175	26.4	\$1248	\$ 45	\$ 20
	HNL4942LD	149	23.2	\$1095	\$ 45	\$ 20
	HNL4936LD	145	20.3	\$1059	\$ 45	\$ 20

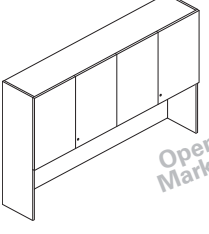
 <p>Stack-on Storage, Laminate Locking Doors</p> <p>78"W x 15"D x 48$\frac{3}{4}$"H — 4 doors, 2 compartments</p> <p>72"W x 15"D x 48$\frac{3}{4}$"H — 4 doors, 2 compartments</p> <p>66"W x 15"D x 48$\frac{3}{4}$"H — 4 doors, 2 compartments</p> <p>60"W x 15"D x 48$\frac{3}{4}$"H — 4 doors, 2 compartments</p> <p>48"W x 15"D x 48$\frac{3}{4}$"H — 3 doors, 2 compartments</p> <p>42"W x 15"D x 48$\frac{3}{4}$"H — 2 doors, 1 compartment</p> <p>36"W x 15"D x 48$\frac{3}{4}$"H — 2 doors, 1 compartment</p>	HNL4978LL E◆A	264	31.3	\$1699	\$ 60	\$ 40
	HNL4972LL E◆A	243	29.1	\$1570	\$ 50	\$ 40
	HNL4966LL E◆A	229	26.8	\$1488	\$ 50	\$ 40
	HNL4960LL E◆A	212	24.5	\$1389	\$ 50	\$ 40
	HNL4948LL	175	26.4	\$1288	\$ 45	\$ 20
	HNL4942LL	149	23.2	\$1135	\$ 45	\$ 20
	HNL4936LL	145	20.3	\$1099	\$ 45	\$ 20

▲ Lock available in Black (P) or Satin (SA) finish. Lock is core removable. Keyed alike cores must be ordered separately. For stack-on and wall mount storage with locking hinged doors, specify model HF27B (Black) or HF27S (Satin) and the key number, see page 116. Model HNL4948LL has one lock, which secures two of the three doors.

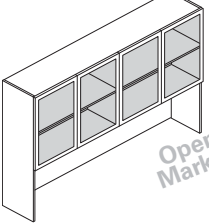
 <p>Stack-on Storage, Frosted Doors with Silver Frame</p> <p>78"W x 15"D x 48$\frac{3}{4}$"H — 4 doors, 2 compartments</p> <p>72"W x 15"D x 48$\frac{3}{4}$"H — 4 doors, 2 compartments</p> <p>66"W x 15"D x 48$\frac{3}{4}$"H — 4 doors, 2 compartments</p> <p>60"W x 15"D x 48$\frac{3}{4}$"H — 4 doors, 2 compartments</p> <p>48"W x 15"D x 48$\frac{3}{4}$"H — 3 doors, 2 compartments</p> <p>42"W x 15"D x 48$\frac{3}{4}$"H — 2 doors, 1 compartment</p> <p>36"W x 15"D x 48$\frac{3}{4}$"H — 2 doors, 1 compartment</p>	HNL4978FD E◆A	225	31.3	\$2519	\$ 60	N/A
	HNL4972FD E◆A	207	29.1	\$2390	\$ 50	N/A
	HNL4966FD E◆A	196	26.8	\$2308	\$ 50	N/A
	HNL4960FD E◆A	182	24.5	\$2209	\$ 50	N/A
	HNL4948FD	152	26.4	\$1923	\$ 45	N/A
	HNL4942FD	128	23.2	\$1545	\$ 45	N/A
	HNL4936FD	114	20.3	\$1509	\$ 45	N/A

▲ Frosted/silver door units do not have a lock option.

How to specify	<p>Select Model Number from above</p> <p>H N L 4 9 7 8 L D .</p>	<p>1st Option</p> <p>Select Chassis Color</p> <p>See page 51</p> <p>H .</p>	<p>2nd Option</p> <p>Select Door Front Color</p> <p>See page 51</p> <p>H </p>
----------------	--	---	--

How to specify	<p>Select Model Number from above</p> <p>H N L 4 9 7 8 L L .</p>	<p>1st Option</p> <p>Select Lock Finish</p> <p>See page 51</p> <p>P .</p>	<p>2nd Option</p> <p>Select Chassis Color</p> <p>See page 51</p> <p>H .</p>	<p>3rd Option</p> <p>Select Door Front Color</p> <p>See page 51</p> <p>H </p>
----------------	--	---	---	--

How to specify	<p>Select Model Number from above</p> <p>H N L 4 9 7 8 F D .</p>	<p>1st Option</p> <p>Select Chassis Color</p> <p>See page 51</p> <p>H </p>
----------------	--	---

Concinnity™ Stack-on Storage

GSA SIN as Noted



- ▶ Convenient off-the-worksurface storage requires no additional floor space.
- ▶ 48⁵/₈"H units have a fixed, intermittent shelf; storage space above and below the shelf is 12⁵/₈".
- ▶ Fully enclosed back provides privacy; includes a 1¹/₄", full-width pass-through for 3-prong electrical plugs; facilitates routing cords and reaching wall electrical outlets.
- ▶ Lower back panel can be attached with cord pass-through at bottom next to the worksurface or at top for close proximity to task light cord.
- ▶ Lower back panel can be removed to facilitate collaboration in teaming configurations.
- ▶ Valance hides task light.
- ▶ Vertical clearance for computer monitor is 20".
- ▶ Laminate vertical paper organizer (HLVPM1) sized to fit below storage compartments.
- ▶ Can be specified in seven widths (36", 42", 48", 60", 66", 72", and 78"W) and two heights, standard (35¹/₄"H) or executive (48⁵/₈"H).
- ▶ Available with laminate doors, frosted/silver doors, or sliding door.
- ▶ Doors are sized to overlap the top, end panels and light valance, to provide a clean design.
- ▶ Laminate and frosted/silver door units are equipped with self-closing, adjustable hinges.
- ▶ Laminate hinged door units are available with or without a lock.
- ▶ For tackboards, see below.
- ▶ For task lights, see page 117.
- ▶ For paper organizers, see page 114.

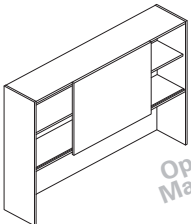

Description	Model	COM	Ship		L1 List	L2 Upcharges	
			Weight	Cube		Chassis	Fronts
 <p>Stack-on Storage, Sliding Door 78"W x 15"D x 48⁵/₈"H 72"W x 15"D x 48⁵/₈"H 66"W x 15"D x 48⁵/₈"H 60"W x 15"D x 48⁵/₈"H 48"W x 15"D x 48⁵/₈"H</p> <p>NOTES: Sliding door units have one door per cabinet; standard with black lock, which is located on inside vertical support panel. Sliding door availability limited to select sizes.</p>	HNL4978SD E◆A		236	31.3	\$1642	\$ 60	\$ 20
	HNL4972SD E◆A		221	29.1	\$1554	\$ 50	\$ 20
	HNL4966SD E◆A		207	26.8	\$1519	\$ 50	\$ 20
	HNL4960SD E◆A		192	24.5	\$1339	\$ 50	\$ 20
	HNL4948SD		162	26.4	\$1274	\$ 45	\$ 20

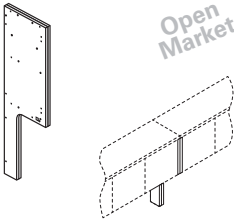
 <p>Stack-on Space Saver End Panels 3¹/₄"W x 14¹/₄"D x 48⁵/₈"H</p> <p>NOTES: Two field installable end panels (1-right; 1-left) for use in ganging two stack-on storage units. Combining stack-on allows users to span longer worksurfaces, including 84" (2 - 42"W), 96" (2 - 48"W), 120" (2 - 60"W), and 144" (2 - 72"W). Narrow, space-saving panel size replaces the full 15"D end panels to expand worksurface space. The 4¹/₄" right end panel is to replace the standard 15"D right end panel on one stack-on storage unit, the 4¹/₄" left end panel is to replace the standard 15"D left end panel on a separate, adjacent stack-on storage unit that is in linear alignment with the first unit. Kit includes: (2) narrow end panel supports; European-style fasteners; dowels; joint connector bolts with sleeve nuts (for ganging stack-on storage units). Can be used to connect up to two stack-on storage units in a line (requires 1 kit). Can be specified in a woodgrain or solid laminate color only.</p>	HNL4905SSEP		23	2.2	\$ 464	\$ 15	N/A
	<p>SPECIFYING EXAMPLE: HNL4905SSEP.H</p>						

 <p>Tackboards for use with Stack-on Storage 18"H</p> <p>SIN 711-2</p>	75"W - for 78"W	H90057	3	13	3.2	\$ 289	N/A	N/A
	68 ³ / ₄ "W - for 72"W	H90056	2	12	2.7	\$ 276	N/A	N/A
	62 ³ / ₄ "W - for 66"W	H90055	2	11	2.5	\$ 261	N/A	N/A
	56 ³ / ₄ "W - for 60"W	H90054	2	10	2.2	\$ 230	N/A	N/A
	44 ³ / ₄ "W - for 48"W	H90053	2	8	1.8	\$ 220	N/A	N/A
	39"W - for 42"W	H90052	2	7	1.6	\$ 202	N/A	N/A
	33"W - for 36"W	H90051	1	6	1.4	\$ 179	N/A	N/A
26 ³ / ₄ "W	H90050	1	5	1.2	\$ 179	N/A	N/A	

NOTES: Specify fabric, see pages 310-311. Upcharges may apply to premium fabric grades.

SPECIFYING EXAMPLE: H90057.APN15

How to specify	1st Option	2nd Option
<p>Select Model Number from above</p> <p>H N L 4 9 7 8 S D .</p>	<p>Select Chassis Color</p> <p>See page 51</p> <p>H .</p>	<p>Select Door Front Color</p> <p>See page 51</p> <p>H </p>

E◆A Icon Legend on page 10

- Installation (review carefully):
 - **Attachment requires individual cabinets be secured by a minimum of two (2) wall mounting locations/studs.**
 - **Designed for interior and perimeter walls that are constructed with wood or metal studs.**
 - **Attaches to wall with horizontally mounted, interlocking brackets.**
 - **The HON Company is not responsible for any liabilities resulting from wall mounted storage cabinets that are not properly installed.**
- Laminate, laminate locking, and frosted/silver door units can be specified in eight widths (30", 36", 42", 48", 60", 66", 72", and 78"W) and two heights, standard (15"H) or executive (29½"H).
- Sliding door units can be specified in five widths (48", 60", 66", 72", and 78"W) and two heights, standard (15"H) or executive (29½"H).
- Product placement can be aligned to match the height of 64¾"H or 78⅛"H storage- and wardrobe-type cabinets.
- Available with laminate doors, frosted/silver doors, or sliding door.
 - Door design overlaps end panels so that when multiple units are placed side-by-side they appear as one continuous unit.
 - Laminate and frosted/silver door units are equipped with self-closing, adjustable hinges.
 - Laminate hinged door units are available with or without a lock.
 - Lock available in Black (P) or Satin (SA).
 - Lock is core removable; keyed alike cores must be ordered separately — specify model HF27B or HF27S and the key number.
 - Frosted/silver hinged door units do not have a lock option.
 - Sliding door units have one door per cabinet; standard with black lock, which is located on inside vertical support panel.
 - Laminate and frosted/silver door cabinets in 30", 36", and 42"W have two doors; 48"W has three doors; 60", 66", 72", and 78"W have four doors.
- Inside storage dimensions of 15"H cabinets:
 - 30"W = one compartment, sized 28⅜"W x 13⅜"D x 12¾"H
 - 36"W = one compartment, sized 34⅜"W x 13⅜"D x 12¾"H
 - 42"W = one compartment, sized 40⅜"W x 13⅜"D x 12¾"H
 - 48"W = two compartments, one sized 30⅝"W x 13⅜"D x 12¾"H; one sized 14⅝"W x 13⅜"D x 12¾"H
 - 60"W = two compartments, each 28⅝"W x 13⅜"D x 12¾"H
 - 66"W = two compartments, each 31⅝"W x 13⅜"D x 12¾"H
 - 72"W = two compartments, each 34⅝"W x 13⅜"D x 12¾"H
 - 78"W = two compartments, each 37⅝"W x 13⅜"D x 12¾"H
- 28½"H units have a fixed, intermittent shelf; storage space above and below the shelf is 12⅝".
- Wall mounted storage cabinets are not designed for attachment to O-leg models HL650S or HL500S.
- **Horizontal interlocking rails are included; due to varying types of walls, installers are responsible for selecting and supplying the appropriate fasteners.**
- Ship fully assembled.

OPTIONS INCLUDE:

- Door/Storage Options:

Door(s)	Standard-Height	Executive-Height
Laminate	•	•
Laminate Locking	•	•
Frosted/Silver	•	•
Sliding	48"-78"W only	48"-78"W only

- Paper organizers for stack-on and wall mounted storage cabinets (see compatibility information on page 115).
- Fabric-Covered Tackboards:
 - Tackboards mount directly to wall using the fasteners or hook-and-loop tape provided.
 - Available in HON Group panel fabric grades A and B.
 - See compatibility cross reference below.
 - NOTE: Tackboard widths differ slightly from the wall mounted storage cabinet widths. For applications where multiple wall mounted storage units are placed side-by-side, the preferred tackboard solution may be to utilize a larger tackboard size. For example, H90057 = 75"W; H90056 = 68³/₄"W; H90055 = 62³/₄"W; H90054 = 56³/₄"W.
- Markerboards:
 - HLSL1530SOMB: 29¹/₂"W x 12¹/₂"H panel attaches to 60" and 66"W stack-on and wall mounted storage with sliding door models with double-sided tape.
 - HLSL1536SOMB: 35¹/₂"W x 12¹/₂"H panel attaches to 72" and 78"W stack-on and wall mounted storage with sliding door models with double-sided tape.
- Task Lights:
 - Attach to underside of stack-on and wall mount storage cabinets.
 - Fluorescent or LED options.
 - Compatibility: Tackboard and task light solutions, by model, for each wall mounted storage cabinet size:

Wall Mounted Storage	Tackboard	Fluorescent Task Light	LED Task Light
78"W	H90057 (75"W) or qty 2 of H90052 (39"W ea.)	HH870960, HH870960CH	HLED31A, HLED31AUO
72"W	H90056 (71 ¹ / ₂ "W)	HH870960, HH870960CH	HLED31A, HLED31AUO
66"W	H90055 (65 ¹⁵ / ₁₆ "W)	HH870960, HH870960CH	HLED31A, HLED17AUO
60"W	H90054 (59 ¹⁵ / ₁₆ "W)	HH870960, HH870960CH	HLED31A, HLED17AUO
48"W	H90053 (44 ³ / ₄ "W)	HH870942, HH870942CH	HLED31AS
42"W	H90052 (39"W)	HH870942, HH870942CH	HLED31AS
36"W	H90051 (33"W)	HH870930, HH870930CH	HLED17AS
30"W	H90050 (26 ³ / ₄ "W)	HH870930, HH870930CH	HLED17AS

Concinnity™ Wall Mount Storage

Not on GSA Contract



- ▶ Convenient off-the-worksurface storage requires no additional floor space.
- ▶ Available with laminate doors, frosted/silver doors, or sliding door.
- ▶ Doors are sized to overlap the top, end panels and light valance, to provide a clean design.
- ▶ Laminate and frosted/silver door units are equipped with self-closing, adjustable hinges.
- ▶ Laminate hinged door units are available with or without a lock.
- ▶ For tackboards, see page 78.
- ▶ For task lights, see page 117.
- ▶ For paper organizers, see page 114.
- ▶ **IMPORTANT: See installation guidelines at top of page 74.**

Description	Model	Ship Weight	Cube	L1 List	L2 Upcharges	
					Chassis	Fronts
Wall Mount Storage, Laminate Doors						
78"W x 15"D x 15"H — 4 doors, 2 compartments	HNL1578LD	126	17.1	\$1129	\$ 35	\$ 20
72"W x 15"D x 15"H — 4 doors, 2 compartments	HNL1572LD	118	15.9	\$1049	\$ 25	\$ 20
66"W x 15"D x 15"H — 4 doors, 2 compartments	HNL1566LD	109	14.6	\$ 999	\$ 25	\$ 20
60"W x 15"D x 15"H — 4 doors, 2 compartments	HNL1560LD	100	13.3	\$ 897	\$ 25	\$ 20
48"W x 15"D x 15"H — 3 doors, 2 compartments	HNL1548LD	83	10.9	\$ 809	\$ 20	\$ 15
42"W x 15"D x 15"H — 2 doors, 1 compartment	HNL1542LD	68	9.7	\$ 764	\$ 20	\$ 10
36"W x 15"D x 15"H — 2 doors, 1 compartment	HNL1536LD	60	8.4	\$ 697	\$ 20	\$ 10
30"W x 15"D x 15"H — 2 doors, 1 compartment	HNL1530LD	51	7.2	\$ 644	\$ 20	\$ 10
Wall Mount Storage, Laminate Locking Doors						
78"W x 15"D x 15"H — 4 doors, 2 compartments	HNL1578LL	126	17.1	\$1209	\$ 35	\$ 20
72"W x 15"D x 15"H — 4 doors, 2 compartments	HNL1572LL	118	15.9	\$1129	\$ 25	\$ 20
66"W x 15"D x 15"H — 4 doors, 2 compartments	HNL1566LL	109	14.6	\$1079	\$ 25	\$ 20
60"W x 15"D x 15"H — 4 doors, 2 compartments	HNL1560LL	100	13.3	\$ 977	\$ 25	\$ 20
48"W x 15"D x 15"H — 3 doors, 2 compartments	HNL1548LL	83	10.9	\$ 849	\$ 20	\$ 15
42"W x 15"D x 15"H — 2 doors, 1 compartment	HNL1542LL	68	9.7	\$ 804	\$ 20	\$ 10
36"W x 15"D x 15"H — 2 doors, 1 compartment	HNL1536LL	60	8.4	\$ 737	\$ 20	\$ 10
30"W x 15"D x 15"H — 2 doors, 1 compartment	HNL1530LL	51	7.2	\$ 684	\$ 20	\$ 10
⚠ Lock available in Black (P) or Satin (SA) finish. Lock is core removable. Keyed alike cores must be ordered separately. For stack-on and wall mount storage with locking hinged doors, specify model HF27B (Black) or HF27S (Satin) and the key number, see page 116. Model HNL1548LL has one lock, which secures two of the three doors.						
Wall Mount Storage, Frosted Doors with Silver Frame						
78"W x 15"D x 15"H — 4 doors, 2 compartments	HNL1578FD	106	17.1	\$1729	\$ 35	N/A
72"W x 15"D x 15"H — 4 doors, 2 compartments	HNL1572FD	99	15.9	\$1649	\$ 25	N/A
66"W x 15"D x 15"H — 4 doors, 2 compartments	HNL1566FD	92	14.6	\$1599	\$ 25	N/A
60"W x 15"D x 15"H — 4 doors, 2 compartments	HNL1560FD	85	13.3	\$1497	\$ 25	N/A
48"W x 15"D x 15"H — 3 doors, 2 compartments	HNL1548FD	71	10.9	\$1259	\$ 20	N/A
42"W x 15"D x 15"H — 2 doors, 1 compartment	HNL1542FD	57	9.7	\$1064	\$ 20	N/A
36"W x 15"D x 15"H — 2 doors, 1 compartment	HNL1536FD	50	8.4	\$ 997	\$ 20	N/A
30"W x 15"D x 15"H — 2 doors, 1 compartment	HNL1530FD	43	7.2	\$ 944	\$ 20	N/A
⚠ Frosted door models do not have a lock option.						
Wall Mount Storage, Sliding Door						
78"W x 15"D x 15"H	HNL1578SD	114	17.1	\$1099	\$ 35	\$ 20
72"W x 15"D x 15"H	HNL1572SD	107	15.9	\$1009	\$ 25	\$ 20
66"W x 15"D x 15"H	HNL1566SD	99	14.6	\$ 939	\$ 25	\$ 20
60"W x 15"D x 15"H	HNL1560SD	91	13.3	\$ 854	\$ 25	\$ 20
48"W x 15"D x 15"H	HNL1548SD	76	10.9	\$ 799	\$ 20	\$ 20

NOTES: One door per unit. Standard with black lock, which is located on the inside vertical support panel.

How to specify	Select Model Number from above H N L 1 5 7 8 L D .	1st Option Select Chassis Color See page 51 H .	2nd Option Select Door Front Color See page 51 H 	
How to specify	Select Model Number from above H N L 1 5 7 8 L L .	1st Option Select Lock Finish See page 51 P .	2nd Option Select Chassis Color See page 51 H .	3rd Option Select Door Front Color See page 51 H
How to specify	Select Model Number from above H N L 1 5 7 8 F D .	1st Option Select Chassis Color See page 51 H 		
How to specify	Select Model Number from above H N L 1 5 7 8 S D .	1st Option Select Chassis Color See page 51 H .	2nd Option Select Door Front Color See page 51 H 	

ABJ Icon Legend on page 10

- ▶ Convenient off-the-worksurface storage requires no additional floor space.
- ▶ Available with laminate doors, frosted/silver doors, or sliding door.
- ▶ Doors are sized to overlap the top, end panels and light valance, to provide a clean design.
- ▶ Laminate and frosted/silver door units are equipped with self-closing, adjustable hinges.
- ▶ Laminate hinged door units are available with or without a lock.
- ▶ 28½"H units have a fixed, intermittent shelf; storage space above and below the shelf is 12½".
- ▶ For tackboards, see page 78.
- ▶ For task lights, see page 117.
- ▶ For paper organizers, see page 114.
- ▶ **IMPORTANT: See installation guidelines at top of page 74.**



Description	Model	Ship Weight	Cube	L1 List	L2 Upcharges	
					Chassis	Fronts
Wall Mount Storage, Laminate Doors						
78"W x 15"D x 28½"H — 4 doors, 2 compartments	HNL2978LD	213	30.8	\$1369	\$ 50	\$ 40
72"W x 15"D x 28½"H — 4 doors, 2 compartments	HNL2972LD	199	28.6	\$1299	\$ 40	\$ 40
66"W x 15"D x 28½"H — 4 doors, 2 compartments	HNL2966LD	185	26.4	\$1259	\$ 40	\$ 40
60"W x 15"D x 28½"H — 4 doors, 2 compartments	HNL2960LD	170	24.1	\$1169	\$ 40	\$ 40
48"W x 15"D x 28½"H — 3 doors, 2 compartments	HNL2948LD	142	19.7	\$1064	\$ 35	\$ 30
42"W x 15"D x 28½"H — 2 doors, 1 compartment	HNL2942LD	116	17.4	\$ 874	\$ 35	\$ 20
36"W x 15"D x 28½"H — 2 doors, 1 compartment	HNL2936LD	101	15.2	\$ 832	\$ 35	\$ 20
30"W x 15"D x 28½"H — 2 doors, 1 compartment	HNL2930LD	87	12.9	\$ 742	\$ 35	\$ 20

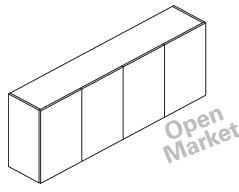

Wall Mount Storage, Laminate Locking Doors						
78"W x 15"D x 28½"H — 4 doors, 2 compartments	HNL2978LL	213	30.8	\$1449	\$ 50	\$ 40
72"W x 15"D x 28½"H — 4 doors, 2 compartments	HNL2972LL	199	28.6	\$1379	\$ 40	\$ 40
66"W x 15"D x 28½"H — 4 doors, 2 compartments	HNL2966LL	185	26.4	\$1339	\$ 40	\$ 40
60"W x 15"D x 28½"H — 4 doors, 2 compartments	HNL2960LL	170	24.1	\$1249	\$ 40	\$ 40
48"W x 15"D x 28½"H — 3 doors, 2 compartments	HNL2948LL	142	19.7	\$1104	\$ 35	\$ 30
42"W x 15"D x 28½"H — 2 doors, 1 compartment	HNL2942LL	116	17.4	\$ 914	\$ 35	\$ 20
36"W x 15"D x 28½"H — 2 doors, 1 compartment	HNL2936LL	101	15.2	\$ 872	\$ 35	\$ 20
30"W x 15"D x 28½"H — 2 doors, 1 compartment	HNL2930LL	87	12.9	\$ 782	\$ 35	\$ 20

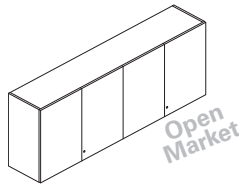

△ **Lock available in Black (P) or Satin (SA) finish. Lock is core removable. Keyed alike cores must be ordered separately. For stack-on and wall mount storage with locking hinged doors, specify model HF27B (Black) or HF27S (Satin) and the key number, see page 116. Model HNL2948LL has one lock, which secures two of the three doors.**

Wall Mount Storage, Frosted Doors with Silver Frame						
78"W x 15"D x 28½"H — 4 doors, 2 compartments	HNL2978FD	174	30.8	\$2269	\$ 50	N/A
72"W x 15"D x 28½"H — 4 doors, 2 compartments	HNL2972FD	163	28.6	\$2199	\$ 40	N/A
66"W x 15"D x 28½"H — 4 doors, 2 compartments	HNL2966FD	152	26.4	\$2159	\$ 40	N/A
60"W x 15"D x 28½"H — 4 doors, 2 compartments	HNL2960FD	140	24.1	\$2069	\$ 40	N/A
48"W x 15"D x 28½"H — 3 doors, 2 compartments	HNL2948FD	118	19.7	\$1739	\$ 35	N/A
42"W x 15"D x 28½"H — 2 doors, 1 compartment	HNL2942FD	94	17.4	\$1324	\$ 35	N/A
36"W x 15"D x 28½"H — 2 doors, 1 compartment	HNL2936FD	83	15.2	\$1282	\$ 35	N/A
30"W x 15"D x 28½"H — 2 doors, 1 compartment	HNL2930FD	72	12.9	\$1192	\$ 35	N/A

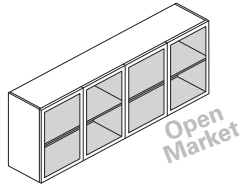

△ **Frosted door models do not have a lock option.**

How to specify	Select Model Number from above H N L 2 9 7 8 L D .	1st Option Select Chassis Color See page 51 H .	2nd Option Select Door Front Color See page 51 H
----------------	---	---	--

How to specify	Select Model Number from above H N L 2 9 7 8 L L .	1st Option Select Lock Finish See page 51 P .	2nd Option Select Chassis Color See page 51 H .	3rd Option Select Door Front Color See page 51 H
----------------	---	---	---	--

How to specify	Select Model Number from above H N L 2 9 7 8 F D .	1st Option Select Chassis Color See page 51 H
----------------	---	---

△ Icon Legend on page 10

Concinnity™ Wall Mount Storage

GSA SIN as Noted



- ▶ Convenient off-the-worksurface storage requires no additional floor space.
- ▶ Valance hides task light.
- ▶ Available with laminate doors, frosted/silver doors, or sliding door.
- ▶ Doors are sized to overlap the top, end panels and light valance, to provide a clean design.
- ▶ Laminate and frosted/silver door units are equipped with self-closing, adjustable hinges.
- ▶ Laminate hinged door units are available with or without a lock.
- ▶ 28½”H units have a fixed, intermittent shelf; storage space above and below the shelf is 12⅝”.
- ▶ For tackboards, see below.
- ▶ For task lights, see page 117.
- ▶ For paper organizers, see page 114.
- ▶ **IMPORTANT: See installation guidelines at top of page 74.**

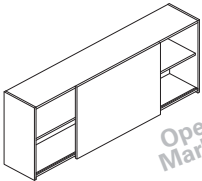

Description	Model	COM	Ship		L1 List	L2 Upcharges	
			Weight	Cube		Chassis	Fronts
 <p>Wall Mount Storage, Sliding Door 78”W x 15”D x 28½”H 72”W x 15”D x 28½”H 66”W x 15”D x 28½”H 60”W x 15”D x 28½”H 48”W x 15”D x 28½”H</p> <p>Open Market</p>	HNL2978SD E◆A		189	30.8	\$1424	\$ 50	\$ 40
	HNL2972SD E◆A		177	28.6	\$1359	\$ 40	\$ 40
	HNL2966SD E◆A		165	26.4	\$1327	\$ 40	\$ 40
	HNL2960SD E◆A		153	24.1	\$1242	\$ 40	\$ 40
	HNL2948SD E◆A		129	19.7	\$1089	\$ 35	\$ 30

NOTES: One door per unit. Standard with black lock, which is located on the inside vertical support panel.

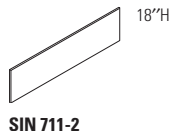

Description	Model	COM	Weight	Cube	List	Chassis	Fronts
Tackboards for use with Wall Mount Storage							
75”W - for 78”W	H90057	3	13	3.2	\$ 289	N/A	N/A
68¾”W - for 72”W	H90056	2	12	2.7	\$ 276	N/A	N/A
62¾”W - for 66”W	H90055	2	11	2.5	\$ 261	N/A	N/A
56¾”W - for 60”W	H90054	2	10	2.2	\$ 230	N/A	N/A
44¾”W - for 48”W	H90053	2	8	1.8	\$ 220	N/A	N/A
39”W - for 42”W	H90052	2	7	1.6	\$ 202	N/A	N/A
33”W - for 36”W	H90051	1	6	1.4	\$ 179	N/A	N/A
26¾”W	H90050	1	5	1.2	\$ 179	N/A	N/A

NOTES: Specify fabric, see pages 310-311. Upcharges may apply to premium fabric grades.

Tackboard widths differ slightly from the wall mounted storage cabinet widths. For applications where multiple wall mounted storage units are placed side-by-side, the preferred tackboard solution may be to utilize a larger tackboard size. For example, H90057 = 75”W; H90056 = 68¾”W; H90055 = 62¾”W; H90054 = 56¾”W.

SPECIFYING EXAMPLE: H90057.APN15

How to specify	1st Option	2nd Option
Select Model Number from above H N L 2 9 7 8 S D .	Select Chassis Color See page 51 H .	Select Door Front Color See page 51 H

E◆A Icon Legend on page 10

- ▶ Designed for use on worksurfaces, or on 30" or 36"W x 29 1/2"H lateral file or storage cabinet with doors.
- ▶ Two widths, 30" and 36"; two heights, 35 1/4" and 48 5/8".
- ▶ The 35 1/4"H unit has three shelves, two are adjustable in 1 1/4" increments with a total range of 17 1/2"; bottom shelf is fixed.
- ▶ The 48 5/8"H unit has four shelves, three are adjustable in 1 1/4" increments with a total range of 25"; bottom shelf is fixed.
- ▶ Available with laminate doors or frosted/silver doors or no doors (open).
- ▶ Door units equipped with self-closing, adjustable hinges.
- ▶ Laminate doors have decorative handles.
- ▶ Frosted door units have push/touch latch release.
- ▶ Doors are non-locking.
- ▶ To align with the top of the 35 1/4"H bookcase hutch, use 64 3/4"H floor-standing storage models; to align with the top of the 48 5/8"H bookcase hutch, use 78 1/2"H models.
- ▶ Ship fully assembled.



Description	Model	Ship Weight	Cube	L1 List	L2 Upcharges	
					Chassis	Fronts
Bookcase Hutch, No Doors/Open 36"W x 14 1/4"D x 35 1/4"H (shown) 30"W x 14 1/4"D x 35 1/4"H 36"W x 14 1/4"D x 48 5/8"H 30"W x 14 1/4"D x 48 5/8"H	HNL3636BHxD	213	15.3	\$ 529	\$ 15	N/A
	HNL3630BHxD	199	12.5	\$ 517	\$ 15	N/A
	HNL4936BHxD	213	125.0	\$ 669	\$ 25	N/A
	HNL4930BHxD	199	109.0	\$ 624	\$ 25	N/A
Bookcase Hutch, Laminate Doors 36"W x 15"D x 35 1/4"H (shown) 30"W x 15"D x 35 1/4"H 36"W x 15"D x 48 5/8"H 30"W x 15"D x 48 5/8"H	HNL3636BHLD	213	15.3	\$ 684	\$ 15	\$ 20
	HNL3630BHLD	199	12.5	\$ 642	\$ 15	\$ 20
	HNL4936BHLD	213	165.0	\$ 819	\$ 25	\$ 30
	HNL4930BHLD	199	142.0	\$ 769	\$ 25	\$ 30
Bookcase Hutch, Frosted Doors with Silver Frame 36"W x 15"D x 35 1/4"H (shown) 36"W x 15"D x 48 5/8"H	HNL3636BHFD	199	15.3	\$1284	\$ 15	N/A
	HNL4936BHFD	213	134.0	\$1569	\$ 25	N/A

How to specify	Select Model Number from above H N L 3 6 3 6 B H X D . H 	1st Option Select Laminate Color See page 51
----------------	---	--

How to specify	Select Model Number from above H N L 3 6 3 6 B H L D . E .	1st Option Select Handle A Cylinder – Satin B Cylinder – Black C Canopy – Satin D Canopy – Black E Loop – Satin F Loop – Black	2nd Option Select Chassis Color See page 51 H .	3rd Option Select Door Front Color See page 51 H
----------------	---	---	---	--

How to specify	Select Model Number from above H N L 3 6 3 6 B H F D . H 	1st Option Select Chassis Color See page 51
----------------	---	---

Icon Legend on page 10

Concinnity™ Reception Stations

GSA SIN as Noted



▶ Reception Station Counter for Desk, and L-Reception Station with Transaction Counter for Desk, have profiled edgeband on the approach and user sides.

△ **L-Reception Station with Transaction Counter for Desk and Return has profiled edgeband on front side of transaction counter on desk approach-side only.**

△ **For L-reception station layouts where the return is not against a wall, specify return using modular components, as the modesty/back panel can be specified without a grommet. Assembled returns come standard with cord grommet in modesty/back panel.**

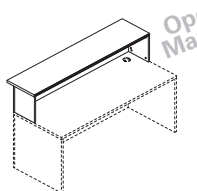
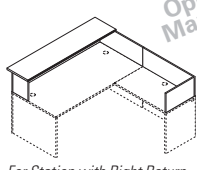
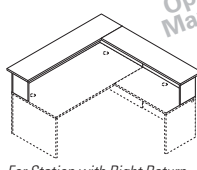
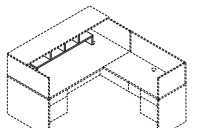

Description	Model	Ship Weight	Cube	L1 List	L2 Upcharges	
					Counter	Chassis
 <p>Reception Station Counter for Desk 72"W x 17"D x 14 5/8"H</p> <p>Open Market</p> <p>△ Compatible for use on 72"W x 30" or 36"D desktops and worksurfaces. For cleanest approach-side aesthetic, use on desk built with modular components; desk comprised of either 72"W x 30"D rectangle worksurface and 72"W x 27 7/8"H modesty/back panel, supported by 29 1/8"D pedestal(s) and/or end panel(s), or 72"W x 36"D worksurface and 72"W x 27 7/8"H modesty/back panel, supported by 35"D left and right end panels. The counter is 17"D with a 4" approach-side overhang; end panels are 12 3/8"D. Ships E♦A. Transaction counter organizer (model HTC0L52) is available as an option; fits under transaction counter; organizer is available in black only.</p> <p>SPECIFYING EXAMPLE: HNL1772RT.B.H.H.H</p>	HNL1772RT E♦A	74	4.3	\$ 499	\$ 10	\$ 15
 <p>L-Reception Station with Transaction Counter for Desk 72"W x 88"D x 14 5/8"H 72"W x 82"D x 14 5/8"H</p> <p>Open Market</p> <p>NOTES: Intended for use on desk built with modular components, for clean approach-side aesthetic, connected to a return or modular return. Layout for 78" and 84"D footprints:</p> <ul style="list-style-type: none"> • 72"W x 78"D: <ul style="list-style-type: none"> - Desk = 72"W x 30"D worksurface, 72"W x 27 7/8"H modesty/back panel, supported by 29 1/8"D pedestal(s) and/or end panel(s). - Return = 48"W x 24"D return; or 48"W x 24"D worksurface with vertical grain, 48"W x 27 7/8"H modesty/back panel, supported by a 23 1/8"D pedestal and/or end panel. • 72"W x 78"D: <ul style="list-style-type: none"> - Desk = 72"W x 36"D worksurface, 72"W x 27 7/8"H modesty/back panel, supported by 1-left and 1-right 35"D panel. - Return = 42"W x 24"D return; or 42"W x 24"D worksurface with vertical grain, 42"W x 27 7/8"H modesty/back panel, supported by a 23 1/8"D pedestal and/or end panel. • 72"W x 84"D: <ul style="list-style-type: none"> - Desk = 72"W x 36"D worksurface, 72"W x 27 7/8"H modesty/back panel, supported by 1-left and 1-right 35"D end panel. - Return = 48"W x 24"D return; or 48"W x 24"D worksurface with vertical grain, 48"W x 27 7/8"H modesty/back panel, supported by a 23 1/8"D pedestal and/or end panel. <p>△ Comprised of 17"D transaction counter, with 4" approach-side overhang, for the desk and a vertical privacy panel extending the depth of the desk and width of the return. Ships E♦A. Transaction counter organizer (model HTC0L52) is available as an option; fits under transaction counter; organizer is available in black only.</p> <p>SPECIFYING EXAMPLE: HNL8472RT.B.H.H.H</p>	HNL8472RT E♦A HNL7872RT E♦A	103 101	4.5 4.5	\$ 799 \$ 779	\$ 10 \$ 10	\$ 25 \$ 25
 <p>L-Reception Station with Transaction Counter for Desk and Return 76"W x 88"D x 14 5/8"H 76"W x 82"D x 14 5/8"H</p> <p>Open Market</p> <p>NOTES: Intended for use on desk built with modular components, for clean approach-side aesthetic, connected to a return or modular return. Layout for 78" and 84"D footprints:</p> <ul style="list-style-type: none"> • 72"W x 78"D: <ul style="list-style-type: none"> - Desk = 72"W x 30"D worksurface, 72"W x 27 7/8"H modesty/back panel, supported by 29 1/8"D pedestal(s) and/or end panel(s). - Return = 48"W x 24"D worksurface with vertical grain, 48"W x 27 7/8"H modesty/back panel, supported by a 23 1/8"D pedestal and/or end panel. • 72"W x 78"D: <ul style="list-style-type: none"> - Desk = 72"W x 36"D worksurface, 72"W x 27 7/8"H modesty/back panel, supported by 1-left and 1-right 35"D panel. - Return = 42"W x 24"D worksurface with vertical grain, 42"W x 27 7/8"H modesty/back panel, supported by a 23 1/8"D pedestal and/or end panel. • 72"W x 84"D: <ul style="list-style-type: none"> - Desk = 72"W x 36"D worksurface, 72"W x 27 7/8"H modesty/back panel, supported by 1-left and 1-right 35"D end panel. - Return = 48"W x 24"D worksurface with vertical grain, 48"W x 27 7/8"H modesty/back panel, supported by a 23 1/8"D pedestal and/or end panel. <p>△ The 17"D transaction counter, with 4" overhang, extends around the perimeter of the station, across the width of the desk, as well as along the depth of the desk and width of the return. Ships E♦A. Transaction counter organizer (model HTC0L52) is available as an option; fits under transaction counter; organizer is available in black only.</p> <p>SPECIFYING EXAMPLE: HNL8472RLT.B.H.H.H</p>	HNL8472RLT E♦A HNL7872RLT E♦A	145 139	5.6 5.6	\$ 957 \$ 924	\$ 20 \$ 20	\$ 25 \$ 25
 <p>Transaction Counter Organizer 48 3/4"W x 11 1/8"D x 13"H</p> <p>SIN 711-8</p> <p>NOTES: Fits under reception station counters. △ Black only.</p> <p>SPECIFYING EXAMPLE: HTC0L52.P</p>	HTC0L52 E♦A	24	1.1	\$ 252	N/A	N/A

How to specify	1st Option	2nd Option	3rd Option
Select Model Number from above H N L 1 7 7 2 R T .	Select Edge Profile and Edge Color See page 51 B H .	Select Counter Color See page 51 H .	Select Chassis Color See page 51 H

Icon Legend on page 10

▶ Mobile pedestals roll easily on four casters to provide convenient, flexible placement of personal storage needs.

▶ Drawers operate on steel ball bearing suspension with full extension.

▶ File drawers include hangrails for side-to-side letter and legal filing; and front-to-back for letter filing.

⚠ **28³/₈"H mobile pedestals are not designed for use with the 28¹/₂"H metal O-leg due to interference caused by (1) the O-leg worksurface attachment bracket, and (2) the external support channel on the underside of a 72", 66", and 60"W rectangle worksurface supported by O-leg(s).**



Description	Model	Ship Weight	Cube	L1 List	L2 Upcharges		
					Top	Chassis	Fronts
 <p>Mobile Pedestal — 15³/₄"W 15³/₄"W x 20¹/₈"D x 28³/₈"H, Box/Box/File 15³/₄"W x 20¹/₈"D x 28³/₈"H, File/File 15³/₄"W x 20¹/₈"D x 21¹/₂"H, Box/File</p>	HNL2116MBBF	69	7.4	\$ 814	N/A	\$ 20	\$ 10
	HNL2116MFF	70	7.4	\$ 814	N/A	\$ 20	\$ 10
	HNL2116MBF	55	5.8	\$ 689	N/A	\$ 20	\$ 10
<p>NOTES: Well suited to a variety of office layouts, including private, open floor plan, and cubicle workspaces. Design positions the center of gravity towards the back of the cabinet to inhibit tipping. All drawers lock; interchangeable core removable lock makes re-keying quick and easy. Finish of lock is determined by, and aligned with, the handle finish specified. Keyed alike cores must be ordered separately; specify model HF23B (Black) or HF23S (Satin) and specific key number required. Pedestals, excluding cushion option, are sized to be positioned under 29¹/₂"H workspaces. Seat cushion model HLSL2016PH2 is optional. Cushion adds 1" to the height of the pedestal. Box/File unit with cushion will fit below 29¹/₂"H worksurface. ³/₄" thick top with flat edgeband; back inside end panel construction. Ships fully assembled.</p> <p>SPECIFYING EXAMPLE: HNL2116MBBF.E.H.H</p>							

Open Market

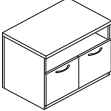
 <p>Mobile Pedestal — 30"W 30"W x 20"D x 21¹/₂"H, Shelf/File/Cabinet</p>	HNL2030MSFC	105	10.7	\$1024	N/A	\$ 10	\$ 25
	<p>NOTES: Sized to align with 20"D x 20¹/₂"H low credenzas. Open shelf over file drawer left and cabinet with door right. Design positions the center of gravity towards the back of the cabinet to inhibit tipping. Seat cushion model HLSL2030CH2 is optional. Cushion adds 1" to the height of the pedestal. 1¹/₈" thick top matches low credenza design. Ships fully assembled.</p> <p>SPECIFYING EXAMPLE: HNL2030MSFC.B.H.E.H.H.H</p>						

Open Market

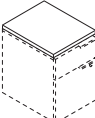
Description	Model	Ship Weight	Cube						
				1	2	3	4	5	6
 <p>Mobile Pedestal Cushion 15³/₈"W x 20"D x 1"H 30"W x 20"D x 1"H</p>	HLSL2016PH2	6	1.1	\$ 273	\$ 297	\$ 321	\$ 345	\$ 376	\$ 407
	HLSL2030CH2	9	1.9	\$ 328	\$ 364	\$ 400	\$ 436	\$ 482	\$ 529
<p>NOTES: See pages 488-497 and 522-523 for available fabrics.</p> <p>SPECIFYING EXAMPLE: HLSL2016PH2.AB10</p>									

SIN 711-2 - HLSL2016PH2
 SIN 711-3 - HLSL2030CH2

How to specify	1st Option	2nd Option	3rd Option
<p>Select Model Number from above</p> <p>H N L 2 1 1 6 M B B F . E .</p>	<p>Select Handle</p> <p>A Cylinder – Satin B Cylinder – Black C Canopy – Satin D Canopy – Black E Loop – Satin F Loop – Black</p> <p>E .</p>	<p>Select Chassis Color</p> <p>See page 51</p> <p>H .</p>	<p>Select Drawer Front Color</p> <p>See page 51</p> <p>H </p>

How to specify	1st Option	2nd Option	3rd Option	4th Option	5th Option
<p>Select Model Number from above</p> <p>H N L 2 0 3 0 M S F C . B H .</p>	<p>Select Edge Profile and Edge Color</p> <p>See page 51</p> <p>B H .</p>	<p>Select Handle</p> <p>A Cylinder – Satin B Cylinder – Black C Canopy – Satin D Canopy – Black E Loop – Satin F Loop – Black</p> <p>E .</p>	<p>Select Top Color</p> <p>See page 51</p> <p>H .</p>	<p>Select Chassis Color</p> <p>See page 51</p> <p>H .</p>	<p>Select Drawer/Door Front Color</p> <p>See page 51</p> <p>H </p>

► Drawers include hangrails to accept folders in letter or legal size.



Open Market

Description	Model	Ship Weight	Cube	L1 List	L2 Upcharges		
					Top	Chassis	Fronts
Lateral File							
36"W x 24"D x 29½"H, 2-Drawer	HNL2436LD2	178	18.4	\$1059	\$ 15	\$ 20	\$ 20
36"W x 24"D x 45½"H, 3-Drawer	HNL2436LD3	222	26.0	\$1599	\$ 15	\$ 25	\$ 25
36"W x 24"D x 59½"H, 4-Drawer	HNL2436LD4	276	34.3	\$1929	\$ 15	\$ 30	\$ 30

NOTES: Equipped with safety restraints; mechanical interlock inhibits the extension of more than one drawer at a time; counterweight positions the center of gravity towards the back of the cabinet to inhibit tipping. 24" depth aligns evenly with credenzas, returns, storage cabinet, storage/file cabinet, storage cabinet/lateral file, wardrobe/storage cabinet, wardrobe/bookcase, storage towers, and 24"D modular components. 29½"H unit is sized to accommodate 36"W stack-on storage or bookcase hutch options. Drawers lock; interchangeable core removable lock makes re-keying quick and easy. Finish of lock is determined by, and aligned with, the handle finish specified. Keyed alike cores must be ordered separately; specify model HF23B (Black) or HF23S (Satin) and specific key number required. Ship fully assembled. 30"W two-drawer size can be specified and assembled using modular components.

SPECIFYING EXAMPLE: HNL2436LD2.B.H.E.H.H.H

How to specify	1st Option	2nd Option	3rd Option	4th Option	5th Option
<p>Select Model Number from above</p> <p>H N L 2 4 3 6 L D 4 .</p>	<p>Select Edge Profile and Edge Color</p> <p>See page 51</p> <p>B H .</p>	<p>Select Handle</p> <p>A Cylinder – Satin B Cylinder – Black C Canopy – Satin D Canopy – Black E Loop – Satin F Loop – Black</p> <p>E .</p>	<p>Select Top Color</p> <p>See page 51</p> <p>H .</p>	<p>Select Chassis Color</p> <p>See page 51</p> <p>H .</p>	<p>Select Drawer Front Color</p> <p>See page 51</p> <p>H </p>

Icon Legend on page 10

► Interchangeable core removable lock makes re-keying quick and easy.

► Finish of lock is determined by, and aligned with, the handle finish specified.

► Keyed alike cores must be ordered separately; specify model HF23B (Black) or HF23S (Satin) and specific key number required.

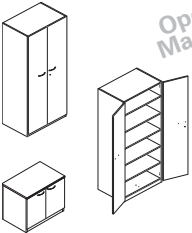

Description	Model	Ship Weight	Cube	L1 List	L2 Upcharges		
					Top	Chassis	Fronts
 <p>Storage Cabinet with Laminate Doors 36"W x 24"D x 29½"H 36"W x 24"D x 64¾"H 36"W x 24"D x 78⅞"H (shown)</p> <p>NOTES: 29½"H size has one adjustable interior shelf. Shelf adjusts in 1¼" increments over a total range of 6¼", 64¾"H and 78⅞" have five shelves (four adjustable) and six shelves (five adjustable), respectively; shelves adjust in 2½" increments. Locking doors. 24" depth aligns evenly with credenzas, returns, lateral files, storage/file cabinet, storage cabinet/lateral file, wardrobe/storage cabinet, wardrobe/bookcase, storage tower, bookcase with coat hook, and 24"D modular components. 29½"H unit is sized to accommodate 36"W stack-on storage or bookcase hutch options. Ships fully assembled. 30"W x 24"D x 29½"H freestanding unit can be built using modular components.</p> <p>SPECIFYING EXAMPLE (29½"H): HNL243629SC.B.H.E.H.H.H SPECIFYING EXAMPLE (64¾-78⅞"H): HNL243665SC.E.H.H</p>	HNL243629SC	158	18.4	\$ 942	\$ 15	\$ 20	\$ 20
	HNL243665SC	252	40.8	\$1964	\$ 40	\$ 30	\$ 40
	HNL243679SC	317	47.4	\$2089	\$ 45	\$ 35	\$ 45

 <p>Storage/File Cabinet 18"W x 24"D x 64¾"H, File/File, Laminate Door Hinged Right (shown) 18"W x 24"D x 64¾"H, File/File, Laminate Door Hinged Left 18"W x 24"D x 64¾"H, File/File, Open Shelves</p> <p>NOTES: Versatile unit features a storage cabinet plus two file drawers. Storage cabinet includes three shelves, two are adjustable; shelves adjust in 2½" increments. Can be specified with door hinged left, door hinged right, or no door/open shelves. File drawers operate on steel ball-bearing suspensions with full extension. File drawers include hangrails to accept folders in letter or legal size. Storage cabinet door and file drawers lock separately; the two locks are keyed alike. Unit height is designed to match desk, credenza, or return plus 35¼"H stack-on storage (= 64¾"). Ships fully assembled.</p> <p>SPECIFYING EXAMPLE (WITH DOOR): HNL241865SFLR.E.H.H SPECIFYING EXAMPLE (WITHOUT DOOR): HNL241865SFX.E.H.H</p>	HNL241865SFLR	184	21.6	\$1579	N/A	\$ 25	\$ 15
	HNL241865SFL	184	21.6	\$1579	N/A	\$ 25	\$ 15
	HNL241865SFX	169	21.6	\$1499	N/A	\$ 25	\$ 15

 <p>Storage Cabinet/Lateral File, Laminate Doors 36"W x 24"D x 64¾"H</p> <p>NOTES: Cabinet includes one fixed and two full-width adjustable shelves; adjustable shelves can be removed. Overall storage compartment measures 34"W x 22"D x 34½"H and will accommodate supplies, books and binders. Lateral file equipped with mechanical interlock to inhibit the extension of more than one drawer at a time. Lateral file drawers include hangrails to accept folders in letter or legal size. Storage cabinet and lateral file lock independently; upper lock secures cabinet; lower locks secure file drawers. Locks are keyed alike. Door hinges rotate to 94 degrees. Unit height is designed to match desk, credenza, or return plus 35¼"H stack-on storage (= 64¾"). Ships fully assembled.</p> <p>SPECIFYING EXAMPLE: HNL243665SLL.E.H.H</p>	HNL243665SLL	328	40.8	\$2119	N/A	\$ 55	\$ 30
---	--------------	-----	------	--------	-----	-------	-------

How to specify	1st Option	2nd Option	3rd Option	4th Option	5th Option
Select Model Number from above H N L 2 4 3 6 2 9 S C .	Select Edge Profile and Edge Color See page 51 B H .	Select Handle A Cylinder – Satin B Cylinder – Black C Canopy – Satin D Canopy – Black E Loop – Satin F Loop – Black E .	Select Top Color See page 51 H .	Select Chassis Color See page 51 H .	Select Drawer Front Color See page 51 H

How to specify	1st Option	2nd Option	3rd Option
Select Model Number from above H N L 2 4 3 6 6 5 S C . H N L 2 4 1 8 6 5 S F X .	Select Handle A Cylinder – Satin B Cylinder – Black C Canopy – Satin D Canopy – Black E Loop – Satin F Loop – Black E . E .	Select Chassis Color See page 51 H . H .	Select Drawer Front Color See page 51 H H

How to specify	1st Option	2nd Option	3rd Option
Select Model Number from above H N L 2 4 1 8 6 5 S F L R . H N L 2 4 3 6 6 5 S L L .	Select Handle A Cylinder – Satin B Cylinder – Black C Canopy – Satin D Canopy – Black E Loop – Satin F Loop – Black E . E .	Select Chassis Color See page 51 H . H .	Select Door/Drawer Front Color See page 51 H H

Icon Legend on page 10

- ▶ Heights designed to match desk, credenza, or return plus 35³/₄"H stack-on storage (= 64³/₄"H) or 48⁵/₈"H stack-on storage (= 78⁵/₈"H).
- ▶ Finish of locks is determined by, and aligned with, the handle finish specified.
- ▶ Keyed alike cores must be ordered separately; specify model HF23B (Black) or HF23S (Satin) and specific key number required.



Description	Model	Ship Weight	Cube	L1 List	L2 Upcharges	
					Chassis	Fronts
Wardrobe/Storage Cabinet, Laminate Doors — 36"W 36"W x 24"D x 64 ³ / ₄ "H 36"W x 24"D x 78 ⁵ / ₈ "H	HNL243665WL	284	40.8	\$2299	\$ 55	\$ 30
	HNL243679WL	303	40.8	\$2399	\$ 60	\$ 35

Open Market

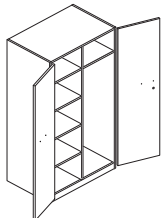
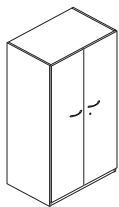

NOTES: Spacious design combines a cabinet with adjustable shelves and a generous personal wardrobe compartment with a coat rod and upper shelf. 64³/₄"H and 78⁵/₈"H have five shelves (four adjustable) and six shelves (five adjustable), respectively; shelves adjust in 2¹/₂" increments. One lock secures both doors. Ships fully assembled.

SPECIFYING EXAMPLE: HNL243665WL.E.H.H

Wardrobe/Storage Cabinet, Laminate Door — 18"W 18"W x 24"D x 64 ³ / ₄ "H, Hinged Right 18"W x 24"D x 64 ³ / ₄ "H, Hinged Left 18"W x 24"D x 78 ⁵ / ₈ "H, Hinged Right (shown) 18"W x 24"D x 78 ⁵ / ₈ "H, Hinged Left	HNL241865WLR	157	21.6	\$1442	\$ 25	\$ 15
	HNL241865WLL	157	21.6	\$1442	\$ 25	\$ 15
	HNL241879WLR	205	24.8	\$1574	\$ 30	\$ 20
	HNL241879WLL	205	24.8	\$1574	\$ 30	\$ 20

Open Market

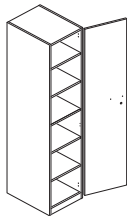

NOTES: Design includes coat rod and shelves. 64³/₄"H and 78⁵/₈"H have five shelves (four adjustable) and six shelves (five adjustable), respectively; shelves adjust in 2¹/₂" increments. Middle shelves can be removed to provide space for garments; coat rod can be removed for storage only applications. Lock to secure contents. Ships fully assembled.

SPECIFYING EXAMPLE: HNL241865WLR.E.H.H

Wardrobe/Bookcase, Laminate Door 36"W x 24"D x 64 ³ / ₄ "H, Wardrobe Left, Bookcase Right 36"W x 24"D x 64 ³ / ₄ "H, Wardrobe Right, Bookcase Left (shown) 36"W x 24"D x 78 ⁵ / ₈ "H, Wardrobe Left, Bookcase Right 36"W x 24"D x 78 ⁵ / ₈ "H, Wardrobe Right, Bookcase Left	HNL243665WLBR	230	40.8	\$2174	\$ 55	\$ 20
	HNL243665WRBL	230	40.8	\$2174	\$ 55	\$ 20
	HNL243679WLBR	302	47.4	\$2299	\$ 60	\$ 25
	HNL243679WRBL	302	47.4	\$2299	\$ 60	\$ 25

Open Market

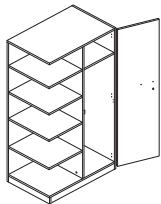
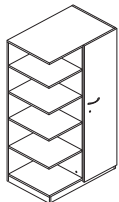

NOTES: Combination closed-door wardrobe closet and open shelf bookcase. 64³/₄"H and 78⁵/₈"H bookcases have five and six fixed shelves, respectively. Locking wardrobe compartment includes a coat rod and one shelf; shelf is positioned above the coat rod. Bookcase can be accessed from front or side. Left (L) model is wardrobe on left, bookcase on right; Right (R) model is wardrobe on right, bookcase on left. Ships fully assembled.

SPECIFYING EXAMPLE: HNL243665WRBL.E.H.H

How to specify	1st Option	2nd Option	3rd Option
Select Model Number from above H N L 2 4 3 6 6 5 W L	Select Handle A Cylinder – Satin B Cylinder – Black C Canopy – Satin D Canopy – Black E Loop – Satin F Loop – Black E	Select Chassis Color See page 51 H	Select Door Front Color See page 51 H

Icon Legend on page 10

- ▶ Equipped with interchangeable core removable locks.
- ▶ Finish of locks is determined by, and aligned with, the handle finish specified.
- ▶ Keyed alike cores must be ordered separately; specify model HF23B (Black) or HF23S (Satin) and specific key number required.



Description	Model	Ship Weight	Cube	L2 Upcharges		
				L1 List	Chassis	Fronts
Storage Towers, Laminate Doors — 24"W 24"W x 24"D x 64 ³ / ₄ "H, Wardrobe Hinged Left, Cabinet Hinged Right 24"W x 24"D x 64 ³ / ₄ "H, Wardrobe Hinged Right, Cabinet Hinged Left (shown) 24"W x 24"D x 78 ¹ / ₈ "H, Wardrobe Hinged Left, Cabinet Hinged Right 24"W x 24"D x 78 ¹ / ₈ "H, Wardrobe Hinged Right, Cabinet Hinged Left	HNL242465TLL	241	27.6	\$2029	\$ 60	\$ 35
	HNL242465TLR	241	27.6	\$2029	\$ 60	\$ 35
	HNL242479TLL	284	32.4	\$2229	\$ 70	\$ 45
	HNL242479TLR	284	32.4	\$2229	\$ 70	\$ 45

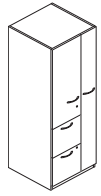

Open Market

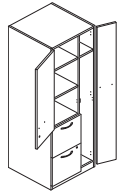

Open Market

NOTES: Versatile design includes a wardrobe closet, storage cabinet, and two file drawers, in one compact unit. Wardrobe contains a coat rod and upper shelf. 64³/₄"H and 78¹/₈"H cabinets have three shelves (two adjustable) and four shelves (three adjustable), respectively; shelves adjust in 2¹/₂" increments. File drawers operate on ball-bearing suspensions with full extension. File drawer design includes integrated hangrails for side-to-side letter or legal filing; and front-to-back for letter filing. Upper lock secures wardrobe closet and storage cabinet; lower lock secures file drawers; the two locks are keyed alike. Left (L) model is wardrobe hinged left, cabinet hinged right; Right (R) model is wardrobe hinged right, cabinet hinged left. Ships fully assembled.

SPECIFYING EXAMPLE: HNL242465TLR.E.H.H

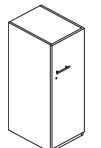

Hinged Right
HNL241850TLR shown

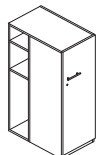

Hinged Right
HNL301850TLR shown

Storage Towers, Laminate Door — 50"H 18"W x 24"D x 50"H, Hinged Right 18"W x 24"D x 50"H, Hinged Left 18"W x 30"D x 50"H, Hinged Right 18"W x 30"D x 50"H, Hinged Left	HNL241850TLR	121	15.9	\$1129	\$ 50	\$ 35
	HNL241850TLL	121	15.9	\$1129	\$ 50	\$ 35
	HNL301850TLR	135	19.8	\$1257	\$ 50	\$ 35
	HNL301850TLL	135	19.8	\$1257	\$ 50	\$ 35

NOTES: Low profile design is well-suited for open plan layouts. Can be used next to 29¹/₂"H to standing, 42"H worksurfaces. Cabinet includes coat hook on back of door, perfect for jackets, sweaters, and purses. Two adjustable interior shelves, plus bottom of unit; shelves adjust in 2¹/₂" increments. 30"D size has a slim side-access storage space at rear of unit with two fixed interior shelves; the lower shelf is positioned to align with a 29¹/₂"H worksurface, the upper shelf with a 42"H worksurface. Hardware bag includes an extra coat hook which can be positioned on the side of the unit, below the worksurface; ideal for back packs. Left (L) model is door hinged left; Right (R) model is door hinged right. Worksurface tower bracket kit (model HSTB2W1) can be used to attach a worksurface directly to the tower. Bracket (1) eliminates the need for one end panel or O-leg support; (2) is not designed to be used as a support when a stack-on storage unit is placed over bracket. Ships fully assembled.

SPECIFYING EXAMPLE: HNL182450TLR.E.H.H

CABINET/WARDROBE/TOWER SOLUTIONS BY SIZE			
	Low/50"H	Standard/64 ³ / ₄ "H	Executive/78 ¹ / ₈ "H
Storage Cabinet with Doors		•	•
Storage/File Cabinet		•	
Storage Cabinet/Lateral File		•	
Wardrobe/Storage Cabinet		•	•
Wardrobe/Bookcase		•	•
Storage Tower		•	•
Storage Tower with Side Access on 30"D	•		
Bookcase with Coat Hook		•	

How to specify	1st Option	2nd Option	3rd Option
Select Model Number from above H N L 2 4 2 4 6 5 T L R .	Select Handle A Cylinder – Satin B Cylinder – Black C Canopy – Satin D Canopy – Black E Loop – Satin F Loop – Black E .	Select Chassis Color See page 51 H .	Select Door Front Color See page 51 E

Icon Legend on page 10

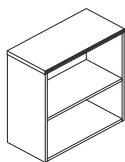

Open Market

Description	Model	Ship Weight	Cube	L1 List	L2 Upcharges	
					Top	Chassis
Bookcase with Adjustable Shelves						
30"W x 14 1/4"D x 29 1/2"H, 2-Shelf	HNL1530BK2	69	10.2	\$ 509	\$ 15	\$ 15
30"W x 14 1/4"D x 42"H, 3-Shelf	HNL1530BK3	95	14.1	\$ 579	\$ 15	\$ 20
30"W x 14 1/4"D x 52 3/4"H, 4-Shelf	HNL1530BK4	118	17.4	\$ 659	\$ 20	\$ 25
30"W x 14 1/4"D x 65"H, 5-Shelf	HNL1530BK5	143	21.1	\$ 762	\$ 25	\$ 30
30"W x 14 1/4"D x 78 1/8"H, 6-Shelf	HNL1530BK6	170	25.7	\$ 859	\$ 30	\$ 35

NOTES: Profiled top edge; choose from edge detail options. Number of total and adjustable shelves:

Height	Shelves	Adjustable Shelves
29 1/2"	2	1
42"	3	2
52 3/4"	4	3
65"	5	4
78 1/8"	6	5

3/4" thick shelves adjust in 1/4" increments. Inside shelf dimensions on all units are 28 1/2"W x 13 1/4"D. Ships fully assembled.

SPECIFYING EXAMPLE: HNL1530BK2.BH.H.H

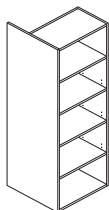

Open Market

Bookcase with Coat Hooks						
24"W x 24"D x 64 3/4"H, 5-Shelf, with Coat Hooks, Right (shown)	HNL2424BK5CR	133	27.6	\$ 868	\$ 25	\$ 30
24"W x 24"D x 64 3/4"H, 5-Shelf, with Coat Hooks, Left	HNL2424BK5CL	133	27.6	\$ 868	\$ 25	\$ 30

NOTES: Inside shelf dimensions are 28 1/2"W x 13 1/4"D. Two out of sight coat hooks for garments are secluded behind bookcase. One end panel measures 14 1/4"D, the other 24"D. "R" indicates coat hook access is on the right and the full 24"D end panel on the left; for use next to credenza or return with pedestal on right. "L" indicates coat hook access is on the left and the full 24"D end panel is on the right; for use next to credenza or return with pedestal on left. Unit height is designed to match desk, credenza, or return plus 35 1/4"H stack-on storage (= 64 3/4"). 3/4" thick, non-profiled top edge. Not available in two-tone laminate color combinations. Ships fully assembled.

SPECIFYING EXAMPLE: HNL2424BK5CR.H

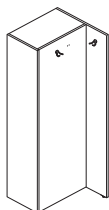

Back View

How to specify	1st Option	2nd Option	3rd Option
Select Model Number from above H N L 1 5 3 0 B K 2 .	Select Edge Profile and Edge Color See page 51 B H .	Select Top Color See page 51 H .	Select Chassis Color See page 51 H

How to specify	1st Option
Select Model Number from above H N L 2 4 2 4 B K 5 C R .	Select Laminate See page 51 H

Icon Legend on page 10

MODULAR COMPONENTS

- Smart, adaptable, reconfigurable assortment to maximize office layout flexibility and optimize floor space.
- Components for all popular office layouts.
- Selection allows user to choose their own workstation shape, size, and storage.
- Sizes for large and small spaces:
 - 36"D x 72"W or 84"W
 - 30"D — six sizes up to 84"W
 - 24"D — in 6" increments, from 30"W to 96"W
- Worksurfaces supported by post legs with casters provide added layout flexibility.
- Mobile desks quickly convert an office into a small conference space; desks roll easily and can be repositioned in seconds.
- Grommet options provide cord management from the top, side, and back in appropriate models.
- Broad menu of under-surface storage to enable user to specify the solution that best meets their individual needs.
 - Non-handed units can be configured to meet individual tastes and reconfigured when preferences or floor space requirements change.
 - Applications include:
 - The ability to "build" contiguous customized/personalized storage behind the desk that looks like custom architectural millwork, but at a fraction of the price. Allows for multiple storage pedestals to be configured under a single top with clean lines and no gaps.
 - Choosing the storage solution to go under desks, credenzas, and returns.

WORKSURFACES

- Available in a variety of shapes and sizes.
- Scratch-, stain-, and spill-resistant laminate over durable 1¹/₈" solid core high performance particleboard; resists warping.
- An external support channel, for attachment under worksurfaces, is required for all unsupported spans — a distance in which there is not a vertical support (point of contact) between the underside of the worksurface and the floor — greater than 54"W.
- For tri-oval and beaded edge options on tops with horizontal grain, there is a shaped profile on the user and approach sides, and a flat edge on the ends.
- For tri-oval and beaded edge options on tops with vertical grain, there is a shaped profile on the user side and a flat edge on the approach side and the ends.
- Grommets are an option and require specification. If grommets are selected, grommets come in a pre-determined location.
- Must be specified with support components; for pedestal, end panel, column, and leg options, see "Components — Supports" listings.

SUPPORTS

- For use with rectangle, bow, bullet, and extended corner worksurfaces.
- Available in 28¹/₂" and 41"H.
- Adjustable hex glides allow floor-standing units to be easily leveled, without lifting, to compensate for uneven floors; glides have 1¹/₄" adjustable range on most components; 2" on O-legs.
- Bottom of laminate end panels are edge banded for added strength and to seal out moisture.

FOR 29¹/₂" H WORKSURFACES

- Specify from a broad assortment of solutions, including —
 - Modular Pedestals
 - Laminate end panels (must be used in conjunction with a laminate modesty panel)
 - Laminate L-shaped end panels
 - Laminate T-shaped end panels
 - Metal O-legs — for use with worksurfaces up to 78"W (when using an 84" or wider worksurface, cannot use two O-legs; must use at least one 15³/₄" or wider pedestal for the other support).
 - 4¹/₂" diameter metal column
 - 2" square metal post leg

FOR 42" H WORKSURFACES

- 42", fixed standing-height workstations give users the option of changing postures from sitting to standing throughout the day to help achieve their wellness goals.
- Specify supports from —
 - Modular Pedestals
 - Laminate end panels (must be used in conjunction with a laminate modesty panel)
 - Laminate L-shaped end panels
 - Metal O-legs
- When combined with a stool-height task chair, provides users the benefit of alternating their work between a seated or standing position.
- An external support channel, for attachment under worksurfaces, is required for all unsupported spans greater than 54"W.
- Worksurface End Support (panel, leg, column, base, pedestal) requirements by product type are as follows —
 - Desk, peninsula, or credenza — qty. 2
 - Return — qty. 1
 - Island extension — qty. 1

COORDINATE™ HEIGHT ADJUSTABLE BASE

- Height adjustable bases deliver a healthier style of working by allowing a seamless transition between sitting and standing throughout the day. For open, private, or training spaces.
- Frame rises from 23⁵/₈" to 49¹/₄".
- Telescoping base design.
- Accommodates rectangle worksurface sizes 24" to 36"D and 48" to 72"W.
- Standard-height adjustable control included with base. Optional memory control allows preset worksurface heights for consistency — ships separately.
- Shipped complete with a pre-assembled electric motor.

Concinnity™ Components — Worksurfaces

Not on GSA Contract



- ▶ Grain direction on all rectangle worksurfaces runs horizontal (side-to-side) except as follows: 30"W - 36"W - 42"W - 48"W - 54"W - 60"W x 24"D tops can be specified with horizontal (side-to-side) or vertical (front-to-back) grain.
- ▶ 42"W and 48"W x 20"D tops are available with vertical (front-to-back) grain only.

- ▶ 48" - 72"W x 24" - 30"D worksurfaces are compatible for use with height-adjustable electric base model HHAB3S24F.
- ▶ For standing-height requirements, use worksurface with 41"H O-leg, end panel, L-shaped end panel, or pedestal supports.
- ▶ For mobile desks and tables, use post leg with casters.

- ▲ **Attachment of above privacy screen models requires a minimum 1" clear space/overhang on the underside of worksurface.**
- ▲ **Attachment of above/below privacy screen models requires a minimum 2" clear space/overhang on the underside of the worksurface.**

- ▲ **Steel external support channel can be attached to the underside of worksurfaces that are subjected to heavier loads. Channel is recommended to provide extra support on unsupported spans of 54"W or greater or per user preference. Ordered separately from worksurface.**
- ▲ **If using a 54"W or 60"W floating modesty panel, it is not necessary to specify an external support channel.**

- ▲ **When using an external support channel under the worksurface, the depth clearance for center drawers and keyboard platforms decreases by 8".**
- ▲ **See "External Channel (Recommended Use)" chart on page 93.**

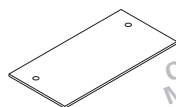

Open Market

Description	Model	Ship Weight	Cube	L1 List Price	L2 Upcharge
Rectangle Worksurface with Horizontal Grain					
84"W x 36"D	HNLRC3684	105	7.7	\$ 579	\$ 30
72"W x 36"D (shown)	HNLRC3672	90	6.7	\$ 484	\$ 30
84"W x 30"D	HNLRC3084	88	6.5	\$ 464	\$ 25
78"W x 30"D	HNLRC3078	81	6.1	\$ 419	\$ 25
72"W x 30"D	HNLRC3072	75	5.6	\$ 384	\$ 20
66"W x 30"D	HNLRC3066	69	5.2	\$ 353	\$ 20
60"W x 30"D	HNLRC3060	62	4.7	\$ 330	\$ 20
48"W x 30"D	HNLRC3048	50	3.9	\$ 269	\$ 15
96"W x 24"D	HNLRC2496	80	5.8	\$ 464	\$ 30
90"W x 24"D	HNLRC2490	75	5.5	\$ 454	\$ 30
84"W x 24"D	HNLRC2484	70	5.3	\$ 430	\$ 25
78"W x 24"D	HNLRC2478	65	4.9	\$ 383	\$ 20
72"W x 24"D	HNLRC2472	60	4.6	\$ 319	\$ 20
66"W x 24"D	HNLRC2466	55	4.2	\$ 307	\$ 20
60"W x 24"D	HNLRC2460	50	3.9	\$ 284	\$ 20
54"W x 24"D	HNLRC2454	45	3.5	\$ 259	\$ 20
48"W x 24"D	HNLRC2448	40	3.1	\$ 239	\$ 15
42"W x 24"D	HNLRC2442	35	2.8	\$ 222	\$ 15
36"W x 24"D Rectangle Worksurface/Pedestal Top	HNLRC2436	30	2.4	\$ 199	\$ 15
30"W x 24"D Rectangle Worksurface/Pedestal Top	HNLRC2430	25	2.1	\$ 199	\$ 15

NOTES: See chart on page 58 for cord management options.

- ▲ **When grommets are specified for 30"D and 36"D rectangle worksurfaces, pre-drilled holes will not be included for a 4 1/2" diameter support column.**

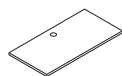

Open Market

Description	Model	Ship Weight	Cube	L1 List Price	L2 Upcharge
Rectangle Worksurface with Vertical Grain					
60"W x 24"D	HNLRC2460V	50	3.9	\$ 284	\$ 20
54"W x 24"D	HNLRC2454V	45	3.5	\$ 259	\$ 20
48"W x 24"D (shown)	HNLRC2448V	40	3.1	\$ 239	\$ 15
42"W x 24"D	HNLRC2442V	35	2.8	\$ 222	\$ 15
36"W x 24"D Rectangle Worksurface/Pedestal Top	HNLRC2436V	30	2.4	\$ 199	\$ 15
30"W x 24"D Rectangle Worksurface/Pedestal Top	HNLRC2430V	25	2.1	\$ 199	\$ 15
48"W x 20"D	HNLRC2048V	33	2.7	\$ 228	\$ 10
42"W x 20"D	HNLRC2042V	29	2.3	\$ 209	\$ 10

NOTES: Can be used in a host of applications, including as a desk, credenza, return, bridge, stationary or mobile table surface, in U- or L-shaped configurations, as part of a work wall layout with an island extension, or with the height-adjustable electric base. The conference overhang dimension on the approach side of worksurfaces varies depending on the supports and modesty panels specified. Top can be positioned with a cantilevered conference overhang on one end when used with select worksurface supports, including an O-leg or 9 1/2"W modular pedestal. For return applications in which there is an unsupported span wider than 54", such as a 72"W x 24"D worksurface supported by a 15 3/4"W modular pedestal (= 56 1/4") or a 60"W x 24"D worksurface supported by a 1 1/8" thick end panel (= 58 7/8"), use internal support panel model HNL11SUPP. For bridges wider than 54", use internal support panel HNL11SUPP. When using a 30"W, 36"W, 42"W, or 48"W rectangle worksurface as a bridge, no support legs are needed. When specifying a 84"W, 90"W, or 96"W worksurface, cannot use two O-legs for the supports. In these applications, the maximum number of supports that can be an O-leg is one; must choose from a 15 3/4" or wider modular pedestal for use as the additional support component. For applications requiring connection to an adjoining worksurface, two flat brackets are included with 24"D and 20"D worksurfaces that are ≤48"W; one flat bracket is included with 24"D worksurfaces that are ≥54"W. Underside of worksurface includes pilot mounting holes for O-leg, 1 1/8" thick laminate end panel, pedestals, and flat brackets. See chart on page 58 for cord management options.

- ▲ **When grommets are specified for 30"D and 36"D rectangle worksurfaces, pre-drilled holes will not be included for a 4 1/2" diameter support column.**

How to specify	1st Option	2nd Option	3rd Option
Select Model Number from above	Select Edge Profile and Edge Color See page 51	Select Worksurface Grommet Finish P Black T1 Platinum X No Grommet	Select Worksurface Color See page 51
H N L R C 3 6 8 4 .	B H .	P .	H

ABJ ▲ Icon Legend on page 10

⚠ When specifying an 84"W size, cannot use two 0-legs; must use another type of support component such as a pedestal.

⚠ Steel external support channel can be attached to the underside of worksurfaces that are subjected to heavier loads. Channel is recommended to provide extra support on unsupported spans of 54"W or greater or per user preference. Ordered separately from worksurface.

⚠ If using a 54"W or 60"W floating modesty panel, it is not necessary to specify an external support channel.

⚠ When using an external support channel under the worksurface, the depth clearance for center drawers and keyboard platforms decreases by 8".

⚠ See "External Channel (Recommended Use)" chart on page 93.

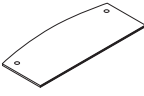

Description	Model	Ship Weight	Cube	L1	L2
				List Price	Upcharge
 Open Market Bow Worksurface 84"W x 36"D 72"W x 36"D	HNLBW3684	94	7.7	\$ 619	\$ 30
	HNLBW3672	80	6.7	\$ 559	\$ 30

NOTES: 84"W size is ideal for executive layouts or for user's who require additional worksurface space. 72"W top can be combined with different pedestal support options to allow users to personalize their storage needs. Underside of worksurface includes pilot mounting holes for 1 1/8" and L-shaped laminate end panels, and 29 1/8"D pedestals. Grain direction runs horizontal (side-to-side). See chart on page 58 for cord management options.

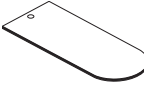
 Open Market Bullet Worksurface 84"W x 30"D 78"W x 30"D 72"W x 30"D 66"W x 30"D 60"W x 30"D 48"W x 30"D	HNLBU3084	84	6.3	\$ 545	\$ 25
	HNLBU3078	78	6.3	\$ 519	\$ 20
	HNLBU3072	72	5.5	\$ 450	\$ 20
	HNLBU3066	66	5.5	\$ 430	\$ 20
	HNLBU3060	60	4.7	\$ 399	\$ 20
	HNLBU3048	54	3.7	\$ 349	\$ 15

NOTES: Applications include U- or L-shaped peninsula configurations and island extensions. Underside of worksurface includes pilot mounting holes for 0-leg, T-shaped end panel, 29 1/8"D pedestals, 4 1/2" diameter support column, and 2" square post leg. One flat bracket is packaged with each worksurface for applications requiring connection to an adjoining worksurface. Grain direction runs horizontal (side-to-side). Can be used in combination with a 15 3/4"W or 9 1/2"W x 29 1/8"D x 28 1/4"H modular pedestal to create a freestanding desk. See chart on page 58 for cord management options.

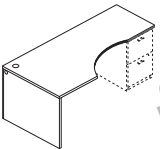
Description	Model	Ship Weight	Cube	L1 List	L2 Upcharges	
					Worksurface	End Panel
 Open Market Extended Corner Worksurface 72"W x 48"D, Right 72"W x 48"D, Left	HNLEC487224R	130	8.9	\$ 942	\$ 50	\$ 50
	HNLEC487224L	130	8.9	\$ 942	\$ 50	\$ 50
72"W x 36"D, Right 72"W x 36"D, Left	HNLEC367224R	106	6.6	\$ 779	\$ 45	\$ 45
	HNLEC367224L	106	6.6	\$ 779	\$ 45	\$ 45

NOTES: For use in U- or L-shaped layouts. Includes top and long (47"D or 35"D) end panel components. Installation also requires modesty panel and either a 1 1/8" thick end panel or 15 3/4" x 23 1/8"D pedestal support for opposite end; both ordered separately. 72"W x 24/48"D or 48/24"D top is intended for use with 30/48"D or 48/30"D jetty peninsula to create a 2-piece "U" station with a curved cockpit on user's side. 72"W x 24/36"D or 36/24"D size is intended for use with 24"D returns or bridges. Underside of worksurface has pilot mounting holes for 1 1/8" thick end panel and 15 3/4" x 23 1/8"D modular pedestal. Grain direction runs horizontal (side-to-side).

⚠ One flat bracket is packaged with each 48"D worksurface for applications requiring connection to a 48"D jetty peninsula. For 36"D extended corner worksurface, the flat bracket is shipped with the adjoining return or bridge. See chart on page 58 for cord management options. If grommet option is chosen, the worksurface component will match the color specified; the long end panel grommet color will be black.

How to specify	1st Option	2nd Option	3rd Option
Select Model Number from above	Select Edge Profile and Edge Color See page 51	Select Worksurface Grommet Finish P Black T1 Platinum X No Grommet	Select Worksurface Color See page 51
H N L B W 3 6 8 4 .	B H .	P .	H

How to specify	1st Option	2nd Option	3rd Option	4th Option
Select Model Number from above	Select Edge Profile and Edge Color See page 51	Select Worksurface Grommet Finish P Black T1 Platinum X No Grommet	Select Worksurface Color See page 51	Select End Panel Color See page 51
H N L E C 4 8 7 2 2 4 R .	B H .	X .	H .	H

Icon Legend on page 10

▶ Use the worksurface to tower bracket kit to attach worksurfaces to Storage Tower models.

⚠ **Depending on your support combination, an external channel may be required for extra support on unsupported spans greater than 54"W.**

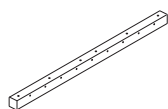

SIN 711-2

Description

External Support Channel
 48"W for a 54" Worksurface
 54"W for a 60" Worksurface
 60"W for a 66" Worksurface
 66"W for a 72" Worksurface
 72"W for a 78" Worksurface

Model

HLSLZ5SC60
 HLSLZ5SC66
 HLSLZ5SC72
 HLSLZ5SC78
 HLSLZ5SC84

Ship Weight

6
 7
 7
 7
 12

Cube

0.5
 0.5
 0.5
 0.5
 0.7

List

\$ 87
 \$ 90
 \$ 97
 \$ 92
 \$ 97

⚠ **Available in Graphite paint only.**
 ⚠ **Attaches to underside of worksurface; required for unsupported spans greater than 54"W.**
 ⚠ **When specifying a 54"W or 60"W Floating Modesty Panel, it is not necessary to specify an external channel.**



HVPWLBK24 shown

Open Market

Worksurface Wall Mount Bracket
 For 30"
 For 24"

HVPWLBK30
 HVPWLBK24

2
 2

0.3
 0.3

\$ 77
 \$ 77

NOTES: Can be used in place of an end panel to support a worksurface. Cannot be used as a support when placing a stack-on storage unit on worksurface over bracket; must have two full-sized floor supports when using stack-on storage. Finish option not required.

SPECIFYING EXAMPLE: HVPWLBK30



SIN 711-3

Description

Worksurface to Tower Bracket Kit
 18½" long bracket for attaching 24"D worksurface directly to storage tower, wardrobe/bookcase, wardrobe/storage cabinet, storage cabinet/lateral file, storage cabinet, or lateral file.

Model

HSTB2W1

Ship Weight

4

Cube

0.6

List by Paint Grade

Core Choice/Metallics Custom

\$ 68 \$ 81 \$ 92

NOTES: Can be used in place of end panel or O-leg to support worksurfaces.

⚠ **Bracket not designed for use as a support if placing Stack-on Storage on worksurface over/above bracket. Two full-sized supports required when using Stack-on Storage.**

How to specify

Select Model Number from above

H | L | S | L | Z | 5 | S | C | 8 | 4

⚠ Icon Legend on page 10

△ The chart reference is to be used to complete the model number. It is not the actual length dimension of the external support channel.

HNL Support Options — External Channel (model HSLZ5SCxx) - Recommended Use														
	Support Combination		Worksurface Width											
	Support 1	Support 2	30"	36"	42"	48"	54"	60"	66"	72"	78"	84"	90"	96"
O-LEG ON ONE END	O-Leg	O-Leg	NR	NR	NR	NR	60	66	72	78	84	NA	NA	NA
	O-Leg	9½"W Ped	NR	NR	NR	NR	NR	60	66	72	78	84	NA	NA
	O-Leg	End Bookcase	NA	NR	NR	NR	NR	NR	60	66	72	78	84	NA
	O-Leg	L End Panel	NR	NR	NR	NR	NR	60	66	72	78	84	NA	NA
	O-Leg	15¾"W Ped	NA	NR	NR	NR	NR	NR	NR	60	66	72	78	NA
	O-Leg	18"W Ped	NA	NA	NR	NR	NR	NR	NR	60	66	72	78	84
	O-Leg	30"W Ped	NA	NA	NA	NA	NR	NR	NR	NR	NR	60	66	72
	O-Leg	36"W Ped	NA	NA	NA	NA	NA	NR	NR	NR	NR	NR	60	66
NARROW PED	9½"W Ped	9½"W Ped	NA	NA	NR	NR	NR	NR	NR	60	66	72	78	84
	9½"W Ped	End Bookcase	NA	NA	NR	NR	NR	NR	NR	60	66	72	78	84
	9½"W Ped	L End Panel	NA	NR	NR	NR	NR	NR	60	66	72	78	84	NA
	9½"W Ped	15¾"W Ped	NA	NA	NA	NR	NR	NR	NR	NR	60	66	72	78
	9½"W Ped	18"W Ped	NA	NA	NA	NR	NR	NR	NR	NR	60	66	72	78
	9½"W Ped	30"W Ped	NA	NA	NA	NA	NA	NR	NR	NR	NR	NR	60	66
	9½"W Ped	36"W Ped	NA	NA	NA	NA	NA	NA	NR	NR	NR	NR	NR	60
END BOOKCASE PED	End Bookcase	End Bookcase	NA	NA	NR	NR	NR	NR	NR	NR	60	66	72	78
	End Bookcase	L End Panel	NA	NA	NR	NR	NR	NR	NR	60	66	72	78	84
	End Bookcase	15¾"W Ped	NA	NA	NA	NR	NR	NR	NR	NR	60	66	72	78
	End Bookcase	18"W Ped	NA	NA	NA	NR	NR	NR	NR	NR	60	66	72	78
	End Bookcase	30"W Ped	NA	NA	NA	NA	NA	NR	NR	NR	NR	NR	60	66
	End Bookcase	36"W Ped	NA	NA	NA	NA	NA	NA	NR	NR	NR	NR	NR	60
L END PANEL	L End Panel	L End Panel	NA	NR	NR	NR	NR	NR	60	66	72	78	84	NA
	L End Panel	15¾"W Ped	NA	NA	NR	NR	NR	NR	NR	NR	60	66	72	78
	L End Panel	18"W Ped	NA	NA	NA	NR	NR	NR	NR	NR	60	66	72	78
	L End Panel	30"W Ped	NA	NA	NA	NA	NA	NR	NR	NR	NR	NR	60	66
	L End Panel	36"W Ped	NA	NA	NA	NA	NA	NA	NR	NR	NR	NR	NR	60
TWO PEDS	15¾"W Ped	15¾"W Ped	NA	NA	NA	NA	NR	NR	NR	NR	NR	60	66	72
	15¾"W Ped	18"W Ped	NA	NA	NA	NA	NR	NR	NR	NR	NR	60	66	72
	15¾"W Ped	30"W Ped	NA	NA	NA	NA	NA	NA	NR	NR	NR	NR	NR	60
	15¾"W Ped	36"W Ped	NA	NA	NA	NA	NA	NA	NA	NR	NR	NR	NR	NR
	18"W Ped	18"W Ped	NA	NR	NA	NA	NR	NR	NR	NR	NR	NR	60	66
	18"W Ped	30"W Ped	NA	NA	NA	NR	NA	NA	NR	NR	NR	NR	NR	NR
	18"W Ped	36"W Ped	NA	NA	NA	NA	NA	NA	NA	NR	NR	NR	NR	NR
	30"W Ped	30"W Ped	NA	NA	NA	NA	NA	NR	NA	NA	NR	NR	NR	NR
	30"W Ped	36"W Ped	NA	NA	NA	NA	NA	NA	NR	NA	NA	NR	NR	NR
	36"W Ped	36"W Ped	NA	NA	NA	NA	NA	NA	NA	NR	NA	NA	NR	NR
RETURN CONFIGURATION	None	O-Leg	NR	NR	NR	NR	60	66	72	78	84	NA	NA	NA
	None	9½"W Ped	NR	NR	NR	NR	NR	60	66	72	78	84	NA	NA
	None	End Bookcase	NA	NR	NR	NR	NR	NR	60	66	72	78	84	NA
	None	L End Panel	NR	NR	NR	NR	NR	60	66	72	78	84	NA	NA
	None	15¾"W Ped	NA	NR	NR	NR	NR	NR	NR	60	66	72	78	NA
	None	18"W Ped	NA	NA	NR	NR	NR	NR	NR	60	66	72	78	84
	None	30"W Ped	NA	NA	NA	NA	NR	NR	NR	NR	NR	60	66	72
	None	36"W Ped	NA	NA	NA	NA	NA	NR	NR	NR	NR	NR	60	66

NA = Stiffener not applicable due to invalid worksurface width and support combination
 NR = Applicable worksurface width and support combination, but stiffener not required

- ▶ Provide approach-side kneespace privacy for user seated at desks, credenzas, returns, and bridges.
- ▶ Full-width laminate panel can be specified in 6" increments from 30"-96"W, and in full-length (27⁷/₈"H) or short (10"H).
- ▶ Formal, full-length, 27⁷/₈"H models extend from the underside of the worksurface to the floor.
- ▶ 10"H sizes allow quick and easy access to wall power outlets.
- ▶ 30"W and 36"W x 27⁷/₈"H are sized to serve as a modesty panel, or pedestal back for respective 30"W and 36"W support storage pedestal models.
- △ **The full-width panel designs are specifically for use when the worksurface supports are two 1¹/₈" thick end panels, two support storage pedestals, or one 1¹/₈" thick end panel and one support storage pedestal; not for use with O-legs or L-shaped end panels.**



Description	Model	Ship		L1	L2
		Weight	Cube	List Price	Upcharge
Modesty/Back Panels — Full Length					
96"W x 27 ⁷ / ₈ "H	HNLMP9628	62	7.2	\$ 389	\$ 25
90"W x 27 ⁷ / ₈ "H	HNLMP9028	58	6.7	\$ 379	\$ 25
84"W x 27 ⁷ / ₈ "H	HNLMP8428	54	6.1	\$ 314	\$ 25
78"W x 27 ⁷ / ₈ "H	HNLMP7828	50	5.5	\$ 279	\$ 20
72"W x 27 ⁷ / ₈ "H	HNLMP7228	46	5.3	\$ 257	\$ 20
66"W x 27 ⁷ / ₈ "H	HNLMP6628	42	4.8	\$ 242	\$ 20
60"W x 27 ⁷ / ₈ "H	HNLMP6028	38	4.4	\$ 219	\$ 20
54"W x 27 ⁷ / ₈ "H	HNLMP5428	34	4.0	\$ 211	\$ 20
48"W x 27 ⁷ / ₈ "H	HNLMP4828	30	3.6	\$ 199	\$ 15
42"W x 27 ⁷ / ₈ "H	HNLMP4228	26	3.2	\$ 184	\$ 15
36"W x 27 ⁷ / ₈ "H Modesty/Pedestal Back Panel	HNLMP3628	22	2.8	\$ 169	\$ 12
30"W x 27 ⁷ / ₈ "H Modesty/Pedestal Back Panel	HNLMP3028	18	2.4	\$ 157	\$ 12
Modesty/Back Panels — Short					
96"W x 10"H	HNLMP9610	22	3.0	\$ 389	\$ 15
90"W x 10"H	HNLMP9010	21	2.8	\$ 379	\$ 15
84"W x 10"H	HNLMP8410	20	2.8	\$ 314	\$ 15
78"W x 10"H	HNLMP7810	19	2.3	\$ 279	\$ 12
72"W x 10"H	HNLMP7210	18	2.1	\$ 257	\$ 12
66"W x 10"H	HNLMP6610	17	1.9	\$ 242	\$ 12
60"W x 10"H	HNLMP6010	16	1.8	\$ 219	\$ 12
54"W x 10"H	HNLMP5410	15	1.6	\$ 211	\$ 12
48"W x 10"H	HNLMP4810	14	1.4	\$ 199	\$ 10
42"W x 10"H	HNLMP4210	13	1.3	\$ 184	\$ 10
36"W x 10"H	HNLMP3610	12	1.1	\$ 169	\$ 10
30"W x 10"H	HNLMP3010	11	0.9	\$ 157	\$ 10

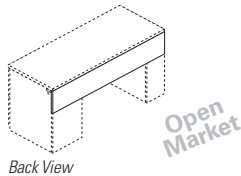
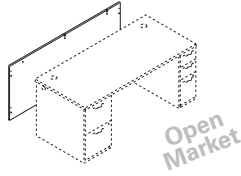

NOTES: For use with modular worksurface and support components. Component is 3/4" thick. Full-to-floor sizes can be specified with or without grommet; see chart on page 58 for cord management options. For standing-height applications, a worksurface supported by 1¹/₈" thick x 41"H laminate end panel(s) and/or 41"H support pedestal(s), the recommended modesty panel length extends 27⁷/₈" below the underside of the top, leaving 13" of wall access; 9¹/₂" and 15³/₄"H x 13"H backs are available to enclose the balance of the pedestal back. Worksurfaces supported by 1¹/₈" thick x 41"H laminate end panel(s) and/or 41"H support pedestal(s) can be used with a 10" modesty panel to increase the amount of wall access, however in this application the pedestal should be positioned against a wall, as there is not a 30⁷/₈"H panel to cover the back of the pedestal that is exposed below the modesty panel. For standing-height applications with the worksurface supported by 41"H O-legs or L-shaped end panels, use the appropriate floating modesty panel size.

How to specify	Select Model Number from above H N L M P 7 2 2 8 .	1st Option Select Grommet P Black X No Grommet X .	2nd Option Select Laminate Color See page 51 H
----------------	---	---	--

How to specify	Select Model Number from above H N L M P 7 2 1 0 .	1st Option Select Laminate Color See page 51 H
----------------	---	--

△ Icon Legend on page 10

Concinnity™ Components — Modesty/Back Panels

GSA SIN 711-2



- ▶ Floating panel options attach under worksurfaces and are available in laminate or mixed (frosted translucent) material. The modesty panel and attachment bracket are packaged separately.
- ▶ If using a 54"W or 60"W floating modesty panel, it is not necessary to specify an external support channel.
- ▶ When using a floating modesty panel under the worksurface, the depth clearance for center drawers and keyboard platforms decreases by 8".
- ▶ The full width/half-height and full-to-floor/full-height panels are filler options designed only for use on 60", 66", and 72"W x 29 1/2"H, double, 15 3/4"W, pedestal desks and credenzas that are specified/built with modular components.

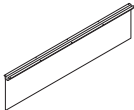
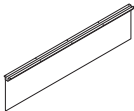
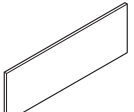
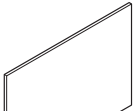

Description	Model	Ship Weight	Cube	L1 List Price	L2 Upcharge
 <p>Laminate Floating Modesty Panel</p> <p>30"W x 14"H</p> <p>36"W x 14"H</p> <p>42"W x 14"H</p> <p>48"W x 14"H</p> <p>54"W x 14"H</p> <p>60"W x 14"H</p> <p>NOTES: The attachment bracket and modesty panel are packaged separately. Specify: Model.Laminate.Paint</p> <p>SPECIFYING EXAMPLE: HLSL3014L.N.P (Black is the only paint option for this model)</p> <p>▲ When specifying the 54"W or 60"W Laminate Floating Modesty Panel, it is not necessary to specify an external support channel.</p> <p>▲ 30"W and 36"W screens attach with L-brackets, not the external channel.</p>	HLSL3014L	10	0.8	\$ 148	\$ 10
	HLSL3614L	12	0.8	\$ 156	\$ 10
	HLSL4214L	14	0.8	\$ 169	\$ 10
	HLSL4814L	16	1.1	\$ 186	\$ 12
	HLSL5414L	18	1.1	\$ 204	\$ 12
	HLSL6014L	20	1.1	\$ 220	\$ 12
 <p>Mixed Material Floating Modesty Panel</p> <p>30"W x 14"H</p> <p>36"W x 14"H</p> <p>42"W x 14"H</p> <p>48"W x 14"H</p> <p>54"W x 14"H</p> <p>60"W x 14"H</p> <p>NOTES: The attachment bracket and modesty panel are packaged separately. Specify: Model.Mixed Material.Paint</p> <p>SPECIFYING EXAMPLE: HLSL3014MM.FT01.P (Frosted Translucent mixed material and Black paint are the only options for this model)</p> <p>▲ When specifying the 54"W or 60"W Mixed Material Floating Modesty Panel, it is not necessary to specify an external support channel.</p>	HLSL3014MM	8	2.0	\$ 597	N/A
	HLSL3614MM	8	2.0	\$ 641	N/A
	HLSL4214MM	9	2.3	\$ 716	N/A
	HLSL4814MM	11	2.6	\$ 794	N/A
	HLSL5414MM	13	3.3	\$ 862	N/A
	HLSL6014MM	13	3.3	\$ 984	N/A
 <p>Full Width/Half-Height Laminate Modesty Panel</p> <p>28"W x 14"H, for use with 60" desks</p> <p>34"W x 14"H, for use with 66" desks</p> <p>40"W x 14"H, for use with 72" desks</p> <p>NOTES: Filler piece that can only be used between the following supports: two 15 3/4"W modular pedestals, two 15 3/4"W L-shaped end panels, or one 15 3/4"W modular pedestal and one 15 3/4"W L-shaped end panel. Attachment brackets included.</p>	HLSL2814LM	19	1.6	\$ 162	\$ 10
	HLSL3414LM	23	1.9	\$ 167	\$ 10
	HLSL4014LM	29	2.4	\$ 175	\$ 10
 <p>Full-to-Floor/Full Length Laminate Modesty Panel</p> <p>28"W x 28 1/2"H, for use with 60" desks</p> <p>34"W x 28 1/2"H, for use with 66" desks</p> <p>40"W x 28 1/2"H, for use with 72" desks</p> <p>NOTES: Filler piece that can only be used between the following supports: two 15 3/4"W modular pedestals, two 15 3/4"W L-shaped end panels, or one 15 3/4"W modular pedestal and one 15 3/4"W L-shaped end panel. Attachment brackets included.</p>	HLSL2828LM	33	2.7	\$ 218	\$ 12
	HLSL3428LM	38	3.2	\$ 254	\$ 12
	HLSL4028LM	44	3.6	\$ 270	\$ 12

How to specify	<p>Select Model Number from above</p> <p>H L S L 3 0 1 4 M M .</p>	<p>1st Option</p> <p>Select Mixed Material</p> <p>FT01 Frosted Translucent</p> <p>F T 0 1 </p>
----------------	---	---

How to specify	<p>Select Model Number from above</p> <p>H L S L 2 8 1 4 L M .</p>	<p>1st Option</p> <p>Select Laminate</p> <p>See page 175</p> <p>N </p>
----------------	---	--

Icon Legend on page 10

HNL Floating Modesty Panel — HSLx14L/MM — Selection Guide														
	Support Combination		Worksurface Width											
	Support 1	Support 2	30"	36"	42"	48"	54"	60"	66"	72"	78"	84"	90"	96"
O-LEG ON ONE END	O-Leg	O-Leg	NA	NA	36	42	48	54	60	60	60	NA	NA	NA
	O-Leg	9½"W Ped	NA	NA	NA	30	36	42	48	54	60	60	NA	NA
	O-Leg	End Bookcase	NA	NA	NA	30	36	42	48	54	60	60	60	NA
	O-Leg	L End Panel	NA	NA	NA	36	42	48	54	60	60	60	NA	NA
	O-Leg	15¾"W Ped	NA	NA	NA	NA	30	36	42	48	54	60	60	NA
	O-Leg	18"W Ped	NA	NA	NA	NA	30	36	42	48	54	60	60	60
	O-Leg	30"W Ped	NA	NA	NA	NA	NA	NA	30	36	42	48	54	60
	O-Leg	36"W Ped	NA	NA	NA	NA	NA	NA	NA	30	36	42	48	54
NARROW PED	9½"W Ped	9½"W Ped	NA	NA	NA	NA	30	36	42	48	54	60	60	60
	9½"W Ped	End Bookcase	NA	NA	NA	NA	30	36	42	48	54	60	60	60
	9½"W Ped	L End Panel	NA	NA	NA	NA	30	36	42	48	54	60	60	NA
	9½"W Ped	15¾"W Ped	NA	NA	NA	NA	NA	30	36	42	48	54	60	60
	9½"W Ped	18"W Ped	NA	NA	NA	NA	NA	30	36	42	48	54	60	60
	9½"W Ped	30"W Ped	NA	NA	NA	NA	NA	NA	NA	NA	30	36	48	48
	9½"W Ped	36"W Ped	NA	NA	NA	NA	NA	NA	NA	NA	30	36	42	48
END BOOKCASE PED	End Bookcase	End Bookcase	NA	NA	NA	NA	NA	30	36	42	48	54	60	60
	End Bookcase	L End Panel	NA	NA	NA	NA	30	36	36	48	54	60	60	60
	End Bookcase	15¾"W Ped	NA	NA	NA	NA	NA	30	36	42	48	54	60	60
	End Bookcase	18"W Ped	NA	NA	NA	NA	NA	NA	30	36	42	48	54	60
	End Bookcase	30"W Ped	NA	NA	NA	NA	NA	NA	NA	NA	30	36	42	48
	End Bookcase	36"W Ped	NA	NA	NA	NA	NA	NA	NA	NA	NA	30	36	42
L END PANEL	L End Panel	L End Panel	NA	NA	NA	NA	36	36	48	54	60	60	60	NA
	L End Panel	15¾"W Ped	NA	NA	NA	NA	NA	30	36	42	48	54	60	60
	L End Panel	18"W Ped	NA	NA	NA	NA	NA	30	36	42	48	54	60	60
	L End Panel	30"W Ped	NA	NA	NA	NA	NA	NA	NA	30	36	42	48	54
	L End Panel	36"W Ped	NA	NA	NA	NA	NA	NA	NA	NA	30	36	42	48
TWO PEDS	15¾"W Ped	15¾"W Ped	NA	NA	NA	NA	NA	NA	30	36	42	48	54	60
	15¾"W Ped	18"W Ped	NA	NA	NA	NA	NA	NA	30	36	36	48	54	60
	15¾"W Ped	30"W Ped	NA	NA	NA	NA	NA	NA	NA	NA	30	36	42	48
	15¾"W Ped	36"W Ped	NA	NA	NA	NA	NA	NA	NA	NA	NA	30	36	42
	18"W Ped	18"W Ped	NA	NA	NA	NA	NA	NA	NA	30	36	42	48	54
	18"W Ped	30"W Ped	NA	NA	NA	NA	NA	NA	NA	NA	NA	30	36	42
	18"W Ped	36"W Ped	NA	NA	NA	NA	NA	NA	NA	NA	NA	NA	30	36
	30"W Ped	30"W Ped	NA	NA	NA	NA	NA	NA	NA	NA	NA	NA	NA	30
	30"W Ped	36"W Ped	NA	NA	NA	NA	NA	NA	NA	NA	NA	NA	NA	NA
	36"W Ped	36"W Ped	NA	NA	NA	NA	NA	NA	NA	NA	NA	NA	NA	NA
HT ADJ BASE	Height-Adjustable Electric Base (model HHAB3S24F)		NA	NA	NA	42	48	54	60	60	NA	NA	NA	NA
PENINSULA	Support Column	T End Panel	NA	NA	NA	30	30	36	42	48	54	60	60	60
	Support Column	9½"W Ped	NA	NA	NA	NA	NA	30	36	42	48	54	60	60
	Support Column	15¾"W Ped	NA	NA	NA	NA	NA	NA	30	36	42	48	54	60
	Support Column	18"W Ped	NA	NA	NA	NA	NA	NA	30	36	42	48	54	60
	Support Column	30"W Ped	NA	NA	NA	NA	NA	NA	NA	NA	30	36	42	48
	Support Column	36"W Ped	NA	NA	NA	NA	NA	NA	NA	NA	NA	30	36	42
RETURN CONFIGURATION	None	O-Leg	NA	NA	36	42	48	54	60	60	60	NA	NA	NA
	None	9½"W Ped	NA	NA	NA	30	36	42	48	54	60	60	NA	NA
	None	End Bookcase	NA	NA	NA	30	36	42	48	54	60	60	60	NA
	None	L End Panel	NA	NA	36	36	42	48	54	60	60	60	NA	NA
	None	15¾"W Ped	NA	NA	NA	NA	30	36	42	48	54	60	60	NA
	None	18"W Ped	NA	NA	NA	NA	30	36	42	48	54	60	60	60
	None	30"W Ped	NA	NA	NA	NA	NA	NA	30	36	42	48	54	60
	None	36"W Ped	NA	NA	NA	NA	NA	NA	NA	30	36	42	48	60

NA = Floating Modesty Panel not applicable for use with worksurface width and support combination

Concinnity™ Components — Supports

Not on GSA Contract



△ 1 1/8" Laminate End Panels must be used with a full length (27 1/8" H) or short (10" H) modesty/back panel; ordered separately, see page 95.

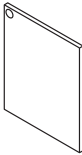
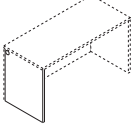
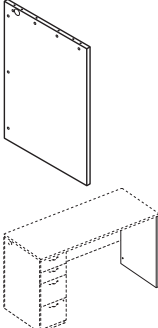

	Description	Model	Ship Weight	Cube	L1 List Price	L2 Upcharge
 HNLEP2428R shown	1 1/8" Laminate End Panels — For 29 1/2" H 1 1/8" W x 35" D x 28 1/2" H for 36" D, Right 1 1/8" W x 35" D x 28 1/2" H for 36" D, Left	HNLEP3628R	39	2.8	\$ 235	\$ 20
		HNLEP3628L	39	2.8	\$ 235	\$ 20
	1 1/8" W x 29 1/8" D x 28 1/2" H for 30" D, Right 1 1/8" W x 29 1/8" D x 28 1/2" H for 30" D, Left	HNLEP3028R	32	2.3	\$ 205	\$ 15
		HNLEP3028L	32	2.3	\$ 205	\$ 15
 HNLEP2428L shown	1 1/8" W x 23 1/8" D x 28 1/2" H for 24" D, Right 1 1/8" W x 23 1/8" D x 28 1/2" H for 24" D, Left	HNLEP2428R	22	1.9	\$ 184	\$ 10
		HNLEP2428L	22	1.9	\$ 184	\$ 10
 HNLEP2441R shown	1 1/8" Laminate End Panels — For 42" H 1 1/8" W x 29 1/8" D x 41" H for 30" D, Right 1 1/8" W x 29 1/8" D x 41" H for 30" D, Left	HNLEP3041R	47	3.2	\$ 234	\$ 20
		HNLEP3041L	47	3.2	\$ 234	\$ 20
	1 1/8" W x 23 1/8" D x 41" H for 24" D, Right 1 1/8" W x 23 1/8" D x 41" H for 24" D, Left	HNLEP2441R	37	2.6	\$ 219	\$ 15
		HNLEP2441L	37	2.6	\$ 219	\$ 15

NOTES: Supports the end of a component worksurface where there is no modular pedestal. 1 1/8" Laminate End Panels must be used with a full length (27 1/8" H) or short (10" H) modesty/back panel; ordered separately, see page 95. The depth of an end panel is 3/4" less than the depth of the worksurface, to accommodate the modesty/back panel. Handed design (left and right models). Bottom of end panel is edge banded for added strength and to seal out moisture. Applications include — For the non-pedestal end of single pedestal desks or credenzas utilizing modular storage components. For returns that do not have a modular storage pedestal to support the worksurface. For extended corner units that do not utilize a 15 3/4" W x 23 1/8" D modular storage pedestal to support the 24" D worksurface dimension. For building desk or credenza shells comprised of a worksurface top and modesty/back panel components, and left and right end panel. Available in a woodgrain or solid laminate color only. Can be specified with or without grommet; see chart on page 58 for cord management options. If grommet option is chosen, the color is black only.

Concinnity™ Kneespace Clearance End Panels

Not on GSA Contract



	Description	Model	Ship Weight	Cube	L1 List Price	L2 Upcharge
 HNLEP1128 shown	Kneespace Clearance End Panels 1 1/8" W x 11 1/4" D x 28 1/2" H for 24" D, 2 pk 1 1/8" W x 11 1/4" D x 41" H for 24" D, 2 pk	HNLEP1128	25	2.0	\$ 209	\$ 10
		HNLEP1141	25	2.8	\$ 257	\$ 10

NOTES: Creates additional kneespace for the user. Two 1 1/8" W x 11 1/4" D laminate end panels, one left, one right; sized to support two adjoining, contiguous 24" D worksurfaces. Can be specified with worksurfaces at time of installation or ordered as replacement for two side-by-side 1 1/8" W x 23" D end panels. Available in 28 1/2" and 41" H. Can be used to connect up to three credenzas in line (2 kits). Not designed for use with returns. Allows conversion of units currently in the field; European fasteners make installation quick and easy. Cord routing notch in top back of each panel. Includes two 1 1/8" thick panels; European fastening hardware; flat connector bracket; self-tapping wood screws for ganging credenza to adjacent worksurface; and adjustable leveling glides. Can be specified in a woodgrain or solid laminate color only; not in a two-tone combination.

SPECIFYING EXAMPLE: HNLEP1128.H

How to specify	Select Model Number from above H N L E P 2 4 2 8 R .	1st Option Select Grommet P Black X No Grommet X .	2nd Option Select Laminate Color See page 51 H
How to specify	Select Model Number from above H N L E P 1 1 2 8 .	1st Option Select Grommet P Black X No Grommet X	

Icon Legend on page 10

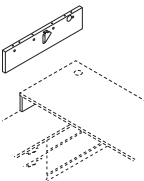

Description	Model	Ship		L1	L2
		Weight	Cube	List Price	Upcharge
 <p>Laminate End Panel — 7”H Support for Worksurfaces 1 1/8”W x 30”D x 7”H, Right 1 1/8”W x 30”D x 7”H, Left 1 1/8”W x 24”D x 7”H, Right 1 1/8”W x 24”D x 7”H, Left</p> <p>HNLEP307L shown</p> <p>NOTES: Specifically for layered surface applications; used to support a 29 1/2”H component worksurface over a 21 1/2”H low credenza unit. 1 1/8” thick. Handed design (left and right models). Includes cord routing notch. Bottom of end panel is edge banded for added strength and to seal out moisture. Attaches to underside of worksurface via cam fasteners and L-bracket; attaches to top of low credenza with double-sided tape. Can be specified in a woodgrain or solid laminate color only. For 7”H metal O-leg support see page 100.</p>	HNLEP307R	7	0.7	\$ 119	\$ 10
	HNLEP307L	7	0.7	\$ 119	\$ 10
	HNLEP247R	6	0.7	\$ 119	\$ 10
	HNLEP247L	6	0.7	\$ 119	\$ 10

SPECIFYING EXAMPLE: HNLEP307R.H

 <p>Laminate L-Shaped End Panels — For 29 1/2”H 15 3/4”W x 30”D x 28 1/2”H, Right 15 3/4”W x 30”D x 28 1/2”H, Left 15 3/4”W x 24”D x 28 1/2”H, Right 15 3/4”W x 24”D x 28 1/2”H, Left</p> <p>HNLEP3028R shown</p> <p>HNLEP3028R and HNLEP3028L shown</p>	HNLLEP3028R E ◆A	38	4.3	\$ 333	\$ 15
	HNLLEP3028L E ◆A	38	4.3	\$ 333	\$ 15
	HNLLEP2428R E ◆A	32	2.8	\$ 299	\$ 15
	HNLLEP2428L E ◆A	32	2.8	\$ 299	\$ 15

Laminate L-Shaped End Panels — For 42”H

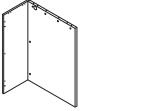
 <p>15 3/4”W x 30”D x 41”H, Right 15 3/4”W x 30”D x 41”H, Left 15 3/4”W x 24”D x 41”H, Right 15 3/4”W x 24”D x 41”H, Left</p> <p>HNLEP3041R shown</p> <p>NOTES: Supports the end of a component worksurface where there is no modular pedestal. Provides easy, open access to wall electrical outlets. For configurations requiring a modesty panel, options include a laminate floating modesty panel or a mixed material floating modesty panel — see page 96. Tops and bottoms of panels are edge banded. Two pieces; 1 1/8” end panel and 3/4” back panel. Ships E◆A; simple assembly. Can be specified in a woodgrain or solid laminate color only; not available in a two-tone combination. See chart on page 58 for cord management options. If grommet option is chosen for the end panel, the color is black only.</p>	HNLLEP3041R E ◆A	55	4.3	\$ 368	\$ 20
	HNLLEP3041L E ◆A	55	4.3	\$ 368	\$ 20
	HNLLEP2441R E ◆A	47	2.8	\$ 329	\$ 20
	HNLLEP2441L E ◆A	47	2.8	\$ 329	\$ 20

SPECIFYING EXAMPLE: HNLLEP2428R.X.H

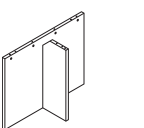
 <p>Laminate T-Shaped End Panels — For 29 1/2”H 11 5/8”W x 35 1/8”D x 28 1/2”H 11 5/8”W x 29 1/8”D x 28 1/2”H 11 5/8”W x 23 1/8”D x 28 1/2”H</p> <p>NOTES: Supports the end of a component worksurface where there is no modular pedestal. Available in 24”, 30”, and 36”D x 28 1/2”H. Two 1 1/8” thick pieces; one end and one brace panel. Cord routing notch in brace panel. Non-handed. Ships E◆A; simple assembly. Can be specified in a woodgrain or solid laminate color only; not available in a two-tone combination.</p>	HNLTEP3628 E ◆A	45	3.7	\$ 339	\$ 20
	HNLTEP3028 E ◆A	39	3.3	\$ 319	\$ 20
	HNLTEP2428 E ◆A	33	2.9	\$ 299	\$ 20

SPECIFYING EXAMPLE: HNLTEP3628.H

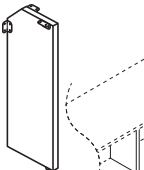
 <p>Support Brace — For 29 1/2”H 1 1/8”W x 10 1/2”D x 28 1/2”H</p> <p>NOTES: Minimizes worksurface deflection by providing added internal support under 24”D tops with an unsupported span of 54” or wider (distance for which there is no panel, leg, or pedestal support component. Not for use as an end panel. 11”D size provides kneespace clearance. Attaches with brackets to both the underside of the worksurface top and either a conventional full-length or 10” laminate modesty panel; not for use with O-leg or L-shaped end panel supports. 1 1/8” thick. Cord routing notch in brace panel. Can be specified in a woodgrain or solid laminate color only.</p>	HNL11SUPP	11	0.9	\$ 134	\$ 10
--	------------------	----	-----	--------	-------

SPECIFYING EXAMPLE: HNL11SUPP.H

How to specify	Select Model Number from above H N L E P 3 0 7 R .	1st Option Select Laminate Color See page 51 H
How to specify	Select Model Number from above H N L L E P 3 0 2 8 R .	1st Option Select Grommet P Black X No Grommet X . 2nd Option Select Laminate Color See page 51 H
How to specify	Select Model Number from above H N L 1 1 S U P P .	1st Option Select Laminate Color See page 51 H

E◆A Icon Legend on page 10

Concinnity™ Components — Supports

GSA SIN 711-2 Except as Noted



- ▶ Open frame, metal design.
- ▶ O-leg ships fully assembled with mounting hardware.
- ▶ O-leg glides have 2" adjustability.

- ▶ Will have 6" overhang when using 30"D O-legs with a 36"D worksurface.
- ▶ Shared O-legs create a cleaner aesthetic in all applications where two legs are used side-by-side.

- ⚠ O-legs may only be attached to worksurfaces, not storage units.
- ⚠ O-leg installation requires 6" of clearance from the worksurface end.

- ⚠ For use with worksurfaces up to 78"W. When using an 84"W or wider worksurface, cannot use two O-legs; must use one 15 3/4" or wider pedestal for the other support.

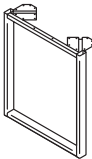
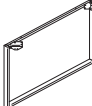
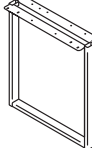
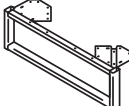
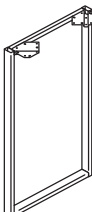
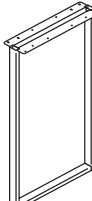

Description	Model	Ship Weight	Cube	List Price by Paint Grade	
				Core	Metallics
 <p>O-Leg 30"D x 28 1/2"H 24"D x 28 1/2"H</p> <p>NOTES: Ship fully assembled, 1/pack. Non-handed. IMPORTANT: The O-leg attachment bracket interferes with placement of 28 3/8"H mobile pedestals, preventing them from being positioned directly next to (flush with) the O-leg. Box/file mobile pedestal (model HNL2116MBF) can be positioned along side the O-leg. SPECIFYING EXAMPLE: HLSL24280.T1</p>	HLSL30280	19	5.4	\$ 310	\$ 314
	HLSL24280	17	3.7	\$ 279	\$ 283
 <p>Double-Depth O-Leg Support for Worksurfaces 48"D x 28 1/2"H 60"D x 28 1/2"H</p> <p>NOTES: Ship fully assembled, 1/pack. Non-handed. 48"D and 60"D sizes span back-to-back 24"D and 30"D worksurfaces, respectively.</p>	HLSL48280	18	7.0	\$ 528	\$ 536
	HLSL60280	19	8.7	\$ 588	\$ 596
 <p>O-Leg Shared Support for Worksurfaces 24"D x 28 1/2"H 30"D x 28 1/2"H</p> <p>NOTES: Ship fully assembled, 1/pack. Non-handed. ⚠ Specify paint only. SPECIFYING EXAMPLE: HLSL2028SL.T1</p>	HLSL2428SL	17	3.7	\$ 347	\$ 351
	HLSL3028SL	19	5.4	\$ 386	\$ 390
 <p>O-Leg Support for Low Credenzas 24"D x 7"H 30"D x 7"H</p> <p>NOTES: Ship fully assembled, 1/pack. Non-handed. For 7"H laminate support see page 99. ⚠ Specify paint only. SPECIFYING EXAMPLE: HLSL2070.T1</p>	HLSL2470	6	1.0	\$ 188	\$ 192
	HLSL3070	7	1.0	\$ 239	\$ 243
 <p>Standing-Height O-Leg Support for Worksurfaces 24"D x 41"H 30"D x 41"H</p> <p>NOTES: Ship fully assembled, 1/pack. Non-handed.</p>	HLSL24410	16	5.3	\$ 375	\$ 381
	HLSL30410	17	6.5	\$ 419	\$ 425
 <p>Standing-Height O-Leg Shared Support for Worksurfaces 24"D x 41"H 30"D x 41"H</p> <p>NOTES: Ship fully assembled, 1/pack. Non-handed. For use with two 24"D or 30"D worksurfaces positioned side-by-side along the depth dimension.</p>	HLSL2441SL	16	5.3	\$ 422	\$ 428
	HLSL3041SL	17	6.5	\$ 468	\$ 474

How to specify	<p>Select Model Number from above</p> <p>H L S L 3 0 2 8 0 .</p>	<p>1st Option</p> <p>Select Paint Color</p> <p>See page 175</p> <p>T 1 </p>
----------------	---	---

ABJ, Level, and other certification logos. Icon Legend on page 10

- ▶ All bases allow tops to sit at 29½" from the floor with glides half-way seated.
- ▶ **Height Adjustable Base**
- ▶ 3-Stage column design.
- ▶ Frame rises from 23⅝" to 49¼" for a sit-to-stand desk option.



- ▶ Ships complete with a preassembled motor.
- ▶ Base telescopes to accommodate any worksurface between 48"W and 72"W.
- ▶ Accommodates rectangular worksurfaces between 24"D x 48"W and 36"D x 72"W.
- ▶ Standard height-adjustable control ships with base.

- ▶ Dynamic load capacity when worksurface is moving is 300 lbs.
- ▶ Optional Memory Control allows preset worksurface heights for consistency. Ships separately.
- ▶ Silver finish matches any neutral HON paint or finish color.
- ▶ Tops and bases are ordered and sold separately.

- ▶ **Post and T-Leg Bases**
- ▶ Both glides and casters attach to the foot easily without tools for assembly.
- ▶ Bases specified with casters include two locking and two non-locking casters.
- ▶ Bases specified with glides have four adjustable glides, which adjust 1".
- ▶ When post legs are used with 18"W tops, post leg to be specified with glides only.

- ▶ **Support column must be specified for worksurfaces used as peninsulas or as an island extension.**
- ▶ **Post leg can only be used to support peninsula, not as primary supports for a top.**

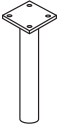



	Description	Model	Ship		
			Weight	Cube	List
	Support Column 4½" Diameter. Specify: HPC190X.P. Black only.	HPC190X	12 	1.0	\$ 144
	Support Column 4½" Diameter. Specify: HPC191X.X. Available in Silver only.	HPC191X	12 	1.0	\$ 144

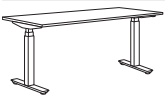

NOTES: For peninsula or island extension worksurface application.

	Description	Model	Ship Weight	Cube	List Price by Paint Grade	
					Core	Metallics
	Post Leg Base 28½"H x 2" square	HLSL28P	15	1.0	\$ 256	\$ 260

NOTES: Can only be used as the outbound support in a peninsula or island extension worksurface application. Glides have 2" of adjustability. Ship 1/pack.
SPECIFYING EXAMPLE: HLSL28P.T1

	Description	Model	Ship		
			Weight	Cube	List
 <i>Base shown with worksurface attached.</i>	Height Adjustable Base – 3 Stage 24"D Feet and Worksurface Brackets	HHAB3S24F E 	80.0	2.8	\$1250

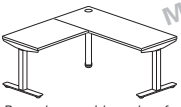
NOTES: Support option for 24", 30", and 36"D rectangle worksurfaces. For 36"D, the base must be centered in the middle of the underside of worksurface. Worksurfaces are ordered separately, see model listing on page 90.
Available in silver finish only, no specification needed. Suggested coordinated paint, Platinum Metallic.

 <i>Base shown with worksurface attached.</i>	3-Leg Height Adjustable Base – 3 Stage 24"D Feet and Worksurface Brackets	HHAB3S3C24F E 	102.0	4.4	\$1700
---	--	--	-------	-----	--------

NOTES: Supports two rectangular worksurfaces to create a height-adjustable L-shaped configuration. Accepts worksurface sizes between 24"D x 48"W and 36"D x 72"W. Accommodates combined components comprising a maximum L-layout footprint of 6' x 6' (72"W x 72"D), examples include 72"W x 30"D with 42"W x 24"D and 72"W x 24"D with 48"W x 24"D.
Available in silver finish only, no specification needed. Suggested coordinated paint, Platinum Metallic.

	Height Adjustable Base – Optional Memory Control	HHABMEM	0.5	0.4	\$ 75
---	--	----------------	-----	-----	-------

Available in black finish only, no specification needed. Memory controller includes digital display and four memory presets.

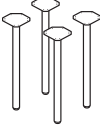
	Post Leg Base (Includes 4 Post Legs) 24"D and 30"D Worksurfaces up to 72"W	HMBPOST	18.0	2.3	\$ 324
---	---	----------------	------	-----	--------

NOTES: For 54" and 60" worksurfaces, use one external channel, centered between user and approach sides. For 66" and 72"W worksurfaces, use two external channels; if no grommets, locate the channels 3" from user and approach sides; if grommets are in the worksurface, locate channels 3" from user and 6" from approach sides.
1¾" diameter Post Leg Base with glide (HMBPOST.G); qty. 4; for 30" to 72"W x 24"D and 48" to 72"W x 30"D tops
1¾" diameter Post Leg Base with casters (HMBPOST.C); qty. 4; for 30" to 72"W x 24"D and 48" to 72"W x 30"D tops

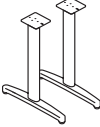
	Fixed Height T-Leg Base (Includes 2 T-legs) For 24"D and 30"D Worksurfaces up to 72"W	HMBTLEG24	14.0	3.6	\$ 385
---	--	------------------	------	-----	--------

NOTES: Use external channel when space between the two legs is 54"W or greater. Center the channel between approach and user sides. See model listing on page 92.
Fixed Height T-Leg Base with glide (HMBTLEG24.G); qty. 2; for 24" and 30"D tops up to 72"W; adjustable glides have 1" range
Fixed Height T-Leg Base with casters (HMBTLEG24.C); qty. 2; for 24" and 30"D tops up to 72"W; two locking and two non-locking casters





How to specify	1st Option	2nd Option
Select Model Number from above H M B T L E G 2 4 .	Select Glide/Caster Option G Glide C Caster 18"D tops are not available in Concinnity™ G .	Select Paint Color See page 633 \$20 upcharge per model, for Metallic paint T 1

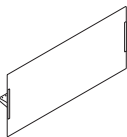

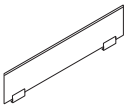

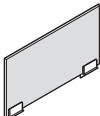
- ▶ Ships complete with attachment brackets.
- ▶ All brackets are Platinum.
- ▶ Above Privacy Screen attaches to top of worksurface.
- ▶ Above and below privacy screen extends 13" above and 13" below the worksurface.
- ⚠ **Above screens must attach to edgeband and top of surface.**

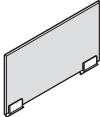

Description	Model	Ship		List
		Weight	Cube	
 <p>Above/Below Privacy Screen 30"W x 28"H 36"W x 28"H 42"W x 28"H 48"W x 28"H 54"W x 28"H 60"W x 28"H</p> <p>NOTES: Attachment bracket extends 2" into top and underside of worksurface. Screen is frosted translucent acrylic. All brackets are platinum (no need to specify). Extends 13" above and 13" below worksurface. ⚠ See page 103 for the "Above-Below Privacy Screen — HLSL28xx — Selection Guide". ⚠ Available in Frosted Translucent Acrylic ONLY HLSL2830.FT01.</p>	HLSL2830	6	6.4	\$ 707
	HLSL2836	6	6.4	\$ 978
	HLSL2842	6	6.3	\$ 991
	HLSL2848	8	8.2	\$1055
	HLSL2854	9	8.6	\$1229
	HLSL2860	9	8.6	\$1237

 <p>Above Privacy Screen 30"W x 13"H 36"W x 13"H 42"W x 13"H 48"W x 13"H 54"W x 13"H 60"W x 13"H</p> <p>NOTES: Attachment requires 1" clear space/overhang on the underside of the worksurface. Screen is frosted glass. All brackets are platinum (no need to specify). ⚠ Available in Frosted Glass ONLY HLSL1230.G.</p>	HLSL1230	13	1.5	\$ 241
	HLSL1236	15	1.8	\$ 266
	HLSL1242	18	2.3	\$ 298
	HLSL1248	20	2.3	\$ 340
	HLSL1254	22	2.9	\$ 364
	HLSL1260	24	2.9	\$ 392

 <p>Above Frosted Polymer (Side) Privacy Screen 24"W x 13"H 30"W x 13"H 36"W x 13"H</p> <p>NOTES: Attach to top and side of worksurface with adhesive banding. Platinum color brackets are intended to be attached between users sitting side-by-side. Brackets create a 1/8" separation between adjacent worksurfaces.</p>	HLSL1224FS	14 	1.4	\$ 284
	HLSL1230FS	16 	1.6	\$ 307
	HLSL1236FS	19 	1.9	\$ 344

 <p>Above Frosted Glass (Side) Privacy Screen 24"W x 13"H 30"W x 13"H 36"W x 13"H</p> <p>NOTES: Attach to top and side of worksurface with adhesive banding. Platinum color brackets are intended to be attached between users sitting side-by-side. Brackets create a 1/8" separation between adjacent worksurfaces.</p>	HLSL1224GS	16 	1.4	\$ 237
	HLSL1230GS	18 	1.6	\$ 256
	HLSL1236GS	20 	1.9	\$ 286

How to specify	Select Model Number from above	1st Option
	HLSL2830 . HLSL1230 .	Select Mixed Material FT01 Frosted Translucent Acrylic Specified for Above/Below Privacy Screens only G Frosted Glass Specified for Above Privacy Screens only FT01 G

How to specify	Select Model Number from above	1st Option
	HLSL1224FS . HLSL1224GS .	Select Mixed Material FT01 Frosted Translucent Acrylic Specified for Above Screen models HLSL1224FS–HLSL1236FS only G Frosted Glass Specified for Above Screen models HLSL1224GS–HLSL1236GS only FT01 G

   Icon Legend on page 10

HNL Above-Below Privacy Screen — HLSL28xx — Selection Guide														
	Support Combination		Worksurface Width											
	Support 1	Support 2	30"	36"	42"	48"	54"	60"	66"	72"	78"	84"	90"	96"
O-LEG ON ONE END	O-Leg	O-Leg	NA	30	36	42	48	54	60	60	60	NA	NA	NA
	O-Leg	9½"W Ped	NA	NA	30	36	42	48	54	60	60	60	NA	NA
	O-Leg	End Bookcase	NA	NA	NA	30	36	42	48	54	60	60	60	NA
	O-Leg	L End Panel	NA	NA	NA	36	42	48	54	60	60	60	NA	NA
	O-Leg	15¾"W Ped	NA	NA	NA	30	36	42	48	54	60	60	60	NA
	O-Leg	18"W Ped	NA	NA	NA	NA	30	36	42	48	54	60	60	60
	O-Leg	30"W Ped	NA	NA	NA	NA	NA	NA	30	36	42	48	54	60
	O-Leg	36"W Ped	NA	NA	NA	NA	NA	NA	NA	30	36	42	48	54
NARROW PED	9½"W Ped	9½"W Ped	NA	NA	NA	NA	30	36	42	48	54	60	60	60
	9½"W Ped	End Bookcase	NA	NA	NA	NA	30	36	42	48	54	60	60	60
	9½"W Ped	L End Panel	NA	NA	NA	30	36	42	48	48	60	60	60	NA
	9½"W Ped	15¾"W Ped	NA	NA	NA	NA	NA	30	36	42	48	54	60	60
	9½"W Ped	18"W Ped	NA	NA	NA	NA	NA	30	36	42	48	54	60	60
	9½"W Ped	30"W Ped	NA	NA	NA	NA	NA	NA	NA	30	36	42	48	54
	9½"W Ped	36"W Ped	NA	NA	NA	NA	NA	NA	NA	NA	30	36	42	48
END BOOKCASE PED	End Bookcase	End Bookcase	NA	NA	NA	NA	30	36	42	48	54	60	60	60
	End Bookcase	L End Panel	NA	NA	NA	NA	30	36	42	48	54	60	60	60
	End Bookcase	15¾"W Ped	NA	NA	NA	NA	NA	30	36	42	48	54	60	60
	End Bookcase	18"W Ped	NA	NA	NA	NA	NA	30	36	42	48	54	60	60
	End Bookcase	30"W Ped	NA	NA	NA	NA	NA	NA	NA	30	36	42	48	54
	End Bookcase	36"W Ped	NA	NA	NA	NA	NA	NA	NA	NA	30	36	42	48
L END PANEL	L End Panel	L End Panel	NA	NA	NA	30	36	42	48	54	60	60	60	NA
	L End Panel	15¾"W Ped	NA	NA	NA	NA	30	36	42	48	54	60	60	60
	L End Panel	18"W Ped	NA	NA	NA	NA	NA	30	36	42	48	54	60	60
	L End Panel	30"W Ped	NA	NA	NA	NA	NA	NA	NA	30	36	42	48	54
	L End Panel	36"W Ped	NA	NA	NA	NA	NA	NA	NA	NA	30	36	42	48
TWO PEDS	15¾"W Ped	15¾"W Ped	NA	NA	NA	NA	NA	NA	30	36	42	48	54	60
	15¾"W Ped	18"W Ped	NA	NA	NA	NA	NA	NA	30	36	42	48	54	60
	15¾"W Ped	30"W Ped	NA	NA	NA	NA	NA	NA	NA	NA	30	36	42	48
	15¾"W Ped	36"W Ped	NA	NA	NA	NA	NA	NA	NA	NA	NA	30	36	42
	18"W Ped	18"W Ped	NA	NA	NA	NA	NA	NA	30	36	42	48	48	60
	18"W Ped	30"W Ped	NA	NA	NA	NA	NA	NA	NA	NA	30	36	42	48
	18"W Ped	36"W Ped	NA	NA	NA	NA	NA	NA	NA	NA	NA	30	36	42
	30"W Ped	30"W Ped	NA	NA	NA	NA	NA	NA	NA	NA	NA	NA	30	36
	30"W Ped	36"W Ped	NA	NA	NA	NA	NA	NA	NA	NA	NA	NA	NA	30
	36"W Ped	36"W Ped	NA	NA	NA	NA	NA	NA	NA	NA	NA	NA	NA	NA
HT ADJ BASE	Height-Adjustable Base (model HHAB3S24F)		NA	NA	NA	42	48	54	60	60	NA	NA	NA	NA
RETURN CONFIGURATION	None	O-Leg	NA	30	36	42	48	54	60	60	60	NA	NA	NA
	None	9½"W Ped	NA	NA	30	36	42	48	54	60	60	60	NA	NA
	None	End Bookcase	NA	NA	NA	30	36	42	48	54	60	60	60	NA
	None	L End Panel	NA	NA	30	36	42	48	54	60	60	60	NA	NA
	None	15¾"W Ped	NA	NA	NA	30	36	36	48	54	60	60	60	NA
	None	18"W Ped	NA	NA	NA	NA	30	36	42	48	54	60	60	60
	None	30"W Ped	NA	NA	NA	NA	NA	NA	30	36	42	48	54	60
	None	36"W Ped	NA	NA	NA	NA	NA	NA	NA	30	36	42	48	54

NA = Above-Below Screen not applicable for use with worksurface width and support combination

SUPPORT STORAGE PEDESTALS — 28½”H

- Non-handed, interchangeable design reconfigures easily.
- For use with component top and modesty/back panels or pedestal top and back panels.
 - Pedestals are not fully enclosed and require a component top/ worksurface and modesty/back panel or a pedestal back, both of which must be ordered separately.
 - Pedestal's front and side panels are finished.
- The pedestal depth dimension is less than the like-size depth of the component top, to accommodate addition of a modesty/back panel.
 - 29½”D pedestals can be used under 30” or 36”D worksurfaces; 23½”D pedestals can be used under 24” or 30”D worksurfaces.
 - When specifying a 29½”D pedestal with ¾” modesty panel under a 36”D worksurface, or a 23½”D pedestal with a ¾” modesty panel under a 30”D worksurface, there will be a 6” approach side overhang.
- Bottom of side panels are edge banded for added strength and to seal out moisture.
- Drawers:
 - Operate on steel ball-bearing suspensions to ensure smooth, quiet, long-lasting operation; full extension allows easy access to contents.
 - Fronts are edge banded on all four sides.
 - Feature 5-sided construction for added strength and easy alignment or replacement of drawer fronts.
- Interchangeable core removable locks are located on front of all modular storage products, except the storage cabinet.
- Finish of lock is determined by, and aligned with, the handle finish specified.
- Locks feature a removable cylinder that can be interchanged as needed; allows users to access all furniture pieces in an office with a single key for convenience and security. Makes re-keying quick and easy. Keyed alike cores must be ordered separately by specification of the key number (removable lock core kit models available in Black [model HF23B] or Satin [model HF23S]).
- Ship fully assembled.
- Chassis and drawer front colors are specified separately; can be selected with common woodgrain or solid laminate color, or with different, complementary chassis and drawer/door colors.
- See chart on page 58 for cord management options. If the pedestal grommet option is chosen, two cutouts, one per end/side panel, each with a black plastic cap, are included.

SUPPORT STORAGE PEDESTALS — 41”H STANDING-HEIGHT

- Same as above except — not to be used freestanding; top and back are not enclosed.
 - Rear of pedestal can be enclosed with a full, 40¾”H back panel or with a 27¾”H modesty panel combined with a lower, 13”H pedestal back component. Pedestal back and modesty panel must be ordered separately.

- ▶ 29½"D pedestals can be used under 30" or 36"D worksurfaces; 23⅜"D pedestals can be used under 24" or 30"D worksurfaces.
 - ▶ Drawers operate on steel ball-bearing suspensions to ensure smooth, quiet, long-lasting operation; full extension allows easy access to contents.
 - ▶ Interchangeable core removable locks allow users to access all furniture pieces in an office with a single key for convenience and security. Makes re-keying quick and easy.
 - ▶ See chart on page 58 for cord management options. If the pedestal grommet option is chosen, two cutouts, one per end/side panel, each with a black plastic cap, are included.
- ⚠ **Pedestal tops and backs are open and require top and back panel components — ordered separately.**

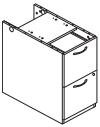
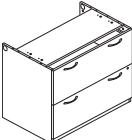

	Description	Model	Ship Weight	Cube	L2 Upcharges		
					L1 List	Chassis	Front
 Open Market	Narrow Box/Box/File Pedestal 9½"W x 29⅞"D x 28½"H	HNL291028PBBF	64	10.6	\$ 699	\$ 25	\$ 10
	9½"W x 23⅜"D x 28½"H	HNL231028PBBF	53	8.6	\$ 625	\$ 20	\$ 10
NOTES: Efficient, space saving design for smaller footprints. Three locking drawers; two box (supply) drawers, one for files. File drawer has high sides to accept hanging folders; hangrails are included for side-to-side letter or legal filing. Pedestal's top and back are open and require top and back panel components — ordered separately. See chart on page 58 for cord management options. Ships fully assembled. SPECIFYING EXAMPLE: HNL291028PBBF.E.X.H.H							
 Open Market	Narrow File/File Pedestal 9½"W x 29⅞"D x 28½"H	HNL291028PFF	69	10.6	\$ 699	\$ 25	\$ 10
	9½"W x 23⅜"D x 28½"H	HNL231028PFF	54	10.6	\$ 625	\$ 20	\$ 10
NOTES: Efficient, space saving design for smaller footprints. Two locking file drawers. Drawers have high sides to accept hanging folders; hangrails are included for side-to-side letter or legal filing. Pedestal's top and back are open and require top and back panel components — ordered separately. See chart on page 58 for cord management options. Ships fully assembled. SPECIFYING EXAMPLE: HNL291028PFF.E.X.H.H							
 Open Market	Box/Box/File Pedestal 15¾"W x 29⅞"D x 28½"H	HNL291628PBBF	76	10.6	\$ 709	\$ 25	\$ 10
	18"W x 23⅜"D x 28½"H	HNL231828PBBF	72	9.8	\$ 712	\$ 20	\$ 10
	15¾"W x 23⅜"D x 28½"H	HNL231628PBBF	69	8.6	\$ 647	\$ 20	\$ 10
NOTES: Three locking drawers; two box (supply) drawers, one for files. File drawer has high sides to accept hanging folders; hangrails are included for side-to-side letter or legal filing; and front-to-back for letter filing. Pedestal's top and back are open and require top and back panel components — ordered separately. See chart on page 58 for cord management options. Ships fully assembled. SPECIFYING EXAMPLE: HNL291628PBBF.E.X.H.H							
 Open Market	File/File Pedestal 15¾"W x 29⅞"D x 28½"H	HNL291628PFF	78	10.6	\$ 709	\$ 25	\$ 10
	18"W x 23⅜"D x 28½"H	HNL231828PFF	72	9.8	\$ 712	\$ 20	\$ 10
	15¾"W x 23⅜"D x 28½"H	HNL231628PFF	70	8.6	\$ 647	\$ 20	\$ 10
NOTES: Two locking file drawers. Drawers have high sides to accept hanging folders; hangrails are included for side-to-side letter or legal filing; and front-to-back for letter filing. Pedestal's top and back are open and require top and back panel components — ordered separately. See chart on page 58 for cord management options. Ships fully assembled. SPECIFYING EXAMPLE: HNL291628PFF.E.X.H.H							
 Open Market	Lateral File Pedestal 36"W x 23⅜"D x 28½"H	HNL233628PLF	134	18.4	\$ 957	\$ 40	\$ 20
	30"W x 23⅜"D x 28½"H	HNL233028PLF	115	15.0	\$ 874	\$ 35	\$ 20
NOTES: Two locking file drawers; drawers include hangrails to accept folders in letter or legal size. For use under 24"D rectangle worksurface. Widths can also span depth dimension of respective 30" or 36"D rectangle worksurface. Anti-tip design includes mechanical interlock to inhibit the extension of more than one drawer at a time. Pedestal's top and back are open and require top and back panel components — ordered separately. See chart on page 58 for cord management options. Ships fully assembled. SPECIFYING EXAMPLE: HNL233628PLF.E.X.H.H							

How to specify	1st Option	2nd Option	3rd Option	4th Option
Select Model Number from above	Select Handle	Select Grommet	Select Chassis Color	Select Drawer Front Color
	A Cylinder – Satin B Cylinder – Black C Canopy – Satin D Canopy – Black E Loop – Satin F Loop – Black	P Black X No Grommet	See page 51	See page 51
H N L 2 9 1 0 2 8 P B B F .	E .	X .	H .	H

Icon Legend on page 10

- ▶ 23 1/8" D pedestals can be used under 24" or 30" D worksurfaces.
- ▶ Drawers operate on steel ball-bearing suspensions to ensure smooth, quiet, long-lasting operation; full extension allows easy access to contents.
- ▶ Interchangeable core removable locks allow users to access all furniture pieces in an office with a single key for convenience and security. Makes re-keying quick and easy.
- ▶ See chart on page 58 for cord management options. If the pedestal grommet option is chosen, two cutouts, one per end/side panel, each with a black plastic cap, are included.

△ Pedestal tops and backs are open and require top and back panel components — ordered separately.

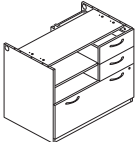
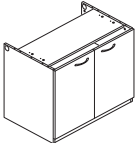
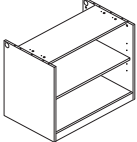
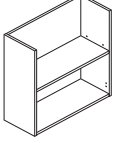

Description	Model	Ship Weight	Cube	L1 List	L2 Upcharges	
					Chassis	Front
 <p>Shelf/Box/Box/Lateral File Pedestal 36"W x 23 1/8"D x 28 1/2"H 30"W x 23 1/8"D x 28 1/2"H</p> <p>NOTES: Versatile unit features an open shelf and three drawers; two for supplies and one for files. For use under 24"D rectangle worksurface. Widths can also span depth dimension of respective 30" or 36"D rectangle worksurface. Box (supply) drawers are located on the right and open shelves on the left. All drawers lock. Pedestal's top and back are open and require top and back panel components — ordered separately. See chart on page 58 for cord management options. Ships fully assembled.</p> <p>SPECIFYING EXAMPLE: HNL233628PSL.E.X.H.H</p>	HNL233628PSL	145	18.4	\$1129	\$ 40	\$ 20
	HNL233028PSL	126	15.0	\$1107	\$ 35	\$ 20
 <p>Storage Cabinet Pedestal 36"W x 23 1/8"D x 28 1/2"H 30"W x 23 1/8"D x 28 1/2"H</p> <p>NOTES: One adjustable shelf, which adjusts in 2 1/2" increments. For use under 24"D rectangle worksurface. Widths can also span depth dimension of respective 30" or 36"D rectangle worksurface. Doors are non-locking. Pedestal's top and back are open and require top and back panel components — ordered separately. See chart on page 58 for cord management options. Ships fully assembled.</p> <p>SPECIFYING EXAMPLE: HNL233628PSC.E.X.H.H</p>	HNL233628PSC	104	18.4	\$ 734	\$ 35	\$ 20
	HNL233028PSC	91	15.0	\$ 709	\$ 30	\$ 20
 <p>Bookcase Pedestal 36"W x 23 1/8"D x 28 1/2"H 30"W x 23 1/8"D x 28 1/2"H</p> <p>NOTES: Two shelves; bottom of unit plus one adjustable shelf, which adjusts in 2 1/2" increments. For use under 24"D rectangle worksurface. Widths can also span depth dimension of respective 30" or 36"D rectangle worksurface. Pedestal's top and back are open and require top and back panel components — ordered separately. See chart on page 58 for cord management options. Ships fully assembled.</p> <p>SPECIFYING EXAMPLE: HNL233628PBK.X.H</p>	HNL233628PBK	82	18.4	\$ 645	\$ 25	N/A
	HNL233028PBK	73	15.0	\$ 630	\$ 20	N/A
 <p>Bookcase End Support 12"W x 36"D x 28 1/2"H 12"W x 30"D x 28 1/2"H 12"W x 24"D x 28 1/2"H</p> <p>NOTES: Two shelves; bottom of unit plus one adjustable shelf, which adjusts in 1 1/4" increments. Designed to span the depth dimension of 24", 30", or 36"D rectangle worksurface; shelves can be oriented facing outwards, or inwards towards the user's kneespace. Includes fully finished back. Ships with two (2) extra L-brackets for applications requiring attachment of a laminate modesty panel; the panel brackets to the back of the bookcase end support. Modesty panel specified should be 12" less than the worksurface width. Open top; for use under worksurface only — ordered separately. Ships fully assembled.</p> <p>SPECIFYING EXAMPLE: HNL123628BKE.H</p>	HNL123628BKE	48	11.0	\$ 484	\$ 25	N/A
	HNL123028BKE	48	10.2	\$ 459	\$ 20	N/A
	HNL122428BKE	41	7.4	\$ 435	\$ 20	N/A

How to specify	1st Option	2nd Option	3rd Option	4th Option
<p>Select Model Number from above</p> <p>H N L 2 3 3 6 2 8 P S L .</p>	<p>Select Handle</p> <p>A Cylinder – Satin B Cylinder – Black C Canopy – Satin D Canopy – Black E Loop – Satin F Loop – Black</p> <p>E .</p>	<p>Select Grommet</p> <p>P Black X No Grommet</p> <p>X .</p>	<p>Select Chassis Color</p> <p>See page 51</p> <p>H .</p>	<p>Select Drawer Front Color</p> <p>See page 51</p> <p>H</p>

Icon Legend on page 10

► Pedestals for standing-height workstations.

► 29½”D pedestals can be used under 30” or 36”D worksurfaces; 23½”D pedestals can be used under 24” or 30”D worksurfaces.

► Drawers operate on steel ball-bearing suspensions to ensure smooth, quiet, long-lasting operation; full extension allows easy access to contents.

► See chart on page 58 for cord management options. If the pedestal grommet option is chosen, two cutouts, one per end/side panel, each with a black plastic cap, are included.

⚠ **Pedestal tops and backs are open and require top and back panel components — ordered separately.**

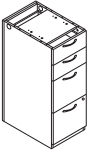
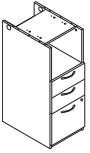
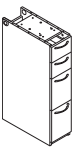

	Description	Model	Ship Weight	Cube	L1 List	L2 Upcharges	
						Chassis	Front
 <i>Open Market</i>	Box/Box/File/File Pedestal 15¾”W x 29½”D x 41”H 15¾”W x 23½”D x 41”H NOTES: Four drawers: two box (supply) and two file. File drawer has high sides to accept hanging folders; hangrails are included for side-to-side letter or legal filing; and front-to-back for letter filing. The two box drawers do not lock. Pedestal's top and back are open and require top and back panel components — ordered separately. See chart on page 58 for cord management options. Ships fully assembled. SPECIFYING EXAMPLE: HNL291641PBBFF.E.X.H.H	HNL291641PBBFF HNL231641PBBFF	114 102	14.7 11.9	\$1454 \$1364	\$ 45 \$ 40	\$ 25 \$ 25
	 <i>Open Market</i>	Shelf/Box/Box/File Pedestal 15¾”W x 29½”D x 41”H 15¾”W x 23½”D x 41”H NOTES: Open shelf over three drawers: two box (supply) and one file. Interior dimensions of the open storage area are: 14½”W x 28¼”D x 12¼”H for the 29½”D pedestal. 14½”W x 22¼”D x 12¼”H for the 23½”D pedestal. File drawer has high sides to accept hanging folders; hangrails are included for side-to-side letter or legal filing; and front-to-back for letter filing. All drawers lock. Pedestal's top and back are open and require top and back panel components — ordered separately. See chart on page 58 for cord management options. Ships fully assembled. SPECIFYING EXAMPLE: HNL291641PSBBF.E.X.H.H	HNL291641PSBBF HNL231641PSBBF	99 89	14.7 11.9	\$1454 \$1364	\$ 45 \$ 40
 <i>Open Market</i>	Narrow Box/Box/File/File Pedestal 9½”W x 29½”D x 41”H 9½”W x 23½”D x 41”H NOTES: Efficient, space saving design for smaller footprints. Four drawers: two box (supply) and two file. File drawers have high sides to accept hanging folders; hangrails are included for side-to-side letter or legal filing. When used in a double pedestal configuration under a 60” and 48”W worksurface, provides 41” and 29” of kneespace width, respectively. The two box drawers do not lock. Pedestal's top and back are open and require top and back panel components — ordered separately. See chart on page 58 for cord management options. Ships fully assembled. SPECIFYING EXAMPLE: HNL291041PBBFF.E.X.H.H	HNL291041PBBFF HNL231041PBBFF	88 79	14.7 11.9	\$1279 \$1199	\$ 45 \$ 40	\$ 20 \$ 20

How to specify	1st Option	2nd Option	3rd Option	4th Option
Select Model Number from above H N L 2 9 1 6 4 1 P B B F F .	Select Handle A Cylinder – Satin B Cylinder – Black C Canopy – Satin D Canopy – Black E Loop – Satin F Loop – Black E .	Select Grommet P Black X No Grommet X .	Select Chassis Color See page 51 H .	Select Drawer Front Color See page 51 H

Icon Legend on page 10

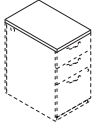

Open Market

Description	Model	Ship Weight	Cube	L1 List	L2 Upcharge
Pedestal Tops					
15¾"W x 30"D	HNLPT3016	16	1.4	\$ 207	\$ 10
18"W x 24"D	HNLPT2418	15	1.3	\$ 195	\$ 10
15¾"W x 24"D	HNLPT2416	13	1.2	\$ 195	\$ 10

NOTES: Component is 1½" thick. Underside of top includes pilot mounting holes for pedestals. Grain direction on 15¾" and 18"W pedestal tops runs horizontal (side-to-side). Component tops for 30" and 36"W pedestals are listed with rectangle worksurface sizes. Grain direction on 30" and 36"W pedestal tops can be specified horizontal (side-to-side) or vertical (front-to-back). For tri-oval and beaded edge options, there is a shaped profile on the user and approach sides, and a flat edge on the ends.

⚠ **For modular pedestals used in freestanding applications; not compatible when pedestal is positioned under a worksurface.**

How to specify	1st Option	2nd Option
<p>Select Model Number from above</p> <p>H N L P T 3 0 1 6 .</p>	<p>Select Edge Profile and Edge Color</p> <p>See page 51</p> <p>B H .</p>	<p>Select Top Color</p> <p>See page 51</p> <p>H </p>

Icon Legend on page 10

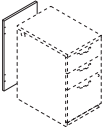
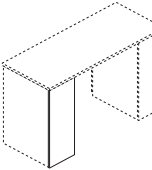
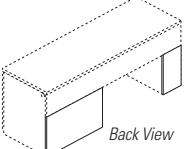
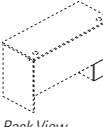

	Description	Model	Ship		L1	L2
			Weight	Cube	List Price	Upcharge
 <p>Open Market</p>	Full Back Panels — For 28½”H Pedestals					
	18”W x 27⅞”H	HNLBP1828	11	1.5	\$ 134	\$ 10
	15¾”W x 27⅞”H	HNLBP1628	10	1.3	\$ 119	\$ 10
	9½”W x 27⅞”H	HNLBP1028	6	0.9	\$ 112	\$ 10
	<p>NOTES: Encloses the rear of 28½”H modular support pedestals, which come standard with an open, unfinished back. For use when a support storage pedestal is positioned under a 29½”H worksurface and a conventional worksurface width x 27⅞”H modesty/back panel is not specified to cover the back of the pedestal. Examples of when to use a 27⅞” pedestal back include: A worksurface supported by an O-leg on one end and support pedestal on the other, with open wall access; or a worksurface with an O-leg and pedestal support flanking a floating modesty panel. Can be specified in a woodgrain or solid laminate color only. For 30” and 36”W pedestals, use the respective modesty/pedestal back panel size, see page 95.</p> <p>SPECIFYING EXAMPLE (9½”, 15¾”, 18”W): HNLBP1028.H</p>					
 <p>Open Market</p>	Full Back Panels — For 41”H Pedestals					
	15¾”W x 40⅜”H	HNLBP1641	15	1.8	\$ 138	\$ 15
	9½”W x 40⅜”H	HNLBP1041	9	1.2	\$ 124	\$ 15
		<p>NOTES: Encloses the rear of 41”H modular support pedestals, which come standard with an open, unfinished back. For use when a support storage pedestal is positioned under a 42”H worksurface and no full-width, 27⅞”H laminate modesty and low, 13”H pedestal back panel are specified. Examples of when to use a 40⅜” pedestal back include: A worksurface supported by an O-leg on one end and support pedestal on the other, with open wall access; or a worksurface with an O-leg and pedestal support flanking a floating modesty panel. Can be specified in a woodgrain or solid laminate color only.</p> <p>SPECIFYING EXAMPLE: HNLBP1641.H</p>				
 <p>Open Market</p>	Low Back Panels — For 28½”H Pedestals					
	36”W x 18”H	HNLB3618	15	1.9	\$ 134	\$ 15
	30”W x 18”H	HNLB3018	12	1.6	\$ 134	\$ 15
	18”W x 18”H	HNLB1818	7	1.0	\$ 119	\$ 15
	15¾”W x 18”H	HNLB1618	6	0.9	\$ 114	\$ 10
	9½”W x 18”H	HNLB1018	4	0.6	\$ 106	\$ 10
	<p>NOTES: Encloses the rear of 28½”H modular support pedestals when positioned under a 29½”H worksurface with a full-width, 10” laminate modesty panel. The modesty panel extends down from the underside of the worksurface to cover the upper back portion of the pedestal, the lower panel component encloses the remainder of the pedestal back. When used in combination, the 10” modesty and pedestal low back panels fully conceal the rear of the pedestal. The pedestal low back panel is only for use when a modular pedestal is used in conjunction with a worksurface with a 10” laminate modesty panel and the customer wants/needs to fully enclose the back section of the pedestal. Can be specified in a woodgrain or solid laminate color only.</p>					
 <p>Open Market</p>	Low Back Panels — For 41”H Pedestals					
	15¾”W x 13”H	HNLB1613	4	0.7	\$ 114	\$ 10
	9½”W x 13”H	HNLB1013	3	0.5	\$ 106	\$ 10
		<p>NOTES: Encloses the rear of 41”H modular support pedestals when positioned under a 42”H worksurface with a full-width, 27⅞” laminate modesty panel. The modesty panel extends down from the underside of the worksurface to cover the upper back portion of the pedestal, the lower panel component encloses the remainder of the pedestal back. When used in combination, the 27⅞” modesty and pedestal low back panels fully conceal the rear of the pedestal. The pedestal low back panel is only for use when a modular pedestal is used in conjunction with a worksurface with a 27⅞” laminate modesty panel and the customer wants/needs to fully enclose the back section of the pedestal. Can be specified in a woodgrain or solid laminate color only.</p>				

How to specify	<p>Select Model Number from above</p> <p>H N L P B 1 8 2 8 . H</p>	<p>1st Option</p> <p>Select Laminate Color</p> <p>See page 51</p>
----------------	---	---

How to specify	<p>Select Model Number from above</p> <p>H N L L B 3 6 1 8 . H</p>	<p>1st Option</p> <p>Select Laminate Color</p> <p>See page 51</p>
----------------	---	---

Icon Legend on page 10

▶ Laminate center drawers include pencil tray. **△ Collaborative desk shelf for use with 72"W x 36"D breakfront, floating modesty panel desk designs or with 60" or wider worksurface, supported by pedestals, and no modesty panel.**



Description	Model	Ship		L1	L2
		Weight	Cube	List Price	Upcharge
 Laminate Center Drawer 26" x 15 ³ / ₈ " 22" x 15 ³ / ₈ " Refer to page 751 for Center Drawer compatibility information SIN 711-1, 711-2, 711-11	H1526	12	1.2	\$ 182	N/A
	H1522	11	1.1	\$ 168	N/A

• 12" drawer extension (3/4).
 • Inside drawer dimension for H1526: 22⁷/₈"W x 15¹/₂"D x 1¹/₂"H.
 • Inside drawer dimension for H1522: 18⁵/₈"W x 15¹/₂"D x 1¹/₂"H.
 • Minimum clearance for mounting H1526: 27¹/₄"W x 18¹/₂"D compatible with 72"W x 36"D, 66"W x 30"D, 60"W x 30"D Double Pedestal Desks, 72"W x 24"D, 66"W x 24"D, 60"W x 24"D Credenza w/Kneespace, 48"W x 24"D Return
 • Minimum clearance for mounting H1522: 22³/₄"W x 18¹/₂"D compatible with 72"W x 36"D, 66"W x 30"D, 60"W x 30"D Double Pedestal Desks, 72"W x 36"D, 66"W x 30"D Single Pedestal Desks, Bullet and P-Shaped Peninsulas, 72"W x 24"D, 66"W x 24"D, 60"W x 24"D Credenza w/Kneespace, 72"W x 24"D, 66"W x 24"D Single Pedestal Credenzas, 48"W x 24"D, 42"W x 24"D Returns

NOTES: Specify laminate for drawer. Model H1522 or H1022 can be used on peninsulas with modesty panel, model HPC180W.

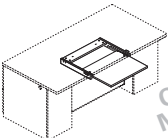
 Collaborative Desk Shelf 25"W x 23"D x 2 ¹ / ₂ "H Open Market	HNLCD SHELF	18	1.5	\$ 309	\$ 20
--	-------------	----	-----	--------	-------

NOTES: Convenient slide-out shelf on approach-side of desk provides work space for guests. For use with 72"W x 36"D breakfront desk designs — see listings on page 62 — or with 60" or wider worksurface, supported by pedestals, and no modesty panel. Minimum clearance for mounting: 28"W x 19³/₄"D. Fully extended shelf dimensions: 24"W x 19"D. Shelf extends 12³/₈". ³/₄" thick. Not compatible on desks with under surface center drawer or keyboard platform attached. Can be specified in a woodgrain or solid laminate color only.

SPECIFYING EXAMPLE: HNLCD SHELFH

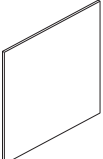
Description	Model	Ship		List
		Weight	Cube	
 Wall Mount Tackboard 36"W x 35 ¹ / ₄ "H 30"W x 35 ¹ / ₄ "H Open Market	HNL3636TB	20	2.9	\$ 269
	HNL3630TB	16	2.9	\$ 229
36"W x 48 ⁵ / ₈ "H 30"W x 48 ⁵ / ₈ "H	HNL4936TB	27	5.5	\$ 299
	HNL4930TB	22	3.7	\$ 259

NOTES: Available in HON Group panel fabric grades A and B. When positioned above 29¹/₂"H floor-standing storage, the sizes align with overhead storage height options. Can be positioned side-by-side with corresponding wall mount markerboard sizes. Easy to install; includes mounting hardware. Attaches to wall with horizontally mounted, interlocking Z-clip brackets.

SPECIFYING EXAMPLE: HNL3636TB.APN15

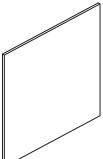
 Wall Mount Markerboard 36"W x 35 ¹ / ₄ "H 30"W x 35 ¹ / ₄ "H Open Market	HNL3636WB	16	2.9	\$ 174
	HNL3630WB	14	2.9	\$ 162
36"W x 48 ⁵ / ₈ "H 30"W x 48 ⁵ / ₈ "H	HNL4936WB	22	5.5	\$ 215
	HNL4930WB	20	3.7	\$ 197

NOTES: Smooth, white, magnetic surface. Metal material produces clear graphics and cleans easily. Compatible for use with dry- or wet-erase markers. When positioned above 29¹/₂"H floorstanding storage, the sizes align with overhead storage height options. Can be positioned side-by-side with corresponding wall mount tackboard sizes. Easy to install; includes mounting hardware. Attaches to wall with horizontally mounted, interlocking Z-clip brackets.



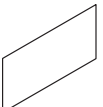

SPECIFYING EXAMPLE: HNL3636WB

 Markerboard 36"W x 15"D 30"W x 15"D SIN 711-2	HLSL1536SOMB	8	1.0	\$ 159
	HLSL1530SOMB	6	1.0	\$ 118

NOTES: Markerboard laminate material with black edges, no frame. Adheres to laminate doors. Includes double-sided tape. No specification necessary.

How to specify	1st Option
Select Model Number from above H N L C D S H E L F . H	Select Laminate See page 51





	Description	Model	Ship Weight	Cube	List
 <p><i>Black only</i></p>	<p>Field Installable Grommet — For 2½" Diameter Hole</p> <ul style="list-style-type: none"> Intended for use in tops and end panels to route/hide cords and in modesty panels to facilitate reaching wall electrical outlets. Grommet is field installable. Requires a 2½" diameter hole saw and drill for installation (not included). Grommet shape is round. Includes grommet cap and sleeve. Grommet cap measures 3" diameter and includes a ¾" diameter cord access hole. Grommet sleeve measures 2½" O.D. x ¾" thick. Includes instructions to locate grommet position for desks, credenzas, returns, and bridges. <p>⚠ Black Finish SPECIFYING EXAMPLE: HFLDGRMT</p>	HFLDGRMT	0.1 	0.01	\$ 28
	<p>Field Installable Grommet — For 3" Diameter Hole</p> <ul style="list-style-type: none"> Intended for use in tops and end panels to route/hide cords and in modesty panels to facilitate reaching wall electrical outlets. Grommet is field installable. Requires a 3" diameter hole saw and drill for installation (not included). Grommet shape is round. Includes grommet cap and sleeve. Grommet outside dimensions measures 3½" diameter and includes two cord access holes. Grommet sleeve measures 3" O.D. x 1" thick. Includes instructions to locate grommet position for desks, credenzas, returns, and bridges. <p>⚠ Black Finish SPECIFYING EXAMPLE: HFLDGRMT3</p>	HFLDGRMT3	0.1 	0.3	\$ 28
 <p><i>Open Market</i></p>	<p>Field Installable Grommet — For 3" Diameter Hole</p> <ul style="list-style-type: none"> Intended for use in tops to route/hide cords. Requires a 3" diameter hole saw and drill for installation (not included). Includes grommet cap, with two access holes, and sleeve components. Outside dimension measures 3½" diameter. Sleeve hole in worksurface measures 3" O.D. x 1" thick. Includes instructions to locate grommet position for desks, credenzas, returns, and bridges. <p>⚠ Platinum Finish SPECIFYING EXAMPLE: HFLDGRMT4</p>	HFLDGRMT4	0.1	0.01	\$ 28

How to specify

Select Model Number from above

H | F | L | D | G | R | M | T

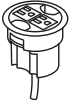
   Icon Legend on page 10

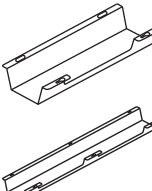
	Description	Model	Ship Weight	Cube	List
 SIN 71-302	Power Hub, 3" Grommet Mount • Fits in 3" round grommet holes on the following product lines: 10500, 10700, Concinnity, Coordinate, Pennsylvania Avenue, and Voi desks; Abound Worksurfaces; Huddle and Motivate tables and SmartLink. • Two grounded AC power outlets. • Two cord pass-through holes in cap. • Includes 6' cord with three-prong plug. • Field installed; easy plug-and-play. • UL Listed. ▲ Available in black only (no color designation so use .X – Specify: HGRMTAC.X).	HGRMTAC	1.3	0.2	\$ 100
	 SIN 71-303	Power/USB Hub, 3" Grommet Mount • One grounded AC power outlet with 2 USB ports. • Two cord pass-through holes in cap. • Includes 6' cord with three-prong plug. • Field installed; easy plug-and-play. • UL Listed. ▲ Available in black only (no color designation so use .X – Specify: HGRMTUSB2.X).	HGRMTUSB2	1.3 <input type="checkbox"/>	0.2
 SIN 711-1	Cable Management Troughs 17"W — Single 17"W — 10-Pack 36"W — Single 36"W — 10-Pack • Cable management troughs ship flat packed. • The troughs attach to underneath the worksurface with screws. • The 17"W has one wire access cut out on the user side. The 36" has two wire access cut outs. These cut outs give users access to inside the trough without having to detach it from the worksurface. • Color: Graphite. • Material: Metal. • TAA Compliant.	HCTROUGH17 HCTROUGH1710 HCTROUGH36 HCTROUGH3610	2.7 <input type="checkbox"/> 14.0 <input type="checkbox"/> 4.9 <input type="checkbox"/> 30.0 <input type="checkbox"/>	0.5 0.5 0.9 0.9	\$ 60 \$ 568 \$ 101 \$ 959
	O-Leg Cord Clips Clips for 28½" Worksurface O-Legs — 8-Pack Clips for Layering O-Legs — 4-Pack NOTES: Wire clips work with 7" Low Credenza O-leg and 29"H Support O-leg. ▲ Available in frosted plastic material only.	HWMCLIPLG HWMCLIPSM	0.8 <input type="checkbox"/> 0.5 <input type="checkbox"/>	0.1 0.1	\$ 86 \$ 55

Open Market

How to specify

Select Model Number from above

H | G | R | M | T | A | C

   Icon Legend on page 10

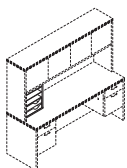

Not available in two-tone laminates
SIN 711-8

Description	Model	Ship Weight	Cube	L1 List Price	L2 Upcharge
Vertical Paper Manager 14 ⁷ / ₈ "W x 10 ⁷ / ₈ "D x 19 ¹ / ₁₆ "H NOTES: Keeps papers, files, and books neatly organized and within easy reach from a seated position. Designed for desk, credenza, and return tops. Fits under stack-on storage models. Two pullout drawers and three fixed shelves. ⚠ When used in conjunction with wall mounted storage cabinets, allow 19³/₄" minimum clearance above the worksurface. SPECIFYING EXAMPLE: HLVPM1.N	HLVPM1	27	2.8	\$ 298	\$ 10

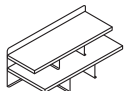

Not available in two-tone laminate
SIN 711-2

Desktop Storage Terrace 26 ¹ / ₂ "W x 12 ¹ / ₂ "D x 10 ¹ / ₂ "H NOTES: Keeps work-in-process, priority files, loose pages, and mail neatly organized and in view. Mixed material design comprised of sturdy laminate shelves with metal back and support panels. Not available in two-tone laminate combination or pattern laminate colors. Choose from Platinum Metallic (T1), Black (P), and Charcoal (S) for the metal components. Designed to be used on worksurfaces. Also sized to fit in stack-on and wall mounted storage cabinets, see compatibility chart on page 115. Specify: Model.Laminate.Paint SPECIFYING EXAMPLE: HLDST1.N.T1	HLDST1 E♦A	24	1.1	\$ 272	\$ 10
--	-------------------	----	-----	--------	-------

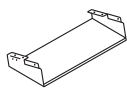

SIN 711-2

Description	Model	Ship Weight	Cube	List
Hanging Paper Shelf 28 ¹ / ₁₆ "W x 11 ⁷ / ₁₆ "D x 4 ⁵ / ₁₆ "H NOTES: Maximizes worksurface space; de-clutters desktop while placing priority communications and active project folders within easy reach. Angled design allows contents to be distinguished at a glance. Mixed material styling features strong painted metal frame with a frosted shelf. Attaches quickly and easily to stack-on and wall mount storage models, see compatibility chart on page 115. Choose from Platinum Metallic (T1), Black (P), and Charcoal (S) paint. Specify: Model.Paint SPECIFYING EXAMPLE: HHPS1.T1	HHPS1	7	2.9	\$ 175

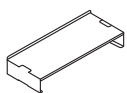

SIN 711-2

Desktop Paper Shelf 28 ¹ / ₁₆ "W x 11 ⁵ / ₈ "D x 5"H NOTES: Organizer shelf provides a place and space for work-in-process and piling to keep worksurfaces neat and tidy. Convenient, scalable design with interlocking side supports allow two units to be stacked and integrated. Durable painted metal frame with a frosted shelf; mixed material styling matches hanging paper shelf. Also sized to fit in stack-on and wall mounted storage cabinets, see compatibility chart on page 115 Choose from Platinum Metallic (T1), Black (P), and Charcoal (S) paint. Specify: Model.Paint SPECIFYING EXAMPLE: HDPS1.T1	HDPS1	7	2.9	\$ 175
--	--------------	---	-----	--------

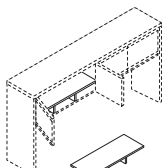

SIN 711-2

Stacked Paper Management 32 ¹ / ₂ "W x 12 ⁵ / ₈ "D x 4 ¹ / ₄ "H NOTES: Segments and organizes stack-on and wall mount storage compartments (see compatibility chart on page 115), as well as bookcase shelves. In some cases, installation may require removing the stack-on or wall mount storage doors. ⚠ Black only.	HLVPM2 E♦A	22	1.25	\$ 144
--	-------------------	----	------	--------

How to specify	1st Option
Select Model Number from above H L V P M 1 .	Select Laminate See pages 48-49 N

Icon Legend on page 10

PAPER ORGANIZERS FOR STACK-ON AND WALL MOUNTED STORAGE CABINETS









- Laminate vertical paper manager (HLVPM1) is designed for desk, credenza, and return tops; fits under stack-on and wall mount storage units.
- Laminate desktop storage terrace (HLDST1) for use on worksurfaces, or inside overhead storage compartments >26½"W.
- Metal desktop paper shelf (HDPS1) for use on worksurfaces, can be stacked two high, or inside overhead storage compartments >28¾"W.
- Stacked paper management (HLVPM2) can be positioned inside overhead storage cabinets >32½"W.
- Metal hanging paper shelf (HHPS1) attaches quickly and easily to the underside of stack-on and wall mounted storage models.
- For applications using the organizers inside stack-on and wall mounted storage compartments, the fit compatibility is as follows:

OUTSIDE WIDTH	INSIDE WIDTH	Stacked Paper Mgt. — 32½"W HLVPM2	Desktop Paper Shelf — 28¾"W HDPS1	Desktop Storage Terrace — 26½"W HLDST1	Hanging Paper Shelf — 28¾"W HHPS1
		Yes or No	Yes or No	Yes or No	*Qty — see NOTE
STACK-ON STORAGE W/ LAM DOORS, LAM LOCKING DOORS, FROSTED DOORS					
36"W	34.34	Y	Y	Y	1
42"W	40.34	Y	Y	Y	1
48"W (large compartment)	30.60	N	Y	Y	1
60"W	28.60	N	N	Y	2
66"W	31.60	N	Y	Y	2
72"W	34.60	Y	Y	Y	2
78"W	37.60	Y	Y	Y	2
STACK-ON STORAGE W/ SLIDING DOOR					
48"W	22.60	N	N	N	1
60"W	28.60	N	N	Y	2
66"W	31.60	N	Y	Y	2
72"W	34.60	Y	Y	Y	2
78"W	37.60	Y	Y	Y	2
WALL MOUNT STORAGE W/ LAM DOORS, LAM LOCKING DOORS, FROSTED DOORS					
30"W	28.35	N	N	Y	N
36"W	33.67	Y	Y	Y	1
42"W	39.67	Y	Y	Y	1
48"W (large compartment)	30.22	N	Y	Y	1
60"W	28.22	N	N	Y	2
66"W	31.22	N	Y	Y	2
72"W	34.22	Y	Y	Y	2
78"W	37.22	Y	Y	Y	2
WALL MOUNT STORAGE W/ SLIDING DOOR					
48"W	22.46	N	N	N	1
60"W	28.46	N	N	Y	2
66"W	31.46	N	Y	Y	2
72"W	34.46	Y	Y	Y	2
78"W	37.46	Y	Y	Y	2

*NOTE: For model HHPS1, quantity represents the number that can be mounted side-by-side under the cabinet.

- ▶ Interchangeable core removable locks are standard on most HON products.
- ▶ Removable lock core kits with specific key number must be ordered to facilitate keying alike in the field.
- ▶ For keyed alike locks:
 - Order standard product which will be shipped with factory installed locks and random numbered cores.
 - Order the appropriate quantity of like numbered cores required for each workstation or keyed area.
 - Simply replace the factory installed cores with the replacement cores after product has been installed.
- ▶ To install new core:
 - Lock must be in the unlocked position.
 - Insert core removal key and pull core straight out.
 - Insert new core with core removable key, hold core into lock and withdraw core removal key.
 - Retain original core for future use.
- ▶ To provide normal lead times, key numbers cannot be specified on HON products at time of order. This also eliminates need for tagging and tracking each product's lock number during installation.



	Description	Model	Ship Weight	Cube	List
  SIN 711-2	Black Removable Lock Core Kit <ul style="list-style-type: none"> • Specify quantity of each key number from 101E-225E. • Includes: 1-core, 2-keys, 1-core removal tool, and instructions. NOTES: If key number isn't specified, number will be at random.	HF23B	0.1 	0.1	\$ 28
  SIN 711-3	Satin Removable Lock Core Kit <ul style="list-style-type: none"> • Specify quantity of each key number from 101E-225E. • Includes: 1-core, 2-keys, 1-core removal tool, and instructions. NOTES: If key number isn't specified, number will be at random.	HF23S	0.1 	0.1	\$ 34
  Open Market	Removable Lock Core Kit Black Satin <ul style="list-style-type: none"> • For stack-on and wall mounted storage laminate models (with locks) in 10500, 10700, Valido, Park Avenue Laminate, Concinnity, and 94000 Series. • Specify quantity of each key number from 101E to 225E. • Includes: 1-core, 2-keys, 1-core removal tool, and instructions. NOTES: If key number isn't specified, number will be at random.	HF27B HF27S	0.2	0.02	\$ 28 \$ 28

HOW TO ORDER CORE REMOVABLE LOCK KITS:

Specify: Model Number.X
 Key Number
 Examples: HF23S.X121E
 HF23S.X (Key number not specified)

NOTES: Key orders without numbers specified will be keyed at random.
 Numbers 101E-225E are available.

SAMPLE ORDER:

Quantity	Model	Key Code
4	HF23B.	X121E

How to specify

Select Model Number from above



H | F | 2 | 3 | B

  Icon Legend on page 10

▶ Task lights are designed for use with stack-on storage and wall mounted storage cabinets.

▶ Task lights feature a new slim profile and electronic ballast for increased energy efficiency.

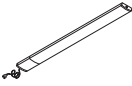

	Description	Model	Ship Weight	Cube	List
 Open Market	Recessed Task Lights — For Stack-on and Wall Mounted Storage Cabinets <ul style="list-style-type: none"> • Color: Black. • Slim profile design. • Mount to stack-on storage and wall mounted storage cabinets (see pages 135-136 and 147). • Electronic ballast for increased energy efficiency. • T5 bulb, included, which contains less mercury. • 9-foot black cord and switch off right rear corner. 				
	22 ⁷ / ₈ "W x 3 ¹ / ₁₆ "D x 1 ¹ / ₈ "H Chicago code version (with fused plug)	HH870930	7.0	0.60	\$ 205
	34 ⁵ / ₈ "W x 3 ¹ / ₁₆ "D x 1 ¹ / ₈ "H Chicago code version (with fused plug)	HH870930CH	7.0	0.60	\$ 268
		HH870942	10.0	0.90	\$ 222
		HH870942CH	10.0	0.90	\$ 282
		HH870960	12.0	1.10	\$ 240
	Chicago code version (with fused plug)	HH870960CH	12.0	1.10	\$ 300
 SIN 711-1	LED Task Lights — For Stack-on and Wall Mounted Storage Cabinets 17" LED Light with Power Supply (Single) 31" LED Light with Power Supply (Single) 17" LED Light with Power Supply for Daisy-chain (Starter) 31" LED Light with Power Supply for Daisy-chain (Starter) 17" LED Light with 8" Jumper Cord for Daisy-chain (Follower) 31" LED Light with 8" Jumper Cord for Daisy-chain (Follower)	HLED17AS HLED31AS	1.2 1.5	0.05 0.09	\$ 374 \$ 503
		HLED17A	1.0	0.05	\$ 411
		HLED31A	1.4	0.09	\$ 553
		HLED17AUO	1.0	0.03	\$ 335
		HLED31AUO	1.0	0.05	\$ 448
		Undercabinet Occupancy Sensor with 1" End to End Connector	HLEDOSA	0.2	0.01
	NOTES: To use the daisy chain application, must start with model HLED17A or HLED31A. No finish specification required. Attaches magnetically to underside of overhead storage, or attaches with provided screws or double-sided tape. Occupancy sensor attaches to a single or starter LED light and will automatically turn the light off after no motion is detected for 30 minutes. Just like all the LED light models, the occupancy sensor features a soft-touch on/off switch. LED task lights have a lifetime of 50,000 hours and have a dimmer feature that allows the user to adjust the amount of light output.				
 SIN 711-1	Articulating Desk Lamp Articulating Desk Lamp w/ Occupancy Sensor	HLED1 HLED10C	1.2 1.2	6.5 6.5	\$ 350 \$ 428
	Task Desk Lamp	HLED2	0.7	3.0	\$ 303
 SIN 711-1					

How to specify

Select Model Number from above
H | H | 8 | 7 | 0 | 9 | 3 | 0

Icon Legend on page 10

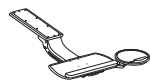

Refer to pages 749-750 for additional product information

Description	Model	Ship Weight	Cube	List by Paint Grade	
				Core	Metallics
Articulating Arm with Keyboard Platform	H1706	16	1.4	\$ 440	
Articulating Arm with Convertible Keyboard Platform	H2107	16	1.3	\$ 472	
Sit to Stand Arm with Convertible Keyboard Platform	H2516	17	1.6	\$ 551	
Slide-Away Keyboard Platform (Specify: Laminate)	H4022	10	0.6	\$ 194	
Extended Tray Slide-Away Keyboard Platform (Specify: Laminate)	HE4022	12	0.7	\$ 278	
Metal Keyboard and Mouse Tray (Specify paint)	H4028	11	1.5	\$ 140	\$ 150
Metal Keyboard Tray (Specify paint)	H4029	11	1.5	\$ 125	\$ 135

Concinnity™ Accessories — Monitor Arms

GSA SIN 711-2

Monitor Arms

► Arms fold back to post to allow more desktop room.

► Arms feature double extension, allowing 20" of back and forth movement.

► Cable management on both pole and arm assemblies.

► Counterbalance adjustment provides stability for monitors up to 17 lbs per arm.

► Made of high quality aluminum alloy material.

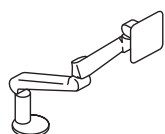

Description	Model	Ship Weight	Cube	List

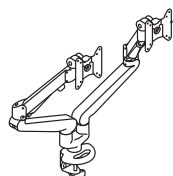

Dual Monitor Arm Single Mount with Dual Monitor. Effortless adjustment. Range of adjustment is 13" from 6½"-19½". <ul style="list-style-type: none"> • Single mount with dual monitor adjustment. • Monitor extends 21". • Monitor retracts 3½" to save space. • 360° swivel at two points with folding capabilities. • Monitor tilts +30" to -25". • Enclosed cable management. • Dual screen models allow screens to be aligned horizontally for optimal ergonomic positioning. • Includes desk clamp or grommet mount. ▲ Available in Silver finish only, no specification needed. For complete monitor arm features, see page 745.	H5220	15	1.8	\$ 889
---	--------------	----	-----	--------

How to specify







Select Model Number from above

H 1 | 7 | 0 | 6

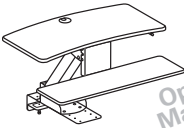

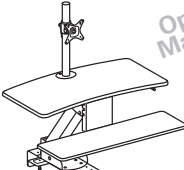
Icon Legend on page 10

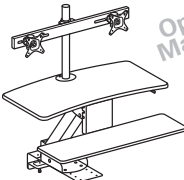
- ▶ These products are designed to allow the user to transition from seating position to standing position throughout the workday.
 - ▶ Gas-assist lever-operated mechanism with positive stop.
 - ▶ Clamp mount compatible with worksurfaces depths of 20"-30".
 - ▶ Clamp requires 3.5" of clearance along back edge of worksurface.
 - ▶ Black seamless worksurfaces.
 - ▶ Silver powder coated metal components.
 - ▶ Lowers below worksurface level on 24" and 30"D worksurfaces.
 - ▶ All models contain a large primary worksurface and a smaller keyboard / mouse surface.
 - ▶ Beveled edges for sleek appearance and comfort while typing.
 - ▶ Monitor arms include height, width, and swivel adjustment.
- ⚠ **Not recommended for use on mobile (castered) worksurfaces.**

	Description	Model	Ship Weight	Cube	List
	Directional™ Desktop Sit-to-Stand Device NOTES: Does not include a monitor arm and is suitable for laptops and/or monitors on their original stands.	HS1100	60 	3.2	\$ 525
	Directional™ Desktop Sit-to-Stand Device with Single Monitor Arm NOTES: Includes a monitor arm for a single monitor.	HS1101	62 	3.2	\$ 615
	Directional™ Desktop Sit-to-Stand Device with Dual Monitor Arm NOTES: Includes a monitor arm for dual monitors.	HS1102	63 	3.2	\$ 700

Mounting and Compatibility:

- This product is intended to be installed on commercial-grade worksurfaces in good condition.
- Compatible with freestanding worksurfaces 24"-30"D or panel-supported worksurfaces 24"-30"D.
- Not for use on mobile worksurfaces.

Clamp Mount

Use when 3.5" minimum overhang is available

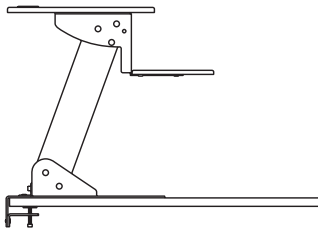

Screw Mount

Use when no overhang is available. Worksurface must be minimum 1" thick.

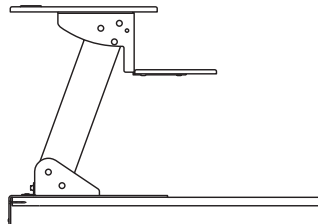

How to specify

Select Model Number from above

H | S | 1 | 1 | 0 | 0

  Icon Legend on page 10

- ▶ Durable scratch- and stain-resistant thermal-fused laminate over solid core particleboard.
- ▶ Worksurfaces and end panels are 1" thick; modesty panels are 3/8".
- ▶ Square edge detail.
- ▶ Drawers open with metal handle in silver finish; hole pattern center-to-center distance is 96 mm.
- ▶ Each 3/4-pedestal contains one box and one file drawer.
- ▶ Full extension ball-bearing drawer slides.
- ▶ File drawers include integrated hangrails for front-to-back for letter filing and side-to-side legal filing.
- ▶ All drawers lock; removable lock cores make re-keying quick and easy.
- ▶ Lock faces are black.
- ▶ Keyed alike cores must be ordered separately by specification of the field installable core (model HF23B) and the key number.
- ▶ 3" diameter grommet(s) in tops of desks to route cords; grommet cap is black.
- ▶ Wood-grain direction on modesty panels is horizontal (side-to-side).
- ▶ Adjustable leveling glides have 1/4" range.
- ▶ Desks, credenzas, and returns ship assembled.

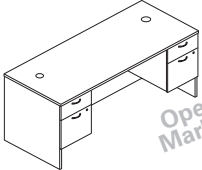
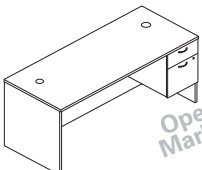
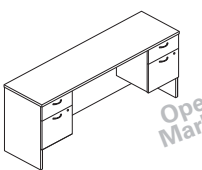
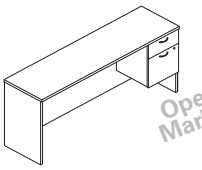
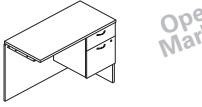
	Description	Full Width Overhang	Model	Ship Weight	Cube	L1 List	L2 List
 <p>Open Market</p>	Double Pedestal Desk 72"W x 30"D x 29 1/2"H 60"W x 30"D x 29 1/2"H	7 3/8" 7 3/8"	HLL3072DP HLL3060DP	208 191	43.6 36.7	\$ 991 \$ 867	\$ 1041 \$ 910
	<p>NOTES: Two-drawer pedestal left and right; each with 1-box and 1-file drawer. Clear inside depth in kneespace is 21 3/4". Two cord grommets in top. Cord pass-through gap below modesty panel. Double pedestal desks can be used in combination with a credenza with kneespace or as stand-alone unit.</p>						
 <p>Open Market</p>	Single Pedestal Desk 72"W x 30"D x 29 1/2"H, Right 72"W x 30"D x 29 1/2"H, Left	7 3/8" 7 3/8"	HLL3072RP HLL3072LP	182 182	43.6 43.6	\$ 820 \$ 820	\$ 861 \$ 861
	<p>NOTES: Two-drawer pedestal with 1-box and 1-file drawer. Clear inside depth in kneespace is 21 3/4". Two cord grommets in top. Cord pass-through gap below modesty panel. Single pedestal desks can be used with a return to form an L-shaped configuration, or with a bridge and single pedestal credenza to form a U-shaped workstation.</p>						
 <p>Open Market</p>	Credenza with Kneespace 72"W x 19 7/8"D x 29 1/2"H 60"W x 19 7/8"D x 29 1/2"H		HLL2072DP HLL2060DP	167 153	30.1 25.2	\$ 895 \$ 846	\$ 940 \$ 888
	<p>NOTES: Two-drawer pedestal left and right; each with 1-box and 1-file drawer. Clear inside depth in kneespace is 17 1/4". Cord pass-through gap below modesty panel. Credenza with kneespace models can be used with double pedestal desk or as stand-alone unit.</p>						
 <p>Open Market</p>	Single Pedestal Credenza 72"W x 19 7/8"D x 29 1/2"H, Right 72"W x 19 7/8"D x 29 1/2"H, Left		HLL2072RP HLL2072LP	142 142	30.1 30.1	\$ 737 \$ 737	\$ 774 \$ 774
	<p>NOTES: Two-drawer pedestal with 1-box and 1-file drawer. Clear inside depth in kneespace is 17 1/4". Cord pass-through gap below modesty panel. Single pedestal credenzas can be used with a bridge and single pedestal desk to form a U-shaped set-up.</p>						
 <p>Open Market</p>	Return with Pedestal 42"W x 19 7/8"D x 29 1/2"H, Right 42"W x 19 7/8"D x 29 1/2"H, Left		HLL2042RP HLL2042LP	92 92	18.3 18.3	\$ 581 \$ 581	\$ 610 \$ 610
	<p>NOTES: Two-drawer pedestal with 1-box and 1-file drawer. Clear inside depth in kneespace is 18 3/4". Cord pass-through gap below modesty panel. Returns are for L-shaped workstations; connects to single pedestal desk. ⚠ Not designed to be used freestanding.</p>						

How to specify	Select Model Number from above	1st Option Select Laminate Color
	H L L 3 0 7 2 D P .	F F F Shaker Cherry (L1) MOCH Mocha (L1) PINC Pinnacle (L1) LPT1 Portico Teak (L2)

⚠ Icon Legend on page 10

- ▶ Durable scratch- and stain-resistant thermal-fused laminate over solid core particleboard.
- ▶ Bridge and lateral file worksurfaces are 1" thick.
- ▶ Square edge detail.
- ▶ Full extension ball-bearing drawer slides.
- ▶ File drawers include integrated hangrails for front-to-back for letter filing and side-to-side legal filing.
- ▶ All drawers lock; removable lock cores make re-keying quick and easy.
- ▶ Lock faces are black.
- ▶ Keyed alike cores must be ordered separately by specification of the field installable core (model HF23B) and the key number.
- ▶ Adjustable leveling glides have ¼" range.

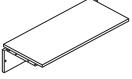
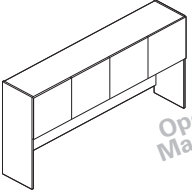
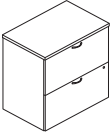
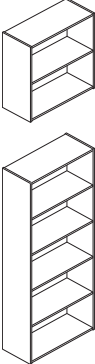

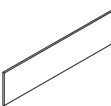
	Description	Model	Ship Weight	Cube	L1 List	L2 List
 Open Market	Bridge 44½"W x 19⅞"D x 10½"H NOTES: Clear inside depth in kneespace is 17¾". Short modesty panel provides access to wall electrical outlets. Bridges are for U-shaped workstations — connect single pedestal desk to single pedestal credenza. ⚠ Not designed to be used freestanding.	HLL2045BR EDA	40	2.9	\$ 235	\$ 247
 Open Market	Stack-On Storage 72"W x 14½"D x 36⅞"H 60"W x 14½"D x 36⅞"H NOTES: Stack-on storage maximizes the use of vertical space. Hinged doors are adjustable. Vertical clearance for computer monitor is 19¾". Enclosed back provides privacy; back includes a full-width slot to route cords. Attaches to desks and credenzas with double-sided tape. 72"W size can also be used to span the total depth dimension of an L-shaped configuration comprised of 30"D single pedestal desk attached to a 42"W return. Design includes valance to hide task lights. Assembly required. Stack-on storage options include tackboards (see below) and task lights; both sold separately. Task light compatibility: Use H870960 for 72"W and 60"W.	HLL1472SD EDA HLL1460SD EDA	137 118	16.3 13.7	\$ 807 \$ 746	\$ 847 \$ 783
 Open Market	Lateral File 30"W x 20"D x 29½"H — 2-Drawer NOTES: Includes mechanical interlock to inhibit opening of more than one drawer at a time. Aligns with 20"D credenzas and returns. Ships assembled.	HLL2030L2	127	13.0	\$ 674	\$ 708
 Open Market	Bookcases 29¾"W x 13"D x 29½"H — 2-Shelf 29¾"W x 13"D x 71½"H — 5-Shelf NOTES: Bookcases have fixed shelves; inside shelf dimensions are 28⅜"W x 12"D x 13⅜"H. Assembly required.	HLL1330B2 EDA HLL1330B5 EDA	51 111	1.9 3.3	\$ 342 \$ 580	\$ 359 \$ 609

	Description	Model	Ship Weight	Cube	List
 Open Market 18"H	Tackboards for use with Stack-On Storage 68¾"W — Tackboard for 72" / HLL1472SD 56¾"W — Tackboard for 60" / HLL1460SD NOTES: Tackboard mounts to stack-on storage back using the latch and hook tape provided. Tackboards are available in the following HON Grade A Element fabric patterns: Flint (GN65), Parchment (GN53), Veil (GN13). Not available in COM. SPECIFYING EXAMPLE: HLL72TBK.GN65	HLL72TBK HLL60TBK	12 10	2.7 2.2	\$ 221 \$ 184

How to specify	Select Model Number from above H L L 2 0 4 5 B R .	1st Option Select Laminate Color F Shaker Cherry (L1) MOCH Mocha (L1) PINC Pinnacle (L1) LPT1 Portico Teak (L2) F F
----------------	---	--

⚠ EDA Icon Legend on page 10

- ▶ For keyed alike locks:
 - Order standard product which will be shipped with factory installed locks and random numbered cores.
 - Order the appropriate quantity of like numbered cores required for each workstation or keyed area.
 - Simply replace the factory installed cores with the replacement cores after product has been installed.
- ▶ To install new core:
 - Lock must be in the unlocked position.
 - Insert core removal key and pull core straight out.
 - Insert new core with core removable key, hold core into lock and withdraw core removal key.
 - Retain original core for future use.

	Description	Model	Ship Weight	Cube	List
  <p>SIN 711-2</p>	<p>Black Removable Lock Core Kit (for laminate products) Specify quantity of each key number from 101E-225E. Includes: 1-core, 2-keys, 1-core removal tool, and instructions. NOTES: If key number isn't specified, number will be at random.</p>	HF23B	0.1 	0.1	\$ 28



HOW TO ORDER CORE REMOVABLE LOCK KITS:

Specify: Model Number.X
 Key Number
 Examples: HF23C.X121E
 HF23C.X (Key number not specified)

NOTES: Key orders without numbers specified will be keyed at random.
 Numbers 101E-225E are available.

SAMPLE ORDER:

Quantity	Model	Key Code
6	HF23C.	X121E
4	HF23B.	X121E
5	HF24.	X121E
1	HF22.	X
2	HF24.	X



<p>Field Installable Grommet</p> <ul style="list-style-type: none"> • Intended for use in tops and end panels to route/hide cords and in modesty panels to facilitate reaching wall electrical outlets. • Black Finish • Grommet is field installable. • Requires a 3" diameter hole saw and drill for installation (not included). • Grommet shape is round. • Includes grommet cap and sleeve. • Grommet outside dimensions measures 3 1/2" diameter and includes two cord access holes. • Grommet sleeve measures 3" O.D. x 1" thick. • Includes instructions to locate grommet position for desks, credenzas, returns and bridges. 	HFLDGRMT3	0.1 	0.3	\$ 28
--	------------------	---	-----	-------

 Icon Legend on page 10

Edge Profiles

Tops have both shaped and flat edges (except for conference tables). Flat edges allow side-by-side placement of worksurfaces without gaps. The tops of desks, peninsulas and the reception station/transaction counter are shaped on the user's side and the approach side.

Return, credenza, bridge, corner unit, stack-on storage, wall mounted storage cabinet, mobile pedestal, lateral file, storage cabinet, bookcase hutch, bookcase, end cap bookshelf, storage/file cabinet, storage cabinet/lateral file, wardrobe/storage cabinet, modular return, modular credenza and tower bookcase tops are shaped on the user's side.

The tops of conference tables are shaped on all sides.

Edge Options:

Beaded Edge
Double-Crest Edge
Tri-Oval Edge

Designator

B
E
V

Edge Options:



Beaded Edge "B"



Double-Crest Edge "E"



Tri-Oval Edge "V"

Drawer/Door Handles

Park Avenue Collection® handles are designed to be easy to grasp. Handles are metal and are located on all pedestal drawer fronts and lateral files. Handles are also on the doors of the storage cabinet, storage/file cabinet with laminate door, storage cabinet/lateral file with laminate doors and wardrobe/storage cabinet. Handles are not used on stack-on or wall mounted storage, or frosted/nickel door units.

Handles are available in three finishes: Black, Brushed Brass, and Satin Nickel. Alpha designators are shown above.

Drawer/Door Handle Options:

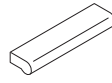

Bar Designator

Black A*
Brushed Brass B*
Satin Nickel C*

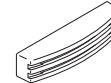

Fluted Designator

Black D
Brushed Brass E
Satin Nickel F



Loop Designator

Black G
Brushed Brass H
Satin Nickel J

Color Options:

Bourbon Cherry
Cognac
Harvest
Mahogany
Mocha
Natural Maple
Pinnacle
Shaker Cherry

Designator

HH
COGNCOGN
CC
NN
MOCHMOCH
DD
PINCINC
FF

EXAMPLES OF HOW TO SPECIFY

Desks, credenzas, returns, mobile pedestals, lateral files, storage cabinet with doors, storage / file cabinet with laminate door, storage cabinet / lateral file with laminate doors, and wardrobe / storage cabinets —

SPECIFY: Model #.Edge.Handle.Laminate

EXAMPLE: HPC203D.B.A.HH

Bullet peninsulas, stack-on storage, wall mounted storage cabinets, reception station / transaction counter, bookcase hutches, bookcases, end cap bookshelves, storage cabinet / lateral file with frosted doors, and tower bookcases —

SPECIFY: Model #.Edge.Laminate

EXAMPLE: HPC100X.B.HH

***Jetty and boomerang peninsulas, bridges, corner units, modular credenza top/back components, modular return top/back components, and modular extended corner unit top/back/end panel components —**

SPECIFY: Model #.Edge.Grommet.Laminate

EXAMPLE: HPC130R.B.A.HH

***NOTE:** The above products do not have a handle option. They do, however, have a top grommet that requires color specification. Consequently, for these products, the handle designator field becomes a grommet finish designator. For grommet finish, A = Black; B = Brushed Brass; C = Satin Nickel.

*NOTE: The jetty and boomerang peninsulas, bridges, corner units, modular credenza top/back components, modular return top/back components, and modular extended corner top/back/end panel components do not have a handle option. They do, however, have a top grommet that requires color specification. Consequently, for these products, the handle designator field becomes a grommet finish designator. For grommet finish, A = Black; B = Brushed Brass; C = Satin Nickel.

HOW TO SPECIFY

Note: Color specification requires two characters, except for the following which require one color code character only:

- modesty panels (for peninsulas)
- modular pedestals
- modular end panels
- shared 10500 Series™ solutions (transaction counter organizer, vertical paper manager)
- laminate center drawers

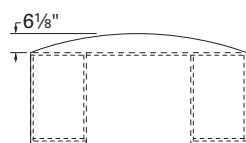
Conference Overhang Dimensions

**Bow Front,
Recessed Modesty Panel**
72" W x 36" D Models:
HPC023D, HPC023R, HPC023L



**Rectangle,
Recessed Modesty Panel**
72" W x 36" D Models:
HPC027D, HPC027R, HPC027L

Styling

Park Avenue Laminate combines sophisticated styling with the hard-working attributes of laminate. The upscale design features clean form with uninterrupted, rigid lines, sweeping curves and precise fits. Tops are available in three different edge profiles / shapes. The edge detailing conveys the beauty of real wood but offers superior durability. Drawer / door handles can be specified from three designs and three finishes. The insert for worksurface cord grommet covers is color matched to drawer / door handle finishes. All desk, credenza, and return models feature full-to-the-floor pedestals to maximize storage space and formal, full-length modesty panels. All vertical components, including drawer and door fronts, modesty panels, and stack-on storage enclosures have vertical grain. The option of frosted / nickel doors and modesty panel provides an attractive blend of materials and an enhanced look.

Materials / Construction

Tops and end panels are scratch- and stain-resistant laminate over durable 1 1/8" solid core high-performance particleboard. Profiled and flat edges are scuff and impact resistant. Laminate surfaces are designed to withstand the daily wear-and-tear in today's offices, including hot and cold spills. The chassis is constructed with European-designed fasteners, enabling the tops or end panels to be replaced, if necessary. These strong metal-to-metal connections ensure a long life cycle. All fasteners are positioned by computer to maintain rigorous dimensional standards and precise positioning. Drawers operate on steel ball-bearing suspensions for smooth, quiet, long-lasting operation.

Storage in Desks

Pencil/media/file pedestals store and organize CD's, in addition to conventional supplies and paper media. The top drawer holds supplies. The middle drawer features a media organizer to hold blank CD's (flat storage), standard and slim profile CD jewel cases, VHS tapes, 3 1/2" or Zip® disks, and other miscellaneous items. The organizer stores CD jewel cases in the "label up" position for easier identification and cataloging. The media organizer can be easily removed so drawer can be re-purposed for other storage needs. The organizer features legs for angled positioning on desktops or in HON stack-on storage units. The bottom drawer is for files and includes hangrails for side-to-side letter or legal filing; and front-to-back for letter filing.

File/file pedestals accept hanging folders; hangrails are included in all drawers, for side-to-side letter or legal filing; and front-to-back for letter filing.

Cord Management

Park Avenue Laminate is designed with a host of cord management features. Worksurface grommets route and hide wires and cables. The sides / end panels of desk, credenza and return storage pedestals are designed with a cord pass-through grommet to allow connections between workstations. And, all return, bridge and credenza modesty panels contain a cord pass-through to facilitate reaching wall electrical outlets.

Security

Interchangeable core removable locks are located on the front of all desk, credenza and return pedestals, mobile pedestals, lateral files, storage/file cabinet and storage cabinet/lateral file with laminate doors, and the wardrobe/storage cabinet. All drawers / doors on these units are equipped with a removable cylinder that can be interchanged as needed, allowing users to access all furniture pieces in an office with a single key for convenience and security. Makes re-keying quick and easy.

Product Performance

All models meet or exceed ANSI/BIFMA and ISTA performance standards.

Components used are listed on pages 131-149. Order components individually.
Other configurations are possible, including various sizes of some components.

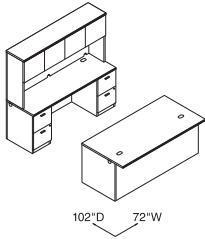

Qty.	Model #	Description
1	HPC027D D	Double Pedestal Desk - 3/2 72"W x 36"D x 29"H
1	HPC210D D	Credenza with Kneespace - 2/2 72"W x 24"D x 29"H
1	HPC501W D	Stack-on Storage, Laminate Doors 72"W x 14 3/4"D x 37 1/8"H

Desk/Credenza
72"W x 102"D

List Price	Price Extension
\$2,299	\$2,299
\$2,062	\$2,062
\$1,494	\$1,494
TOTAL:	\$5,855

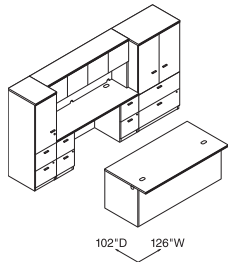

Qty.	Model #	Description
1	HPC027D D	Double Pedestal Desk - 3/2 72"W x 36"D x 29"H
1	HPC210D D	Credenza with Kneespace - 2/2 72"W x 24"D x 29"H
1	HPC501W D	Stack-on Storage, Laminate Doors 72"W x 14 3/4"D x 37 1/8"H
1	HPC710L D	Storage/File Cabinet w/Laminate Door 18"W x 24"D x 66 1/8"H
1	HPC720W D	Storage Cabinet/Lateral File, Laminate Doors 36"W x 24"D x 66 1/8"H

Desk/Credenza
126"W x 102"D

List Price	Price Extension
\$2,299	\$ 2,299
\$2,062	\$ 2,062
\$1,494	\$ 1,494
\$1,977	\$ 1,977
\$2,590	\$ 2,590
TOTAL:	\$10,422

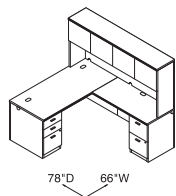

Qty.	Model #	Description
1	HPC031L D	Single Pedestal Desk, Left - b/b/f 66"W x 30"D x 29"H
1	HPC324R D	Return, Right - f/f 48"W x 24"D x 29"H
1	HPC500W D	Stack-on Storage, Laminate Doors 78"W x 14 3/4"D x 37 1/8"H

"L" Workstation
66"W x 78"D

List Price	Price Extension
\$1,819	\$1,819
\$1,269	\$1,269
\$1,652	\$1,652
TOTAL:	\$4,740

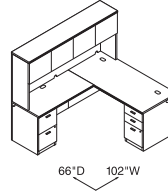

Qty.	Model #	Description
1	HPC031R D	Single Pedestal Desk, Right - b/b/f 66"W x 30"D x 29"H
1	HPC324L D	Return, Left - f/f 48"W x 24"D x 29"H
1	HPC500W D	Stack-on Storage, Laminate Doors 78"W x 14 3/4"D x 37 1/8"H

"L" Workstation
102"W x 66"D

List Price	Price Extension
\$1,819	\$1,819
\$1,269	\$1,269
\$1,652	\$1,652
TOTAL:	\$4,740

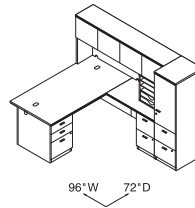

Qty.	Model #	Description
1	HPC027L D	Single Pedestal Desk, Left - b/b/f 72"W x 36"D x 29"H
1	HPC325R D	Return, Right - f/f 42"W x 24"D x 29"H
1	HPC500W D	Stack-on Storage, Laminate Doors 78"W x 14 3/4"D x 37 1/8"H
1	HPC710R D	Storage/File Cabinet w/Laminate Door 18"W x 24"D x 66 1/8"H
1	HLVPM1	Vertical Paper Manager

"L" Workstation
72"W x 102"D

List Price	Price Extension
\$1,943	\$1,943
\$1,239	\$1,239
\$1,652	\$1,652
\$1,977	\$1,977
\$ 298	\$ 298
TOTAL:	\$7,109

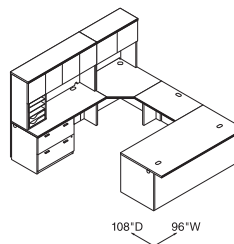

Qty.	Model #	Description
1	HPC027R D	Single Pedestal Desk, Right - b/b/f 72"W x 36"D x 29"H
1	HPC404X D	Bridge 36"W x 24"D x 29"H
1	HPC153X D	36" Corner Unit
1	HPC507W D	Stack-on Storage, Laminate Doors 36"W x 14 3/4"D x 37 1/8"H
1	HPM704X D	Return Top, Back Panel, Support Legs 60"W x 24"D x 29"H
1	HPM520X D	Lateral File Pedestal 31 3/8"W x 22 3/4"D x 27 3/4"H
1	HPC503W D	Stack-on Storage, Laminate Doors 48"W x 14 3/4"D x 37 1/8"H
1	HLVPM1	Vertical Paper Manager

"U" Workstation with Corner Unit
96"W x 108"D

List Price	Price Extension
\$1,943	\$1,943
\$ 453	\$ 453
\$ 920	\$ 920
\$1,004	\$1,004
\$ 699	\$ 699
\$1,179	\$1,179
\$1,386	\$1,386
\$ 298	\$ 298
TOTAL:	\$7,882

Park Avenue Collection® Laminate Wood Desks — Typicals



Components used are listed on pages 131-149. Order components individually.
Other configurations are possible, including various sizes of some components.

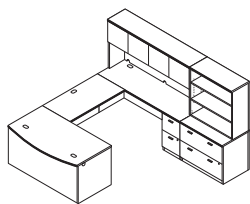

“U” Workstation
108”W x 108”D

Qty.	Model #	Description	List Price	Price Extension
1	HPC023L	Single Pedestal Bow Top Desk, Left - b/b/f 72”W x 36”D x 29”H	\$2,099	\$2,099
1	HPC402X	Bridge 48”W x 24”D x 29”H	\$ 485	\$ 485
1	HPC230R	Single Pedestal Credenza, Right, f/f 72”W x 24”D x 29”H	\$1,679	\$1,679
1	HPC501W	Stack-on Storage, Laminate Doors 72”W x 14 3/4”D x 37 1/8”H	\$1,494	\$1,494
1	HPC634X	Lateral File 36”W x 24”D x 29”H	\$1,322	\$1,322
1	HPC690X	Bookcase Hutch - Open 36”W x 14 3/4”D x 37 1/8”H	\$ 781	\$ 781
TOTAL:			\$7,860	

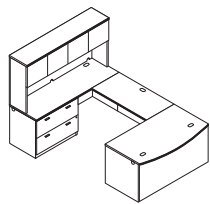

“U” Workstation
96”W x 108”D

Qty.	Model #	Description	List Price	Price Extension
1	HPC023R	Single Pedestal Bow Top Desk, Right - b/b/f 72”W x 36”D x 29”H	\$2,099	\$2,099
1	HPC402X	Bridge 48”W x 24”D x 29”H	\$ 485	\$ 485
1	HPC233L	Credenza with 36” Lateral, Left 72”W x 24”D x 29”H	\$1,869	\$1,869
1	HPC501W	Stack-on Storage, Laminate Doors 72”W x 14 3/4”D x 37 1/8”H	\$1,494	\$1,494
TOTAL:			\$5,947	

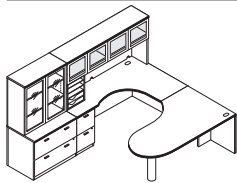

“U” Workstation
108”W x 96”D

Qty.	Model #	Description	List Price	Price Extension
1	HPC130R	Jetty Peninsula w/End Panel, Right 72”W x 30/48”D x 29”H	\$1,288	\$1,288
1	HPC190X	Support Column for Peninsula	\$ 144	\$ 144
1	HPM680L	Extended Corner Top, Left 24-72” x 48-24” x 29”H	\$1,131	\$1,131
1	HPM514X	File/File Pedestal 15 1/8”W x 22 3/4”D x 27 3/4”H	\$ 814	\$ 814
1	HPC501G	Stack-on Storage, Frosted Doors 72”W x 14 3/4”D x 37 1/8”H	\$2,094	\$2,094
1	HLVPM1	Vertical Paper Manager	\$ 298	\$ 298
1	HPC634X	Lateral File 36”W x 24”D x 29”H	\$1,322	\$1,322
1	HPC690G	Bookcase Hutch — Frosted Doors 36”W x 14 3/4”D x 37 1/8”H	\$1,481	\$1,481
TOTAL:			\$8,572	

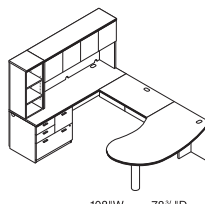

“U” Workstation
78 3/8”W x 108”D

Qty.	Model #	Description	List Price	Price Extension
1	HPC140R	Boomerang Peninsula w/End Panel, Right 72”W x 30/42”D x 29”H	\$1,175	\$1,175
1	HPC190X	Support Column for Peninsula	\$ 144	\$ 144
1	HPC403X	Bridge 42”W x 24”D x 29”H	\$ 462	\$ 462
1	HPM630X	Credenza Top and Back Panel Components 78 3/8”W x 24”D	\$ 777	\$ 777
1	HPM692R	End Panel for 24”D Tops, Right	\$ 199	\$ 199
1	HPM522X	Multi File Pedestal 31 3/8”W x 22 3/4”D x 27 3/4”H	\$1,374	\$1,374
1	HPM801W	Stack-on Storage, Laminate Doors, Enclosed Back 62 3/4”W x 14 3/4”D x 37 1/8”H	\$1,416	\$1,416
1	HPM828X	Tower Bookcase - Open 15 11/16”W x 14 3/4”D x 37 1/8”H	\$ 589	\$ 589
TOTAL:			\$6,136	

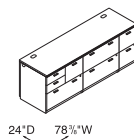

Modular Storage
78 3/8”W x 24”D

Qty.	Model #	Description	List Price	Price Extension
1	HPM630X	Credenza Top and Back Panel Components 78 3/8”W x 24”D	\$ 777	\$ 777
1	HPM522X	Multi File Pedestal 31 3/8”W x 22 3/4”D x 27 3/4”H	\$1,374	\$1,374
1	HPM520X	Lateral File Pedestal 31 3/8”W x 22 3/4”D x 27 3/4”H	\$1,179	\$1,179
1	HPM514X	File/File Pedestal 15 1/16”W x 22 3/4”D x 27 3/4”H	\$ 814	\$ 814
TOTAL:			\$4,144	

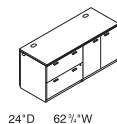

Modular Storage
62 3/4”W x 24”D

Qty.	Model #	Description	List Price	Price Extension
1	HPM633X	Credenza Top and Back Panel Components 62 3/4”W x 24”D	\$ 707	\$ 707
1	HPM520X	Lateral File Pedestal 31 3/8”W x 22 3/4”D x 27 3/4”H	\$1,179	\$1,179
1	HPM524X	Storage Cabinet Pedestal 31 3/8”W x 22 3/4”D x 27 3/4”H	\$ 827	\$ 827
TOTAL:			\$2,713	

Icon Legend on page 10 **D** Discontinued 7/1/2017.

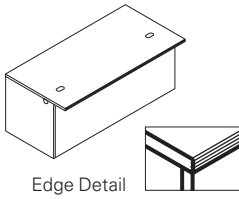

- ▶ Upscale design with clean, uninterrupted lines, precise fits, and vertically matched woodgrain.
- ▶ Tops are available in three decorative, durable edge designs (see page 127).
- ▶ Drawer / door handles are available in three styles and three finishes (see page 127).
- ▶ Media drawer can be used to store CD's or conventional supplies.
- ▶ For components that can be shared with Park Avenue Laminate Series, see pages 133-140.
- ▶ Tops are abrasion- and stain-resistant laminate over durable 1 1/8" solid core high-performance particleboard; resists warping.
- ▶ Full-to-the-floor pedestals maximize storage space.
- ▶ Formal, full-height modesty panels feature vertical woodgrain direction.
- ▶ Drawers operate on steel ball-bearing suspensions to ensure smooth, quiet, long-lasting operation.
- ▶ File drawers extend fully and include hangrails for side-to-side letter and legal filing; and front-to-back for letter filing.
- ▶ Drawer fronts have vertical woodgrain and are matched in sets to assure continuous grain pattern.
- ▶ Cord management grommets facilitate routing and hiding wires/cables and reaching wall electrical outlets.
- ▶ Desk, return and credenza models ship assembled.



	Description	Full Width Overhang	Model	Ship Weight	Cube	List
	Double Pedestal Desk					
	72"W x 36"D x 29"H, Bow Top, 3-2	6 1/8"	HPC023D D	293	51.8	\$2429
	72"W x 36"D x 29"H, Rectangle Top, 3-2	6 1/8"	HPC027D D	299	51.8	\$2299
	66"W x 30"D x 29"H, Rectangle Top, 3-2		HPC031D D	285	40.2	\$2195
	60"W x 30"D x 29"H, Rectangle Top, 3-2		HPC032D D	280	36.7	\$2122
	NOTES: Pencil/media/file drawers left; file/file drawers right. Pencil drawer includes removable organizer tray. All drawers lock. Recessed modesty panel on 72"W desk provides a conference overhang for meetings. 60" and 66"W models have flush modesty panels. Cord grommets in top and side panels. See page 140 for optional center drawers.					
	Single Pedestal Desk, Bow Top					
	72"W x 36"D x 29"H, Right (shown)	6 1/8"	HPC023R D	285	51.8	\$2099
	72"W x 36"D x 29"H, Left	6 1/8"	HPC023L D	285	51.8	\$2099
	NOTES: Pencil/media/file drawers. Pencil drawer includes removable organizer tray. Drawers lock. Recessed modesty panel on 72"W desk provides a conference overhang for meetings. Cord grommets in top and side panels. See page 140 for optional center drawers.					
	Single Pedestal Desk, Rectangle Top					
	72"W x 36"D x 29"H, Right (shown)	6 1/8"	HPC027R D	266	51.8	\$1943
	66"W x 30"D x 29"H, Right		HPC031R D	242	40.2	\$1819
	72"W x 36"D x 29"H, Left	6 1/8"	HPC027L D	266	51.8	\$1943
	66"W x 30"D x 29"H, Left		HPC031L D	242	40.2	\$1819
	NOTES: Pencil/media/file drawers. Pencil drawer includes removable organizer tray. Drawers lock. Recessed modesty panel on 72"W desk provides a conference overhang for meetings. 66"W models have flush modesty panels. Cord grommets in top and side panels. See page 140 for optional center drawers.					
	Return, Right, file/file					
	48"W x 24"D x 29"H		HPC324R D	165	24.1	\$1269
	42"W x 24"D x 29"H		HPC325R D	145	21.3	\$1239
	Return, Left, file/file					
	48"W x 24"D x 29"H		HPC324L D	165	24.1	\$1269
	42"W x 24"D x 29"H		HPC325L D	145	21.3	\$1239
	NOTES: Return is for use with single pedestal desks, peninsulas, or corner units. One cord pass-through grommet in top, top center of modesty panel and in each side of pedestal. Drawers lock. See page 135 for optional stack-on storage.					
	⚠ Not designed to be used freestanding.					

NOTE: See pages 133 through 140 for shared components.

How to specify	1st Option	2nd Option	3rd Option
Select Model Number from above	Select Edge Profile See page 127	Select Handle Option See page 127	Select Laminate See pages 48-49
H P C 2 0 3 D .	B .	A .	H H

Park Avenue Collection® Laminate Wood Desks

GSA SIN 711-2

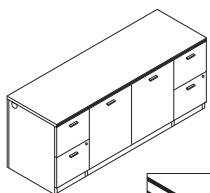

Edge Detail



- ▶ For components that can be shared with Park Avenue Collection Laminate Series, see pages 133-140.
 - ▶ Tops are abrasion- and stain-resistant laminate over durable 1 1/8" solid core high-performance particleboard; resists warping.
 - ▶ Full-to-the-floor pedestals maximize storage space.
 - ▶ Formal, full-height modesty panels feature vertical grain direction.
 - ▶ Drawers operate on steel ball-bearing suspensions to ensure smooth, quiet, long-lasting operation.
 - ▶ File drawers extend fully and include hangrails for side-to-side letter and legal filing; and front-to-back for letter filing.
 - ▶ Drawer fronts have vertical woodgrain and are matched in sets to assure continuous grain pattern.
 - ▶ Cord management grommets facilitate routing and hiding wires/cables and reaching wall electrical outlets.
 - ▶ For Park Avenue Collection Laminate matching Conference Tables, see page 149.
- △ **Removable lock core kit for desks, credenzas, returns, lateral files, storage cabinets, wardrobes, mobile and modular pedestals is model HF23B, see page 743.**

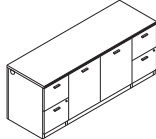
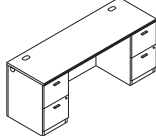
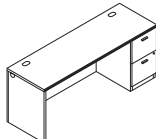
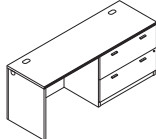

	Description	Model	Ship Weight	Cube	List
	Credenza with Storage 72"W x 24"D x 29"H NOTES: Four file drawers, 2-left, 2-right. All drawers lock. Doors are non-locking. Cabinet includes one adjustable shelf. Cord management grommets in back and in sides of pedestals. See page 135 for optional stack-on storage.	HPC200D D	349	35.6	\$2429
	Credenza with Kneespace 72"W x 24"D x 29"H 66"W x 24"D x 29"H 60"W x 24"D x 29"H NOTES: Four file drawers, 2-left, 2-right. All drawers lock. Cord management grommets in top, back and in sides of pedestals. See page 135 for optional stack-on storage.	HPC210D D HPC211D D HPC212D D	260 250 248	35.6 32.7 29.9	\$2062 \$2005 \$1971
	Credenza, Single Pedestal 72"W x 24"D x 29"H, Right (shown) — file/file 72"W x 24"D x 29"H, Left — file/file NOTES: Drawers lock. Cord management grommets in top, back and in side/vertical panels, including sides of pedestals. See page 135 for optional stack-on storage. Accommodates Park Avenue Laminate mobile or modular pedestals.	HPC230R D HPC230L D	213 213	35.6 35.6	\$1679 \$1679
	Credenza with Lateral File 72"W x 24"D x 29"H, Right (shown) 72"W x 24"D x 29"H, Left NOTES: Drawers lock. Hangrails for letter or legal size filing are included. Mechanical interlock inhibits the extension of more than one drawer at a time. Cord management grommets in top, back and in side/vertical panels, including sides of lateral file. See page 135 for optional stack-on storage. Accommodates Park Avenue Laminate mobile or modular pedestals.	HPC233R D HPC233L D	271 271	35.6 35.6	\$1869 \$1869





NOTE: See pages 133 through 140 for shared components.

How to specify	1st Option	2nd Option	3rd Option
Select Model Number from above H P C 2 0 0 D .	Select Edge Profile See page 127 B .	Select Handle Option See page 127 A .	Select Laminate See pages 48-49 H H

Icon Legend on page 10 D Discontinued 7/1/2017.

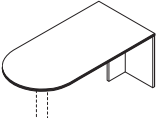
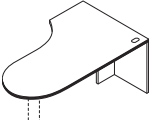
- ▶ Shared components shown on this page can be used with full pedestal models shown on pages 131-132 and modular components shown on pages 141-148.
- ▶ Jetty and Boomerang peninsulas are designed and sized to efficiently serve as both a computing and conferencing space.
- ▶ Adjustable hex leveling glides allow floor-standing furniture to be easily leveled; glides have 3/4" adjustable range.
- ▶ Field installable modesty panel for peninsulas is available in laminate or frosted/silver.
- ▶ Mobile pedestals shown on page 137 work well in a variety of configurations.
- ▶ For stack-on and wall mounted storage options, see pages 135-136.
- ▶ **Support column must be specified for peninsulas; column is sold separately.**

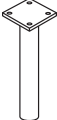

	Description	Model	Ship Weight	Cube	List
 <p>Support column sold separately</p>	Bullet Peninsula w/End Panel 72"W x 36"D x 29"H 66"W x 30"D x 29"H NOTES: For use in "U" or "L" shaped layout. Comprised of top and end/brace panels. Cord routing notch in the brace panel. Accepts field installable modesty panels HPC180W or HPC180G (see below). See page 140 for optional center drawers. ⚠ Not designed to be used freestanding.	HPC100X E♦A D	123	6.9	\$ 944
		HPC111X E♦A D	98	5.4	\$ 827
 <p>Right-hand model HPC130R shown</p> <p>Support column sold separately</p>	Jetty Peninsula w/End Panel 72"W x 30/48"D x 29"H, Right (shown) 72"W x 30/42"D x 29"H, Right Jetty Peninsula w/End Panel 72"W x 48/30"D x 29"H, Left 72"W x 42/30"D x 29"H, Left NOTES: For use in "U" or "L" shaped layout. Designed and sized to efficiently serve as both a computing and conferencing space. Comprised of top and end/brace panels. One cord management grommet in top; cord routing notch in the brace panel. Accepts field installable modesty panels HPC180W or HPC180G (see below). 48"D unit can be used with the 48"D extended corner components to form a "U" station. ⚠ Not designed to be used freestanding.	HPC130R E♦A D	168	9.1	\$1288
		HPC131R E♦A D	129	8.0	\$1175
 <p>Right-hand model HPC130R shown</p> <p>Support column sold separately</p>	Jetty Peninsula w/End Panel 72"W x 48/30"D x 29"H, Left 72"W x 42/30"D x 29"H, Left NOTES: For use in "U" or "L" shaped layout. Designed and sized to efficiently serve as both a computing and conferencing space. Comprised of top and end/brace panels. One cord management grommet in top; cord routing notch in the brace panel. Accepts field installable modesty panels HPC180W or HPC180G (see below). 48"D unit can be used with the 48"D extended corner components to form a "U" station. ⚠ Not designed to be used freestanding.	HPC130L E♦A D	168	9.1	\$1288
		HPC131L E♦A D	129	8.0	\$1175
 <p>Right-hand model HPC140R shown</p> <p>Support column sold separately</p>	Boomerang Peninsula w/End Panel 72"W x 30/42"D x 29"H, Right (shown) 72"W x 42/30"D x 29"H, Left NOTES: For use in "U" or "L" shaped layout. Designed and sized to efficiently serve as both a computing and conferencing space. Comprised of top and end/brace panels. One cord management grommet in top; cord routing notch in the brace panel. Accepts field installable modesty panels HPC180W or HPC180G (see below). ⚠ Not designed to be used freestanding.	HPC140R E♦A D	125	8.0	\$1175
		HPC140L E♦A D	125	8.0	\$1175
 <p>SIN 711-8</p>	Support Column for Bullet, Jetty and Boomerang Peninsulas 4 1/2" Diameter. Specify: HPC190X.P. Black only. Support Column for Bullet, Jetty and Boomerang Peninsulas 4 1/2" Diameter. Specify: HPC191X.X. Available in Silver only. ⚠ Support Column must be specified/ordered with Bullet, Jetty and Boomerang peninsulas.	HPC190X	12 S	1.0	\$ 144
		HPC191X	12 S	1.0	\$ 144
	Field Installable Modesty Panel for Bullet, Jetty and Boomerang Peninsulas, Laminate (vertical grain) 50 1/4"W x 3/4"Thick x 18"H NOTES: Center drawer model H1522 can be used in conjunction with laminate modesty panel model HPC180W. Cord pass-through notch in top corner. SPECIFYING EXAMPLE: HPC180W.H	HPC180W	28 S	3.6	\$ 194
		HPC180G	33 S	1.5	\$ 629
	Field Installable Modesty Panel for Bullet, Jetty and Boomerang Peninsulas, Frosted with Silver Frame 50 1/4"W x 3/4"Thick x 18"H NOTES: Cord pass-through notch available on model HPC180W only. Frosted/silver modesty panel HPC180G can be used with Valido, 10700 and 10500 Series™ peninsula models. Cord pass-through notch is not available on the Frosted/Silver model HPC180G. Notch is on laminate model HPC180W only. ⚠ Center drawers not designed to be used with the frosted/silver modesty panel model HPC180G.	HPC180G	33 S	1.5	\$ 629

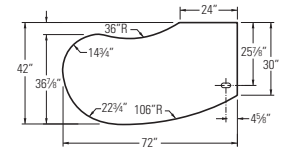
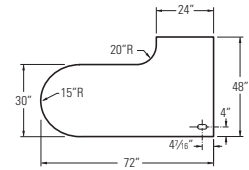

NOTE: See pages 133 through 140 for shared components.

How to specify	Select Model Number from above H P C 1 0 0 X .	1st Option Select Edge Profile See page 127 B .	2nd Option Select Laminate See pages 48-49 H H 	
How to specify	Select Model Number from above H P C 1 3 0 R .	1st Option Select Edge Profile See page 127 B .	2nd Option Select Grommet Finish (no upcharge) A Black B Brushed Brass C Satin Nickel A .	3rd Option Select Laminate See pages 48-49 H H

- ▶ Shared components shown on this page can be used with modular components shown on pages 141-148.
- ▶ Formal, full-height modesty panels feature vertical woodgrain direction.
- ▶ Cord management grommets for routing and hiding wires and cables.
- ▶ See stack-on and wall mounted storage options on pages 135-136.
- ▶ Mobile pedestals shown on page 137 work well in a variety of configurations.

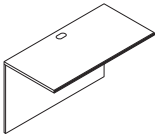

Description	Model	Ship		
		Weight	Cube	List
 <p>Bridge (Single Ped. Desk, or Peninsula (Bullet, Boomerang, Jetty) to Corner Unit, Single Ped. Credenza or Modular Credenza) 48"W x 24"D x 29"H, (Clear inside depth = 22⁷/₈"D) 42"W x 24"D x 29"H, (Clear inside depth = 22⁷/₈"D)</p>	HPC402X E♦A D	78	4.1	\$ 485
	HPC403X E♦A D	70	3.6	\$ 462
<p>Bridge (for use with Corner or Extended Corner Units and Boomerang and Jetty Peninsulas) 36"W x 24"D x 29"H, (Clear inside depth = 22⁷/₈"D)</p>	HPC404X E♦A D	66 S	3.2	\$ 453
<p>Bridge (for use with Corner or Extended Corner Units and Jetty Peninsulas) 30"W x 24"D x 29"H, (Clear inside depth = 22⁷/₈"D)</p>	HPC405X E♦A D	58	2.8	\$ 453
<p>NOTES: Bridges are for "U" station layouts. Cord management grommet in top and back. Kneespace of desk is limited to 26¹/₄" if bridge is used with 66"W single pedestal desk. For full access to wall electrical outlets, the bridge top can be used without the modesty panel component. Grain direction on top runs front-to-back.</p>				

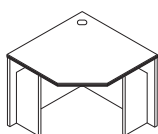

<p>Corner Unit 24" x 36" x 36" x 24" x 29"H</p>	HPC153X D	138	26.7	\$ 920
<p>NOTES: Can be used freestanding. One cord management grommet in top; cord routing notches in the leg panels. Can be used to achieve a 6' x 6' footprint when connected to two 36"W modular returns. Accepts stack-on storage model HPC507W/HPC507K/HPC507G.</p> <p>▲ Intended for use with 24"D x 29"H returns or bridges.</p>				

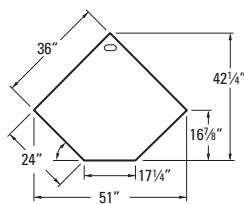

NOTE: See pages 133 through 140 for shared components.

How to specify	1st Option	2nd Option	3rd Option
<p>Select Model Number from above</p> <p>H P C 4 0 2 X .</p>	<p>Select Edge Profile</p> <p>See page 127</p> <p>B .</p>	<p>Select Grommet Finish</p> <p>See page 127</p> <p>A .</p>	<p>Select Laminate</p> <p>See pages 48-49</p> <p>H H </p>

▶ Shared components shown on this page can be used with full pedestal models shown on pages 131-132 and modular components shown on pages 141-148.
▶ For Task Light models see page 148.

▶ Stack-ons provide convenient off-the-worksurface storage without consuming valuable floor space.
▶ Stack-on storage units have an enclosed back. Back features cutouts to facilitate routing cords and reaching wall electrical outlets.

▶ Stack-on storage models are equipped with self-closing, adjustable hinged doors and valance to hide task light.
▶ Available with laminate doors or frosted doors with silver frame.
▶ Stack-on storage units ship fully assembled.

▶ Vertical paper manager (HLVPM1) is available as an option. See page 139.
▶ Tackboard is sized 3/4" narrower than back panel of stack-on storage unit, allowing 3/8" on each side to route task light cord.

⚠ **Frosted door units do not have a lock option.**
⚠ **Removable lock core kit for stack-on and wall mount storage is model HF27B, see page 743.**



	Description	Model	COM	Ship Weight	Cube	List
	Stack-on Storage for an "L" Shaped Workstation 78"W x 14 3/4"D x 37 1/8"H, Laminate Doors, Enclosed Back	HPC500W D		218	33.0	\$1652
	Stack-on Storage for an "L" Shaped Workstation, Locking 78"W x 14 3/4"D x 37 1/8"H, Laminate Doors, Locking, Enclosed Back	HPC500K D		218	33.0	\$1732
	Stack-on Storage for an "L" Shaped Workstation 78"W x 14 3/4"D x 37 1/8"H, Frosted Doors w/Silver Frame, Enclosed Back	HPC500G D		218	33.0	\$2252
	NOTES: Spans the total depth dimension of configurations comprised of: 48"W return or modular return attached to a 36"D single pedestal desk with a bow front (78"D). 36"D single pedestal desk with bow front is 30"D along end panel; 48"W return or modular return attached to a 30"D single pedestal desk or peninsula (78"D); 48"W return or modular return attached to a boomerang peninsula (78"D). Boomerang is 30"D along end panel; 42"W return or modular return attached to a 36"D single pedestal desk, or bullet peninsula (78"D); 42"W return or modular return attached to a 36"D extended corner unit (78"D); 42"W return or modular return attached to a 36"W corner unit (78"D); or 36"W modular return attached to a 42"D jetty peninsula (78"D). Also for use with 78 3/8"W modular credenza top (HPM630X). Use Tackboard model H90057 (see below). Use Task Light models HH870960 or HH870960CH (see page 148). For vertical paper manager (HLVPM1) see page 139.					
	Stack-on Storage, Laminate Doors, Enclosed Back (See below for Fabric Tackboards)					
	72"W x 14 3/4"D x 37 1/8"H, (Use Task Light model HH870960)	HPC501W D		219	30.6	\$1494
	66"W x 14 3/4"D x 37 1/8"H, (Use Task Light model HH870960)	HPC502W D		207	28.1	\$1416
	60"W x 14 3/4"D x 37 1/8"H, (Use Task Light model HH870960)	HPC503W D		194	25.7	\$1386
	48"W x 14 3/4"D x 37 1/8"H, (Use Task Light model HH870942)	HPC505W D		165	20.7	\$1180
	42"W x 14 3/4"D x 37 1/8"H, (Use Task Light model HH870942)	HPC506W D		157	18.3	\$1051
	36"W x 14 3/4"D x 37 1/8"H, (Use Task Light model HH870930)	HPC507W D		121	15.8	\$1004
	Stack-on Storage, Laminate Doors, Locking, Enclosed Back (See below for Fabric Tackboards)					
	72"W x 14 3/4"D x 37 1/8"H, (Use Task Light model HH870960)	HPC501K D		219	30.6	\$1574
66"W x 14 3/4"D x 37 1/8"H, (Use Task Light model HH870960)	HPC502K D		207	28.1	\$1496	
60"W x 14 3/4"D x 37 1/8"H, (Use Task Light model HH870960)	HPC503K D		194	25.7	\$1466	
48"W x 14 3/4"D x 37 1/8"H, (Use Task Light model HH870942)	HPC505K D		165	20.7	\$1220	
42"W x 14 3/4"D x 37 1/8"H, (Use Task Light model HH870942)	HPC506K D		157	18.3	\$1091	
36"W x 14 3/4"D x 37 1/8"H, (Use Task Light model HH870930)	HPC507K D		121	15.8	\$1044	
	Stack-on Storage, Frosted Doors w/Silver Frame, Enclosed Back (See below for Fabric Tackboards)					
	72"W x 14 3/4"D x 37 1/8"H, (Use Task Light model HH870960)	HPC501G D		219	30.6	\$2094
	66"W x 14 3/4"D x 37 1/8"H, (Use Task Light model HH870960)	HPC502G D		207	28.1	\$2016
	60"W x 14 3/4"D x 37 1/8"H, (Use Task Light model HH870960)	HPC503G D		194	25.7	\$1986
	48"W x 14 3/4"D x 37 1/8"H, (Use Task Light model HH870942)	HPC505G D		165	20.7	\$1630
	42"W x 14 3/4"D x 37 1/8"H, (Use Task Light model HH870942)	HPC506G D		157	18.3	\$1351
	36"W x 14 3/4"D x 37 1/8"H, (Use Task Light model HH870930)	HPC507G D		121	15.8	\$1304
NOTES: Model HPC501W or HPC501G can be used for "L" shaped workstation comprised of 30"D desk or peninsula with a 42"W return or modular return (72"D) or a 36"D desk or peninsula with a 36"W modular return (72"D).						
	Tackboards for use with Stack-on Storage					
	75"W - for 78"W model HPC500W, HPC500K or HPC500G	H90057	3	13	3.2	\$ 289
	68 3/4"W - for 72"W model HPC501W, HPC501K or HPC501G	H90056	2	12	2.7	\$ 276
	62 3/4"W - for 66"W model HPC502W, HPC502K or HPC502G	H90055	2	11	2.5	\$ 261
	56 3/4"W - for 60"W model HPC503W, HPC503K or HPC503G	H90054	2	10	2.2	\$ 230
	44 3/4"W - for 48"W model HPC505W, HPC505K or HPC505G	H90053	2	8	1.8	\$ 220
	39"W - for 42"W model HPC506W, HPC506K or HPC506G	H90052	2	7	1.6	\$ 202
	33"W - for 36"W model HPC507W, HPC507K or HPC507G	H90051	1	6	1.4	\$ 179

NOTES: Specify fabric, see pages 310-311. Upcharges may apply to premium fabric grades.

SPECIFYING EXAMPLE: H90057.APN15

NOTE: See pages 133 through 140 for shared components.

How to specify	1st Option	2nd Option
Select Model Number from above	Select Edge Profile	Select Laminate
H P C 5 0 0 W .	See page 127 B .	See pages 48-49 H H

AB, Level, Icon Legend on page 10, D Discontinued 7/1/2017.

- ▶ Wall mounted storage cabinet attachment requires individual cabinets be secured by a minimum of two wall mounting locations/studs.
- ▶ Wall attachment methodology: horizontally mounted, interlocking brackets.
- ▶ Wall mounted storage cabinet door design overlaps end panels so that when multiple units are placed side-by-side they appear as one continuous unit.
- ▶ Wall mounted storage cabinets are designed for interior and perimeter walls that are constructed with wood or metal studs.
- ▶ Available with laminate doors or frosted doors with silver frame.
- ▶ End cap bookshelf is ideal for books, photos and mementos.
- ▶ Vertical paper manager (HLVPM1) is available as an option. See page 139.
- ⚠ **Frosted door units do not have a lock option.**
- ⚠ **The HON Company is not responsible for any liabilities resulting from wall mounted storage cabinets that are not properly installed.**
- ⚠ **Removable lock core kit for stack-on and wall mount storage is model HF27B, see page 743.**



	Description	Model	Ship		
			Weight	Cube	List
	Wall Mounted Storage Cabinet, Laminate Doors				
	48"W x 14 ³ / ₄ "D x 17 ³ / ₈ "H, 3 doors (Use task light model HH870942, see page 148)	HPC522W D	114	12.9	\$1014
	42"W x 14 ³ / ₄ "D x 17 ³ / ₈ "H, 2 doors (Use task light model HH870942, see page 148)	HPC523W D	97	11.4	\$ 940
	36"W x 14 ³ / ₄ "D x 17 ³ / ₈ "H, 2 doors (Use task light model HH870930, see page 148)	HPC524W D	87	9.9	\$ 862
	30"W x 14 ³ / ₄ "D x 17 ³ / ₈ "H, 2 doors (Use task light model HH870930, see page 148)	HPC525W D	73	8.5	\$ 822
	Wall Mounted Storage Cabinet, Laminate Doors, Locking				
	48"W x 14 ³ / ₄ "D x 17 ³ / ₈ "H, 3 doors (Use task light model HH870942, see page 148)	HPC522K D	114	12.9	\$1054
	42"W x 14 ³ / ₄ "D x 17 ³ / ₈ "H, 2 doors (Use task light model HH870942, see page 148)	HPC523K D	97	11.4	\$ 980
	36"W x 14 ³ / ₄ "D x 17 ³ / ₈ "H, 2 doors (Use task light model HH870930, see page 148)	HPC524K D	87	9.9	\$ 902
	30"W x 14 ³ / ₄ "D x 17 ³ / ₈ "H, 2 doors (Use task light model HH870930, see page 148)	HPC525K D	73	8.5	\$ 862
NOTES: Tackboard widths differ slightly from wall mounted storage cabinet widths. For applications where multiple wall mounted storage cabinets are placed side-by-side, the preferred tackboard solution may be to utilize a larger tackboard size. For example, H90057 = 75"W; H90056 = 68 ³ / ₄ "W; H90055 = 62 ³ / ₄ "W; H90054 = 56 ³ / ₄ "W. See pages 135 and 148 for available tackboard sizes.					
	Wall Mounted Storage Cabinet, Frosted Doors w/Silver Frame				
	48"W x 14 ³ / ₄ "D x 17 ³ / ₈ "H, 3 doors (Use task light model HH870942, see page 148)	HPC522G D	114	12.9	\$1464
	42"W x 14 ³ / ₄ "D x 17 ³ / ₈ "H, 2 doors (Use task light model HH870942, see page 148)	HPC523G D	97	11.4	\$1240
	36"W x 14 ³ / ₄ "D x 17 ³ / ₈ "H, 2 doors (Use task light model HH870930, see page 148)	HPC524G D	87	9.9	\$1162
	30"W x 14 ³ / ₄ "D x 17 ³ / ₈ "H, 2 doors (Use task light model HH870930, see page 148)	HPC525G D	73	8.5	\$1122

⚠ **Frosted door units do not have a lock option.**

NOTE: See pages 133 through 140 for shared components.



How to specify	1st Option	2nd Option
Select Model Number from above	Select Edge Profile	Select Laminate
See page 127	See page 127	See pages 48-49
H P C 5 2 2 W .	B .	H H

Icon Legend on page 10 **D** Discontinued 7/1/2017.

- ▶ Versatile mobile pedestals work well in a variety of configurations. Profiled front edge only with a square, non-profiled edge on sides and back.
- ▶ Drawers operate on steel ball-bearing suspensions to ensure smooth, quiet, long-lasting operation.
- ▶ Drawer fronts have vertical woodgrain and are matched in sets to assure continuous grain pattern.
- ▶ Hangrails are provided in all file drawers for side-to-side letter and legal filing; and front-to-back for letter filing.
- ▶ Media drawer can be used to store CD's or conventional supplies.
- ▶ Storage cabinet with doors supports flat screen television displays; cord pass-through grommet in back panel allows placement of DVD/VCR inside cabinet.
- ▶ Adjustable hex leveling glides allow floor-standing furniture to be easily leveled; glides have 3/4" adjustable range.
- ▶ Locking units equipped with interchangeable core removable locks unless otherwise noted. Allows multiple units to be keyed alike and makes re-keying quick and easy.
- ▶ Bookcase hutches have one fixed and two adjustable shelves which adjust in 1/4" increments.
- ▶ Conference tables shown on page 149.

⚠ **Keyed alike cores must be ordered separately — see model HF23B on page 743 — makes re-keying quick and easy.**

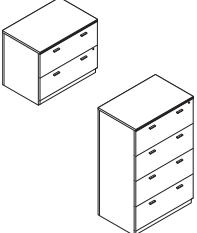
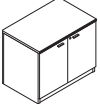
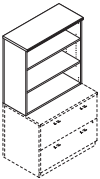
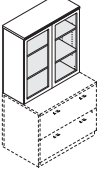

	Description	Model	Ship Weight	Cube	List
	Mobile Pedestal (with core removable lock) — file/file 15 3/4"W x 22 3/4"D x 27 1/2"H NOTES: File drawers include hangrails. ⚠ Profiled front edge only, non-profiled edges on back and sides.	HPC614X D	81	8.4	\$1009
	Mobile Pedestal (with core removable lock)—pencil/media/file 15 3/4"W x 22 3/4"D x 27 1/2"H NOTES: Top drawer includes a pencil tray and middle drawer features a removable media organizer with legs that can also be used on desktops or stack-on storage. Bottom file drawer includes hangrails to accept hanging folders in letter or legal size. ⚠ Profiled front edge only, non-profiled edges on back and sides.	HPC613X D	116	8.4	\$1057
	Lateral File (with core removable lock) 36"W x 24"D x 29"H — two drawer 36"W x 24"D x 59 1/2"H — four drawer NOTES: Include hangrails, mechanical interlock and, a counterweight. Stack-on storage (HPC507W or HPC507G) and bookcase hutch (HPC690X and HPC690G) can be used with HPC634X. 24"D size aligns evenly with 24"D credenzas, returns, and modular components to provide linear layout continuity.	HPC634X D HPC630X D	199 342	19.7 36.1	\$1322 \$2527
	Storage Cabinet with Doors (lock is not core removable) 36"W x 24"D x 29"H NOTES: Versatile design supports flat screen television displays; cord pass-through grommet in back panel allows placement of DVD/VCR inside cabinet. Includes one adjustable shelf. Shelf adjusts in 1/4" increments with a total range of 6 1/4"H. Stack-on storage (HPC507W or HPC507G) and bookcase hutch (HPC690X and HPC690G) can be used with HPC700X. 24"D size aligns evenly with 24"D credenzas, returns, and modular components to provide linear layout continuity.	HPC700X D	180	19.0	\$1053
	Bookcase Hutch — Open 36"W x 14 3/4"D x 37 1/8"H	HPC690X D	110	15.3	\$ 781
	Bookcase Hutch with Frosted Doors w/Silver Frame 36"W x 14 3/4"D x 37 1/8"H NOTES: For use with lateral file model HPC634X or storage cabinet with doors model HPC700X. Also for use on 36"D desks, bullet peninsula, or extended corner unit. Two adjustable shelves; bottom shelf is fixed. Includes a cord pass-through gap behind shelves and a cord management grommet in the back panel to facilitate routing wires and cables and reaching wall electrical outlets. Total height when placed on 29"H base unit is 66 1/8". Doors are equipped with a push/touch latch release and self-closing, adjustable hinges. Specify edge and laminate only. ⚠ Frosted door model is non-locking.	HPC690G D	138	18.4	\$1481

NOTE: See pages 133 through 140 for shared components.

How to specify	1st Option	2nd Option	3rd Option
Select Model Number from above H P C 6 1 4 X . H P C 6 9 0 X .	Select Edge Profile See page 127 B . B .	Select Handle Option See page 127 A .	Select Laminate See pages 48-49 H H H H

▶ Drawer/door handles are available in three styles and three finishes (see page 127).

▶ Drawers operate on steel ball-bearing suspensions to ensure smooth, quiet, long-lasting operation.

▶ Adjustable hex leveling glides allow floor-standing furniture to be easily leveled; glides have 3/4" adjustable range.

▶ Storage cabinet with lateral file is available with laminate doors or frosted doors with silver frame.

▶ Locking units equipped with interchangeable core removable locks. Allows multiple units to be keyed alike and makes re-keying quick and easy.

⚠ **Keyed alike cores must be ordered separately — see model HF23B on page 743 — makes re-keying quick and easy.**

⚠ **Frosted doors do not lock.**

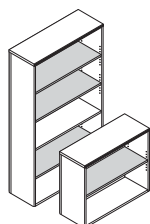

Shaded shelves are adjustable.

Description

Bookcase

36"W x 13 1/8"D x 29"H, 2-Shelf

NOTES: 1 shelf is adjustable in 1/4" increments. Inside shelf dimensions on all units is 34 3/8"W x 12 1/4"D. No assembly required.

36"W x 13 1/8"D x 66 1/8"H, 5-Shelf

NOTES: 3 shelves are adjustable in 1/4" increments. Inside shelf dimensions on all units is 34 3/8"W x 12 1/4"D. No assembly required.

Model

Ship Weight

Cube

List

HPC670X D

85

10.4

\$ 645

HPC673X D

179

24.0

\$1047



Right-hand model HPC710R shown

Storage/File Cabinet with Laminate Door (with core removable lock — storage cabinet and file drawers)

18"W x 24"D x 66 1/8"H, Hinged Right (shown)

18"W x 24"D x 66 1/8"H, Hinged Left

NOTES: Storage/file cabinet is standard with one fixed and two adjustable shelves and two locking file drawers. Shelves adjust in 2 1/2" increments. Laminate door locks.

HPC710R D

229

20.2

\$1977

HPC710L D

229

20.2

\$1977

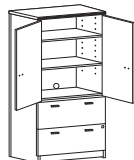

Doors open 120 degrees from closed position.

Storage Cabinet/Lateral File with Laminate Doors (with core removable locks — storage cabinet and lateral file drawers)

36"W x 24"D x 66 1/8"H

NOTES: Standard with one fixed and two full-width adjustable shelves in top compartment; adjustable shelves can be removed. Overall storage compartment measures 31 1/4"W x 22"D x 36 1/8"H and will accommodate supplies, books and binders, as well as business machines and electronic equipment. Cord pass-through gap behind shelves and grommet in back of cabinet to facilitate routing cords and reaching wall electrical outlets. Laminate doors lock. Locking two drawer lateral file on bottom. Lateral file comes with mechanical interlock and hangrails. Unit height is designed to match credenza or return plus stack-on storage height.

HPC720W D

313

39.7

\$2590



Doors open 120 degrees from closed position.

Storage Cabinet/Lateral File with Frosted Doors w/Silver Frame (with core removable lock — lateral file only)

36"W x 24"D x 66 1/8"H

NOTES: Standard with one fixed and two full-width adjustable shelves in top compartment; adjustable shelves can be removed. Overall storage compartment measures 31 1/4"W x 22"D x 36 1/8"H and will accommodate supplies, books and binders, as well as business machines and electronic equipment. Cord pass-through gap behind shelves and grommet in back of cabinet to facilitate routing cords and reaching wall electrical outlets. Laminate doors lock. Locking two drawer lateral file on bottom. Lateral file comes with mechanical interlock and hangrails. Unit height is designed to match credenza or return plus stack-on storage height.

HPC720G D

323

43.6

\$3290

⚠ **Frosted doors do not lock.**

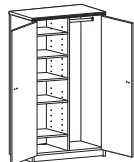

Wardrobe/Storage Cabinet with Laminate Doors (with core removable lock)

36"W x 24"D x 66 1/8"H

NOTES: Spacious design is standard with four adjustable shelves and one fixed shelf, plus generous personal wardrobe section with a coat rod. Shelves adjust in 2 1/2" increments. One lock secures both doors. Unit height is designed to match credenza or return plus stack-on storage height.

HPC740W D

313

39.7

\$2519

NOTE: See pages 133 through 140 for shared components.

How to specify	1st Option	2nd Option	3rd Option
Select Model Number from above	Select Edge Profile See page 127	Select Handle Option See page 127 Not specified for models HPC670X and HPC673X	Select Laminate See pages 48-49
H P C 6 7 0 X .	B .	A .	H H
H P C 7 1 0 R .	B .		H H



Icon Legend on page 10

D Discontinued 7/1/2017.

► Model HPC541X can be used on a 72"W x 36"D double or single pedestal desk with a rectangle top.

► Model HPC533X is comprised of a transaction counter for desk and privacy panel for the desk/return.

► Transaction counter organizer, model HTCOL52, is available as an option on both HPC541X and HPC533X. Fits under transaction counter.

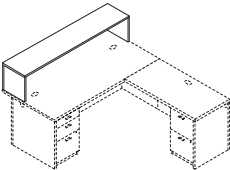
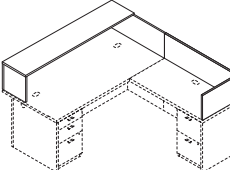
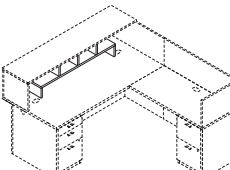
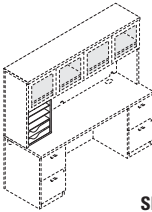
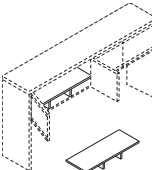

	Description	Model	Ship Weight	Cube	List
	Reception Station with Transaction Counter 72"W x 13 ¹ / ₈ "D x 14 ⁵ / ₈ "H, for 72"W x 36"D for double or single pedestal desk with rectangle top	HPC541X E♦A D	87	4.4	\$ 680
	Reception Station for an "L" Workstation 72"W x 84"D x 14 ⁵ / ₈ "H For workstation comprised of a 72"W x 36"D single pedestal desk with rectangle top and 48"W x 24"D return. Non-handed.	HPC553X E♦A D	108	5.2	\$ 985
	Transaction Counter Organizer 48 ³ / ₄ "W x 11 ¹ / ₈ "D x 13"H NOTES: Fits under transaction counter model HPC541X and HPC533X. ▲ Black only. SPECIFYING EXAMPLE: HTCOL52.P	HTCOL52 E♦A	24	1.1	\$ 252
	Vertical Paper Manager 14 ⁷ / ₈ "W x 10 ⁷ / ₈ "D x 19 ¹ / ₁₆ "H NOTES: Keeps papers, files, and books neatly organized and within easy reach from a seated position. Designed for desk, credenza, and return tops. Fits under stack-on storage models. Two pullout drawers and three fixed shelves. When used in conjunction with wall mounted storage cabinets, the top of the wall mounted storage cabinets must be positioned a minimum of 66 ¹ / ₄ " above the floor. SPECIFYING EXAMPLE: HLVPM1.H	HLVPM1	27	2.8	\$ 298
	Stacked Paper Management 32 ¹ / ₂ "W x 12 ⁵ / ₈ "D x 4 ¹ / ₄ "H NOTES: Segments and organizes stack-on and wall mount storage compartments, as well as bookcase shelves. Unit can be used in Models HPC500W/G, HPC501W/G, HPC506W/G, HPC507W/G, HPC523W/G, HPC524W/G and HPC690X/G. In some cases, installation may require removing the stack-on or wall mount storage doors. ▲ Black only. SPECIFYING EXAMPLE: HLVPM2.P	HLVPM2 E♦A	22	1.25	\$ 144

SIN 711-8

SIN 711-8

NOTE: See pages 133 through 140 for shared components.

How to specify	1st Option	2nd Option
Select Model Number from above	Select Edge Profile See page 127	Select Laminate See pages 48-49
H P C 5 4 1 X .	B .	H H

Icon Legend on page 10 **D** Discontinued 7/1/2017.

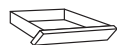

Refer to page 751 for
Center Drawer compatibility
information

SIN 711-1, 711-2, 711-11

Description	Model	Ship		
		Weight	Cube	List
Angled Wood Center Drawer 26" x 15 5/8" 22" x 15 5/8" NOTES: Specify laminate for drawer. SPECIFYING EXAMPLE: H1526.H	H1526	12.0	1.2	\$ 182
	H1522	11.0	1.1	\$ 168

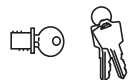

SIN 711-2

Description	Model	Ship		
		Weight	Cube	List
Black Removable Lock Core Kit—see page 743 NOTES: Lock with a removable cylinder that can be interchanged as needed; allows users to access all furniture pieces in an office with a single key for convenience and security. Makes re-keying quick and easy. For HON laminate desks, credenzas, returns, lateral files, storage cabinets, wardrobes, mobile and modular pedestals. ▲ For Stack-on and wall mount storage, use black removable lock core kit HF27B, see page 743.	HF23B	0.1	0.1	\$ 28

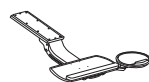

Refer to pages 749-750 for additional
product information

SIN 711-1, 711-2, 711-11

Description	Model	Ship Weight	Cube	List by Paint Grade	
				Core	Choice/Metallics
Articulating Arm with Keyboard Platform Articulating Arm with Convertible Keyboard Platform Sit to Stand Arm with Convertible Keyboard Platform Slide-Away Keyboard Platform (Specify: Laminate) Extended Tray Slide-Away Keyboard Platform (Specify: Laminate) Metal Keyboard and Mouse Tray (Specify paint) Metal Keyboard Tray (Specify paint)	H1706	16	1.4	\$ 440	
	H2107	16	1.3	\$ 472	
	H2516	17	1.6	\$ 551	
	H4022	10	0.6	\$ 194	
	HE4022	12	0.7	\$ 278	
	H4028	11	1.5	\$ 140	\$ 150
H4029	11	1.5	\$ 125	\$ 135	

NOTE: See pages 133 through 140 for shared components.

How to specify	1st Option
Select Model Number from above H 1 5 2 6 .	Select Laminate Does not apply to all products. See above. N



Icon Legend on page 10

- ▶ Modular components enable office layout flexibility and provide a broad menu of storage solutions to choose from.
- ▶ Applications include the ability to build contiguous, personalized behind-the-desk storage and to choose the type of storage for credenzas and returns.
- ▶ Pedestals are non-handed and easy to arrange or re-configure.
- ▶ Under worksurface pedestals can support the end of component surface tops.
- ▶ The depth of pedestals is 3/4" less than the depth of the component tops to accommodate the back/modesty panel.
- ▶ All modular pedestals (except the storage cabinet pedestal) are equipped with interchangeable core removable locks. See page 743.
- ▶ End panels support the end of a component top when there is no modular pedestal.
- ▶ Filing capabilities on modular pedestals: side-to-side letter and legal filing; or front-to-back for letter filing.
- ▶ The depth of end panels are 3/4" less than the depth of the component tops to accommodate the back/modesty panel.

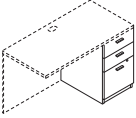
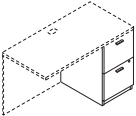
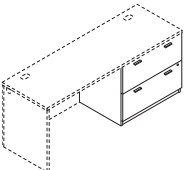
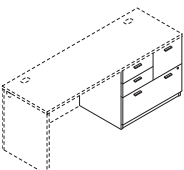
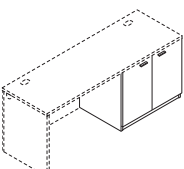

	Description	Model	Ship Weight	Cube	List
	Box/Box/File Pedestal (with core removable lock) 15 ¹ / ₁₆ "W x 22 ³ / ₄ "D x 27 ³ / ₄ "H NOTES: Box drawers hold office supplies. File drawer includes hangrails for side-to-side letter or legal filing; and front-to-back for letter filing. ⚠ Pedestal's top and back are open and require a component top and back panel kit, ordered separately — see pages 142-146.	HPM512X D	82	8.4	\$ 814
	File/File Pedestal (with core removable lock) 15 ¹ / ₁₆ "W x 22 ³ / ₄ "D x 27 ³ / ₄ "H NOTES: File drawers include hangrails for side-to-side letter or legal filing; and front-to-back for letter filing. ⚠ Pedestal's top and back are open and require a component top and back panel kit, ordered separately — see pages 142-146.	HPM514X D	81	8.4	\$ 814
	Lateral File Pedestal (with core removable lock) 31 ³ / ₈ "W x 22 ³ / ₄ "D x 27 ³ / ₄ "H NOTES: Includes hangrails and counterweight; mechanical interlock inhibits more than one drawer from opening at a time. ⚠ Pedestal's top and back are open and require a component top and back panel kit, ordered separately — see pages 142-146.	HPM520X D	121	15.1	\$1179
	Multi File Pedestal (with core removable lock) 31 ³ / ₈ "W x 22 ³ / ₄ "D x 27 ³ / ₄ "H NOTES: Versatile four drawer unit featuring a lateral file, vertical file and two box drawers. File drawers include hangrails. Counterweight standard. Box drawers hold office supplies. Design locates the two box drawers on the left. Box drawers do not lock. ⚠ Pedestal's top and back are open and require a component top and back panel kit, ordered separately — see pages 142-146.	HPM522X D	163	15.1	\$1374
	Storage Cabinet Pedestal 31 ³ / ₈ "W x 22 ³ / ₄ "D x 27 ³ / ₄ "H NOTES: Includes one adjustable shelf. Shelf adjusts in 2 ¹ / ₂ " increments. Non-locking. ⚠ Pedestal's top and back are open and require a component top and back panel kit, ordered separately — see pages 142-146.	HPM524X D	115	15.1	\$ 827

How to specify	1st Option	2nd Option
Select Model Number from above H P M 5 1 2 X .	Select Drawer/Door Handle Option See page 127 A .	Select Laminate See pages 48-49 H H

- ▶ Modular return top components have a shaped edge profile on the user's side (see page 127 for edge options).
- ▶ Component tops are 1/8" thick.
- ▶ Drawer and door fronts, backs/modesty panels and stack-on storage, feature vertical woodgrain.
- ▶ Component backs/modesty panels provide finished back for modular pedestals or an enclosed kneewell.
- ▶ The depth of end panels are 3/4" less than the depth of the component tops to accommodate the modesty panel.
- ▶ Top/back components feature cord management grommets to facilitate routing and hiding wires/cables and reaching wall electrical outlets.
- ▶ For wall mounted storage cabinet options see page 136.
- ⚠ **For customers who wish to specify their storage solutions, see storage pedestal options on page 141. End panel is required if there is not a modular storage pedestal to support the top (see page 146).**
- ⚠ **Modular return top/back components must be used in conjunction with either modular storage pedestal(s) or an end panel component.**



	Description	Model	Ship Weight	Cube	List
	<p>Return Top and Back Panel Components Rectangle Top: 36"W x 24"D; one cord pass-through grommet Back/Modesty Panel: 36"W x 27 3/8"H; one cord pass-through grommet</p> <p>NOTES: Can be used to achieve an efficient 6' x 6' "L" shaped layout when connected to:</p> <ul style="list-style-type: none"> - 36"D single pedestal desk with rectangle top. - 36"D bullet peninsula with support column. - 36"D extended corner modular components with either a 15 1/16"W storage pedestal or a 23"D end panel. - 36" corner unit (requires two 36" return top/back components). <p>Accepts 36"W stack-on storage models HPC507W/HPC507K/HPC507G and bookcase hutch models HPC690X/HPC690G.</p> <p>72"W stack-on storage models HPC501W/HPC501K/HPC501G will work on a 36"W return top/back when attached to a 36"D single pedestal desk with rectangle top, 36"D bullet peninsula with support column, 36"D extended corner modular components with either a 15 1/16"W storage pedestal or a 23"D end panel, or 36" corner unit.</p> <p>66"W stack-on storage models HPC502W/HPC502K/HPC502G will work on a 36"W return top/back when attached to a 30"D single pedestal desk or 30"D bullet peninsula with support column.</p>	HPM709X E↕A D	75	3.2	\$ 444
	<p>Return Top and Back Panel Components Rectangle Top: 42"W x 24"D; one cord pass-through grommet Back/Modesty Panel: 42"W x 27 3/8"H; one cord pass-through grommet</p> <p>NOTES: Accepts 42"W stack-on storage models HPC506W/HPC506K/HPC506G.</p> <p>Can be used to achieve an efficient 6' x 6' "L" shaped layout when connected to:</p> <ul style="list-style-type: none"> - 30"D single pedestal desk. - 30"D bullet peninsula with support column. <p>78"W stack-on storage models HPC500W/HPC500K/HPC500G will work on a 42"W return top/back when attached to a 36"D single pedestal desk with rectangle top, 36"D bullet peninsula with support column, 36"D extended corner modular components with either a 15 1/16"W storage pedestal or a 23"D end panel, or 36" corner unit.</p> <p>72"W stack-on storage models HPC501W/HPC501K/HPC501G will work on a 42"W return top/back when attached to a 30"D single pedestal desk or 30"D bullet peninsula with support column.</p>	HPM708X E↕A D	79	3.6	\$ 494
	<p>Return Top and Back Panel Components Rectangle Top: 48"W x 24"D; one cord pass-through grommet Back/Modesty Panel: 48"W x 27 3/8"H; one cord pass-through grommet</p> <p>NOTES: Accepts 48"W stack-on storage models HPC505W/HPC505K/HPC505G.</p> <p>78"W stack-on storage models HPC500W/HPC500K/HPC500G will work on a 48"W return top/back when attached to a 30"D single pedestal desk or 30"D bullet peninsula with support column.</p>	HPM706X E↕A D	80	4.1	\$ 562

How to specify	1st Option	2nd Option	3rd Option
Select Model Number from above	Select Edge Profile	Select Grommet Finish	Select Laminate
See page 127	See page 127	See page 127	See pages 48-49
H P M 7 0 9 X .	B .	A .	H H

- ▶ Modular return top components have a shaped edge profile on the user's side (see page 127 for edge options).
- ▶ Component tops are 1 1/8" thick.

- ▶ Drawer and door fronts, backs/modesty panels and stack-on storage, feature vertical grain.
- ▶ Component backs/modesty panels provide finished back for modular pedestals or an enclosed kneewell.

- ▶ The depth of end panels are 3/4" less than the depth of the component tops to accommodate the modesty panel.
- ▶ Top/back components feature cord management grommets to facilitate routing and hiding wires/cables and reaching wall electrical outlets.
- ▶ For wall mounted storage cabinet options see page 136.

⚠ For customers who wish to specify their storage solutions, see storage pedestal options on page 141. End panel is required if there is not a modular storage pedestal to support the top (see page 146).

⚠ Modular return top/back components must be used in conjunction with either modular storage pedestal(s) or an end panel component.



	Description	Model	Ship Weight	Cube	List
	Return Top, Back Panel and Support Leg Components Rectangle Top: 60"W x 24"D; two cord pass-through grommets Back/Modesty Panel: 60"W x 27 3/8"H; one cord pass-through grommet Inside dimension: 56 5/8"W NOTES: Accepts 60"W stack-on storage models HPC503W/HPC503K/HPC503G.	HPM704X E♣A D	99	5.0	\$ 699
	Return Top, Back Panel and Support Leg Components Rectangle Top: 66"W x 24"D; two cord pass-through grommets Back/Modesty Panel: 66"W x 27 3/8"H; one cord pass-through grommet Inside dimension: 62 5/8"W NOTES: Accepts 66"W stack-on storage models HPC502W/HPC502K/HPC502G.	HPM702X E♣A D	105	5.9	\$ 755
	Return Top, Back Panel and Support Leg Components Rectangle Top: 72"W x 24"D; two cord pass-through grommets Back/Modesty Panel: 72"W x 27 3/8"H; one cord pass-through grommet Inside dimension: 68 5/8"W NOTES: Accepts 72"W stack-on storage models HPC501W/HPC501K/HPC501G.	HPM701X E♣A D	125	5.9	\$ 777

How to specify	Select Model Number from above H P M 7 0 4 X .	1st Option Select Edge Profile See page 127 B .	2nd Option Select Grommet Finish See page 127 A .	3rd Option Select Laminate See pages 48-49 H H
----------------	---	---	---	--

- ▶ Component tops are 1½" thick.
- ▶ Modular credenza top components have a shaped edge profile on the user's side and the approach side (see page 127 for edge options).
- ▶ Component backs/modesty panels provide finished back for modular pedestals or an enclosed kneewell.
- ▶ The depth of end panels are ¾" less than the depth of the component tops to accommodate the modesty panel.
- ▶ Drawer and door fronts, backs/modesty panels and stack-on storage feature vertical grain.
- ▶ Top/back components feature cord management grommets to facilitate routing and hiding wires/cables and reaching wall electrical outlets.

- ▲ For customers who wish to specify their storage solutions, see storage pedestal options on page 141. End panel(s) required if there is no modular storage pedestal(s) to support the top (see page 146).
- ▲ Modular credenza top/back components must be used in conjunction with either modular storage pedestals or end panel components.

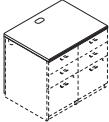
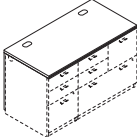
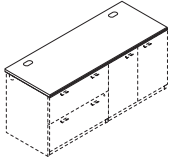
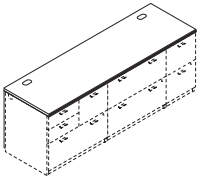

	Description	Model	Ship Weight	Cube	List
	Credenza Top and Back Panel Components Rectangle Top: 31⅜"W x 24"D; one cord pass-through grommet Back/Modesty Panel: 31⅜"W x 27⅞"H; one cord pass-through grommet NOTES: Options include but are not limited to: 2 – 15⅛"W pedestals or 1 – 31⅜"W pedestal Accepts stack-on storage models HPM806W/HPM806K.	HPM640X E♦A D	54 S	2.8	\$ 424
	Credenza Top and Back Panel Components Rectangle Top: 47"W x 24"D; two cord pass-through grommets Back/Modesty Panel: 47"W x 27⅞"H; one cord pass-through grommet NOTES: Options include but are not limited to: 3 – 15⅛"W pedestals or 1 – 31⅜"W pedestal and 1 – 15⅛"W pedestal or 1 – 15⅛"W pedestal with 30¼"W of kneespace (requires one 23"D end panel) Accepts stack-on storage models HPM802W/HPM802K.	HPM637X E♦A D	75	4.1	\$ 573
	Credenza Top and Back Panel Components Rectangle Top: 62¾"W x 24"D; two cord pass-through grommets Back/Modesty Panel: 62¾"W x 27⅞"H; one cord pass-through grommet NOTES: Options include but are not limited to: 4 – 15⅛"W pedestals or 2 – 31⅜"W pedestals or 1 – 31⅜"W pedestal and 2 – 15⅛"W pedestals or 2 – 15⅛"W pedestals with 30¼"W of kneespace (requires one 23"D end panel) or 1 – 31⅜"W pedestal with 30¼"W of kneespace (requires one 23"D end panel) or 1 – 15⅛"W pedestal with 46" of kneespace (requires one 23"D end panel) Accepts stack-on storage models HPM801W/HPM801K.	HPM633X E♦A D	96	5.3	\$ 707
	Credenza Top and Back Panel Components Rectangle Top: 78⅞"W x 24"D; two cord pass-through grommets Back/Modesty Panel: 78⅞"W x 27⅞"H; one cord pass-through grommet NOTES: Options include but are not limited to: 5 – 15⅛"W pedestals or 3 – 15⅛"W pedestals and 1 – 31⅜"W pedestal or 2 – 31⅜"W pedestals and 1 – 15⅛"W pedestal or 2 – 15⅛"W pedestals (positioned side-by-side with end panel opposite) with 45⅞"W of kneespace or 2 – 15⅛"W pedestals (one at each end) with 47" of kneespace or 1 – 15⅛"W pedestal and 2 – 31⅜"W pedestals Accepts stack-on storage models HPC500W/HPC500K/HPC500G.	HPM630X E♦A D	124	6.5	\$ 777

How to specify	1st Option	2nd Option	3rd Option
Select Model Number from above H P M 6 4 0 X .	Select Edge Profile See page 127 B .	Select Grommet Finish See page 127 A .	Select Laminate See pages 48-49 H H

- ▶ Component tops are 1 1/8" thick.
- ▶ Modular credenza top components have a shaped edge profile on the user's side and the approach side (see page 127 for edge options).

- ▶ Component backs/modesty panels provide finished back for modular pedestals or an enclosed kneewell.
- ▶ The depth of end panels are 3/4" less than the depth of the component tops to accommodate the modesty panel.

- ▶ Drawer and door fronts, backs/modesty panels and stack-on storage feature vertical grain.
- ▶ Top/back components feature cord management grommets to facilitate routing and hiding wires/cables and reaching wall electrical outlets.

⚠ For customers who wish to specify their storage solutions, see storage pedestal options on page 141. End panel(s) required if there is no modular storage pedestal(s) to support the top (see page 146).

⚠ Modular credenza top/back components must be used in conjunction with either modular storage pedestals or end panel components.



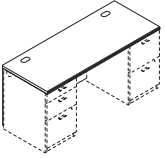
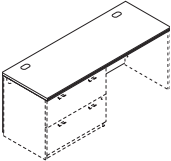
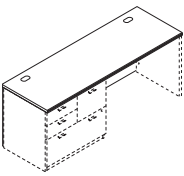

	Description	Model	Ship Weight	Cube	List
	<p>Credenza Top and Back Panel Components Rectangle Top: 60"W x 24"D; two cord pass-through grommets Back/Modesty Panel: 60"W x 27 3/8"H; one cord pass-through grommet NOTES: Accepts stack-on storage models HPC503W/HPC503K/HPC503G.</p>	HPM634X E⚡A D	90	5.0	\$ 652
	<p>Credenza Top and Back Panel Components Rectangle Top: 66"W x 24"D; two cord pass-through grommets Back/Modesty Panel: 66"W x 27 3/8"H; one cord pass-through grommet NOTES: Accepts stack-on storage models HPC502W/HPC502K/HPC502G.</p>	HPM632X E⚡A D	100	5.5	\$ 707
	<p>Credenza Top and Back Panel Components Rectangle Top: 72"W x 24"D; two cord pass-through grommets Back/Modesty Panel: 72"W x 27 3/8"H; one cord pass-through grommet NOTES: Accepts stack-on storage models HPC501W/HPC501K/HPC501G.</p>	HPM631X E⚡A D	109	5.9	\$ 731

How to specify	1st Option	2nd Option	3rd Option
<p>Select Model Number from above H P M 6 3 4 X .</p>	<p>Select Edge Profile See page 127 B .</p>	<p>Select Grommet Finish See page 127 A .</p>	<p>Select Laminate See pages 48-49 H H </p>

- ▶ Component tops are 1½" thick.
- ▶ Extended corner unit components can be used in "L" and "U" shaped layouts.
- ▶ Extended corner unit top components have a shaped edge profile on the user's side only. All other top edges are finished with a flat edge (see page 127 for edge options).
- ▶ Component backs/modesty panels provide finished back for modular pedestals or an enclosed kneewell.
- ▶ End panels support the end of a component top when there is no modular pedestal.
- ▶ See pages 135-136 for stack-on and wall mounted storage models.
- ▶ The depth of end panels are ¾" less than the depth of the component tops to accommodate the modesty panel.
- ▶ Top/back components feature cord management grommets to facilitate routing and hiding wires/cables and reaching wall electrical outlets.

⚠ **Extended corner unit components must be used in conjunction with either a 15½"W modular storage pedestal or a 23"D end panel component to support the 24" dimension. See storage pedestal options page 141.**

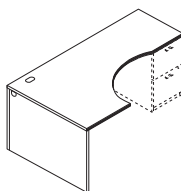
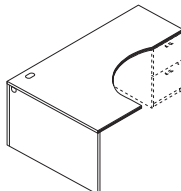
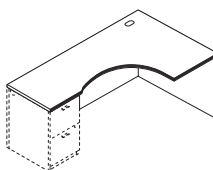
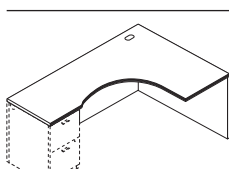
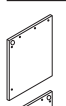

Description	Model	Ship Weight	Cube	List
 <p>Extended Corner Top, Back and End Panel Components, Right Rectangle Top: 24-36" x 72-24" Modesty/Back Panel: 72"W x 27¾"H End Panel measures: 1½"W x 36"D x 27¾"H</p> <p>NOTES: One cord pass-through grommet in top, modesty/back panel and end panel. Optional stack-on maximizes storage space (72"W for width or 36"W for depth). Extended corner unit serves as a "credenza" in "U" station layouts. Can be used to achieve an efficient 6' x 6' "L" shaped layout when attached to 36"W modular return.</p> <p>⚠ Designed to be used with returns or bridges. For end panel applications, use HPM692R with HPM680R or HPM682R.</p>	HPM682R E♦A D	184	6.9	\$ 944
 <p>Extended Corner Top, Back and End Panel Components, Right Rectangle Top: 24-48" x 72-24" Modesty/Back Panel: 72"W x 27¾"H End Panel measures: 1½"W x 47"D x 27¾"H</p> <p>NOTES: One cord pass-through grommet in top, modesty/back panel and end panel. Optional stack-on maximizes storage space (72"W for width or 48"W for depth). 48"D extended corner unit, right, forms a "U" station layout when attached to a 48"D jetty peninsula, left.</p> <p>⚠ Designed to be used with returns or 48"D jetty peninsula. For end panel applications, use HPM692R with HPM680R or HPM682R.</p>	HPM680R E♦A D	240	9.1	\$1131
 <p>Extended Corner Top, Back and End Panel Components, Left Rectangle Top: 24-72" x 36-24" Modesty/Back Panel: 72"W x 27¾"H End Panel measures: 1½"W x 36"D x 27¾"H</p> <p>NOTES: One cord pass-through grommet in top, modesty/back panel and end panel. Optional stack-on maximizes storage space (72"W for width or 36"W for depth). Extended corner unit serves as a "credenza" in "U" station layouts. Can be used to achieve an efficient 6' x 6' "L" shaped layout when attached to 36"W modular return.</p> <p>⚠ Designed to be used with returns or bridges. For end panel applications, use HPM692L with HPM680L or HPM682L.</p>	HPM682L E♦A D	184	6.9	\$ 944
 <p>Extended Corner Top, Back and End Panel Components, Left Rectangle Top: 24-72" x 48-24" Modesty/Back Panel: 72"W x 27¾"H End Panel measures: 1½"W x 47"D x 27¾"H</p> <p>NOTES: One cord pass-through grommet in top, modesty/back panel and end panel. Optional stack-on maximizes storage space (72"W for width or 48"W for depth). 48"D extended corner unit, left, forms a "U" station layout when attached to a 48"D jetty peninsula, right.</p> <p>⚠ Designed to be used with returns or 48"D jetty peninsula. For end panel applications, use HPM692L with HPM680L or HPM682L.</p>	HPM680L E♦A D	240	9.1	\$1131
 <p>End Panel for 24"D Tops, Right 1½"W x 23"D x 27¾"H</p>	HPM692R D	27 S	1.4	\$ 199
 <p>End Panel for 24"D Tops, Left 1½"W x 23"D x 27¾"H</p> <p>NOTES: End Panels are for —</p> <ul style="list-style-type: none"> Single Pedestal Credenza applications utilizing modular storage pedestals. Return applications that do not have a modular storage pedestal to support the top. Extended corner unit applications that do not utilize a 15½"W x 22¾"D modular storage pedestal to support the 24"D dimension. Bottom of end panels are edge banded with durable PVC for added strength. Shell applications involving credenza top and back panel components with both a right and left end panel. 	HPM692L D	27 S	1.4	\$ 199

SPECIFYING EXAMPLE: HPM692R.H

How to specify	1st Option	2nd Option	3rd Option
Select Model Number from above H P M 6 8 2 R .	Select Edge Profile See page 127 B .	Select Grommet Finish See page 127 A .	Select Laminate See pages 48-49 H H

- ▶ Stack-on storage sizes are available for modular credenza and modular return components.
- ▶ Stack-ons provide convenient off-the-worksurface storage without consuming valuable floor space.

- ▶ Stack-on storage units ship fully assembled.
- ▶ Stack-on storage units have an enclosed back. Back features cutouts to facilitate routing cords and reaching wall electrical outlets.
- ▶ Available with laminate doors or frosted doors with silver frame.

- ▶ Stack-on storage models are equipped with self-closing, adjustable hinged doors and a valance to hide task light.
- ▶ Tackboard is sized 3/4" narrower than back panel of stack-on storage unit, allowing 3/8" on each side to route task light cord.

- ▶ For fabric covered tackboards, task lights and tower bookcases, see page 148.
- ▶ Vertical paper manager (HLVPM1) is available as an option. See page 148.

- ⚠ **Frosted doors do not have a lock option.**
- ⚠ **Removable lock core kit for stack-on and wall mount storage only is model HF27B, see page 743.**

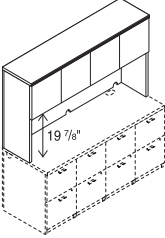
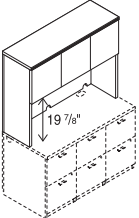
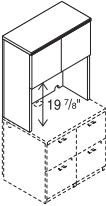
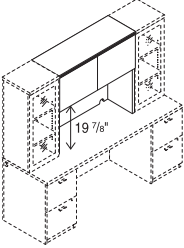

	Description	Model	Ship Weight	Cube	List
	Stack-on Storage, 4 Laminate Doors, Enclosed Back 62 3/4"W x 14 3/4"D x 37 1/8"H	HPM801W D	201	27.0	\$1416
	Stack-on Storage, 4 Laminate Doors, Locking, Enclosed Back 62 3/4"W x 14 3/4"D x 37 1/8"H	HPM801K D	201	27.0	\$1496
NOTES: Applications include use on a 62 3/4"W modular credenza top; or use with a tower bookcase on a 78 3/8"W modular credenza top. Accepts fabric tackboard model H90066 and task light model HH870960.					
	Stack-on Storage with 3 Laminate Doors, Enclosed Back 47"W x 14 3/4"D x 37 1/8"H	HPM802W D	163	20.5	\$1180
	Stack-on Storage with 3 Laminate Doors, Locking, Enclosed Back 47"W x 14 3/4"D x 37 1/8"H	HPM802K D	163	20.5	\$1220
NOTES: Applications include use on a 47"W modular credenza top; or use with a tower bookcase on a 62 3/4"W modular credenza top; or use with two tower bookcases on 78 3/8"W modular credenza top. Accepts fabric tackboard model H90065 and task light model HH870942.					
	Stack-on Storage, 2 Laminate Doors, Enclosed Back 31 3/8"W x 14 3/4"D x 37 1/8"H	HPM806W D	110	14.0	\$ 920
	Stack-on Storage, 2 Laminate Doors, Locking, Enclosed Back 31 3/8"W x 14 3/4"D x 37 1/8"H	HPM806K D	110	14.0	\$ 960
NOTES: Applications include use on a 31 3/8"W modular credenza top; or use with a tower bookcase on a 47"W modular credenza top; or use with two tower bookcases on 62 3/4"W modular credenza top; or use with three tower bookcases on a 78 3/8"W modular credenza top. Accepts fabric tackboard model H90061 and task light model HH870930.					
	Stack-on Storage, 2 Laminate Doors, Enclosed Back — Specifically for use with 2 Tower Bookcase units on a 72"W top 40 1/2"W x 14 3/4"D x 37 1/8"H	HPM804W D	154	17.6	\$1051
	Stack-on Storage, 2 Laminate Doors, Locking, Enclosed Back — Specifically for use with 2 Tower Bookcase units on a 72"W top 40 1/2"W x 14 3/4"D x 37 1/8"H	HPM804K D	154	17.6	\$1091
NOTES: Accepts fabric tackboard model H90063 and task light model HH870942. ⚠ Specifically designed for use with two tower bookcase units on a 72"W top.					

How to specify	1st Option	2nd Option
Select Model Number from above H P M 8 0 1 W . H P M 8 0 1 K .	Select Edge Profile See page 127 B . B .	Select Laminate See pages 48-49 H H H H

- ▶ Tower bookcases include three shelves, one fixed and two adjustable. Shelves adjust in 2½" increments.
- ▶ Tower bookcase design is ideal for books, photographs or mementos.
- ▶ Vertical paper manager fits under stack-on storage models.
- ▶ For conference tables, see page 149.

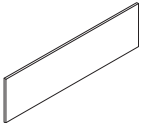

Description	Model	COM	Ship		
			Weight	Cube	List
 <p>Tackboards for use with Stack-on Storage shown on page 147</p> <p>61"W - for 62¾"W models HPM801W/HPM801K</p> <p>45"W - for 47"W models HPM802W/HPM802K</p> <p>38"W - for 40½"W models HPM804W/HPM804K</p> <p>29¼"W - for 31¾"W models HPM806W/HPM806K</p> <p>Specify: Fabric — see pages 310-311. Upcharges may apply to premium fabric grades.</p>	H90066 D	2	11 S	2.1	\$ 261
	H90065 D	2	9 S	1.7	\$ 220
	H90063 D	2	7 S	1.6	\$ 202
	H90061 D	1	6 S	1.2	\$ 179

How to specify	1st Option
Select Model Number from above H 9 0 0 6 6 .	Select Fabric See pages 310-311 A P N 1 5

Description	Model	Ship		
		Weight	Cube	List
 <p>Open Market</p> <p>Recessed Task Lights</p> <ul style="list-style-type: none"> • Color: Black. • Slim profile design. • Mount to stack-on storage and wall mounted storage cabinets (see pages 135-136 and 147). • Electronic ballast for increased energy efficiency. • T5 bulb, included, which contains less mercury. • 9-foot black cord and switch off right rear corner. <p>For 31¾"W Models, 22½"W x 3¹¹⁄₁₆"D x 1¹⁄₈"H Chicago code version (with fused plug)</p> <p>For 40½"W and 47"W Models, 34⁵⁄₈"W x 3¹¹⁄₁₆"D x 1¹⁄₈"H Chicago code version (with fused plug)</p> <p>For 62¾"W Models, 46½"W x 3¹¹⁄₁₆"D x 1¹⁄₈"H Chicago code version (with fused plug)</p> <p>See page 752 for LED Task Lights.</p>	HH870930	7 S	0.6	\$ 205
	HH870930CH	7 S	0.6	\$ 268
	HH870942	10 S	0.9	\$ 222
	HH870942CH	10 S	0.9	\$ 282
	HH870960	12 S	1.1	\$ 240
	HH870960CH	12 S	1.1	\$ 300

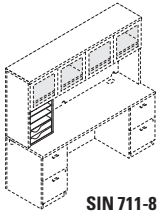

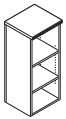

Description	Model	Weight	Cube	List
 <p>Vertical Paper Manager</p> <p>14⁷⁄₈"W x 10⁷⁄₈"D x 19¹¹⁄₁₆"H</p> <p>NOTES: Keeps papers, files, and books neatly organized and within easy reach from a seated position. Designed for desk, credenza, and return tops. Fits under stack-on storage models. Two pullout drawers and three fixed shelves. When used in conjunction with wall mounted storage cabinets, the top of the wall mounted storage cabinets must be positioned a minimum of 66¼" above the floor.</p> <p>Specify: Model.Laminate SPECIFYING EXAMPLE: HLVPM1.H</p> <p>SIN 711-8</p>	HLVPM1	27	2.8	\$ 298

Description	Model	Weight	Cube	List
 <p>Tower Bookcase</p> <p>15¹¹⁄₁₆"W x 14¾"D x 37¹⁄₈"H — Open (no door)</p> <p>NOTES: Three shelves, one fixed, two adjustable. Shelves adjust in 2½" increments. Applications include:</p> <ul style="list-style-type: none"> – Use of two tower bookcases with a 47"W stack-on storage unit on a 78¾"W modular credenza top. – Use of two tower bookcases with a 40½"W stack-on storage unit on a 72"W credenza, modular credenza top, or modular return top. – Use of two tower bookcases with a 31¾"W stack-on storage unit on a 62¾"W modular credenza top. – Use of two tower bookcases on a 31¾"W modular credenza top. 	HPM828X D	58	7.2	\$ 589

How to specify	1st Option	2nd Option
Select Model Number from above H P M 8 2 8 X .	Select Edge Profile See page 127 B .	Select Laminate See pages 48-49 H H

- ▶ Choose from standard or tops with cord/power cutouts.
 - ▶ If the cut-out option is selected, 144"L and 120"L tops have two cutouts each and 96"L, 72"L, 48" round and 42" round have one cut-out, centered in the top. Each cutout carries a \$70 upcharge.
 - ▶ Tops and bases ordered separately and shipped in separate cartons, **E** **◆** **A**.
 - ▶ 120"L and 144"L tops ship in two pieces to facilitate handling and installation; these top sizes in woodgrain colors will not have exact grain alignment in the center where the two halves meet.
 - ▶ 96" and 72"L tops are one piece.
 - ▶ Tops with bases are 29 1/2"H.
 - ▶ Tops are abrasion- and stain-resistant laminate over 1 1/8" thick solid core high-performance particleboard.
 - ▶ Tops are shaped on all sides.
 - ▶ Durable, profiled edges.
 - ▶ Underside of tops are sealed to resist warping.
 - ▶ Two piece tops are secured and supported by steel or wood stretchers, worksurface connectors and flat brackets to facilitate alignment and minimize deflection.
 - ▶ Underside of tops feature alignment guide for base placement.
 - ▶ Pop-up Port, model HTPWRGROM1 and Flip-top Port, model HTPWRGROM2 must be purchased separately.
 - ▶ Flip-top Port option is not available with round tops; Pop-up Port only.
 - ▶ Optional cutouts are available to accommodate power ports. One centered cutout per top section.
- ▲ For table base options, use listings on pages 700-703.

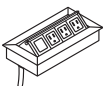
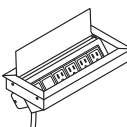

Description	Seating Capacity	Model	Ship Weight	Cube	List
 <p>Rectangular Shaped Laminate Tops 144"L x 48"W (ships in two pieces) 120"L x 48"W (ships in two pieces) 96"L x 48"W 72"L x 36"W</p>	12	HPTC144 E ◆ A D	277	10.8	\$1299
	10	HPTC120 E ◆ A D	230	8.9	\$1165
	8	HPTC096 E ◆ A D	164	14.7	\$ 950
	6	HPTC072 E ◆ A D	93	8.1	\$ 668
 <p>Racetrack Shaped Laminate Tops 144"L x 48"W (ships in two pieces) 120"L x 48"W (ships in two pieces) 96"L x 48"W 72"L x 36"W</p>	12	HPTA144 E ◆ A D	280	10.8	\$1299
	10	HPTA120 E ◆ A D	215	8.9	\$1165
	8	HPTA096 E ◆ A D	146	14.7	\$ 950
	6	HPTA072 E ◆ A D	82	8.1	\$ 668
 <p>Boat Shaped Laminate Tops 144"L x 48"W (ships in two pieces) 120"L x 48"W (ships in two pieces) 96"L x 48"W</p> <p>NOTES: Width of 144"L, 120"L and 96"L top at ends is 36"W.</p> <p>72"L x 36"W</p> <p>NOTES: Width of 72"L top at ends is 27"W.</p>	12	HPTB144 E ◆ A D	255	10.8	\$1299
	10	HPTB120 E ◆ A D	220	8.9	\$1165
	8	HPTB096 E ◆ A D	151	14.7	\$ 950
	6	HPTB072 E ◆ A D	86	8.1	\$ 668
 <p>Round Laminate Tops 48" diameter 42" diameter</p> <p>NOTES: Round Table Tops have only two grommet options: N, No Cutout or G1, Cutout for Pop-up Port. SPECIFYING EXAMPLE: HPTD048.B.N.NN or HPTD048.B.G1.NN</p>	4	HPTD048 E ◆ A D	78 S	7.3	\$ 558
	4	HPTD042 E ◆ A D	52 S	5.7	\$ 508
 <p>Pop-up Port</p> <ul style="list-style-type: none"> • Fits into 4" x 8" cutout. • Specify G1 cutout in table top. • Pop-up Port provides three power ports and one blank data receptacle. • Sits flush with worksurface when closed. • Finish is anodized aluminum. • Includes 6' cord with three-prong plug. 		HTPWRGROM1	5	0.3	\$ 343
 <p>Flip-top Port</p> <ul style="list-style-type: none"> • Fits into 5" x 11" cutout. • Specify G2 cutout in table top. • Flip-top Port provides four power ports and two blank data receptacles. • Conceals wires and allows power cords to be plugged in while in use. • Includes 6' cord with three-prong circuit breaker plug. <p>NOTES: Two circuit breaker plugs do not fit into one duplex.</p>		HTPWRGROM2	5	0.3	\$ 496

NOTE: Use with Preside® bases found on pages 700-703.

How to specify	1st Option	2nd Option	3rd Option
<p>Select Model Number from above</p> <p>H P T C 1 4 4 .</p>	<p>Select Edge Profile</p> <p>See page 127</p> <p>B .</p>	<p>Select Cutout</p> <p>N No Cutout G1 Cutout for Pop-up Port (\$70 upcharge) G2 Cutout for Flip-top Port (\$70 upcharge)</p> <p>(G2 Cutout not available on models HPTD048 or HPTD042)</p> <p>N .</p>	<p>Select Laminate</p> <p>See pages 48-49</p> <p>N N </p>

ABJ ▲ **E◆A** **S** Icon Legend on page 10 **D** Discontinued 7/1/2017.

Valido® — Typicals



Components used are listed on pages 152-171. Order components individually.
Other configurations are possible, including various sizes of some components.

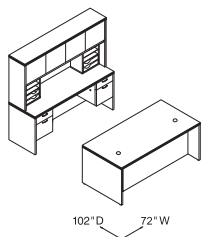

Desk/Credenza
72"W x 102"D

Qty.	Model #	Description	List Price	Price Extension
1	H11593	Double Pedestal Desk - 2/2 72"W x 36"D x 29½"H	\$1,574	\$1,574
1	H11543	Credenza with Kneespace - 2/2 72"W x 24"D x 29½"H	\$1,460	\$1,460
1	H11534	Stack-on Storage 72"W x 14⅝"D x 37½"H	\$1,132	\$1,132
2	HLVPM1	Vertical Paper Manager	\$ 298	\$ 596
TOTAL:			\$4,762	

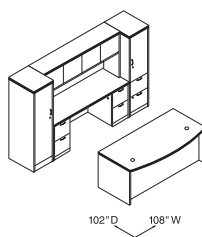

Desk/Credenza
108"W x 102"D

Qty.	Model #	Description	List Price	Price Extension
1	H11595	Double Pedestal Bow Top Desk - 2/2 72"W x 36"D x 29½"H	\$1,719	\$1,719
1	H115900	Credenza with Kneespace - 2/2 72"W x 24"D x 29½"H	\$1,813	\$1,813
1	H11534	Stack-on Storage 72"W x 14⅝"D x 37½"H	\$1,132	\$1,132
1	H115296L	Personal Wardrobe/Storage Cabinet, Left 18"W x 24"D x 67"H	\$1,559	\$1,559
1	H115297R	Storage/File Cabinet, Right 18"W x 24"D x 67"H	\$1,804	\$1,804
TOTAL:			\$8,027	

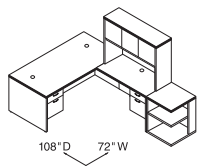

"L" Workstation
72"W x 108"D

Qty.	Model #	Description	List Price	Price Extension
1	H11586L	Single Pedestal Desk, Left - b/f 72"W x 36"D x 29½"H	\$1,338	\$1,338
1	H11515R	Return, Right-b/f 48"W x 24"D x 29½"H	\$ 974	\$ 974
1	H115323	Stack-on Storage 48"W x 14⅝"D x 37½"H	\$ 920	\$ 920
1	H115525R	Square End Cap Bookshelf 24"W x 24"D x 29½"H	\$ 658	\$ 658
TOTAL:			\$3,890	

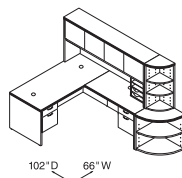

"L" Workstation
66"W x 102"D

Qty.	Model #	Description	List Price	Price Extension
1	H11584L	Single Pedestal Desk, Left - b/f 66"W x 30"D x 29½"H	\$1,251	\$1,251
1	H11515R	Return, Right - b/f 48"W x 24"D x 29½"H	\$ 974	\$ 974
1	H115327	Stack-on Storage 78"W x 14⅝"D x 37½"H	\$1,261	\$1,261
1	HLVPM1	Vertical Paper Manager	\$ 298	\$ 298
1	H115520	End Cap Bookshelf 24"W x 24"D x 29½"H	\$ 668	\$ 668
1	H115523	End Cap Bookshelf 15"W x 15"D x 37½"H	\$ 591	\$ 591
TOTAL:			\$5,043	

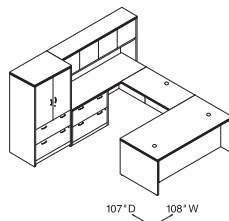

"U" Workstation
108"W x 107"D

Qty.	Model #	Description	List Price	Price Extension
1	H11585R	Single Pedestal Desk, Right - b/f 72"W x 36"D x 29½"H	\$1,338	\$1,338
1	H11570	Bridge 47"W x 24"D x 29½"H	\$ 442	\$ 442
1	H11548L	Credenza with 36" Lateral, Left 72"W x 24"D x 29½"H	\$1,565	\$1,565
1	H11534	Stack-on Storage 72"W x 14⅝"D x 37½"H	\$1,132	\$1,132
1	H115293	Storage Cabinet/Lateral File 36"W x 24"D x 67"H	\$2,339	\$2,339
TOTAL:			\$6,816	

Components used are listed on pages 152-171. Order components individually.
Other configurations are possible, including various sizes of some components.

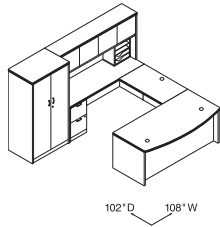

“U” Workstation
108”W x 102”D

Qty.	Model #	Description	List Price	Price Extension
1	H115893R	Single Full Pedestal Bow Front Desk 72”W x 36”D x 29½”H	\$1,877	\$1,877
1	H11560	Bridge 42”W x 24”D x 29½”H	\$ 423	\$ 423
1	H115904L	Left Single Full Pedestal Credenza 72”W x 24”D x 29½”H	\$1,492	\$1,492
1	H11534	Stack-on Storage 72”W x 14½”D x 37½”H	\$1,132	\$1,132
1	HLVPM1	Vertical Paper Manager	\$ 298	\$ 298
1	H11530	Personal Wardrobe/Storage Cabinet 36”W x 24”D x 67”H	\$2,285	\$2,285
TOTAL:			\$7,507	

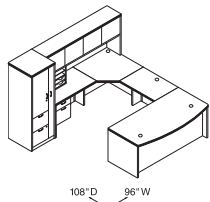

“U” Workstation
102”W x 108”D

Qty.	Model #	Description	List Price	Price Extension
1	H11587R	Single Pedestal Bow Front Desk, Right - b/f 72”W x 36”D x 29½”H	\$1,514	\$1,514
1	H115599	Bridge 36”W x 24”D x 29½”H	\$ 423	\$ 423
1	H115811	36” Corner Unit	\$ 790	\$ 790
1	H11512L	Return, Left 42”W x 24”D x 29½”H	\$ 962	\$ 962
1	H115327	Stack-on Storage 78”W x 14½”D x 37½”H	\$1,261	\$1,261
1	HLVPM1	Vertical Paper Manager	\$ 298	\$ 298
1	H115301R	Personal Storage Tower 24”W x 24”D x 67”H	\$2,285	\$2,285
TOTAL:			\$7,533	

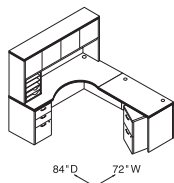

Modular “L” Workstation
72”W x 84”D

Qty.	Model #	Description	List Price	Price Extension
1	H115816L	Extended Corner Unit, Left 24”D x 72”W x 36”D x 24”W x 29½”H	\$1,147	\$1,147
1	H115102	Box/Box/File Mobile Pedestal 15½”W x 22¾”D x 28”H	\$ 826	\$ 826
1	H11534	Stack-on Storage 72”W x 14½”D x 37½”H	\$1,132	\$1,132
1	HLVPM1	Vertical Paper Manager	\$ 298	\$ 298
1	H11561	Return Shell (with Full Modesty Panel) 48”W x 24”D x 29½”H	\$ 603	\$ 603
1	H115104	File/File Mobile Pedestal 15½”W x 22¾”D x 28”H	\$ 826	\$ 826
TOTAL:			\$4,832	

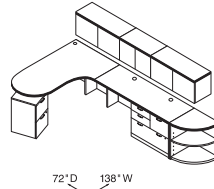

Modular “L” Workstation
138”W x 72”D

Qty.	Model #	Description	List Price	Price Extension
1	H115202L	Jetty Peninsula, Left 72”W x 42”/30”D x 29½”H	\$1,223	\$1,223
1	H115104	File/File Mobile Pedestal 15½”W x 22¾”D x 28”H	\$ 826	\$ 826
1	H115686	Return Shell 72”W x 24”D x 29½”H	\$ 788	\$ 788
1	H11505	Multi File Pedestal 36”W x 20”D x 28”H	\$1,232	\$1,232
2	H115382	Wall Mounted Storage Cabinet 42”W x 14½”D x 18½”H	\$ 866	\$1,732
1	H115380	Wall Mounted Storage Cabinet 30”W x 14½”D x 18½”H	\$ 765	\$ 765
1	H115520	End Cap Bookshelf 24”W x 24”D x 29½”H	\$ 668	\$ 668
TOTAL:			\$7,234	

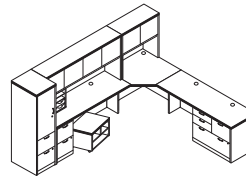

Modular “L” Corner Workstation
126”W x 96”D

Qty.	Model #	Description	List Price	Price Extension
1	H115298L	Storage/File Cabinet, Left 18”W x 24”D x 67”H	\$1,804	\$1,804
1	H115686	Return Shell 72”W x 24”D x 29½”H	\$ 788	\$ 788
1	H11504	File/File Modular Pedestal 15½”W x 22¾”D x 28”H	\$ 673	\$ 673
1	H105679	Mobile Printer/Fax Cart 20”W x 19½”D x 14½”H	\$ 397	\$ 397
1	H11534	Stack-on Storage 72”W x 14½”D x 37½”H	\$1,132	\$1,132
1	HLVPM1	Vertical Paper Manager	\$ 298	\$ 298
1	H115811	36” Corner Unit	\$ 790	\$ 790
1	H115321	Stack-on Storage 36”W x 14½”D x 37½”H	\$ 758	\$ 758
1	H115684	Return Shell 60”W x 24”D x 29½”H	\$ 736	\$ 736
1	H11505	Multi File Pedestal 36”W x 20”D x 28”H	\$1,232	\$1,232
TOTAL:			\$8,608	

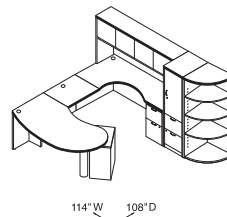

Modular “U” Workstation
114”W x 108”D

Qty.	Model #	Description	List Price	Price Extension
1	H115204L	Boomerang Peninsula, Left 72”W x 42”/30”D x 29½”H	\$1,223	\$1,223
1	H115102	Box/Box/File Mobile Pedestal 15½”W x 22¾”D x 28”H	\$ 826	\$ 826
1	H115598	Bridge 30”W x 24”D x 29½”H	\$ 423	\$ 423
1	H115815R	Extended Corner Unit, Right 24”W x 36”D x 72”W x 24”D x 29½”H	\$1,147	\$1,147
1	H11504	File/File Modular Pedestal 15½”W x 22¾”D x 28”H	\$ 673	\$ 673
1	H11534	Stack-on Storage 72”W x 14½”D x 37½”H	\$1,132	\$1,132
1	H115297R	Storage/File Cabinet, Right 18”W x 24”D x 67”H	\$1,804	\$1,804
1	H115524	End Cap Bookshelf 24”W x 24”D x 67”H	\$1,063	\$1,063
TOTAL:			\$8,291	

Valido® Laminate Modular Desks

GSA SIN 711-2



► Non-handed desk, credenza, and return shells, combined with a variety of under-the-worksurface storage solutions, maximize office layout flexibility. Shells and pedestals can be reconfigured quickly and easily when user preferences or space needs change.

► For storage components see pages 155-156.
 ► Tops are abrasion- and stain-resistant laminate over extra-thick 1½" solid core high-performance particleboard; resists warping.
 ► "Ribbon" edge profile; shape is on all four sides.
 ► Full height modesty panels.

► Cord management grommets, for routing and hiding wires and cables, are located in the tops of desk and return shells.
 ► 3" round worksurface grommet can be replaced with optional Power Hub (model HGRMTAC) to bring the ease of plug-and-play to the desktop. See page 245.
 ► Credenza shells have a cord pass-through grommet in the top center of the modesty panel.

► The narrow design of the kneespace clearance end panel kits replace full end panels to provide added kneespace.
 ► Adjustable hex leveling glides allow floor-standing furniture to be easily leveled; glides have ¾" adjustable range.
 ► For conference table options, see the Preside® table tops and bases on pages 698-703. Order edge option "K".



Edge Option:



Ribbon Edge "A"

Handle Options:



Sweep Designator
 Black
 Satin Nickel

A C



Crescent Designator
 Black
 Satin Nickel

D F

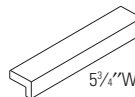

Linear
 Black
 Matte Chrome

G J

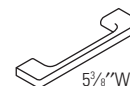

Arch
 Black
 Matte Chrome

K M

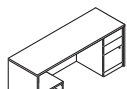

Multiple storage solutions to fit your needs



Storage placement flexibility

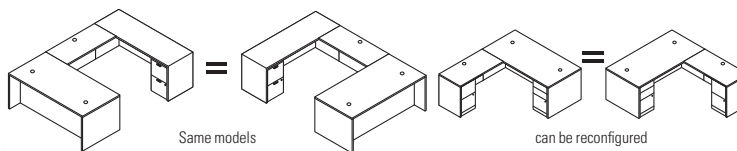

Same models

can be reconfigured

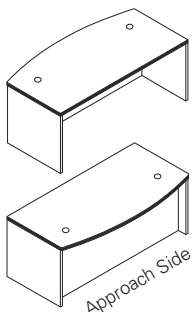

Model H11596 shown

Description	Inside Dimensions	Full Width Overhang	Model	Ship		
				Weight	Cube	List
Desk Shell (with Full Modesty Panel)						
72"W x 36"D x 29½"H, Bow Top (end panels 30"D)	69½"W x 24⅝"D	10½"	H11596 E◆A	218	5.8	\$ 936
72"W x 36"D x 29½"H, Rectangle Top	69½"W x 24⅝"D	10½"	H11594 E◆A	239	5.8	\$ 897
72"W x 30"D x 29½"H, Rectangle Top	69½"W x 24⅝"D	4½"	H11592 E◆A	206	6.6	\$ 836
66"W x 30"D x 29½"H, Rectangle Top	63½"W x 24⅝"D	4½"	H11579 E◆A	194	4.5	\$ 788
60"W x 30"D x 29½"H, Rectangle Top	57½"W x 24⅝"D	4½"	H11578 E◆A	182	4.1	\$ 755
48"W x 30"D x 29½"H, Rectangle Top (1 grommet)	45½"W x 24⅝"D	4½"	H11598 E◆A	154	4.0	\$ 713

NOTES: See page 170 for optional center drawers.

NOTE: See pages 155-156 for modular storage components.

How to specify	1st Option	2nd Option
Select Model Number from above	Select Edge Profile	Select Laminate
See above	See above	See pages 48-49
H 1 1 5 9 6 .	A .	N N

Icon Legend on page 10

- ▶ Non-handed desk, credenza, and return shells, combined with a variety of under-the-worksurface storage solutions, maximize office layout flexibility. Shells and pedestals can be reconfigured quickly and easily when user preferences or space needs change.
- ▶ For storage components see pages 155-156.
- ▶ Tops are abrasion- and stain-resistant laminate over extra-thick 1 1/2" solid core high-performance particleboard; resists warping.
- ▶ "Ribbon" edge profile; shape is on all four sides.
- ▶ Cord management grommets, for routing and hiding wires and cables, are located in the tops of desk and return shells.
- ▶ Credenza shells have a cord pass-through grommet in the top center of the modesty panel.
- ▶ The narrow design of the kneespace clearance end panel kits replace full end panels to provide added kneespace.
- ▶ Adjustable hex leveling glides allow floor-standing furniture to be easily leveled; glides have 3/4" adjustable range.
- ▶ Credenza Shells available with Full or 10" Modesty Panel options.
- ▶ For conference table options, see the Preside® table tops and bases on pages 698-703. Order edge option "K".

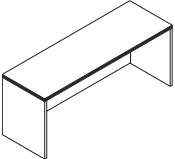
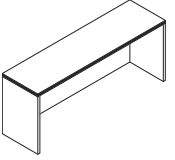
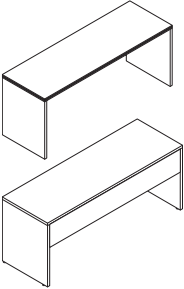

	Description	Inside Dimensions	Model	Ship		
				Weight	Cube	List
 <p>Model H11541 shown</p>	24"D Credenza Shell (with Full Modesty Panel)					
	72"W x 24"D x 29 1/2"H	69 1/2"W x 22 3/4"D	H11541 E ♦A	169	4.5	\$ 788
	66"W x 24"D x 29 1/2"H	63 1/2"W x 22 3/4"D	H11542 E ♦A	159	4.2	\$ 767
	60"W x 24"D x 29 1/2"H	57 1/2"W x 22 3/4"D	H11564 E ♦A	148	3.8	\$ 736
	48"W x 24"D x 29 1/2"H	45 1/2"W x 22 3/4"D	H115692 E ♦A	135	2.8	\$ 693
	42 1/4"W x 24"D x 29 1/2"H	39 3/4"W x 22 3/4"D	H115691 E ♦A	118	3.4	\$ 658
	NOTES: Cord pass-through grommet in top center of modesty panel. See page 163 for optional stack-on storage.					
	20"D Credenza Shell (with Full Modesty Panel)					
	72"W x 20"D x 29 1/2"H	69 1/2"W x 18 3/4"D	H115581	154	5.3	\$ 746
	66"W x 20"D x 29 1/2"H	63 1/2"W x 18 3/4"D	H115582	145	4.8	\$ 724
	60"W x 20"D x 29 1/2"H	57 1/2"W x 18 3/4"D	H115583	135	4.4	\$ 697
	NOTES: Cord pass-through grommet in top center of modesty panel. See page 163 for optional stack-on storage.					
	24"D Credenza Shell (with 10" Modesty Panel)					
	72"W x 24"D x 29 1/2"H	69 1/2"W x 22 3/4"D	H11541X E ♦A	162	5.0	\$ 788
	66"W x 24"D x 29 1/2"H	63 1/2"W x 22 3/4"D	H11542X E ♦A	124	4.0	\$ 767
	60"W x 24"D x 29 1/2"H	57 1/2"W x 22 3/4"D	H11564X E ♦A	120	4.0	\$ 736
	48"W x 24"D x 29 1/2"H	45 1/2"W x 22 3/4"D	H115692X E ♦A	107	4.0	\$ 693
	42 1/4"W x 24"D x 29 1/2"H	39 3/4"W x 22 3/4"D	H115691X E ♦A	98	4.0	\$ 658
	20"D Credenza Shell (with 10" Modesty Panel)					
	72"W x 20"D x 29 1/2"H	69 1/2"W x 18 3/4"D	H115581X	124	4.6	\$ 746
	66"W x 20"D x 29 1/2"H	63 1/2"W x 18 3/4"D	H115582X	117	4.2	\$ 724
	60"W x 20"D x 29 1/2"H	57 1/2"W x 18 3/4"D	H115583X	110	3.8	\$ 697
	NOTES: Makes reaching wall electrical outlets quick and easy. Provides more than 18" of clearance. See page 163 for optional stack-on storage.					

 Not available in two-tone laminate

Kneespace Clearance End Panel Kits (field installable)

1 1/8"W x 11 1/4"D x 28 1/8"H **H105098 E** ♦A 13 0.9 \$ 193
 For use at either end of Valido, 10500 or 10700 Series™ 24"D Credenza Shells (with full or 10" modesty panel) or non-pedestal end of single pedestal credenzas or credenzas with lateral files.

1 1/8"W x 17 1/4"D x 28 1/8"H **H105099 E** ♦A 11 0.8 \$ 202
 For use at either end of Valido, 10500 or 10700 Series™ 30"D Desk Shells or non-pedestal end of 30"D single pedestal desks.

Kits include: (1) support panel; European fastening hardware; flat connector bracket; joint connector bolts with sleeve nuts (for ganging credenza to adjacent worksurface); and adjustable leveling glides. Allows conversion of units currently in the field.

NOTES: Can be used to connect up to three 24"D credenzas or 30"D desks in line (requires 4 kits).
 ⚠ **Not designed to be used freestanding. Not designed to be used with returns, 36"D desks or desk shells.**
SPECIFYING EXAMPLE: H105098.N

NOTE: See pages 155-156 for modular storage components.

How to specify	1st Option	2nd Option
Select Model Number from above	Select Edge Profile	Select Laminate
See page 152	See page 152	See pages 48-49
H 1 1 5 4 1 .	A .	N N

Valido® Modular Returns

GSA SIN 711-2



- ▶ Non-handed desk, credenza, and return shells, combined with a variety of under-the-worksurface storage solutions, maximize office layout flexibility. Shells and pedestals can be reconfigured quickly and easily when user preferences or space needs change.
- ▶ For storage components see pages 155-156.
- ▶ Tops are abrasion- and stain-resistant laminate over extra-thick 1½" solid core high-performance particleboard; resists warping.
- ▶ "Ribbon" edge profile; shape is on all four sides.
- ▶ Cord management grommets, for routing and hiding wires and cables, are located in the tops of desk and return shells.
- ▶ Credenza shells have a cord pass-through grommet in the top center of the modesty panel.
- ▶ The narrow design of the kneespace clearance end panel kits replace full end panels to provide added kneespace.
- ▶ Adjustable hex leveling glides allow floor-standing furniture to be easily leveled; glides have ¼" adjustable range.
- ▶ Credenza Shells available with Full or 10" Modesty Panel options.
- ▶ For conference table options, see the Preside® table tops and bases on pages 698-703. Order edge option "K".
- ▶ For work-in-process paper management tools, see page 171.

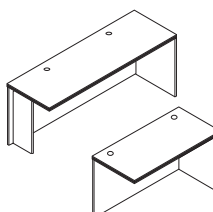

Description	Inside Dimensions	Model	Ship		
			Weight	Cube	List
 <p>24"D Return Shell (with Full Modesty Panel)</p> <p>72"W x 24"D x 29½"H, (w/support; 2 grommets)</p> <p>60"W x 24"D x 29½"H, (w/support; 2 grommets)</p> <p>48"W x 24"D x 29½"H, (1 grommet)</p> <p>42"W x 24"D x 29½"H, (1 grommet)</p> <p>36"W x 24"D x 29½"H, (1 grommet)</p> <p>30"W x 24"D x 29½"H, (1 grommet)</p>	67"W x 22¾"D	H115686 E ◆A	161	5.4	\$ 788
	55"W x 22¾"D	H115684 E ◆A	142	4.9	\$ 736
	47"W x 22¾"D	H11561 E ◆A	97	3.2	\$ 603
	41"W x 22¾"D	H115681 E ◆A	97	2.5	\$ 590
	34⅞"W x 22¾"D	H115680 E ◆A	91	3.2	\$ 590
	28⅞"W x 22¾"D	H11568 E ◆A	78	2.8	\$ 547

Model H115686 shown

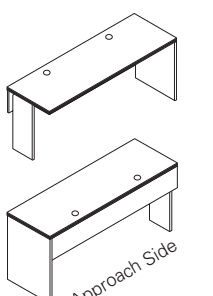
 <p>24"D Return Shell (with 10" Modesty Panel)</p> <p>72"W x 24"D x 29½"H</p> <p>60"W x 24"D x 29½"H</p> <p>48"W x 24"D x 29½"H</p> <p>42"W x 24"D x 29½"H</p> <p>36"W x 24"D x 29½"H</p> <p>30"W x 24"D x 29½"H</p>	67"W x 22¾"D	H115686X E ◆A	124	5.0	\$ 788
	55"W x 22¾"D	H115684X E ◆A	108	4.0	\$ 736
	47"W x 22¾"D	H11561X E ◆A	90	3.0	\$ 603
	41"W x 22¾"D	H115681X E ◆A	80	3.0	\$ 590
	34⅞"W x 22¾"D	H115680X E ◆A	76	3.0	\$ 590
	28⅞"W x 22¾"D	H11568X E ◆A	65	2.8	\$ 547

NOTES: Shells are non-handed. No pre-drilled grommet in modesty panel (field installable grommet included). Wood-grain direction on modesty/back panel runs vertical on 30"W-60"W sizes and horizontal on 72"W unit. 36"W return shell can be used to achieve an efficient 6' x 6' footprint when connected to either a 72"W x 36"D single pedestal desk, desk shell, or peninsula, or when two are connected to a 36"W corner unit model H115811. 30"W return shell can be used to accomplish a 5' x 5' footprint when connected to a 60"W x 30"D desk shell or peninsula. See page 163 for optional stack-on storage.

NOTE: See pages 155-156 for modular storage components.

How to specify	1st Option	2nd Option
Select Model Number from above H 1 1 5 6 8 6 .	Select Edge Profile See page 152 A .	Select Laminate See pages 48-49 N N

ABJ E◆A Icon Legend on page 10

- ▶ Pedestals can be reconfigured quickly and easily when user preferences or space needs change.
- ▶ File drawers accept hanging folders in letter or legal size.
- ▶ Narrow pedestal features a compact design that is ideal for use in U- and L-shaped layouts for smaller spaces, such as a 5' x 8' U-shaped workstation or a 5' x 5' L-shaped workstation.
- ▶ Pedestal drawers operate on full-extension, ball-bearing suspensions to ensure smooth quiet, long-lasting operation.
- ▶ Handle options shown on page 152.
- ▶ Pedestal sides are notched to enable the routing of cords and cables.
- ▶ Mobile pedestals shown on page 166, work well in a variety of configurations.
- ▶ Pedestal models ship assembled unless designated **E** or **A**.
- ▶ Modular pedestals to be used with 24"D, 30"D and 36"D Modular Shells.
- ▶ Pedestal models not designed to be used freestanding.

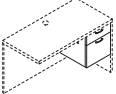
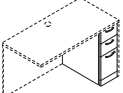
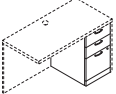
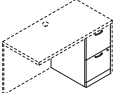

	Description	Model	Ship Weight	Cube	List
 <i>Not available in two-tone laminate</i>	Box/File Pedestal (with core removable lock) 15 ⁵ / ₈ "W x 22 ³ / ₄ "D x 17 ³ / ₄ "H NOTES: For use under 24"D, 30"D and 36"D desk, credenza and return shells. Hangrails included. Lock can be positioned on either the right or left side. Attaches to underside of worksurface top. Unfinished top and back. ⚠ Not designed to be used freestanding.	H11501	57	5.5	\$ 520
 <i>Not available in two-tone laminate</i>	Narrow Box/Box/File Pedestal — floorstanding 9 ¹ / ₂ "W x 22 ³ / ₄ "D x 28"H NOTES: For use under 24"D, 30"D and 36"D modular desk, credenza and return shells. Unfinished top and back. ⚠ Handle choices for this model are the Sweep, Crescent and Arch designs only. The linear handle (options "G" and "J") is not available on this product as the width of the component interferes with lock on the drawer face. ⚠ Not designed to be used freestanding.	H115093	61	5.6	\$ 662
 <i>Not available in two-tone laminate</i>	Box/Box/File Pedestal (with core removable lock) — floorstanding 15 ⁵ / ₈ "W x 22 ³ / ₄ "D x 28"H — for use under 24"D, 30"D and 36"D desk, credenza and return shells 15 ⁵ / ₈ "W x 18 ³ / ₄ "D x 28"H — for use under 20"D, 24"D, 30"D and 36"D desk, credenza and return shells NOTES: Top box drawer does not lock. Hangrails included. Unfinished top and back. ⚠ Not designed to be used freestanding.	H11502 H115012	90 73	8.4 7.0	\$ 673 \$ 635
 <i>Not available in two-tone laminate</i>	File/File Pedestal (with core removable lock) — floorstanding 15 ⁵ / ₈ "W x 22 ³ / ₄ "D x 28"H — for use under 24"D, 30"D and 36"D desk, credenza and return shells 15 ⁵ / ₈ "W x 18 ³ / ₄ "D x 28"H — for use under 20"D, 24"D, 30"D and 36"D desk, credenza and return shells NOTES: Hangrails included. Unfinished top and back. ⚠ Not designed to be used freestanding.	H11504 H115014	85 72	8.4 7.0	\$ 673 \$ 635

NOTE: See pages 152-154 for desk, credenza and return shells.

How to specify	1st Option	2nd Option
Select Model Number from above H 1 1 5 0 1 .	Select Handle Option Linear handles "G" and "J" not available on model H115093 See page 152 C .	Select Laminate See pages 48-49 N

- ▶ Pedestals can be reconfigured quickly and easily when user preferences or space needs change.
- ▶ See page 152 for handle design/finish options.
- ▶ File drawers accept hanging folders in letter or legal size.
- ▶ Pedestal drawers operate on full extension, ball-bearing suspensions to ensure smooth quiet, long-lasting operation.
- ▶ Pedestal sides are notched to enable the routing of cords and cables.
- ▶ Mobile pedestals shown on page 166, work well in a variety of configurations.
- ▶ Pedestal models ship assembled unless designated E⚡.

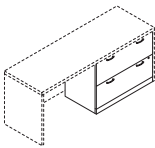
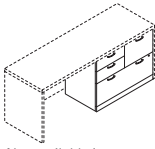
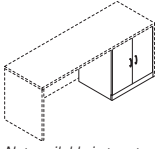

	Description	Model	Ship Weight	Cube	List
 Not available in two-tone laminate	Lateral File Pedestal (with core removable lock) — floorstanding 36"W x 20"D x 28"H — for use under 24"D, 30"D and 36"D desk, credenza and return shells NOTES: Hangrails included. Unfinished top and back. Mechanical interlock inhibits extension of more than one drawer at a time. ⚠ Not designed to be used freestanding.	H11503	127	15.6	\$1033
 Not available in two-tone laminate	Multi File Pedestal (with core removable lock) — floorstanding 36"W x 20"D x 28"H — for use under 24"D, 30"D and 36"D desk, credenza and return shells NOTES: Versatile four drawer unit features one lateral file drawer, one vertical file drawer, and two box drawers. Box drawers do not lock. Hangrails included. Unfinished top and back. Mechanical interlock in lateral drawer inhibits extension of more than one drawer at a time. ⚠ Not designed to be used freestanding.	H11505	155	15.6	\$1232
 Not available in two-tone laminate	Cabinet Pedestal — floorstanding 26"W x 21 1/4"D x 28"H — for use under 24"D, 30"D and 36"D desk, credenza and return shells NOTES: One adjustable shelf at 2 1/2" increments. Doors are non-locking. Unfinished top and back. ⚠ Not designed to be used freestanding.	H11508	78	12.2	\$ 749

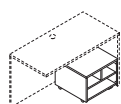

SIN 711-8

Mobile Printer/Fax Cart 20"W x 19 1/8"D x 14 1/8"H NOTES: Holds laser printers, inkjet printers or fax machines. Ideal for limited space. Low profile cart stores conveniently and easily under desks and workstations. Interior compartment shelving is Black. Four casters. 1 1/8" thick top with flat, non-profiled edge. SPECIFYING EXAMPLE: H105679.NN	H105679 E⚡	52	2.9	\$ 397
---	-------------------	----	-----	--------

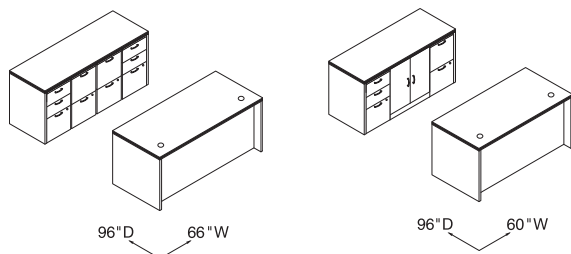

- | | |
|-------------|------------|
| 1 – H11579 | 1 – H11578 |
| 1 – H11542 | 1 – H11564 |
| 2 – H115102 | 1 – H11502 |
| 2 – H115104 | 1 – H11504 |
| | 1 – H11508 |

NOTE: See pages 152-154 for desk, credenza and return shells.

How to specify	1st Option	2nd Option
Select Model Number from above H 1 1 5 0 3 .	Select Handle Option See page 152 Not specified for model H105679 C .	Select Laminate See pages 48-49 N





- ▶ Full pedestal design provides a more formal styling aesthetic and maximizes storage space.
- ▶ Drawers in pedestal extend from underside of worksurface to the floor.
- ▶ Tops are abrasion- and stain-resistant laminate over extra-thick 1½" solid core high-performance particleboard; resists warping.
- ▶ Recessed modesty panel design facilitates conferencing. See approach side illustration at left.
- ▶ Full height modesty panels.
- ▶ Drawers operate on full extension, ball-bearing suspensions to ensure smooth, quiet, long-lasting operation.
- ▶ See page 152 for handle design/finish options.
- ▶ File drawer design includes integrated hangrails for side-to-side letter or legal filing; and front-to-back for letter filing.
- ▶ All drawers are 5-sided construction, which allows easy drawer alignment or replacement of drawer fronts.
- ▶ Desk, credenza and return models ship assembled.
- ▶ For conference table options, see the Preside® table tops and bases on pages 698-703. Order edge option "K".



	Description	Full Width Overhang	Model	Ship Weight	Cube	List
	Double Pedestal Desk, 3/2					
	72"W x 36"D x 29½"H, Bow Top	10½"	H115899	362	52.2	\$2140
	72"W x 36"D x 29½"H, Rectangle Top	10½"	H115890	370	52.2	\$2036
	66"W x 30"D x 29½"H, Rectangle Top	4½"	H115891	312	40.9	\$1958
	60"W x 30"D x 29½"H, Rectangle Top	4½"	H115892	303	37.3	\$1859
	NOTES: All drawers lock. Two worksurface grommets to route/hide cords. See page 170 for optional center drawers. Bow top model measures 36"D at the crest and 30" along the end panels.					
	Single Pedestal Desk, Bow Top					
	72"W x 36"D x 29½"H, Right	10½"	H115893R	308	52.2	\$1877
	72"W x 36"D x 29½"H, Left	10½"	H115894L	308	52.2	\$1877
	NOTES: Box/box/file drawer configuration. Drawers lock. Two worksurface grommets to route/hide cords. See page 170 for optional center drawers. Bow top model measures 36"D at the crest and 30" along the end panels.					
	Single Pedestal Desk, Rectangle Top					
	72"W x 36"D x 29½"H, Right	10½"	H115895R	316	52.2	\$1756
	66"W x 30"D x 29½"H, Right	4½"	H115897R	269	40.9	\$1594
	72"W x 36"D x 29½"H, Left	10½"	H115896L	316	52.2	\$1756
	66"W x 30"D x 29½"H, Left	4½"	H115898L	269	40.9	\$1594
	NOTES: Box/box/file drawer configuration. Drawers lock. Two worksurface grommets to route/hide cords. See page 170 for optional center drawers.					

NOTE: See pages 161 through 171 for shared components.

How to specify	1st Option	2nd Option	3rd Option
Select Model Number from above	Select Edge Profile See page 152	Select Handle Option See page 152	Select Laminate See pages 48-49
H 1 1 5 8 9 9 .	A .	C .	N N

Valido® Laminate Wood Desks — Full Pedestals

GSA SIN 711-2



- ▶ Full pedestal design provides a more formal styling aesthetic and maximizes storage space.
- ▶ Drawers in pedestal extend from underside of worksurface to the floor.
- ▶ Tops are abrasion- and stain-resistant laminate over extra-thick 1½" solid core high-performance particleboard; resists warping.
- ▶ Recessed modesty panel design facilitates conferencing. See approach side illustration at left.
- ▶ Full height modesty panels.
- ▶ Drawers operate on full extension, ball-bearing suspensions to ensure smooth, quiet, long-lasting operation.
- ▶ See page 152 for handle design/finish options.
- ▶ File drawer design includes integrated hangrails for side-to-side letter or legal filing; and front-to-back for letter filing.
- ▶ All drawers are 5-sided construction, which allows easy drawer alignment or replacement of drawer fronts.
- ▶ Valido® 18¾"D modular and mobile pedestals can be positioned under credenza with kneespace and single pedestal credenza models.
- ▶ Desk, credenza and return models ship assembled.
- ▶ For conference table options, see the Preside® table tops and bases on pages 698-703. Order edge option "K".

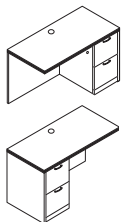
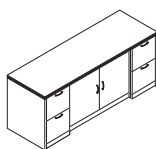
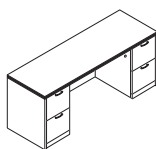
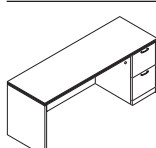

Description	Full Width Overhang	Model	Ship Weight	Cube	List
 <p>Return, File/File 48"W x 24"D x 29½"H, Right 42"W x 24"D x 29½"H, Right 48"W x 24"D x 29½"H, Left 42"W x 24"D x 29½"H, Left</p> <p>NOTES: Return is for use with single pedestal desks, desk shells, peninsulas or corner units. Drawers lock. One worksurface grommet and one cord pass-through grommet in top center of modesty panel to reach wall electrical outlets. See page 163 for optional stack-on storage.</p>		<p>H115905R H115907R H115906L H115908L</p>	<p>168 159 168 159</p>	<p>24.9 20.5 24.9 20.5</p>	<p>\$1165 \$1152 \$1165 \$1152</p>
 <p>Credenza with Doors 72"W x 24"D x 29½"H</p> <p>NOTES: All drawers lock. Doors are non-locking. One cord pass-through grommet in top center of modesty panel. Includes a fixed shelf located at the bottom of the center storage area. No intermittent shelf. See page 163 for optional stack-on storage.</p>	3½"	H115909	340	36.0	\$2131
 <p>Credenza with Kneespace — 2/0/2 72"W x 24"D x 29½"H 66"W x 24"D x 29½"H 60"W x 24"D x 29½"H</p> <p>NOTES: All drawers lock. One cord pass-through grommet in top center of modesty panel. See page 163 for optional stack-on storage. ⚠ Not designed to be used with Valido/11500 Series 24"D modular or mobile pedestals.</p>	<p>3½" 3½" 3½"</p>	<p>H115900 H115901 H115902</p>	<p>296 286 257</p>	<p>36.0 31.6 28.8</p>	<p>\$1813 \$1725 \$1671</p>
 <p>Single Pedestal Credenza, File/File 72"W x 24"D x 29½"H, Right (shown) 72"W x 24"D x 29½"H, Left</p> <p>NOTES: Drawers lock. One cord pass-through grommet in top center of modesty panel. See page 163 for optional stack-on storage. ⚠ Not designed to be used with Valido/11500 Series 24"D modular or mobile pedestals.</p>	<p>3½" 3½"</p>	<p>H115903R H115904L</p>	<p>251 251</p>	<p>36.0 36.0</p>	<p>\$1492 \$1492</p>

NOTE: See pages 161 through 171 for shared components.

How to specify	1st Option	2nd Option	3rd Option
<p>Select Model Number from above H 1 1 5 9 0 5 R .</p>	<p>Select Edge Profile See page 152 A .</p>	<p>Select Handle Option See page 152 C .</p>	<p>Select Laminate See pages 48-49 N N </p>

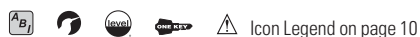

Icon Legend on page 10



- ▶ For components that can be shared with Valido/11500 Series, see pages 161-171.
- ▶ Tops are abrasion- and stain-resistant laminate over extra-thick 1 1/2" solid core high-performance particleboard; resists warping.
- ▶ 3/4 pedestal design increases budget flexibility.
- ▶ Formal, full height modesty panels.
- ▶ All drawers are 5-sided construction, which allows easy drawer alignment or replacement of drawer fronts.
- ▶ The small foot print of the Small Office Desk is ideal for limited space.
- ▶ Drawers operate on full extension, ball-bearing suspensions to ensure smooth, quiet, long-lasting operation.
- ▶ See page 152 for handle design/finish options.
- ▶ Center drawers conveniently store writing instruments, paper and other miscellaneous items. Includes pencil tray. See page 170.
- ▶ File drawer design includes integrated hangrails for side-to-side letter or legal filing; and front-to-back for letter filing.
- ▶ Desk, credenza and return models ship assembled.
- ▶ See page 163 for optional stack-on storage.
- ▶ For conference table options, see the Preside® table tops and bases on pages 698-703. Order edge option "K".



	Description	Full Width Overhang	Model	Ship Weight	Cube	List
	Double Pedestal Desk, 2-2					
	72"W x 36"D x 29 1/2"H, Bow Top	10 1/2"	H11595	356	52.2	\$1719
	72"W x 36"D x 29 1/2"H, Rectangle Top	10 1/2"	H11593	364	52.2	\$1574
	66"W x 30"D x 29 1/2"H, Rectangle Top	4 1/2"	H11571	304	40.9	\$1503
	60"W x 30"D x 29 1/2"H, Rectangle Top	4 1/2"	H11573	288	37.3	\$1417
	NOTES: All drawers lock. Two worksurface grommets to route/hide cords. See page 170 for optional center drawers.					
	Single Pedestal Desk, Bow Top					
	72"W x 36"D x 29 1/2"H, Right	10 1/2"	H11587R	264	52.9	\$1514
	72"W x 36"D x 29 1/2"H, Left	10 1/2"	H11588L	264	52.9	\$1514
	NOTES: Drawers lock. Two worksurface grommets to route/hide cords. See page 170 for optional center drawers. Bow top models measure 36"D at the crest and 30"D along the end panels.					
	Single Pedestal Desk, Rectangle Top					
	72"W x 36"D x 29 1/2"H, Right	10 1/2"	H11585R	303	52.2	\$1338
	66"W x 30"D x 29 1/2"H, Right	4 1/2"	H11583R	247	40.9	\$1251
	72"W x 36"D x 29 1/2"H, Left	10 1/2"	H11586L	303	52.2	\$1338
	66"W x 30"D x 29 1/2"H, Left	4 1/2"	H11584L	247	40.9	\$1251
	NOTES: Drawers lock. Two worksurface grommets to route/hide cords. See page 170 for optional center drawers.					
	Small Office Desk					
	48"W x 30"D x 29 1/2"H	4 1/2"	H115885R	183	30.0	\$1009
	NOTES: Small footprint makes this desk ideal for limited space. Drawers lock. One cord grommet in top for routing and hiding wires and cables. 3/4 length modesty panel facilitates reaching wall electrical outlets. Optional stack-on storage model H115323 maximizes storage space; see page 163 for additional stack-on storage models.					
	Return, Box/File					
	48"W x 24"D x 29 1/2"H, Right		H11515R	158	24.9	\$ 974
	42"W x 24"D x 29 1/2"H, Right		H11511R	146	20.5	\$ 962
	48"W x 24"D x 29 1/2"H, Left		H11516L	158	24.9	\$ 974
	42"W x 24"D x 29 1/2"H, Left		H11512L	146	20.5	\$ 962
	NOTES: Return is for use with single pedestal desks, desk shells, peninsulas or corner units. Drawers lock. One worksurface grommet and one cord pass-through grommet in top center of modesty panel to reach wall electrical outlets. See page 163 for optional stack-on storage.					
	⚠ Not designed to be used freestanding.					

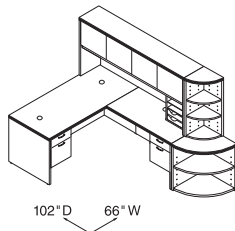

H11584L
H11515R
H115327
H115520
H115523
HLVPM1

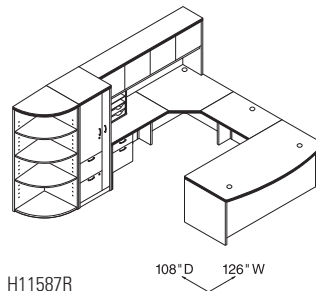

H11587R
H115598
H115811
H11516L
H115301
H115524
H115327
HLVPM1

NOTE: See pages 161 through 171 for shared components.

How to specify	1st Option	2nd Option	3rd Option
Select Model Number from above	Select Edge Profile See page 152	Select Handle Option See page 152	Select Laminate See pages 48-49
H 1 1 5 9 5 .	A .	C .	N N

Valido® Laminate Wood Desks — 3/4 Pedestals

GSA SIN 711-2



- ▶ For components that can be shared with Valido/11500 Series, see pages 161-171.
- ▶ Tops are abrasion- and stain-resistant laminate over extra-thick 1/2" solid core high-performance particleboard; resists warping.
- ▶ Formal, full height modesty panels.
- ▶ Cord management grommets, for routing and hiding wires and cables, are located in the tops of desks, returns, bridges and corner units.
- ▶ All drawers are 5-sided construction, which allows easy drawer alignment or replacement of drawer fronts.
- ▶ Drawers operate on full extension, ball-bearing suspensions to ensure smooth, quiet, long-lasting operation.
- ▶ See page 152 for handle design/finish options.
- ▶ File drawer design includes integrated hangrails for side-to-side letter or legal filing; and front-to-back for letter filing.
- ▶ For conference table options, see the Preside™ table tops and bases on pages 698-703. Order edge option "K".

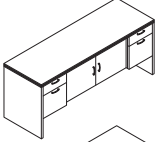
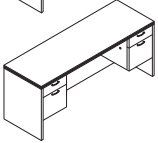
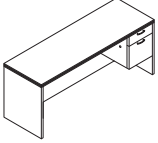

Description	Full Width Overhang	Model	Ship Weight	Cube	List
 Credenza with Doors 72"W x 24"D x 29½"H NOTES: Includes one fixed shelf at the bottom of the center storage area. All drawers lock. Doors are non-locking.	3½"	H11544	294	36.0	\$1733
 Credenza with Kneespace 72"W x 24"D x 29½"H 66"W x 24"D x 29½"H 60"W x 24"D x 29½"H NOTES: One cord pass-through grommet in top center of modesty panel to reach wall electrical outlets. All drawers lock. See page 163 for optional stack-on storage.	3½" 3½" 3½"	H11543 H11566 H11565	259 249 239	36.0 31.6 28.8	\$1460 \$1417 \$1365
 Credenza, Single Pedestal, Box/File 72"W x 24"D x 29½"H, Right (shown) 72"W x 24"D x 29½"H, Left NOTES: One cord pass-through grommet in top center of modesty panel to reach wall electrical outlets. Drawers lock. See page 163 for optional stack-on storage.	3½" 3½"	H11545R H11546L	228 228	36.0 36.0	\$1223 \$1223

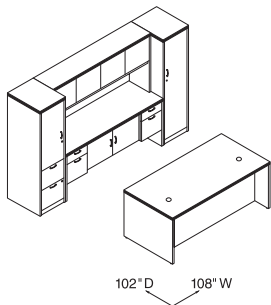

H11593
H11544
H115295R
H115298L
H11534

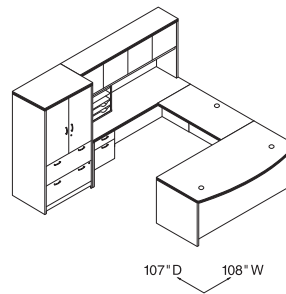

H11587R
H11570
H11546L
H11534
H115293
HLVPM1



NOTE: See pages 161 through 171 for shared components.

How to specify	1st Option	2nd Option	3rd Option
Select Model Number from above H 1 1 5 4 4 .	Select Edge Profile See page 152 A .	Select Handle Option See page 152 C .	Select Laminate See pages 48-49 N N

ABJ Level ONE KEY Icon Legend on page 10

- ▶ Shared components shown on this page can be used with modular components shown on pages 152-156, full pedestal models shown on pages 157-158, and 3/4 pedestal models shown on pages 159-160.
- ▶ Mobile pedestals shown on page 166 work well in a variety of configurations.
- ▶ Peninsulas ship complete with end panel and black 4 1/2" diameter support column. For a silver support column option, please see model HPC191X on page 133 (ordered separately).
- ▶ Jetty, Boomerang and Rudder peninsulas are designed and sized to efficiently serve as both a computing and conferencing space.
- ▶ Adjustable hex leveling glides allow floor-standing furniture to be easily leveled; glides have 3/4" adjustable range.
- ▶ For conference table options, see the Preside® table tops and bases on pages 698-703. Order edge option "K".

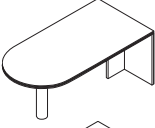
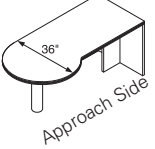
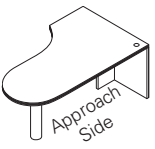
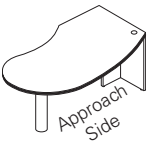
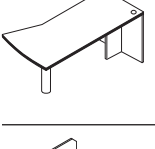

Description	Model	Ship Weight	Cube	List
 <p>Peninsula w/End Panel 72"W x 36"D x 29 1/2"H 66"W x 30"D x 29 1/2"H 60"W x 30"D x 29 1/2"H</p>	H11521 E♦A	171	15.1	\$ 948
	H11522 E♦A	142	11.8	\$ 866
	H11523 E♦A	119	11.4	\$ 805
 <p>P-shaped Peninsula w/End Panel 72"W x 30/36"D x 29 1/2"H, Right (shown) 72"W x 36/30"D x 29 1/2"H, Left</p> <p>NOTES: Use for "U" or "L" configuration. 60"W ideal for smaller spaces. Cord routing notch in brace panel. Accept field installable modesty panel model H10528 (see below). See page 170 for optional center drawers. Peninsulas ship complete with end panel and support column. Support column is black. ⚠ Not designed to be used freestanding.</p>	H11525R E♦A	163	13.4	\$1055
	H11526L E♦A	163	13.4	\$1055
 <p>Jetty Peninsula w/End Panel 72"W x 30/42"D x 29 1/2"H, Right (shown) 72"W x 42/30"D x 29 1/2"H, Left</p> <p>NOTES: For use in "U" or "L" configuration. Designed and sized to efficiently serve as both a computing and conferencing space. One cord management grommet in the top; cord routing notch in brace panel. Jetty units manufactured on or after 10/24/2005 accept field installable modesty panel H10528 (see below). Peninsulas ship complete with end panel and support column. Support column is black. ⚠ Not designed to be used freestanding.</p>	H115201R E♦A	179	16.9	\$1223
	H115202L E♦A	179	16.9	\$1223
 <p>Boomerang Peninsula w/End Panel 72"W x 30/42"D x 29 1/2"H, Right (shown) 72"W x 42/30"D x 29 1/2"H, Left</p> <p>NOTES: For use in "U" or "L" configuration. Designed and sized to efficiently serve as both a computing and conferencing space. One cord management grommet in the top; cord routing notch in brace panel. Accepts field installable modesty panel H10528 (see below). Peninsulas ship complete with end panel and support column. Support column is black. ⚠ Not designed to be used freestanding.</p>	H115203R E♦A	176	16.9	\$1223
	H115204L E♦A	176	16.9	\$1223
 <p>Rudder Peninsula w/End Panel 72"W x 30/38"D x 29 1/2"H, Right 72"W x 38/30"D x 29 1/2"H, Left</p> <p>NOTES: Use for "U" or "L" configuration. One cord management grommet in the top; cord routing notch in the brace panel. Support column is black. ⚠ Not designed to be used freestanding.</p>	H115205R E♦A	168	16.8	\$1154
	H115206L E♦A	168	16.8	\$1154
 <p>Field Installable Modesty Panel for Peninsulas 50 1/4"W x 3/4" Thick x 18"H</p> <p>NOTES: Center drawer model H1522 can be used in conjunction with modesty panel. Laminate Modesty Panel has a cord pass-through notch in top corner. ⚠ Not designed to be used on jetty peninsulas manufactured prior to 10/24/2005. SPECIFYING EXAMPLE: H10528.N</p>	H10528	25	1.3	\$ 170
 <p>Field Installable Modesty Panel for Bullet, Jetty and Boomerang Peninsulas, Frosted with Silver Frame 50 1/4"W x 3/4" Thick x 18"H</p> <p>NOTES: For use on 72"W peninsulas. Frosted/silver modesty panel HPC180G can be used with Valido, 10700, 10600 and 10500 Series™ peninsula models. Cord pass-through notch is not available on the Frosted/Silver model HPC180G. Notch is on laminate model H10528 only. ⚠ Center drawers not designed to be used with the frosted/silver modesty panel model HPC180G.</p>	HPC180G	33	1.5	\$ 629

NOTE: See pages 161 through 171 for shared components.

How to specify	1st Option	2nd Option
Select Model Number from above H 1 1 5 2 1 .	Select Edge Profile See page 152 A .	Select Laminate See pages 48-49 N N

- ▶ Shared components shown on this page can be used with modular components shown on pages 152-156, full pedestal models shown on pages 157-158, and 3/4 pedestal models shown on pages 159-160.
 - ▶ Mobile pedestals shown on page 166 work well in a variety of configurations.
 - ▶ Locking units equipped with interchangeable core removable locks.
 - ▶ File drawers accept hanging folders in letter or legal size.
 - ▶ See page 152 for handle design/finish options.
 - ▶ Adjustable hex leveling glides allow floor-standing furniture to be easily leveled; glides have 3/4" adjustable range.
- ⚠ **Keyed alike cores must be ordered separately — see page 743.**



	Description	Model	Ship Weight	Cube	List
	Bridge (Single Ped. Desk, Desk Shell or Peninsula, to Corner Unit, Single Ped. Credenza or Credenza Shell) 47"W x 24"D x 29 1/2"H, (Clear inside depth = 21 7/8"D)	H11570 E♦A	86	3.2	\$ 442
	42"W x 24"D x 29 1/2"H, (Clear inside depth = 21 7/8"D)	H11560 E♦A	81	2.9	\$ 423
	36"W x 24"D x 29 1/2"H, (Clear inside depth = 21 7/8"D) (see notes below)	H115599 E♦A	69	2.9	\$ 423
	30"W x 24"D x 29 1/2"H, (Clear inside depth = 21 7/8"D) (see notes below)	H115598 E♦A	57	2.2	\$ 423
	47"W x 20"D x 29 1/2"H, (Clear inside depth = 17 7/8"D) (see notes below)	H115699 E♦A	70	3.2	\$ 423
	42"W x 20"D x 29 1/2"H, (Clear inside depth = 17 7/8"D) (see notes below)	H115698 E♦A	62	2.9	\$ 404
	NOTES: One worksurface grommet and one grommet in top and in top center of modesty panel. Kneespace of desk limited to 24 3/4"W if bridge is used with 66"W single pedestal desk. H115599 is for use with corner or extended corner units or jetty or boomerang peninsulas. H115598 is for use with corner or extended corner units. H115699 and H115698 are for use with single pedestal desks, desk shells or peninsulas (excluding jetty and boomerang). Specify: Model.Edge.Laminate SPECIFYING EXAMPLE: H11570.A.NN				
	Credenza with 36" Lateral (with core removable locks) 72"W x 24"D x 29 1/2"H, Right (shown)	H11547R	264	36.0	\$1565
	72"W x 24"D x 29 1/2"H, Left	H11548L	264	36.0	\$1565
	NOTES: Includes hangrails. Mechanical interlock inhibits the extension of more than one drawer at a time. See page 163 for optional stack-on storage. ⚠ Not designed to be used with Valido/11500 Series 24"D modular or mobile pedestals.				
	Credenza with two Lateral Files (with core removable locks) 72"W x 24"D x 29 1/2"H	H115491	330	36.0	\$2195
	NOTES: 4 locking drawers. Each lock secures 2 drawers. Includes hangrails; mechanical interlock inhibits the extension of more than one drawer at a time. If side-by-side drawers are opened or closed simultaneously, one drawer may interfere with the other. See page 163 for optional stack-on storage.				
	Credenza with Lateral File, left and Storage Cabinet, right (with core removable locks) 72"W x 24"D x 29 1/2"H	H115492	323	36.0	\$1991
	NOTES: Includes hangrails; mechanical interlock inhibits the extension of more than one drawer at a time. Storage cabinet locks and includes one adjustable interior shelf. Shelf adjusts in 1/4" increments with a total range of 6 1/4"H. See page 163 for optional stack-on storage.				
	Credenza w/Two Storage Cabinets 72"W x 24"D x 29 1/2"H	H115493	320	35.6	\$1765
	NOTES: Each storage cabinet has one interior shelf which adjusts in 1 1/4" increments over a total range of 5". Each cabinet locks independently. Locks are keyed alike. For optional stack-on storage, see page 163 for additional stack-on storage models.				

NOTE: See pages 161 through 171 for shared components.

How to specify	1st Option	2nd Option	3rd Option
Select Model Number from above	Select Edge Profile See page 152	Select Handle Option See page 152 Not specified on Bridge models	Select Laminate See pages 48-49
H 1 1 5 4 7 R .	A .	C .	N N

▶ Shared components shown on this page can be used with modular components shown on pages 152-156, full pedestal models shown on pages 157-158, and 3/4 pedestal models shown on pages 159-160.

▶ Stack-on storage models are equipped with self-closing, adjustable hinged doors and valance to hide task light.
▶ For work-in-process paper management tools, see page 171.

▲ **Removable lock core kit for stack-on and wall mount storage is model HF27B, see page 743.**

▲ **The HON Company is not responsible for any liabilities resulting from wall mounted storage cabinets that are not properly installed.**



	Description	Model	Ship Weight	Cube	List
	Stack-on Storage for an "L" Workstation 78"W x 14 ⁵ / ₈ "D x 37 ¹ / ₂ "H	H115327 E ⚡	209	17.6	\$1261
	Stack-on Storage for an "L" Workstation, Locking 78"W x 14 ⁵ / ₈ "D x 37 ¹ / ₂ "H	H115327K E ⚡	209	17.6	\$1341
	NOTES: Spans the total depth dimension of configurations comprised of: 48"W return or return shell attached to a 30"D single pedestal desk, desk shell or peninsula (78"D); 42"W return or return shell attached to a 36"D single pedestal desk, desk shell or peninsula (78"D). 42"W return or return shell attached to a 36" corner unit (78"D); or 42"W curved return attached to 36" curved corner unit (78"D). Use back enclosure model H105857 and tackboard model H90057 (see page 164). Use task light models HH870960, or HH870960CH (see page 376). For vertical paper manager model HLVP1, see page 171.				
	Stack-on Storage (See page 164 for Back Enclosures and Fabric Tackboards) 72"W x 14 ⁵ / ₈ "D x 37 ¹ / ₂ "H, 4 doors (Use Task Light model HH870960, see page 172)	H11534 E ⚡	195	16.9	\$1132
	66"W x 14 ⁵ / ₈ "D x 37 ¹ / ₂ "H, 4 doors (Use Task Light model HH870960, see page 172)	H11533 E ⚡	184	15.3	\$1105
	60"W x 14 ⁵ / ₈ "D x 37 ¹ / ₂ "H, 4 doors (Use Task Light model HH870960, see page 172)	H115324 E ⚡	172	14.0	\$1059
	48"W x 14 ⁵ / ₈ "D x 37 ¹ / ₂ "H, 3 doors (Use Task Light model HH870942, see page 172)	H115323 E ⚡	148	11.3	\$ 920
	42"W x 14 ⁵ / ₈ "D x 37 ¹ / ₂ "H, 2 doors (Use Task Light model HH870942, see page 172)	H115322 E ⚡	141	4.0	\$ 791
	36"W x 14 ⁵ / ₈ "D x 37 ¹ / ₂ "H, 2 doors (Use Task Light model HH870930, see page 172)	H115321 E ⚡	107	3.5	\$ 758
	Stack-on Storage, Locking (See page 164 for Back Enclosures and Fabric Tackboards) 72"W x 14 ⁵ / ₈ "D x 37 ¹ / ₂ "H, 4 doors (Use Task Light model HH870960, see page 172)	H11534K E ⚡	195	16.9	\$1212
66"W x 14 ⁵ / ₈ "D x 37 ¹ / ₂ "H, 4 doors (Use Task Light model HH870960, see page 172)	H11533K E ⚡	184	15.3	\$1185	
60"W x 14 ⁵ / ₈ "D x 37 ¹ / ₂ "H, 4 doors (Use Task Light model HH870960, see page 172)	H115324K E ⚡	172	14.0	\$1139	
48"W x 14 ⁵ / ₈ "D x 37 ¹ / ₂ "H, 3 doors (Use Task Light model HH870942, see page 172)	H115323K E ⚡	148	11.3	\$ 960	
42"W x 14 ⁵ / ₈ "D x 37 ¹ / ₂ "H, 2 doors (Use Task Light model HH870942, see page 172)	H115322K E ⚡	141	4.0	\$ 831	
36"W x 14 ⁵ / ₈ "D x 37 ¹ / ₂ "H, 2 doors (Use Task Light model HH870930, see page 172)	H115321K E ⚡	107	3.5	\$ 798	
	NOTES: Models H11534 and H11534K can be used for "L" configuration comprised of 30"D desk, desk shell or peninsula and 42"W return or return shell. Model H115323K has one lock which secures two of the three doors. For vertical paper manager, see page 171.				
	Stack-on Storage for an "L" Workstation, Frosted Doors with Silver Frame 78"W x 14 ⁵ / ₈ "D x 37 ¹ / ₂ "H, 4 doors (Use Task Light model HH870960, see page 172)	H115327G E ⚡	210	18.4	\$1861
	NOTES: Spans the total depth dimension of configurations comprised of: 48"W return or return shell attached to a 30"D single pedestal desk, desk shell or peninsula (78"D); 42"W return or return shell attached to a 36"D single pedestal desk or desk shell with a rectangle top, or to a peninsula (78"D). 42"W return or return shell attached to a 36" corner unit (78"D); 42"W curved return attached to 36" curved corner unit (78"D); or 36"W return shell attached to a jetty peninsula (78"D). Use back enclosure model 105857 and tackboard model 90057. Use task light models H870960 or H870960CH. For vertical paper manager model HLVP1, see page 171.				
	Stack-on Storage, w/Frosted Doors with Silver Frame 72"W x 14 ⁵ / ₈ "D x 37 ¹ / ₂ "H, 4 doors (Use Task Light model HH870960, see page 172)	H11534G E ⚡	196	17.0	\$1732
	66"W x 14 ⁵ / ₈ "D x 37 ¹ / ₂ "H, 4 doors (Use Task Light model HH870960, see page 172)	H11533G E ⚡	185	15.6	\$1705
	60"W x 14 ⁵ / ₈ "D x 37 ¹ / ₂ "H, 4 doors (Use Task Light model HH870960, see page 172)	H115324G E ⚡	173	14.2	\$1659
	48"W x 14 ⁵ / ₈ "D x 37 ¹ / ₂ "H, 3 doors (Use Task Light model HH870942, see page 172)	H115323G E ⚡	148	11.5	\$1370
	42"W x 14 ⁵ / ₈ "D x 37 ¹ / ₂ "H, 2 doors (Use Task Light model HH870942, see page 172)	H115322G E ⚡	141	4.1	\$1091
	36"W x 14 ⁵ / ₈ "D x 37 ¹ / ₂ "H, 2 doors (Use Task Light model HH870930, see page 172)	H115321G E ⚡	107	4.1	\$1058
	NOTES: For respective desk, credenza or return widths. Model 11534 can be used for "L" configuration comprised of a 42"W return or return shell attached to a 30"D single pedestal desk, desk shell or peninsula (72"); 36"W return shell attached to a 36"D single pedestal desk, desk shell or peninsula (72"); or 30"W return shell attached to a jetty peninsula (72"). Back enclosures, tackboards for use with back enclosures and task lights are available as options. See vertical paper manager model HLVP1 on page 171.				
Stack-on Storage models H115327G, H11534G, H11533G and H115324G use task light model HH870960. Models H115323G and H115322G use task light model H870942 and model H115321G uses task light model HH870930. All task lights can be found on page 172.					
	Stack-on Storage Clearance End Panel Kit 1 ¹ / ₈ "W x 4 ⁹ / ₁₆ "-14 ⁵ / ₈ "D x 36"H	H105349	29	3.4	\$ 331
	Two field installable end panels (1-right; 1-left) for use in ganging two 10500 or Valido® Series stack-on storage units. See page 232. NOTES: Can be used to connect up to two stack-on storage units in a line (requires 1 kit). Not available in two-tone laminate. SPECIFYING EXAMPLE: H105349.N				

NOTE: See pages 161 through 171 for shared components.

How to specify	1st Option	2nd Option
Select Model Number from above H 1 1 5 3 4 .	Select Edge Profile See page 152 A .	Select Laminate See pages 48-49 N N

▶ Shared components shown on this page can be used with modular components shown on pages 152-156, full pedestal models shown on pages 157-158, and 3/4 pedestal models shown on pages 159-160.

▶ Back enclosure features full-width 1 1/8" slot at the bottom to facilitate routing cords and reaching wall electrical outlets.
 ▶ Tackboard is sized 3/4" narrower than stack-on storage back enclosure, allowing 3/8" on each side to route task light cord.

▶ Wall mounted storage cabinet attachment requires individual cabinets be secured by a minimum of two wall mounting locations/studs.
 ▶ Wall mounted storage cabinets are designed for interior and perimeter walls that are constructed with wood or metal studs.

▶ Wall attachment methodology: horizontally mounted, interlocking brackets.
 ▶ Wall mounted storage cabinet door design overlaps end panels so that when multiple units are placed side-by-side they appear as one continuous unit.

⚠ **Removable lock core kit for stack-on and wall mount storage is model HF27B, see page 743.**
 ⚠ **The HON Company is not responsible for any liabilities resulting from wall mounted storage cabinets that are not properly installed.**

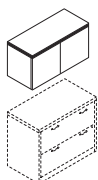

Description

Model

Ship COM Weight Cube List

Wall Mounted Storage Cabinet					
30"W x 14 5/8"D x 18 7/8"H, 2 doors (Use Task Light model HH870930, see page 172)	H115380		77	8.7	\$ 765
36"W x 14 5/8"D x 18 7/8"H, 2 doors (Use Task Light model HH870930, see page 172)	H115381		92	10.2	\$ 805
42"W x 14 5/8"D x 18 7/8"H, 2 doors (Use Task Light model HH870942, see page 172)	H115382		103	11.7	\$ 866
48"W x 14 5/8"D x 18 7/8"H, 3 doors (Use Task Light model HH870942, see page 172)	H115383		121	14.0	\$ 935

Wall Mounted Storage Cabinet, Locking

30"W x 14 5/8"D x 18 7/8"H, 2 doors (Use Task Light model HH870930, see page 172)	H115380K		77	8.7	\$ 805
36"W x 14 5/8"D x 18 7/8"H, 2 doors (Use Task Light Model HH870930, see page 172)	H115381K		92	10.2	\$ 845
42"W x 14 5/8"D x 18 7/8"H, 2 doors (Use Task Light Model HH870942, see page 172)	H115382K		103	11.7	\$ 906
48"W x 14 5/8"D x 18 7/8"H, 3 doors (Use Task Light Model HH870942, see page 172)	H115383K		121	14.0	\$ 975

NOTES: Horizontal interlocking rails are included; due to varying types of walls, installers are responsible for selecting and supplying the appropriate fasteners. Tackboard widths differ slightly from wall mounted storage cabinet widths. For applications where multiple wall mounted storage cabinets are placed side-by-side, the preferred tackboard solution may be to utilize a larger tackboard size. For example, H90057 = 75"W; H90056 = 68 3/4"W; H90055 = 62 3/4"W; H90054 = 56 3/4"W. For paper organizer tools, see page 171.

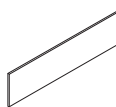

18 7/8"H

Not available in two-tone laminate

SIN 711-8

Back Enclosure for Stack-on Storage

75 3/4"W - for 78"W model #H115327	H105857		39	1.4	\$ 238
69 3/4"W - for 72"W model #H11534	H105856		33	1.3	\$ 218
63 3/4"W - for 66"W model #H11533	H105855		31	1.3	\$ 203
57 3/4"W - for 60"W model #H115324	H105854		29	1.3	\$ 194
45 3/4"W - for 48"W model #H115323	H105853		23	0.9	\$ 194
39 3/4"W - for 42"W model #H115322	H105852		21	0.9	\$ 185
33 3/4"W - for 36"W model #H115321	H105851		18	0.9	\$ 174

NOTES: Non-tackable. Specify laminate.

SPECIFYING EXAMPLE: H105857.N

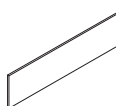

18"H

Tackboards for use with Stack-on Back Enclosures

75"W - for 78"W model #H115327 Hutch with #H105857 Enclosure	H90057	3	13	3.2	\$ 289
68 3/4"W - for 72"W model #H11534 Hutch with #H105856 Enclosure	H90056	2	12	2.7	\$ 276
62 3/4"W - for 66"W model #H11533 Hutch with #H105855 Enclosure	H90055	2	11	2.5	\$ 261
56 3/4"W - for 60"W model #H115324 Hutch with #H105854 Enclosure	H90054	2	10	2.2	\$ 230
44 3/4"W - for 48"W model #H115323 Hutch with #H105853 Enclosure	H90053	2	8	1.8	\$ 220
39"W - for 42"W model #H115322 Hutch with #H105852 Enclosure	H90052	2	7	1.6	\$ 202
33"W - for 36"W model #H115321 Hutch with #H105851 Enclosure	H90051	1	6	1.4	\$ 179

NOTES: Specify fabric, see pages 310-311. Upcharges may apply to premium fabric grades.

⚠ **Back Enclosures must be ordered separately.**

SPECIFYING EXAMPLE: H90057.APN15

NOTE: See pages 161 through 171 for shared components.

How to specify	1st Option	2nd Option
Select Model Number from above	Select Edge Profile	Select Laminate
See page 152	See pages 48-49	
H 1 1 5 3 8 0 .	A .	N N

Icon Legend on page 10

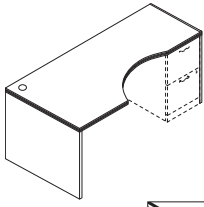

Ribbon Edge Detail



- ▶ Shared components shown on this page can be used with modular components shown on pages 152-156, full pedestal models shown on pages 157-158, and 3/4 pedestal models shown on pages 159-160.
- ▶ Mobile pedestals, shown on page 166, work well in a variety of configurations.
- ▶ Extended corner units (H115815R and H115816L) can be used with 36"W return shell (H115680) to achieve a 6' x 6' layout.
- ▶ 36" corner unit (H115811) can be used with two 36"W return shells (H115680) to achieve a 6' x 6' layout.
- ▶ For conference table options, see the Preside® table tops and bases on pages 698-703. Order edge option "K".
- ▶ For work-in-process paper management tools, see page 171.











Description	Model	Ship Weight	Cube	List	
Extended Corner Unit 24"W x 36"D x 72"W x 24"D x 29 1/2"H, Right (shown) 24"D x 72"W x 36"D x 24"W x 29 1/2"H, Left NOTES: Can be used freestanding. One grommet in top and in modesty panel. Accept Valido/11500 Series modular or mobile pedestals. See page 163 for optional stack-on storage. ▲ Designed to be used with returns or bridges. SPECIFYING EXAMPLE: H115815R.A.NN					
		H115815R E♦A H115816L E♦A	203	7.0	\$1147
<p>Right-hand model H115815R shown</p>					
	H115298L H115816L H11534 H11515R				
Corner Unit 24" x 36" x 36" x 24" x 29 1/2"H NOTES: Can be used freestanding. ▲ Designed to be used with 24"D x 29 1/2"H returns or bridges. SPECIFYING EXAMPLE: H115811.A.NN		H115811 E♦A	141	3.1	\$ 790

NOTE: See pages 161 through 171 for shared components.

How to specify	1st Option	2nd Option
Select Model Number from above H 1 1 5 8 1 7 R .	Select Edge Profile See page 152 A .	Select Laminate See pages 48-49 N N

- ▶ For additional components that can be shared with Valido/11500 Series, see pages 161-171.
- ▶ Drawers operate on full extension, ball-bearing suspensions to ensure smooth, quiet, long-lasting operation.
- ▶ Versatile mobile pedestals work well in a variety of configurations. Can be used freestanding or under modular shells. 1 1/8" thick top with a square, non-profiled edge.
- ▶ 24"D two drawer lateral file and 24"D storage cabinet with door models align with 24"D credenzas and returns, credenza and return shells as well as wardrobe/storage cabinets to provide linear layout continuity.
- ▶ Mobile printer/fax cart shown on page 156 is ideal for limited space.
- ▶ File drawer design includes integrated hangrails for side-to-side letter or legal filing; and front-to-back for letter filing.
- ▶ Adjustable hex leveling glides allow floor-standing furniture to be easily leveled; glides have 3/4" adjustable range.
- ▶ For conference table options, see the Preside® table tops and bases on pages 698-703. Order edge option "K".

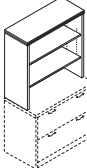

Description	Model	Ship Weight	Cube	List
 Mobile Pedestal (with core removable lock) — Box/Box/File 15 3/4"W x 22 3/4"D x 28 3/8"H — use freestanding or under 24"D, 30"D and 36"D modular shells NOTES: Top box drawer does not lock.	H115102	121	8.4	\$ 826
 Mobile Pedestal (with core removable lock) — File/File 15 3/4"W x 22 3/4"D x 28 3/8"H — use freestanding or under 24"D, 30"D and 36"D modular shells	H115104	121	8.4	\$ 826
 Mobile Pedestal (with core removable lock) — Box/File 15 3/4"W x 18 3/4"D x 21 7/8"H — use freestanding or under 20"D, 24"D, 30"D and 36"D modular shells	H115106	68	5.8	\$ 688
 Mobile Pedestal — Shelf/Box/File 15 3/4"W x 18 3/4"D x 28 3/8"H — use freestanding or under 20"D, 24"D, 30"D and 36"D modular shells NOTES: All mobile pedestals have a 1 1/8" thick top with flat, non-profiled edge. SPECIFYING EXAMPLE: H115102.C.NN	H115109	76	7.3	\$ 757
 Lateral File (with core removable lock) 36"W x 24"D x 29 1/2"H — two drawer 36"W x 20"D x 29 1/2"H — two drawer 36"W x 20"D x 45 1/2"H — three drawer 36"W x 20"D x 59 1/8"H — four drawer NOTES: Includes hangrails, mechanical interlock, and in H11563 and H115690, a counterweight. Stack-on storage (H115321) and bookcase hutch (H115292) can be used with H11563 and H115690. Interlock inhibits the extension of more than one drawer from opening at a time. 24"D two-drawer model aligns with the depth of 24"D credenzas and returns. SPECIFYING EXAMPLE: H11563.A.C.NN	H115690 H11563 H11517 H11516	199 177 247 312	18.4 15.6 23.2 31.0	\$1154 \$1099 \$1671 \$2329
    Storage Cabinet with Doors (with core removable lock) 36"W x 24"D x 29 1/2"H 36"W x 20"D x 29 1/2"H NOTES: Includes one adjustable shelf. Shelf adjusts in 1/4" increments with a total range of 6 1/4"H. Stack-on storage (H115321) and bookcase hutch (H115292) can be used with H115290 or H115291. 24"D model aligns with the depth of 24"D credenzas and returns. SPECIFYING EXAMPLE: H115291.A.C.NN	H115290 H115291	176 154	18.4 15.0	\$ 992 \$ 852
 Bookcase Hutch (for use with lateral file models H11563 or H115690 or storage cabinet with door models H115291 or H115290) 36"W x 14 5/8"D x 37 1/2"H NOTES: Cord pass-through gap behind shelves and a 1 1/8"H full-width cord management slot at the bottom of the back panel to facilitate routing cords and reaching wall electrical outlets. When placed on top of 29 1/2"H base unit the total height (67"H) matches the height of credenzas with stack-on storage and the height of the wardrobe/storage cabinets and storage cabinet/lateral file. Two shelves are adjustable in 1/4" increments with a total range of 17 1/2"H. SPECIFYING EXAMPLE: H115292.A.NN	H115292 E↔A	108	3.8	\$ 664

NOTE: See pages 161 through 171 for shared components.

How to specify	1st Option	2nd Option	3rd Option
Select Model Number from above H 1 1 5 6 3 .	Select Edge Profile See page 152 Not specified for models H115102, H115103 and H115104 A .	Select Handle Option See page 152 Not specified for models H115292, H115520, H115523 and H115524 C .	Select Laminate See pages 48-49 N N





▶ Adjustable hex leveling glides allow floor-standing furniture to be easily leveled; glides have 3/4" adjustable range.

▶ Locking units equipped with interchangeable core removable locks.

▶ For conference table options, see the Preside® table tops and bases on pages 698-703. Order edge option "K".

▶ **Keyed alike cores must be ordered separately — see model HF23B on page 743.**

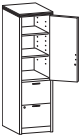

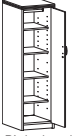
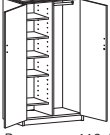
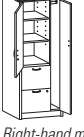
	Description	Model	Ship Weight	Cube	List
 Right-hand model H115297R shown	Storage/File Cabinet (with core removable locks) 18"W x 24"D x 67"H, Hinged Right (shown)	H115297R	262	22.7	\$1804
	18"W x 24"D x 67"H, Hinged Left	H115298L	262	22.7	\$1804
NOTES: Versatile unit features a storage cabinet and two file drawers. Storage cabinet includes three shelves, two are adjustable in 2 1/2" increments. Door hinged left or right models available. File drawers operate on ball-bearing suspensions with full extension. File drawers have high sides to accept hanging folders in letter or legal size. Drawers standard with hangrails. Both the storage cabinet and the file drawers are equipped with an interchangeable core removable lock. Unit height is designed to match credenza or return plus stack-on storage height.					
 Doors open 110 degrees from closed position.	Storage Cabinet/Lateral File (with core removable lock) 36"W x 24"D x 67"H	H115293	373	41.0	\$2339
	NOTES: Storage cabinet is standard with one fixed and two full-width adjustable shelves in top compartment; adjustable shelves can be removed. Overall storage compartment measures 31 1/4"W x 22"D x 36 1/8"H and will accommodate supplies, books and binders, as well as business machines and electronic equipment. Cord pass-through gap behind shelves and grommet in back of cabinet to facilitate routing cords and reaching wall electrical outlets. Two drawer lateral file on bottom. Lateral file comes with mechanical interlock and hangrails. Cabinet and lateral file lock independently. Unit height is designed to match credenza or return plus stack-on storage height.				
 Doors open 110 degrees from closed position.	Storage Cabinet w/Doors (with core removable lock) 36"W x 24"D x 67"H	H115299	349	41.0	\$2089
	NOTES: Large capacity storage area includes five, full-width (side-to-side) shelves; three are adjustable in 2 1/2" increments. Unit height matches credenza or return plus stack-on storage height.				
 Right-hand model H115295R shown	Personal Wardrobe/Storage Cabinet (with core removable lock) 18"W x 24"D x 67"H, Hinged Right (shown)	H115295R	227	22.9	\$1559
	18"W x 24"D x 67"H, Hinged Left	H115296L	227	22.9	\$1559
NOTES: Unit is standard with four adjustable shelves, coat rod, and core removable lock. Shelves adjust in 2 1/2" increments. Unit height is designed to match credenza or return plus stack-on storage height. Cabinet can be used as a wardrobe by removing four adjustable shelves. Coat rod can be removed from cabinet for storage only applications.					
 Doors open 110 degrees from closed position.	Personal Wardrobe/Storage Cabinet (with core removable lock) 36"W x 24"D x 67"H	H11530	349	41.0	\$2285
	NOTES: Spacious design is standard with four adjustable shelves (one shelf is fixed), coat rod and core removable lock which locks both doors. Shelves adjust in 2 1/2" increments. Unit height is designed to match credenza or return plus stack-on storage height.				
 Right-hand model H115301R shown	Personal Storage Tower (with core removable locks) 24"W x 24"D x 67"H, Wardrobe Hinged Right, Storage Cabinet Hinged Left (shown)	H115301R	304	27.9	\$2285
	24"W x 24"D x 67"H, Wardrobe Hinged Left, Storage Cabinet Hinged Right	H115302L	304	27.9	\$2285
NOTES: Spacious design includes a wardrobe closet, storage cabinet, and two file drawers in one compact unit. Wardrobe closet contains a coat rod. Storage cabinet includes three shelves, two are adjustable in 2 1/2" increments. Door hinged left or right models available. File drawers operate on ball-bearing suspensions with full extension. File drawers have high sides to accept hanging folders in letter or legal size. Drawers standard with hangrails. Equipped with interchangeable core removable locks. Upper lock secures storage cabinet and wardrobe closet doors; lower lock secures file drawers. Unit height is designed to match credenza or return plus stack-on storage height.					

NOTE: See pages 161 through 171 for shared components.

How to specify	1st Option	2nd Option	3rd Option
Select Model Number from above	Select Edge Profile See page 152	Select Handle Option See page 152	Select Laminate See pages 48-49
H 1 1 5 2 9 7 R .	A .	C .	N N

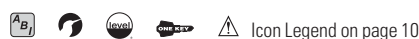

Valido® Shared Components & Accessories

GSA SIN 711-2



- ▶ Choose from square or rounded versions of the end cap bookshelves.
- ▶ End cap bookshelf units are ideal for books, photos and mementos.
- ▶ End Cap Bookcases are designed to be positioned at the end of 24"D credenzas and returns.
- ▶ Adjustable hex leveling glides allow floor-standing furniture to be easily leveled; glides have 3/4" adjustable range.
- ▶ End cap bookshelf units are ideal for books, photos and mementos.
- ▶ For conference table options, see the Preside® table tops and bases on pages 698-703. Order edge option "K".



	Description	Model	Ship Weight	Cube	List
 H11552 shown	Bookcase				
	36"W x 13 1/8"D x 29 5/8"H, 2-Shelf	H11552	94	10.2	\$ 571
	36"W x 13 1/8"D x 43 3/8"H, 3-Shelf	H11553	126	15.6	\$ 667
	36"W x 13 1/8"D x 57 1/8"H, 4-Shelf	H11554	160	20.3	\$ 795
	36"W x 13 1/8"D x 71"H, 5-Shelf	H11555	191	25.3	\$ 897

NOTES: Fixed shelves. Inside shelf dimensions on all units is 33 3/4"W x 12"D x 13"H. No assembly required.
SPECIFYING EXAMPLE: H11552.A.NN

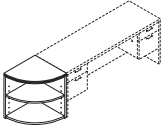
	End Cap Bookshelf				
	24"W x 24"D x 29 1/2"H (2 shelves, 1 fixed, 1 adjustable. Adjusts in 2 1/2" increments with a total range of 10"H)	H115520 E♦A	87	2.6	\$ 668

NOTES: Unit is freestanding. Designed to be positioned at the end of 24"D credenzas and returns. Holds books and personal items.
SPECIFYING EXAMPLE: H115520.A.NN

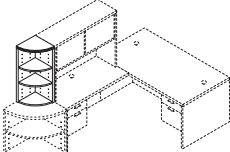
	End Cap Bookshelf				
	15"W x 15"D x 37 1/2"H (3 shelves, 1 fixed, 2 adjustable. Adjusts in 2 1/2" increments with a total range of 25"H)	H115523 E♦A	54	2.2	\$ 591

NOTES: Unit is designed to be positioned at the end of stack-on storage and on top of model H115520. Combined height of models H115520 and H115523 matches credenza plus stack-on storage height. Can be used freestanding.
SPECIFYING EXAMPLE: H115523.A.NN

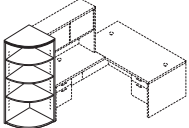
	End Cap Bookshelf				
	24"W x 24"D x 67"H	H115524 E♦A	167	4.8	\$1063

NOTES: Designed to be positioned at the end of 24"D credenzas with stack-on storage, 24"D returns with stack-on storage, 24"D storage/file cabinet, 24"D storage cabinet/lateral file, 24"D wardrobe/storage cabinets, or the 24"D personal storage tower. Unit has four shelves, three are adjustable in 2 1/2" increments, with a total range of 45"H; bottom shelf is fixed.
SPECIFYING EXAMPLE: H115524.A.NN

 Model H115525R	 Model H115526L	Square End Cap Bookshelf — 2-Fixed Shelves				
		24"W x 24"D x 29 1/2"H, Right	H115525R E♦A	98	3.7	\$ 658
		24"W x 24"D x 29 1/2"H, Left	H115526L E♦A	98	3.7	\$ 658

SPECIFYING EXAMPLE: H115525R.A.NN

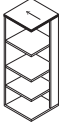
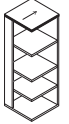
 Model H115527R	 Model H115528L	Square End Cap Bookshelf — 4-Fixed Shelves				
		24"W x 24"D x 67"H, Right	H115527R E♦A	178	11.4	\$1019
		24"W x 24"D x 67"H, Left	H115528L E♦A	178	11.4	\$1019

SPECIFYING EXAMPLE: H115527R.A.NN

NOTES: Units are freestanding. Designed to be positioned next to 24"D models or as a corner bookcase.
 End cap, left: grain direction on top aligns with grain direction on tops of left pedestal returns and left credenza models or when positioned to the left side of credenzas with doors or kneespace models.
 End cap, right: grain direction on top aligns with grain direction on tops of right pedestal returns and right credenza models or when positioned to the right side of credenzas with doors or kneespace models.

NOTE: See pages 161 through 171 for shared components.

How to specify	1st Option	2nd Option
Select Model Number from above	Select Edge Profile	Select Laminate
See page 152	See page 152	See pages 48-49
H 1 1 5 5 2 7 .	A .	N N

E♦A Icon Legend on page 10

► Two welcoming reception station designs to choose from — stack-on enclosure or full-to-floor shell.

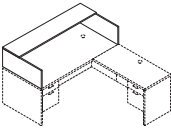
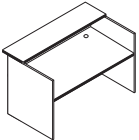
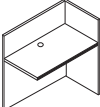
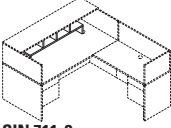

	Description	Model	Ship Weight	Cube	List
	Reception Station with Transaction Counter for 72"W x 36"D Desk, or Desk Shell, with rectangle top 72"W x 36"D x 14 ⁵ / ₈ "H NOTES: For desk tops without grommets, see field installable grommet kit, model HFLDGRMT or HFLDGRMT3 on page 747. Transaction counter organizer (HTCOL52) fits under/inside of transaction counter (see below).	H115720 E♦A	100	3.0	\$ 635
	Reception Station for 42"W x 24"D Return or Return Shell 42"W x 24"D x 13"H Reception Station for 48"W x 24"D Return or Return Shell 48"W x 24"D x 13"H NOTES: For return tops without grommets, see field installable grommet kit, model HFLDGRMT or HFLDGRMT3 on page 747. ▲ Not available in two tone laminate.	H105722 E♦A H105721 E♦A	21 25	1.0 3.6	\$ 233 \$ 265
	Reception Desk Shell 72"W x 39 ⁷ / ₈ "D x 44 ¹³ / ₁₆ "H NOTES: Non-handed design. Integrated 18 ⁵ / ₈ "D transaction counter with a 4" full-width overhang. Two cord management grommets in top for routing and hiding wires and cables. Transaction counter organizer (HTCOL52) fits under/inside of transaction counter.	H115724 E♦A	328	16.8	\$1273
	Reception Return Shell 42"W x 24"D x 43 ⁵ / ₁₆ "H NOTES: Non-handed design. Attaches to reception desk shell to form an L-shaped workstation. One cord management grommet in top for routing and hiding wires and cables. Wood-grain on approach side is vertical to match grain direction on end panels of reception desk.	H115726 E♦A	140	16.8	\$ 827
	Transaction Counter Organizer 48 ³ / ₄ "W x 11 ¹ / ₈ "D x 13"H NOTES: Fits under reception station with transaction counter model H115720 or reception desk shell H115724. ▲ Black only.	HTCOL52 E♦A	24	1.1	\$ 252

SIN 711-8

SIN 711-8

NOTE: See pages 161 through 171 for shared components.

How to specify	Select Model Number from above H 1 1 5 7 2 4 .	1st Option Select Edge Profile See page 152 A .	2nd Option Select Laminate See pages 48-49 N N
----------------	---	---	--



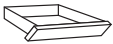
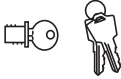
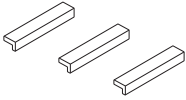
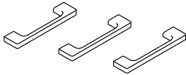

- ▶ Linear and Arch field installable handles attach using Valido® 96mm (approx. 3/4") hole spacing. No drilling required.
- ▶ Center drawers ideal for pens, pencils and other miscellaneous storage. Feature ball-bearing slide suspension.
- ▶ For conference table options, see the Preside® table tops and bases on pages 698-703. Order edge option "K".

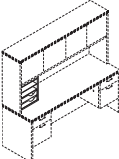
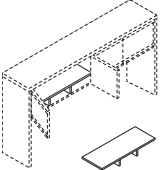
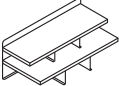
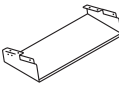
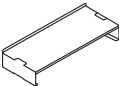
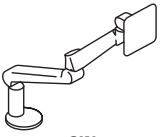

Description	Model	Ship		List
		Weight	Cube	
 Angled Wood Center Drawer 26" x 15 5/8" 22" x 15 5/8" Refer to page 751 for Center Drawer compatibility information SIN 711-1, 711-2, 711-11	H1526	12.0	1.2	\$ 182
	H1522	11.0	1.1	\$ 168
NOTES: Specify laminate for drawer.				
 Black Removable Lock Core Kit — see page 743. NOTES: Lock with a removable cylinder that can be interchanged as needed; allows users to access all furniture pieces in an office with a single key for convenience and security. Makes re-keying quick and easy. For use in all Valido® Series product lock cores, except the stack-on and wall mounted storage "K" models. For the latter, use lock core kit model HF27B. SIN 711-2	HF23B	0.1	0.1	\$ 28
 Field Installable Drawer/Door Handle Kits (fit Valido® 96mm hole spacing) Linear, Black, 2-pack Linear, Matte Chrome, 2-pack Linear, Black, 3-pack Linear, Matte Chrome, 3-pack NOTES: The Linear and Arch handles attach using the same 96mm hole spacing as the Valido® Sweep and Crescent handles. The Linear handle is not recommended for use on the Valido® Narrow/Box/Box/File Modular Pedestal — model H115093.  Arch, Black, 2-pack Arch, Matte Chrome, 2-pack Arch, Black, 3-pack Arch, Matte Chrome, 3-pack SIN 711-8	HLINEARA2	0.4	0.3	\$ 49
	HLINEARC2	0.4	0.3	\$ 49
	HLINEARA3	0.5	0.3	\$ 57
	HLINEARC3	0.5	0.3	\$ 57
	HARCHA2	0.4	0.3	\$ 49
	HARCHC2	0.4	0.3	\$ 49
	HARCHA3	0.5	0.3	\$ 57
	HARCHC3	0.5	0.3	\$ 57

Description	Model	Ship Weight	Cube	List by Paint Grade	
				Core	Metallics
 Refer to pages 749-750 for additional product information SIN 711-1, 711-2, 711-11	H1706	16	1.4	\$ 440	
	H2107	16	1.3	\$ 472	
	H2516	17	1.6	\$ 551	
	H4022	10	0.6	\$ 194	
	HE4022	12	0.7	\$ 278	
	H4028	11	1.5	\$ 140	\$ 150
	H4029	11	1.5	\$ 125	\$ 135

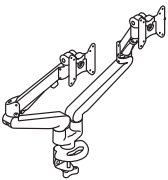





	Description	Model	Ship Weight	Cube	List
 <p>Not available in two-tone laminates SIN 711-8</p>	<p>Vertical Paper Manager 14⁷/₈"W x 10⁷/₈"D x 19¹/₁₆"H</p> <p>NOTES: Keeps papers, files, and books neatly organized and within easy reach from a seated position. Designed for desk, credenza, and return tops. Fits under stack-on storage models. Two pullout drawers and three fixed shelves. ⚠ When used in conjunction with wall mounted storage cabinets, the top of the wall mounted storage cabinets must be positioned a minimum of 68⁷/₈" above the floor. SPECIFYING EXAMPLE: HLVPM1.N</p>	HLVPM1	27	2.8	\$ 298
	<p>Stacked Paper Management 32¹/₂"W x 12⁵/₈"D x 4¹/₄"H</p> <p>NOTES: Segments and organizes stack-on and wall mount storage compartments, as well as bookcase shelves. Unit can be used in Models H115327, H11534, H115322, H115321, H115382 and H115381. In some cases, installation may require removing the stack-on or wall mount storage doors. ⚠ Black (P) only.</p>	HLVPM2 E◆A	22	1.25	\$ 144
 <p>Not available in two-tone laminate</p>	<p>Desktop Storage Terrace 26¹/₂"W x 12¹/₂"D x 10¹/₂"H</p> <p>NOTES: Keeps work-in-process, priority files, loose pages, and mail neatly organized and in view. Mixed material design comprised of sturdy laminate shelves with metal back and support panels. Not available in two-tone laminate combination or pattern laminate colors. Choose from Platinum Metallic (T1), Black (P), and Charcoal (S) for the metal components. Sized to fit in stack-on and wall mounted storage cabinets in 10500, 10700, Valido, 94000, Park Avenue Laminate, and 38000 Series. Fits in Voi stack-on and overhead cabinets except for 48"W or smaller sliding door models. Specify: Model.Laminate.Paint SPECIFYING EXAMPLE: HLDST1.N.T1</p>	HLDST1 E◆A	24	1.1	\$ 272
	<p>Hanging Paper Shelf 28¹/₁₆"W x 11¹/₁₆"D x 4⁵/₁₆"H</p> <p>NOTES: Maximizes worksurface space; de-clutters desktop while placing priority communications and active project folders within easy reach. Angled design allows contents to be distinguished at a glance. Mixed material styling features strong painted metal frame with a frosted shelf. Attaches quickly and easily to stack-on and wall mount storage models in the following series: 10500, 10700, Valido, Park Avenue Laminate, 94000, Pennsylvania Avenue, and Voi (except the 36"W overhead hutch with O-legs or panel mount brackets). Not for use with 38000 Series. Choose from Platinum Metallic (T1), Black (P), and Charcoal (S) paint. Specify: Model.Paint SPECIFYING EXAMPLE: HHPS1.T1</p>	HHPS1	7	2.9	\$ 175
	<p>Desktop Paper Shelf 28¹/₁₆"W x 11⁵/₈"D x 5"H</p> <p>NOTES: Organizer shelf provides a place and space for work-in-process and piling to keep worksurfaces neat and tidy. Convenient, scalable design with interlocking side supports allow two units to be stacked and integrated. Durable painted metal frame with a frosted shelf; mixed material styling matches hanging paper shelf. Can also be used inside select overhead storage, including the following stack-on with hinged door models: 10500 and Valido 36", 42", 66", 72", 78"W and 10700 68⁵/₈"W. Choose from Platinum Metallic (T1), Black (P), and Charcoal (S) paint. Specify: Model.Paint SPECIFYING EXAMPLE: HDPS1.T1</p>	HDPS1	7	2.9	\$ 175
 <p>H5210 SIN 711-1, 711-2</p>	<p>Single Monitor Arm Effortless adjustment, no levers. Range of adjustment is 13" from 6¹/₂"-19¹/₂".</p>	H5210	11 	1.3	\$ 497
 <p>H5220</p>	<p>Dual Monitor Arm Single Mount with Dual Monitor effortless adjustment. Range of adjustment is 13" from 6¹/₂"-19¹/₂". NOTES: Available in Silver only, no specification needed. For complete monitor arm features, see page 745.</p>	H5220	15 	1.8	\$ 889

How to specify	<p>Select Model Number from above</p> <p>H L V P M 1 .</p>	<p>1st Option</p> <p>Select Laminate</p> <p>See pages 48-49</p> <p>N</p>
----------------	---	---

Icon Legend on page 10

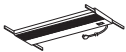
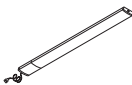
- ▶ Task lights are designed for use with stack-on storage and wall mounted storage cabinets.
- ▶ Task lights feature a new slim profile and electronic ballast for increased energy efficiency.
- ▶ For conference table options, see the Preside® table tops and bases on pages 698-703. Order edge option "K".





	Description	Model	Ship			List
			Weight	Cube		
 Refer to page 376 Open Market	Recessed Task Light					
	46½"W x 3¼"D x 1⅞"H for Models H115327, H11534, H11533 and H115324	HH870960	12.0 [S]	1.1	\$ 240	
	34⅝"W x 3¼"D x 1⅞"H for Models H115323, H115322, H115382 and H115383	HH870942	10.0 [S]	0.9	\$ 222	
	22⅞"W x 3¼"D x 1⅞"H for Models H115321, H115380 and H115381	HH870930	7.0 [S]	0.6	\$ 205	
 SIN 711-1	LED Task Lights					
	17" LED Light with Power Supply (Single)	HLED17AS	1.2 [S]	0.05	\$ 374	
	31" LED Light with Power Supply (Single)	HLED31AS	1.5 [S]	0.09	\$ 503	
	17" LED Light with Power Supply for Daisy-chain (Starter)	HLED17A	1.0 [S]	0.05	\$ 411	
	31" LED Light with Power Supply for Daisy-chain (Starter)	HLED31A	1.4 [S]	0.09	\$ 553	
	17" LED Light with 8" Jumper Cord for Daisy-chain (Follower)	HLED17AUO	1.0 [S]	0.03	\$ 335	
	31" LED Light with 8" Jumper Cord for Daisy-chain (Follower)	HLED31AUO	1.0 [S]	0.05	\$ 448	
Undercabinet Occupancy Sensor with 1" End to End Connector	HLEDOSA	0.2 [S]	0.01	\$ 78		
NOTES: To use the daisy chain application, must start with model HLED17A or HLED31A. No finish specification required. Attaches magnetically to underside of overhead storage, or attaches with provided screws or double-sided tape. Occupancy sensor attaches to a single or starter LED light and will automatically turn the light off after no motion is detected for 30 minutes. Just like all the LED light models, the occupancy sensor features a soft-touch on/off switch. LED task lights have a lifetime of 50,000 hours and have a dimmer feature that allows the user to adjust the amount of light output.						
 SIN 711-1	LED Task Lights					
	Articulating Desk Lamp	HLED1	1.2 [S]	6.5	\$ 350	
	Articulating Desk Lamp w/ Occupancy Sensor	HLED10C	1.2 [S]	6.5	\$ 428	
 SIN 711-1	Task Desk Lamp	HLED2	0.7 [S]	3.0	\$ 303	
 Black only SIN 711-8	Field installable grommet	HFLDGRMT	0.1 [S]	0.01	\$ 28	
	<ul style="list-style-type: none"> • Grommet is field installable. • Grommet shape is round. • Includes grommet cap and sleeve. <ul style="list-style-type: none"> • Grommet cap measures 3" diameter and includes a ¾" diameter cord access hole. • Grommet sleeve measures 2½" O.D. x ¾" thick. • Includes instructions to locate grommet position for desks, credenzas, returns and bridges. <p>▲ Designed to be used in top and end panels to route/hide cords, and in modesty panels to facilitate reaching wall electrical outlets.</p> <p>▲ Black Finish</p> <p>▲ Requires a 2½" diameter hole saw and drill for installation (not included).</p>					
 SIN 711-8	Field Installable Grommet	HFLDGRMT3	0.1 [S]	0.3	\$ 28	
	<ul style="list-style-type: none"> • Grommet is field installable. • Includes grommet cap and sleeve. <ul style="list-style-type: none"> • Grommet outside dimensions measure 3½" diameter and includes two cord access holes. • Grommet sleeve measures 3" O.D. x 1" thick. • Includes instructions to locate grommet position for desks, credenzas, returns and bridges. <p>▲ Designed to be used in top and end panels to route/hide cords, and in modesty panels to facilitate reaching wall electrical outlets.</p> <p>▲ Black Finish</p> <p>▲ Requires a 3" diameter hole saw and drill for installation (not included).</p>					

NOTE: See pages 161 through 171 for shared components.

How to specify	Select Model Number from above H H 8 7 0 9 6 0 .	1st Option Select Color Available in Black (P) only P
----------------	--	---

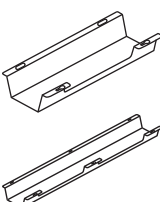

	Description	Model	Ship Weight	Cube	List
 SIN 71-302	Power Hub, 3" Grommet Mount <ul style="list-style-type: none"> Fits in 3" round grommet holes on the following product lines: 10500, 10700, Concinnity, Coordinate, Pennsylvania Avenue, and Voi desks; Abound Worksurfaces; Huddle and Motivate tables and SmartLink. Two grounded AC power outlets. Includes 6' cord with three-prong plug. Two cord pass-through holes in cap. Field installed; easy plug-and-play. UL Listed. <p>△ Available in black only (no color designation so use .X – Specify: HGRMTAC.X).</p>	HGRMTAC	1.3	0.2	\$ 100
 SIN 71-302	<p><i>Open Market</i></p> Power/USB Hub, 3" Grommet Mount <ul style="list-style-type: none"> One grounded AC power outlet with 2 USB ports. Two cord pass-through holes in cap. Includes 6' cord with three-prong plug. Field installed; easy plug-and-play. UL Listed. <p>△ Available in black only (no color designation so use .X – Specify: HGRMTUSB2.X).</p>	HGRMTUSB2	1.3	0.02	\$ 198
 SIN 711-1	Cable Management Troughs <ul style="list-style-type: none"> 17"W — Single 17"W — 10-Pack 36"W — Single 36"W — 10-Pack Cable management troughs ship flat packed. The troughs attach to underneath the worksurface with screws. The 17"W has one wire access cut out on the user side. The 36" has two wire access cut outs. These cut outs give users access to inside the trough without having to detach it from the worksurface. Color: Graphite. Material: Metal. TAA Compliant. 	HCTROUGH17 HCTROUGH1710 HCTROUGH36 HCTROUGH3610	2.7 14.0 4.9 30.0	0.5 0.5 0.9 0.9	\$ 60 \$ 568 \$ 101 \$ 959







How to specify

Select Model Number from above

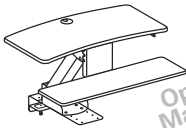
H | G | R | M | T | A | C

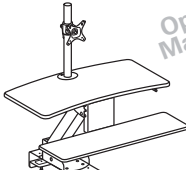
Icon Legend on page 10

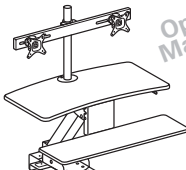
- ▶ These products are designed to allow the user to transition from seating position to standing position throughout the workday.
 - ▶ Gas-assist lever-operated mechanism with positive stop.
 - ▶ Clamp mount compatible with worksurfaces depths of 20"-30".
 - ▶ Clamp requires 3.5" of clearance along back edge of worksurface.
 - ▶ Black seamless worksurfaces.
 - ▶ Silver powder coated metal components.
 - ▶ Lowers below worksurface level on 24" and 30"D worksurfaces.
 - ▶ All models contain a large primary worksurface and a smaller keyboard / mouse surface.
 - ▶ Beveled edges for sleek appearance and comfort while typing.
 - ▶ Monitor arms include height, width, and swivel adjustment.
- ⚠ **Not recommended for use on mobile (castered) worksurfaces.**

	Description	Model	Ship Weight	Cube	List
	Directional™ Desktop Sit-to-Stand Device NOTES: Does not include a monitor arm and is suitable for laptops and/or monitors on their original stands.	HS1100	60 	3.2	\$ 525
	Directional™ Desktop Sit-to-Stand Device with Single Monitor Arm NOTES: Includes a monitor arm for a single monitor.	HS1101	62 	3.2	\$ 615
	Directional™ Desktop Sit-to-Stand Device with Dual Monitor Arm NOTES: Includes a monitor arm for dual monitors.	HS1102	63 	3.2	\$ 700

Mounting and Compatibility:

- This product is intended to be installed on commercial-grade worksurfaces in good condition.
- Compatible with freestanding worksurfaces 24"-30"D or panel-supported worksurfaces 24"-30"D.
- Not for use on mobile worksurfaces.

Clamp Mount

Use when 3.5" minimum overhang is available

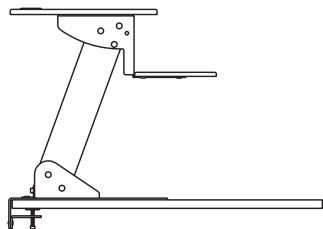

Screw Mount

Use when no overhang is available. Worksurface must be minimum 1" thick.

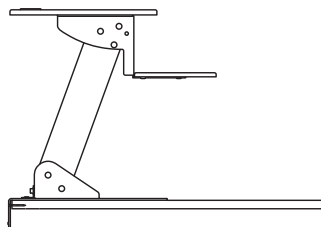

How to specify

Select Model Number from above

H S 1 1 0 0

  Icon Legend on page 10

		Voi® Worksurfaces	Chassis/Cabinet	Drawer/Door Fronts	Grommets	Cubes/Drawer Organizer	0-Legs, Post Legs, Brackets, Shared Legs	Pulls	Laminate End Panels, Layering Shelves and Modesty Panels
L1 LAMINATES		CODES							
Woodgrain	Bourbon Cherry	H	•	•	•				•
	Cognac	COGN	•	•	•				•
	Harvest	C	•	•	•				•
	Mahogany	N	•	•	•				•
	Mocha	MOCH	•	•	•				•
	Natural Maple	D	•	•	•				•
	Pinnacle	PINC	•	•	•				•
	Shaker Cherry	F	•	•	•				•
Patterned	Sheer Mesh*	A5	•						
	Silver Mesh**	B9	•						
Solid	Black	P	•	•	•				•
	Brilliant White	WHIT	•	•	•				•
	Charcoal	S	•	•	•				•
	Loft	LOFT	•	•	•				•
L2 LAMINATES***		CODES							
Woodgrain	Lowell Ash <i>NEW! 1/30/2017</i>	LLA1	•	•	•				•
	Natural Recon <i>NEW! 1/30/2017</i>	LNR1	•	•	•				•
	Phantom Ecru <i>NEW! 1/30/2017</i>	LPE1	•	•	•				•
	Portico Teak <i>NEW! 1/30/2017</i>	LPT1	•	•	•				•
	Skyline Walnut <i>NEW! 1/30/2017</i>	LSW1	•	•	•				•
PAINTS / GROMMETS		CODES							
Core	Black	P			•	•	•		
	Charcoal	S				•			
	Greige	T5			•	•			
	Light Gray	Q				•			
	Loft	LOFT				•			
	Muslin	T3				•			
	Putty	L				•			
Cube	Shadow	SHDW				•			
	Autumn	AUTM				•			
	Citron	CITR				•			
	Flame	FLAM				•			
	Pool	POOL				•			
Metallic	Sisal	SISL				•			
	Brilliant White	WHIT			•	•	•		
	Champagne Metallic	T4				•	•		
Platinum Metallic	T1			•	•	•			
EDGE BAND		CODES							
	Bourbon Cherry	H	•						
	Brilliant White	WHIT	•						
	Cognac	COGN	•						
	Harvest	C	•						
	Loft	LOFT	•						
	Lowell Ash <i>NEW! 1/30/2017</i>	DL	•						
	Mahogany	N	•						
	Mocha	MOCH	•						
	Muslin	T	•						
	Natural Maple	D	•						
	Natural Recon <i>NEW! 1/30/2017</i>	NR	•						
	Phantom Ecru <i>NEW! 1/30/2017</i>	PE	•						
	Pinnacle	PINC	•						
	Portico Teak <i>NEW! 1/30/2017</i>	DP	•						
	Shadow	SHDW	•						
	Shaker Cherry	F	•						
	Skyline Walnut <i>NEW! 1/30/2017</i>	SW	•						

WORKSURFACE LAMINATES CODES	EDGE BAND OPTIONS						
	Matching Edge	Brilliant White (WHIT)	Loft (LOFT)	Muslin (T)	Shadow (SHDW)	Black (P)	Charcoal (S)
Black	P					•	
Bourbon Cherry	H	•	•	•			
Brilliant White	WHIT		•				
Charcoal	S						•
Cognac	COGN	•	•	•			
Harvest	C	•	•	•			
Loft	LOFT			•			
Lowell Ash	LLA1	•	•	•	•		
Mahogany	N	•		•		•	
Mocha	MOCH	•	•	•			
Natural Maple	D	•	•	•	•		
Natural Recon	LNR1	•	•	•	•		
Phantom Ecru	LPE1	•	•	•	•		
Pinnacle	PINC	•	•	•	•		
Portico Teak	LPT1	•	•	•	•		
Shaker Cherry	F	•	•	•	•	•	
Sheer Mesh	A5				•		
Silver Mesh	B9			•			
Skyline Walnut	LSW1	•	•	•	•		

* Sheer Mesh laminate will have Muslin Edgeband.

** Silver Mesh laminate will have Loft Edgeband.

*** Storage chassis that are specified in L2 laminates and are longer than 60"W will ship with back panels that are horizontal grain.

Voi® Laminate Typical

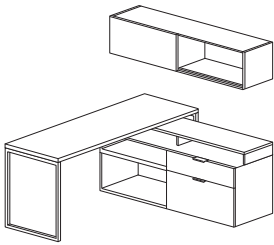

Small Footprint
66" x 60"

Qty.	Model #	Description	List Price	Price Extension
1	HLSLZ5SC66	External Channel 54"W	\$ 90	\$ 90
1	HLSLR2466	Rectangle Worksurface 24"D x 66"W	\$ 336	\$ 336
1	HLSL2060LR2	Low credenza (Right hand drawers) 60"W x 20"D x 21½"H	\$1,131	\$1,131
1	HLSL1460LS	Layering shelf 60"W x 14¼"D x 5¼"H	\$ 321	\$ 321
2	HLSL24280	O-Leg Support for Worksurface (1 pack) 24"D x 28½"H	\$ 279	\$ 558
1	HLSL1460S	Overhead Cabinet with Wall Bracket with One Sliding Door 60"W x 14¼"D x 14"H	\$1,177	\$1,177
TOTAL:			\$3,613	

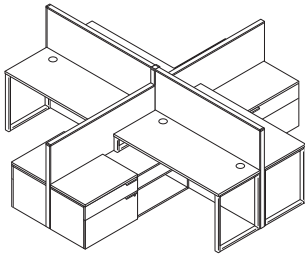

Open Plan
120" x 120"

Qty.	Model #	Description	List Price	Price Extension
4	HLSLZ5SC60	External Channel 48"W	\$ 87	\$ 348
2	HETP4260FP	Accelerate® Raceway Panels 42½"H x 60"W	\$ 383	\$ 766
2	HETP5060FP	Accelerate® Raceway Panels 50"H x 60"W	\$ 426	\$ 852
2	HH871260	Electrical Power Harness, 3-1 & 2-2 60"W	\$ 194	\$ 388
4	HH871503	Duplex Receptacle Circuit 3, 3-1	\$ 37	\$ 148
1	HH879072	Power Infeed	\$ 206	\$ 206
2	HLSL2060LR2	Low credenza (Right hand drawers) 60"W x 20"D x 21½"H	\$1,131	\$ 2,262
2	HLSL2060LL2	Low credenza (Left hand drawers) 60"W x 20"D x 21½"H	\$1,131	\$ 2,262
4	HLSL2030CH2	Credenza Cushion 20"W x 30"D x 1"H	\$ 328	\$ 1,312
4	HLSL24280	O-Leg Support for Worksurface (1 pack) 30"D x 28½"H	\$ 279	\$ 1,116
2	HLSLPBL	Left O-Leg to panel bracket	\$ 87	\$ 174
2	HLSLPBR	Right O-Leg to panel bracket	\$ 87	\$ 174
4	HETC60	Accelerate® Top Cap 60"W	\$ 70	\$ 280
2	HECVH07P	Accelerate® Variable Height Finishing Kit	\$ 44	\$ 88
2	HEFEC50P	Accelerate® Finished End Cover 50"H	\$ 48	\$ 96
2	HEFEC42P	Accelerate® Finished End Cover 42½"H	\$ 45	\$ 90
1	HEC50PX	Accelerate® "X" Connector 50"H	\$ 125	\$ 125
4	HLSL2470	O-Leg Support for Worksurface 24"D x 7"H	\$ 188	\$ 752
4	HLSLR2460	Rectangle Worksurface 24"D x 60"W	\$ 309	\$ 1,236
TOTAL:			\$12,675	

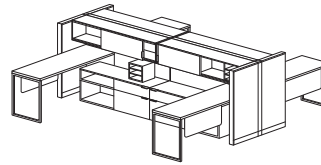

Open Plan
144" x 144"

Qty.	Model #	Description	List Price	Price Extension
4	HLSLR2472	Rectangle Worksurface 24"D x 72"W	\$ 347	\$ 1,388
2	HLSL2060LR2	Low credenza (Right hand drawers) 60"W x 20"D x 21½"H	\$1,131	\$ 2,262
2	HLSL2060LL2	Low credenza (Left hand drawers) 60"W x 20"D x 21½"H	\$1,131	\$ 2,262
4	HLSL24280	O-Leg Support for Worksurface (1 pack) 24"D x 28½"H	\$ 279	\$ 1,116
4	HLSL1472S	Overhead Cabinet - Sliding 72"W x 14¼"D x 14"H	\$1,239	\$ 4,956
4	HLSLPMB	Stack-on Storage Panel Mounted Bracket (3 pack)	\$ 114	\$ 456
4	HLSL1212	Storage Cube 12" x 12"	\$ 269	\$ 1,076
4	HLSL4214MM	Mixed Material Floating Modesty Panel 42"W x 14"H	\$ 716	\$ 2,864
6	HRVF6524P	Abound® Panel Frame 65"H x 24"W	\$ 249	\$ 1,494
4	HRVT6024E	Abound® Power/Data Fabric Tile 60"H x 24"W	\$ 208	\$ 832
8	HRVT6024T	Abound® Fabric Tile 60"H x 24"W	\$ 149	\$ 1,192
2	HRVF6548P	Abound® Panel Frame 65"H x 48"W	\$ 284	\$ 568
4	HRVT6048T	Abound® Fabric Tile 60"H x 48"W	\$ 232	\$ 928
4	HRVC65PF	Finished End Painted 65"	\$ 87	\$ 348
2	HRVC65PT	"T" Connector Painted 65"	\$ 144	\$ 288
1	HH879072	Power Infeed	\$ 206	\$ 206
4	HH873504	Duplex Receptacle Circuit 1	\$ 37	\$ 148
6	HH873502	Duplex Receptacle Circuit 2	\$ 37	\$ 222
6	HH873503	Duplex Receptacle Circuit 3	\$ 37	\$ 222
4	HH871224	Electrical Power Harness, 3-1 & 2-2 24"W	\$ 185	\$ 740
1	HH871096	Electrical Pass-Thru Power Harness, 3-1 & 2-2 96"W	\$ 184	\$ 184
2	HH871248	Electrical Power Harness, 3-1 & 2-2 48"W	\$ 194	\$ 388
1	HH871366	Up to 30" Vertical Jump 66"	\$ 124	\$ 124
1	HH8988EBN	Electrical Mounting Brackets (Pk of 12)	\$ 56	\$ 56
4	HWSB2	Worksurface Bracket Kit	\$ 40	\$ 160
1	HRVTC96	Abound® Top Cap 96"W	\$ 113	\$ 113
6	HRVTC24	Abound® Top Cap 24"W	\$ 31	\$ 186
TOTAL:			\$24,779	

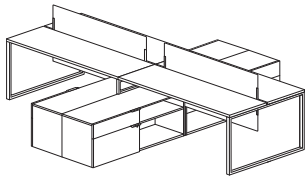

Open Plan
144" x 120"

Qty.	Model #	Description	List Price	Price Extension
4	HLSLZ5SC72	External Channel 60"W	\$ 97	\$ 388
4	HLSLR2472	Rectangle Worksurface 24"D x 72"W	\$ 347	\$ 1,388
2	HLSL247SL	O-Leg Shared Support for Low Credenzas	\$ 234	\$ 468
4	HLSL24280	O-Leg Support for Worksurface (1 pack) 24"D x 28½"H	\$ 279	\$ 1,116
2	HLSL2060LR2	Low credenza (Right hand drawers) 60"W x 20"D x 21½"H	\$1,131	\$ 2,262
2	HLSL2060LL2	Low credenza (Left hand drawers) 60"W x 20"D x 21½"H	\$1,131	\$ 2,262
2	HLSL2860	Above/Below Privacy Screen 60"W x 28½"H	\$1,237	\$ 2,474
TOTAL:			\$10,358	

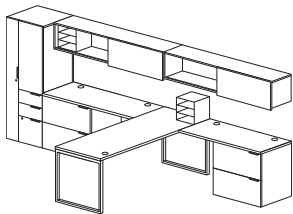

Open Plan
168" x 72"

Qty.	Model #	Description	List Price	Price Extension
1	HLSLW446LP	Personal Storage Tower (Left handed) 24"W x 24"D x 65"H	\$2,311	\$2,311
2	HLSL2430L	Lateral File 30"W x 24"D x 28½"H	\$1,048	\$2,096
1	HLSLR2460	Rectangle Worksurface 24"D x 60"W	\$ 309	\$ 309
1	HLSLR3072	Rectangle Worksurface 30"D x 72"W	\$ 414	\$ 414
1	HLSLR2454	Rectangle Worksurface 24"D x 54"W	\$ 284	\$ 284
2	HLSL30280	O-Leg Support for Worksurface (1 pack) 30"D x 28½"H	\$ 310	\$ 620
2	HLSL1472S	Overhead Cabinet with Wall Bracket with One Sliding Door 72"W x 14¼"D x 13"H	\$1,389	\$2,778
2	HLSL1212	Storage Cube 12" x 12"	\$ 269	\$ 538
1	HLSLZ5SC72	External Channel 60"W	\$ 97	\$ 97
TOTAL:			\$9,447	

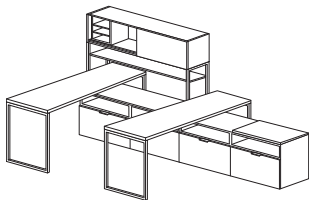

Semi Private
144" x 72"

Qty.	Model #	Description	List Price	Price Extension
2	HLSLZ5SC72	External Channel 60"W	\$ 97	\$ 194
2	HLSLR2472	Rectangle Worksurface 24"D x 72"W	\$ 347	\$ 694
2	HLSL2072LD2	Low credenza (2 file drawers and open top) 72"W x 20"D x 21½"H	\$1,303	\$2,606
1	HLSL1472S	Overhead Cabinet with One Sliding Door 72"W x 14¼"D x 14"H	\$1,239	\$1,239
1	HLSL72S	Shelf for Stack-on Storage 72"W	\$ 262	\$ 262
1	HLSL650S	O-Leg Stack-on Storage Support (2 pack) 65"H	\$ 413	\$ 413
4	HLSL24280	O-Leg Support for Worksurface (1 pack) 24"D x 28½"H	\$ 279	\$1,116
1	HLSL2036CH2	Credenza Cushion 20"W x 36"D x 1"H	\$ 354	\$ 354
1	HLSL1212	Storage Cube 12" x 12"	\$ 269	\$ 269
TOTAL:			\$7,147	

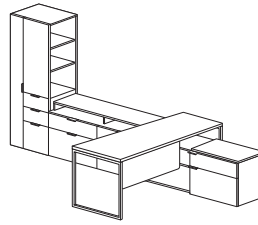

Private Office
144" x 72"

Qty.	Model #	Description	List Price	Price Extension
1	HLSLW046L	Tower (Right hand drawers/Left hand door) 24"W x 20"D x 65"H, Left	\$1,938	\$1,938
1	HLSL1460LS	Layering shelf 60"W x 14½"D x 5½"H	\$ 321	\$ 321
1	HLSLR3072	Rectangle Worksurface 30"D x 72"W	\$ 414	\$ 414
1	HLSL4214MM	Mixed Material Floating Modesty Panel 42"W x 14"H	\$ 716	\$ 716
2	HLSL30280	O-Leg Support for Worksurface (1 pack) 30"D x 28½"H	\$ 310	\$ 620
1	HLSL2060LD4	Low credenza (2 file/2 box) 60"W x 20"D x 21½"H	\$1,320	\$1,320
1	HLSL2060LR2	Low credenza (Open/Right hand drawers) 60"W x 20"D x 21½"H	\$1,131	\$1,131
1	HLSL2030CH2	Credenza Cushion 20"W x 30"D x 1"H	\$ 328	\$ 328
TOTAL:			\$6,788	

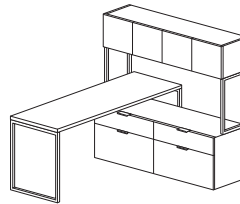

Small Footprint
66" x 60"

Qty.	Model #	Description	List Price	Price Extension
1	HLSLZ5SC66	External Channel 54"W	\$ 90	\$ 90
1	HLSLR2466	Rectangle Worksurface 24"D x 66"W	\$ 336	\$ 336
1	HLSL2060LD4	Low credenza (2 file/2 box) 60"W x 20"D x 21½"H	\$1,320	\$1,320
2	HLSL24280	O-Leg Support for Worksurface (1 pack) 24"D x 28½"H	\$ 279	\$ 558
1	HLSL1460D	Overhead Cabinet with 4 Doors 60"W x 14¼"D x 14"H	\$1,027	\$1,027
1	HLSL650S	O-Leg Support for Overhead Cabinet 14¼"D x 20½"H for 65"H Overhead Cabinet	\$ 413	\$ 413
TOTAL:			\$3,744	

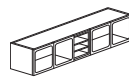

Private Office
102" x 72"

Qty.	Model #	Description	List Price	Price Extension
1	HLSL3028B	Box/Box/File Pedestal Support 30"D x 28"H	\$ 759	\$ 759
1	HLSLR3672	Rectangle Worksurface 36"D x 72"W	\$ 539	\$ 539
1	HLSL2428E	End Panel Support 24"D x 28½"H	\$ 178	\$ 178
1	HLSL3028E	End Panel Support 30"D x 28½"H	\$ 190	\$ 190
1	HLSLR2042	Rectangle Worksurface 20"D x 42"W	\$ 230	\$ 230
1	HLSLR2472	Rectangle Worksurface 24"D x 72"W	\$ 347	\$ 347
1	HLSL4214MM	Mixed Material Floating Modesty Panel 42"W x 14"H	\$ 716	\$ 716
1	HLSL2430L	Lateral File 36"W x 24"D x 28½"H	\$1,048	\$1,048
1	HLSL1472M	Overhead Cabinet - Metal Frame, Glass Doors 72"W x 14¼"D x 14"H	\$2,039	\$2,039
1	HLSL1212	Storage Cube 12" x 12"	\$ 269	\$ 269
TOTAL:			\$6,315	

Voi® Laminate Typicals

HON

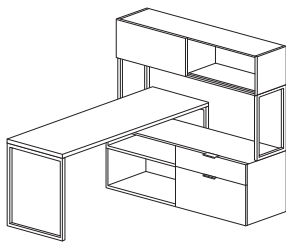
Small Footprint
66" x 60"

Qty.	Model #	Description	List Price	Price Extension
1	HLSLZ5SC66	External Channel 54"W	\$ 90	\$ 90
1	HLSLR2466	Rectangle Worksurface 24"D x 66"W	\$ 336	\$ 336
1	HLSL2060LR2	Low credenza (Right hand drawers) 60"W x 20"D x 21½"H	\$1,131	\$1,131
2	HLSL24280	O-Leg Support for Worksurface (1 pack) 24"D x 28½"H	\$ 279	\$ 558
1	HLSL1460S	Overhead Cabinet with One Sliding Door 60"W x 14¼"D x 14"H	\$1,027	\$1,027
1	HLSL650S	O-Leg Support for Overhead Cabinet 14¼"D x 20½"H for 65"H Overhead Cabinet	\$ 413	\$ 413
TOTAL:			\$3,555	

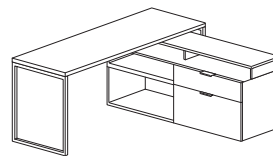
Small Footprint
66" x 60"

Qty.	Model #	Description	List Price	Price Extension
1	HLSLZ5SC54	External Channel 54"W	\$ 82	\$ 82
1	HLSLR2466	Rectangle Worksurface 24"D x 66"W	\$ 336	\$ 336
1	HLSL2060LR2	Low credenza (Right hand drawers) 60"W x 20"D x 21½"H	\$1,131	\$1,131
1	HLSL1460LS	Layering shelf 60"W x 14½"D x 5½"H	\$ 321	\$ 321
2	HLSL24280	O-Leg Support for Worksurface (1 pack) 24"D x 28½"H	\$ 279	\$ 558
TOTAL:			\$2,428	

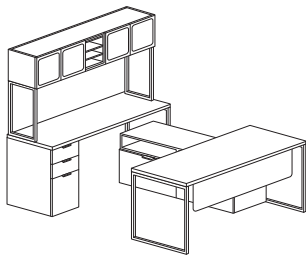
Private Office
92" x 72"

Qty.	Model #	Description	List Price	Price Extension
1	HLSLZ5SC60	External Channel 48"W	\$ 87	\$ 87
1	HLSLR3072	Rectangle Worksurface 30"D x 72"W	\$ 414	\$ 414
1	HLSLR2072	Rectangle Worksurface 20"D x 72"W	\$ 345	\$ 345
1	HLSL2060LD2	Low credenza (2 file drawers) 60"W x 20"D x 21½"H	\$1,237	\$1,237
1	HLSL1472M	Overhead Cabinet - Metal Frame, Glass Doors 72"W x 14¼"D x 14"H	\$1,889	\$1,889
1	HLSL650S	O-Leg Stack-on Storage Support (2 pack) 65"H	\$ 413	\$ 413
1	HLSL20280	O-Leg Support for Worksurface (1 pack) 20"D x 28½"H	\$ 256	\$ 256
2	HLSL30280	O-Leg Support for Worksurface (1 pack) 30"D x 28½"H	\$ 310	\$ 620
1	HLSL2028B	Box/Box/File Pedestal Support 20"D x 28½"H	\$ 609	\$ 609
1	HLSL6014MM	Mixed Material Floating Modesty Panel 60"W x 14"H	\$ 984	\$ 984
1	HLSL1212	Storage Cube 12" x 12"	\$ 269	\$ 269
TOTAL:			\$7,123	

This Specifying Guide is designed to walk you through the steps when choosing the Voi desks elements that will meet your particular workplace needs. From private office to open plan, there are endless combinations that will fit your style and need.

Regardless of the application, Voi presents an integrated, unified aesthetic for the entire workplace.

The step-by-step instructions make it easy to specify elements that personalize workspaces and achieve the right mix of functionality and style.

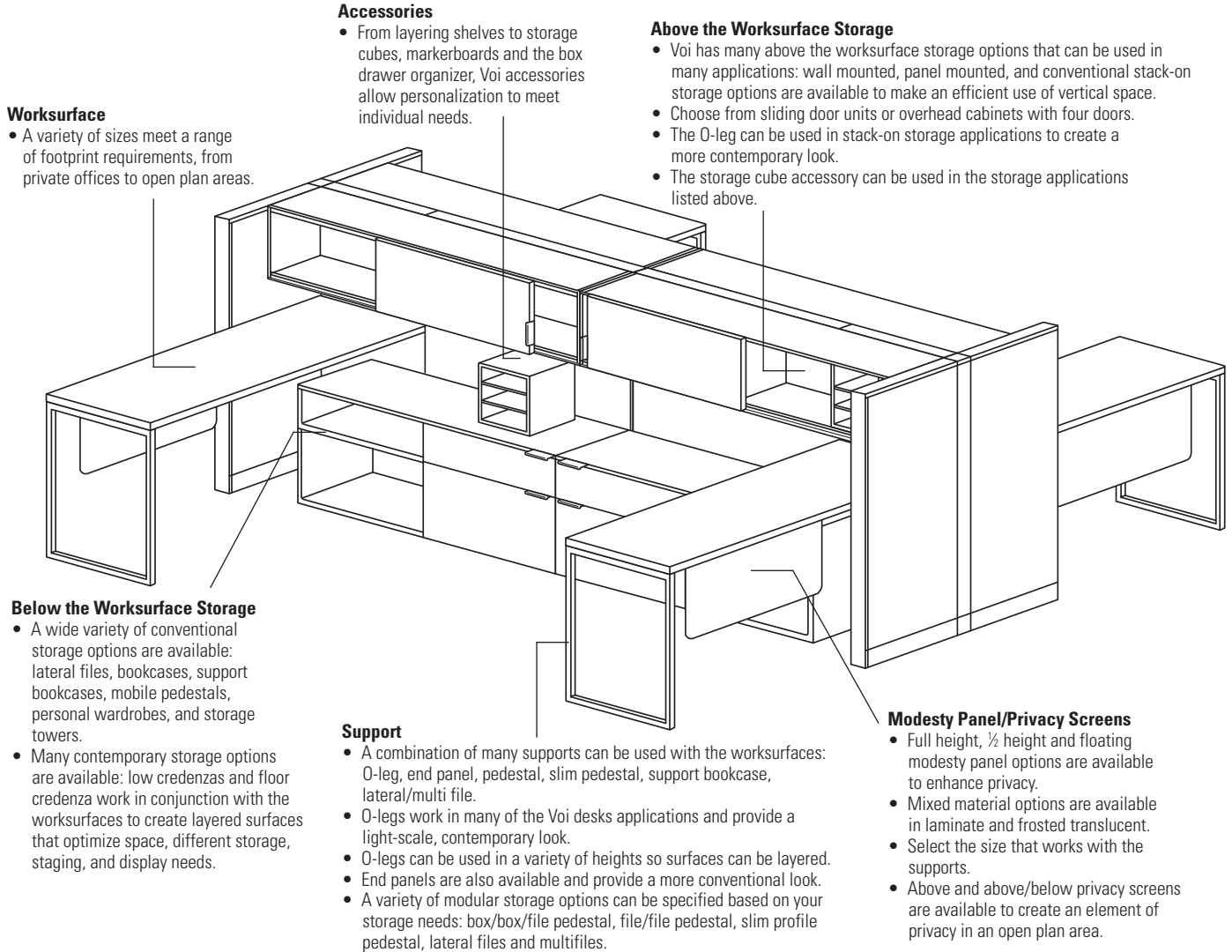

Worksurface

- A variety of sizes meet a range of footprint requirements, from private offices to open plan areas.

Accessories

- From layering shelves to storage cubes, markerboards and the box drawer organizer, Voi accessories allow personalization to meet individual needs.

Above the Worksurface Storage

- Voi has many above the worksurface storage options that can be used in many applications: wall mounted, panel mounted, and conventional stack-on storage options are available to make an efficient use of vertical space.
- Choose from sliding door units or overhead cabinets with four doors.
- The O-leg can be used in stack-on storage applications to create a more contemporary look.
- The storage cube accessory can be used in the storage applications listed above.

Below the Worksurface Storage

- A wide variety of conventional storage options are available: lateral files, bookcases, support bookcases, mobile pedestals, personal wardrobes, and storage towers.
- Many contemporary storage options are available: low credenzas and floor credenza work in conjunction with the worksurfaces to create layered surfaces that optimize space, different storage, staging, and display needs.

Support

- A combination of many supports can be used with the worksurfaces: O-leg, end panel, pedestal, slim pedestal, support bookcase, lateral/multi file.
- O-legs work in many of the Voi desks applications and provide a light-scale, contemporary look.
- O-legs can be used in a variety of heights so surfaces can be layered.
- End panels are also available and provide a more conventional look.
- A variety of modular storage options can be specified based on your storage needs: box/box/file pedestal, file/file pedestal, slim profile pedestal, lateral files and multifiles.

Modesty Panel/Privacy Screens

- Full height, ½ height and floating modesty panel options are available to enhance privacy.
- Mixed material options are available in laminate and frosted translucent.
- Select the size that works with the supports.
- Above and above/below privacy screens are available to create an element of privacy in an open plan area.

Steps for specification:

1. Select the right worksurface.
Choose the worksurface shape and size that best fits your office layout.

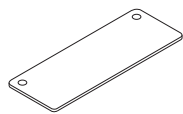
**Rectangle Worksurface**

Depths: 20", 24", 30", 36"
Widths: 36", 42", 48", 54",
60", 66", 72", 84"

Tips

- T-mold is not an option on Voi worksurfaces; edgeband only.

2. Select the supports.
Countless combinations of support options meet a variety of support and storage needs.

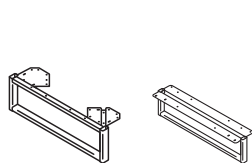
**O-Leg and Shared Support for Low Credenza**

20"D x 7"H, 24"D x 7"H, 30"D x 7"H
7"H only O-legs attach to worksurface and sit on top of credenzas.

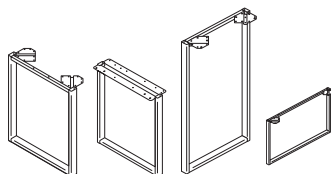
**O-Leg and Shared Support for Worksurfaces**

20"D x 28½"H, 24"D x 28½"H, 30"D x 28½"H
28½"H, 24"D x 41"H, 30"D x 41"H, 48"D x 28½"H,
60"D x 28½"H O-legs provide support for the worksurface.

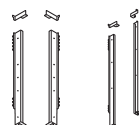
**O-Leg-to-Panel Attachment Bracket**

Left handed bracket (quantity 1)
Right handed bracket (quantity 1)

**Post Leg**

28½"H, 2" square

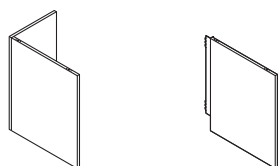
**End Panel Support**

16"W x 20"D x 28½"H,
16"W x 24"D x 28½"H,
16"W x 30"D x 28½"H

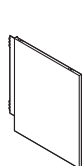
**Laminate End Panel Support With Panel Attachment Bracket**

24"D x 28½"H, 30"D x 28"H

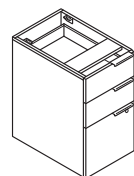
**B/B/F Standard and Power-Ready Pedestals**

16"W x 20"D x 28½"H,
16"W x 24"D x 28½"H,
16"W x 30"D x 28½"H

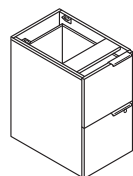
**F/F Standard and Power-Ready Pedestals**

16"W x 20"D x 28½"H,
16"W x 24"D x 28½"H,
16"W x 30"D x 28½"H

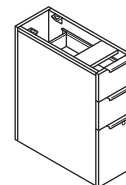
**B/B/F Standard Slim Profile Pedestals**

9½"W x 24"D x 28½"H,
9½"W x 30"D x 28½"H

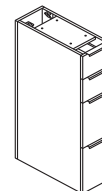
**Standing Height Pedestals**

9½"W x 24"D x 41"H,
9½"W x 30"D x 41"H

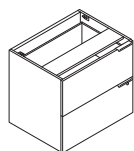
**2 Drawer Standard and Power-Ready Lateral with Pulls**

30"W x 24"D x 28½"H

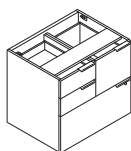
**Multi-Drawer Standard File Center**

30"W x 24"D x 28½"H

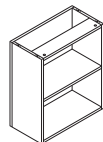
**Bookcase Support**

30"W x 12"D x 28½"H,
24"W x 12"D x 28½"H

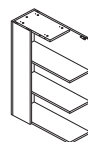
**Standing Height Support Storage**

12"W x 30"D x 41"H,
12"W x 24"D x 41"H

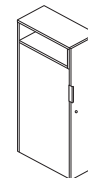
**Standing Height Towers**

12"W x 30"D x 50"H,
12"W x 24"D x 50"H

Tips

- When using an O-leg in open plan, panel supported, applications, you must specify an O-leg to panel attachment bracket separately (available in 28"H and 41"H).
- Bookcase Support can only be used exterior facing.
- Telescoping ball-bearing slides used on box and file drawers. Lateral drawers use a progressive ball-bearing slide.
- O-leg and panel applications cannot be used with T-mold.
- When specifying a 30"D support on a 36"D worksurface, there will be a 6" overhang.
- All modular pedestals have an easy attach method to the worksurface for quick assembly.
- Pass-thru openings in the sides of the Power-Ready Pedestals and Lateral Files allow hardware conduit to run under the worksurfaces, through the case in a continuous run.
- One double-depth O-leg can replace two regular O-legs in teaming applications.
- Shared O-legs create cleaner aesthetic where two legs are used side-by-side.
- 2" adjustable glides on O-leg supports.
- Standing-Height Support Pedestals bottom two file drawers are locking.
- Standing-Height Bookcase Support contains easy-access, fixed storage shelves.

3. Select the modesty panel/privacy screen that works in conjunction with the supports you have specified.

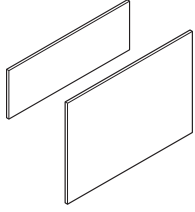

14"H Full Width/Half-height Laminate Modesty Panel
28", 34", 40"W
(Modesty Size)
28"H Full-to-Floor/ Full Length Laminate Modesty Panel
28", 34", 40"W
(Modesty Size)

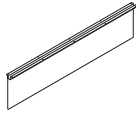

Laminate Floating Modesty Panel
30"W x 14"H, 36"W x 14"H, 42"W x 14"H, 48"W x 14"H, 54"W x 14"H, 60"W x 14"H

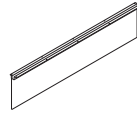

Mixed Material Floating Modesty Panel
30"W x 14"H, 36"W x 14"H, 42"W x 14"H, 48"W x 14"H, 54"W x 14"H, 60"W x 14"H
Available in Frosted Translucent only

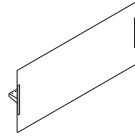

Above/Below Privacy Screen
30"W x 28"H, 36"W x 28"H, 42"W x 28"H, 48"W x 28"H, 54"W x 28"H, 60"W x 28"H
Available in Frosted Translucent only

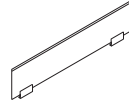

Above Privacy Screen
30"W x 13"H, 36"W x 13"H, 42"W x 13"H, 48"W x 13"H, 54"W x 13"H, 60"W x 13"H
Available in Frosted Glass only

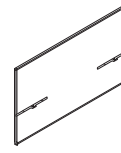

Above/Below Fabric Screen
36"W x 35"H, 42"W x 35"H, 48"W x 35"H, 54"W x 35"H, 60"W x 35"H, 66"W x 35"H, 72"W x 35"H

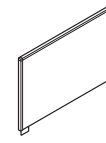

Above Fabric Screen
20"W x 20"H, 20"W x 13"H, 24"W x 20"H, 24"W x 13"H, 30"W x 20"H, 30"W x 13"H, 36"W x 20"H, 36"W x 13"H

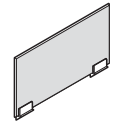

Above Polymer or Glass (Side) Screen
20"W x 13"H, 24"W x 13"H, 30"W x 13"H, 36"W x 13"H

Tips

- Mixed material and laminate floating modesty panels create a lighter scale look by attaching to the top of the worksurface.
- Choose from a variety of materials to create your desired look.
- Laminate modesty panels to create a more conventional look.
- 54"W and 60"W Floating Modesty panels eliminate the need for an external channel.
- Above Privacy Screens provide a division between two worksurfaces and create a division of space in an open plan area.
- Modesty panels cannot be used as a support.
- See modesty panel chart to choose proper modesty size depending on support options.

4. Select Above the Worksurface Storage (Stack-on Storage) or Overhead Cabinets

Select the above the worksurface storage that meets your storage criteria, choose from overhead cabinets, panel mounted storage, conventional or contemporary stack-on storage.

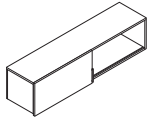

14 1/4'D x 14'H Shared Overhead Cabinet with One Sliding Door
60", 72"

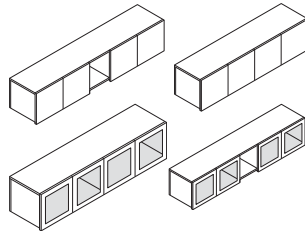

14 1/4'' Overhead Cabinet with 4 Laminate Doors with or without Cubbie or 4 Frosted Metal Doors with or without Cubbie
36", 42", 48" and 60" with 4 Laminate or Frosted Doors
60", 66", 72" and 78" with Laminate or Frosted Doors and Cubbie

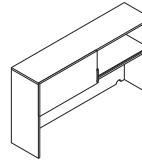

14 1/4'D x 35'H Stack-on Storage, Built-up, with Sliding Doors
72"W only

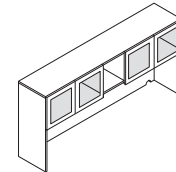

14 1/4'D x 35'H Stack-on Storage, Built-up, 4 Frosted Metal Doors with Cubbie
72"W only with Laminate or Frosted Doors and Cubbie

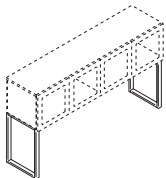

O-Leg Support for Overhead Cabinet
50"-14 1/8"D x 5 1/2"H
65"-14 1/8"D x 20 1/2"H

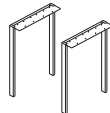

Post Legs for Shared Storage
14"H and 22"H

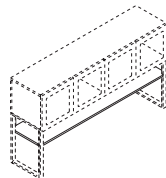

Steel Shelf for Stack-on Storage
72"W, 66"W, 60"W



Tackboard for Overhead Cabinet Applications
Tackboard for Built-up Stack-on Storage
72"W only

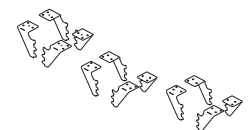

Panel Mount Bracket for Shared Overhead
Abound and Accelerate

Tips

- Select sliding or hinged doors.
- Specify O-leg separately for a contemporary look.
- Optional storage shelf works in conjunction with the O-leg design to provide additional storage space. Only works with 65"H O-legs.
- O-legs come in two sizes to make a 50"H or 65"H stack-on storage unit.
- Wall-mount brackets carry a \$150 upcharge and are specified the model ordering logic.
- Use shared overhead and attachments in small footprint applications.
- Shared overhead must be ordered as left or right to determine open storage location.
- Shared overhead panel mount brackets and overhead post legs allow overhead to span over all panels systems or run down the spine wall, centered on top of the panel.
- Use the 65"H for a more conventional design. 65"H and 50"H aligns with Abound and Accelerate.
- Stack-on Storage must be placed over two full-height supports. Cannot be placed over non-supported sections such as returns using a flat bracket or tower-to-worksurface bracket.
- If the end panel conventional look is preferred, order the built-up stack-on storage models.
- There are two types of tackboards for use on Overhead Cabinet and Stack-on Storage.

5. Select the right storage.

Choose from a variety of below the worksurface, as well as traditional, storage options.

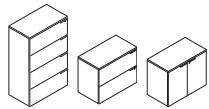
**Laterals and Storage Cabinet**

2-Drawer Lateral, 4-Drawer Lateral, Storage Cabinet

36"W x 24"D x 29½"H, 36"W x 20"D x 29½"H,
36"W x 24"D x 57"H, 36"W x 20"D x 57"H,
36"W x 24"D x 29½"H, 36"W x 20"D x 29½"H

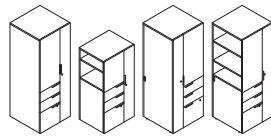
**Storage Towers**

18"W x 20"D, 18"W x 24"D, 24"W x 20"D, 24"W x
24"D, 50"H and 65"H

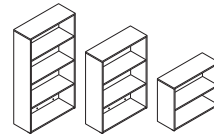
**Bookshelves**

36"W x 13"D x 29½"H (2 Shelf)
36"W x 13"D x 50"H (3 Shelf)
36"W x 13"D x 65"H (4 Shelf)

**Bookcase Hutch without Doors**

36"W x 14"D x 35"H

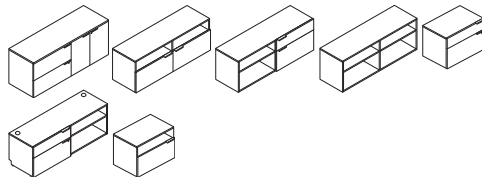
**Credenzas (Standard and Power Ready)**

Credenza: 24"D x 72"W x 29½"H

Low Credenzas: 20"D x 21½"H x 30", 36", 60", 72"W

Low Credenzas with a variety of door/drawer options

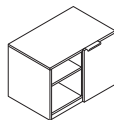
**Mobile Credenza**

30"W x 20"D x 21½"H

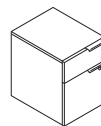
**Mobile Pedestal**

15¾"W x 20⅛"D x 21⅞"H

Tips

- Small credenza models can be used in small footprint applications.
- Can use pedestal or credenza seat cushions on smaller credenza models.
- Low credenzas work in conjunction with worksurface 7" O-leg designed to create a unique layering design.
- Bookcase/laterals and other conventional storage components provide additional storage space.
- Must specify chassis and drawer front color separately.
- Low Credenzas, Laterals and Mobile Pedestals have seat cushions to create additional seating in the workspace.
- Storage and Personal Tower models offer conventional storage as well as wardrobes with a coat rod.
- Using a seat cushion with a power-ready credenza will cover one grommet.
- Specify appropriate power pack for credenza length.
- A worksurface-to-tower bracket kit allows the attachment of worksurfaces to Storage and Personal Tower models.
- Telescoping ball-bearing slides used on box and file drawers. Lateral drawers use a progressive ball-bearing slide.
- Cannot route software power through lockable storage units.

6. Select Accessories to add color, additional storage and organization to your workspace.

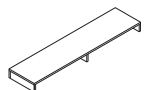
**Layering Shelf**

60"W x 14¼"D x 5½"H
72"W x 14¼"D x 5½"H

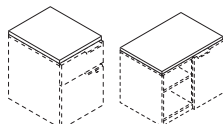
**Seat Cushion for Credenzas and Mobile Credenza/Pedestal Pedestal Cushion**

15⅞"W x 20"D x 2"H

Credenza Cushion

20"W x 30"D x 2"H, 20"W x 36"D x 2"H

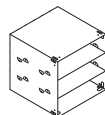
**Storage Cube**

12" x 12"

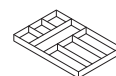
**Drawer Organizer**

12"W x 14½"D x 1½"H

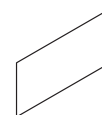
**Markerboard for Shared Overhead**

30"W x 15"D for use with 60"W Shared Overhead
36"W x 15"D for use with 72"W Shared Overhead

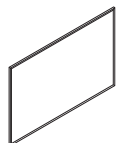
**Markerboard**

48"W x 31"H

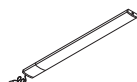
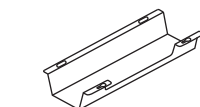
**LED Task Light****Cable Management Trough**

17"W

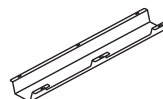
**Cable Management Trough**

36"W

Tips

- Choose from five bright Storage Cube colors for a colorful design element while providing additional storage.
- Use the Drawer Organizer to keep small items in order. Also offered in the same bright Storage Cube colors.
- Layering shelves are great for filing and piling or in conjunction with the lower credenza.
- Optimize shared overhead capabilities by adding the Markerboard for Shared Overhead.

Voi® and Systems Integration

Worksurface Applications

Either Voi or Systems worksurfaces can be used with Voi in an open plan application. There are several support options:

- A. Completely panel supported.
- B. Combination of panel supported and another worksurface support such as:
 - Bookcase support
 - Pedestal (Brigade®, Flagship®, Contain®, or Voi®)
 - Systems open leg
 - Voi O-leg
 - End panel (Systems or Voi)
 - Tower to worksurface bracket
 - Support column
 - Systems round post leg
 - Voi post leg
- C. Freestanding:
 - Bookcase support
 - Two pedestals (Brigade®, Flagship®, Contain®, or Voi®)
 - Two Voi O-legs
 - One Voi O-leg and one Voi O-leg support for lower credenzas
 - Two end panels (metal or Voi)—requires metal or Voi modesty panel

Additional application guidelines for worksurfaces:

- Systems worksurfaces are available with t-mold or edgeband edges. T-mold cannot be used with Voi® components.
- Systems worksurfaces are available with grommets, wire management scallops, or no grommets.
- When Voi lower credenzas are used along the spine wall and are placed adjacent to the wing wall, one electrical/data cutout on the wing wall will be blocked.
- When Voi credenzas are used along the wing wall and are placed adjacent to the spine wall, one electrical/data cutout on the spine wall will be blocked.
- When the Voi O-leg support for credenzas is used, it is recommended to also panel attach the worksurface with the worksurface anti-dislodgement bracket kit HWSA2.
- When the Voi O-leg support is used with panels, it is recommended to also panel attach the O-leg to the panel with the O-leg to panel bracket kit HLSPLB (left) and/or HLSPPB (right). This bracket will provide additional workstation rigidity. The bracket is designed to work with edgeband worksurfaces only.
- When the Voi end panel support is used with panels, it is recommended to use the end panel support with panel bracket model. This model will provide additional workstation rigidity.
- The worksurface to tower bracket kit, HSTB2W1, will work with Voi towers, Voi worksurfaces, and systems worksurfaces.

Application Guidelines—Combination of Panel Supported and Another Worksurface Support

- For applications where 1) the worksurface is perpendicular to the spine wall; 2) the worksurface is panel supported off the spine wall; and 3) there are Voi credenzas placed under the worksurface along the spine: there is not enough clearance to use standard worksurface cantilevers to attach the worksurface to the spine. Use the worksurface anti-dislodgement bracket kit HWSA2 to panel attach the worksurface in lieu of cantilevers.
- The Voi O-leg-to-panel bracket is designed to work with edgeband worksurfaces. Use of the Voi O-leg with t-mold worksurfaces will prevent the attachment of the leg to the panel.

Panel Mounted Stack-on Storage Applications

- The Voi stack-on storage cabinets can be used on Abound and Accelerate as panel mounted overheads.
- The sliding door stack-on storage units are available in 36", 42", 48" widths in addition to 60", 66", 72", and 78" widths.
- The 4 door stack-on storage units are only available in 36", 42", 48", 60", 66", 72", and 78" widths.
- The storage units require a storage to panel bracket kit, model HLSLPMB. This model includes one left hand, one right hand, and one center bracket. The brackets are available in all Core and Choice/Metallic paint colors.
- The storage cabinets do not have off modular capabilities.
- The storage cabinets cannot be upmounted.
- For proper installation and support, the storage units must follow the following specification rules:
 - There should be a storage unit of the same construction on each side of a given panel.
 - The storage units on opposite sides of a given panel should be in the same location vertically and horizontally.
 - Only one storage unit per panel, per side.
 - The wing panel adjacent to the spine wall needs to be the same height as the spine wall.

Contact HON's Integrated Design Services team with specification questions.

Flagship Storage is a perfect fit with Voi Workstations. Please see below for a few key Flagship models that will meet your storage needs. For a full-line of Flagship Storage products, please see pages 466-473.

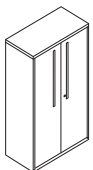

Storage Cabinet

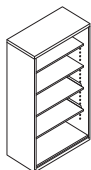

Bookcase

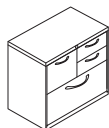

File Center



Standard Height Pedestal



Mobile Pedestal

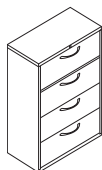

4-Drawer Lateral File

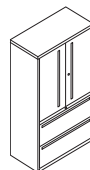

Lateral File with Storage

Voi® Laminate Worksurfaces — Rectangle

GSA SIN 711-2



- Systems worksurfaces can be used with all Voi components.
- Worksurfaces are abrasion- and stain-resistant laminate over durable 1 1/8" solid core high performance particleboard; resists wrapping.
- There is one 3" grommet in 36"W and 42"W worksurfaces and two in 48"W-84"W worksurfaces.
- One flat bracket ships with each worksurface.
- When attaching tops to panels, refer to Systems section of this pricer.

- Square edge detail.
- When using a floating modesty panel or an external channel under the worksurface, the depth clearance for keyboard trays and center drawers decreases by 8". See accessory matrix in accessory section of the pricer.
- 3" Power Hub model HGRMTAC can be interchanged with 3" standard grommet.
- Voi® worksurfaces cannot be used with Abode™ Desks components.**

- Grommets in worksurfaces must be specified. If grommets are specified, grommets come in predetermined location.
- Edgeband option only on all Voi worksurfaces. For edgeband options, see matrix on page 185.
- When specifying an 84" Worksurface, cannot use two 0-legs, must use at least one additional support such as a pedestal or lateral file.
- When using a worksurface as a bridge, no additional supports are needed. One support is required for returns, two supports are required for desks and credenzas.

- Lateral file or multi-files must be used with surfaces 24"D and 60"W or greater.
- Scallops are not available on Voi worksurfaces.
- Depending on your support combination, an external channel may be required for extra support on unsupported spans greater than 54"W. Please see the matrix below for more details.
- If using a 54"W or 60"W floating modesty, it is not necessary to spec an external channel.

- When attaching worksurfaces to panels, one or more of the following are required: anti-dislodgement brackets, end panel, support leg and/or cantilevers. Cantilevers and anti-dislodgement brackets must be ordered separately when attaching worksurfaces to panels.
- A return worksurface is considered 48"W or shorter. Longer returns cannot be supported by a flat bracket only.



Description	Model	Ship		List Price by Laminate Grade	
		Weight	Cube	L1	L2
Rectangle Worksurfaces					
36"W x 20"D	HLSLR2036	40	2.2	\$ 207	\$ 217
42"W x 20"D	HLSLR2042	46	2.6	\$ 230	\$ 240
48"W x 20"D	HLSLR2048	52	2.9	\$ 249	\$ 259
54"W x 20"D	HLSLR2054	64	3.5	\$ 279	\$ 294
60"W x 20"D	HLSLR2060	70	3.5	\$ 307	\$ 322
66"W x 20"D	HLSLR2066	76	4.2	\$ 334	\$ 349
72"W x 20"D	HLSLR2072	82	4.2	\$ 345	\$ 360
36"W x 24"D	HLSLR2436	47	2.6	\$ 218	\$ 233
42"W x 24"D	HLSLR2442	54	3.0	\$ 244	\$ 259
48"W x 24"D	HLSLR2448	61	3.4	\$ 264	\$ 279
54"W x 24"D	HLSLR2454	68	4.2	\$ 284	\$ 304
60"W x 24"D	HLSLR2460	75	4.2	\$ 309	\$ 329
66"W x 24"D	HLSLR2466	82	5.0	\$ 336	\$ 356
72"W x 24"D	HLSLR2472	89	5.0	\$ 347	\$ 367
84"W x 24"D	HLSLR2484	103	5.7	\$ 512	\$ 537

Description	Model	Ship Weight	Cube	List
External Support Channel				
42"W for a 54" Worksurface	HLSLZ5SC54	5	0.5	\$ 82
48"W for a 60" Worksurface	HLSLZ5SC60	6	0.5	\$ 87
54"W for a 66" Worksurface	HLSLZ5SC66	7	0.5	\$ 90
60"W for a 72" Worksurface	HLSLZ5SC72	7	0.5	\$ 97
72"W for an 84" Worksurface	HLSLZ5SC84	12	0.7	\$ 97

▲ Available in Graphite paint only.
 ▲ When specifying panel-hung worksurfaces, specify external channel as if supported by two 0-legs via selection chart.
 ▲ When specifying a 54"W or 60"W Floating Modesty Panel, it is not necessary to specify an external channel.

EXTERNAL CHANNEL SELECTION GUIDE						
Support Combination		Worksurface Width for Rectangle, Wedge, and Saddle				
Support 1	Support 2	84 in	72 in	66 in	60 in	54 in
O-Leg	O-Leg	NA	HLSLZ5SC72	HLSLZ5SC66	HLSLZ5SC60	HLSLZ5SC54
O-Leg	Slim Profile Pedestal	HLSLZ5SC84	HLSLZ5SC66	HLSLZ5SC60	HLSLZ5SC54	NA
O-Leg	Bookcase	HLSLZ5SC72	HLSLZ5SC66	HLSLZ5SC60	HLSLZ5SC54	NA
O-Leg	Pedestal	HLSLZ5SC72	HLSLZ5SC60	HLSLZ5SC54	NA	NA
O-Leg	End-Panel	HLSLZ5SC84	HLSLZ5SC60	HLSLZ5SC54	NA	NA
Slim Profile Pedestal	Slim Profile Pedestal	HLSLZ5SC72	HLSLZ5SC60	HLSLZ5SC54	NA	NA
Slim Profile Pedestal	Bookcase	HLSLZ5SC72	HLSLZ5SC60	HLSLZ5SC54	NA	NA
Slim Profile Pedestal	Pedestal	HLSLZ5SC66	HLSLZ5SC54	NA	NA	NA
Slim Profile Pedestal	End-Panel	HLSLZ5SC66	HLSLZ5SC54	NA	NA	NA
Pedestal	Bookcase	HLSLZ5SC66	HLSLZ5SC54	NA	NA	NA
End-Panel	Bookcase	HLSLZ5SC66	HLSLZ5SC54	NA	NA	NA
Bookcase	Bookcase	HLSLZ5SC66	HLSLZ5SC54	NA	NA	NA
End-Panel	End-Panel	HLSLZ5SC60	NA	NA	NA	NA
Pedestal	Pedestal	HLSLZ5SC60	NA	NA	NA	NA
Pedestal	End-Panel	HLSLZ5SC60	NA	NA	NA	NA
O-Leg	Lateral/Multifile	HLSLZ5SC54	NA	NA	NA	NA
Bookcase	Lateral/Multifile	NA	NA	NA	NA	NA
Slim Profile Pedestal	Lateral/Multifile	NA	NA	NA	NA	NA
Pedestal	Lateral/Multifile	NA	NA	NA	NA	NA
End-Panel	Lateral/Multifile	NA	NA	NA	NA	NA

*All Rudder worksurfaces use external channel model HLSLZ5SC60.

How to specify	Select Model Number from above	1st Option Select Worksurface Laminate and Edge Color See page 175	2nd Option Select Grommet Option and Color If choosing the grommet option Select Grommet Color
	H L S L R 2 0 3 6 .	N N .	G T 5

X No Grommet
G Grommet
P Black Grommet
WHIT Brilliant White Grommet
T5 Greige Grommet
T1 Platinum Grommet

How to specify	Select Model Number from above	1st Option Select Paint
	H L S L Z 5 S C 8 4 .	P

Icon Legend on page 10

- ▶ Systems worksurfaces can be used with all Voi components.
- ▶ Worksurfaces are abrasion- and stain-resistant laminate over durable 1½" solid core high performance particleboard: resists wrapping.
- ▶ There is one 3" grommet in 36"W and 42"W worksurfaces and two in 48"W-84"W worksurfaces.
- ▶ One flat bracket ships with each worksurface.
- ▶ When attaching tops to panels, refer to Systems section of this pricer.
- ▶ Square edge detail.
- ▶ When using a floating modesty panel or an external channel under the worksurface, the depth clearance for keyboard trays and center drawers decreases by 8". See accessory matrix in accessory section of the pricer.
- ▶ 3" Power Hub model HGRMTAC can be interchanged with 3" standard grommet.
- ▶ **Voi® worksurfaces cannot be used with Abode™ Desks components.**
- ▶ **Grommets in worksurfaces must be specified. If grommets are specified, grommets come in predetermined location.**
- ▶ **Edgeband option only on all Voi worksurfaces.**
- ▶ **When specifying an 84" Worksurface, cannot use two O-legs, must use at least one additional support such as a pedestal or lateral file.**
- ▶ **When using a worksurface as a bridge, no additional supports are needed. One support is required for returns, two supports are required for desks and credenzas.**
- ▶ **Lateral file or multi-files must be used with surfaces 24"D and 60"W or greater.**
- ▶ **Scallops are not available on Voi worksurfaces.**
- ▶ **Depending on your support combination, an external channel may be required for extra support on unsupported spans greater than 54"W. Please see page 184 for models and a matrix to aid in specifying.**
- ▶ **If using a 54"W or 60"W floating modesty, it is not necessary to spec an external channel.**
- ▶ **When attaching worksurfaces to panels, one or more of the following are required: anti-dislodgement brackets, end panel, support leg and/or cantilevers. Cantilevers and anti-dislodgement brackets must be ordered separately when attaching worksurfaces to panels.**
- ▶ **A return worksurface is considered 48"W or shorter. Longer returns cannot be supported by a flat bracket only.**



Description	Model	Ship Weight	Cube	List Price by Laminate Grade	
				L1	L2
Rectangle Worksurfaces					
36"W x 30"D	HLSLR3036	58	3.2	\$ 249	\$ 264
42"W x 30"D	HLSLR3042	67	3.7	\$ 269	\$ 284
48"W x 30"D	HLSLR3048	75	4.2	\$ 284	\$ 299
54"W x 30"D	HLSLR3054	84	5.1	\$ 317	\$ 337
60"W x 30"D	HLSLR3060	92	5.1	\$ 354	\$ 374
66"W x 30"D	HLSLR3066	101	6.1	\$ 381	\$ 401
72"W x 30"D	HLSLR3072	110	6.1	\$ 414	\$ 434
84"W x 30"D	HLSLR3084	127	7.0	\$ 566	\$ 591
60"W x 36"D	HLSLR3660	110	6.1	\$ 444	\$ 469
66"W x 36"D	HLSLR3666	120	7.2	\$ 480	\$ 505
72"W x 36"D	HLSLR3672	130	7.2	\$ 539	\$ 564

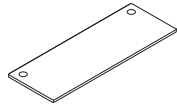

WORKSURFACE LAMINATES CODES	EDGE BAND OPTIONS						
	Matching Edge	Brilliant White (WHIT)	Loft (LOFT)	Muslin (T)	Shadow (SHDW)	Black (P)	Charcoal (S)
Black	P					•	
Bourbon Cherry	H	•		•			
Brilliant White	WHIT		•				
Charcoal	S						•
Cognac	COGN	•		•			
Harvest	C	•		•			
Loft	LOFT		•				
Lowell Ash	LLA1	•	•	•	•		
Mahogany	N	•		•	•		
Mocha	MOCH	•	•	•			
Natural Maple	D	•	•	•	•		
Natural Recon	LNR1	•	•	•	•		
Phantom Ecu	LPE1	•	•	•	•		
Pinnacle	PINC	•	•	•			
Portico Teak	LPT1	•	•	•	•		
Shaker Cherry	F	•	•	•	•	•	
Sheer Mesh	A5				•		
Silver Mesh	B9			•			
Skyline Walnut	LSW1	•	•	•	•		

How to specify	1st Option	2nd Option
<p>Select Model Number from above</p> <p>H L S L R 3 0 3 6 .</p>	<p>Select Worksurface Laminate and Edge Color</p> <p>See page 175</p> <p>N N .</p>	<p>Select Grommet Option and Color</p> <p>X No Grommet G Grommet</p> <p>If choosing the grommet option Select Grommet Color</p> <p>P Black Grommet WHIT Brilliant White Grommet T5 Greige Grommet T1 Platinum Grommet</p> <p>G T 5 </p>

- ▶ A variety of pedestals, end panels, and O-legs can be combined to create a conventional or contemporary desk.
- ▶ O-leg ships fully assembled with mounting hardware.

- ▶ Shared O-Legs create a cleaner aesthetic in all applications where two legs are used side-by-side.
- ▶ The bracket on the O-leg will span both worksurfaces to provide the same support with the look of a single O-leg.

- ▶ Voi square support column is interchangeable with the Systems worksurface round support column: HCNLEG29.
- ▶ Will have a 6" overhang when using 30" worksurface supports with a 36" D worksurface.

- ▶ Glides on O-Leg Support for Worksurfaces and Post Leg Base have 2" of adjustability. No glides on 7" H O-leg. Glides on end panels have 1 1/4" adjustability.

- ⚠ O-legs may only be attached to worksurfaces, not storage units.
- ⚠ Post leg can only be used to support peninsula, not as primary supports for a top.



	Description	Model	Ship Weight	Cube	List Price by Paint Grade	
					Core	Metallics
	O-Leg Support for Worksurfaces					
	20"D x 28 1/2"H	HLSL2028O	15	3.7	\$ 256	\$ 260
	24"D x 28 1/2"H	HLSL2428O	17	3.7	\$ 279	\$ 283
	30"D x 28 1/2"H	HLSL3028O	19	5.4	\$ 310	\$ 314
	NOTES: Ship fully assembled, 1/pack. Non-handed.					
	⚠ Specify paint only.					
	SPECIFYING EXAMPLE: HLSL2028O.T1					
	O-Leg Shared Support for Worksurfaces					
	20"D x 28 1/2"H	HLSL2028SL	15	3.7	\$ 308	\$ 312
	24"D x 28 1/2"H	HLSL2428SL	17	3.7	\$ 347	\$ 351
	30"D x 28 1/2"H	HLSL3028SL	19	5.4	\$ 386	\$ 390
	NOTES: Ship fully assembled, 1/pack. Non-handed.					
	⚠ Specify paint only.					
	SPECIFYING EXAMPLE: HLSL2028SL.T1					
	Double-Depth O-Leg Support for Worksurfaces					
	48"D x 28 1/2"H	HLSL4828O	18	7.0	\$ 528	\$ 536
	60"D x 28 1/2"H	HLSL6028O	19	8.7	\$ 588	\$ 596
	NOTES: Ship fully assembled, 1/package. Non-handed.					
	O-Leg Support for Low Credenzas					
	20"D x 7"H	HLSL207O	5	1.0	\$ 173	\$ 177
	24"D x 7"H	HLSL247O	6	1.0	\$ 188	\$ 192
	30"D x 7"H	HLSL307O	7	1.0	\$ 239	\$ 243
	NOTES: Ship fully assembled, 1/pack. Non-handed.					
	⚠ Specify paint only.					
	SPECIFYING EXAMPLE: HLSL207O.T1					
	O-Leg Shared Support for Low Credenzas					
	20"D x 7"H	HLSL207SL	5	1.0	\$ 216	\$ 220
	24"D x 7"H	HLSL247SL	6	1.0	\$ 234	\$ 238
	30"D x 7"H	HLSL307SL	7	1.0	\$ 297	\$ 301
	NOTES: Ship fully assembled, 1/pack. Non-handed.					
	⚠ Specify paint only.					
	SPECIFYING EXAMPLE: HLSL207SL.T1					
	Post Leg Base					
	28 1/2"H x 2" square	HLSL28P	15	1.0	\$ 256	\$ 260
	⚠ Post leg cannot be used on primary worksurface with an O-leg as the other support.					
	28 1/2"H O-Leg-to-Panel Attachment Bracket					
	28 1/2"H Left handed bracket (quantity 1)	HLSLPBL	3	0.4	\$ 87	\$ 91
	28 1/2"H Right handed bracket (quantity 1)	HLSLPBR	3	0.4	\$ 87	\$ 91
	NOTES: Used to connect Voi O-Leg to a systems panel for additional workstation rigidity. Bracket designed to work with edgeband worksurfaces only. Brackets are handed, come one per package and include self-tapping screws. Specify paint. Standing-height O-leg to panel attachment brackets can be found on the next page.					

	Description	Model	Ship Weight	Cube	List Price by Laminate Grade	
					L1	L2
	End Panel Support					
	16"W x 20"D x 28 1/2"H	HLSL2028E	39	3.2	\$ 165	\$ 175
	16"W x 24"D x 28 1/2"H	HLSL2428E	44	3.7	\$ 178	\$ 188
	16"W x 30"D x 28 1/2"H	HLSL3028E	50	4.2	\$ 190	\$ 200
	NOTES: Ship in two pieces. Non-handed. \$10 list upcharge for L2 laminates.					

How to specify	1st Option
Select Model Number from above	Select Laminate
H L S L 2 0 2 8 E .	See page 175
H	H



▶ O-leg glides have 2" adjustability.

▶ Shared O-legs create a cleaner aesthetic in all applications where two legs are used side-by-side.

▶ O-Leg to Panel Attachment Brackets are used to connect Voi® O-Legs to a systems panel for additional worksurface rigidity.

⚠ O-legs may only be attached to worksurfaces, not storage units.

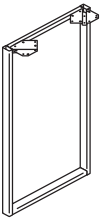
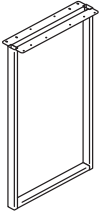

Description	Model	Ship Weight	Cube	List Price by Paint Grade	
				Core	Metallics
 <p>Standing-Height O-Leg Support for Worksurfaces 24"D x 41"H 30"D x 41"H</p> <p>NOTES: Ship fully assembled, 1/package. Non-handed. Coordinate™ Power Modules will work with standing-height applications for 10500™ and Voi® desks. Please see Coordinate™ Accessories Stand-Alone Pricer pages for more information.</p>	HLSL24410	16	5.3	\$ 375	\$ 381
	HLSL30410	17	6.5	\$ 419	\$ 425
 <p>Standing-Height O-Leg Shared Support for Worksurfaces 24"D x 41"H 30"D x 41"H</p> <p>NOTES: Ship fully assembled, 1/package. Non-handed. Coordinate™ Power Modules will work with standing-height applications for 10500™ and Voi® desks. Please see Coordinate™ Accessories Stand-Alone Pricer pages for more information.</p>	HLSL2441SL	16	5.3	\$ 422	\$ 428
	HLSL3041SL	17	6.5	\$ 468	\$ 474
 <p>Standing-Height O-Leg to Panel Attachment Bracket 41"H Left-hand Bracket 41"H Right-hand Bracket</p> <p>NOTES: 1/package. Brackets are handed as shown above. To be used with 41"H O-legs shown above (HLSL24410 and HLSL30410).</p>	HLSLSPBL	6	1.0	\$ 111	\$ 115
	HLSLSPBR	6	1.0	\$ 111	\$ 115

How to specify	Select Model Number from above H L S L 2 4 4 1 0 .	1st Option Select Paint Color See page 175 T 1
----------------	---	--

Description	Model	Ship Weight	Cube	List
 <p>Height Adjustable Base – Optional Memory Control</p> <p>⚠ Available in black finish only, no specification needed. Memory controller includes digital display and four memory presets.</p>	HHABMEM	0.5	0.4	\$ 75

Open Market

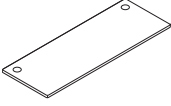
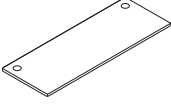
Description	Model	Ship Weight	Cube	List Price by Laminate Grade	
				L1	L2
 <p>Rectangle Worksurfaces 48"W x 24"D 54"W x 24"D 60"W x 24"D 66"W x 24"D 72"W x 24"D</p>	HLSLR2448	61	3.4	\$ 264	\$ 279
	HLSLR2454	68	4.2	\$ 284	\$ 304
	HLSLR2460	75	4.2	\$ 309	\$ 329
	HLSLR2466	82	5.0	\$ 336	\$ 356
	HLSLR2472	89	5.0	\$ 347	\$ 367
 <p>Rectangle Worksurfaces 48"W x 30"D 54"W x 30"D 60"W x 30"D 66"W x 30"D 72"W x 30"D</p>	HLSLR3048	75	4.2	\$ 284	\$ 299
	HLSLR3054	84	5.1	\$ 317	\$ 337
	HLSLR3060	92	5.1	\$ 354	\$ 374
	HLSLR3066	101	6.1	\$ 381	\$ 401
	HLSLR3072	110	6.1	\$ 414	\$ 434

How to specify	Select Model Number from above H L S L R 2 4 4 8 .	1st Option Select Worksurface Laminate and Edge Color See page 175 N N .	2nd Option Select Grommet Option and Color X No Grommet G Grommet If choosing the grommet option Select Grommet Color P Black Grommet WHIT Brilliant White Grommet T5 Greige Grommet T1 Platinum Grommet G T 5
----------------	---	--	---

Voi® Laminate Support/Power-Ready Support Pedestals

GSA SIN 711-3



- ▶ A variety of pedestals, end panels, and O-legs can be combined to create a conventional or contemporary desk.
- ▶ Chassis and drawer front woodgrain and solid laminates are specified separately (see SIF options below).
- ▶ Will have a 6" overhang when using 30" worksurface supports with a 36"D worksurface.
- ▶ Pass-thru openings in the sides of support pedestals allow hardwire conduit to run under worksurfaces, through the case in a continuous run. Black grommets included on both sides for a finished look.
- ▶ File drawers accept hanging folders in letter or legal size.
- ▶ Multiple handle locations possible per customer preference.
- ▶ Ships with one handle per drawer.
- ▶ Drawer Organizer model HLSLRWORG works with box drawers.
- ▶ Box and file drawers operate on ball-bearing suspension with full extension.
- ▶ Adjustable hex leveling glides allow floor-standing furniture to be easily leveled without lifting the unit; glides have 1/4" adjustable range.

△ **Pedestals ship fully assembled but must attach to a worksurface with a quick release bracket, provided. Pedestals are non-handed and are interchangeable.**

△ **Locking units equipped with HON "One Key" interchangeable core removable locks. Keyed alike core must be ordered separately.**

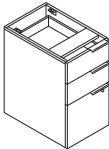
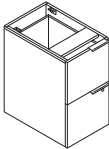
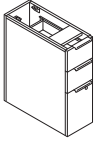
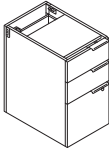
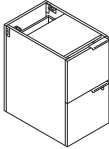
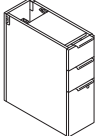

Description	Model	Ship Weight	Cube	L1 List	L2 Upcharges	
					Chassis	Front
Support Pedestals — Box/Box/File 16"W x 20"D x 28½"H 16"W x 24"D x 28½"H 16"W x 30"D x 28½"H NOTES: Top box drawer does not lock.	HLSL2028B	73	7.3	\$ 609	\$ 15	\$ 10
	HLSL2428B	85	8.5	\$ 674	\$ 20	\$ 10
	HLSL3028B	105	10.5	\$ 759	\$ 25	\$ 10
						
Support Pedestals — File/File 16"W x 20"D x 28½"H 16"W x 24"D x 28½"H 16"W x 30"D x 28½"H NOTES: Unit is locking.	HLSL2028F	72	7.3	\$ 609	\$ 15	\$ 10
	HLSL2428F	84	8.5	\$ 674	\$ 20	\$ 10
	HLSL3028F	104	10.5	\$ 759	\$ 25	\$ 10
						
Slim Profile Pedestals — Box/Box/File 9½"W x 24"D x 28½"H 9½"W x 30"D x 28½"H NOTES: Top box drawer does not lock. △ Cannot use worksurface with grommets with Slim Profile Pedestal due to mounting location.	HLSL2428S	69	6.9	\$ 669	\$ 20	\$ 10
	HLSL3028S	56	5.6	\$ 734	\$ 25	\$ 10
						
Power-Ready Support Pedestal — Box/Box/File 16"W x 20"D x 28½"H 16"W x 24"D x 28½"H 16"W x 30"D x 28½"H NOTES: Top drawers are non-locking.	HLSL2028BPWR	73	7.3	\$ 705	\$ 15	\$ 10
	HLSL2428BPWR	86	8.5	\$ 742	\$ 20	\$ 10
	HLSL3028BPWR	105	10.5	\$ 827	\$ 25	\$ 10
						
Power-Ready Support Pedestal — File/File 16"W x 20"D x 28½"H 16"W x 24"D x 28½"H 16"W x 30"D x 28½"H NOTES: Unit is locking.	HLSL2028FPWR	72	7.3	\$ 705	\$ 15	\$ 10
	HLSL2428FPWR	85	8.5	\$ 742	\$ 20	\$ 10
	HLSL3028FPWR	104	10.5	\$ 827	\$ 25	\$ 10
						
Power-Ready, Slim Profile Support Pedestal — Box/Box/File 9½"W x 24"D x 28½"H 9½"W x 30"D x 28½"H NOTES: Top drawers are non-locking. △ Cannot use worksurface with grommets with Slim Profile Pedestal due to mounting location.	HLSL2428SPWR	56	5.6	\$ 739	\$ 20	\$ 10
	HLSL3028SPWR	69	6.9	\$ 803	\$ 25	\$ 10
						

How to specify	1st Option	2nd Option	3rd Option	4th Option
Select Model Number from above H L S L 2 0 2 8 B P W R .	Select Chassis Laminate See page 175 N .	Select Drawer Front Laminate See page 175 N .	Select Pull Color P Black T4 Champagne T1 Platinum WHIT White T 4 .	Select Grommet Color P Black Specified for Power-Ready models only P

- ▶ Ships with one handle per drawer on all units.
- ▶ A variety of pedestals, end panels, and D-legs can be combined to create a conventional or contemporary desk.
- ▶ Will have a 6" overhang when using 30" worksurface supports with a 36"D worksurface.

- ▶ Bookcase can only mount exterior facing under a worksurface.
- ▶ Chassis and drawer front woodgrain and solid laminates are specified separately (see SIF options below).
- ▶ File drawers accept hanging folders in letter or legal size.
- ▶ Multiple handle locations possible per customer preference.

- ▶ Storage accessory model HSLDRWORG works with box doors.
- ▶ Standard box drawers operate on ball-bearing suspension with full extension. File, lateral, and wide box drawers operate on ball-bearing suspension with full extension.
- ▶ Adjustable hex leveling glides allow floor-standing furniture to be easily leveled without lifting the unit; glides have 2" adjustable range.

- ▶ When using two lateral files, a 60" worksurface cannot be used, a 66" worksurface must be specified, which will show a gap.
- ▶ Pass-thru openings in the sides of support pedestals and lateral files allow hardware conduit to run under worksurfaces, through the case in a continuous run. Black grommets included on both sides for a finished look.

⚠ A single multi-file or lateral file must be specified under a worksurface 60" W or wider.
 ⚠ Locking units equipped with HON "One Key" interchangeable core removable locks. Keyed alike core must be ordered separately.

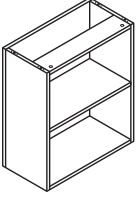
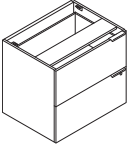
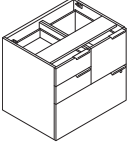
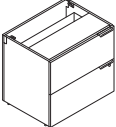

Description	Model	Ship Weight	Cube	L1 List	L2 Upcharges	
					Chassis	Front
 <p>Bookcase Support 24"W x 12"D x 28½"H 30"W x 12"D x 28½"H</p>	HLSL240BC E♦A	60	3.0	\$ 452	\$ 20	N/A
	HLSL300BC E♦A	75	3.0	\$ 474	\$ 25	N/A
 <p>Lateral File — 2 Drawer 31⅜"W x 24"D x 28½"H NOTES: Unit is locking.</p>	HLSL2430L	121	15.6	\$1048	\$ 35	\$ 20
 <p>Multi File Lateral File 31⅜"W x 24"D x 28½"H NOTES: Box drawers do not lock.</p>	HLSL2430MF	163	15.6	\$1243	\$ 35	\$ 20
 <p>Power-Ready Lateral File, 2 Drawers 31⅜"W x 24"D x 28½"H NOTES: Unit is locking.</p>	HLSL2430LPWR	121	15.6	\$1116	\$ 35	\$ 20

How to specify	1st Option	2nd Option	3rd Option	4th Option
<p>Select Model Number from above</p> <p>H L S L 2 4 3 0 L . N .</p>	<p>Select Chassis Laminate</p> <p>See page 175</p>	<p>Select Laminate</p> <p>See page 175</p>	<p>Select Pull Color</p> <p>P Black T4 Champagne T1 Platinum WHIT White T 4 .</p>	<p>Select Grommet Color</p> <p>P Black Specified for Power-Ready models only P </p>

- ▶ Tower includes coat hook on back of door.
- ▶ Chassis and drawer front panels can be specified separately.
- ▶ Tower door is locking. Ships with one handle.
- ▶ Support Pedestals bottom file drawers will lock, top box drawers will not.
- ▶ Standing-Height Bookcases and Pedestals will have 6" overhang when using 30"D support storage with a 36"D worksurface.
- ▶ Use the worksurface to tower bracket kit model HSTB2W1 on page 204 to attach worksurfaces to the Storage Tower models.
- ▶ **Bookcase can only mount with open side facing underneath the worksurface.**
- ▶ **Pedestals ship fully assembled but must attach to a worksurface with a quick release bracket, provided. Pedestals are non-handed and are interchangeable.**
- ▶ **Locking units equipped with HON "One Key" interchangeable core removable locks. Keyed alike core must be ordered separately.**

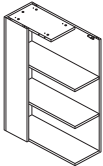
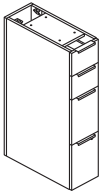
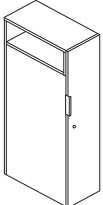

Description	Model	Ship Weight	Cube	L1 List	L2 Upcharges		
					Chassis	Front	
 <p>Standing-Height Bookcase Support 12"W x 30"D x 41"H – Left 12"W x 30"D x 41"H – Right 12"W x 24"D x 41"H – Left 12"W x 24"D x 41"H – Right</p> <p>⚠ Cannot use grommet worksurfaces with Standing-Height Support Storage.</p>	HLSL3041BCL	73	3.7	\$ 622	\$ 30	N/A	
	HLSL3041BCR	73	3.7	\$ 622	\$ 30	N/A	
	HLSL2441BCL	57	2.8	\$ 522	\$ 25	N/A	
	HLSL2441BCR	57	2.8	\$ 522	\$ 25	N/A	
	 <p>Standing-Height Support Pedestals — Box/Box/File/File 9½"W x 24"D x 41"H 9½"W x 30"D x 41"H</p> <p>NOTES: Top two drawers are non-locking.</p> <p>⚠ Cannot use grommet worksurfaces with Standing-Height Support Storage.</p>	HLSL2441S	94	11.9	\$1310	\$ 40	\$ 20
		HLSL3041S	113	14.7	\$1361	\$ 45	\$ 20
 <p>Standing-Height Side Access Storage Tower 12"W x 24"D x 50"H – Left 12"W x 24"D x 50"H – Right 12"W x 30"D x 50"H – Left 12"W x 30"D x 50"H – Right</p>		HLSLW1224L	100	11.0	\$1195	\$ 35	\$ 20
	HLSLW1224R	100	11.0	\$1195	\$ 35	\$ 20	
	HLSLW1230L	121	13.6	\$1246	\$ 35	\$ 20	
	HLSLW1230R	121	13.6	\$1246	\$ 35	\$ 20	

How to specify	1st Option	2nd Option	3rd Option
<p>Select Model Number from above</p> <p>H L S L 2 4 4 1 S . N .</p>	<p>Select Chassis Laminate</p> <p>See page 175</p>	<p>Select Drawer Front Laminate</p> <p>See page 175</p>	<p>Select Pull Color</p> <p>P Black T4 Champagne T1 Platinum WHIT White T 4 </p>

► Full width laminate modesty panel (14"H) and full width/full length laminate modesty panels are designed to work with 60", 66", & 72" desks.

► Laminate and frosted translucent laminate are available options on modesty panels.

► Full height and half height laminate modesty panels can only be used when specifying a pedestal and/or end panel.

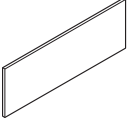
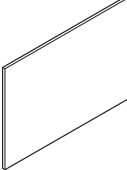
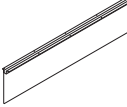

Description	Model	Ship Weight	Cube	List Price by Laminate Grade	
				L1	L2
 <p>Full Width/Half-height Laminate Modesty Panel 28"W x 14"H, for use with 60" desks 34"W x 14"H, for use with 66" desks 40"W x 14"H, for use with 72" desks NOTES: Three sizes available for 60", 66" and 72" desks. Can only be used when using end panels and pedestals for support.</p>	HLSL2814LM	19	1.6	\$ 162	\$ 172
	HLSL3414LM	23	1.9	\$ 167	\$ 177
	HLSL4014LM	29	2.4	\$ 175	\$ 185
	NOTES: Three sizes available for 60", 66" and 72" desks. Can only be used when using end panels and pedestals for support.				
 <p>Full-to-Floor/Full Length Laminate Modesty Panel 28"W x 28½"H, for use with 60" desks 34"W x 28½"H, for use with 66" desks 40"W x 28½"H, for use with 72" desks NOTES: Three sizes available for 60", 66" and 72" desks. Can only be used when using end panels and pedestals for support.</p>	HLSL2828LM	33	2.7	\$ 218	\$ 230
	HLSL3428LM	38	3.2	\$ 254	\$ 266
	HLSL4028LM	44	3.6	\$ 270	\$ 282
	NOTES: Three sizes available for 60", 66" and 72" desks. Can only be used when using end panels and pedestals for support.				
 <p>Laminate Floating Modesty Panel 30"W x 14"H 36"W x 14"H 42"W x 14"H 48"W x 14"H 54"W x 14"H 60"W x 14"H NOTES: The attachment bracket and modesty panel are packaged separately. Specify: Model.Laminate.Paint SPECIFYING EXAMPLE: HLSL3014L.N.P (Black is the only paint option for this model) ▲ When specifying the 54"W or 60"W Laminate Floating Modesty Panel, it is not necessary to specify an external channel. ▲ 30"W and 36"W screens attach with L-brackets, not the external channel.</p>	HLSL3014L	10	0.8	\$ 148	\$ 158
	HLSL3614L	12	0.8	\$ 156	\$ 166
	HLSL4214L	14	0.8	\$ 169	\$ 179
	HLSL4814L	16	1.1	\$ 186	\$ 198
	HLSL5414L	18	1.1	\$ 204	\$ 216
	HLSL6014L	20	1.1	\$ 220	\$ 232
	NOTES: The attachment bracket and modesty panel are packaged separately. Specify: Model.Laminate.Paint SPECIFYING EXAMPLE: HLSL3014L.N.P (Black is the only paint option for this model) ▲ When specifying the 54"W or 60"W Laminate Floating Modesty Panel, it is not necessary to specify an external channel. ▲ 30"W and 36"W screens attach with L-brackets, not the external channel.				

How to specify

<p>Select Model Number from above</p> <p>H L S L 2 8 1 4 L M .</p>	<p>1st Option</p> <p>Select Laminate</p> <p>See page 175</p> <p>N</p>
---	--

Description	Model	Ship Weight	Cube	List
 <p>Mixed Material Floating Modesty Panel 30"W x 14"H 36"W x 14"H 42"W x 14"H 48"W x 14"H 54"W x 14"H 60"W x 14"H NOTES: The attachment bracket and modesty panel are packaged separately. Specify: Model.Mixed Material.Paint SPECIFYING EXAMPLE: HLSL3014MM.FT01.P (Frosted Translucent mixed material and Black paint are the only options for this model) ▲ When specifying the 54"W or 60"W Mixed Material Floating Modesty Panel, it is not necessary to specify an external channel.</p>	HLSL3014MM	8	2.0	\$ 597
	HLSL3614MM	8	2.0	\$ 641
	HLSL4214MM	9	2.3	\$ 716
	HLSL4814MM	11	2.6	\$ 794
	HLSL5414MM	13	3.3	\$ 862
	HLSL6014MM	13	3.3	\$ 984

FLOATING MODESTY SELECTION GUIDE										
Support Combination		Top Size								
Support 1	Support 2	84 in	72 in	66 in	60 in	54 in	48 in	42 in	36 in	30 in
O-Leg	O-Leg	NA	HLSL6014	HLSL5414	HLSL4814	HLSL4214	HLSL3614	HLSL3014	NA	NA
O-Leg	Slim Profile Pedestal	HLSL6014	HLSL5414	HLSL4814	HLSL4214	HLSL3614	HLSL3014	NA	NA	NA
O-Leg	Bookcase	HLSL6014	HLSL5414	HLSL4814	HLSL4214	HLSL3614	HLSL3014	NA	NA	NA
O-Leg	Pedestal	HLSL6014	HLSL4814	HLSL4214	HLSL3614	HLSL3014	NA	NA	NA	NA
O-Leg	End-Panel	HLSL6014	HLSL4814	HLSL4214	HLSL3614	HLSL3014	NA	NA	NA	NA
Slim Profile Pedestal	Slim Profile Pedestal	HLSL6014	HLSL4814	HLSL4214	HLSL3614	HLSL3014	NA	NA	NA	NA
Slim Profile Pedestal	Bookcase	HLSL6014	HLSL4814	HLSL4214	HLSL3614	HLSL3014	NA	NA	NA	NA
Slim Profile Pedestal	Pedestal	HLSL5414	HLSL4214	HLSL3614	HLSL3014	NA	NA	NA	NA	NA
Slim Profile Pedestal	End-Panel	HLSL5414	HLSL4214	HLSL3614	HLSL3014	NA	NA	NA	NA	NA
Pedestal	Bookcase	HLSL5414	HLSL4214	HLSL3614	HLSL3014	NA	NA	NA	NA	NA
End-Panel	Bookcase	HLSL5414	HLSL4214	HLSL3614	HLSL3014	NA	NA	NA	NA	NA
Bookcase	Bookcase	HLSL5414	HLSL4214	HLSL3614	HLSL3014	NA	NA	NA	NA	NA
End-Panel	End-Panel	HLSL4814	HLSL3614	HLSL3014	NA	NA	NA	NA	NA	NA
Pedestal	Pedestal	HLSL4814	HLSL3614	HLSL3014	NA	NA	NA	NA	NA	NA
Pedestal	End-Panel	HLSL4814	HLSL3614	HLSL3014	NA	NA	NA	NA	NA	NA
O-Leg	Lateral/Multifile	HLSL4214	HLSL3614	HLSL3014	NA	NA	NA	NA	NA	NA
Bookcase	Lateral/Multifile	HLSL3614	NA	NA	NA	NA	NA	NA	NA	NA
Slim Profile Pedestal	Lateral/Multifile	HLSL3614	NA	NA	NA	NA	NA	NA	NA	NA
Pedestal	Lateral/Multifile	HLSL3014	NA	NA	NA	NA	NA	NA	NA	NA
End-Panel	Lateral/Multifile	HLSL3014	NA	NA	NA	NA	NA	NA	NA	NA

How to specify

<p>Select Model Number from above</p> <p>H L S L 3 0 1 4 M M .</p>	<p>1st Option</p> <p>Select Mixed Material</p> <p>FT01 Frosted Translucent</p> <p>F T 0 1</p>
---	---

Icon Legend on page 10

- ▶ Ships complete with attachment brackets.
- ▶ Voi® Privacy Screens can be used on the HON Height Adjustable Base.
- ▶ All brackets are Platinum.
- ▶ Above Privacy Screen attaches to top of worksurface.
- ▶ Above and below privacy screen extends 13" above and 13" below the worksurface.

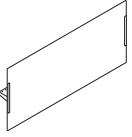

Description	Model	Ship		
		Weight	Cube	List
 Above/Below Privacy Screen 30"W x 28"H 36"W x 28"H 42"W x 28"H 48"W x 28"H 54"W x 28"H 60"W x 28"H	HLSL2830	6	6.4	\$ 707
	HLSL2836	6	6.4	\$ 978
	HLSL2842	6	6.3	\$ 991
	HLSL2848	8	8.2	\$1055
	HLSL2854	9	8.6	\$1229
	HLSL2860	9	8.6	\$1237

NOTES: Attachment bracket extends 2" into the worksurface. Brackets are Platinum only, no need to specify.

▲ Available in Frosted Translucent Acrylic ONLY HLSL2830.FT01.

 Above Privacy Screen 30"W x 13"H 36"W x 13"H 42"W x 13"H 48"W x 13"H 54"W x 13"H 60"W x 13"H	HLSL1230	13	1.5	\$ 241
	HLSL1236	15	1.8	\$ 266
	HLSL1242	18	2.3	\$ 298
	HLSL1248	20	2.3	\$ 340
	HLSL1254	22	2.9	\$ 364
	HLSL1260	24	2.9	\$ 392

NOTES: Bracket is Platinum only, no need to specify.

▲ Available in Frosted Glass ONLY HLSL1230.G.

ABOVE-BELOW PRIVACY SCREEN SELECTION GUIDE

Support Combination		Top Size								
Support 1	Support 2	84 in	72 in	66 in	60 in	54 in	48 in	42 in	36 in	30 in
O-Leg	O-Leg	NA	HLSL2860	HLSL2854	HLSL2848	HLSL2842	HLSL2836	HLSL2830	NA	NA
O-Leg	Slim Profile Pedestal	HLSL2860	HLSL2854	HLSL2848	HLSL2842	HLSL2836	HLSL2830	NA	NA	NA
O-Leg	Bookcase	HLSL2860	HLSL2854	HLSL2848	HLSL2842	HLSL2836	HLSL2830	NA	NA	NA
O-Leg	Pedestal	HLSL2860	HLSL2848	HLSL2842	HLSL2836	HLSL2830	NA	NA	NA	NA
O-Leg	End-Panel	HLSL2860	HLSL2848	HLSL2842	HLSL2836	HLSL2830	NA	NA	NA	NA
Slim Profile Pedestal	Slim Profile Pedestal	HLSL2860	HLSL2848	HLSL2842	HLSL2836	HLSL2830	NA	NA	NA	NA
Slim Profile Pedestal	Bookcase	HLSL2860	HLSL2848	HLSL2842	HLSL2836	HLSL2830	NA	NA	NA	NA
Slim Profile Pedestal	Pedestal	HLSL2854	HLSL2842	HLSL2836	HLSL2830	NA	NA	NA	NA	NA
Slim Profile Pedestal	End-Panel	HLSL2854	HLSL2842	HLSL2836	HLSL2830	NA	NA	NA	NA	NA
Pedestal	Bookcase	HLSL2854	HLSL2842	HLSL2836	HLSL2830	NA	NA	NA	NA	NA
End-Panel	Bookcase	HLSL2854	HLSL2842	HLSL2836	HLSL2830	NA	NA	NA	NA	NA
Bookcase	Bookcase	HLSL2854	HLSL2842	HLSL2836	HLSL2830	NA	NA	NA	NA	NA
End-Panel	End-Panel	HLSL2848	HLSL2836	HLSL2830	NA	NA	NA	NA	NA	NA
Pedestal	Pedestal	HLSL2848	HLSL2836	HLSL2830	NA	NA	NA	NA	NA	NA
Pedestal	End-Panel	HLSL2848	HLSL2836	HLSL2830	NA	NA	NA	NA	NA	NA
O-Leg	Lateral/Multifile	HLSL2842	HLSL2836	HLSL2830	NA	NA	NA	NA	NA	NA
Bookcase	Lateral/Multifile	HLSL2836	NA	NA	NA	NA	NA	NA	NA	NA
Slim Profile Pedestal	Lateral/Multifile	HLSL2836	NA	NA	NA	NA	NA	NA	NA	NA
Pedestal	Lateral/Multifile	HLSL2830	NA	NA	NA	NA	NA	NA	NA	NA
End-Panel	Lateral/Multifile	HLSL2830	NA	NA	NA	NA	NA	NA	NA	NA

How to specify

Select Model Number from above

H | L | S | L | 2 | 8 | 3 | 0 | .

H | L | S | L | 1 | 2 | 3 | 0 | .

1st Option

Select Mixed Material

FT01 Frosted Translucent Acrylic
Specified for Above/Below Privacy Screens only

G Frosted Glass
Specified for Above Privacy Screens only

F | T | 0 | 1 |

G |

➤ Above privacy screens are intended to be attached between users sitting side-by-side but will create 1/8" spacing between the worksurfaces.

➤ Ships complete with attachment brackets.
 ➤ All brackets are Platinum.
 ➤ Above Privacy Screen attaches to top and side of worksurface with adhesive banding.

➤ Lower attachment brackets may be shifted to attach to support components.
 ➤ Above/Below privacy screen extends 20" above and 13" below worksurface.

⚠ Above/Below Fabric Privacy Screens can attach to worksurfaces that are either O-leg supported on both sides, or worksurfaces that are supported by a support pedestal on one side and an O-leg on the other. They cannot be attached to worksurfaces supported by support pedestals on both sides, unless additional hardware is specified.

⚠ Above screens must attach to edgeband and top of surface.
 ⚠ Above/Below privacy screens must be ordered the same width as the worksurface it is being used with to properly attach.
 ⚠ O-legs should not be used with Above/Below Fabric privacy screens.



Description	Model	Ship Weight	Cube	Core List by Price Code	
				A	B
 <p>Above/Below Fabric Privacy Screen 36"W x 35"H 42"W x 35"H 48"W x 35"H 54"W x 35"H 60"W x 35"H 66"W x 35"H 72"W x 35"H</p>	HLSL3635TS	21	3.8	\$ 768	\$ 793
	HLSL4235TS	27	4.4	\$ 808	\$ 833
	HLSL4835TS	33	6.0	\$ 862	\$ 897
	HLSL5435TS	39	6.0	\$ 900	\$ 935
	HLSL6035TS	45	6.0	\$ 957	\$1000
	HLSL6635TS	51	7.4	\$1008	\$1051
	HLSL7235TS	57	7.4	\$1052	\$1095

NOTES: Brackets are Platinum only, no need to specify. Above/Below privacy screens must be ordered the same width as the worksurface it is being used with to properly attach.

 <p>Above Fabric (Side) Privacy Screen 20"W x 20"H 24"W x 20"H 30"W x 20"H 36"W x 20"H</p>	HLSL2020TS	13	1.4	\$ 296	\$ 303
	HLSL2024TS	15	1.4	\$ 305	\$ 313
	HLSL2030TS	17	1.9	\$ 321	\$ 332
	HLSL2036TS	19	2.2	\$ 354	\$ 367
	HLSL1220TS	11	1.1	\$ 278	\$ 284
	HLSL1224TS	13	1.1	\$ 283	\$ 289
	HLSL1230TS	15	1.6	\$ 296	\$ 303
HLSL1236TS	17	1.9	\$ 315	\$ 323	

NOTES: Brackets are Platinum only, no need to specify. Brackets intended to be attached between users sitting side-by-side, and will create 1/8" separation between worksurfaces.

How to specify	<p>Select Model Number from above</p> <p>H L S L 3 6 3 5 T S .</p>	<p>1st Option</p> <p>Select Fabric</p> <p>See pages 310-311</p> <p>P N 1 5</p>
----------------	---	---

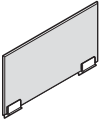
Description	Model	Ship		List
		Weight	Cube	
 <p>Above Frosted Polymer (Side) Privacy Screen 20"W x 13"H 24"W x 13"H 30"W x 13"H 36"W x 13"H</p>	HLSL1220FS	12	1.3	\$ 267
	HLSL1224FS	14	1.4	\$ 284
	HLSL1230FS	16	1.6	\$ 307
	HLSL1236FS	19	1.9	\$ 344

NOTES: Brackets are Platinum only, no need to specify. Brackets intended to be attached between users sitting side-by-side, and will create 1/8" separation between worksurfaces.

 <p>Above Frosted Glass (Side) Privacy Screen 20"W x 13"H 24"W x 13"H 30"W x 13"H 36"W x 13"H</p>	HLSL1220GS	13	1.3	\$ 223
	HLSL1224GS	16	1.4	\$ 237
	HLSL1230GS	18	1.6	\$ 256
	HLSL1236GS	20	1.9	\$ 286

NOTES: Brackets are Platinum only, no need to specify. Brackets intended to be attached between users sitting side-by-side, and will create 1/8" separation between worksurfaces.

How to specify	<p>Select Model Number from above</p> <p>H L S L 1 2 2 0 F S .</p> <p>H L S L 1 2 2 0 G S .</p>	<p>1st Option</p> <p>Select Mixed Material</p> <p>FT01 Frosted Translucent Acrylic Specified for Above Screen models HLSL1220FS–HLSL1236FS only</p> <p>G Frosted Glass Specified for Above Screen models HLSL1220GS–HLSL1236GS only</p> <p>F T 0 1</p> <p>G</p>
----------------	---	---

Voi® Laminate Overhead Storage

GSA SIN 711-2



- ▶ All Overhead Cabinets shown below can be used as a wall mount, panel mount or stack-on storage with O-leg.
- ▶ Tackboards are available for wall mount storage applications and conventional stack-on. Use wall mount tackboards when using O-leg supports.

- ▶ 5½"H and 20½"H O-legs can be purchased to create stack-on storage. Heights line up with Abound® and Accelerate® panels.
- ▶ Overhead cabinets with four doors are available in laminate or mixed materials.

- ▶ Wall mount brackets specified with unit. Brackets attach to case horizontally.
- ▶ For all color specifying combinations, see matrix on page 175.
- ▶ Storage cases accept binder height items.

- ▶ Storage cube fits inside stack-on storage or overhead cabinet units to provide paper management.
- ▶ For panel mounted applications, brackets and hardware are ordered separately, see page 374. Brackets attach to panel and case is screwed into brackets. Two brackets needed for 60" unit; three brackets needed for 66" and larger.

△ **Stack-on Storage must be placed over two full-height supports. Cannot be placed over non-supported sections such as returns using a flat bracket or tower-to-worksurface bracket.**
 △ **Overhead units do not lock.**

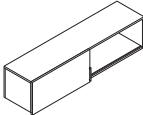

Description	Model	Ship Weight	Cube	L2 Upcharges		
				L1 List	Cabinet	Door
 <p>Overhead Cabinet with One Sliding Door</p> <p>36"W x 14¼"D x 14"H 42"W x 14¼"D x 14"H 48"W x 14¼"D x 14"H 60"W x 14¼"D x 14"H 66"W x 14¼"D x 14"H 72"W x 14¼"D x 14"H 78"W x 14¼"D x 14"H</p>	HLSL1436S	39	9.7	\$ 883	\$ 25	\$ 20
	HLSL1442S	48	9.7	\$ 926	\$ 25	\$ 20
	HLSL1448S	57	12.1	\$ 954	\$ 25	\$ 20
	HLSL1460S	69	13.3	\$1027	\$ 30	\$ 25
	HLSL1466S	83	14.6	\$1134	\$ 30	\$ 25
	HLSL1472S	95	15.9	\$1239	\$ 35	\$ 25
	HLSL1478S	105	18.5	\$1348	\$ 35	\$ 25

How to specify	1st Option	2nd Option	3rd Option	4th Option
<p>Select Model Number from above</p> <p>H L S L 1 4 7 8 S . N .</p>	<p>Select Cabinet Laminate</p> <p>See page 175</p> <p>N .</p>	<p>Select Door Laminate</p> <p>See page 175</p> <p>N .</p>	<p>Select Pull Color</p> <p>T4 Champagne <input type="checkbox"/> T1 Platinum <input type="checkbox"/> WHIT White <input type="checkbox"/> X No Option</p> <p>X .</p>	<p>Specify Bracket Option</p> <p>X No Bracket W Wall Bracket (\$150 upcharge)</p> <p>W</p>

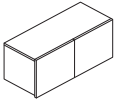
Description	Model	Ship Weight	Cube	L2 Upcharges		
				L1 List	Cabinet	Door
 <p>Overhead Cabinet with Doors</p> <p>36"W x 14¼"D x 14"H, 2 doors 42"W x 14¼"D x 14"H, 2 doors 48"W x 14¼"D x 14"H, 3 doors 60"W x 14¼"D x 14"H, 4 doors</p>	HLSL1436D	39	9.7	\$ 745	\$ 25	\$ 20
	HLSL1442D	48	9.7	\$ 828	\$ 25	\$ 20
	HLSL1448D	57	12.1	\$ 920	\$ 25	\$ 30
	HLSL1460D	115	13.3	\$1027	\$ 30	N/A

△ **2-Door and 3-Door Overhead Cabinet with Doors models HLSL1436D–HLSL1448D available in laminate only. The 60" model HLSL1460D is available in all door finish options—see 2nd Option below.**

 <p>Overhead Cabinet with 4 Doors/Cubbies</p> <p>66"W x 14¼"D x 14"H with 6" Cubbie 72"W x 14¼"D x 14"H with 12" Cubbie 78"W x 14¼"D x 14"H with 18" Cubbie</p>	HLSL1466D	126	14.6	\$1134	\$ 30	N/A
	HLSL1472D	139	15.9	\$1239	\$ 35	N/A
	HLSL1478D	153	18.5	\$1348	\$ 35	N/A

NOTES: Available in laminate or mixed materials.

How to specify	1st Option	2nd Option	3rd Option
<p>Select Model Number from above</p> <p>H L S L 1 4 6 0 D . N .</p>	<p>Select Cabinet Laminate</p> <p>See page 175</p> <p>N .</p>	<p>Select Door Material for 2/3/4 Door Models</p> <p>Upcharges for door selection:</p> <p>T4G Champagne Polymer with Frosted glass \$315 T1G Platinum Polymer with Frosted glass \$315 T4FT01 Champagne with Frosted Translucent Acrylic \$360 T1FT01 Platinum with Frosted Translucent Acrylic \$360</p> <p>Also available in laminate doors. See page 175. Not specified for models HLSL1436D–HLSL1448D. These models are available in laminate only.</p> <p>T 4 G .</p>	<p>Select Bracket Option</p> <p>X No Bracket W Wall Bracket (\$150 upcharge)</p> <p>X</p>

- ▶ Overhead and Stack-on storage units do not lock.
- ▶ Use O-Leg Support models for Overhead Cabinets. See page 197.

- ▶ Storage cube fits inside stack-on storage or wall mount units to provide paper management. See page 197.

- ▶ Storage Cubes are available in the following colors: Autumn (AUTM), Citron (CITR), Flame (FLAM), Pool (POOL) and Sisal (SISL).

⚠ **Stack-on Storage must be placed over two full-height supports. Cannot be placed over non-supported sections such as returns using a flat bracket or tower-to-worksurface bracket.**

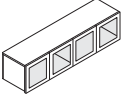
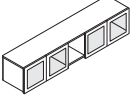
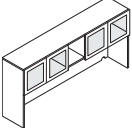

	Description	Model	Ship Weight	Cube	List Price by Laminate Grade	
					L1	L2
	Overhead Cabinet with 4 Frosted, Metal Frame Doors 60"W x 14 1/4"D x 14"H ⚠ Must specify an X or W for attachment bracket option below.	HLSL1460M	115	11.4	\$1676	\$1706
	Overhead Cabinet with 4 Frosted, Metal Frame Doors 78"W x 14 1/4"D x 14"H with 18" Cubbie 72"W x 14 1/4"D x 14"H with 12" Cubbie 66"W x 14 1/4"D x 14"H with 6" Cubbie ⚠ Must specify an X or W for attachment bracket option below.	HLSL1478M HLSL1472M HLSL1466M	153 139 126	14.7 13.6 12.5	\$1996 \$1889 \$1782	\$2031 \$1924 \$1812
	Stack-on Storage, Built-up with 4 Frosted Doors with Metal Frame with Cubbies 72"W x 14 1/4"D x 35"H with 12" Cubbie NOTES: Ships complete with Back Enclosure and laminate End Panels. Ships factory assembled. ⚠ Does not require bracket specification.	HLSL1472MB	165	30.4	\$1990	\$2035

	Description	Model	Ship Weight	Cube	A	B
 18 1/2"H	Tackboard for Wall Mount Overhead Cabinets For 78"W For 72"W For 66"W For 60"W For 48"W For 42"W For 36"W SPECIFYING EXAMPLE: HLSL48TW.DB30	HLSL78TW HLSL72TW HLSL66TW HLSL60TW HLSL48TW HLSL42TW HLSL36TW	13 12 11 10 13 12 11	1.4 1.4 1.4 1.1 1.4 1.4 1.4	\$ 345 \$ 329 \$ 314 \$ 279 \$ 243 \$ 226 \$ 213	\$ 357 \$ 341 \$ 326 \$ 291 \$ 253 \$ 236 \$ 223

How to specify	1st Option	2nd Option	3rd Option
Select Model Number from above	Select Cabinet Laminate See page 175	Select Door Material	Select Bracket Option
H L S L 1 4 6 0 M . N .		T4G Champagne Metal Doors with Frosted Glass (no upcharge) T1G Platinum Metal Doors with Frosted Glass (no upcharge) T4FT01 Champagne Metal Doors with Frosted Translucent Acrylic (\$43 upcharge) T1FT01 Platinum Metal Doors with Frosted Translucent Acrylic (\$43 upcharge)	X No Bracket W Wall Bracket (\$150 upcharge) Not specified for models HLSL1460MB, HLSL1478MB, HLSL1472MB, HLSL1466MB
		T 4 G .	X

Voi® Laminate Shared Overhead Storage Components

GSA SIN 711-2

HON

- ▶ Overall case depth is 19"D including the sliding door.
- ▶ Use Shared Overhead and attachments in small footprint applications.

- ▶ Sliding door is 15"H, providing a 1" valance below the case which can be used as a finger pull if desired.

- ▶ Shared Overhead panel mount brackets and overhead post legs allow overhead to span over all panels systems or run down the spine wall, centered on top of the panel.

- ▶ Post legs can attach to all low credenza models and all worksurface models.
- ▶ Markerboard insert is markerboard laminate with black edges, no frame.



△ Shared Overhead must be ordered as left or right to determine open storage location.

△ Overhead units do not lock.

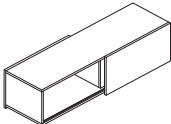





A B J

Description	Model	Ship Weight	Cube	L2 Upcharges		
				L1 List	Cabinet	Door
 Shared Overhead Storage — Left 60"W x 17"D x 14"H 72"W x 17"D x 14"H	HLSL1760SOL	115	14.8	\$1130	\$ 20	\$ 40
	HLSL1772SOL	139	17.0	\$1362	\$ 25	\$ 40

 Shared Overhead Storage — Right 60"W x 17"D x 14"H 72"W x 17"D x 14"H	HLSL1760SOR	115	14.8	\$1130	\$ 20	\$ 40
	HLSL1772SOR	139	17.0	\$1362	\$ 25	\$ 40

Description	Model	Ship Weight	Cube	List Price by Paint Grade	
				Core	Metallics
 Post Legs for Shared Storage 14"H Post Legs 22"H Post Legs	HLSL140SPL	10 	1.1	\$ 299	\$ 303
	HLSL220SPL	13 	3.7	\$ 331	\$ 335

NOTES: 14"H post legs on worksurfaces will span 35"H panel or shorter. 14"H post legs on low credenzas will span 30"H panel or shorter. 22"H post legs on worksurfaces will span 50"H panel or shorter. 22"H post legs on low credenzas will span 35"H panel or shorter.
Specify paint.
SPECIFYING EXAMPLE: HLSL140SPL.T4

   Panel Mount Bracket for Shared Overhead Panel Mount Bracket for Overhead Storage — Accelerate® Panel Mount Bracket for Overhead Storage — Abound® Panel Mount Bracket for Overhead Storage — Accelerate®/Abound® 42½"H panels only	HLSLPMBSOA	4 	0.1	\$ 119	\$ 123
	HLSLPMBSOB	4 	0.1	\$ 119	\$ 123
	HLSLPMBSO42	4 	0.1	\$ 111	\$ 115

NOTES: Specify paint.
SPECIFYING EXAMPLE: HLSLPMBSOA.T4

 Markerboard for Shared Storage 30"W x 13"H for use with 60"W Shared Overhead 36"W x 13"H for use with 72"W Shared Overhead	HLSL1530SOMB	6 	1.0	\$ 118	
	HLSL1536SOMB	8 	1.0	\$ 159	

NOTES: No specification necessary.

How to specify	1st Option	2nd Option
Select Model Number from above H L S L 1 7 6 0 S O L . N .	Select Chassis Laminate See page 175	Select Door Front Laminate See page 175 N

How to specify	1st Option
Select Model Number from above H L S L 1 4 0 S P L . H L S L P M B S O I .	Select Paint Color See page 175 T 4 T 4

   Icon Legend on page 10

- ▶ O-leg ships fully assembled with mounting hardware.
- ▶ Shelves can only be used with 65"H O-leg application.
- ▶ O-legs can be used with all overhead cabinet models. See pages 194 and 195.
- ▶ Storage Cubes are available in the following colors: Autumn (AUTM), Citron (CITR), Flame (FLAM), Pool (POOL) and Sisal (SISL).
- ⚠ **Stack-on Storage must be placed over two full-height supports. Cannot be placed over non-supported sections such as returns using a flat bracket or tower-to-worksurface bracket.**

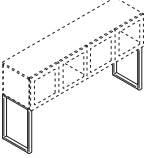

Description	Model	Ship Weight	Cube	List Price by Paint Grade	
				Core Pricing	Core Metallics
 <p>O-Leg Support for Overhead Cabinet Ships 2/pack 14 1/8"D x 20 1/2"H for 65"H Overhead Cabinet 14 1/8"D x 5 1/2"H for 50"H Overhead Cabinet</p> <p>NOTES: The overall height dimension is based on the overhead storage stacking on top of a worksurface. ⚠ Not for use on Shared Overhead Storage, use post leg models on page 196.</p> <p>SIN 711-3</p>	HLSL650S	8	1.1	\$ 413	\$ 417
	HLSL500S	6	1.0	\$ 344	\$ 348

 <p>Steel Shelf for Stack-on Storage 78"W 72"W 66"W 60"W</p> <p>NOTES: Works with O-leg only. ⚠ Installation required for steel shelf onto Stack-on Storage. SPECIFY PAINT: HLSL78S.T5</p>	HLSL78S	35	5.9	\$ 280	\$ 284
	HLSL72S	29	3.4	\$ 262	\$ 266
	HLSL66S	24	3.4	\$ 243	\$ 247
	HLSL60S	20	2.9	\$ 232	\$ 236

Description	Model	Ship Weight	Cube	A		B	
 <p>18 1/2"H Tackboard for Overhead Cabinet Applications For 78"W For 72"W For 66"W For 60"W For 48"W For 42"W For 36"W</p> <p>NOTES: Specify fabric, see pages 310-311. Upcharges may apply to premium fabric grades. SPECIFYING EXAMPLE: HLSL78TW.DB30</p>	HLSL78TW	13	1.4	\$ 345	\$ 357		
	HLSL72TW	12	1.4	\$ 329	\$ 341		
	HLSL66TW	11	1.4	\$ 314	\$ 326		
	HLSL60TW	10	1.1	\$ 279	\$ 291		
	HLSL48TW	13	1.4	\$ 243	\$ 253		
	HLSL42TW	12	1.4	\$ 226	\$ 236		
	HLSL36TW	11	1.4	\$ 213	\$ 223		

Description	Model	Ship Weight	Cube	List
 <p>Storage Cube 12"W x 12"D</p> <p>SPECIFYING EXAMPLE: HLSL1212.CITR</p>	HLSL1212		1	0.3 \$ 269

How to specify	<p>Select Model Number from above</p> <p>H L S L 6 5 0 S .</p>	<p>1st Option</p> <p>Select Paint Color See page 175</p> <p>T 1 </p>
----------------	--	--

Voi® Laminate Stack-on Storage — Built-up

GSA SIN 711-2



▶ Storage cube fits inside stack-on storage or wall mount units to provide paper management.

▶ Overhead and Stack-on storage units do not lock.

▶ Storage Cubes are available in the following colors: Autumn (AUTM), Citron (CITR), Flame (FLAM), Pool (POOL) and Sisal (SISL).

⚠ Tackboards are available for Built-up models only. Tackboards cannot be added to U-leg supported units.

⚠ Stack-on Storage must be placed over two full-height supports. Cannot be placed over non-supported sections such as returns using a flat bracket or tower-to-worksurface bracket.

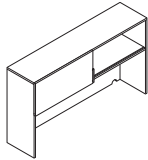

Description	Model	Ship Weight	Cube	L1 List	L2 Upcharges	
					Cabinet	Door
 <p>Stack-on Storage, Built-up, with Sliding Doors 72"W x 14 1/4"D x 35"H</p> <p>Model: HLSL1472SB</p> <p>Ship Weight: 139 Cube: 30.4 L1 List: \$1348 L2 Cabinet: \$ 45 L2 Door: \$ 20</p> <p>NOTES: Ships complete with Back Enclosure and laminate End Panels. Ships factory assembled.</p>						

How to specify	1st Option	2nd Option
<p>Select Model Number from above</p> <p>H L S L 1 4 7 2 S B .</p>	<p>Select Cabinet Laminate</p> <p>See page 175</p> <p>L2 (\$45 upcharge)</p> <p>N .</p>	<p>Select Door Laminate</p> <p>See page 175</p> <p>L2 (\$20 upcharge)</p> <p>N </p>

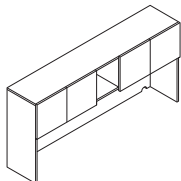
Description	Model	Ship Weight	Cube	L1 List	L2 Upcharges	
					Cabinet	Door
 <p>Stack-on Storage, Built-up, with 4 Doors/Cubbies 72"W x 14 1/4"D x 35"H with 12" Cubbie</p> <p>Model: HLSL1472DB</p> <p>Ship Weight: 144 Cube: 30.4 L1 List: \$1348 L2 Cabinet: \$ 45 L2 Door: N/A</p> <p>NOTES: Ships complete with Back Enclosure and laminate End Panels. Ships factory assembled.</p>						

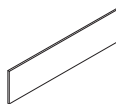
Description	Model	Ship Weight	Cube	A	B
 <p>18 1/2"H</p> <p>Tackboard for Built-up Stack-on Storage For 72"</p> <p>Model: HLSL7265TE</p> <p>Ship Weight: 12 Cube: 1.4 A: \$ 329 B: \$ 341</p> <p>NOTES: For a complete listing of fabrics available for Tackboards, see pages 310-311.</p> <p>SPECIFYING EXAMPLE: HLSL78TE.DB30</p>					

How to specify	1st Option	2nd Option
<p>Select Model Number from above</p> <p>H L S L 1 4 7 2 D B .</p>	<p>Select Cabinet Chassis Laminate</p> <p>See page 175</p> <p>L2 (\$45 upcharge)</p> <p>N .</p>	<p>Select Door Material for 4-Door Models</p> <p>Upcharges for door selection: 4-Door</p> <p>T4G Champagne Polymer with Frosted glass \$315</p> <p>T1G Platinum Polymer with Frosted glass \$315</p> <p>T4FT01 Champagne with Frosted Translucent Acrylic \$360</p> <p>T1FT01 Platinum with Frosted Translucent Acrylic \$360</p> <p>Laminate Grade L2 \$ 40</p> <p>Also available in laminate doors. See page 175.</p> <p>T 4 G </p>

- ▶ Worksurfaces with 7" O-legs, may be placed upon low credenzas to create layering.
- ▶ Chassis and drawer fronts woodgrains and solid laminates are specified separately (see options below).
- ▶ File drawers accept hanging folders in letter or legal size.
- ▶ Multiple handle locations possible per customer preference.
- ▶ Seat cushions are available for low credenzas and mobile pedestals (specify separately).
- ▶ Storage accessory model HSLDRWORG works with box doors.
- ▶ Layering shelf works with low credenzas to provide additional storage areas.
- ▶ File, lateral, and wide box drawers operate on ball-bearing suspension with full extension.
- ▶ Adjustable hex leveling glides allow floor-standing furniture to be easily leveled without lifting the unit; glides have 1/4" adjustable range.
- ▶ Ships with one handle per drawer on all units.

△ **Locking units equipped with HON "One Key" interchangeable core removable locks. Keyed alike core must be ordered separately.**



	Description	Model	Ship Weight	Cube	L1 List	L2 Upcharges	
						Chassis	Front
	Low Credenza, 2 File/2 Box 72"W x 20"D x 21½"H 60"W x 20"D x 21½"H NOTES: Unit is locking.	HLSL2072LD4	230	21.9	\$1449	\$ 40	\$ 40
		HLSL2060LD4	190	18.9	\$1320	\$ 35	\$ 40
	Low Credenza, 2 File Drawers, Open Top 72"W x 20"D x 21½"H 60"W x 20"D x 21½"H NOTES: Unit is non-locking.	HLSL2072LD2	200	21.9	\$1303	\$ 40	\$ 30
		HLSL2060LD2	160	18.9	\$1237	\$ 35	\$ 30
	Low Credenza, Left Hand Drawers 72"W x 20"D x 21½"H 60"W x 20"D x 21½"H NOTES: Unit is locking.	HLSL2072LL2	200	21.9	\$1342	\$ 40	\$ 20
		HLSL2060LL2	160	18.9	\$1131	\$ 35	\$ 20
	Low Credenza, Right Hand Drawers 72"W x 20"D x 21½"H 60"W x 20"D x 21½"H NOTES: Unit is locking.	HLSL2072LR2	200	21.9	\$1342	\$ 40	\$ 20
		HLSL2060LR2	160	18.9	\$1131	\$ 35	\$ 20
	Low Credenza, Open 72"W x 20"D x 21½"H 60"W x 20"D x 21½"H SPECIFYING EXAMPLE: HLSL2072LD0.Z (model.chassis only)	HLSL2072LD0	170	21.9	\$1139	\$1179	N/A
		HLSL2060LD0	130	18.9	\$ 946	\$ 981	N/A
	Low Credenza, 4 Storage Doors 72"W x 20"D x 21½"H 60"W x 20"D x 21½"H NOTES: Unit is locking.	HLSL2072S4	190	21.9	\$1438	\$ 40	\$ 40
		HLSL2060S4	160	18.9	\$1234	\$ 35	\$ 40

Description	Model	Ship Weight	Cube	List Price by Paint Grade		
				Core	Metallics	
	7" O-Leg Support for Worksurfaces 30"D x 7"H	HLSL3070	7	1.0	\$ 239	\$ 243
	24"D x 7"H	HLSL2470	6	1.0	\$ 188	\$ 192
	20"D x 7"H	HLSL2070	5	1.0	\$ 173	\$ 177

Specify: Model. Paint HLSL3070.T1.
NOTES: 7" O-Leg Support to be placed upon Low Credenza models to support worksurfaces. Ship 1/pack.

Description	Model	Ship Weight	Cube	List Price by Paint Grade						
				1	2	3	4	5	6	
	Credenza Cushion 20"W x 36"D x 1"H for 72" Credenzas	HLSL2036CH2	11	2.2	\$ 354	\$ 392	\$ 430	\$ 469	\$ 518	\$ 568
	20"W x 30"D x 1"H for 60" Credenzas	HLSL2030CH2	9	1.9	\$ 328	\$ 364	\$ 400	\$ 436	\$ 482	\$ 529

NOTES: See pages 488-497 and 522-523 for available fabrics.
SPECIFYING EXAMPLE: HLSL2036CH2.AB10

How to specify	1st Option Select Chassis Laminate	2nd Option Select Drawer Front Laminate	3rd Option Select Pull Color
Select Model Number from above	See page 175	See page 175	P Black T4 Champagne T1 Platinum WHIT White Not specified for Open Credenza models HLSL2072LD0, HLSL2060LD0
H L S L 2 0 7 2 L D 4 . N .		N .	T 4

- ▶ Worksurfaces with 7" O-legs, may be placed upon low credenzas to create layering.
- ▶ Chassis and drawer front woodgrains and solid laminates are specified separately (see SIF options below).
- ▶ Metal channel behind credenzas allow cords to run through the case in a continuous run. Also allows cords to run vertically to the worksurface or terminate as a power source in the credenza top. Grommets included for a finished look.
- ▶ File drawers accept hanging folders in letter or legal size.
- ▶ Multiple handle locations possible per customer preference.
- ▶ Ships with one handle per drawer.
- ▶ File, lateral, and wide box drawers operate on ball-bearing suspension with full extension.
- ▶ Drawer Organizer model HLSLDRWORG works with box drawers.
- ▶ Adjustable hex leveling glides allow floor-standing furniture to be easily leveled without lifting the unit; glides have 1/4" adjustable range.

⚠ Locking units equipped with HON "One Key" interchangeable core removable locks. Keyed alike core must be ordered separately.

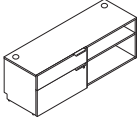
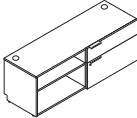

Description	Model	Ship Weight	Cube	L1 List	L2 Upcharges	
					Chassis	Front
 Power-Ready Low Credenza — Left Hand Drawers, Open Right 72"W x 20"D x 21½"H 60"W x 20"D x 21½"H NOTES: Unit is locking.	HLSL2072LL2PWR	200	21.9	\$1512	\$ 40	\$ 20
	HLSL2060LL2PWR	160	18.9	\$1300	\$ 35	\$ 20
 Power-Ready Low Credenza — Right Hand Drawers, Open Left 72"W x 20"D x 21½"H 60"W x 20"D x 21½"H NOTES: Unit is locking.	HLSL2072LR2PWR	200	21.9	\$1512	\$ 40	\$ 20
	HLSL2060LR2PWR	160	18.9	\$1300	\$ 35	\$ 20

How to specify	1st Option	2nd Option	3rd Option	4th Option
Select Model Number from above H L S L 2 0 7 2 L L 2 P W R . N .	Select Chassis Laminate See page 175 N .	Select Drawer Front Laminate See page 175 N .	Select Pull Color P Black T4 Champagne T1 Platinum WHIT White T 4 .	Select Grommet Color P Black WHIT Brilliant White T5 Greige T1 Platinum T 5

- ▶ Worksurfaces with 7" O-legs, may be placed upon low credenzas to create layering.
 - ▶ File drawers accept hanging folders in letter or legal size.
 - ▶ Multiple handle locations possible per customer preference.
 - ▶ Post legs on Shared Overhead are compatible to attach to low credenzas.
 - ▶ Storage accessory model HSLDRWORG works with box doors.
 - ▶ File, lateral, and wide box drawers operate on ball-bearing suspension with full extension.
 - ▶ Utilize in small footprint applications.
 - ▶ Adjustable hex leveling glides allow floor-standing furniture to be easily leveled without lifting the unit; glides have 1/4" adjustable range.
 - ▶ Ships with one handle per drawer on all units.
- ⚠ Locking units equipped with HON "One Key" interchangeable core removable locks. Keyed alike core must be ordered separately.

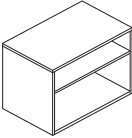
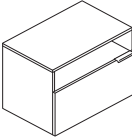
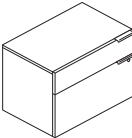

	Description	Model	Ship Weight	Cube	L2 Upcharges		
					L1 List	Chassis	Front
	Low Credenza — Open 30"W x 20"D x 21½"H	HLSL2030LD0	65	9.8	\$ 782	\$ 807	N/A
	36"W x 20"D x 21½"H	HLSL2036LD0	85	12.0	\$ 806	\$ 836	N/A
	Low Credenza — Open Top, File Drawer 30"W x 20"D x 21½"H	HLSL2030LD1	75	9.8	\$ 869	\$ 25	\$ 15
	36"W x 20"D x 21½"H	HLSL2036LD1	95	12.0	\$ 896	\$ 30	\$ 15
	Low Credenza — 1 File Drawer, 1 Box Drawer 30"W x 20"D x 21½"H	HLSL2030LD2	80	9.8	\$ 966	\$ 25	\$ 20
	36"W x 20"D x 21½"H	HLSL2036LD2	100	12.0	\$ 995	\$ 30	\$ 20

How to specify	1st Option	2nd Option	3rd Option
<p>Select Model Number from above</p> <p>H L S L 2 0 3 0 L D 0 . N .</p>	<p>Select Chassis Laminate</p> <p>See page 175</p> <p>N .</p>	<p>Select Drawer Front Laminate</p> <p>See page 175</p> <p>Not specified for Open Credenza models HLSL2030LD0, HLSL2036LD0</p> <p>N .</p>	<p>Select Pull Color</p> <p>P Black T4 Champagne T1 Platinum WHIT White</p> <p>Not specified for Open Credenza models HLSL2030LD0, HLSL2036LD0</p> <p>T 4 </p>

Icon Legend on page 10

Voi® Laminate Mobile Storage

GSA SIN as Noted



- ▶ Chassis and drawer fronts woodgrains and solid laminates are specified separately (see SIF options below).
- ▶ File drawers accept hanging folders in letter or legal size.
- ▶ Multiple handle locations possible per customer preference.
- ▶ Seat cushions are available for low credenzas, floor credenzas, and mobile pedestals (specify separately). See page 202 for Pedestal and Credenza cushion models.
- ▶ Storage accessory model HLSDRWORG works with box doors.
- ▶ Standard box drawers operate on ball-bearing suspension with full extension. File drawers operate on ball-bearing suspension with full extension.
- ▶ Ships with one handle per drawer on all units.

⚠ Locking units equipped with HON "One Key" interchangeable core removable locks. Keyed alike core must be ordered separately.

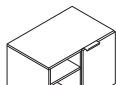

Description	Model	Ship Weight	Cube	L1 List	L2 Upcharges		
					Chassis	Front	
 <p>Mobile Credenza 30"W x 20"D x 21½"H NOTES: Unit is non-locking.</p>	HL2030MCO	80	9.8	\$1238	\$ 25	\$ 10	

SIN 711-3

Description	Model	Ship Weight	Cube	L2 Upcharges					
				1	2	3	4	5	6
 <p>Credenza Cushion 20"W x 30"D x 1"H for 60" Credenzas NOTES: See pages 488-497 and 522-523 for available fabrics. SPECIFYING EXAMPLE: HL2030CH2.AB10</p>	HL2030CH2	9	1.9	\$ 328	\$ 364	\$ 400	\$ 436	\$ 482	\$ 529

SIN 711-3

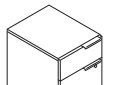
Description	Model	Ship Weight	Cube	L1 List	L2 Upcharges		
					Chassis	Front	
 <p>Mobile Pedestal 15¾"W x 20⅞"D x 21⅞"H NOTES: Unit is locking.</p>	HL2016MP2	65	5.7	\$ 716	\$ 20	\$ 10	

SIN 711-2

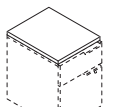
Description	Model	Ship Weight	Cube	L2 Upcharges					
				1	2	3	4	5	6
 <p>Mobile Pedestal Cushion 15⅞"W x 20"D x 1"H for Pedestals NOTES: See pages 488-497 and 522-523 for available fabrics. SPECIFYING EXAMPLE: HL2016PH2.AB10</p>	HL2016PH2	6	1.1	\$ 273	\$ 297	\$ 321	\$ 345	\$ 376	\$ 407

SIN 711-2

How to specify	1st Option	2nd Option	3rd Option
<p>Select Model Number from above</p> <p>H L S L 2 0 3 0 M C O . N .</p>	<p>Select Chassis Laminate</p> <p>See page 175</p> <p>N .</p>	<p>Select Drawer Front Laminate</p> <p>See page 175</p> <p>N .</p>	<p>Select Pull Color</p> <p>P Black T4 Champagne T1 Platinum WHIT White T 4</p>

ABJ Icon Legend on page 10

- ▶ Ships with one handle per drawer on all units.
- ▶ All models shown below are locking.

- ▶ Chassis and drawer fronts woodgrains and solid laminates are specified separately (see SIF options below).

- ▶ File drawers accept hanging folders in letter or legal size.
- ▶ Multiple handle locations possible per customer preference.

- ▶ Adjustable hex leveling glides allow floor-standing furniture to be easily leveled without lifting the unit; glides have 1/4" adjustable range.

⚠ **Locking units equipped with HON "One Key" interchangeable core removable locks. Keyed alike core must be ordered separately.**

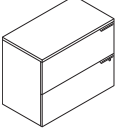
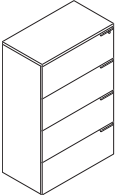
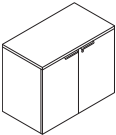
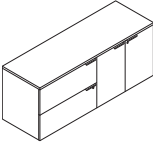

	Description	Model	Ship Weight	Cube	L1 List	L2 Upcharges	
						Chassis	Front
	2-Drawer Lateral Files 36"W x 24"D x 29½"H 36"W x 20"D x 29½"H	HLSL2436L2	305	29.8	\$1136	\$ 35	\$ 20
		HLSL2036L2	170	15.7	\$1019	\$ 30	\$ 20
	4-Drawer Lateral Files 36"W x 24"D x 57"H 36"W x 20"D x 57"H	HLSL2436L4	366	35.9	\$1617	\$ 45	\$ 30
		HLSL2036L4	204	18.3	\$1518	\$ 40	\$ 30
	Storage Cabinet 36"W x 24"D x 29½"H 36"W x 20"D x 29½"H	HLSL2436SC	150	18.3	\$ 860	\$ 35	\$ 20
		HLSL2036SC	147	15.7	\$ 808	\$ 30	\$ 20
	Lateral/Storage Cabinet Credenza 72"W x 24"D x 29½"H	HLSL2472LC	300	35.6	\$2339	\$ 45	\$ 30

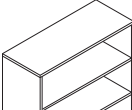
	Bookcase Hutch (no doors) 36"W x 14"D x 35"H	HLSL1436BH	125	3.7	\$ 621	\$ 641	N/A
---	---	------------	-----	-----	--------	--------	-----

NOTES: Bookcase Hutch model works with Storage Cabinet and Lateral File models shown above.
⚠ **Specify: Chassis laminate only.**

How to specify	1st Option	2nd Option	3rd Option
<p>Select Model Number from above</p> <p>H L S L 2 0 3 6 L 2 . N .</p>	<p>Select Chassis Laminate See page 175</p> <p>N .</p>	<p>Select Drawer Front Laminate See page 175 Not specified for model HLSL1436BH</p> <p>N .</p>	<p>Select Pull Color</p> <p>P Black T4 Champagne T1 Platinum WHIT White</p> <p>Not specified for Bookcase Hutch model HLSL1436BH</p> <p>T 4 </p>

Voi® Laminate Storage Towers

GSA SIN 711-2 Except as Noted



- ▶ Use the worksurface to tower bracket kit to attach worksurfaces to Storage Towers models shown below.
- ▶ Chassis and drawer fronts woodgrains and solid laminates are specified separately (see SIF options below).
- ▶ File drawers accept hanging folders in letter or legal size.
- ▶ Wardrobe, middle box drawer and file drawer are locking.
- ▶ Standard box drawers operate on ball-bearing suspension with full extension. File, lateral, and wide box drawers operate on ball-bearing suspension with full extension.
- ▶ Ships with one handle per drawer on all units.
- ▶ Adjustable hex leveling glides allow floor-standing furniture to be easily leveled without lifting the unit; glides have 1/4" adjustable range.
- ▶ Wardrobe/storage cabinet includes coat rod.
- ▶ Wardrobes contain easy access side storage shelves.

⚠ Locking units equipped with HON "One Key" interchangeable core removable locks. Keyed alike core must be ordered separately.



Description	Model	Ship Weight	Cube	L1 List	L2 Upcharges		
					Chassis	Front	
	24"W x 20"D Storage Tower — Right Hand Drawers, Left Hand Door 24"W x 20"D x 50"H, Left	HLSLW045L	167	17.4	\$1700	\$ 50	\$ 35
	24"W x 20"D x 65"H, Left	HLSLW046L	200	22.5	\$1938	\$ 55	\$ 35
	24"W x 20"D Storage Tower — Left Hand Drawers, Right Hand Door 24"W x 20"D x 50"H, Right	HLSLW045R	167	17.4	\$1700	\$ 50	\$ 35
	24"W x 20"D x 65"H, Right	HLSLW046R	200	22.5	\$1938	\$ 55	\$ 35
	24"W x 24"D Storage Tower — Right Hand Drawers, Left Hand Door 24"W x 24"D x 50"H, Left	HLSLW445L	200	20.7	\$1841	\$ 55	\$ 35
	24"W x 24"D x 65"H, Left	HLSLW446L	240	27.8	\$2041	\$ 60	\$ 35
	24"W x 24"D Storage Tower — Left Hand Drawers, Right Hand Door 24"W x 24"D x 50"H, Right	HLSLW445R	200	20.7	\$1841	\$ 55	\$ 35
	24"W x 24"D x 65"H, Right	HLSLW446R	240	27.8	\$2041	\$ 60	\$ 35
	24"W x 24"D Personal Storage Tower 24"W x 24"D x 65"H, Left	HLSLW446LP	250	27.8	\$2311	\$ 60	\$ 35
	24"W x 24"D x 65"H, Right	HLSLW446RP	250	27.8	\$2311	\$ 60	\$ 35

Description	Model	Ship Weight	Cube	List by Paint Grade		
				Core	Choice/Metallics	Custom
<p>Worksurface to Tower Bracket Kit Bracket to attach storage towers or pedestal to worksurfaces.</p> <p>NOTES: Can be used in place of end panel or O-leg to support worksurfaces. ⚠ Bracket cannot be used as a support when placing Stack-on Storage on worksurface over bracket. Must use two full-sized supports when using Stack-on Storage.</p>	HSTB2W1	4	0.6	\$ 68	\$ 81	\$ 92

SIN 711-3

How to specify	1st Option	2nd Option	3rd Option
Select Model Number from above H L S L W 0 4 5 L . N .	Select Chassis Laminate See page 175 N .	Select Drawer Front Laminate See page 175 N .	Select Pull Color P Black T4 Champagne T1 Platinum WHIT White T 4

- ▶ Ships with one handle per drawer on all units.
- ▶ Chassis and drawer fronts woodgrains and solid laminates are specified separately (see SIF options below).

- ▶ File drawers accept hanging folders in letter or legal size.
- ▶ Standard box drawers operate on ball-bearing suspension with full extension. File and box drawers operate on ball-bearing suspension with full extension.

- ▶ Adjustable hex leveling glides allow floor-standing furniture to be easily leveled without lifting the unit; glides have 1/4" adjustable range.
- ▶ Wardrobe/storage cabinet includes coat rod.
- ▶ Wardrobes contain easy access side storage shelves.

- ▶ Wardrobe, middle box drawer and file drawer are locking.
- ▶ Locking units equipped with HON "One Key" interchangeable core removable locks. Keyed alike core must be ordered separately.

⚠ **Worksurface-to-tower bracket cannot be used as a support when placing Stack-on Storage on worksurface over bracket. Must use two full-sized supports when using Stack-on Storage.**



Description	Model	Ship Weight	Cube	L1 List	L2 Upcharges		
					Chassis	Front	
	18"W x 20"D Storage Towers — Right Hand Drawers, Left Hand Door						
	18"W x 20"D x 50"H, Left	HLSLW085L	139	13.4	\$1530	\$ 45	\$ 35
	18"W x 20"D x 65"H, Left	HLSLW086L	167	17.3	\$1748	\$ 50	\$ 35
	18"W x 20"D Storage Towers — Left Hand Drawers, Right Hand Door						
	18"W x 20"D x 50"H, Right	HLSLW085R	139	13.4	\$1530	\$ 45	\$ 35
	18"W x 20"D x 65"H, Right	HLSLW086R	167	17.3	\$1748	\$ 50	\$ 35
	18"W x 24"D Storage Towers — Right Hand Drawers, Left Hand Door						
	18"W x 24"D x 50"H, Left	HLSLW485L	167	15.8	\$1741	\$ 50	\$ 35
	18"W x 24"D x 65"H, Left	HLSLW486L	200	21.5	\$1941	\$ 55	\$ 35
	18"W x 24"D Storage Towers — Left Hand Drawers, Right Hand Door						
	18"W x 24"D x 50"H, Right	HLSLW485R	167	15.8	\$1741	\$ 50	\$ 35
	18"W x 24"D x 65"H, Right	HLSLW486R	200	21.5	\$1941	\$ 55	\$ 35

How to specify	1st Option	2nd Option	3rd Option
<p>Select Model Number from above</p> <p>H L S L W 0 8 5 L . N .</p>	<p>Select Chassis Laminate</p> <p>See page 175</p>	<p>Select Door/Drawer Front Laminate</p> <p>See page 175</p>	<p>Select Pull Color</p> <p>P Black T4 Champagne T1 Platinum WHIT White T 4 </p>

▶ Bookcases available in 2, 3 and 4 shelf models. ▶ Adjustable glides allow bookcases to be easily leveled. Glides have 1/4" of adjustability.



Description	Model	Ship Weight	Cube	List Price by Laminate Grade	
				L1	L2
Bookcase					
36"W x 13"D x 29½"H, 2-Shelf	HLSL1336B2	90	10.7	\$ 493	\$ 508
36"W x 13"D x 50"H, 3-Shelf	HLSL1336B3	122	17.3	\$ 635	\$ 655
36"W x 13"D x 65"H, 4-Shelf	HLSL1336B4	156	22.2	\$ 748	\$ 773

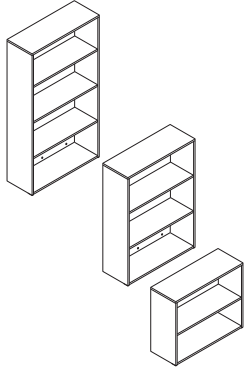

How to specify	<p>Select Model Number from above</p> <p>H L S L 1 3 3 6 B 2 .</p>	<p>1st Option</p> <p>Select Laminate</p> <p>See page 175</p> <p>N</p>
----------------	--	---

- ▶ Layering shelf works with lower credenzas to provide additional storage areas.
- ▶ Storage Cubes and Drawer Organizers are available in the following colors: Autumn (AUTM), Citron (CITR), Flame (FLAM), Pool (POOL) and Sisal (SISL).
- ⚠ Layering Shelves cannot be stacked.
- ⚠ Cannot add a hutch on top of a layering shelf.

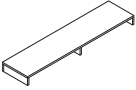

Description	Model	Ship Weight	Cube	L1 List	L2 Upcharge
 Layering Shelf 72"W x 14½"D x 5½"H 60"W x 14½"D x 5½"H	HLSL1472LS	50	4.6	\$ 384	\$ 10
	HLSL1460LS	39	1.3	\$ 321	\$ 10

Description	Model	Ship Weight	Cube	List
 Storage Cube 12"W x 12"D SPECIFYING EXAMPLE: HLSL1212.CITR	HLSL1212	1.0	0.3	\$ 269

Description	Model	Ship Weight	Cube	List
 Drawer Organizer 12"W x 14½"D x 1½"H SPECIFYING EXAMPLE: HLSLDRWORG.POOL	HLSLDRWORG	1.0	0.5	\$ 139

Description	Model	Ship Weight	Cube	List
 Markerboard 48"W x 31"H NOTES: No specification required.	HLSL4831MB	44.0	3.4	\$ 597

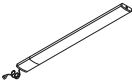





 LED Task Lights 17" LED Light with Power Supply (Single) 31" LED Light with Power Supply (Single)	Model	Ship Weight	Cube	List	
	HLED17AS	1.2	0.05	\$ 374	
	HLED31AS	1.5	0.09	\$ 503	
	17" LED Light with Power Supply for Daisy-chain (Starter) 31" LED Light with Power Supply for Daisy-chain (Starter)	HLED17A	1.0	0.05	\$ 411
	HLED31A	1.4	0.09	\$ 553	
	17" LED Light with 8" Jumper Cord for Daisy-chain (Follower) 31" LED Light with 8" Jumper Cord for Daisy-chain (Follower)	HLED17AUO	1.0	0.03	\$ 335
HLED31AUO	1.0	0.05	\$ 448		
Undercabinet Occupancy Sensor with 1" End to End Connector	HLEDOSA	0.2	0.01	\$ 78	

NOTES: To use the daisy chain application, must start with model HLED17A or HLED31A. No finish specification required. Attaches magnetically to underside of overhead storage, or attaches with provided screws or double-sided tape. Occupancy sensor attaches to a single or starter LED light and will automatically turn the light off after no motion is detected for 30 minutes. Just like all the LED light models, the occupancy sensor features a soft-touch on/off switch. LED task lights have a lifetime of 50,000 hours and have a dimmer feature that allows the user to adjust the amount of light output.

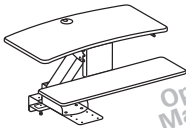
Voi® Worksurface with Accessory Selection Guide			Grommet & External Channel			
Accessory Type	Model	Clearance	20"D	24"D	30"D	36"D
CPU Holder	HCPU	13½"	N	Y	Y	Y
Keyboard Tray	H1706	17¼"	N	N	Y	Y
Keyboard Tray	H2107	21¼"	N	N	Y	Y
Keyboard Tray	H2516	24"	N	N	N	Y
Veneer Center Drawer	H90250	18"	N	N	Y	Y
Laminate Center Drawer	H1522	18½"	N	N	Y	Y
Laminate Center Drawer	H1526	18½"	N	N	Y	Y
Metal Center Drawer	HD2	20¼"	N	N	Y	Y
Metal Center Drawer	HDB	20¼"	N	N	Y	Y
Keyboard Tray	H4022	17"	N	N	Y	Y
Keyboard Tray	HE4022	17"	N	N	Y	Y
Keyboard Tray	H4028	15"	N	Y	Y	Y
Keyboard Tray	H4029	15"	N	Y	Y	Y

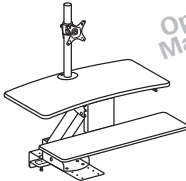
How to specify	Select Model Number from above H L S L 1 4 7 2 L S .	1st Option Select Laminate See page 175 L2 (\$10 upcharge)
----------------	--	---

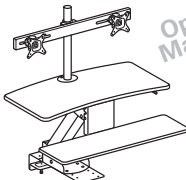
- ▶ These products are designed to allow the user to transition from seating position to standing position throughout the workday.
 - ▶ Gas-assist lever-operated mechanism with positive stop.
 - ▶ Clamp mount compatible with worksurfaces depths of 20"-30".
 - ▶ Clamp requires 3.5" of clearance along back edge of worksurface.
 - ▶ Black seamless worksurfaces.
 - ▶ Silver powder coated metal components.
 - ▶ Lowers below worksurface level on 24" and 30"D worksurfaces.
 - ▶ All models contain a large primary worksurface and a smaller keyboard / mouse surface.
 - ▶ Beveled edges for sleek appearance and comfort while typing.
 - ▶ Monitor arms include height, width, and swivel adjustment.
- ⚠ **Not recommended for use on mobile (castered) worksurfaces.**

	Description	Model	Ship Weight	Cube	List
	Directional™ Desktop Sit-to-Stand Device NOTES: Does not include a monitor arm and is suitable for laptops and/or monitors on their original stands.	HS1100	60 	3.2	\$ 525
	Directional™ Desktop Sit-to-Stand Device with Single Monitor Arm NOTES: Includes a monitor arm for a single monitor.	HS1101	62 	3.2	\$ 615
	Directional™ Desktop Sit-to-Stand Device with Dual Monitor Arm NOTES: Includes a monitor arm for dual monitors.	HS1102	63 	3.2	\$ 700

Mounting and Compatibility:

- This product is intended to be installed on commercial-grade worksurfaces in good condition.
- Compatible with freestanding worksurfaces 24"-30"D or panel-supported worksurfaces 24"-30"D.
- Not for use on mobile worksurfaces.

Clamp Mount

Use when 3.5" minimum overhang is available

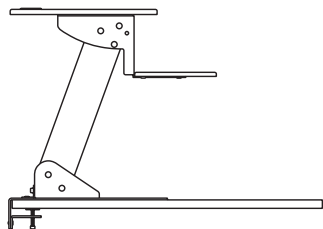

Screw Mount

Use when no overhang is available. Worksurface must be minimum 1" thick.

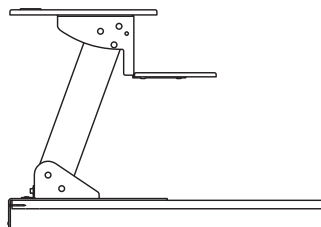

How to specify

Select Model Number from above

H S 1 1 0 0

⚠  Icon Legend on page 10

- ▶ Specify with power-ready casegoods.
- ▶ Includes all mounting hardware.
- ▶ In-Feeds work with a power pole, wall in-feed, or a floor core.
- ▶ In-Feed to be installed by certified electrician.
- ▶ UL 183 Listed to be exposed.
- ▶ Credenza Power Packs have three open connection points on each end (splitters).
- ▶ A/C Grommets are available in two lengths and two circuits for use with Low Credenzas or the grommet cutout on a worksurface.



	Description	Model	Ship Weight	Cube	List
	Electrical Power Jumper				
	12" Jumper	HMAJUMP12	0.5	0.2	\$ 72
	18" Jumper	HMAJUMP18	0.8	0.2	\$ 80
	24" Jumper	HMAJUMP24	1.0	0.2	\$ 86
	30" Jumper	HMAJUMP30	1.0	0.2	\$ 94
	36" Jumper	HMAJUMP36	1.5	0.2	\$ 98
	42" Jumper	HMAJUMP42	1.8	0.2	\$ 110
	48" Jumper	HMAJUMP48	2.0	0.2	\$ 120
	54" Jumper	HMAJUMP54	2.3	0.2	\$ 133
	60" Jumper	HMAJUMP60	2.5	0.2	\$ 143
	66" Jumper	HMAJUMP66	2.8	0.2	\$ 151
	72" Jumper	HMAJUMP72	3.0	0.2	\$ 158
	84" Jumper	HMAJUMP84	3.5	0.2	\$ 171
	96" Jumper	HMAJUMP96	4.0	0.2	\$ 188
	108" Jumper	HMAJUMP108	4.5	0.2	\$ 200
	120" Jumper	HMAJUMP120	5.0	0.2	\$ 214
132" Jumper	HMAJUMP132	5.5	0.2	\$ 225	
144" Jumper	HMAJUMP144	6.0	0.2	\$ 238	
▲ No color options. Specify X when ordering. Example: HMAJUMP12.X.					
	Power In-Feed				
	6' Metal Conduit Power In-feed	HMAINFEED72	1.6	0.3	\$ 146
	13' Metal Conduit Power In-feed	HMAINFEED156	3.5	0.3	\$ 207
▲ No color options. Specify X when ordering. Example: HMAINFEED72.X.					
	6' Sealtight Power In-Feed	HMAINFEED72ST	1.6	0.3	\$ 121
▲ No color options. Specify P when ordering. Example: HMAINFEED72ST.P.					
	Credenza Power Packs				
	For 60" Credenza 36" Jumper and two four-way splitters	HMACREDPK60	0.3	0.9	\$ 126
	For 72" Credenza 48" Jumper and two four-way splitters	HMACREDPK72	0.3	1.2	\$ 136
▲ No color options. Specify X when ordering. Example: HMACREDPK60.X.					
	Hardwire Power Hub				
	Circuit 1 Hardwired 3" Power Hub grommet for worksurface	HGRMTAC1HW34	8.0	0.9	\$ 139
	Circuit 1 Hardwired 3" Power Hub grommet for low and floor credenza	HGRMTAC1HW26	8.0	0.9	\$ 139
	Circuit 2 Hardwired 3" Power Hub grommet for worksurface	HGRMTAC2HW34	8.0	0.9	\$ 139
	Circuit 2 Hardwired 3" Power Hub grommet for low and floor credenza	HGRMTAC2HW26	8.0	0.9	\$ 139
	NOTES: Includes black grommet housing.				
▲ Available in Black only. Specify P when ordering. Example: HGRMTAC1HW34.P.					

How to specify	Select Model Number from above	1st Option
	H M A J U M P 1 2 .	Select Color
		X
		P Black
	H G R M T A C 1 H W 3 4 .	P

Icon Legend on page 10

Voi® Hardwire Electrical Components

GSA SIN 711-2



- ▶ Duplex receptacles accept a standard 15 amp plug and a maximum of 13 duplexes per circuit.
- ▶ 8-Wire to 4-Wire Connector allows hardwire power components to directly connect to system power components (panel system). This component takes the place of a duplex on the panel.
- ▶ Model HMASPLIT is a hardwire connector that allows branching off while keeping the ability to continue straight for longer or larger office layouts. Can also be used as a coupler between jumpers.



	Description	Model	Ship Weight	Cube	List
	Electrical Connectors				
	4-Way Splitter — Single Pack	HMASPLIT	1.0	0.2	\$ 42
	4-Way Splitter — 5-Pack	HMASPLITBP5	2.5	0.2	\$ 180
	2"W x 2"D				
	8-Wire to 4-Wire Connector	HMA8T04CON	1.4	0.2	\$ 158
	48"W				
	Duplex Receptacle Connector	HMADCON	1.4	0.2	\$ 33
	2"W				
⚠ Electrical connector models are available in Black only. Specify with a .P.					
	Duplex Receptacles				
	Circuit 1 Duplex Receptacle — Single Pack	HMADUPLX1	1.4	0.2	\$ 64
	Circuit 1 Duplex Receptacle — 5-Pack	HMADUPLX1BP5	3.5	0.2	\$ 292
	6"W x 2"D x 1"H				
	Circuit 2 Duplex Receptacle — Single Pack	HMADUPLX2	1.4	0.2	\$ 64
	Circuit 2 Duplex Receptacle — 5-Pack	HMADUPLX2BP5	3.5	0.2	\$ 292
	6"W x 2"D x 1"H				
⚠ Available in Black only. Specify P when ordering. Example: HMADUPLX1.P.					

Voi® Software Electrical Components

GSA SIN as Noted





	Description	Model	Ship Weight	Cube	List
	Software Power Hub, 3" Grommet Mount	HGRMTAC	1.3	0.2	\$ 100
SIN 71-302	<ul style="list-style-type: none"> • Fits in 3" round grommet holes • Field installed with Plug-and-play ease • Two grounded AC power outlets • Includes 6' cord with three-prong plug 				
⚠ Available in Black only. Specify X when ordering. Example: HGRMTAC.X.					
	Data Grommet	HGRMTDATA	0.2	0.2	\$ 15
SIN 711-11	Blank grommet kit that includes adapters for a variety of manufacturers jacks and couplers. <ul style="list-style-type: none"> • Fits in 3" round grommet holes 				
⚠ Available in Black only. Specify P when ordering. Example: HGRMTDATA.P.					

How to specify	Select Model Number from above H M A S P L I T .	1st Option Select Color P Black P
----------------	---	--

Icon Legend on page 10

► Wire Management Tray connects to external channel or worksurface and allows for extra storage of coiled wires.



	Description	Model	Ship Weight	Cube	List
 SIN 711-2	O-Leg Cord Clips Clips for 28½" Worksurface O-Legs — 8-Pack Clips for Stack-on Storage, Hutch and Layering O-Legs — 4-Pack NOTES: Wire clips work with 7" Low Credenza O-leg and 29"H Support O-leg. Wire clips also work with the 50" and 65" Hutch O-legs. ▲ Available in frosted plastic material only.	HWMCLIPLG HWMCLIPSM	0.8 [S] 0.5 [S]	0.1 0.1	\$ 86 \$ 55
	Cable Management Troughs 17"W — Single 17"W — 10-Pack 36"W — Single 36"W — 10-Pack • Cable management troughs ship flat packed. • The troughs attach to underneath the worksurface with screws. • The 17"W has one wire access cut out on the user side. The 36" has two wire access cut outs. These cut outs give users access to inside the trough without having to detach it from the worksurface. • Color: Graphite. • Material: Metal. • TAA Compliant.	HCTROUGH17 HCTROUGH1710 HCTROUGH36 HCTROUGH3610	2.7 [S] 14.0 [S] 4.9 [S] 30.0 [S]	0.5 0.5 0.9 0.9	\$ 60 \$ 568 \$ 101 \$ 959
 SIN 711-11 Specify paint color for HH870070, not available in Putty	Power Pole — w/o Receptacles 10'5" ▲ Specify paint; not available in Putty (L).	HH870070	14.0	0.5	\$ 375
 SIN 711-8	Field Installable Grommet • Intended for use in tops and end panels to route/hide cords and in modesty panels to facilitate reaching wall electrical outlets. • Grommet is field installable. • Grommet shape is round. • Includes grommet cap and sleeve. • Grommet outside dimensions measure 3½" diameter and includes two cord access holes. • Grommet sleeve measures 3" O.D. x 1" thick. • Includes instructions to locate grommet position for desks, credenzas, returns and bridges. ▲ Black Finish ▲ Requires a 3" diameter hole saw and drill for installation (not included). ▲ Not for use with credenzas, pedestals, laterals or towers.	HFLDGRMT3	0.1 [S]	0.3	\$ 28

How to specify	Select Model Number from above H L S L W M T R A Y .	1st Option Select Color P Black P
----------------	---	--

AB1 ▲ [S] Icon Legend on page 10

10500 Series™ — Typical

HON



Components used are listed on pages 214-246. Order components individually. Other configurations are possible, including various sizes of some components.

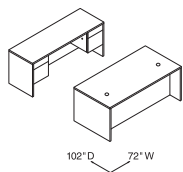

Qty.	Model #	Description	List Price	Price Extension
1	H10593	Double Pedestal Desk – 2/2 72"W x 36"D x 29½"H	\$1,287	\$1,287
1	H10543	Credenza with Kneespace – 2/0/2 72"W x 24"D x 29½"H	\$1,147	\$1,147
TOTAL:			\$2,434	

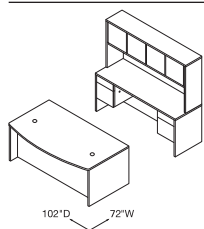

Qty.	Model #	Description	List Price	Price Extension
1	H10595	Double Pedestal Bow Top Desk – 2/2 72"W x 36"D x 29½"H	\$1,444	\$1,444
1	H10543	Credenza with Kneespace – 2/0/2 72"W x 24"D x 29½"H	\$1,147	\$1,147
1	H10534	Stack-on Storage 72"W x 14⅝"D x 37⅞"H	\$ 935	\$ 935
TOTAL:			\$3,526	

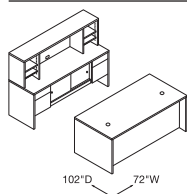

Qty.	Model #	Description	List Price	Price Extension
1	H10593	Double Pedestal Desk – 2/2 72"W x 36"D x 29½"H	\$1,287	\$1,287
1	H10544	Credenza with Doors 72"W x 24"D x 29½"H	\$1,399	\$1,399
1	H105388	Stack-on PC Organizer 72"W x 14⅝"D x 22"H	\$ 753	\$ 753
TOTAL:			\$3,439	

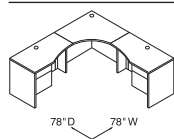

Qty.	Model #	Description	List Price	Price Extension
1	H105818L	Curved Return Left, b/f 42"W x 18-24"D x 29½"H	\$774	\$ 774
1	H105810	Curved Corner Unit 18" x 36" x 36" x 18" x 29½"H	\$714	\$ 714
1	H105817R	Curved Return, Right – b/f 42"W x 18-24"D x 29½"H	\$774	\$ 774
TOTAL:			\$2,262	

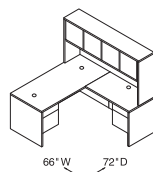
Desk Workstation
72"W x 102"D

Qty.	Model #	Description	List Price	Price Extension
1	H10584L	Single Pedestal Desk, Left – b/f 66"W x 30"D x 29½"H	\$961	\$ 961
1	H10511R	Return, Right – b/f 42"W x 24"D x 29½"H	\$757	\$ 757
1	H10534	Stack-on Storage 72"W x 14⅝"D x 37⅞"H	\$935	\$ 935
TOTAL:			\$2,653	

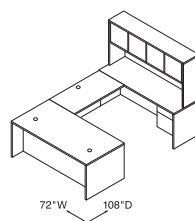
Desk "L" Workstation – Right
66"W x 72"D

Qty.	Model #	Description	List Price	Price Extension
1	H10586L	Single Pedestal Desk, Left – b/f 72"W x 36"D x 29½"H	\$1,093	\$1,093
1	H10570	Bridge 47"W x 24"D x 29½"H	\$ 335	\$ 335
1	H10545R	Single Pedestal Credenza, Right – b/f 72"W x 24"D x 29½"H	\$ 945	\$ 945
1	H10534	Stack-on Storage 72"W x 14⅝"D x 37⅞"H	\$ 935	\$ 935
TOTAL:			\$3,308	

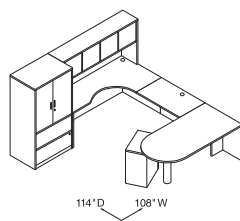
Desk "U" Workstation
72"W x 108"D

Qty.	Model #	Description	List Price	Price Extension
1	H10521	Peninsula with End Panel 72"W x 36"D x 29½"H	\$ 811	\$ 811
1	H10560	Bridge 42"W x 24"D x 29½"H	\$ 323	\$ 323
1	H105816L	Extended Corner Unit, Left 72"W x 24"-36"D x 29½"H	\$ 993	\$ 993
1	H105102	Mobile Pedestal – b/b/f 15¼"W x 22¼"D x 28"H	\$ 789	\$ 789
1	H10534	Stack-on Storage 72"W x 14⅝"D x 37⅞"H	\$ 935	\$ 935
1	H105293	Storage Cabinet/Lateral File 36"W x 24"D x 66⅞"H	\$2,109	\$2,109
TOTAL:			\$5,960	

Peninsula "U" Workstation – Left
108"W x 114"D

Components used are listed on pages 214-246. Order components individually. Other configurations are possible, including various sizes of some components.

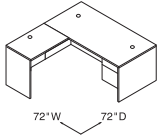

Desk and Return 6' x 6' Workstation
72"W x 72"D

Qty.	Model #	Description	List Price	Price Extension
1	H10585R	Single Pedestal Desk, Right – b/f 72"W x 36"D x 29½"H	\$1,093	\$1,093
1	H105680	Return Shell 36"W x 24"D x 29½"H	\$ 454	\$ 454
TOTAL:			\$1,547	

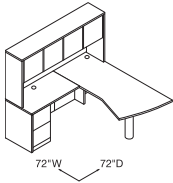

Peninsula "L" Workstation
72"W x 72"D

Qty.	Model #	Description	List Price	Price Extension
1	H105205R	Rudder Peninsula with End Panel, Right 72"W x 30/38"D x 29½"H	\$1,029	\$1,029
1	H105908L	Return, Left – f/f 42"W x 24"D x 29½"H	\$ 870	\$ 870
1	H10534	Stack-on Storage 72"W x 14⅝"D x 37⅞"H	\$ 935	\$ 935
TOTAL:			\$2,834	

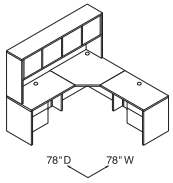

Corner Unit and Returns
78"W x 78"D

Qty.	Model #	Description	List Price	Price Extension
1	H10512L	Return, Left – b/f 42"W x 24"D x 29½"H	\$ 757	\$ 757
1	H105811	Corner Unit 24" x 36" x 36" x 24" x 29½"H	\$ 714	\$ 714
1	H10511R	Return, Right – b/f 42"W x 24"D x 29½"H	\$ 757	\$ 757
1	H105327	Stack-on Storage 78"W x 14⅝"D x 37⅞"H	\$1,059	\$1,059
TOTAL:			\$3,287	

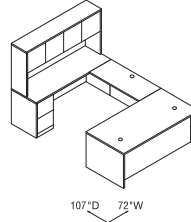

"U" Workstation with Full Pedestals
72"W x 107"D

Qty.	Model #	Description	List Price	Price Extension
1	H105895R	Single Full Pedestal Desk, Right – b/b/f 72"W x 36"D x 29½"H	\$1,260	\$1,260
1	H10570	Bridge 47"W x 24"D x 29½"H	\$ 335	\$ 335
1	H105904L	Single Full Pedestal Credenza, Left – f/f 72"W x 24"D x 29½"H	\$1,120	\$1,120
1	H10534	Stack-on Storage 72"W x 14⅝"D x 37⅞"H	\$ 935	\$ 935
TOTAL:			\$3,650	

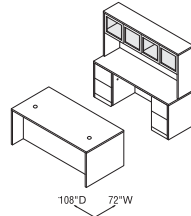

**Desk/Credenza/Stack-on Storage
with Frosted Doors**
72"W x 108"D

Qty.	Model #	Description	List Price	Price Extension
1	H105890	Double Full Pedestal Desk – 3/2 72"W x 36"D x 29½"H	\$1,575	\$1,575
1	H105900	Credenza with Kneespace – 2/0/2 72"W x 24"D x 29½"H	\$1,381	\$1,381
1	H10534G	Stack-on Storage, Frosted Doors with Silver Frame 72"W x 14⅝"D x 37⅞"H	\$1,535	\$1,535
TOTAL:			\$4,491	

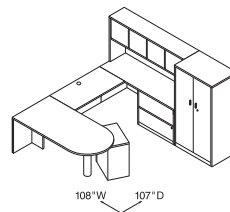

Desk "U" Workstation – Right
108"W x 107"D

Qty.	Model #	Description	List Price	Price Extension
1	H10521	Peninsula with End Panel 72"W x 36"D x 29½"H	\$ 811	\$ 811
1	H10570	Bridge 47"W x 24"D x 29½"H	\$ 335	\$ 335
1	H10547R	Credenza with Lateral, Right 72"W x 24"D x 29½"H	\$1,296	\$1,296
1	H10534	Stack-on Storage 72"W x 14⅝"D x 37⅞"H	\$ 935	\$ 935
1	H10530	Wardrobe/Storage Cabinet w/Doors 36"W x 24"D x 66⅝"H	\$2,109	\$2,109
1	H105102	Mobile Pedestal – b/b/f 15¾"W x 22¾"D x 28"H	\$ 789	\$ 789
TOTAL:			\$6,275	

10500 Series™ Laminate Modular Components

GSA SIN 711-8

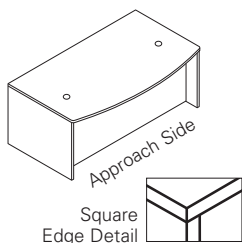

- ▶ Non-handed desk, credenza, and return shells, combined with a variety of under-the-worksurface storage solutions, maximize office layout flexibility. Products can be reconfigured quickly and easily when user preferences or space needs change.
- ▶ For under-surface storage options, see pages 225-226.
- ▶ For additional components see pages 230-246.
- ▶ Tops and end panels are abrasion- and stain-resistant laminate over durable 1 1/8" solid core high-performance particleboard; resists warping.
- ▶ Cord management grommets, for routing and hiding wires and cables, are located in the tops of desks and return shells.
- ▶ 3" round worksurface grommet can be replaced with optional Power Hub (model HGRMTAC) to bring the ease of plug-and-play to the desktop. See page 245.
- ▶ Adjustable hex leveling glides allow floor-standing furniture to be easily leveled without lifting the unit; glides have 3/4" adjustable range.
- ▶ For standing, 42"H shells, see page 217.

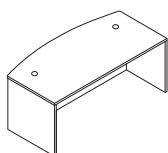
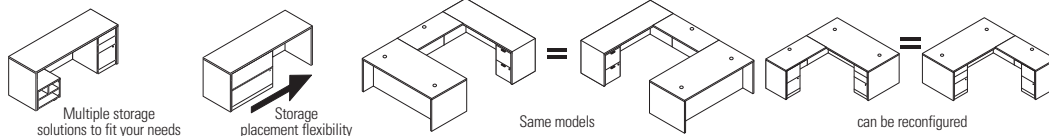

Model H10596 shown

Description	Inside Dimensions	Full Width Overhang	Model	Ship Weight	Cube	List Price by Laminate Grade	
						L1	L2
Desk Shell (with full modesty panel and 2 grommets)							
72"W x 36"D x 29 1/2"H, Bow Top (end panels 30"D)	69 1/2"W x 24 5/8"D	10 1/2"	H10596 E◆A	192	6.9	\$ 827	\$ 877
72"W x 36"D x 29 1/2"H, Rectangle Top	69 1/2"W x 24 5/8"D	10 1/2"	H10594 E◆A	209	6.9	\$ 746	\$ 796
72"W x 30"D x 29 1/2"H, Rectangle Top	69 1/2"W x 24 5/8"D	4 1/2"	H10592 E◆A	182	5.8	\$ 707	\$ 747
66"W x 30"D x 29 1/2"H, Rectangle Top	63 1/2"W x 24 5/8"D	4 1/2"	H10579 E◆A	172	5.4	\$ 670	\$ 710
60"W x 30"D x 29 1/2"H, Rectangle Top	57 1/2"W x 24 5/8"D	4 1/2"	H10578 E◆A	161	5.0	\$ 622	\$ 662
48"W x 30"D x 29 1/2"H, Rectangle Top (1 grommet)	45 1/2"W x 24 5/8"D	4 1/2"	H10598 E◆A	141	5.0	\$ 578	\$ 608

NOTES: See page 246 for optional center drawers.

Desk Shell (with 10"H modesty panel and 2 grommets)							
72"W x 36"D x 29 1/2"H, Bow Top (end panels 30"D)	69 1/2"W x 24 5/8"D	10 1/2"	H10596X E◆A	155	6.1	\$ 827	\$ 877
72"W x 36"D x 29 1/2"H, Rectangle Top	69 1/2"W x 24 5/8"D	10 1/2"	H10594X E◆A	153	6.1	\$ 746	\$ 796
72"W x 30"D x 29 1/2"H, Rectangle Top	69 1/2"W x 24 5/8"D	4 1/2"	H10592X E◆A	143	5.1	\$ 707	\$ 747
66"W x 30"D x 29 1/2"H, Rectangle Top	63 1/2"W x 24 5/8"D	4 1/2"	H10579X E◆A	134	4.7	\$ 670	\$ 710
60"W x 30"D x 29 1/2"H, Rectangle Top	57 1/2"W x 24 5/8"D	4 1/2"	H10578X E◆A	125	4.4	\$ 622	\$ 662
48"W x 30"D x 29 1/2"H, Rectangle Top (1 grommet)	45 1/2"W x 24 5/8"D	4 1/2"	H10598X E◆A	115	4.4	\$ 578	\$ 608

NOTES: Makes reaching wall electrical outlets quick and easy. Provides more than 18" of clearance. See page 232 for optional stack-on storage and page 246 for optional center drawers.

How to specify	<p>Select Model Number from above</p> <p>H 1 0 5 9 6 .</p>	<p>1st Option</p> <p>Select Laminate Top and Chassis Color</p> <p>See pages 48-49</p> <p>N N </p>
----------------	---	---



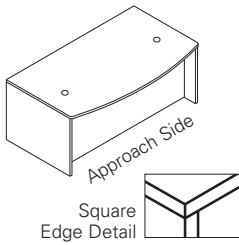

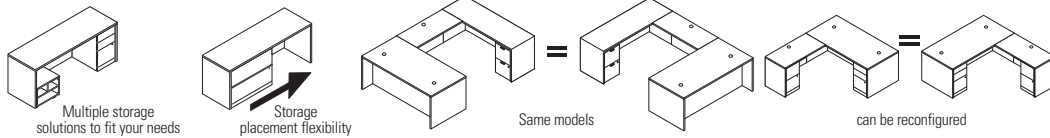

- ▶ Non-handed desk, credenza, and return shells, combined with a variety of under-the-worksurface storage solutions, maximize office layout flexibility. Products can be reconfigured quickly and easily when user preferences or space needs change.
- ▶ For 78", 84", 90", and 96"W credenza shells, see page 216.
- ▶ For under-surface storage options, see pages 225-226.
- ▶ Tops and end panels are abrasion- and stain-resistant laminate over durable 1/8" solid core high-performance particleboard; resists warping.
- ▶ For additional components see pages 230-246.
- ▶ For work-in-process paper management tools, see page 241.
- ▶ Cord management grommets, for routing and hiding wires and cables, are located in the tops of desks and return shells.
- ▶ Credenza shells have a cord pass-through grommet in the top center of the modesty panel.
- ▶ Kneespace Clearance End Panel Kit model H105098, can be used to create "L" configurations with leg clearance, by connecting credenzas to single pedestal desks or credenzas, desk or credenza shells, corners, extended corners or peninsulas.
- ▶ Adjustable hex leveling glides allow floor-standing furniture to be easily leveled without lifting the unit; glides have 3/4" adjustable range.

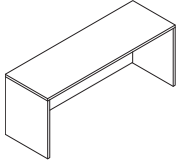

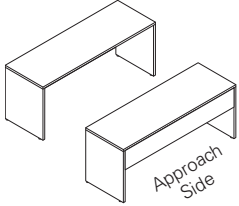
Description	Inside Dimensions	Model	Ship Weight	Cube	List Price by Laminate Grade	
					L1	L2
 <p>Credenza Shell (with full modesty panel)</p> <p>72"W x 24"D x 29 1/2"H 66"W x 24"D x 29 1/2"H 60"W x 24"D x 29 1/2"H 48"W x 24"D x 29 1/2"H 42 1/4"W x 24"D x 29 1/2"H</p> <p>72"W x 20"D x 29 1/2"H 66"W x 20"D x 29 1/2"H 60"W x 20"D x 29 1/2"H</p> <p>NOTES: Cord pass-through in top center of modesty panel. See page 232 for optional stack-on storage.</p>	69 1/2"W x 22 3/4"D	H10541 E◆A	153	5.6	\$ 643	\$ 683
	63 1/2"W x 22 3/4"D	H10542 E◆A	144	5.1	\$ 629	\$ 669
	57 1/2"W x 22 3/4"D	H10564 E◆A	135	4.7	\$ 588	\$ 623
	45 1/2"W x 22 3/4"D	H105692 E◆A	124	3.9	\$ 564	\$ 594
	39 3/4"W x 22 3/4"D	H105691 E◆A	110	3.8	\$ 544	\$ 574
	69 1/2"W x 18 3/4"D	H105581 E◆A	138	5.6	\$ 607	\$ 642
	63 1/2"W x 18 3/4"D	H105582 E◆A	130	5.1	\$ 592	\$ 627
	57 1/2"W x 18 3/4"D	H105583 E◆A	122	4.7	\$ 561	\$ 591

 <p>Credenza Shell (with 10" H modesty panel)</p> <p>72"W x 24"D x 29 1/2"H 66"W x 24"D x 29 1/2"H 60"W x 24"D x 29 1/2"H 48"W x 24"D x 29 1/2"H 42 1/4"W x 24"D x 29 1/2"H</p> <p>72"W x 20"D x 29 1/2"H 66"W x 20"D x 29 1/2"H 60"W x 20"D x 29 1/2"H</p> <p>NOTES: Makes reaching wall electrical outlets quick and easy. Provides more than 18" of clearance. See page 232 for optional stack-on storage.</p>	69 1/2"W x 22 3/4"D	H10541X E◆A	114	4.8	\$ 643	\$ 683
	63 1/2"W x 22 3/4"D	H10542X E◆A	107	4.4	\$ 629	\$ 669
	57 1/2"W x 22 3/4"D	H10564X E◆A	105	4.0	\$ 588	\$ 623
	45 1/2"W x 22 3/4"D	H105692X E◆A	95	3.8	\$ 564	\$ 594
	39 3/4"W x 22 3/4"D	H105691X E◆A	87	3.8	\$ 544	\$ 574
	69 1/2"W x 18 3/4"D	H105581X E◆A	107	4.8	\$ 607	\$ 642
	63 1/2"W x 18 3/4"D	H105582X E◆A	101	4.4	\$ 592	\$ 627
	57 1/2"W x 18 3/4"D	H105583X E◆A	96	4.0	\$ 561	\$ 591

Description	Model	Ship Weight	Cube	L1 List	L2 Upcharge
 <p>Kneespace Clearance End Panel Kits (field installable)</p> <p>1 1/8"W x 11 1/4"D x 28 1/8"H For use at either end of 10500, 10700 or Valido Series™ 24"D Credenza Shells (with full or 10" modesty panel) or non-pedestal end of single pedestal credenzas or credenzas with lateral files.</p> <p>1 1/8"W x 17 1/4"D x 28 1/8"H For use at either end of 10500, 10700 or Valido Series™ 30"D Desk Shells or non-pedestal end of 30"D single pedestal desks.</p> <p>Kits include: (1) support panel; European fastening hardware; flat connector bracket; joint connector bolts with sleeve nuts (for ganging credenza to adjacent worksurface); and adjustable leveling glides. Allows conversion of units currently in the field.</p> <p>NOTES: Can be used to connect up to three 24"D credenzas or 30"D desks in line (requires 4 kits). ⚠ Not designed to be used freestanding. Not designed to be used with returns, 36"D desks or desk shells. SPECIFYING EXAMPLE: H105098.N</p>	H105098 E◆A	13	0.9	\$ 193	\$ 10
	H105099 E◆A	11	0.8	\$ 202	\$ 10

How to specify	<p>Select Model Number from above</p> <p>H 1 0 5 4 1 .</p>	<p>1st Option</p> <p>Select Laminate Top and Chassis Color</p> <p>See pages 48-49</p> <p>N N </p>
----------------	--	---

10500 Series™ Laminate Modular Components

GSA SIN 711-8



- ▶ Non-handed desk, credenza, and return shells, combined with a variety of under-the-worksurface storage solutions, maximize office layout flexibility. Products can be reconfigured quickly and easily when user preferences or space needs change.
- ▶ For under-surface storage options, see pages 225-226.
- ▶ For additional components see pages 230-246.
- ▶ Tops and end panels are abrasion- and stain-resistant laminate over durable 1 1/8" solid core high-performance particleboard; resists warping.
- ▶ Credenza shells have a cord pass-through grommet in the top center of the modesty panel.
- ▶ Kneespace Clearance End Panel Kit model H105098, can be used to create "L" configurations with leg clearance, by connecting credenzas to single pedestal desks or credenzas, desk or credenza shells, corners, extended corners or peninsulas.
- ▶ Adjustable hex leveling glides allow floor-standing furniture to be easily leveled without lifting the unit; glides have 3/4" adjustable range.

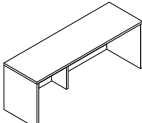

Description	Inside Dimensions	Model	Ship Weight	Cube	List Price by Laminate Grade	
					L1	L2
 <p>Credenza Shell (with full modesty panel) 96"W x 24"D x 29 1/2"H 90"W x 24"D x 29 1/2"H 84"W x 24"D x 29 1/2"H 78"W x 24"D x 29 1/2"H</p>	93 1/2"	H105413 E◆A	215	7.0	\$ 917	\$ 972
	87 1/2"	H105412 E◆A	202	6.6	\$ 892	\$ 942
	81 1/2"	H105411 E◆A	189	6.2	\$ 790	\$ 840
	75 1/2"	H105410 E◆A	176	5.8	\$ 769	\$ 814

NOTES: Larger sizes can be used in conjunction with a 10500 Series rectangle- or bullet-shaped worksurface, supported by an end panel, column or leg, to achieve a space efficient work wall configuration. Shells wider than 72" include an internal, 10 1/2"D vertical support leg. The internal leg can be removed if it is replaced with a 10500 Series 28"H modular pedestal that is adjusted to support the credenza shell top. Cord pass-through in top center of modesty panel. See page 232 for optional stack-on storage and the stack-on storage end panel kit (model H105349).

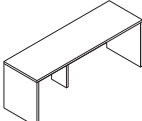
 <p>Credenza Shell (with 10"H modesty panel) 96"W x 24"D x 29 1/2"H 90"W x 24"D x 29 1/2"H 84"W x 24"D x 29 1/2"H 78"W x 24"D x 29 1/2"H</p>	93 1/2"	H105413X E◆A	163	6.1	\$ 917	\$ 972
	87 1/2"	H105412X E◆A	152	5.7	\$ 892	\$ 942
	81 1/2"	H105411X E◆A	141	5.4	\$ 790	\$ 840
	75 1/2"	H105410X E◆A	130	5.0	\$ 769	\$ 814

NOTES: Makes reaching wall electrical outlets quick and easy. Provides more than 18" of clearance. Larger sizes can be used in conjunction with a 10500 Series rectangle- or bullet-shaped worksurface, supported by an end panel, column or leg, to achieve a space efficient work wall configuration. Shells wider than 72" include an internal, 10 1/2"D vertical support leg. The internal leg can be removed if it is replaced with a 10500 Series 28"H modular pedestal that is adjusted to support the credenza shell top. See page 232 for optional stack-on storage and the stack-on storage end panel kit (model H105349).

How to specify	<p>Select Model Number from above</p> <p>H 1 0 5 4 1 3 .</p>	<p>1st Option</p> <p>Select Laminate Top and Chassis Color</p> <p>See pages 48-49</p> <p>N N</p>
----------------	--	--

ABJ E◆A Icon Legend on page 10

- ▶ 42" H shells help support a healthy work style by allowing users to switch between sitting and standing.
- ▶ Non-handed desk and return shells maximize office layout flexibility. Products can be reconfigured quickly and easily when user preferences or space needs change.
- ▶ Tops and end panels are abrasion- and stain-resistant laminate over durable 1½" solid core high-performance particleboard; resists warping.
- ▶ For additional components see pages 230-246.
- ▶ Mobile pedestals, shown on page 237, work well in a variety of applications and configurations.
- ▶ Adjustable hex leveling glides allow floor-standing furniture to be easily leveled without lifting the unit; glides have ¼" adjustable range.

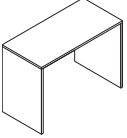

Description	Inside Dimensions	Model	Ship Weight	Cube	List Price by Laminate Grade	
					L1	L2
 <p>Standing-Height Desk Shell 60"W x 30"D x 42"H 60"W x 24"D x 42"H 48"W x 24"D x 42"H</p>	57½"W x 24½"D x 41⅝"H	H105397 E◆A	185	6.2	\$ 774	\$ 814
	57½"W x 22¾"D x 41⅝"H	H105393 E◆A	154	5.1	\$ 713	\$ 753
	45⅝"W x 22¾"D x 41⅝"H	H105392 E◆A	143	4.2	\$ 667	\$ 702
<p>NOTES: Fixed height surface is 42"H. When combined with a stool-height task chair, provides users the benefit of alternating their work between a seated or standing position without the additional cost of an adjustable-height mechanism. Short, 22⅝" modesty panel provides over 18" of wall access; makes reaching wall electrical outlets quick and easy. Box/File Pedestal (H10501) attaches to the underside of the worksurface top to position supplies and files within easy reach.</p>						

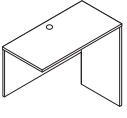
 <p>Standing-Height Return Shell 48"W x 24"D x 42"H</p>	47"W x 22¾"D x 41⅝"H	H105663 E◆A	96	3.1	\$ 560	\$ 595
	<p>NOTES: Non-handed design. Attaches to sit/stand desk shells to form an L-shaped workstation. Short, 22⅝" modesty panel makes reaching wall electrical outlets quick and easy. One cord management grommet in top for routing and hiding wires and cables. Grommet can be replaced with optional Power Hub (model HGRMTAC). Box/File Pedestal (H10501) attaches to the underside of the worksurface top to position supplies and files within easy reach.</p>					

How to specify	Select Model Number from above	1st Option
	H 1 0 5 3 9 7 .	Select Laminate Top and Chassis Color See pages 48-49 N N

10500 Series™ Laminate Modular Components

GSA SIN 711-8



- ▶ Non-handed desk, credenza, and return shells, combined with a variety of under-the-worksurface storage solutions, maximize office layout flexibility. Products can be reconfigured quickly and easily when user preferences or space needs change.
- ▶ For additional components see pages 230-246.
- ▶ Tops and end panels are abrasion- and stain-resistant laminate over durable 1 1/8" solid core high-performance particleboard; resists warping.
- ▶ Cord management grommets, for routing and hiding wires and cables, are located in the tops of desks and return shells.
- ▶ Adjustable hex leveling glides allow floor-standing furniture to be easily leveled without lifting the unit; glides have 3/4" adjustable range.
- ▶ 36"W and 30"W return shells enable L-shaped layouts for smaller spaces.
- ▶ One cord management grommet in tops of Return Shell models, H10568 and H10568X, is used for routing and hiding wires and cables. This 3" round grommet can be replaced with optional Power Hub (model HGRMTAC — page 747).

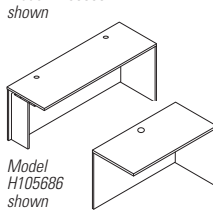

Description	Inside Dimensions	Model	Ship Weight	Cube	List Price by Laminate Grade	
					L1	L2
<p><i>Model H105686 shown</i></p>  <p>Return Shell (with full modesty panel)</p> <p>72"W x 24"D x 29 1/2"H, (w/support; 2 grommets)</p> <p>60"W x 24"D x 29 1/2"H, (w/support; 2 grommets)</p> <p>48"W x 24"D x 29 1/2"H, (1 grommet)</p> <p>42"W x 24"D x 29 1/2"H, (1 grommet)</p> <p>36"W x 24"D x 29 1/2"H, (1 grommet)</p> <p>30"W x 24"D x 29 1/2"H, (1 grommet)</p> <p>Model H105686 shown</p>	<p>67"W x 22 3/4"D</p> <p>55"W x 22 3/4"D</p> <p>47"W x 22 3/4"D</p> <p>41"W x 22 3/4"D</p> <p>34 7/8"W x 22 3/4"D</p> <p>28 7/8"W x 22 3/4"D</p>	<p>H105686 E◆A</p> <p>H105684 E◆A</p> <p>H10561 E◆A</p> <p>H105681 E◆A</p> <p>H105680 E◆A</p> <p>H10568 E◆A</p>	<p>145</p> <p>129</p> <p>86</p> <p>89</p> <p>83</p> <p>69</p>	<p>5.4</p> <p>4.4</p> <p>3.7</p> <p>2.5</p> <p>3.2</p> <p>2.6</p>	<p>\$ 643</p> <p>\$ 588</p> <p>\$ 484</p> <p>\$ 454</p> <p>\$ 454</p> <p>\$ 434</p>	<p>\$ 683</p> <p>\$ 623</p> <p>\$ 514</p> <p>\$ 484</p> <p>\$ 479</p> <p>\$ 459</p>
<p>NOTES: Shells are non-handed. No pre-drilled grommet in modesty panel (field installable grommet included). Wood-grain direction on modesty/back panel runs vertical on 30"W-60"W sizes and horizontal on 72"W unit. 36"W return shell can be used to achieve a 6' x 6' L-shaped footprint when connected to either a 72"W x 36"D single pedestal desk, desk shell, or peninsula, or when two are connected to 36"W corner unit model H105811. 30"W return shell can be used to accomplish a 5' x 5' L-shaped footprint when connected to a 60"W x 30"D desk shell or peninsula. See page 232 for optional stack-on storage.</p> <p>▲ Not designed to attach to corner units manufactured prior to 5/24/99.</p>						

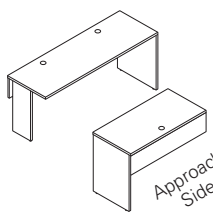
<p><i>Model H105686X shown</i></p>  <p>Return Shell (with 10"H modesty panel)</p> <p>72"W x 24"D x 29 1/2"H, (w/support; 2 grommets)</p> <p>60"W x 24"D x 29 1/2"H, (w/support; 2 grommets)</p> <p>48"W x 24"D x 29 1/2"H, (1 grommet)</p> <p>42"W x 24"D x 29 1/2"H, (1 grommet)</p> <p>36"W x 24"D x 29 1/2"H, (1 grommet)</p> <p>30"W x 24"D x 29 1/2"H, (1 grommet)</p> <p>Approach Side</p>	<p>67"W x 22 3/4"D</p> <p>55"W x 22 3/4"D</p> <p>47"W x 22 3/4"D</p> <p>41"W x 22 3/4"D</p> <p>34 7/8"W x 22 3/4"D</p> <p>28 7/8"W x 22 3/4"D</p>	<p>H105686X E◆A</p> <p>H105684X E◆A</p> <p>H10561X E◆A</p> <p>H105681X E◆A</p> <p>H105680X E◆A</p> <p>H10568X E◆A</p>	<p>106</p> <p>93</p> <p>78</p> <p>69</p> <p>67</p> <p>56</p>	<p>4.6</p> <p>3.9</p> <p>3.1</p> <p>3.8</p> <p>3.8</p> <p>2.6</p>	<p>\$ 643</p> <p>\$ 588</p> <p>\$ 484</p> <p>\$ 454</p> <p>\$ 454</p> <p>\$ 434</p>	<p>\$ 683</p> <p>\$ 623</p> <p>\$ 514</p> <p>\$ 484</p> <p>\$ 479</p> <p>\$ 459</p>
<p>NOTES: Makes reaching wall electrical outlets quick and easy. Provides more than 18" of clearance. See page 232 for optional stack-on storage.</p>						

How to specify	<p>Select Model Number from above</p> <p>H 1 0 5 6 8 6 .</p>	<p>1st Option</p> <p>Select Laminate Top and Chassis Color</p> <p>See pages 48-49</p> <p>N N </p>
----------------	---	---

- ▶ Easy-care, scratch-, spill- and stain-resistant laminate over 1/8" solid core high-performance particleboard.
- ▶ Grain direction on all worksurfaces runs horizontal.

- ▶ Versatile component tops combine with under-surface support options to form freestanding desks or credenzas, U- or L-shaped configurations, or work wall layouts with an island extension.
- ▶ One flat bracket ships with each worksurface for applications requiring connection to an adjoining worksurface.

- ▶ For end panels, legs, columns and bases, see the Worksurface Supports listing on pages 220-221.
- ▶ When using a floating modesty panel or an external channel under the worksurface, the depth clearance for keyboard trays and center drawers decreases by 8". See accessory matrix in accessory section of the pricer.

⚠ **Worksurfaces are subject to slight bowing. The magnitude of the deflection is dependent upon the weight, placement, and duration of the load.**

⚠ **When using a worksurface as a bridge, no additional supports are needed. One support is required for returns, two supports are required for desks and credenzas.**

⚠ **External channel support is recommended for extended unsupported spans or heavily loaded worksurfaces. See below for details.**



	Description	Model	Ship Weight	Cube	List Price by Laminate Grade	
					L1	L2
 SIN 711-8	Rectangle Worksurface					
	72"W x 30"D	H105R3072	83	6.1	\$ 371	\$ 391
	66"W x 30"D	H105R3066	76	6.1	\$ 344	\$ 364
	60"W x 30"D	H105R3060	69	5.2	\$ 322	\$ 342
	48"W x 30"D	H105R3048	55	4.1	\$ 263	\$ 278
 SIN 711-8	72"W x 24"D	H105R2472	66	4.9	\$ 315	\$ 335
	66"W x 24"D	H105R2466	61	4.9	\$ 305	\$ 325
	60"W x 24"D	H105R2460	55	4.2	\$ 286	\$ 306
	48"W x 24"D	H105R2448	44	3.4	\$ 243	\$ 258
	42"W x 24"D	H105R2442	39	3.0	\$ 220	\$ 235
NOTES: Underside of rectangle worksurfaces includes pilot mounting holes for end panels, support columns, post and O-legs, and height adjustable base. Applications for 24"D worksurfaces include desks, credenzas, returns, and bridges. For above privacy screen sizes, see page 192.						
 SIN 711-8	Bullet Worksurface					
	72"W x 30"D	H105B3072	79	6.1	\$ 384	\$ 404
	66"W x 30"D	H105B3066	73	6.1	\$ 364	\$ 384
	60"W x 30"D	H105B3060	66	5.2	\$ 346	\$ 366
NOTES: Underside includes pilot mounting holes for T-shaped end panels and support columns. ⚠ When specifying 60"W Floating Modesty Panel, it is not necessary to specify an external channel.						

	Description	Model	Ship		
			Weight	Cube	List
 SIN 711-2	External Support Channel				
	60"W	HLSLZ5SC72	7	0.5	\$ 97
	54"W	HLSLZ5SC66	7	0.5	\$ 90
	48"W	HLSLZ5SC60	6	0.5	\$ 87
	42"W	HLSLZ5SC54	5	0.5	\$ 82
NOTES: Steel channel can be attached to the underside of worksurfaces that are subjected to heavier loads. Channel is recommended for unsupported spans of 54"W or greater or per user preference. When using an external support channel under the worksurface, the depth clearance for center drawers and keyboard platforms decreases by 8". See chart below for support channel compatibility information. ⚠ Specify: Model.P (black only) ⚠ When specifying a 54"W or 60"W Floating Modesty Panel, it is not necessary to specify an external channel.					

EXTERNAL SUPPORT CHANNEL (recommended use)				
Support Combination		Rectangle Worksurface Width		
Support 1	Support 2	72 in	66 in	60 in
O-Leg	O-Leg	HLSLZ5SC72	HLSLZ5SC66	HLSLZ5SC60
O-Leg	L-Shaped End Panel	HLSLZ5SC60	HLSLZ5SC54	HLSLZ5SC48
O-Leg	4 1/2" Diameter Support Column	NA	NA	NA
O-Leg	2" Square Post Leg	NA	NA	NA
L-Shaped End Panel	L-Shaped End Panel	NA	NA	NA
L-Shaped End Panel	4 1/2" Diameter Support Column	NA	NA	NA
L-Shaped End Panel	2" Square Post Leg	NA	NA	NA
T-Shaped End Panel	O-Leg	HLSLZ5SC60	HLSLZ5SC54	HLSLZ5SC48
T-Shaped End Panel	L-Shaped End Panel	NA	NA	NA
T-Shaped End Panel	4 1/2" Diameter Support Column	NA	NA	NA
T-Shaped End Panel	2" Square Post Leg	NA	NA	NA

How to specify	Select Model Number from above H 1 0 5 R 3 0 7 2 .	1st Option Select Worksurface Laminate and Edge Color See pages 48-49 N N
----------------	---	---

▶ Adjustable hex leveling glides allow floor-standing furniture to be easily leveled without lifting the unit; glides have 3/4" adjustable range.

⚠ Support column must be specified for worksurfaces used as peninsulas or as an island extension.

⚠ Laminate L- and T-shaped end panels can be specified as one color only; not available in two-tone laminate combination or in a pattern laminate.

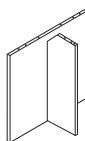

Not available in two-tone laminate

Description	Model	Ship Weight	Cube	List Price by Laminate Grade	
				L1	L2
T-shaped End Panel					
11 5/8"W x 29 1/8"D x 28 1/2"H	H10530TEP E♦A	45	3.7	\$ 244	\$ 256
11 5/8"W x 23 1/8"D x 28 1/2"H	H10524TEP E♦A	38	3.2	\$ 229	\$ 241

NOTES: Non-handed. For use with 30"D and 24"D 10500 Series worksurfaces. Two 1 1/8" thick pieces; one end and one brace panel. Cord routing notch in brace panel. Simple assembly.

⚠ Not designed to be used freestanding.

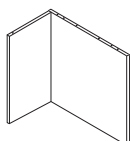

Not available in two-tone laminate

L-shaped End Panel					
15 3/4"W x 29 1/8"D x 28 1/2"H	H10530LEP E♦A	49	4.1	\$ 265	\$ 277
15 3/4"W x 23 1/8"D x 28 1/2"H	H10524LEP E♦A	43	3.7	\$ 247	\$ 259

NOTES: Non-handed. 29 1/8"D for use with 30"D worksurfaces; 23 1/8"D for use with 24"D worksurfaces. Design facilitates easy, open access to wall electrical outlets. Two pieces; 1 1/8" end panel and 3/4" back panel. 10500 Series modular and mobile pedestals fit flush to the end panel. Simple assembly.

⚠ Not designed to be used freestanding.

30"D Rectangle Worksurface Support Options

Product Application	Support Combination		Support Model Numbers for 72"W, 66"W, or 60"W Worksurfaces	Support Model Numbers for 48"W or 42"W Worksurfaces
	Support 1	Support 2		
Desk or Credenza	O-Leg	O-Leg	HLSL30280 (2)	HLSL30280 (2)
	O-Leg	L-Shaped End Panel	HLSL30280 / HH10530LEP	HLSL30280 / H10530LEP
	L-Shaped End Panel	L-Shaped End Panel	H10530LEP (2)	H10530LEP (2)
	T-Shaped End Panel	O-Leg	H10530TEP / HLSL30280	H10530TEP / HLSL30280
	T-Shaped End Panel	L-Shaped End Panel	H10530TEP / H10530LEP	H10530TEP / H10530LEP
Peninsula for U- or L-Configuration; Not Freestanding	O-Leg	4 1/2" Diameter Support Column	HLSL30280 / HPC190X-191X	NA
	O-Leg	2" Square Post Leg	HLSL30280 / HLSL28P	NA
	L-Shaped End Panel	4 1/2" Diameter Support Column	H10530LEP / HPC190X-191X	NA
	L-Shaped End Panel	2" Square Post Leg	H10530LEP / HLSL28P	NA
	T-Shaped End Panel	4 1/2" Diameter Support Column	H10530TEP / HPC190X-191X	NA
	T-Shaped End Panel	2" Square Post Leg	H10530TEP / HLSL28P	NA
Desk, Credenza, or Freestanding Return or Bridge	Adjustable Height Base – Electric		HHAB3S24F	HHAB3S24F (48"W min.)
Return (requires one support)	O-Leg	—	HLSL30280	HLSL30280
	L-Shaped End Panel	—	H10530LEP	H10530LEP
Island Extension (requires one support)	O-Leg	—	HLSL30280	HLSL30280
	4 1/2" Diameter Support Column	—	HPC190X or HPC191X	HPC190X or HPC191X
	2" Square Post Leg	—	HLSL28P	HLSL28P

How to specify	1st Option
<p>Select Model Number from above</p> <p>H 1 0 5 3 0 T E P . N</p>	<p>Select Laminate</p> <p>See pages 48-49</p>

ABJ Icon Legend on page 10

▶ A variety of pedestals, end panels, and O-legs can be combined to create a conventional or contemporary desk.

⚠ **Support column must be specified for worksurfaces used as peninsulas or as an island extension.**

⚠ **Post leg can only be used to support peninsula, not as primary supports for a top.**

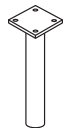

SIN 711-8

Description	Model	Ship Weight	Cube	List
Support Column for 10500 Series Rectangle and Bullet Worksurfaces 4½" Diameter For Black , specify HPC190X.P. For Silver , specify HPC191X.X.	HPC190X	12	1.0	\$ 144
	HPC191X	12	1.0	\$ 144

NOTES: Can only be used as the outbound support in a peninsula or island extension worksurface application. Glides have ¾" adjustable range.

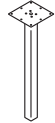

SIN 711-2

Description	Model	Ship Weight	Cube	List Price by Paint Grade	
				Core	Metallics
Post Leg Base 28½"H x 2" square	HLSL28P	15	1.0	\$ 256	\$ 260

NOTES: Can only be used as the outbound support in a peninsula or island extension worksurface application. Glides have 2" of adjustability. Ship 1/pack.
SPECIFYING EXAMPLE: HLSL28P.T1

24"D Rectangle Worksurface Support Options				
Product Application	Support Combination		Support Model Numbers for 72"W, 66"W, or 60"W Worksurfaces	Support Model Numbers for 48"W or 42"W Worksurfaces
	Support 1	Support 2		
Desk or Credenza	O-Leg	O-Leg	HLSL24280 (2)	HLSL24280 (2)
	O-Leg	L-Shaped End Panel	HLSL24280 / H10524LEP	HLSL24280 / H10524LEP
	L-Shaped End Panel	L-Shaped End Panel	H10524LEP (2)	H10524LEP (2)
	T-Shaped End Panel	O-Leg	H10524TEP / HLSL24280	H10524TEP / HLSL24280
	T-Shaped End Panel	L-Shaped End Panel	H10524TEP / H10524LEP	H10524TEP / H10524LEP
Peninsula for U- or L-Configuration; Not Freestanding	O-Leg	4½" Diameter Support Column	HLSL24280 / HPC190X-191X	NA
	O-Leg	2" Square Post Leg	HLSL24280 / HLSL28P	NA
	L-Shaped End Panel	4½" Diameter Support Column	H10524LEP / HPC190X-191X	NA
	L-Shaped End Panel	2" Square Post Leg	H10524LEP / HLSL28P	NA
	T-Shaped End Panel	4½" Diameter Support Column	H10524TEP / HPC190X-191X	NA
	T-Shaped End Panel	2" Square Post Leg	H10524TEP / HLSL28P	NA
Desk, Credenza, or Freestanding Return or Bridge	Adjustable Height Base – Electric		HHAB3S24F	HHAB3S24F (48"W min.)
Return (requires one support)	O-Leg	—	HLSL24280	HLSL24280
	L-Shaped End Panel	—	H10524LEP	H10524LEP
	T-Shaped End Panel	—	H10524TEP	H10524TEP
	4½" Diameter Support Column	—	HPC190X or HPC191X	HPC190X or HPC191X
	2" Square Post Leg	—	HLSL28P	HLSL28P
Island Extension (requires one support)	O-Leg	—	HLSL24280	HLSL24280
	4½" Diameter Support Column	—	HPC190X or HPC191X	HPC190X or HPC191X
	2" Square Post Leg	—	HLSL28P	HLSL28P

72"W, 66"W, or 60"W x 30"D Bullet Worksurface Support Options			
Product Application	Support Combination		Support Model Numbers
	Support 1	Support 2	
Peninsula for U- or L-Configuration; Not Freestanding	O-Leg	4½" Diameter Support Column	HLSL30280 / HPC190X or HPC191X
	O-Leg	2" Square Post Leg	HLSL30280 / HLSL28P
	L-Shaped End Panel	4½" Diameter Support Column	H10524LEP / HPC190X or HPC191X
	L-Shaped End Panel	2" Square Post Leg	H10524LEP / HLSL28P
	T-Shaped End Panel	4½" Diameter Support Column	H10524TEP / HPC190X or HPC191X
	T-Shaped End Panel	2" Square Post Leg	H10524TEP / HLSL28P
Island Extension	4½" Diameter Support Column	—	HPC190X or HPC191X
	2" Square Post Leg	—	HLSL28P

How to specify	<p>Select Model Number from above</p> <p>H P C 1 9 0 X .</p>	<p>1st Option</p> <p>Select Paint Color</p> <p>See page 175</p> <p>T 1</p>
----------------	---	---

10500 Series™ Worksurface Supports

GSA SIN as Noted



- ▶ O-leg glides have 2" adjustability.
 - ▶ For shared components such as modesty panels and privacy screens see pages 191-192.
 - ▶ O-leg ships fully assembled with mounting hardware.
 - ▶ O-leg installation requires 6" of clearance from the worksurface end.
 - ▶ For standing-height O-leg sizes, see page 222.
 - ▶ Shared O-legs create a cleaner aesthetic in all applications where two legs are used side-by-side.
 - ▶ Will have 6" overhang when using 30"D O-legs with a 36"D worksurface.
- ⚠ **O-legs may only be attached to worksurfaces, not storage units.**



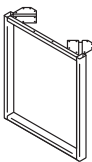

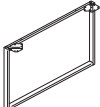
Description	Model	Ship Weight	Cube	List Price by Paint Grade	
				Core	Metallics
 O-Leg 30"D x 28½"H 24"D x 28½"H NOTES: Ship fully assembled, 1/pack. Non-handed. IMPORTANT: The O-leg attachment bracket interferes with placement of 10500 Series modular pedestals and 28⅝"H mobile pedestals, preventing them from being positioned directly next to (flush with) the O-leg. Box/file mobile pedestal (model H105106) and mobile printer/fax cart model (H105679) can be positioned along side the O-leg. SPECIFYING EXAMPLE: HLSL24280.T1	HLSL30280	19	5.4	\$ 310	\$ 314
	HLSL24280	17	3.7	\$ 279	\$ 283

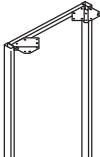
 Double-Depth O-Leg Support for Worksurfaces 48"D x 28½"H 60"D x 28½"H NOTES: Ship fully assembled, 1/package. Non-handed. 48"D and 60"D sizes span back-to-back 24"D and 30"D worksurfaces, respectively.	HLSL48280	18	7.0	\$ 528	\$ 536
	HLSL60280	19	8.7	\$ 588	\$ 596

 Standing-Height O-Leg Support for Worksurfaces 24"D x 41"H 30"D x 41"H NOTES: Ship fully assembled, 1/package. Non-handed. Coordinate™ Power Modules will work with standing-height applications for 10500™ and Voi® desks. Please see Coordinate™ Accessories Stand-Alone Pricer pages for more information.	HLSL24410	16	5.3	\$ 375	\$ 381
	HLSL30410	17	6.5	\$ 419	\$ 425

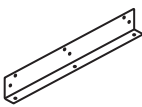
 Standing-Height O-Leg Shared Support for Worksurfaces 24"D x 41"H 30"D x 41"H NOTES: Ship fully assembled, 1/package. Non-handed. For use with two 24"D or 30"D worksurfaces positioned side-by-side along the depth dimension. Coordinate™ Power Modules will work with standing-height applications for 10500™ and Voi® desks. Please see Coordinate™ Accessories Stand-Alone Pricer pages for more information.	HLSL2441SL	16	5.3	\$ 422	\$ 428
	HLSL3041SL	17	6.5	\$ 468	\$ 474

Description	Model	Ship Weight	Cube	List	
				Core	Metallics
 Worksurface Wall Mount Bracket For 30" For 24" NOTES: Can be used in place of an end panel or O-leg to support a worksurface. Cannot be used as a support when placing a stack-on storage unit on worksurface over bracket; must have two full-sized floor supports when using stack-on storage. Finish option not required. SPECIFYING EXAMPLE: HVPWLBK30	HVPWLBK30	2	0.3	\$ 77	
	HVPWLBK24	2	0.3	\$ 77	

Description	Model	Ship Weight	Cube	List by Paint Grade		
				Core	Choice/Metallics	Custom
 Worksurface to Tower Bracket Kit 18½" long bracket for attaching 24"D worksurface directly to storage tower, wardrobe/bookcase, wardrobe/storage cabinet, storage cabinet/lateral file, storage cabinet, or lateral file. NOTES: Can be used in place of end panel or O-leg to support worksurfaces. ⚠ Bracket not designed for use as a support if placing Stack-on Storage on worksurface over/above bracket. Two full-sized supports required when using Stack-on Storage.	HSTB2W1	4	0.6	\$ 68	\$ 81	\$ 92





Description	Model	Ship Weight	Cube	List by Paint Grade		
				Core	Choice/Metallics	Custom
 Worksurface to Tower Bracket Kit 18½" long bracket for attaching 24"D worksurface directly to storage tower, wardrobe/bookcase, wardrobe/storage cabinet, storage cabinet/lateral file, storage cabinet, or lateral file. NOTES: Can be used in place of end panel or O-leg to support worksurfaces. ⚠ Bracket not designed for use as a support if placing Stack-on Storage on worksurface over/above bracket. Two full-sized supports required when using Stack-on Storage.	HSTB2W1	4	0.6	\$ 68	\$ 81	\$ 92

How to specify	Select Model Number from above H L S L 3 0 2 8 0 .	1st Option Select Paint Color See page 175 T 1
----------------	--	--

- ▶ Height Adjustable Base is a 3-stage column design.
- ▶ Frame rises from 23³/₈" to 49¹/₄" for a sit-to-stand desk option.
- ▶ Height Adjustable Bases shipped complete with a preassembled motor.
- ▶ Base telescopes to accommodate any worksurface between 48"W and 72"W.
- ▶ Height Adjustable Base accommodates rectangular worksurfaces between 24"D x 48"W and 36"D x 72"W. Systems, Voi®, 10500, and Preside® all have worksurfaces within this range.
- ▶ Standard height-adjustable control ships with base.
- ▶ Dynamic load capacity when worksurface is moving is 300 lbs.
- ▶ Optional Memory Control allows preset worksurface heights for consistency. Ships separately.
- ▶ Silver finish matches any neutral HON paint or finish color.

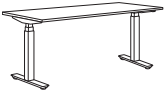
⚠ **HON's Optional Memory Control (HHABMEM) does not work with the *basyx* by HON® Height Adjustable Base.**

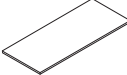
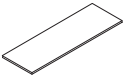

	Description	Model	Ship Weight	Cube	List
 <p>Base shown with worksurface attached. SIN 711-2</p>	<p>Height Adjustable Base – 3 Stage 24"D Feet and Worksurface Brackets</p> <p>NOTES: Support option for 30"D and 24"D 10500 Series™ rectangle worksurfaces. Worksurfaces are ordered separately, see model listing on page 219. <i>Worksurfaces are ordered separately, see model listing below.</i></p> <p>⚠ Available in silver finish only, no specification needed. Suggested coordinated paint, Platinum Metallic.</p>	HHAB3S24F E♠A	80.0	2.8	\$1250
 <p>Open Market</p>	<p>Height Adjustable Base – Optional Memory Control</p> <p>⚠ Available in black finish only, no specification needed. Memory controller includes digital display and four memory presets.</p>	HHABMEM	0.5	0.4	\$ 75
 <p>Open Market</p>	<p>Under Worksurface Power Module – 4 Outlets, 10' Cord</p> <ul style="list-style-type: none"> • Includes 10' cord with three-prong plug. • Fits in cable management troughs. See page 392. • 4 outlets on side create easy access. <p>NOTES: Power Modules will also work with standing-height applications for 10500 Series™ and Voi® desks.</p> <p>⚠ Available in black finish only, no specification needed.</p>	HPWRMOD2 E♠A	1.5	0.2	\$ 340
 <p>Open Market</p>	<p>Caster Add-On Kit</p> <p>⚠ Available in black finish only, no specification needed.</p>	HHABCASTER E♠A	1.0	0.1	\$ 65

	Description	Model	Ship Weight	Cube	List Price by Laminate Grade	
					L1	L2
 <p>SIN 711-8</p>	Rectangle Worksurface					
	72"W x 30"D	H105R3072	83	6.1	\$ 371	\$ 391
	66"W x 30"D	H105R3066	76	6.1	\$ 344	\$ 364
	60"W x 30"D	H105R3060	69	5.2	\$ 322	\$ 342
 <p>SIN 711-8</p>	48"W x 30"D	H105R3048	55	4.1	\$ 263	\$ 278
	72"W x 24"D	H105R2472	66	4.9	\$ 315	\$ 335
	66"W x 24"D	H105R2466	61	4.9	\$ 305	\$ 325
	60"W x 24"D	H105R2460	55	4.2	\$ 286	\$ 306
	48"W x 24"D	H105R2448	44	3.4	\$ 243	\$ 258
	42"W x 24"D	H105R2442	39	3.0	\$ 220	\$ 235

NOTES: Underside of rectangle worksurfaces includes pilot mounting holes for end panels, support columns, post and O-legs, and height adjustable base. Applications for 24"D worksurfaces include desks, credenzas, returns, and bridges. For above privacy screen sizes, see page 192.

How to specify	<p>Select Model Number from above</p> <p>H 1 0 5 R 3 0 7 2 .</p>	<p>1st Option</p> <p>Select Laminate</p> <p>See page 309</p> <p>N N</p>
----------------	---	--

Icon Legend on page 10

10500 Series™ Shared Components

GSA SIN 711-2



► Laminate or mixed material floating modesty panels options are available for attachment under 10500 Series worksurfaces. The modesty panel and attachment bracket are packaged separately.

► If using a 54"W or 60"W floating modesty panel, it is not necessary to specify an external support channel under the worksurface.

► When using a floating modesty panel under the worksurface, the depth clearance for center drawers and keyboard platforms decreases by 8".



Description	Model	Ship		List Price by Laminate Grade	
		Weight	Cube	L1	L2
Laminate Floating Modesty Panel					
30"W x 14"H	HLSL3014L	10	0.8	\$ 148	\$ 158
36"W x 14"H	HLSL3614L	12	0.8	\$ 156	\$ 166
42"W x 14"H	HLSL4214L	14	0.8	\$ 169	\$ 179
48"W x 14"H	HLSL4814L	16	1.1	\$ 186	\$ 198
54"W x 14"H	HLSL5414L	18	1.1	\$ 204	\$ 216
60"W x 14"H	HLSL6014L	20	1.1	\$ 220	\$ 232

NOTES: The attachment bracket and modesty panel are packaged separately.

Specify: Model.Laminate.Paint

SPECIFYING EXAMPLE: HLSL3014L.N.P (Black is the only paint option for this model)

▲ **When specifying the 54"W or 60"W Laminate Floating Modesty Panel, it is not necessary to specify an external channel.**

▲ **30"W and 36"W screens attach with L-brackets, not the external channel.**

Description	Model	Ship		List
		Weight	Cube	
Mixed Material Floating Modesty Panel				
30"W x 14"H	HLSL3014MM	8	2.0	\$ 597
36"W x 14"H	HLSL3614MM	8	2.0	\$ 641
42"W x 14"H	HLSL4214MM	9	2.3	\$ 716
48"W x 14"H	HLSL4814MM	11	2.6	\$ 794
54"W x 14"H	HLSL5414MM	13	3.3	\$ 862
60"W x 14"H	HLSL6014MM	13	3.3	\$ 984

NOTES: The attachment bracket and modesty panel are packaged separately.

Specify: Model.Mixed Material.Paint

SPECIFYING EXAMPLE: HLSL3014MM.FT01.P (Frosted Translucent mixed material and Black paint are the only options for this model)

▲ **When specifying the 54"W or 60"W Mixed Material Floating Modesty Panel, it is not necessary to specify an external channel.**

Above Privacy Screen					
30"W x 13"H	HLSL1230	13	1.5	\$ 241	
36"W x 13"H	HLSL1236	15	1.8	\$ 266	
42"W x 13"H	HLSL1242	18	2.3	\$ 298	
48"W x 13"H	HLSL1248	20	2.3	\$ 340	
54"W x 13"H	HLSL1254	22	2.9	\$ 364	
60"W x 13"H	HLSL1260	24	2.9	\$ 392	

NOTES: Ships complete with attachment bracket. Bracket is Platinum only, no need to specify. Attaches to top of rectangle worksurfaces; requires a minimum overhang of 1½".

▲ **Available in Frosted Glass ONLY HLSL1230.G.**

FLOATING MODESTY PANELS – MODEL SELECTION GUIDE

Support Combination		Rectangle Worksurface Width				
Support 1	Support 2	72 in	66 in	60 in	48 in	42 in
O-Leg	O-Leg	HLSL6014	HLSL5414	HLSL4814	HLSL3614	HLSL3014
O-Leg	L-Shaped End Panel	HLSL4814	HLSL4214	HLSL3614	NA	NA
O-Leg	4½" Diameter Support Column	HLSL4814	HLSL4814	HLSL4814	HLSL3614	HLSL3014
O-Leg	2" Square Post Leg	HLSL4814	HLSL4814	HLSL4814	HLSL3614	HLSL3014
L-Shaped End Panel	L-Shaped End Panel	HLSL3614	HLSL3014	NA	NA	NA
L-Shaped End Panel	4½" Diameter Support Column	HLSL3614	HLSL3614	HLSL3614	NA	NA
L-Shaped End Panel	2" Square Post Leg	HLSL3614	HLSL3614	HLSL3614	NA	NA
T-Shaped End Panel	O-Leg	HLSL5414	HLSL4814	HLSL4214	HLSL3014	NA
T-Shaped End Panel	L-Shaped End Panel	HLSL3614	HLSL3014	NA	NA	NA
T-Shaped End Panel	4½" Diameter Support Column	HLSL3614	HLSL3014	NA	NA	NA
T-Shaped End Panel	2" Square Post Leg	HLSL3614	HLSL3014	NA	NA	NA

Support Combination		Bullet Worksurface Width		
Support 1	Support 2	72 in	66 in	60 in
O-Leg	4½" Diameter Support Column	HLSL4814	HLSL4814	HLSL4814
O-Leg	2" Square Post Leg	HLSL4814	HLSL4814	HLSL4814
L-Shaped End Panel	4½" Diameter Support Column	HLSL3614	HLSL3614	HLSL3614
L-Shaped End Panel	2" Square Post Leg	HLSL3614	HLSL3614	HLSL3614
T-Shaped End Panel	4½" Diameter Support Column	HLSL3614	HLSL3614	HLSL3614
T-Shaped End Panel	2" Square Post Leg	HLSL3614	HLSL3614	HLSL3614

How to specify	1st Option
Select Model Number from above H L S L 3 0 1 4 M M .	Select Mixed Material FT01 Frosted Translucent F T 0 1

ABJ Icon Legend on page 10

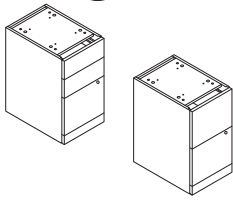

- ▶ Pedestals can be reconfigured quickly and easily when user preferences or space needs change.
- ▶ Locking units equipped with interchangeable core removable locks.
- ▶ Pedestal models ship assembled unless designated. **E-4**
- ▶ Mobile pedestals shown on page 237, work well in a variety of configurations.

- ▶ Narrow Pedestal features a compact design that is ideal for use in U and L-shaped layouts for smaller spaces such as a 5' x 8' U-shaped workstation or a 5' x 5' L-shaped workstation.
- ▶ **Keyed alike cores must be ordered separately — see model HF23B on page 743 — makes re-keying quick and easy.**

- ▶ **Access strip (filler) required when box/box file, file/file, and/or pencil/media/file pedestals are configured side-by-side to allow access for opening the drawers.**
- ▶ **Access strip is required when CPU storage pedestal is used next to B/F, B/B/F, or F/F or P/M/F pedestals (finger pull is on side of door front). See below.**

- ▶ **Modular pedestals can be specified as one color only; not available in two-tone laminate combination or in a pattern laminate.**



Description	Model	Ship Weight	Cube	List Price by Laminate Grade	
				L1	L2
 <p>Box/File Pedestal (with core removable lock) 15⁵/₈"W x 22³/₄"D x 17³/₄"H — for use under 24"D, 30"D and 36"D desk, credenza and return shells</p> <p>NOTES: Attaches to underside of worksurface top. Lock can be positioned on either the right or left side. File drawer includes integrated hangrails for letter- or legal-sized folders. Not for use under 20"D shells.</p> <p>⚠ Not designed to be used freestanding. Unfinished top and back.</p>	H10501	57	5.5	\$ 483	\$ 503
 <p>Narrow Box/Box/File Pedestal (with core removable lock) — floorstanding 9¹/₂"W x 22³/₄"D x 28"H — for use under 24"D, 30"D and 36"D desk, credenza and return shells</p> <p>NOTES: Space-saving design supports smaller footprints. Middle box drawer and file drawer lock; top box drawer does not lock. File drawer includes integrated hangrails for side-to-side letter or legal filing. Not for use under 20"D shells.</p> <p>⚠ Not designed to be used freestanding. Unfinished top and back.</p>	H105093	61	5.6	\$ 624	\$ 649
 <p>Box/Box/File Pedestal — floorstanding 15⁵/₈"W x 28³/₄"D x 28"H — for use under 10500 Series 30"D worksurfaces supported by 29⁷/₈"D L-shaped end panel model H10530LEP.</p> <p>NOTES: Top box drawer does not lock. File drawer includes integrated hangrails for letter- or legal-sized folders. Not for use under shells, per "Inside Dimensions" listings.</p> <p>⚠ Not designed to be used freestanding. Unfinished top and back.</p>	H105062	105	10.5	\$ 683	\$ 713
 <p>Box/Box/File Pedestal (with core removable lock) — floorstanding 15⁵/₈"W x 22³/₄"D x 28"H — for use under 24"D, 30"D and 36"D desk, credenza and return shells or worksurface supported by 23³/₈"D L-shaped end panel(s)</p> <p>NOTES: Top box drawer does not lock. File drawer includes integrated hangrails for letter- or legal-sized folders. Not for use under 20"D shells.</p> <p>⚠ Not designed to be used freestanding. Unfinished top and back.</p>	H10502	90	8.4	\$ 634	\$ 659
 <p>Box/Box/File Pedestal (with core removable lock) — floorstanding 15⁵/₈"W x 18³/₄"D x 28"H — for use under 20"D, 24"D, 30"D and 36"D desk, credenza and return shells</p> <p>NOTES: Top box drawer does not lock. File drawer includes integrated hangrails for letter- or legal-sized hanging folders.</p> <p>⚠ Not designed to be used freestanding. Unfinished top and back.</p>	H105012	73	7.3	\$ 598	\$ 618
 <p>File/File Pedestal — floorstanding 15⁵/₈"W x 28³/₄"D x 28"H — for use under 10500 Series 30"D worksurfaces supported by 29⁷/₈"D L-shaped end panel model H10530LEP.</p> <p>NOTES: File drawer includes integrated hangrails for letter- or legal-sized folders. Not for use under shells, per "Inside Dimensions" listings.</p> <p>⚠ Not designed to be used freestanding. Unfinished top and back.</p>	H105064	104	10.5	\$ 683	\$ 713
 <p>File/File Pedestal (with core removable lock) — floorstanding 15⁵/₈"W x 22³/₄"D x 28"H — for use under 24"D, 30"D and 36"D desk, credenza and return shells or worksurface supported by 23³/₈"D L-shaped end panel(s)</p> <p>NOTES: File drawers include integrated hangrails for letter- or legal-sized folders. Not for use under 20"D shells.</p> <p>⚠ Not designed to be used freestanding. Unfinished top and back.</p>	H10504	85	8.2	\$ 634	\$ 659
 <p>File/File Pedestal (with core removable lock) — floorstanding 15⁵/₈"W x 18³/₄"D x 28"H — for use under 20"D, 24"D, 30"D and 36"D desk, credenza and return shells</p> <p>NOTES: File drawers include integrated hangrails for letter- or legal-sized folders.</p> <p>⚠ Not designed to be used freestanding. Unfinished top and back.</p>	H105014	72	7.3	\$ 598	\$ 618
 <p>Access Strip (Filler) 1¹/₈"W x 20¹/₂"D x 28"H</p> <p>NOTES: For use under 24"D, 30"D and 36"D desk, credenza or return shells when B/B/F, F/F, and/or P/M/F pedestals are configured side-by-side or when CPU storage is used next to B/F, B/B/F, or F/F pedestals. Not required when pedestals are used in conjunction with lateral file pedestals, multi file pedestals or cabinet pedestal. Not sized for use with 20"D modular shells.</p>	H10524	21	0.9	\$ 161	\$ 171

NOTE: See pages 214-218 for desk, credenza and return shells.

How to specify	<p>Select Model Number from above</p> <p>H 1 0 5 0 9 3 .</p>	<p>1st Option</p> <p>Select Laminate Chassis Color</p> <p>See pages 48-49</p> <p>N </p>
----------------	--	---



- ▶ Pedestals can be reconfigured quickly and easily when user preferences or space needs change.
- ▶ File drawers accept hanging folders in letter or legal size.
- ▶ Mobile pedestals shown on page 237, work well in a variety of configurations.
- ▶ Locking units equipped with interchangeable core removable locks.
- ▶ Pedestal models ship assembled unless designated. E♦A
- ▶ **Keyed alike cores must be ordered separately — see model HF23B on page 743 — makes re-keying quick and easy.**
- ▶ **Access strip (filler) required when box/box file, file/file, and or pencil/media/file pedestals are configured side-by-side to allow access for opening the drawers.**
- ▶ **Access strip is required when CPU storage pedestal is used next to B/F, B/B/F, F/F or P/M/F pedestals (finger pull is on side of door front). See page 225.**

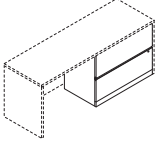
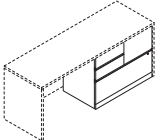
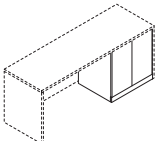
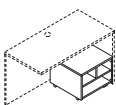

Description	Model	Ship Weight	Cube	List Price by Laminate Grade	
				L1	L2
 <p>Lateral File Pedestal (with core removable lock) — floorstanding 36"W x 20"D x 28"H — for use under 24"D, 30"D and 36"D desk, credenza and return shells</p> <p>NOTES: Drawers include integrated hangrails for letter- or legal-sized folders. Mechanical interlock inhibits extension of more than one drawer at a time. Not for use under 20"D shells.</p> <p>⚠ Not designed to be used freestanding. Unfinished top and back.</p>	H10503	127	15.6	\$ 964	\$1004
 <p>Multi File Pedestal (with core removable lock) — floorstanding 36"W x 20"D x 28"H — for use under 24"D, 30"D and 36"D desk, credenza and return shells</p> <p>NOTES: Versatile four drawer unit features a lateral file, vertical file, and two box drawers. Box drawers do not lock. File drawers include integrated hangrails for letter- or legal-sized folders. Mechanical interlock in lateral drawer inhibits extension of more than one drawer at a time. Not for use under 20"D shells.</p> <p>⚠ Not designed to be used freestanding. Unfinished top and back.</p>	H10505	155	15.6	\$1155	\$1195
 <p>Cabinet Pedestal — floorstanding 26"W x 21 1/4"D x 28"H — for use under 24"D, 30"D and 36"D desk, credenza and return shells</p> <p>NOTES: One adjustable shelf at 2 1/2" increments. Doors are non-locking. Not for use under 20"D shells.</p> <p>⚠ Not designed to be used freestanding. Unfinished top and back.</p>	H10508	78	12.2	\$ 718	\$ 758
 <p>Mobile Printer/Fax Cart 20"W x 19 7/8"D x 14 1/8"H — for use under 24"D, 30"D and 36"D desk, credenza and return shells</p> <p>NOTES: Holds laser printers, inkjet printers or fax machines. Ideal for limited space. Low profile cart stores conveniently and easily under desks and workstations. Interior compartment shelving is Black. Four casters. Specify laminate top and chassis color. Not for use under 20"D shells.</p> <p>SPECIFYING EXAMPLE: H105679.NN</p>	H105679 E♦A	52	2.9	\$ 397	\$ 417

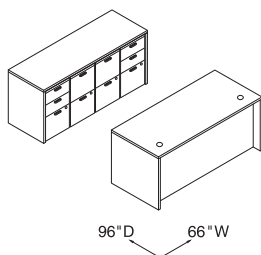

- 1 – H10579
- 1 – H10542
- 2 – H105102
- 2 – H105104

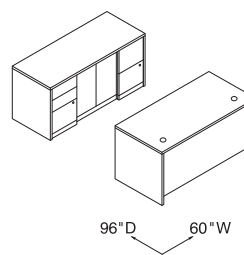

- 1 – H10578
- 1 – H10564
- 1 – H10502
- 1 – H10504
- 1 – H10508

NOTE: See pages 214-218 for desk, credenza and return shells.

How to specify	<p>Select Model Number from above</p> <p>H 1 0 5 0 3 .</p>	<p>1st Option</p> <p>Select Laminate Chassis Color</p> <p>See pages 48-49</p> <p>N</p>
----------------	--	---

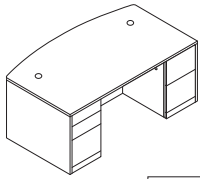

Square Edge Detail

- ▶ Factory-configured desks, credenzas and returns ship fully assembled for ease and speed of installation.
- ▶ Full-to-floor pedestals maximize storage space.
- ▶ Smooth, flat edges provide a clean look.
- ▶ Tops are easy-care, scratch-, spill- and stain-resistant laminate over 1 1/8" solid core high-performance particleboard.
- ▶ 3" round cord management grommets, for routing and hiding wires and cables, are located in the tops of desks, returns, bridges, and corner units. Accepts optional Power Hub Grommet model HGRMTAC — page 747.
- ▶ For work-in-process paper management tools, see page 241.
- ▶ Drawers operate on full extension, ball-bearing suspensions to ensure smooth, quiet, long-lasting operation.
- ▶ File drawer design includes integrated hangrails for side-to-side letter or legal filing; and front-to-back for letter filing.
- ▶ For field installable decorative handle options, see page 244.
- ▶ All drawers are five-sided construction for added strength and easy alignment or replacement of drawer fronts.
- ▶ Center drawers conveniently store writing instruments, paper and other miscellaneous items. Includes pencil tray. See page 246.

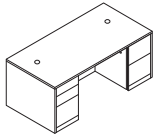
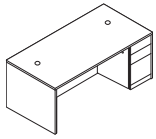

Description	Full Width Overhang	Model	Ship Weight	Cube	List Price by Laminate Grade		
					L1	L2	
 <p>Double Pedestal Desk 72"W x 36"D x 29 1/2"H, Bow Top, 3/2 72"W x 36"D x 29 1/2"H, Rectangle Top, 3/2 66"W x 30"D x 29 1/2"H, Rectangle Top, 3/2 60"W x 30"D x 29 1/2"H, Rectangle Top, 3/2</p>	10 1/2"	H105899	315	50.9	\$1728	\$1808	
	10 1/2"	H105890	340	50.9	\$1575	\$1650	
	4 1/2"	H105891	290	39.4	\$1467	\$1532	
	4 1/2"	H105892	278	35.9	\$1379	\$1439	
NOTES: All drawers lock. Two cord grommets in top for routing and hiding wires and cables. Bow top models measure 36"D at crest and 30"D along the end panels. See page 246 for optional center drawers.							
 <p>Single Pedestal Desk 72"W x 36"D x 29 1/2"H, Bow Top, Right 72"W x 36"D x 29 1/2"H, Rectangle Top, Right 66"W x 30"D x 29 1/2"H, Rectangle Top, Right</p> <p>72"W x 36"D x 29 1/2"H, Bow Top, Left 72"W x 36"D x 29 1/2"H, Rectangle Top, Left 66"W x 30"D x 29 1/2"H, Rectangle Top, Left</p>	10 1/2"	H105893R	292	50.9	\$1416	\$1486	
	10 1/2"	H105895R	278	50.9	\$1260	\$1330	
	4 1/2"	H105897R	226	39.4	\$1137	\$1192	
	10 1/2"	H105894L	292	50.9	\$1416	\$1486	
	10 1/2"	H105896L	278	50.9	\$1260	\$1330	
	4 1/2"	H105898L	226	39.4	\$1137	\$1192	
	NOTES: Box/box/file drawers. Drawers lock. Two cord grommets in top for routing and hiding wires and cables. Bow top models measure 36"D at crest and 30"D along the end panels. See page 246 for optional center drawers.						

How to specify

<p>Select Model Number from above</p> <p>H 1 0 5 8 9 9 .</p>	<p>1st Option</p> <p>Select Laminate Top and Chassis Color</p> <p>See pages 48-49</p> <p>N N </p>
--	---

10500 Series™ Laminate Wood Desks — Full Pedestals

GSA SIN 711-8

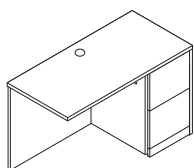

Square Edge Detail



- ▶ Factory-configured desks, credenzas and returns ship fully assembled for ease and speed of installation.
- ▶ Formal, full length modesty panels.
- ▶ Tops are easy-care, scratch-, spill- and stain-resistant laminate over 1 1/8" solid core high-performance particleboard.
- ▶ 3" round cord management grommets, for routing and hiding wires and cables, are located in the tops of desks, returns, bridges, and corner units. Accepts optional Power Hub Grommet model HGRMTAC.
- ▶ Drawers operate on full extension, ball-bearing suspensions to ensure smooth, quiet, long-lasting operation.
- ▶ All drawers are five-sided construction for added strength and easy alignment for replacement of drawer fronts.
- ▶ File drawer design includes integrated hangrails for side-to-side letter or legal filing; and front-to-back for letter filing.
- ▶ For field installable decorative handle options, see page 244.
- ▶ 10500 Series™ 18 3/4"D modular and mobile pedestals can be positioned under credenza with kneespace and single pedestal credenza models.

⚠ **Keyed alike cores must be ordered separately — see model HF23B on page 743 — makes re-keying quick and easy.**

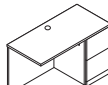
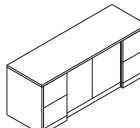
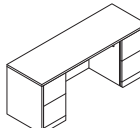
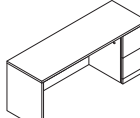

Description	Full Width Overhang	Model	Ship Weight	Cube	List Price by Laminate Grade	
					L1	L2
 <p>Return, file/file 48"W x 24"D x 29 1/2"H, Right 42"W x 24"D x 29 1/2"H, Right</p> <p>48"W x 24"D x 29 1/2"H, Left 42"W x 24"D x 29 1/2"H, Left</p> <p>NOTES: Return is for use with single pedestal desks, desk shells, peninsulas or corner units. One worksurface grommet and one cord pass-through grommet in top center of modesty panel to reach wall electrical outlets. Drawers lock. Not to be used freestanding. Will not attach to Corner Units manufactured prior to 5/24/99. See page 232 for optional Stack-on Storage.</p>		H105905R	167	24.2	\$ 890	\$ 930
		H105907R	147	21.4	\$ 870	\$ 910
		H105906L	167	24.2	\$ 890	\$ 930
		H105908L	147	21.4	\$ 870	\$ 910
 <p>Credenza with Doors 72"W x 24"D x 29 1/2"H</p> <p>NOTES: All drawers lock. Doors are non-locking. Includes a fixed shelf located at the bottom of the center storage area. No intermittent shelf. See page 232 for optional Stack-on Storage.</p>	3 1/2"	H105909	323	34.8	\$1631	\$1696
 <p>Credenza with Kneespace, file/file 72"W x 24"D x 29 1/2"H 66"W x 24"D x 29 1/2"H 60"W x 24"D x 29 1/2"H</p> <p>NOTES: All drawers lock. One cord pass-through grommet in top center of modesty panel to reach wall electrical outlets. Not designed for use with 24"D modular or mobile pedestals. See page 232 for optional Stack-on Storage.</p>	3 1/2"	H105900	274	34.8	\$1381	\$1441
	3 1/2"	H105901	262	32.0	\$1368	\$1428
	3 1/2"	H105902	248	29.2	\$1317	\$1372
 <p>Single Pedestal Credenza, file/file 72"W x 24"D x 29 1/2"H, Right (shown) 72"W x 24"D x 29 1/2"H, Left</p> <p>NOTES: Drawers lock. One cord pass-through grommet in top center of modesty panel to reach wall electrical outlets. Not designed for use with 24"D modular or mobile pedestals. See page 232 for optional Stack-on Storage.</p>	3 1/2"	H105903R	226	34.8	\$1120	\$1175
	3 1/2"	H105904L	226	34.8	\$1120	\$1175

How to specify	<p>Select Model Number from above</p> <p>H 1 0 5 9 0 5 R .</p>	<p>1st Option</p> <p>Select Laminate Top and Chassis Color</p> <p>See pages 48-49</p> <p>N N</p>
----------------	--	---

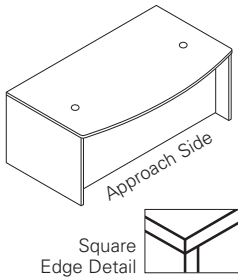

- ▶ For components that can be shared with 10500 Series™, see pages 230-246.
- ▶ Tops and end panels are abrasion- and stain-resistant laminate over durable 1 1/4" solid core high-performance particleboard; resists warping.
- ▶ Formal, full height modesty panels.
- ▶ 3/4 pedestal design increases budget flexibility.
- ▶ 3" round cord management grommets, for routing and hiding wires and cables, are located in the tops of desks, returns, bridges, and corner units. Accepts optional Power Hub Grommet model HGRMTAC — page 747.
- ▶ All drawers are 5-sided construction, which allows easy drawer alignment or replacement of drawer fronts.
- ▶ Drawers operate on full extension, ball-bearing suspensions to ensure smooth, quiet, long-lasting operation.
- ▶ File drawer design includes integrated hangrails for side-to-side letter or legal filing; and front-to-back for letter filing.
- ▶ For field installable decorative handle options, see page 244.
- ▶ Desk, credenza, and return models ship assembled.
- ▶ See stack-on storage and stack-on PC organizer options on pages 231-232.
- ▶ Use with Above Worksurface Privacy Screens. See page 224.
- ▶ Mobile table quickly provides additional worksurface space, see page 243.



Description	Full Width Overhang	Model	Ship Weight	Cube	List Price by Laminate Grade	
					L1	L2
Double Pedestal Desk 72"W x 36"D x 29 1/2"H, Bow Top, 2-2 72"W x 36"D x 29 1/2"H, Rectangle Top, 2-2 66"W x 30"D x 29 1/2"H, Rectangle Top, 2-2 60"W x 30"D x 29 1/2"H, Rectangle Top, 2-2 NOTES: All drawers lock. Two cord grommets in top for routing and hiding wires and cables. Bow top models measure 36"D at crest and 30"D along the end panels. See page 246 for optional center drawers.	10 1/2"	H10595	300	52.9	\$1444	\$1524
Single Pedestal Desk 72"W x 36"D x 29 1/2"H, Bow Top, Right 72"W x 36"D x 29 1/2"H, Rectangle Top, Right 66"W x 30"D x 29 1/2"H, Rectangle Top, Right 72"W x 36"D x 29 1/2"H, Bow Top, Left 72"W x 36"D x 29 1/2"H, Rectangle Top, Left 66"W x 30"D x 29 1/2"H, Rectangle Top, Left NOTES: Box/file drawers. Drawers lock. Two cord grommets in top for routing and hiding wires and cables. Bow top models measure 36"D at crest and 30"D along the end panels. See page 246 for optional center drawers.	10 1/2"	H10587R	238	52.9	\$1246	\$1316
Small Office Desk 48"W x 30"D x 29 1/2"H, 3/4 Pedestal, Right box/file NOTES: Small footprint makes this desk ideal for limited space. Drawers lock. One cord grommet in top for routing and hiding wires and cables. 3/4 height modesty panel facilitates reaching wall electrical outlets. Optional stack-on storage model H105323 maximizes storage space; see page 232.	4 1/2"	H105885R	168	30.5	\$ 853	\$ 893
Return, box/file 48"W x 24"D x 29 1/2"H, Right 42"W x 24"D x 29 1/2"H, Right 48"W x 24"D x 29 1/2"H, Left 42"W x 24"D x 29 1/2"H, Left NOTES: Return is for use with single pedestal desks, desk shells, peninsulas or corner units. One worksurface grommet and one cord pass-through grommet in top center of modesty panel to reach wall electrical outlets. Drawers lock. See page 232 for optional stack-on storage.		H10515R	147	25.6	\$ 774	\$ 814
Credenza with Doors 72"W x 24"D x 29 1/2"H NOTES: All drawers lock. Doors are non-locking. Includes a fixed shelf located at the bottom of the center storage area. No intermittent shelf. See page 232 for optional stack-on storage.	3 1/2"	H10544	278	36.0	\$1399	\$1464
Credenza with Kneespace — box/file 72"W x 24"D x 29 1/2"H 66"W x 24"D x 29 1/2"H 60"W x 24"D x 29 1/2"H NOTES: All drawers lock. One cord pass-through grommet in top center of modesty panel to reach wall electrical outlets.	3 1/2"	H10543	243	36.3	\$1147	\$1207
Single Pedestal Credenza — box/file 72"W x 24"D x 29 1/2"H, Right (shown) 72"W x 24"D x 29 1/2"H, Left NOTES: Drawers lock. One cord pass-through grommet in top center of modesty panel to reach wall electrical outlets. See page 232 for optional stack-on storage.	3 1/2"	H10546L	212	36.0	\$ 945	\$1000

NOTE: See pages 230 through 246 for shared components.

How to specify	Select Model Number from above H 1 0 5 9 5 .	1st Option Select Laminate Top and Chassis Color See pages 48-49 N N
----------------	--	---



10500 Series™ Shared Components & Accessories

GSA SIN 711-8



► Shared components shown on this page can be used with modular components shown on pages 214-226, full pedestal models shown on pages 227-228 and 3/4 pedestal models shown on page 229.

► Jetty, boomerang and rudder peninsulas are designed and sized to efficiently serve as both a computing and conferencing space.

► Peninsulas ship complete with end panel and black 4 1/2" diameter support column. For a silver support column option, please see model HPC191X on page 133 (ordered separately).

► Mobile pedestals shown on page 237 work well in a variety of configurations.

► Adjustable hex leveling glides allow floor-standing furniture to be easily leveled without lifting the unit; glides have 3/4" adjustable range.

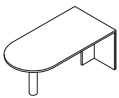

Description	Model	Ship Weight	Cube	List Price by Laminate Grade	
				L1	L2
 <p>Peninsula w/End Panel 72"W x 36"D x 29 1/2"H 72"W x 30"D x 29 1/2"H 66"W x 30"D x 29 1/2"H 60"W x 30"D x 29 1/2"H</p>	H10521 E◆A	150	15.1	\$ 811	\$ 856
	H105209 E◆A	130	12.8	\$ 742	\$ 787
	H10522 E◆A	125	11.8	\$ 747	\$ 792
	H10523 E◆A	100	10.7	\$ 699	\$ 744

NOTES: Use for "U" or "L" configuration. 60"W size ideal for smaller spaces. Cord routing notch in brace panel. Accepts field installable modesty panel model H10528. Accepts center drawer model H1526 and H1522. Model H1522 can be used in conjunction with the laminate modesty panel model H10528. Round support column is black.

▲ **Not designed to be used freestanding.**

 <p>72"W x 30/36"D x 29 1/2"H, P-shaped Right (shown) 72"W x 36/30"D x 29 1/2"H, P-shaped Left</p>	H10525R E◆A	142	13.4	\$ 948	\$ 993
	H10526L E◆A	142	13.4	\$ 948	\$ 993

NOTES: Use for "U" or "L" configuration. Cord routing notch in brace panel. Accept field installable modesty panel model H10528 (see below). See page 246 for optional center drawers. Round support column is black.

▲ **Not designed to be used freestanding.**

 <p>Jetty Peninsula w/End Panel 72"W x 30/42"D x 29 1/2"H, Right (shown) 72"W x 42/30"D x 29 1/2"H, Left</p>	H105201R E◆A	156	16.9	\$1053	\$1108
	H105202L E◆A	156	16.9	\$1053	\$1108

NOTES: For use in "U" or "L" configuration. Designed and sized to efficiently serve as both a computing and conferencing space. One cord management grommet in the top; cord routing notch in brace panel. Round support column is black.

▲ **Not designed to be used freestanding. Jetty units manufactured on or after 10/24/2005 accept field installable modesty panel H10528 (see below).**

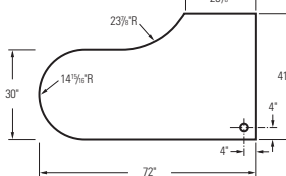

 <p>Boomerang Peninsula w/End Panel 72"W x 30/42"D x 29 1/2"H, Right (shown) 72"W x 42/30"D x 29 1/2"H, Left</p>	H105203R E◆A	152	16.9	\$1053	\$1108
	H105204L E◆A	152	16.9	\$1053	\$1108

NOTES: For use in "U" or "L" configuration. Designed and sized to efficiently serve as both a computing and conferencing space. One cord management grommet in the top; cord routing notch in brace panel. Round support column is black.

▲ **Not designed to be used freestanding. Accept field installable modesty panel H10528 (see below).**

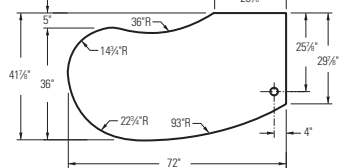

 <p>Rudder Peninsula with End Panel 72"W x 30/38"D x 29 1/2"H, Right (shown) 72"W x 30/38"D x 29 1/2"H, Left</p>	H105205R E◆A	142	15.8	\$1029	\$1074
	H105206L E◆A	142	15.8	\$1029	\$1074

NOTES: Use for "U" or "L" configuration. One cord management grommet in top; cord routing notch in brace panel. 30"D along end panel. Round support column is black.

▲ **Not designed to be used freestanding.**

 <p>Field installable Laminate Modesty Panel for Peninsulas 50 1/4"W x 3/4"Thick x 18"H</p>	H10528 E◆A	25	1.3	\$ 170	\$ 180
--	------------	----	-----	--------	--------

NOTES: Center drawer model H1522 can be used in conjunction with the laminate modesty panel. Laminate modesty panel has a cord pass-through notch in top corner.

▲ **Not compatible with Peninsula models H10525R, H10526L, H10621, H10721, H10722 manufactured prior to 12/1/2001 or jetty models H105201R and H105202L manufactured prior to 10/24/2005.**

SPECIFYING EXAMPLE: H10528.N

Description	Model	Ship Weight	Cube	List
Field Installable Modesty Panel, Frosted with Silver Frame 50 1/4"W x 3/4"Thick x 18"H — for use on 72"W peninsulas	HPC180G	33	1.5	\$ 629

▲ **Center drawers not designed to be used with the frosted/silver modesty panel. Cord pass-through notch is not available on the Frosted/Silver model HPC180G. Notch is on laminate model H10528 only.**

NOTE: See pages 230 through 246 for shared components.

How to specify	1st Option
Select Model Number from above H 1 0 5 2 5 R .	Select Laminate Top and Chassis Color See pages 48-49 N N

Icon Legend on page 10

▶ Shared components shown on this page can be used with modular components shown on pages 214-226 and 3/4 pedestal models shown on page 229.

▶ Mobile pedestals shown on page 237 work well in a variety of configurations.
▶ Work Organizer models accept 3-ring binders and organizer model HTCOL52. See page 240.

▶ Locking units equipped with interchangeable core removable locks.
▶ File drawers accept hanging folders in letter or legal size.

▶ See stack-on storage and organizer options for desks, credenzas and returns, pages 231-232.

⚠ **Keyed alike cores must be ordered separately — see model HF23B on page 743.**

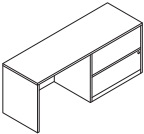
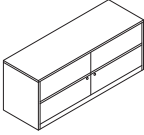
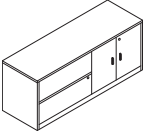
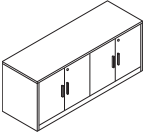
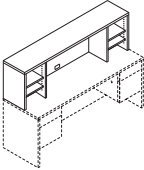
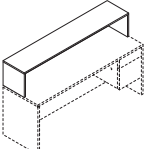

Description	Model	Ship Weight	Cube	List Price by Laminate Grade		
				L1	L2	
 <p>Bridge (Single Ped. Desk, Desk Shell, or Peninsula, to Corner Unit, Single Ped. Credenza or Credenza Shell) 47"W x 24"D x 29½"H (Clear inside depth = 21⅞"D) 42"W x 24"D x 29½"H (Clear inside depth = 21⅞"D) Bridge (for use with Corner or Extended Corner Units or Jetty or Boomerang Peninsulas) 36"W x 24"D x 29½"H (Clear inside depth = 21⅞"D) Bridge (for use with Corner or Extended Corner Units) 30"W x 24"D x 29½"H (Clear inside depth = 21⅞"D) NOTES: One cord grommet in top; one pass-through grommet in top center of modesty panel. Kneespace of desk limited to 24¾"W if bridge is used with 66"W single pedestal desk. ⚠ Not designed to attach to corner units manufactured prior to 5/24/99. Bridge (Single Ped. Desk, Desk Shell, or Peninsula to Single Ped. Credenza or Credenza Shell) 47"W x 20"D x 29½"H (Clear inside depth = 17⅞"D) 42"W x 20"D x 29½"H (Clear inside depth = 17⅞"D) NOTES: One cord grommet in top; one pass-through grommet in top center of modesty panel. Accepts optional stack-on storage model H10534 (page 232) or PC Organizer model H105388 (below). ⚠ Models H105699 and H105698 cannot be connected to corner or extended corner units or to the jetty or boomerang peninsulas, due to the 20"D "hook-up".</p>	H10570 E◆A	76	2.8	\$ 335	\$ 365	
	H10560 E◆A	72	2.6	\$ 323	\$ 353	
	H105599 E◆A	61	2.6	\$ 323	\$ 353	
	H105598 E◆A	50	1.9	\$ 323	\$ 353	
	H105699 E◆A	61	2.8	\$ 323	\$ 353	
	H105698 E◆A	54	2.6	\$ 299	\$ 329	
	 <p>Credenza with 36" Lateral (with core removable lock) 72"W x 24"D x 29½"H, Right (shown) 72"W x 24"D x 29½"H, Left NOTES: One cord pass-through grommet in top center of modesty panel. Includes hangrails. Mechanical interlock inhibits the extension of more than one drawer at a time. Accepts optional stack-on storage model H10534 (page 232) or PC Organizer model H105388 (below). ⚠ Not designed to be used with 10500 Series™ 24"D modular or mobile pedestals.</p>	H10547R	248	35.6	\$1296	\$1356
		H10548L	248	35.6	\$1296	\$1356
		 <p>Credenza with two Lateral Files (4 locking drawers. Each core removable lock secures 2 drawers) 72"W x 24"D x 29½"H NOTES: Includes hangrails; mechanical interlock inhibits the extension of more than one drawer at a time. If side-by-side drawers are opened or closed simultaneously, one drawer may interfere with the other. Two locks (keyed alike). Accepts optional stack-on storage model H10534 (page 232) or PC Organizer model H105388 (below).</p>	H105491	314	34.7	\$1871
	 <p>Credenza with Lateral File, left and Storage Cabinet, right (with core removable locks) 72"W x 24"D x 29½"H NOTES: Includes hangrails; mechanical interlock inhibits the extension of more than one drawer at a time. Storage cabinet locks and includes one adjustable interior shelf. Shelf adjusts in 1¼" increments with a total range of 5"H. Two locks (keyed alike). Accepts optional stack-on storage model H10534 (page 232) or PC Organizer model H105388 (below).</p>		H105492	307	34.7	\$1636
 <p>Credenza with Two Storage Cabinets (with core removable locks) 72"W x 24"D x 29½"H NOTES: Each storage cabinet has one interior shelf which adjusts in 1¼" increments over a total range of 5". Each cabinet locks independently; locks are keyed alike. Accepts optional stack-on storage model H10534 (page 232) or PC Organizer model H105388 (below).</p>		H105493	302	34.8	\$1525	\$1600
	 <p>Stack-on PC Organizer 72"W x 14⅝"D x 22"H (for 72"W desks, credenzas and shells) 60"W x 14⅝"D x 22"H (for 60"W desks, credenzas and shells) NOTES: Features two adjustable paper management shelves both left and right; shelves are adjustable in 1¼" increments. Shelves keep papers, files, and books within easy reach from a seated position. One cord management grommet located in the bottom center of the back panel. Design allows 20¾" of vertical clearance for computer equipment.</p>	H105388 E◆A	124	5.0	\$ 753	\$ 788
H105386 E◆A		111	4.3	\$ 697	\$ 732	
 <p>Work Organizer (shell only) 72"W x 14⅝"D x 14⅞"H (for 72"W unit) 66"W x 14⅝"D x 14⅞"H (for 66"W unit)</p>		H10537 E◆A	73	2.9	\$ 388	\$ 418
	H10536 E◆A	68	2.7	\$ 369	\$ 399	

NOTE: See pages 230 through 246 for shared components.

How to specify	Select Model Number from above	1st Option
	H 1 0 5 7 0 .	Select Laminate Top and Chassis Color See pages 48-49 N N

10500 Series™ Shared Components & Accessories

GSA SIN 711-8



▶ Shared components shown on this page can be used with modular components shown on pages 214-226 and 3/4 pedestal models shown on page 229.

▶ Rich wood-grain laminate and frosted doors with silver frames adds a contemporary mixed materials option to the 10500 Series™.

▶ Stack-on storage models are equipped with self-closing, adjustable hinged doors and valance to hide task light.

▶ See page 234 for stack-on storage back enclosures and tackboards, and page 235 for task lights.
▶ For work-in-process paper management tools, see page 241.

▶ **Removable lock core kit for locking stack-on storage is model HF27B. See page 743.**

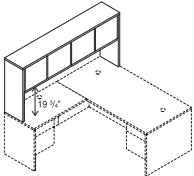
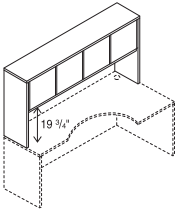
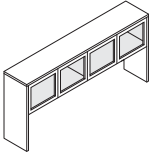
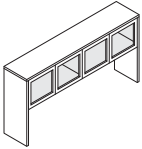
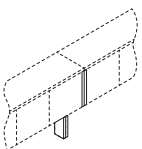

Description	Model	Ship Weight	Cube	List Price by Laminate Grade	
				L1	L2
 <p>Stack-on Storage for an "L" Workstation 78"W x 14½"D x 37½"H</p>	H105327 E	198	17.6	\$1059	\$1124
<p>Stack-on Storage for an "L" Workstation, Locking 78"W x 14½"D x 37½"H</p> <p>NOTES: Spans the total depth dimension of configurations comprised of: 48"W return or return shell attached to a 30"D single pedestal desk, desk shell or peninsula (78"D); 42"W return or return shell attached to a 36"D single pedestal desk or desk shell with a rectangle top, or to a peninsula (78"D). 42"W return or return shell attached to a 36" curved corner unit (78"D); or 42"W curved return attached to 36" curved corner unit (78"D). Use back enclosure model H105857 and tackboard model H90057. Use task light models HH870960 or HH870960CH (see page 376). For vertical paper manager model HLVP1, see page 241.</p>	H105327K E	198	17.6	\$1139	\$1204
 <p>Stack-on Storage 72"W x 14½"D x 37½"H, 4 doors (Use Task Light HH870960, see page 235) 66"W x 14½"D x 37½"H, 4 doors (Use Task Light HH870960, see page 235) 60"W x 14½"D x 37½"H, 4 doors (Use Task Light HH870960, see page 235) 48"W x 14½"D x 37½"H, 3 doors (Use Task Light HH870942, see page 235) 42"W x 14½"D x 37½"H, 2 doors (Use Task Light HH870942, see page 235) 36"W x 14½"D x 37½"H, 2 doors (Use Task Light HH870930, see page 235)</p>	H10534 E	185	17.1	\$ 935	\$ 975
	H10533 E	175	15.3	\$ 909	\$ 964
	H105324 E	164	14.0	\$ 872	\$ 927
	H105323 E	141	11.3	\$ 785	\$ 830
	H105322 E	135	4.0	\$ 643	\$ 688
	H105321 E	102	3.5	\$ 608	\$ 638
<p>Stack-on Storage, Locking 72"W x 14½"D x 37½"H, 4 doors (Use Task Light HH870960, see page 235) 66"W x 14½"D x 37½"H, 4 doors (Use Task Light HH870960, see page 235) 60"W x 14½"D x 37½"H, 4 doors (Use Task Light HH870960, see page 235) 48"W x 14½"D x 37½"H, 3 doors (Use Task Light HH870942, see page 235) 42"W x 14½"D x 37½"H, 2 doors (Use Task Light HH870942, see page 235) 36"W x 14½"D x 37½"H, 2 doors (Use Task Light HH870930, see page 235)</p> <p>NOTES: For use on respective desk, credenza or return widths. Model H10534 can be used for "L" configuration comprised of 30"D desk, desk shell or peninsula and 42"W return or return shell; or a 36"D desk, desk shell, peninsula, or corner unit and 36"W return shell. Model H115323K has one lock which secures two of the three doors. See vertical paper manager model HLVP1 on page 241.</p>	H10534K E	185	17.1	\$1015	\$1070
	H10533K E	175	15.3	\$ 989	\$1044
	H105324K E	164	14.0	\$ 952	\$1007
	H105323K E	141	11.3	\$ 825	\$ 870
	H105322K E	135	4.0	\$ 683	\$ 728
	H105321K E	102	3.5	\$ 648	\$ 688
 <p>Stack-on Storage for an "L" Workstation, Frosted Doors with Silver Frame 78"W x 14½"D x 37½"H</p> <p>NOTES: Spans the total depth dimension of configurations comprised of: 48"W return or return shell attached to a 30"D single pedestal desk, desk shell or peninsula (78"D); 42"W return or return shell attached to a 36"D single pedestal desk or desk shell with a rectangle top, or to a peninsula (78"D). 42"W return or return shell attached to a 36" curved corner unit (78"D); 42"W curved return attached to 36" curved corner unit (78"D); or 36"W return shell attached to a jetty peninsula (78"D). Use back enclosure model 105857 and tackboard model 90057. Use task light models H870960 or H870960CH. For vertical paper manager model HLVP1, see page 241.</p>	H105327G E	198	17.3	\$1659	\$1709
 <p>Stack-on Storage, Frosted Doors with Silver Frame 72"W x 14½"D x 37½"H, 4 doors (Use Task Light HH870960, see page 235) 66"W x 14½"D x 37½"H, 4 doors (Use Task Light HH870960, see page 235) 60"W x 14½"D x 37½"H, 4 doors (Use Task Light HH870960, see page 235) 48"W x 14½"D x 37½"H, 3 doors (Use Task Light HH870942, see page 235) 42"W x 14½"D x 37½"H, 2 doors (Use Task Light HH870942, see page 235) 36"W x 14½"D x 37½"H, 2 doors (Use Task Light HH870930, see page 235)</p> <p>NOTES: For respective desk, credenza or return widths. Model 10534 can be used for "L" configuration comprised of a 42"W return or return shell attached to a 30"D single pedestal desk, desk shell or peninsula (72"); 36"W return shell attached to a 36"D single pedestal desk, desk shell or peninsula (72"); or 30"W return shell attached to a jetty peninsula (72"). Back enclosures, tackboards for use with back enclosures and task lights are available as options. See vertical paper manager model HLVP1 on page 241.</p>	H10534G E	185	15.9	\$1535	\$1575
	H10533G E	175	14.6	\$1509	\$1549
	H105324G E	164	13.3	\$1472	\$1512
	H105323G E	141	10.8	\$1235	\$1265
	H105322G E	135	3.6	\$ 943	\$ 973
	H105321G E	102	3.1	\$ 908	\$ 933
 <p>Stack-on Storage Clearance End Panel Kit 1½"W x 4½"-14½"D x 36"H</p> <p>Two field installable end panels (1-right; 1-left) for use in ganging two 10500 or Valido® Series stack-on storage units. Narrow design replaces the full 14½"D end panels to expand worksurface space. The narrow right end panel replaces the standard 14½"D right end panel on one stack-on storage unit, the narrow left end panel replaces the standard 14½"D left end panel on a separate, adjacent stack-on storage unit that is in linear alignment with the first unit. Kit includes: (2) narrow end panel supports; European-style fasteners; dowels; joint connector bolts with sleeve nuts (for ganging stack-on storage units).</p> <p>NOTES: Can be used to connect up to two stack-on storage units in a line (requires 1 kit). Not available in two-tone laminate.</p>	H105349	29	3.4	\$ 331	\$ 346

SPECIFYING EXAMPLE: H105349.N

NOTE: See pages 230 through 246 for shared components.

How to specify	<p>Select Model Number from above</p> <p>Add suffix "K" to Model Number for Lock. \$80 upcharge.</p> <p>H 1 0 5 3 2 7 .</p>	<p>1st Option</p> <p>Select Laminate Top and Chassis Color</p> <p>See pages 48-49</p> <p>N N </p>
----------------	---	---

ABJ, Level, E Icon Legend on page 10

- ▶ Stack-on models below are sized to fit on 72" desk, credenza, return, or desk with return worksurfaces.
- ▶ Easy-care, scratch-, spill- and stain-resistant laminate over 1 1/8" solid core high-performance particleboard.
- ▶ Cabinets have three shelves, two are adjustable.
- ▶ Each cabinet includes a core removable lock.
- ▶ Back of cabinet door has a convenient double coat hook; the lower peg is for jackets and lighter items, the upper peg for heavier coats and bags.
- ▶ Open shelves display books, photos, and mementos, shelves are fixed height; top shelf is 3/4" thick, lower shelf is 1/8".
- ▶ Task light can be attached to underside of the bottom shelf.

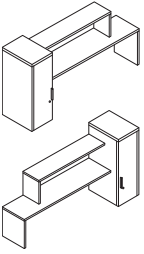

Description	Model	Ship Weight	Cube	List Price by Laminate Grade	
				L1	L2
 <p>Stack-on Cabinet, Left, Open Shelves, Right Stack-on Cabinet, Right, Open Shelves, Left Overall measures: 72"W x 20"D x 37 1/8"H Cabinet measures: 13 1/2"W x 19 1/8"D x 37 1/8"H</p> <p>NOTES: Closed door locking cabinet combines with open shelves for a clean look. Cabinet has 3 shelves (two are adjustable) and a core removable lock to secure contents. The clearance between the worksurface and underside of the lower shelf is 18 5/8". Top shelf is 45"W x 11"D, bottom shelf is 58 1/2"W x 14"D; space between the shelves is 12 1/4". Some assembly required; cabinet is fully assembled; simple shelf attachment. For two-tone color combinations, the first color designator defines the top of the storage cabinet(s), the second designator defines the color of the cabinet vertical panels and the open (exterior) shelves.</p>	H105314L E♣A	149	11.9	\$1015	\$1065
	H105313R E♣A	149	11.9	\$1015	\$1065
 <p>Stack-on Cabinets with Open Shelves, Center Overall measures: 72"W x 20"D x 37 1/8"H Cabinet measures: 13 1/2"W x 19 1/8"D x 37 1/8"H</p> <p>NOTES: Contemporary, light scale design blends open and closed storage. Features two locking cabinets bridged by two open shelves. The clearance between the worksurface and underside of the lower shelf is 18 5/8". Top shelf is 45"W x 11"D, bottom shelf is 45"W x 14"D; space between the shelves is 12 1/4". Some assembly required; cabinets are fully assembled; simple shelf attachment. For two-tone color combinations, the first color designator defines the top of the storage cabinet(s), the second designator defines the color of the cabinet vertical panels and the open (exterior) shelves.</p>	H105319 E♣A	218	20.3	\$1611	\$1691

How to specify	1st Option	2nd Option																
<p>Select Model Number from above</p> <p>H 1 0 5 3 1 4 L .</p>	<p>Select Cabinet Top and Chassis Color</p> <p>See pages 48-49</p> <p>H H .</p>	<p>Select Open Shelf Laminate</p> <table border="0"> <tr> <td>H Bourbon Cherry</td> <td>P Black</td> </tr> <tr> <td>COGN Cognac</td> <td>S Charcoal</td> </tr> <tr> <td>C Harvest</td> <td>Q Light Gray</td> </tr> <tr> <td>N Mahogany</td> <td>WHIT Brilliant White</td> </tr> <tr> <td>MOCH Mocha</td> <td></td> </tr> <tr> <td>D Natural Maple</td> <td></td> </tr> <tr> <td>PINC Pinnacle</td> <td></td> </tr> <tr> <td>F Shaker Cherry</td> <td></td> </tr> </table> <p>H </p>	H Bourbon Cherry	P Black	COGN Cognac	S Charcoal	C Harvest	Q Light Gray	N Mahogany	WHIT Brilliant White	MOCH Mocha		D Natural Maple		PINC Pinnacle		F Shaker Cherry	
H Bourbon Cherry	P Black																	
COGN Cognac	S Charcoal																	
C Harvest	Q Light Gray																	
N Mahogany	WHIT Brilliant White																	
MOCH Mocha																		
D Natural Maple																		
PINC Pinnacle																		
F Shaker Cherry																		

10500 Series™ Shared Components & Accessories

GSA SIN 711-8 Except as Noted



- ▶ Back enclosure features full-width 1 1/8" slot at the bottom to facilitate routing cords and reaching wall electrical outlets.
- ▶ Tackboard is sized 3/4" narrower than stack-on storage back enclosure, allowing 3/8" on each side to route task light cord.

- ▶ Wall attachment methodology: horizontally mounted, interlocking brackets.
- ▶ Wall mounted storage cabinet door design overlaps end panels so that when multiple units are placed side-by-side they appear as one continuous unit.

- ▶ Wall mounted storage cabinets available with laminate doors, locking brackets.
- ▶ Removable lock core kit for locking stack-on storage is model HF27B. See page 743.

- ⚠ Wall mounted storage cabinet attachment requires individual cabinets be secured by a minimum of two wall mounting locations/studs.
- ⚠ Wall mounted storage cabinets are designed for interior and perimeter walls that are constructed with wood or metal studs.

⚠ The HON Company is not responsible for any liabilities resulting from wall mounted storage cabinets that are not properly installed.

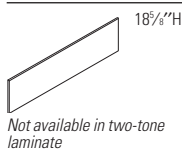

Description	Model	Ship Weight	Cube	List Price by Laminate Grade	
				L1	L2
Back Enclosure for Stack-on Storage					
75 3/4"W - for 78"W model #H105327/H105327K/H105327G	H105857	39	1.4	\$ 238	\$ 248
69 3/4"W - for 72"W model #H10534/H10534K/H10534G	H105856	33	1.3	\$ 218	\$ 228
63 3/4"W - for 66"W model #H10533/H10533K/H10533G	H105855	31	1.3	\$ 203	\$ 213
57 3/4"W - for 60"W model #H105324/H105324K/H105324G	H105854	29	1.3	\$ 194	\$ 204
45 3/4"W - for 48"W model #H105323/H105323K/H105323G	H105853	23	0.9	\$ 194	\$ 204
39 3/4"W - for 42"W model #H105322/H105322K/H105322G	H105852	21	0.9	\$ 185	\$ 195
33 3/4"W - for 36"W model #H105321/H105321K/H105321G	H105851	18	0.9	\$ 174	\$ 184

NOTES: Non-tackable.
SPECIFYING EXAMPLE: H105857.N

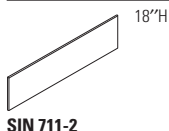

Description	Model	COM	Ship			List
			Weight	Cube		
Tackboards for use with Stack-on Back Enclosures (Back Enclosures must be ordered separately).						
75"W - for 78"W model #H105327 Hutch with #H105857 Enclosure	H90057	3	13	3.2	\$ 289	
68 3/4"W - for 72"W model #H10534 Hutch with #H105856 Enclosure	H90056	2	12	2.7	\$ 276	
62 3/4"W - for 66"W model #H10533 Hutch with #H105855 Enclosure	H90055	2	11	2.5	\$ 261	
56 3/4"W - for 60"W model #H105324 Hutch with #H105854 Enclosure	H90054	2	10	2.2	\$ 230	
44 3/4"W - for 48"W model #H105323 Hutch with #H105853 Enclosure	H90053	2	8	1.8	\$ 220	
39"W - for 42"W model #H105322 Hutch with #H105852 Enclosure	H90052	2	7	1.6	\$ 202	
33"W - for 36"W model #H105321 Hutch with #H105851 Enclosure	H90051	1	6	1.4	\$ 179	
26 3/4"W	H90050	1	5	1.2	\$ 179	

NOTES: Specify fabric, see pages 310-311. Upcharges may apply to premium fabric grades.
SPECIFYING EXAMPLE: H90057.APN15

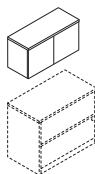

Description	Model	Ship Weight	Cube	List Price by Laminate Grade	
				L1	L2
Wall Mounted Storage Cabinet					
30"W x 14 5/8"D x 18 1/2"H, 2 doors (use task light model HH870930, see below)	H105380	73	8.7	\$ 644	\$ 679
36"W x 14 5/8"D x 18 1/2"H, 2 doors (use task light model HH870930, see below)	H105381	87	10.2	\$ 691	\$ 726
42"W x 14 5/8"D x 18 1/2"H, 2 doors (use task light model HH870942, see below)	H105382	97	11.7	\$ 759	\$ 794
48"W x 14 5/8"D x 18 1/2"H, 3 doors (use task light model HH870942, see below)	H105383	114	13.2	\$ 812	\$ 847
Wall Mounted Storage Cabinet, Locking					
30"W x 14 5/8"D x 18 1/2"H, 2 doors (use task light model HH870930, see below)	H105380K	73	8.7	\$ 684	\$ 719
36"W x 14 5/8"D x 18 1/2"H, 2 doors (use task light model HH870930, see below)	H105381K	87	10.2	\$ 731	\$ 766
42"W x 14 5/8"D x 18 1/2"H, 2 doors (use task light model HH870942, see below)	H105382K	97	11.7	\$ 799	\$ 834
48"W x 14 5/8"D x 18 1/2"H, 3 doors (use task light model HH870942, see below)	H105383K	114	13.2	\$ 852	\$ 887

NOTES: Horizontal interlocking rails are included; due to varying types of walls, installers are responsible for selecting and supplying the appropriate fasteners. Tackboard widths differ slightly from wall mounted storage cabinet widths. For applications where multiple wall mounted storage cabinets are placed side-by-side, the preferred tackboard solution may be to utilize a larger tackboard size. For wall mounted storage cabinets with frosted doors, see page 235.
SPECIFYING EXAMPLE: H105380.NN
 If Specifying with Lock Option: **H105380K.N**

NOTE: See pages 230 through 246 for shared components.

How to specify	<p>Select Model Number from above</p> <p>H 1 0 5 8 5 7 .</p> <p>H 1 0 5 3 8 0 K .</p>	<p>1st Option</p> <p>Select Laminate Top and Chassis Color</p> <p>See pages 48-49</p> <p>N</p> <p>N</p>
----------------	---	---



▶ Easy-care, scratch-, spill- and stain-resistant laminate over 1 1/8" solid core high-performance particleboard.

▶ Stacked paper management (model HLVPM2), which is 32 1/2"W, is compatible with the 30"W and 36"W wall mounted storage cabinets.

⚠ **Wall mounted storage cabinet attachment requires individual cabinets be secured by a minimum of two wall mounting locations/studs.**

⚠ **Wall mounted storage cabinets are designed for interior and perimeter walls that are constructed with wood or metal studs.**

⚠ **The HON Company is not responsible for any liabilities resulting from wall mounted storage cabinets that are not properly installed.**

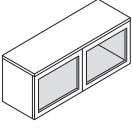

Description	Model	Ship Weight	Cube	List Price by Laminate Grade	
				L1	L2
 <p>Wall Mounted Storage Cabinet, Frosted Doors with Silver Frame 48"W x 14 5/8"D x 17 1/2"H 42"W x 14 5/8"D x 17 1/2"H 36"W x 14 5/8"D x 17 1/2"H 30"W x 14 5/8"D x 17 1/2"H</p>	H105383G	114.0	13.9	\$1262	\$1287
	H105382G	97.0	12.3	\$1059	\$1084
	H105381G	87.0	10.7	\$ 991	\$1016
	H105380G	73.0	9.1	\$ 944	\$ 969
<p>NOTES: Door design overlaps end panels so that when multiple units are placed side-by-side they appear as one continuous unit. Product placement can be aligned to match the height of storage cabinets, wardrobes and towers. Equipped with self-closing, adjustable side-hinged doors. The 30", 36", and 42"W units have two doors; the 48"W has three doors. Frosted door units do not have a lock option. Wall attachment methodology: horizontally mounted, interlocking brackets. Tackboard widths differ slightly from wall mounted storage cabinet widths. For applications where multiple wall mounted storage cabinets are placed side-by-side, the preferred tackboard width may be to utilize a larger tackboard size.</p>					

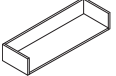
 <p>Not available in two-tone laminate</p>	Wall Mounted Open Shelf 48"W x 9 7/8"D x 4 3/4"H 42"W x 9 7/8"D x 4 3/4"H 36"W x 9 7/8"D x 4 3/4"H 30"W x 9 7/8"D x 4 3/4"H	H105363 E◆A	18.0	1.2	\$ 285	\$ 305
		H105362 E◆A	16.0	0.8	\$ 257	\$ 277
		H105361 E◆A	14.0	0.8	\$ 234	\$ 249
		H105360 E◆A	12.0	0.8	\$ 222	\$ 237
<p>NOTES: Ideal for books, photographs, and mementos up to 9"D. Two attachment orientation options, open ended shelf or shelf with book ends. Available in wood-grain or solid color laminates only. No patterns. No two-tone combinations. Simple assembly. SPECIFYING EXAMPLE: H105363.N</p>						

Description	Model	Ship Weight	Cube	List
<p>Open Market</p> <p>Recessed Task Light, 46 1/2"W x 3 1/16"D, for Models H105327, H10534, H10533 and H105324</p>	HH870960	12.0	1.1	\$ 240
<p>Recessed Task Light, 34 5/8"W x 3 1/16"D, for Models H105323, H105322, H105382 and H105383</p>	HH870942	10.0	0.9	\$ 222
<p>Recessed Task Light, 22 7/8"W x 3 1/16"D, for Models H10531, H105321, H105320, H105380 and H105381</p>	HH870930	7.0	0.6	\$ 205

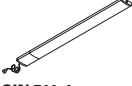
 <p>SIN 711-1</p>	LED Task Lights 17" LED Light with Power Supply (Single) 31" LED Light with Power Supply (Single)	HLED17AS HLED31AS	1.2 1.5	0.05 0.09	\$ 374 \$ 503
	17" LED Light with Power Supply for Daisy-chain (Starter) 31" LED Light with Power Supply for Daisy-chain (Starter)	HLED17A HLED31A	1.0 1.4	0.05 0.09	\$ 411 \$ 553
	17" LED Light with 8" Jumper Cord for Daisy-chain (Follower) 31" LED Light with 8" Jumper Cord for Daisy-chain (Follower)	HLED17AUO HLED31AUO	1.0 1.0	0.03 0.05	\$ 335 \$ 448
	Undercabinet Occupancy Sensor with 1" End to End Connector	HLEDOSA	0.2	0.01	\$ 78
	<p>NOTES: To use the daisy chain application, must start with model HLED17A or HLED31A. No finish specification required. Attaches magnetically to underside of overhead storage, or attaches with provided screws or double-sided tape. Occupancy sensor attaches to a single or starter LED light and will automatically turn the light off after no motion is detected for 30 minutes. Just like all the LED light models, the occupancy sensor features a soft-touch on/off switch. LED task lights have a lifetime of 50,000 hours and have a dimmer feature that allows the user to adjust the amount of light output.</p>				

How to specify	<p>Select Model Number from above</p> <p>H 1 0 5 3 8 3 G .</p>	<p>1st Option</p> <p>Select Laminate Top and Chassis Color</p> <p>See pages 48-49</p> <p>H H </p>
----------------	--	--

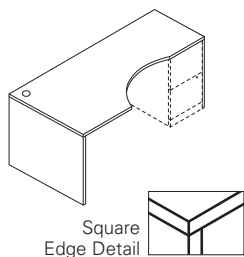

- ▶ Shared components shown on this page can be used with modular components shown on pages 214-226 and 3/4 pedestal models shown on page 229.
- ▶ Mobile pedestals, shown on page 237, work well in a variety of configurations.
- ▶ Extended corner units (H105815R and H105816L) can be used with 36"W return shell (H105680) to achieve a 6' x 6' layout.
- ▶ 36" corner unit (H105811) can be used with two 36"W return shells (H105680) to achieve a 6' x 6' layout.
- ▶ End cap bookshelf units are ideal for books and personal items — see page 239.
- ▶ For work-in-process paper management tools, see page 241.
- ▶ For 10500 Series™ matching occasional tables, use the H80191, H80192, and H80193 on page 242.
- ▶ For conference table options, see the Preside™ table tops and bases on pages 698-703.
- ▶ Mobile table quickly provides additional worksurface space, see page 243.

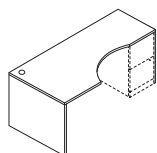

Right-hand model H105815R shown

Description	Model	Ship Weight	Cube	List Price by Laminate Grade	
				L1	L2
Extended Corner Unit 24"W x 36"D x 72"W x 24"D x 29½"H, Right (shown) 24"D x 72"W x 36"D x 24"W x 29½"H, Left	H105815R E◆A	184	7.0	\$ 993	\$1038
	H105816L E◆A	184	7.0	\$ 993	\$1038

NOTES: Intended for use with returns or bridges. Can be used freestanding. The 17" user side dimension is designed to accommodate 10500 Series™ modular or mobile pedestals up to 15¾"W. One grommet in top and one cord pass-through grommet in modesty panel. See pages 232-234 for optional stack-ons and tackboards.

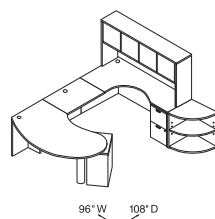
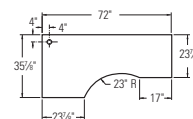

H105204L
H105102
H105598
H105815R
H105104
H10534
H105520

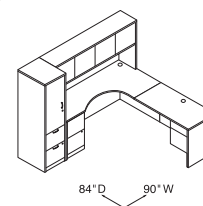

H105298L
H105816L
H10504
H10534
H10515R

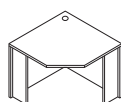

Corner Unit
24" x 36" x 36" x 24" x 29½"H
NOTES: Intended for use with 24"D x 29½"H returns or bridges. Can be used freestanding.
⚠ **Not designed to attach to returns or bridges manufactured prior to 5/24/99.**

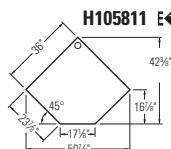

H105811 E◆A	130	3.1	\$ 714	\$ 749
-------------	-----	-----	--------	--------

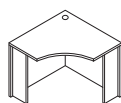

Curved Corner Unit
18" x 36" x 36" x 18" x 29½"H
NOTES: Can be used freestanding.
⚠ **Designed to be used with curved returns only.**

H105810 E◆A	128	5.4	\$ 714	\$ 749
-------------	-----	-----	--------	--------

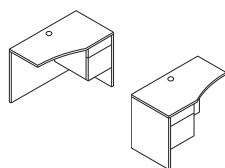

Curved Return — box/file
42"W x 18-24"D x 29½"H, Right
42"W x 24-18"D x 29½"H, Left
NOTES: Pedestal locks. One cord grommet in top; one pass-through grommet in top center of modesty panel. H105327 stack-on storage (78"W) can be used to span corner unit and return. H105322 stack-on storage (42"W) can be used on return. See page 232.
⚠ **Designed to be used with curved corner unit only.**
⚠ **Not designed to be used freestanding.**

H105817R	134	20.5	\$ 774	\$ 814
H105818L	134	20.5	\$ 774	\$ 814

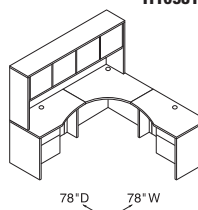

H105818L
H105810
H105327
H105817R

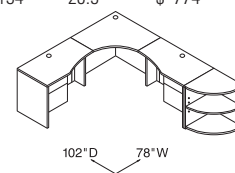





H105818
H105810
H105817R
H105520

NOTE: See pages 230 through 246 for shared components.

How to specify	1st Option
Select Model Number from above H 1 0 5 8 1 5 R .	Select Laminate Top and Chassis Color See pages 48-49 N N

- ▶ For additional components that can be shared with 10500 Series™, see pages 230-246.
- ▶ Versatile mobile pedestals work well in a variety of configurations. Can be used freestanding, under modular shells, or with 10500 Series™ component worksurfaces and supports.
- ▶ 24" D lateral file, storage cabinet, and bookcase models align evenly with credenzas and returns to provide linear layout continuity.
- ▶ At 45½" H, the three-drawer lateral file can be used as a standing-height worksurface or to support office equipment.
- ▶ Drawers operate on full extension, ball-bearing suspensions to ensure smooth, quiet, long-lasting operation.
- ▶ File drawer design includes integrated hangrails for side-to-side letter or legal filing; and front-to-back for letter filing.
- ▶ Mobile printer/fax cart shown on page 226 is ideal for limited space.

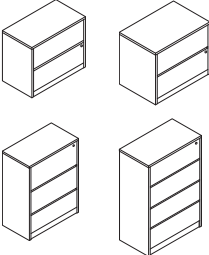
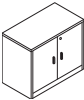
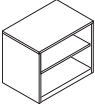
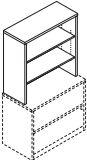

	Description	Model	Ship Weight	Cube	List Price by Laminate Grade	
					L1	L2
	Box/Box/File Mobile Pedestal (with core removable lock) 15¾"W x 22¾"D x 28⅝"H — use freestanding or under 24"D, 30"D and 36"D modular shells NOTES: Top box drawer does not lock. File drawer includes hangrails.	H105102	121	8.5	\$ 789	\$ 829
	File/File Mobile Pedestal (with core removable lock) 15¾"W x 22¾"D x 28⅝"H — use freestanding or under 24"D, 30"D and 36"D modular shells NOTES: File drawers include hangrails.	H105104	121	8.4	\$ 789	\$ 829
	Box/File Mobile Pedestal (with core removable lock) 15¾"W x 18⅝"D x 21⅞"H — use freestanding or under 20"D, 24"D, 30"D and 36"D modular shells	H105106	65	5.8	\$ 660	\$ 690
	Shelf/Box/File Mobile Pedestal (with core removable lock) 15¾"W x 18⅝"D x 28⅝"H — use freestanding or under 20"D, 24"D, 30"D and 36"D modular shells NOTES: Interior dimensions of the open storage area of the Shelf/Box/File model are 14⅞"W x 16¾"D x 6⅝"H.	H105109	73	7.3	\$ 727	\$ 767
	Lateral File (with core removable lock) 36"W x 20"D x 29½"H — two drawer 36"W x 24"D x 29½"H — two drawer 36"W x 20"D x 45½"H — three drawer 36"W x 20"D x 59⅞"H — four drawer NOTES: Includes hangrails, mechanical interlock and in H10563 and H105690, a counterweight. Stack-on storage (H105321) and bookcase hutch (H105292) can be used with H10563 and H105690. Interlock inhibits the extension of more than one drawer from opening at a time. Model H105690 aligns with 24"D credenzas and returns.	H10563 H105690 H10517 H10516	170 191 240 305	15.6 17.6 23.2 31.0	\$ 899 \$ 945 \$1478 \$1949	\$ 949 \$1000 \$1543 \$2019
	Storage Cabinet with Doors (with core removable lock) 36"W x 20"D x 29½"H 36"W x 24"D x 29½"H NOTES: Includes one adjustable shelf. Shelf adjusts in ¼" increments with a total range of 6¼"H. Stack-on storage (H105321), and bookcase hutch (H105292) can be used with H105291 or H105290. Model H105290 aligns with 24"D credenzas and returns.	H105291 H105290	147 168	15.0 17.6	\$ 722 \$ 857	\$ 772 \$ 912
	Bookcase 36"W x 24"D x 29½"H, 2-Shelf, 1-Adjustable NOTES: Adjustable shelf is 22"D and adjusts in ¼" increments, with a total range of 5". 24" depth aligns evenly with 24"D credenzas, credenza shells, returns, return shells, and wardrobe/storage cabinets to provide linear layout continuity. Adjustable leveling glides. Accommodates the 36"W stack-on storage or bookcase hutch. Ships fully assembled.	H105531	102	18.4	\$ 689	\$ 704
	Bookcase Hutch (for use with lateral file models H10563/H105690, storage cabinet models H105291/H105290, and bookcase model H105531) 36"W x 14⅝"D x 37⅞"H NOTES: Cord pass-through gap behind shelves and a 1⅞"H full-width cord management slot at the bottom of the back panel. Two shelves are adjustable in ¼" increments with a total range of 17½"H.	H105292 EDA	103	3.6	\$ 527	\$ 542

NOTE: See pages 230 through 246 for shared components.

How to specify	Select Model Number from above H 1 0 5 1 0 2 .	1st Option Select Laminate Top and Chassis Color See pages 48-49 N N
----------------	---	--

10500 Series™ Shared Components & Accessories

GSA SIN 711-8







▶ Broad family of storage components takes organization way beyond the confines of a desk drawer.

▶ Locking units equipped with interchangeable core removable locks.

▶ Adjustable hex leveling glides allow floor-standing furniture to be easily leveled without lifting the unit; glides have 3/4" adjustable range.

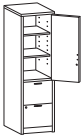
▲ **Keyed alike cores must be ordered separately — see model HF23B on page 743 — makes re-keying quick and easy.**

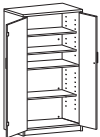
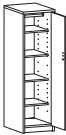
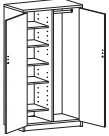

Description	Model	Ship Weight	Cube	List Price by Laminate Grade	
				L1	L2
 <p>Storage/File Cabinet (with core removable locks) 18"W x 24"D x 66 5/8"H, Hinged Right (shown) 18"W x 24"D x 66 5/8"H, Hinged Left</p> <p>NOTES: Versatile unit features a storage cabinet and two file drawers. Storage cabinet includes three shelves, two are adjustable in 1/2" increments. Door hinged left or right models available. File drawers operate on ball-bearing suspensions with full extension. File drawers have high sides to accept hanging folders in letter or legal size. Drawers standard with hangrails. Both the storage cabinet and the file drawers are equipped with a HON "One Key" interchangeable core removable lock. Unit height is designed to match credenza or return plus stack-on storage height.</p>	H105297R	258	22.7	\$1565	\$1640
	H105298L	258	22.7	\$1565	\$1640
 <p>Storage Cabinet/Lateral File (with core removable lock) 36"W x 24"D x 66 5/8"H</p> <p>NOTES: Storage cabinet is standard with one fixed and two full-width adjustable shelves in top compartment; adjustable shelves can be removed. Overall storage compartment measures 31 1/4"W x 22"D x 36 1/8"H and will accommodate supplies, books and binders, as well as business machines and electronic equipment. Cord pass-through gap behind shelves and grommet in back of the cabinet to facilitate routing cords and reaching wall electrical outlets. Two drawer lateral file on bottom. Lateral file comes with mechanical interlock and hangrails. Cabinet and lateral file lock independently. Unit height is designed to match credenza or return plus stack-on storage height.</p>	H105293	365	41.0	\$2109	\$2209
 <p>Storage Cabinet with Full-width Shelves (with core removable lock) 36"W x 24"D x 66 5/8"H</p> <p>NOTES: Large storage area includes five, full-width (side-to-side) shelves; three are adjustable in 2 1/2" increments. Unit height matches credenza or return plus stack-on storage height.</p>	H105299	341	39.6	\$1968	\$2068
 <p>Personal Wardrobe/Storage Cabinet (with core removable lock) 18"W x 24"D x 66 5/8"H, Hinged Right (shown) 18"W x 24"D x 66 5/8"H, Hinged Left</p> <p>NOTES: Unit is standard with four adjustable shelves, coat rod, and core removable lock. Shelves adjust in 2 1/2" increments. Cabinet can be used as a wardrobe by removing four adjustable shelves. Coat rod can be removed from cabinet for storage only applications. Unit height is designed to match credenza or return plus stack-on storage height.</p>	H105295R	223	22.9	\$1418	\$1493
	H105296L	223	22.9	\$1418	\$1493
 <p>Personal Wardrobe/Storage Cabinet (with core removable lock) 36"W x 24"D x 66 5/8"H</p> <p>NOTES: Spacious design is standard with four adjustable shelves (one shelf is fixed), coat rod and core removable lock which locks both doors. Shelves adjust in 2 1/2" increments. Unit height is designed to match credenza or return plus stack-on storage height.</p>	H10530	341	41.0	\$2109	\$2121
 <p>Personal Storage Tower (with core removable locks) 24"W x 24"D x 66 5/8"H, wardrobe Hinged Right, storage cabinet Hinged Left (shown) 24"W x 24"D x 66 5/8"H, wardrobe Hinged Left, storage cabinet Hinged Right</p> <p>NOTES: Spacious design includes a wardrobe closet, storage cabinet, and two file drawers in one compact unit. Wardrobe closet contains a coat rod. Storage cabinet includes three shelves, two are adjustable in 2 1/2" increments. Door hinged left or right models available. File drawers operate on ball-bearing suspensions with full extension. File drawers have high sides to accept hanging folders in letter or legal size. Drawers standard with hangrails. Equipped with HON "One Key" interchangeable core removable locks. Upper lock secures storage cabinet and wardrobe closet doors; lower lock secures file drawers. Unit height is designed to match credenza or return plus stack-on storage height.</p>	H105301R	299	27.9	\$1981	\$2076
	H105302L	299	27.9	\$1981	\$2076

NOTE: See pages 230 through 246 for shared components.

How to specify	<p>Select Model Number from above</p> <p>H 1 0 5 2 9 7 R .</p>	<p>1st Option</p> <p>Select Laminate Top and Chassis Color</p> <p>See pages 48-49</p> <p>N N </p>
----------------	---	---

AB, level, ONE KEY, Icon Legend on page 10

► For 24"D two-shelf bookcase, to align evenly with credenzas and returns, see page 237.



	Description	Model	Ship Weight	Cube	List Price by Laminate Grade	
					L1	L2
 H105532 shown	Bookcase					
	2 Shelf, 36"W x 13 1/8"D x 29 5/8"H	H105532	90	11.0	\$ 438	\$ 453
	3 Shelf, 36"W x 13 1/8"D x 43 3/8"H	H105533	122	15.6	\$ 556	\$ 576
	4 Shelf, 36"W x 13 1/8"D x 57 1/8"H	H105534	156	20.2	\$ 656	\$ 681
	5 Shelf, 36"W x 13 1/8"D x 71"H	H105535	187	25.1	\$ 763	\$ 793

NOTES: Fixed shelves. Inside shelf dimensions on all units is 33 3/4"W x 12"D x 13"H. No assembly required.

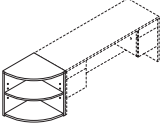
	End Cap Bookshelf (2 shelves, 1 fixed, 1 adjustable. Adjusts in 1/2" increments with a total range of 10"H) 24"W x 24"D x 29 1/2"H	H105520 E♦A	84	2.6	\$ 557	\$ 572
---	--	--------------------	----	-----	--------	--------

NOTES: Unit is freestanding. Designed to be positioned at the end of 24"D credenzas and returns. Ideal for books, photos, plants and mementos.

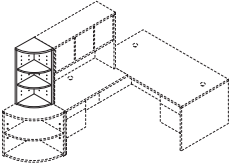
	End Cap Bookshelf (3 shelves, 1 fixed, 2 adjustable. Adjusts in 1/2" increments with a total range of 25"H) 15"W x 15"D x 37 1/8"H	H105523 E♦A	53	2.2	\$ 479	\$ 494
---	--	--------------------	----	-----	--------	--------

NOTES: Unit is designed to be positioned at the end of stack-on storage and on top of model H105520. Combined height of models H105520 and H105523 matches credenza or return plus stack-on storage height. Can be used freestanding.

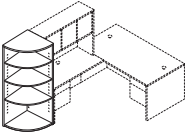
	End Cap Bookshelf 24"W x 24"D x 66 5/8"H	H105524 E♦A	164	4.8	\$ 929	\$ 954
---	--	--------------------	-----	-----	--------	--------

NOTES: Designed to be positioned at the end of 24"D credenzas with stack-on storage, 24"D returns with stack-on storage, 24"D storage/file cabinet, 24"D storage cabinet/lateral file, 24"D wardrobe/storage cabinets, or the 24"D personal storage tower. Unit has four shelves, three are adjustable in 1/2" increments, with a total range of 45"H; bottom shelf is fixed.

 Model H105525R Model H105526L	Square End Cap Bookshelf — 2-Fixed Shelves					
	24"W x 24"D x 29 1/2"H, Right	H105525R E♦A	92	3.6	\$ 552	\$ 567
	24"W x 24"D x 29 1/2"H, Left	H105526L E♦A	92	3.6	\$ 552	\$ 567

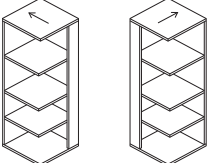
 Model H105527R Model H105528L	Square End Cap Bookshelf — 4-Fixed Shelves					
	24"W x 24"D x 66 5/8"H, Right	H105527R E♦A	172	5.9	\$ 887	\$ 912
	24"W x 24"D x 66 5/8"H, Left	H105528L E♦A	172	5.9	\$ 887	\$ 912

NOTES: Units are freestanding. Designed to be positioned next to 24"D models or as a corner bookcase.
 End cap, left: grain direction on top aligns with grain direction on tops of left pedestal returns and left credenza models or when positioned to the left side of credenzas with doors or kneespace models.
 End cap, right: grain direction on top aligns with grain direction on tops of right pedestal returns and right credenza models or when positioned to the right side of credenzas with doors or kneespace models.

How to specify	Select Model Number from above	1st Option	Select Laminate Top and Chassis Color
	H 1 0 5 5 3 2 .	See pages 48-49	N N

10500 Series™ Shared Components & Accessories

GSA SIN 711-8



- ▶ Three welcoming reception station designs to choose from — stack-on enclosure, full-to-floor shell, or front-suspended counter.
- ▶ Versatile mobile office table is ideal for additional worksurface space, meetings, and special projects. See page 243.
- ▶ For 10500 Series™ matching reception area furniture, see Occasional Tables on page 242.

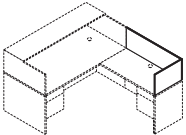

Description	Model	Ship Weight	Cube	List Price by Laminate Grade	
				L1	L2
 <p>Reception Station with Transaction Counter, for 72"W x 36"D Desk, or Desk Shell, with rectangle top 72"W x 36"D x 14 1/4"H</p> <p>H105720 E♣A</p> <p>92 3.0 \$ 465 \$ 500</p> <p>NOTES: For desk tops without grommets, see field installable grommet kit, model HFLDGRMT on page 245. Transaction counter organizer (HTCOL52) fits under/inside of transaction counter (see below).</p>					

 <p>Reception Station for 42"W x 24"D Return or Return Shell 42"W x 24"D x 13"H</p> <p>H105722 E♣A</p> <p>2 1.0 \$ 233 \$ 253</p>					
<p>Reception Station for 48"W x 24"D Return or Return Shell 48"W x 24"D x 13"H</p> <p>H105721 E♣A</p> <p>25 3.6 \$ 265 \$ 285</p> <p>NOTES: For return tops without grommets, see field installable grommet kit, model HFLDGRMT on page 245. Not available in two tone laminate. Designed specifically for use with Reception Station with Transaction Counter, model H105720.</p> <p>SPECIFYING EXAMPLE: H105722.N</p>					

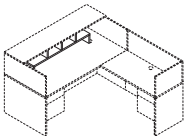
Description	Model	Ship Weight	Cube	List
 <p>Transaction Counter Organizer 48 3/4"W x 11 1/8"D x 13"H</p> <p>HTCOL52 E♣A</p> <p>24 1.1 \$ 252</p> <p>NOTES: Fits under reception station with transaction counter model H105720 reception desk shell (H105724), and work organizer models H10537 and H10536.</p> <p>▲ Black only.</p> <p>SPECIFYING EXAMPLE: HTCOL52.P</p>				

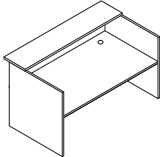
Description	Model	Ship Weight	Cube	List Price by Laminate Grade	
				L1	L2
 <p>Reception Desk Shell, with rectangle top 72"W x 39 7/8"D x 44 7/16"H</p> <p>H105724 E♣A</p> <p>294 17.0 \$ 995 \$1050</p> <p>NOTES: Non-handed design. Integrated 18 5/8"D transaction counter with a 4" full-width overhang. Two cord management grommets in top for routing and hiding wires and cables. Transaction counter organizer model TCOL52 fits under/inside transaction counter. When a two-tone color combination is specified, the first designator defines the transaction countertop and the desk worksurface.</p>					

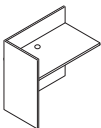
 <p>Reception Station Return Shell 42"W x 24 3/8"D x 42 15/16"H</p> <p>H105726 E♣A</p> <p>131 17.0 \$ 693 \$ 728</p> <p>NOTES: Non-handed design for use with reception desk shell. One cord management grommet in top for routing and hiding wires and cables. Woodgrain on approach side is vertical to match grain direction on end panels of reception station desk. Designed specifically for use with Reception Desk Shell, model H105724.</p>					
--	--	--	--	--	--

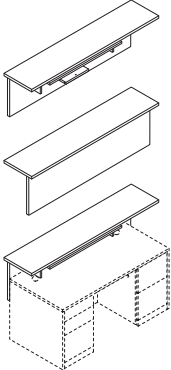
 <p>Transaction Counter for Reception Desk 66"W x 14 5/8"D x 14 1/4"H</p> <p>H105729 E♣A</p> <p>100 4.2 \$ 578 \$ 603</p> <p>NOTES: Off-the-worksurface solution designed for use with 72"W or 66"W desks or desk shells with a 1 1/8" thick rectangle top and a full-width conference (approach-side) overhang of 4 1/2"D minimum. Choose from two height options at time of installation; 13 3/8"H (upper position) or 5 1/2"H (lower position) above the desktop. Attaches easily and securely without any drilling or double-sided tape on the worksurface. Grain direction: side-to-side on countertop; horizontal on approach and users side vertical panel.</p>					
--	--	--	--	--	--

NOTE: See pages 230 through 246 for shared components.

How to specify	1st Option
<p>Select Model Number from above</p> <p>H 1 0 5 7 2 0 .</p>	<p>Select Laminate Top and Chassis Color</p> <p>See pages 48-49</p> <p>N N</p>

- ▶ For 10500 Series™ matching Occasional Tables, see page 242.
- ▶ Vertical paper manager designed for desk, credenza, and return tops. Fits under stack-on storage.

- ▶ Stacked paper management segments and organizes stack-on and wall mount storage compartments, as well as bookcase shelves. Unit can be used in models H105327, H10534, H105322, H105321, H105382 and H105381.

- ▶ Desktop Storage Terrace is for use on the tops of 29½”H desks, credenzas, and returns.
- ▶ Desktop Storage Terrace features six storage sections plus top display shelf.

- ▶ Desktop Paper Shelf and Storage Terrace include protective, non-slip pads on the base.
- ▶ Paper Shelf can stack two-high.
- ▶ Hanging Paper Shelf attaches quickly and easily (screws included).

⚠ In some cases, installation of Stacked Paper Management may require removing the stack-on or wall mount storage doors.

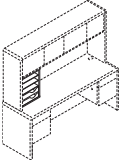

Description	Model	Ship Weight	Cube	List Price by Laminate Grade	
				L1	L2
 <p>Vertical Paper Manager 14⅞”W x 10⅞”D x 19⅞”H</p> <p>NOTES: Keeps papers, files, and books neatly organized and within easy reach from a seated position. Designed for desk, credenza, and return tops. Fits under stack-on storage models. Two pullout drawers and three fixed shelves. Unit can also be used with 10700 Series™, Valido®, Park Avenue Collection® Laminate and 94000 Series™. When used in conjunction with wall mounted storage cabinets, the top of the wall mounted storage cabinets must be positioned a minimum of 68” above the floor.</p> <p>SPECIFYING EXAMPLE: HLVPM1.N</p>	HLVPM1	27	2.8	\$ 298	\$ 308

Not available in two-tone laminate
SIN 711-8

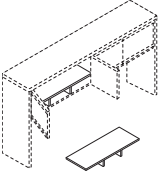
Description	Model	Ship Weight	Cube	List	
				L1	L2
 <p>Stacked Paper Management 32½”W x 12⅝”D x 4¼”H</p> <p>NOTES: Segments and organizes stack-on and wall mount storage compartments, as well as bookcase shelves. In some cases, installation may require removing the stack-on or wall mount storage doors.</p> <p>⚠ Black only.</p>	HLVPM2 E♦A	22	1.25	\$ 144	

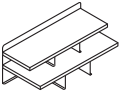
Description	Model	Ship Weight	Cube	List Price by Laminate Grade	
				L1	L2
 <p>Desktop Storage Terrace 26½”W x 12½”D x 10½”H</p> <p>NOTES: Keeps work-in-process, priority files, loose pages, and mail neatly organized and in view. Mixed material design comprised of sturdy laminate shelves with metal back and support panels. Not available in two-tone laminate combination or pattern laminate colors. Choose from Platinum Metallic (T1), Black (P), and Charcoal (S) for the metal components.</p> <p>Sized to fit in stack-on and wall mounted storage cabinets in 10500, 10700, Valido, 94000, Park Avenue Laminate, and 38000 Series. Fits in Voi stack-on and overhead cabinets except for 48”W or smaller sliding door models.</p> <p>Specify: Model.Laminate.Paint</p> <p>SPECIFYING EXAMPLE: HLDST1.N.T1</p>	HLDST1 E♦A	24	1.1	\$ 272	\$ 282

Not available in two-tone laminate

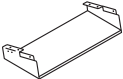
Description	Model	Ship Weight	Cube	List	
				L1	L2
 <p>Hanging Paper Shelf 28⅞”W x 11⅞”D x 4⅝”H</p> <p>NOTES: Maximizes worksurface space; de-clutters desktop while placing priority communications and active project folders within easy reach. Angled design allows contents to be distinguished at a glance. Mixed material styling features strong painted metal frame with a frosted shelf.</p> <p>Attaches quickly and easily to stack-on and wall mount storage models in the following series: 10500, 10700, Valido, Park Avenue Laminate, 94000, Pennsylvania Avenue, and Voi (except the 36”W overhead hutch with O-legs or panel mount brackets). Not for use with 38000 Series.</p> <p>Choose from Platinum Metallic (T1), Black (P), and Charcoal (S) paint.</p> <p>Specify: Model.Paint</p> <p>SPECIFYING EXAMPLE: HHPS1.T1</p>	HHPS1	7	2.9	\$ 175	

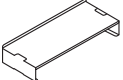
Description	Model	Ship Weight	Cube	List	
				L1	L2
 <p>Desktop Paper Shelf 28⅞”W x 11⅞”D x 5”H</p> <p>NOTES: Organizer shelf provides a place and space for work-in-process and piling to keep worksurfaces neat and tidy. Convenient, scalable design with interlocking side supports allow two units to be stacked and integrated. Durable painted metal frame with a frosted shelf; mixed material styling matches hanging paper shelf.</p> <p>Can also be used inside select overhead storage, including the following stack-on with hinged door models: 10500 and Valido 36”, 42”, 66”, 72”, 78”W and 10700 68⅝”W.</p> <p>Choose from Platinum Metallic (T1), Black (P), and Charcoal (S) paint.</p> <p>Specify: Model.Paint</p> <p>SPECIFYING EXAMPLE: HDPS1.T1</p>	HDPS1	7	2.9	\$ 175	

NOTE: See pages 230 through 246 for shared components.

How to specify	<p>Select Model Number from above</p> <p>H L V P M 1 .</p>	<p>1st Option</p> <p>Select Laminate</p> <p>See pages 48-49</p> <p>N </p>
----------------	--	---

10500 Series™ Laminate Occasional Tables

GSA SIN 711-11

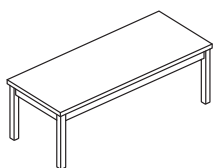

► Durable material and construction make laminate occasional tables ideal for high traffic areas such as lobbies, reception rooms and lounges. Versatile design is also well suited to private offices.







► Tables accommodate lamps, magazines, telephones, plants, laptops and more.

► Coffee, Corner and End Tables feature top-over-apron styling with square corner detail, which complements many interiors and furniture designs.

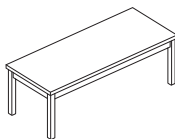
► Tops are abrasion- and stain-resistant laminate over 1/8" thick solid core high-performance particleboard.

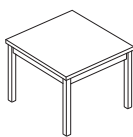
Edge Detail

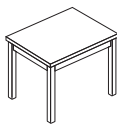

	Description	Model	Ship Weight	Cube	List
	Coffee Table 48"L x 20"W x 16"H	H80191 E◆A	48 	3.4	\$ 431
	Corner Table 24"L x 24"W x 20"H	H80192 E◆A	35 	2.1	\$ 372
	End Table 24"L x 20"W x 20"H	H80193 E◆A	29 	1.8	\$ 355

Laminate Occasional Tables (H80191, H80192 and H80193)

Woodgrain: Bourbon Cherry (HH), Cognac (COGNCOGN), Harvest (CC), Mahogany (NN), Mocha (MOCHMOCH), Natural Maple (DD), Pinnacle (PINCPINC), Shaker Cherry (FF).

Solid: Black (PP), Brilliant White (WHITWHIT), Charcoal (SS).

Patterned: Canyon Zephyr (K9), Desert Zephyr (K8), Grey Tigris (L6*), Sheer Mesh (A5), Silver Mesh (B9).

* Select edge/apron/leg color — Black (P), Bourbon Cherry (H), Brilliant White (WHIT), Charcoal (S), Cognac (COGN), Harvest (C), Mahogany (N), Mocha (MOCH), Natural Maple (D), Pinnacle (PINC), Shaker Cherry (F).

Two-Tone: Black/Brilliant White (PWHIT), Black/Charcoal (PS), Bourbon Cherry/Black (HP), Bourbon Cherry/Brilliant White (HWHIT), Bourbon Cherry/Charcoal (HS), Brilliant White/Black (WHITP), Brilliant White/Bourbon Cherry (WHITH), Brilliant White/Charcoal (WHITS), Brilliant White/Cognac (WHITCOGN), Brilliant White/Harvest (WHITC), Brilliant White/Mahogany (WHITN), Brilliant White/Mocha (WHITMOCH), Brilliant White/Natural Maple (WHITD), Brilliant White/Pinnacle (WHITPINC), Brilliant White/Shaker Cherry (WHITF), Charcoal/Black (SP), Charcoal/Brilliant White (SWHIT), Cognac/Black (COGNP), Cognac/Brilliant White (COGNWHIT), Cognac/Charcoal (COGNS), Harvest/Black (CP), Harvest/Brilliant White (CWHIT), Harvest/Charcoal (CS), Mahogany/Black (NP), Mahogany/Brilliant White (NWHIT), Mahogany/Charcoal (NS), Mocha/Black (MOCHP), Mocha/Brilliant White (MOCHWHIT), Mocha/Charcoal (MOCHS), Natural Maple/Black (DP), Natural Maple/Brilliant White (DWHIT), Natural Maple/Charcoal (DS), Pinnacle/Black (PINCP), Pinnacle/Brilliant White (PINCWHIT), Pinnacle/Charcoal (PINCS), Shaker Cherry/Black (FP), Shaker Cherry/Brilliant White (FWHIT), Shaker Cherry/Charcoal (FS).

NOTE: See pages 230 through 246 for shared components.

How to specify	Select Model Number from above	1st Option Select Laminate See above
	H 8 0 1 9 1 .	N N
	H 8 0 1 9 1 .	L 6 N

 E◆A  Icon Legend on page 10

► Easy-care, scratch-, spill- and stain-resistant laminate over 1/8" solid core high-performance particleboard.

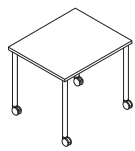

Description	Model	Ship Weight	Cube	List Price by Laminate Grade	
				L1	L2
Mobile Table 36"W x 30"D x 29½"H	H105T3036C E♦A	56	11.0	\$ 591	\$ 606
30"W x 24"D x 29½"H	H105T2430C E♦A	42	7.1	\$ 530	\$ 542

NOTES: Rectangle-shaped top. Versatile design quickly provides additional worksurface space; ideal for work-in-process, meetings, and special projects. Choose from two sizes to align with either 30" and 36"D or 24" and 30"D worksurfaces. Roll easily on 4 casters; 2 locking, 2 non-locking. Top and legs ship together in one carton. Simple assembly. Paint options for post leg are Black (P), Charcoal (S), Brilliant White (WHIT), and Platinum Metallic (T1).

Specify: Model.Worksurface Laminate.Edge Color.Base Paint Color

SPECIFYING EXAMPLE: H105T3036C.N.N.S

How to specify	1st Option	2nd Option	3rd Option
Select Model Number from above H 1 0 5 T 3 0 3 6 C .	Select Worksurface Laminate See pages 48-49 N .	Select Edge Color See pages 48-49 N .	Select Base Paint Color S Charcoal S

10500 Series™ Shared Components & Accessories

GSA SIN 711-8

HON

- ▶ Field Installable Drawer/Door Handle Kits for use on 10500 Series™ desks, credenzas, returns and lateral files.
- ▶ Metal template, for field installation of the Linear, Arch, Sweep and Crescent decorative handles, on 10500 and 10700 Series™ drawer fronts, can be ordered through HON Customer Support. Hardware Pack 251-0251. Order SPLH-SYST-DRKNB.M263164.



Description	Model	Ship Weight	Cube	List
Field Installable Drawer/Door Handle Kits Sweep Black, 2-pack Sweep Satin Nickel, 2-pack	HSWEEPA2	0.4	0.3	\$ 38
	HSWEEPC2	0.4	0.3	\$ 38
Sweep Black, 3-pack Sweep Satin Nickel, 3-pack	HSWEEPA3	0.5	0.3	\$ 49
	HSWEEPC3	0.5	0.3	\$ 49
Crescent Black, 2-pack Crescent Satin Nickel, 2-pack	HCRESCENTA2	0.4	0.3	\$ 38
	HCRESCENTC2	0.4	0.3	\$ 38
Crescent Black, 3-pack Crescent Satin Nickel, 3-pack	HCRESCENTA3	0.5	0.3	\$ 49
	HCRESCENTC3	0.5	0.3	\$ 49

NOTES: Handles are for purchase and field installation on 10500 or 10700 Series™ desks, credenzas, returns, and lateral files, as well as for the modular pedestals used with 10700 and 10500.

Applications include:

- box/file and file/file pedestals = one 2-pack per pedestal
- box/box/file and pencil/media/file pedestals = one 3-pack per pedestal
- two drawer lateral file = two 2-packs per unit
- four drawer lateral file = four 2-packs per unit

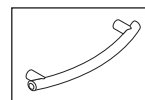

Sweep Handle

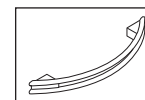

Crescent Handle

The hole spacing for the Sweep and Crescent handles is 96mm (approx. 3³/₄"). Important note: effective January 1, 2007, the holes used for the black drawer/door handle that comes standard on several HON 10500 and 10700 Series™ products, including mobile pedestals, storage cabinet with doors, storage/file cabinet, storage cabinet/lateral file, personal wardrobe/storage cabinets, and personal storage towers, will accept the Sweep and Crescent handles. Units manufactured prior to January 1, 2007, have 64mm (approx. 2¹/₂") hole spacing and will not accept the Sweep and Crescent handles. Instructions include mounting hardware and paper template.

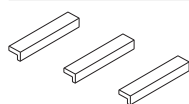

Field Installable Drawer/Door Handle Kits

Linear, Black, 2-pack
Linear, Matte Chrome, 2-pack

HLINEARA2 0.4 0.3 \$ 49
HLINEARC2 0.4 0.3 \$ 49

Linear, Black, 3-pack
Linear, Matte Chrome, 3-pack

HLINEARA3 0.5 0.3 \$ 57
HLINEARC3 0.5 0.3 \$ 57

Specify Linear handles in black to coordinate with 10500 Series™ models that ship standard with a decorative handle, such as mobile pedestals, storage cabinets and wardrobes.

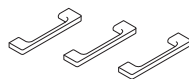

Arch, Black, 2-pack
Arch, Matte Chrome, 2-pack

HARCHA2 0.4 0.3 \$ 49
HARCHC2 0.4 0.3 \$ 49

Arch, Black, 3-pack
Arch, Matte Chrome, 3-pack

HARCHA3 0.5 0.3 \$ 57
HARCHC3 0.5 0.3 \$ 57

NOTES: Handles are for purchase and field installation on 10500 or 10700 Series™ desks, credenzas, returns, lateral files and modular pedestals. Instructions include mounting hardware and paper template for drilling holes.

Applications include:

- box/file and file/file pedestals = one 2-pack per pedestal
- box/box/file and pencil/media/file pedestals = one 3-pack per pedestal
- two drawer lateral file = two 2-packs per unit
- four drawer lateral file = four 2-packs per unit

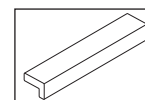

Linear Handle

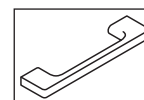

Arch Handle

The Linear and Arch handles can be attached using 96mm (approx. 3³/₄") or 128mm (approx. 5") hole spacing. Important note: effective January 1, 2007, the holes used for the black drawer/door handle that comes standard on several HON 10500 and 10700 Series™ products, including mobile pedestals, storage cabinet with doors, storage/file cabinet, storage cabinet/lateral file, personal wardrobe/storage cabinets, and personal storage towers, will accept the Linear and Arch handles. Units manufactured prior to January 1, 2007, have 64mm (approx. 2¹/₂") hole spacing and will not accept the Linear and Arch handles.













NOTE: See pages 230 through 246 for shared components.

How to specify

Select Model Number
from above

H | S | W | E | E | P | A | 2 |

Icon Legend on page 10

	Description	Model	Ship Weight	Cube	List
	Field Installable Grommet <ul style="list-style-type: none"> Intended for use in tops and end panels to route/hide cords and in modesty panels to facilitate reaching wall electrical outlets. Grommet is field installable. Grommet shape is round. Includes grommet cap and sleeve. Grommet cap measures 3" diameter and includes a 3/4" diameter cord access hole. Grommet sleeve measures 2 1/2" O.D. x 3/4" thick. Includes instructions to locate grommet position for desks, credenzas, returns and bridges. <p>▲ Black Finish ▲ Requires a 2 1/2" diameter hole saw and drill for installation (not included).</p>	HFLDGRMT	0.1 	0.01	\$ 28
	Field Installable Grommet <ul style="list-style-type: none"> Intended for use in tops and end panels to route/hide cords and in modesty panels to facilitate reaching wall electrical outlets. Grommet is field installable. Grommet shape is round. Includes grommet cap and sleeve. Grommet outside dimensions measure 3 1/2" diameter and includes two cord access holes. Grommet sleeve measures 3" O.D. x 1" thick. Includes instructions to locate grommet position for desks, credenzas, returns and bridges. <p>▲ Black Finish ▲ Requires a 3" diameter hole saw and drill for installation (not included).</p>	HFLDGRMT3	0.1 	0.3	\$ 28
 SIN 71-302	Power Hub, 3" Grommet Mount <ul style="list-style-type: none"> Brings the ease of plug-and-play to the desktop. Fits in 3" round grommet holes in 10500 Series™ desks, credenzas and returns; not compatible with 10500 Series™ 2 1/2" round grommets. Two grounded AC power outlets. Two cord pass-through holes in cap. Includes 6' cord with three-prong plug. For field installation. UL Listed. <p>▲ Available in Black only (no color designation – Specify: HGRMTAC.X).</p>	HGRMTAC	1.3	0.2	\$ 100
 SIN 71-302	<p><i>Open Market</i></p> Power/USB Hub, 3" Grommet Mount <ul style="list-style-type: none"> Brings the ease of plug-and-play to the desktop. Fits in 3" round grommet holes in 10500 Series™ desks, credenzas and returns; not compatible with 10500 Series™ 2 1/2" round grommets. One grounded AC power outlet with 2 USB ports. Two cord pass-through holes in cap. Includes 6' cord with three-prong plug. For field installation. UL Listed. <p>▲ Available in black only (no color designation so use .X – Specify: HGRMTUSB2.X).</p>	HGRMTUSB2	1.3 	0.02	\$ 198
 SIN 711-1	Articulating Desk Lamp Articulating Desk Lamp w/ Occupancy Sensor ▲ Silver finish only, no specification needed.	HLED1 HLED10C	1.2  1.2 	6.5 6.5	\$ 350 \$ 428
 SIN 711-1	Task Desk Lamp ▲ Brushed nickel finish only, no specification needed.	HLED2	0.7 	3.0	\$ 303

NOTE: See pages 230 through 246 for shared components.

How to specify

Select Model Number from above

H | F | L | D | G | R | M | T

   Icon Legend on page 10

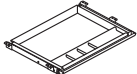

Description	Model	Ship Weight	Cube	List
 <p>Refer to page 751 for Center Drawer compatibility information SIN 711-1, 711-2, 711-11</p>	Angled Wood Center Drawer 26" x 15 3/8"	H1526	12.0	1.2 \$ 182
	22" x 15 3/8"	H1522	11.0	1.1 \$ 168

 <p>Open Market</p>	<p>Polymer Center Drawer</p> <ul style="list-style-type: none"> Color: Black. Material: ABS. Opening Requirements: 23"W x 16 1/4"D x 2"H. Retracts on 16" ball bearing slides. Can be used on worksurfaces with Coordinate™ and basyx by HON® Height Adjustable Bases as long as it is attached with spacer model HKBS. Can store up to 25 lbs. <p>⚠ Black finish only, no specification needed.</p>	HCD1	7.0	0.5	\$ 96
--	--	------	-----	-----	-------

Description	Model	Ship Weight	Cube	List by Paint Grade	
				Core	Metallics
 <p>Refer to pages 749-750 for additional product information SIN 711-1, 711-2, 711-11</p>	Articulating Arm with Keyboard Platform	H1706	16	1.4	\$ 440
	Articulating Arm with Convertible Keyboard Platform	H2107	16	1.3	\$ 472
	Sit to Stand Arm with Convertible Keyboard Platform	H2516	17	1.6	\$ 551
	Slide-Away Keyboard Platform (Specify: Laminate)	H4022	10	0.6	\$ 194
	Extended Tray Slide-Away Keyboard Platform (Specify: Laminate)	HE4022	12	0.7	\$ 278
	Metal Keyboard and Mouse Tray (Specify paint)	H4028	11	1.5	\$ 140
Metal Keyboard Tray (Specify paint)	H4029	11	1.5	\$ 125	\$ 135

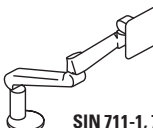
Description	Model	Ship Weight	Cube	List
 <p>SIN 711-1, 711-2</p>	Single Monitor Arm	H5210	11.0	1.3 \$ 497

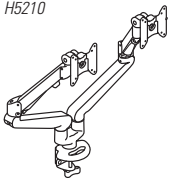
 <p>H5220</p>	<p>Dual Monitor Arm</p> <p>Single Mount with Dual Monitor effortless adjustment. Range of adjustment is 13" from 6 1/2"-19 1/2".</p> <p>NOTES: All Keyboards available in Silver only, no specification needed. For complete monitor arm features, see page 745.</p>	H5220	15.0	1.8	\$ 889
--	--	-------	------	-----	--------

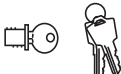
 <p>SIN 711-2, SIN 711-3</p>	Black Removable Lock Core Kit	HF23B	0.1	0.1	\$ 28
	Satin Removable Lock Core Kit	HF23S	0.1	0.1	\$ 34

• Specify quantity of each key number from 101E-225E.
 • Includes: 1-core, 2-keys, 1-core removal tool, and instructions.
 NOTES: Lock with a removable cylinder that can be interchanged as needed; allows users to access all furniture pieces in an office with a single key for convenience and security. Makes re-keying quick and easy. For use in all 10500 Series™ product lock cores, except the stack-on and wall mounted storage "K" models. For the latter use model HF27B or HF27S, listed below.

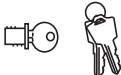
 <p>Open Market</p>	Removable Lock Core Kit				
	Black	HF27B	0.2	0.02	\$ 28
	Satin	HF27S	0.2	0.02	\$ 28

• For stack-on and wall mounted storage laminate models (with locks) in 10500, 10700, Valido, Park Avenue Laminate, Concinnity, and 94000 Series.
 • Specify quantity of each key number from 101E to 225E.
 • Includes: 1-core, 2-keys, 1-core removal tool, and instructions.
 NOTES: If key number isn't specified, number will be at random.

HOW TO ORDER CORE REMOVABLE LOCK KITS:

Specify: Model Number.X
Key Number

Examples: HF23S.X121E
HF23S.X (Key number not specified)



SAMPLE ORDER:

Quantity	Model	Key Code
4	HF23B.	X121E







NOTES: Key orders without numbers specified will be keyed at random.
Numbers 101E-225E are available.

NOTE: See pages 230 through 246 for shared components.

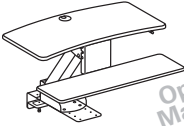
How to specify	1st Option
<p>Select Model Number from above</p> <p>H 1 5 2 6 .</p>	<p>Select Laminate</p> <p>See page 741</p> <p>N</p>

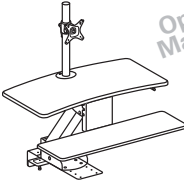
   Icon Legend on page 10

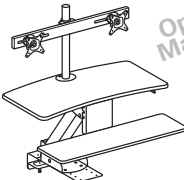
- ▶ These products are designed to allow the user to transition from seating position to standing position throughout the workday.
 - ▶ Gas-assist lever-operated mechanism with positive stop.
 - ▶ Clamp mount compatible with worksurfaces depths of 20"-30".
 - ▶ Clamp requires 3.5" of clearance along back edge of worksurface.
 - ▶ Black seamless worksurfaces.
 - ▶ Silver powder coated metal components.
 - ▶ Lowers below worksurface level on 24" and 30"D worksurfaces.
 - ▶ All models contain a large primary worksurface and a smaller keyboard / mouse surface.
 - ▶ Beveled edges for sleek appearance and comfort while typing.
 - ▶ Monitor arms include height, width, and swivel adjustment.
- ⚠ **Not recommended for use on mobile (castered) worksurfaces.**

	Description	Model	Ship Weight	Cube	List
	Directional™ Desktop Sit-to-Stand Device NOTES: Does not include a monitor arm and is suitable for laptops and/or monitors on their original stands.	HS1100	60 	3.2	\$ 525
	Directional™ Desktop Sit-to-Stand Device with Single Monitor Arm NOTES: Includes a monitor arm for a single monitor.	HS1101	62 	3.2	\$ 615
	Directional™ Desktop Sit-to-Stand Device with Dual Monitor Arm NOTES: Includes a monitor arm for dual monitors.	HS1102	63 	3.2	\$ 700

Mounting and Compatibility:

- This product is intended to be installed on commercial-grade worksurfaces in good condition.
- Compatible with freestanding worksurfaces 24"-30"D or panel-supported worksurfaces 24"-30"D.
- Not for use on mobile worksurfaces.

Clamp Mount

Use when 3.5" minimum overhang is available

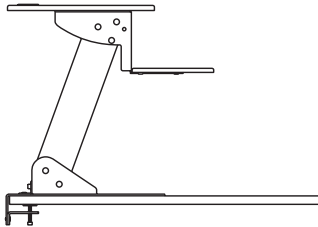

Screw Mount

Use when no overhang is available. Worksurface must be minimum 1" thick.

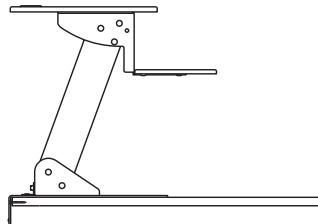

How to specify

Select Model Number from above

H | S | 1 | 1 | 0 | 0

  Icon Legend on page 10



Components used are listed on pages 250-269. Order components individually.
Other configurations are possible, including various sizes of some components.

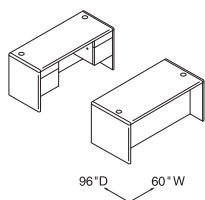

Qty.	Model #	Description	List Price	Price Extension
1	H10771	Double Pedestal Desk – 2/2 60"W x 30"D x 29½"H	\$1,199	\$1,199
1	H10765	Credenza with Kneespace – 2/0/2 60"W x 24"D x 29½"H	\$1,143	\$1,143
TOTAL:			\$2,342	

Desk Workstation 60"W x 96"D

Qty.	Model #	Description	List Price	Price Extension
1	H10771	Double Pedestal Desk – 2/2 60"W x 30"D x 29½"H	\$1,199	\$1,199
1	H10765	Credenza with Kneespace – 2/0/2 60"W x 24"D x 29½"H	\$1,143	\$1,143
TOTAL:			\$2,342	

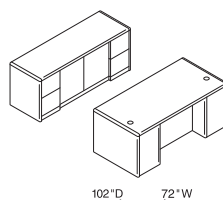

Qty.	Model #	Description	List Price	Price Extension
1	H10799	Double Pedestal Desk – 3/2 72"W x 36"D x 29½"H	\$1,827	\$1,827
1	H10742	Credenza with Storage 72"W x 24"D x 29½"H	\$1,827	\$1,827
TOTAL:			\$3,654	

Desk Workstation with Storage Credenza 72"W x 102"D

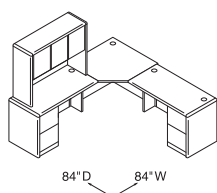

Qty.	Model #	Description	List Price	Price Extension
1	H107811	Corner Unit 24" x 36" x 36" x 24" x 29½"H	\$1,049	\$1,049
1	H10715R	Return, Right – b/f 48"W x 24"D x 29½"H	\$ 793	\$ 793
1	H10716L	Return, Left – b/f 48"W x 24"D x 29½"H	\$ 793	\$ 793
1	H107313	Stack-on Storage 44½"W x 14½"D x 37½"H	\$ 935	\$ 935
TOTAL:			\$3,570	

Corner "L" Workstation 84"W x 84"D

Qty.	Model #	Description	List Price	Price Extension
1	H107811	Corner Unit 24" x 36" x 36" x 24" x 29½"H	\$1,049	\$1,049
1	H10715R	Return, Right – b/f 48"W x 24"D x 29½"H	\$ 793	\$ 793
1	H10716L	Return, Left – b/f 48"W x 24"D x 29½"H	\$ 793	\$ 793
1	H107313	Stack-on Storage 44½"W x 14½"D x 37½"H	\$ 935	\$ 935
TOTAL:			\$3,570	

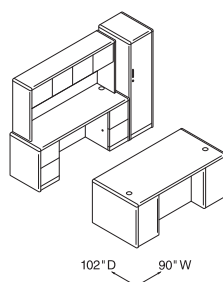

Qty.	Model #	Description	List Price	Price Extension
1	H10799	Double Pedestal Desk – 3/2 72"W x 36"D x 29½"H	\$1,827	\$1,827
1	H10741	Credenza with Kneespace – 2/0/2 72"W x 24"D x 29½"H	\$1,575	\$1,575
1	H10734	Stack-on Storage 68½"W x 14½"D x 37½"H	\$1,062	\$1,062
1	H107295R	Wardrobe/Storage Cabinet, Right 18"W x 24"D x 66½"H	\$1,614	\$1,614
TOTAL:			\$6,078	

Desk Workstation 90"W x 102"D

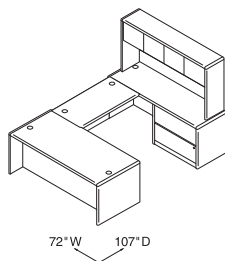

Qty.	Model #	Description	List Price	Price Extension
1	H10786L	Single Pedestal Desk, Left – b/f 72"W x 36"D x 29½"H	\$1,181	\$1,181
1	H10770	Bridge 47"W x 24"D x 29½"H	\$ 358	\$ 358
1	H10747R	Credenza with Lateral, Right 72"W x 24"D x 29½"H	\$1,426	\$1,426
1	H10734	Stack-on Storage 68½"W x 14½"D x 37½"H	\$1,062	\$1,062
TOTAL:			\$4,027	

Desk "U" Workstation – Right 72"W x 107"D

Qty.	Model #	Description	List Price	Price Extension
1	H10786L	Single Pedestal Desk, Left – b/f 72"W x 36"D x 29½"H	\$1,181	\$1,181
1	H10770	Bridge 47"W x 24"D x 29½"H	\$ 358	\$ 358
1	H10747R	Credenza with Lateral, Right 72"W x 24"D x 29½"H	\$1,426	\$1,426
1	H10734	Stack-on Storage 68½"W x 14½"D x 37½"H	\$1,062	\$1,062
TOTAL:			\$4,027	

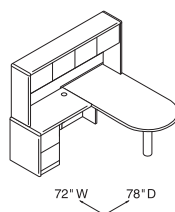

Qty.	Model #	Description	List Price	Price Extension
1	H10721	Peninsula 72"W x 36"D x 29½"H	\$1,166	\$1,166
1	H107192L	Return, Left – f/f 42"W x 24"D x 29½"H	\$ 957	\$ 957
1	H107318	Stack-on Storage 74½"W x 14½"D x 37½"H	\$1,166	\$1,166
TOTAL:			\$3,289	

Peninsula "L" Workstation – Left 72"W x 78"D

Components used are listed on pages 250-269. Order components individually.
Other configurations are possible, including various sizes of some components.

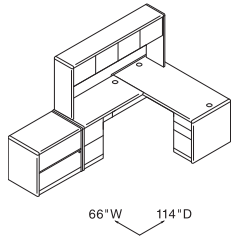

Desk "L" Workstation – Left
66"W x 114"D

Qty.	Model #	Description	List Price	Price Extension
1	H10701R	Single Pedestal Desk, Right – b/b/f 66"W x 30"D x 29½"H	\$1,448	\$1,448
1	H10712L	Return, Left – f/f 48"W x 24"D x 29½"H	\$ 969	\$ 969
1	H107318	Stack-on Storage 74⅝"W x 14⅝"D x 37⅞"H	\$1,166	\$1,166
1	H107690	2-Drawer Lateral File 36"W x 24"D x 29½"H	\$1,058	\$1,058
TOTAL:			\$4,641	

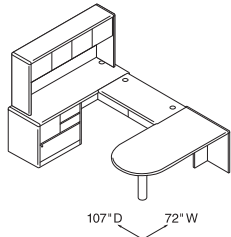

Peninsula "U" Workstation – Left
72"W x 107"D

Qty.	Model #	Description	List Price	Price Extension
1	H10721	Peninsula 72"W x 36"D x 29½"H	\$1,166	\$1,166
1	H10770	Bridge 47"W x 24"D x 29½"H	\$ 358	\$ 358
1	H107817	Credenza Shell with Full Modesty Panel 72"W x 24"D x 29½"H	\$ 792	\$ 792
1	H10505	Multi File Pedestal 36"W x 20"D x 28"H	\$1,155	\$1,155
1	H10734	Stack-on Storage 68⅝"W x 14⅝"D x 37⅞"H	\$1,062	\$1,062
TOTAL:			\$4,533	

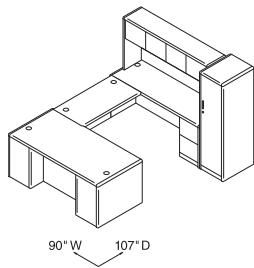

Desk "U" Workstation – Right
90"W x 107"D

Qty.	Model #	Description	List Price	Price Extension
1	H10788L	Single Pedestal Desk, Left – b/b/f 72"W x 36"D x 29½"H	\$1,575	\$1,575
1	H10770	Bridge 47"W x 24"D x 29½"H	\$ 358	\$ 358
1	H10707R	Single Pedestal Credenza, Right – f/f 72"W x 24"D x 29½"H	\$1,289	\$1,289
1	H10734	Stack-on Storage 68⅝"W x 14⅝"D x 37⅞"H	\$1,062	\$1,062
1	H107295R	Wardrobe/Storage Cabinet, Right 18"W x 24"D x 66⅝"H	\$1,614	\$1,614
TOTAL:			\$5,898	

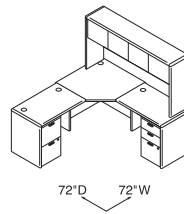

Corner 6' x 6' Workstation
72"W x 72"D

Qty.	Model #	Description	List Price	Price Extension
1	H107802L	Return Shell, Left 36"W x 24"D x 29½"H	\$ 532	\$ 532
1	H107811	Corner Unit 24" x 36" x 36" x 24" x 29½"H	\$1,049	\$1,049
1	H107801R	Return Shell, Right 36"W x 24"D x 29½"H	\$ 532	\$ 532
1	H10734	Stack-on Storage 68⅝"W x 14⅝"D x 37⅞"H	\$1,062	\$1,062
1	H105102	Mobile Pedestal – b/b/f 15¼"W x 22¾"D x 28"H	\$ 789	\$ 789
1	H105104	Mobile Pedestal – f/f 15¼"W x 22¾"D x 28"H	\$ 789	\$ 789
TOTAL:			\$4,753	

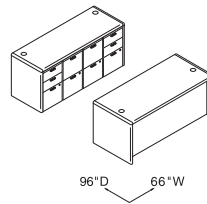

Modular Desk and Credenza
66"W x 96"D

Qty.	Model #	Description	List Price	Price Extension
1	H107826	Desk Shell 66"W x 30"D x 29½"H	\$849	\$ 849
1	H107816	Credenza Shell 66"W x 24"D x 29½"H	\$738	\$ 738
2	H105102	Mobile Pedestal – b/b/f 15¼"W x 22¾"D x 28"H	\$789	\$1,578
2	H105104	Mobile Pedestal – f/f 15¼"W x 22¾"D x 28"H	\$789	\$1,578
TOTAL:			\$4,743	

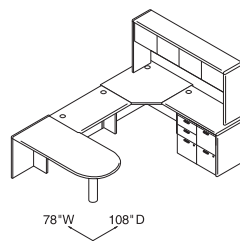

Peninsula "U" with Modular Components
78"W x 108"D

Qty.	Model #	Description	List Price	Price Extension
1	H10722	Peninsula 66"W x 30"D x 29½"H	\$1,019	\$1,019
1	H10760	Bridge 42"W x 24"D x 29½"H	\$ 343	\$ 343
1	H107811	Corner Unit 24" x 36" x 36" x 24" x 29½"H	\$1,049	\$1,049
1	H107803R	Return Shell, Right 42"W x 24"D x 29½"H	\$ 532	\$ 532
1	H105102	Mobile Pedestal – b/b/f 15¼"W x 22¾"D x 28"H	\$ 789	\$ 789
1	H105104	Mobile Pedestal – f/f 15¼"W x 22¾"D x 28"H	\$ 789	\$ 789
1	H107318	Stack-on Storage 74⅝"W x 14⅝"D x 37⅞"H	\$1,166	\$1,166
TOTAL:			\$5,687	



Double Radius Edge Detail

► Desk, credenza, and return shells, combined with a variety of under-the-worksurface storage solutions, maximize office layout flexibility. Products can be reconfigured quickly and easily when user preferences or space needs change.

► Worksurfaces and end panels feature contract-grade scratch, stain and spill resistant laminate over durable 1½" solid core high-performance particleboard; resists warping.
 ► Contoured hardwood trim; stained to match laminate.
 ► User friendly waterfall-shaped edges and round corners.

► 3" round cord management grommets, for routing and hiding wires and cables, are located in the tops of desk, credenza, and return shells. Grommets also serve as anchor points for stack-on storage and organizers.

► Grommet can be replaced with optional Power Hub for easy plug-and-play. See page 269.
 ► Shells utilize 10500 Series™ mobile pedestals or modular pedestals. See pages 225-226.



Description	Inside Dimensions	Full Width Overhang	Model	Ship Weight	Cube	List
<p>Desk Shell w/Full Modesty Panel</p> <p>72"W x 36"D x 29½"H 72"W x 30"D x 29½"H 66"W x 30"D x 29½"H 60"W x 30"D x 29½"H 48"W x 30"D x 29½"H</p>	69½"W x 24⅝"D	10½"	H107827 E◆A	213	7.0	\$ 959
	69½"W x 24⅝"D	4½"	H107829 E◆A	167	4.7	\$ 852
	63½"W x 24⅝"D	4½"	H107826 E◆A	175	5.5	\$ 849
	57½"W x 24⅝"D	4½"	H107825 E◆A	164	5.0	\$ 734
	45½"W x 24⅝"D	4½"	H107824 E◆A	143	5.0	\$ 713
	NOTES: Can be used freestanding or connected to a 42"W return shell to achieve a space efficient 6' x 6' L-shaped workstation layout. Accepts stack-on storage models H10734, H10734K or H10734G. See page 268 for optional center drawers.					

<p>Desk Shell w/10" Modesty Panel</p> <p>60"W x 30"D x 29½"H</p>	57½"W x 24⅝"D	4½"	H107825X E◆A	161	4.0	\$ 734
	NOTES: Makes reaching wall electrical outlets quick and easy. Provides more than 18" of clearance. Can be used freestanding or connected to a 30"W return shell to achieve a compact 5' x 5' L-shaped workstation layout. Accepts stack-on storage models H10732, H10732K. See page 268 for optional center drawers.					

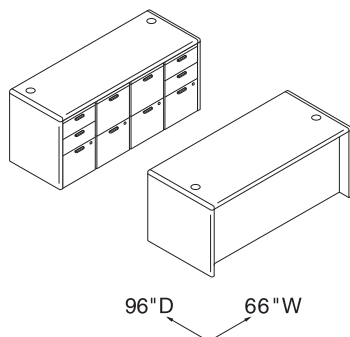

- 1 – H107826
- 1 – H107816
- 2 – H105102
- 2 – H105104

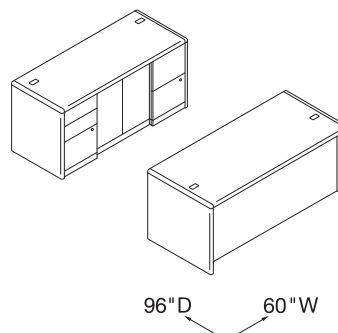

- 1 – H107825
- 1 – H107815
- 1 – H10508
- 1 – H10504
- 1 – H10502

▲ All 10700 Series™ grommets on desk, credenza, credenza shell, return, return shell, bridge and corner unit worksurfaces changed from rectangle-shaped to round, effective November, 2011.

NOTE: See pages 254 through 255 for modular storage components.

How to specify	Select Model Number from above H 1 0 7 8 2 7 .	1st Option Select Laminate See pages 48-49 N N
----------------	--	--





▶ Desk, credenza, and return shells, combined with a variety of under-the-worksurface storage solutions, maximize office layout flexibility. Products can be reconfigured quickly and easily when user preferences or space needs change.

▶ Worksurfaces and end panels feature contract-grade scratch, stain and spill resistant laminate over durable 1½" solid core high-performance particleboard; resists warping.
 ▶ Contoured hardwood trim; stained to match laminate.
 ▶ User friendly waterfall-shaped edges and rounded corners.

▶ Formal, full height or 10" modesty panels.
 ▶ Cord management grommets, for routing and hiding wires and cables, are located in the tops of desk, credenza, and return shells. Grommets also serve as anchor points for stack-on storage and organizers.

▶ Shells utilize 10500 Series™ mobile pedestals or modular pedestals. See pages 225-226.

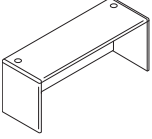

Description	Inside Dimensions	Model	Ship Weight	Cube	List
 <p>Credenza Shell w/Full Modesty Panel</p> <p>72"W x 24"D x 29½"H 66"W x 24"D x 29½"H 60"W x 24"D x 29½"H</p> <p>72"W x 20"D x 29½"H 66"W x 20"D x 29½"H 60"W x 20"D x 29½"H</p>	69½"W x 22¾"D	H107817 E◆A	156	6.0	\$ 792
	63½"W x 22¾"D	H107816 E◆A	145	5.5	\$ 738
	57½"W x 22¾"D	H107815 E◆A	133	5.0	\$ 697
	69½"W x 18¾"D	H107837 E◆A	140	5.3	\$ 775
	63½"W x 18¾"D	H107836 E◆A	132	4.8	\$ 722
	57½"W x 18¾"D	H107835 E◆A	127	3.8	\$ 685

NOTES: One cord pass-through grommet in top center of modesty panel to reach wall electrical outlets. See pages 261-262 for optional stack-on storage.

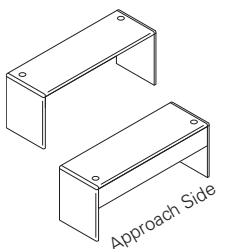

<p>Credenza Shell w/10"H Modesty Panel</p> <p>72"W x 24"D x 29½"H 66"W x 24"D x 29½"H 60"W x 24"D x 29½"H</p>	69½"W x 22¾"D	H107817X E◆A	127	6.0	\$ 792
	63½"W x 22¾"D	H107816X E◆A	121	5.5	\$ 738
	57½"W x 22¾"D	H107815X E◆A	115	5.0	\$ 697

NOTES: Makes reaching wall electrical outlets quick and easy. Provides more than 18" of clearance. See pages 261-262 for optional stack-on storage.

▲ **All 10700 Series™ grommets on desk, credenza, credenza shell, return, return shell, bridge and corner unit worksurfaces changed from rectangle-shaped to round, effective November, 2011.**



<p>Kneespace Clearance End Panel Kits (field installable)</p> <p>1⅞"W x 11¼"D x 28⅞"H</p> <p>For use at either end of 10700, 10500 or Valido Series™ 24"D Credenza Shells (with full or 10" modesty panel) or non-pedestal end of single pedestal credenzas or credenzas with lateral files.</p>		H105098 E◆A	13	0.9	\$ 193
<p>1⅞"W x 17¼"D x 28⅞"H</p> <p>For use at either end of 10700, 10500 or Valido Series™ 30"D Desk Shells or non-pedestal end of 30"D single pedestal desks.</p> <p>Kits include: (1) support panel; European fastening hardware; flat connector bracket; joint connector bolts with sleeve nuts (for ganging credenza to adjacent worksurface); and adjustable leveling glides. Allows conversion of units currently in the field.</p> <p>NOTES: Can be used to connect up to three 24"D credenzas or 30"D desks in line (requires 4 kits).</p> <p>▲ Not designed to be used freestanding. Not designed to be used with returns, 36"D desks or desk shells.</p> <p>SPECIFYING EXAMPLE: H105098.N</p>		H105099 E◆A	11	0.8	\$ 202

NOTE: See pages 254 through 255 for modular storage components.

How to specify	1st Option
<p>Select Model Number from above</p> <p>H 1 0 7 8 1 7 .</p>	<p>Select Laminate</p> <p>See pages 48-49</p> <p>N N </p>

10700 Series™ Laminate Modular Components

GSA SIN 711-8



Double Radius Edge Detail



- ▶ Worksurfaces and end panels feature contract-grade scratch, stain and spill resistant laminate over durable 1 1/8" solid core high-performance particleboard; resists warping.
- ▶ Contoured hardwood trim; stained to match laminate.
- ▶ User friendly waterfall-shaped edges and rounded corners.
- ▶ Formal, full height or 10" modesty panels.
- ▶ Cord management grommets, for routing and hiding wires and cables, are located in the tops of desk, credenza, and return shells. Grommets also serve as anchor points for stack-on storage and organizers.
- ▶ For work-in-process paper management tools, see page 268.
- ▶ For conference table options, see the Preside® table tops and bases on pages 698-703.
- ▶ Shells utilize 10500 Series™ mobile pedestals or modular pedestals. See pages 225-226.



Description	Inside Dimensions	Model	Ship Weight	Cube	List
Right Return Shell w/Full Modesty Panel					
72"W x 24"D x 29 1/2"H, Right (w/support; 2 grommets)	62"W x 22 13/16"D	H107727R E◆A	145	5.6	\$ 792
60"W x 24"D x 29 1/2"H, Right (w/support; 2 grommets)	50"W x 22 13/16"D	H107807R E◆A	129	4.7	\$ 697
48"W x 24"D x 29 1/2"H, Right (2 grommets)	47"W x 22 3/4"D	H107805R E◆A	100	4.0	\$ 558
42"W x 24"D x 29 1/2"H, Right (2 grommets)	41"W x 22 3/4"D	H107803R E◆A	95	3.5	\$ 532
36"W x 24"D x 29 1/2"H, Right (2 grommets)	34 3/4"W x 22 13/16"D	H107801R E◆A	83	3.4	\$ 532
30"W x 24"D x 29 1/2"H (1 grommet)	28 3/4"W x 22 3/4"D	H107725R E◆A	69	2.4	\$ 517
Left Return Shell w/Full Modesty Panel					
72"W x 24"D x 29 1/2"H, Left (w/support; 2 grommets)	62"W x 22 13/16"D	H107728L E◆A	145	5.6	\$ 792
60"W x 24"D x 29 1/2"H, Left (w/support; 2 grommets)	50"W x 22 13/16"D	H107808L E◆A	129	4.7	\$ 697
48"W x 24"D x 29 1/2"H, Left (2 grommets)	47"W x 22 3/4"D	H107806L E◆A	100	4.0	\$ 558
42"W x 24"D x 29 1/2"H, Left (2 grommets)	41"W x 22 3/4"D	H107804L E◆A	95	3.5	\$ 532
36"W x 24"D x 29 1/2"H, Left (2 grommets)	34 3/4"W x 22 13/16"D	H107802L E◆A	83	3.4	\$ 532
30"W x 24"D x 29 1/2"H (1 grommet)	28 3/4"W x 22 3/4"D	H107726L E◆A	69	2.4	\$ 517

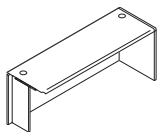

Model H107727R shown

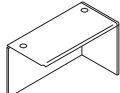

Model H107805R shown

NOTES: One cord pass-through grommet in top center of modesty panel to reach wall electrical outlets. Wood-grain direction on modesty/back panel runs vertical on 30"W-60"W sizes and horizontal on 72"W unit. Stack-on model H10734 is sized to be used on the 72"W return shell. Stack-on model H10732 will work on the 60"W return shell. Stack-on storage model H107313 fits on the 48"W return shell. Stack-on storage model H10734 will work on a 36"W return shell attached to the 36" corner unit; attaches to the return shell through the grommet hole and to the corner unit via double-sided tape. 36"W return shell can be used to achieve a 6' x 6' footprint when connected to either a 72"W x 36"D single pedestal desk, desk shell or peninsula, or when two are connected to a 36" corner unit model H107811.

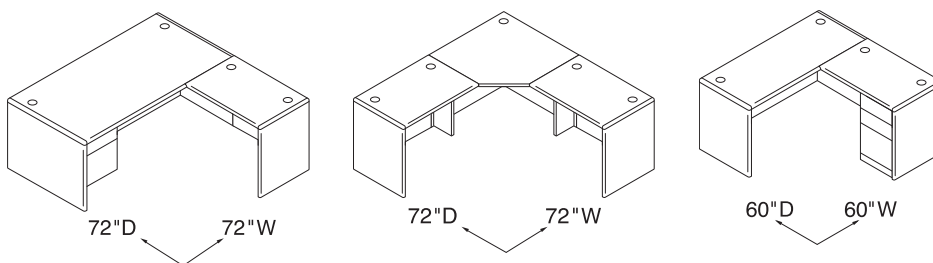

▲ All 10700 Series™ grommets on desk, credenza, credenza shell, return, return shell, bridge and corner unit worksurfaces changed from rectangle-shaped to round, effective November, 2011.

NOTE: See pages 254 through 255 for modular storage components.

How to specify	<p>Select Model Number from above</p> <p>H 1 0 7 7 2 7 R .</p>	<p>1st Option</p> <p>Select Laminate</p> <p>See pages 48-49</p> <p>N N</p>
----------------	---	---





- ▶ Worksurfaces and end panels feature contract-grade scratch, stain and spill resistant laminate over durable 1 1/8" solid core high-performance particleboard; resists warping.
- ▶ Contoured hardwood trim; stained to match laminate.
- ▶ User friendly waterfall-shaped edges and rounded corners.
- ▶ Formal, full height or 10" modesty panels.
- ▶ 3" round cord management grommets, for routing and hiding wires and cables, are located in the tops of desk, credenza, and return shells. Grommets also serve as anchor points for stack-on storage and organizers.
- ▶ Grommet can be replaced with optional Power Hub for easy plug-and-play. See page 269.
- ▶ For conference table options, see the Preside® table tops and bases on pages 698-703.
- ▶ Shells utilize 10500 Series™ mobile pedestals or modular pedestals. See pages 225-226.



Description	Inside Dimensions	Model	Ship Weight	Cube	List
Right Return Shell w/10"H Modesty Panel					
72"W x 24"D x 29 1/2"H, Right (w/support; 2 grommets)	62"W x 22 13/16"D	H107727RX E♣A	113	5.6	\$ 792
60"W x 24"D x 29 1/2"H, Right (w/support; 2 grommets)	50"W x 22 13/16"D	H107807RX E♣A	105	4.7	\$ 697
48"W x 24"D x 29 1/2"H, Right (2 grommets)	47"W x 22 3/4"D	H107805RX E♣A	81	4.0	\$ 558
42"W x 24"D x 29 1/2"H, Right (2 grommets)	41"W x 22 3/4"D	H107803RX E♣A	78	3.5	\$ 532
36"W x 24"D x 29 1/2"H, Right (2 grommets)	34 3/4"W x 22 13/16"D	H107801RX E♣A	69	3.4	\$ 532
Left Return Shell w/10"H Modesty Panel					
72"W x 24"D x 29 1/2"H, Left (w/support; 2 grommets)	62"W x 22 13/16"D	H107728LX E♣A	113	5.6	\$ 792
60"W x 24"D x 29 1/2"H, Left (w/support; 2 grommets)	50"W x 22 13/16"D	H107808LX E♣A	105	4.7	\$ 697
48"W x 24"D x 29 1/2"H, Left (2 grommets)	47"W x 22 3/4"D	H107806LX E♣A	81	4.0	\$ 558
42"W x 24"D x 29 1/2"H, Left (2 grommets)	41"W x 22 3/4"D	H107804LX E♣A	78	3.5	\$ 532
36"W x 24"D x 29 1/2"H, Left (2 grommets)	34 3/4"W x 22 13/16"D	H107802LX E♣A	69	3.4	\$ 532

NOTES: Makes reaching wall electrical outlets quick and easy. Provides more than 18" of clearance.

Non-Handed Return Shell w/10"H Modesty Panel	30"W x 20"D x 29 1/2"H	28 3/4"W x 18 3/4"D	H107270X E♣A	47	2.4	\$ 493
---	------------------------	---------------------	---------------------	----	-----	--------

NOTES: Makes reaching wall electrical outlets quick and easy; provides more than 18" of clearance. Ideal for smaller spaces. Connects to single pedestal desks and credenzas, peninsulas, or desk or credenza shells. Designed to fit over 10500 Series™ mobile pedestal models H105106 (box/file) or H105109 (shelf/box/file) and modular pedestal models H105012 (box/box/file) or H105014 (file/file).

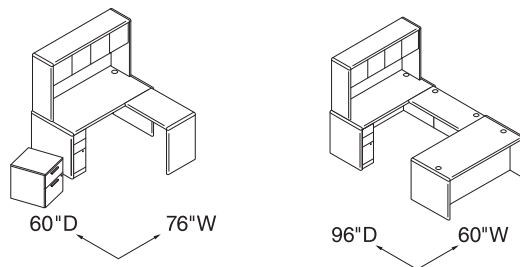

- | | |
|-------------------------|----------|
| H107825X | H107825 |
| H105093 | H107398 |
| H10732 (for desk shell) | H107815X |
| H107270X | H105093 |
| H105106 | H10732 |



⚠ All 10700 Series™ grommets on desk, credenza, credenza shell, return, return shell, bridge and corner unit worksurfaces changed from rectangle-shaped to round, effective November, 2011.

NOTE: See pages 254 through 255 for modular storage components.

How to specify	1st Option
Select Model Number from above	Select Laminate See pages 48-49
H 1 0 7 7 2 7 R X .	N N

- ▶ Pedestals can be reconfigured quickly and easily when user preferences or space needs change.
- ▶ Pedestal models ship assembled unless designated **E♠A**.
- ▶ Locking units equipped with interchangeable core removable locks.
- ⚠ **Keyed alike cores must be ordered separately — see page 743.**
- ⚠ **Pedestals are not designed to be used freestanding. Unfinished top and back.**
- ⚠ **Access strip (filler) required when full height pedestals are configured side-by-side to allow access for opening the drawers.**
- ⚠ **Access strip is required when CPU storage pedestal is used next to B/F, B/B/F, or F/F pedestals (finger pull is on side of door front).**

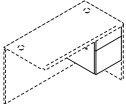
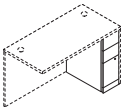
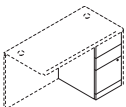
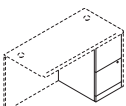

	Description	Model	Ship Weight	Cube	List
	Box/File Pedestal (with core removable lock) 15 ⁵ / ₈ "W x 22 ³ / ₄ "D x 17 ³ / ₄ "H — for use under 24"D, 30"D and 36"D desk, credenza and return shells NOTES: Hangrails included. Lock can be positioned on either the right or left side. Attaches to underside of worksurface top. Not for use under 20"D shells. ⚠ Not designed to be used freestanding. Unfinished top and back.	H10501	57	5.5	\$ 483
	Narrow Box/Box/File Pedestal (with core removable lock) — floorstanding 9 ¹ / ₂ "W x 22 ³ / ₄ "D x 28"H — for use under 24"D, 30"D and 36"D desk, credenza and return shells NOTES: Compact design is ideal for use in U and L-shaped layouts for smaller spaces such as 5' x 8' U-workstation or a 5' x 5' L-workstation. Middle box drawer and file drawer lock; top box drawer does not lock. File drawer includes integrated hangrails for side-to-side letter or legal filing. Not for use with 20"D shells. ⚠ Not designed to be used freestanding; unfinished top and back.	H105093	61	5.6	\$ 624
	Box/Box/File Pedestal (with core removable lock) — floorstanding 15 ⁵ / ₈ "W x 22 ³ / ₄ "D x 28"H — for use under 24"D, 30"D and 36"D desk, credenza and return shells NOTES: Top box drawer does not lock. Hangrails included. Not for use under 20"D shells. ⚠ Not designed to be used freestanding. Unfinished top and back.	H10502	90	8.4	\$ 634
	File/File Pedestal (with core removable lock) — floorstanding 15 ⁵ / ₈ "W x 22 ³ / ₄ "D x 28"H — for use under 24"D, 30"D and 36"D desk, credenza and return shells NOTES: Hangrails included. Not for use under 20"D shells. ⚠ Not designed to be used freestanding. Unfinished top and back.	H10504	85	8.2	\$ 634
	Access Strip (Filler) 1 ¹ / ₈ "W x 20 ¹ / ₂ "D x 28"H NOTES: For use with B/B/F, F/F, and or P/M/F pedestals configured side-by-side or when CPU storage is used next to B/F, B/B/F, or F/F pedestals. Not required when pedestals are used in conjunction with lateral file pedestal, multi file pedestal or cabinet pedestal. Not for use under 20"D shells.	H10524	21	0.9	\$ 161

⚠ **All 10700 Series™ grommets on desk, credenza, credenza shell, return, return shell, bridge and corner unit worksurfaces changed from rectangle-shaped to round, effective November, 2011.**

NOTE: See pages 250 through 253 for modular desk, credenza and return shells.

How to specify	<p>Select Model Number from above</p> <p>H 1 0 5 0 1 .</p>	<p>1st Option</p> <p>Select Laminate</p> <p>See pages 48-49</p> <p>N</p>
----------------	--	---



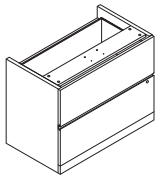

- ▶ Pedestals can be reconfigured quickly and easily when user preferences or space needs change.
- ▶ Locking units equipped with interchangeable core removable locks.
- ⚠ **Keyed alike cores must be ordered separately — see HF23B on page 743.**
- ⚠ **Pedestals are not designed to be used freestanding. Unfinished top and back.**
- ⚠ **Access strip (filler) required when full height pedestals are configured side-by-side to allow access for opening the drawers.**
- ⚠ **Access strip is required when CPU storage pedestal is used next to B/F, B/B/F, or F/F pedestals (finger pull is on side of door front). See page 254.**

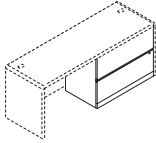
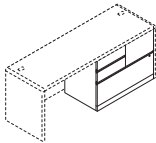
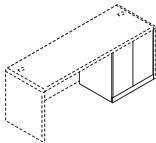
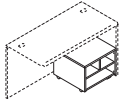

	Description	Model	Ship Weight	Cube	List
	Lateral File Pedestal (with core removable lock) – floorstanding 36"W x 20"D x 28"H — for use under 24"D, 30"D and 36"D desk, credenza and return shells NOTES: Designed for use with credenza or return shells. Hangrails included. Mechanical interlock inhibits extension of more than one drawer at a time. Not for use under 20"D shells. ⚠ Not designed to be used freestanding. Unfinished top and back.	H10503	127	15.6	\$ 964
	Multi File Pedestal (with core removable lock) – floorstanding 36"W x 20"D x 28"H — for use under 24"D, 30"D and 36"D desk, credenza and return shells NOTES: Designed for use with credenza or return shells. Versatile four drawer unit features one lateral file drawer, one vertical file drawer, and two box drawers. Box drawers do not lock. Hangrails included. Mechanical interlock in lateral drawer inhibits extension of more than one drawer at a time. Not for use under 20"D shells. ⚠ Not designed to be used freestanding. Unfinished top and back.	H10505	155	15.6	\$1155
	Cabinet Pedestal – floorstanding 26"W x 21 1/4"D x 28"H — for use under 24"D, 30"D and 36"D desk, credenza and return shells NOTES: One adjustable shelf at 2 1/2" increments. For use with credenza or return shells. Doors are non-locking. Not for use under 20"D shells. ⚠ Not designed to be used freestanding. Unfinished top and back.	H10508	78	12.2	\$ 718
	Mobile Printer/Fax Cart 20"W x 19 1/8"D x 14 1/8"H NOTES: Holds laser printers, inkjet printers or fax machines. Ideal for limited space. Low profile cart stores conveniently and easily under desks and workstations. Interior compartment shelving is Black. Four casters. Not for use under 20"D shells. Flat edge profile on top. SPECIFYING EXAMPLE: H105679.NN	H105679 E♦A	52	2.9	\$ 397

⚠ **All 10700 Series™ grommets on desk, credenza, credenza shell, return, return shell, bridge and corner unit worksurfaces changed from rectangle-shaped to round, effective November, 2011.**

NOTE: See pages 250 through 253 for modular desk, credenza and return shells.

How to specify	Select Model Number from above	1st Option
	H 1 0 5 0 3 .	Select Laminate See pages 48-49 N



10700 Series™ Laminate Wood Desks — Full Pedestals

GSA SIN 711-8



- ▶ Worksurfaces and end panels feature contract-grade scratch, stain and spill resistant high-pressure laminate over durable 1 1/8" solid core high-performance particleboard.
- ▶ Contoured hardwood trim; stained to match laminate.
- ▶ User friendly waterfall-shaped edges.
- ▶ Full-to-floor pedestals maximize storage space.
- ▶ Breakfront modesty panel design on full height pedestal desks. See approach side illustration at left.
- ▶ 3" cord grommet can be replaced with optional Power Hub for easy plug-and-play. See page 269.
- ▶ All drawers are 5-sided construction, which allows easy drawer alignment or replacement of drawer fronts.
- ▶ File drawer design includes integrated hangrails for side-to-side letter or legal filing; and front-to-back for letter filing.
- ▶ Adjustable hex leveling glides allow floor-standing furniture to be easily leveled without lifting the unit; glides have 3/4" adjustable range.
- ▶ Desk, credenza, and return models ship assembled; ready to set in place.

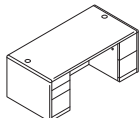

Description	Recessed Modesty Panel	Model	Ship Weight	Cube	List
 <p>Double Pedestal Desk w/Wood-Grain Breakfront Modesty Panel — 3/2 72"W x 36"D x 29 1/2"H 66"W x 30"D x 29 1/2"H 60"W x 30"D x 29 1/2"H</p>	10 1/2"	H10799	371	52.9	\$1827
	4 1/2"	H10774	313	40.9	\$1761
	4 1/2"	H10773	305	37.3	\$1676
NOTES: All drawers lock. Two worksurface grommets to route/hide cords. See page 268 for optional center drawers.					

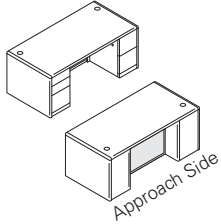
 <p>Double Pedestal Desk w/Frosted Breakfront Modesty Panel — 3/2 72"W x 36"D x 29 1/2"H</p>	10 1/2"	H10799G	366	51.8	\$2277
	NOTES: All drawers lock. Two worksurface grommets to route/hide cords. See page 268 for optional center drawers.				

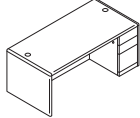
 <p>Single Pedestal Desk w/Wood-Grain Breakfront Modesty Panel — Box/box/file 72"W x 36"D x 29 1/2"H, Right 66"W x 30"D x 29 1/2"H, Right 72"W x 36"D x 29 1/2"H, Left 66"W x 30"D x 29 1/2"H, Left</p>	10 1/2"	H10787R	317	52.9	\$1575
	4 1/2"	H10701R	270	40.9	\$1448
	10 1/2"	H10788L	317	52.9	\$1575
	4 1/2"	H10702L	270	40.9	\$1448
NOTES: Drawers lock. Two worksurface grommets to route/hide cords. See page 268 for optional center drawers.					

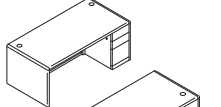
 <p>Single Pedestal Desk w/Frosted Breakfront Modesty Panel — Box/box/file 72"W x 36"D x 29 1/2"H, Right 72"W x 36"D x 29 1/2"H, Left</p>	10 1/2"	H10787RG	313	51.8	\$2025
	10 1/2"	H10788LG	313	51.8	\$2025
NOTES: Drawers lock. Two worksurface grommets to route/hide cords. See page 268 for optional center drawers.					

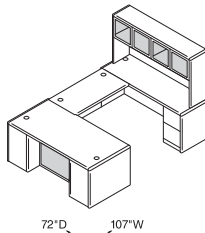

H10788L
 H10770
 H10707R
 H10734G

⚠ **All 10700 Series™ grommets on desk, credenza, credenza shell, return, return shell, bridge and corner unit worksurfaces changed from rectangle-shaped to round, effective November, 2011.**

NOTE: See pages 260 through 269 for shared components.

How to specify	1st Option
<p>Select Model Number from above</p> <p>H 1 0 7 9 9 .</p>	<p>Select Laminate</p> <p>See pages 48-49</p> <p>N N </p>



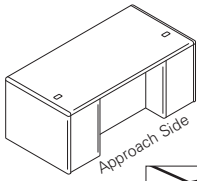

Approach Side

Double Radius Edge Detail



- ▶ Worksurfaces and end panels feature contract-grade scratch, stain and spill resistant high-pressure laminate over durable 1 1/8" solid core high-performance particleboard.
- ▶ Contoured hardwood trim; stained to match laminate.
- ▶ User friendly waterfall-shaped edges.
- ▶ Full-to-floor pedestals maximize storage space.
- ▶ Breakfront modesty panel design on full height pedestal desks. See approach side illustration at left.
- ▶ Cord management grommets serve as anchor points for stack-on storage and organizers.
- ▶ All drawers are 5-sided construction, which allows easy drawer alignment or replacement of drawer fronts.
- ▶ File drawer design includes integrated hangrails for side-to-side letter or legal filing; and front-to-back for letter filing.
- ▶ Adjustable hex leveling glides allow floor-standing furniture to be easily leveled without lifting the unit; glides have 3/4" adjustable range.
- ▶ Desk, credenza, and return models ship assembled; ready to set in place.
- ▶ For work-in-process paper management tools, see page 268.



	Description	Recessed Modesty Panel	Model	Ship Weight	Cube	List
	Return — Right file/file (2 grommets)					
	60"W x 24"D x 29 1/2"H		H10709R	176	29.7	\$1119
	48"W x 24"D x 29 1/2"H		H10711R	158	24.9	\$ 969
	42"W x 24"D x 29 1/2"H		H107191R	150	22.1	\$ 957
	NOTES: Drawers lock. Two worksurface grommets to route/hide cords and one cord pass-through grommet in top center of modesty panel. See page 262 for optional stack-on storage.					
	⚠ Not designed to be used freestanding.					
	Return — Left file/file (2 grommets)					
	60"W x 24"D x 29 1/2"H		H10710L	176	29.7	\$1119
	48"W x 24"D x 29 1/2"H		H10712L	158	24.9	\$ 969
	42"W x 24"D x 29 1/2"H		H107192L	150	22.1	\$ 957
	NOTES: Drawers lock. Two worksurface grommets to route/hide cords and one cord pass-through grommet in top center of modesty panel. See page 262 for optional stack-on storage.					
	⚠ Not designed to be used freestanding.					
	Credenza with Doors 72"W x 24"D x 29 1/2"H	3 1/2"	H10742	314	36.0	\$1827
	NOTES: All drawers lock. Doors are non-locking. Two worksurface grommets to route/hide cords and one pass-through grommet in top center of modesty panel. Includes a fixed shelf located at the bottom of the center storage area. No intermittent shelf. See page 262 for optional stack-on storage.					
	Credenza with Kneespace — 2/0/2					
	72"W x 24"D x 29 1/2"H	3 1/2"	H10741	280	36.0	\$1575
	66"W x 24"D x 29 1/2"H	3 1/2"	H10768	270	33.4	\$1482
	60"W x 24"D x 29 1/2"H	3 1/2"	H10767	241	28.8	\$1440
	NOTES: All drawers lock. Two worksurface grommets to route/hide cords and one pass-through grommet in top center of modesty panel. See page 262 for optional stack-on storage.					
	⚠ Not designed to be used with 24"D modular or mobile pedestals.					
	Single Pedestal Credenza, File/File					
	72"W x 24"D x 29 1/2"H, Right	3 1/2"	H10707R	235	36.3	\$1289
	66"W x 24"D x 29 1/2"H, Right	3 1/2"	H10705R	225	33.4	\$1267
	72"W x 24"D x 29 1/2"H, Left	3 1/2"	H10708L	235	36.3	\$1289
	66"W x 24"D x 29 1/2"H, Left	3 1/2"	H10706L	225	33.4	\$1267
	NOTES: Drawers lock. Two worksurface grommets to route/hide cords and one cord pass-through grommet in top center of modesty panel. See page 262 for optional stack-on storage.					
	⚠ Not designed to be used with 24"D modular or mobile pedestals.					

⚠ All 10700 Series™ grommets on desk, credenza, credenza shell, return, return shell, bridge and corner unit worksurfaces changed from rectangle-shaped to round, effective November, 2011.

NOTE: See pages 260 through 269 for shared components.

How to specify	<p>Select Model Number from above</p> <p>H 1 0 7 0 9 R .</p>	<p>1st Option</p> <p>Select Laminate</p> <p>See pages 48-49</p> <p>N N </p>
----------------	---	---

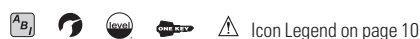

10700 Series™ Laminate Wood Desks — 3/4 Pedestals

GSA SIN 711-8

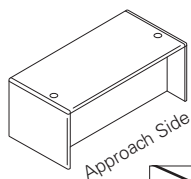

Double Radius Edge Detail

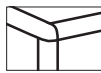

- ▶ Worksurfaces and end panels feature contract-grade scratch, stain and spill resistant high-pressure laminate over durable 1 1/8" solid core high-performance particleboard.
- ▶ Contoured hardwood trim; stained to match laminate.
- ▶ User friendly waterfall-shaped edges and rounded corners.
- ▶ 3/4 pedestal design increases budget flexibility.
- ▶ Formal, full height modesty panels.
- ▶ Drawers operate on full extension, ball-bearing suspensions to ensure smooth, quiet, long-lasting operation.
- ▶ All drawers are 5-sided construction, which allows easy drawer alignment or replacement of drawer fronts.
- ▶ File drawer design includes integrated hangrails for side-to-side letter or legal filing; and front-to-back for letter filing.
- ▶ 3" cord grommet can be replaced with optional Power Hub for easy plug-and-play. See page 269.
- ▶ Adjustable hex leveling glides allow floor-standing furniture to be easily leveled without lifting the unit; glides have 3/4" adjustable range.
- ▶ Desk, credenza, and return models ship assembled; ready to set in place.
- ▶ Center drawers conveniently store writing instruments, paper and other miscellaneous items. Includes pencil tray. See page 268.



	Description	Full Width Overhang	Model	Ship Weight	Cube	List
	Double Pedestal Desk, 2-2					
	72"W x 36"D x 29 1/2"H	10 1/2"	H10791	340	52.9	\$1425
	66"W x 30"D x 29 1/2"H	4 1/2"	H10775	290	40.9	\$1361
	60"W x 30"D x 29 1/2"H	4 1/2"	H10771	266	37.4	\$1199
NOTES: All drawers lock. Two worksurface grommets to route/hide cords. See page 268 for optional center drawers.						
	Single Pedestal Desk, Right box/file					
	72"W x 36"D x 29 1/2"H	10 1/2"	H10785R	279	52.9	\$1181
	66"W x 30"D x 29 1/2"H	4 1/2"	H10783R	239	41.0	\$1076
NOTES: Drawers lock. Two worksurface grommets to route/hide cords. See page 268 for optional center drawers.						
	Small Office Desk, 3/4 Pedestal, Right box/file					
	48"W x 30"D x 29 1/2"H		H107885R	191	30.2	\$ 987
NOTES: Footprint is ideal for limited space. Drawers lock. Two cord management grommets in the top. 3/4 height modesty panel facilitates reaching wall electrical outlets. Optional stack-on storage model H107313 maximizes storage space. See page 268 for optional center drawers.						
	Single Pedestal Desk, Left box/file					
	72"W x 36"D x 29 1/2"H	10 1/2"	H10786L	279	52.9	\$1181
	66"W x 30"D x 29 1/2"H	4 1/2"	H10784L	239	41.0	\$1076
NOTES: Drawers lock. Two worksurface grommets to route/hide cords. See page 268 for optional center drawers.						
⚠ All 10700 Series™ grommets on desk, credenza, credenza shell, return, return shell, bridge and corner unit worksurfaces changed from rectangle-shaped to round, effective November, 2011.						
	Above Privacy Screen					
	30"W x 13"H		HLSL1230	13	1.5	\$ 241
	36"W x 13"H		HLSL1236	15	1.8	\$ 266
	42"W x 13"H		HLSL1242	18	2.3	\$ 298
	48"W x 13"H		HLSL1248	20	2.3	\$ 340
	54"W x 13"H		HLSL1254	22	2.9	\$ 364
60"W x 13"H		HLSL1260	24	2.9	\$ 392	
NOTES: Ships complete with attachment bracket. Bracket is Platinum only, no need to specify. Attaches to top of rectangle worksurfaces; requires a minimum overhang of 1 1/2".						
⚠ Available in Frosted Glass ONLY HLSL1230.G.						

NOTE: See pages 260 through 269 for shared components.

How to specify	<p>Select Model Number from above</p> <p>H 1 0 7 9 1 .</p>	<p>1st Option</p> <p>Select Laminate</p> <p>See pages 48-49</p> <p>N N</p>
----------------	--	---



Double Radius Edge Detail

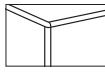

- ▶ Worksurfaces and end panels feature contract-grade scratch, stain and spill resistant high-pressure laminate over durable 1 1/8" solid core high-performance particleboard.
- ▶ Contoured hardwood trim; stained to match laminate.
- ▶ User friendly waterfall-shaped edges and rounded corners.
- ▶ 3/4 pedestal design increases budget flexibility.
- ▶ Formal, full height modesty panels.
- ▶ Cord management grommets also serve as anchor points for stack-on storage and organizers.
- ▶ All drawers are 5-sided construction, which allows easy drawer alignment or replacement of drawer fronts.
- ▶ File drawer design includes integrated hangrails for side-to-side letter or legal filing; and front-to-back for letter filing.
- ▶ Adjustable hex leveling glides allow floor-standing furniture to be easily leveled without lifting the unit; glides have 3/4" adjustable range.
- ▶ Desk, credenza, and return models ship assembled; ready to set in place.
- ▶ For work-in-process paper management tools, see page 268.

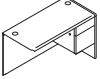
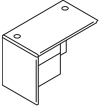
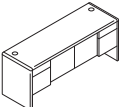
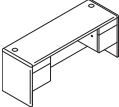
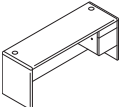

	Description	Full Width Overhang	Model	Ship Weight	Cube	List
 Model H10717R shown	Return — Right box/file (2 grommets)					
	60"W x 24"D x 29 1/2"H		H10717R	173	29.7	\$ 898
	48"W x 24"D x 29 1/2"H		H10715R	147	25.3	\$ 793
	42"W x 24"D x 29 1/2"H		H107193R	136	22.1	\$ 773
	NOTES: Drawers lock. Two worksurface grommets and one cord pass-through grommet in top center of modesty panel. See page 262 for optional stack-on storage. ⚠ Not designed to be used freestanding.					
 Model H10716L shown	Return — Left box/file (2 grommets)					
	60"W x 24"D x 29 1/2"H		H10718L	173	29.7	\$ 898
	48"W x 24"D x 29 1/2"H		H10716L	147	25.3	\$ 793
	42"W x 24"D x 29 1/2"H		H107194L	136	22.1	\$ 773
	NOTES: Drawers lock. Two worksurface grommets and one cord pass-through grommet in top center of modesty panel to reach wall electrical outlets. See page 262 for optional stack-on storage. ⚠ Not designed to be used freestanding.					
	Credenza with Doors	3 1/2"	H10744	278	36.0	\$1437
	72"W x 24"D x 29 1/2"H					
	NOTES: All drawers lock. Hinged doors are non-locking. Two worksurface grommets and one cord pass-through grommet in top center of modesty panel to reach wall electrical outlets. Includes a fixed shelf located at the bottom of the center storage area. No intermittent shelf. See page 262 for optional stack-on storage.					
	Credenza with Kneespace					
	72"W x 24"D x 29 1/2"H	3 1/2"	H10743	243	36.3	\$1281
	66"W x 24"D x 29 1/2"H	3 1/2"	H10766	234	33.4	\$1197
	60"W x 24"D x 29 1/2"H	3 1/2"	H10765	229	28.8	\$1143
	NOTES: Drawers lock. Two worksurface grommets and one cord pass-through grommet in top center of modesty panel to reach wall electrical outlets. See page 262 for optional stack-on storage. ⚠ Not designed to be used with 24"D modular or mobile pedestals.					
	Single Pedestal Credenza, Box/File					
	72"W x 24"D x 29 1/2"H, Right	3 1/2"	H10745R	212	36.0	\$1035
	66"W x 24"D x 29 1/2"H, Right	3 1/2"	H10763R	203	33.4	\$1019
	72"W x 24"D x 29 1/2"H, Left	3 1/2"	H10746L	212	36.0	\$1035
	66"W x 24"D x 29 1/2"H, Left	3 1/2"	H10764L	203	33.4	\$1019
	NOTES: Drawers lock. Two worksurface grommets and one cord pass-through grommet in top center of modesty panel to reach wall electrical outlets. See page 262 for optional stack-on storage. ⚠ Not designed to be used with 24"D modular or mobile pedestals.					

⚠ **All 10700 Series™ grommets on desk, credenza, credenza shell, return, return shell, bridge and corner unit worksurfaces changed from rectangle-shaped to round, effective November, 2011.**

NOTE: See pages 260 through 269 for shared components.

How to specify	Select Model Number from above	1st Option
	H 1 0 7 4 5 R .	Select Laminate See pages 48-49 N N

10700 Series™ Shared Components and Accessories

GSA SIN 711-8



- ▶ Shared components on this page can be used with modular, full pedestal, and 3/4 pedestal models shown on pages 250-259.
- ▶ Multi file is a versatile four drawer unit featuring two box drawers, one file drawer, and one lateral file drawer with mechanical interlock.
- ▶ Cord management grommets, for routing and hiding wires and cables, are located in the tops of desks, credenzas, and returns. Grommets also serve as anchor points for stack-on storage and organizers.
- ▶ Cord pass-through grommet located in the back/modesty panel of returns, bridges and credenzas, facilitates reaching wall electrical outlets.
- ▶ All drawers are 5-sided construction, which allows easy drawer alignment or replacement of drawer fronts.
- ▶ Locking units equipped with interchangeable core removable locks.
- ▶ Peninsula models H10721 and H10722 ship complete with end panel and black 4 1/2" diameter support column. For a silver support column option, please see model HPC191X on page 133 (ordered separately).
- ▶ Stack-on storage attaches with two removable mounting brackets.
- ▶ Adjustable hex leveling glides allow floor-standing furniture to be easily leveled without lifting the unit; glides have 3/4" adjustable range.

⚠ **Keyed alike cores must be ordered separately — see page 743.**

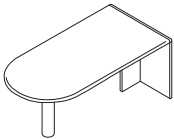

Description	Full Width Overhang	Model	Ship Weight	Cube	List
 <p>Peninsula w/End Panel and Steel Support Column 72"W x 36"D x 29 1/2"H 66"W x 30"D x 29 1/2"H</p> <p>NOTES: Use for "U" or "L" configuration. Cord routing notch in brace panel. Round support column is black. ⚠ Not designed to be used freestanding.</p>		H10721 E♦A	150	15.1	\$1166
		H10722 E♦A	125	11.8	\$1019

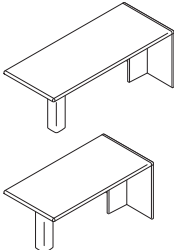
 <p>Peninsula Desk w/End Panel and Wood Support Column 72"W x 30"D x 29 1/2"H 60"W x 30"D x 29 1/2"H</p> <p>NOTES: Designed for use in "U" or "L" configurations, or to be used in combination with bookcase with adjustable shelves (model H107569). 60"W x 30"D size can be used to achieve a space efficient 5' x 5' L-shaped workstation (when connected to a 30"W return shell) or 5' x 8' U-shaped workstation (when used with a 42"W x 20"D bridge and 60"W credenza shell). Cord routing notch in brace panel. The wood support column component ships fully assembled. ⚠ Not designed to be used freestanding.</p>		H10724 E♦A	167	14.6	\$1009
		H10726 E♦A	161	10.7	\$ 935

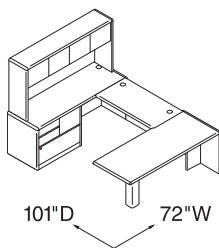

H10721
H10770
H107817
H10505
H10734

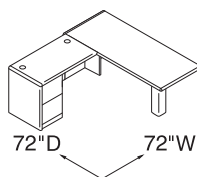

H10724
H107192L

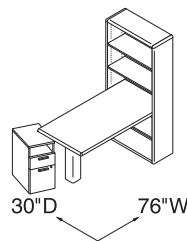

H10726
H107569
H105109

 <p>Field Installable Laminate Modesty Panel 50 1/4"W x 3/4"Thick x 18"H</p> <p>NOTES: Center drawer model H1522 can be used in conjunction with modesty panel. Cord pass-through notch in top corner of modesty panel. See page 268 for optional center drawers. ⚠ Not designed to attach to peninsulas manufactured prior to 12/1/2001. SPECIFYING EXAMPLE: H10528.N</p>	H10528 E♦A	25	1.3	\$ 170
---	------------	----	-----	--------

 <p>Field Installable Modesty Panel, Frosted with Silver Frame 50 1/4"W x 3/4"Thick x 18"H — for use on 72"W peninsulas</p> <p>⚠ Center drawers not designed to be used with the frosted/silver modesty panel.</p>	HPC180G	33 	1.5	\$ 629
--	---------	--	-----	--------

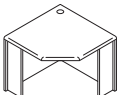
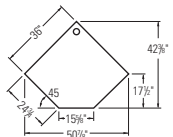
 <p>Corner Unit 24" x 36" x 36" x 24" x 29 1/2"H — (1 grommet in top) Works with 24"D x 29 1/2"H returns or bridges.</p> <p>NOTES: Support legs feature cutouts for routing cords. Can be used freestanding.</p>	 <p>H107811 E♦A</p>	136	4.2	\$1049
---	---	-----	-----	--------

NOTE: See pages 260 through 269 for shared components.

How to specify	1st Option
<p>Select Model Number from above</p> <p>H 1 0 7 2 1 .</p>	<p>Select Laminate</p> <p>See pages 48-49</p> <p>N N</p>



- ▶ Cord management grommets, for routing and hiding wires and cables, are located in the tops of desks, credenzas, and returns. Grommets also serve as anchor points for stack-on storage and organizers.
- ▶ Cord pass-through grommet located in the back/modesty panel of returns, bridges and credenzas, facilitates reaching wall electrical outlets.
- ▶ All drawers are 5-sided construction, which allows easy drawer alignment or replacement of drawer fronts.
- ▶ Locking units equipped with interchangeable core removable locks.
- ▶ Stack-on storage attaches with two removable mounting brackets.
- ▶ Adjustable hex leveling glides allow floor-standing furniture to be easily leveled without lifting the unit; glides have 3/4" adjustable range.

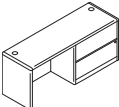
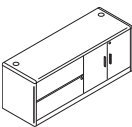

	Description	Full Width Overhang	Model	Ship Weight	Cube	List
	Bridge (Single Ped. Desk, Desk Shell or Peninsula to Corner Unit or Single Ped. Credenza or Credenza Shell) 47"W x 24"D x 29 1/2"H, (Clear inside depth = 22 3/4"D) 42"W x 24"D x 29 1/2"H, (Clear inside depth = 22 3/4"D) 36"W x 24"D x 29 1/2"H, (Clear inside depth = 22 3/4"D) (for use with Corner Units) 47"W x 20"D x 29 1/2"H, (Clear inside depth = 18 3/4"D) 42"W x 20"D x 29 1/2"H, (Clear inside depth = 18 3/4"D) NOTES: Two cord grommets in top; one cord pass-through grommet in top center of modesty panel. Kneespace of desk limited to 24 3/4"W if bridge is used with 66"W single pedestal desk.		H10770 E◆A H10760 E◆A H10751 E◆A H107399 E◆A H107398 E◆A	81 69 64 68 56	2.5 2.6 2.5 2.8 2.6	\$ 358 \$ 343 \$ 341 \$ 343 \$ 333
	Credenza with 36" Lateral (with core removable lock) – 2 cord grommets in top 72"W x 24"D x 29 1/2"H, Right 72"W x 24"D x 29 1/2"H, Left NOTES: One cord pass-through grommet in top center of modesty panel. Mechanical interlock inhibits the extension of more than one drawer at a time. Optional stack-on models H10734, H10734K, and H10734G maximize storage space. ⚠ Not designed to be used with 24"D modular or mobile pedestals.	3 1/2" 3 1/2"	H10747R H10748L	247 247	36.0 36.0	\$1426 \$1426
	Credenza with Lateral File, Left and Storage Cabinet, Right 72"W x 24"D x 29 1/2"H NOTES: Lateral file is equipped with mechanical interlock to inhibit the extension of more than one drawer at a time. Storage cabinet has one adjustable interior shelf which adjusts in 1/4" increments over a range of 5". Drawers and doors lock separately; the two locks are keyed alike. Can be used with optional stack-on storage. See page 262 for Stack-on Storage models H10734/H10734K/H10734G.	3 1/2"	H107492	307	35.6	\$1768

NOTE: See pages 260 through 269 for shared components.

How to specify	Select Model Number from above H 1 0 7 7 0 .	1st Option Select Laminate See pages 48-49 N N
----------------	---	--

Icon Legend on page 10

10700 Series™ Shared Components and Accessories

GSA SIN 711-8 Except as Noted



△ Upcharges may apply to premium tackboard fabric grades.

- ▶ Shared components on this page can be used with modular, full pedestal, and 3/4 pedestal models shown on pages 250-259.
- ▶ Stack-on storage models are equipped with self closing, adjustable hinged doors, and valance to hide task light.
- ▶ When spanning the total depth of an L-workstation, stack-on storage attaches to the desk, peninsula or corner unit via double-sided tape, and to the return through the grommet hole.
- ▶ Stack-on storage end panels are E◆A.
- ▶ Stack-on storage and organizers attach with two removable mounting brackets, except for "L" workstation unit.
- ▶ Stacked paper management segments and organizes stack-on storage compartments and bookcase shelves. Unit can be used in stack-on storage models H107318 and H10734. See HLVPM2 on page 268.
- ▶ Vertical paper manager keeps papers, files, and books neatly organized and within easy reach from a seated position. Fits under stack-on storage models. See page 268.
- ▶ Removable lock core kit for locking stack-on storage is model HF27B. See page 743.

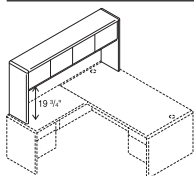

Description	Model	Ship			
		COM	Weight	Cube	List
 <p>Stack-on Storage for "L" Workstation 74⁵/₈"W x 14⁵/₈"D x 37¹/₈"H (Use Task Light model H870960, see page 269)</p>	H107318 E◆A		198	15.8	\$1166
	H107318K E◆A		198	15.8	\$1246
<p>NOTES: Spans the total depth dimension of configurations comprised of: 48"W return or return shell attached to a 30"D single pedestal desk, desk shell or peninsula (78"D); 42"W return or return shell attached to a 36"D single pedestal desk, desk shell or peninsula (78"D) or 42"W return or return shell attached to a 36" corner unit (78"D). Attaches to desk, peninsula, or corner unit via double sided tape, and to return through grommet hole. Inside storage consists of two compartments each 34³/₄"W x 12¹/₈"D x 12"H. Use back enclosure model H107358 and tackboard model H90035. For vertical paper manager, see page 268.</p>					

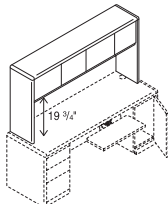
 <p>Stack-on Storage 68⁵/₈"W x 14⁵/₈"D x 37¹/₈"H, 4 doors (For 72"W Credenza) 62⁵/₈"W x 14⁵/₈"D x 37¹/₈"H, 4 doors (For 66"W Credenza) 56⁵/₈"W x 14⁵/₈"D x 37¹/₈"H, 4 doors (For 60"W Credenza or Return) 44⁵/₈"W x 14⁵/₈"D x 37¹/₈"H, 3 doors (For 48"W Return or 48"W Small Office Desk)</p>	H10734 E◆A		175	16.0	\$1062
	H10733 E◆A		168	14.4	\$1048
	H10732 E◆A		161	13.0	\$1019
	H107313 E◆A		147	10.3	\$ 935
<p>Stack-on Storage, Locking 68⁵/₈"W x 14⁵/₈"D x 37¹/₈"H, 4 doors (For 72"W Credenza) 62⁵/₈"W x 14⁵/₈"D x 37¹/₈"H, 4 doors (For 66"W Credenza) 56⁵/₈"W x 14⁵/₈"D x 37¹/₈"H, 4 doors (For 60"W Credenza or Return) 44⁵/₈"W x 14⁵/₈"D x 37¹/₈"H, 3 doors (For 48"W Return or 48"W Small Office Desk)</p>	H10734K E◆A		175	16.0	\$1142
	H10733K E◆A		168	14.4	\$1128
	H10732K E◆A		161	13.0	\$1099
	H107313K E◆A		147	10.3	\$ 975
<p>NOTES: Inside storage for H10734, H10733 and H10732 contains two compartments each sized: 32¹/₂"W, 28³/₄"W, 25³/₄"W respectively x 12¹/₈"D x 12"H. H107313 has 3 doors. Inside storage for H107313 contains two compartments: right side 12¹/₈"W, left side 26³/₄"W respectively x 12¹/₈"D x 12"H. Stack-ons attach through grommet holes on the work surfaces of desks, credenzas and returns. Model 10734 can be used for "L" configuration comprised of 30"D desk, desk shell or peninsula and 42"W return or return shell; or a 36"D desk, desk shell, peninsula or corner unit and 36"W return shell. Model H107313K has one lock which secures two of the three doors. For task light and vertical paper manager, see pages 268-269.</p>					

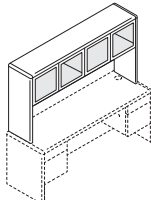
 <p>Stack-on Storage w/Frosted Doors w/Silver Frame 68⁵/₈"W x 14⁵/₈"D x 37¹/₈"H</p>	H10734G E◆A		185	16.2	\$1662
	<p>NOTES: Rich wood-grain laminate and contemporary frosted doors with silver frames add a sleek mixed materials option to 10700 Series™. Accepts back enclosure model H10738, tackboard for use with back enclosure model H90034, task light HH870960 and vertical paper manager HVLPM1. Frosted door models are non-locking.</p>				

 <p>18⁵/₈"H</p>	Back Enclosure for Stack-on Storage					
	72 ¹ / ₄ "W - for 74 ⁵ / ₈ "W model #H107318/H107318K	H107358		34	1.3	\$ 238
	66 ¹ / ₄ "W - for 68 ⁵ / ₈ "W model #H10734/H10734K	H10738		31	1.3	\$ 218
	60 ¹ / ₄ "W - for 62 ⁵ / ₈ "W model #H10733/H10733K	H10737		29	1.3	\$ 203
	54 ¹ / ₄ "W - for 56 ⁵ / ₈ "W model #H10732/H10732K	H10736		27	1.3	\$ 194
42 ¹ / ₄ "W - for 44 ⁵ / ₈ "W model #H107313/H107313K	H107353		22	0.9	\$ 194	
<p>NOTES: Non-tackable. Specify laminate. Feature full width 1¹/₈" slot at bottom to facilitate routing cords and reaching wall electrical outlets. H10738 can also be used with H10634 and H94234 stack-ons.</p>						

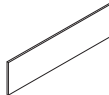
 <p>18"H</p>	Tackboards for use with Stack-on Back Enclosures (Back Enclosures must be ordered separately).					
	71 ¹ / ₂ "W - for 74 ⁵ / ₈ "W model #H107318/H107318K Hutch with #H107358 Enclosure	H90035	2	13	2.8	\$ 289
	65 ¹⁵ / ₁₆ "W - for 68 ⁵ / ₈ "W model #H10734/H10734K Hutch with #H10738 Enclosure	H90034	2	11	2.0	\$ 276
	59 ¹⁵ / ₁₆ "W - for 62 ⁵ / ₈ "W model #H10733/H10733K Hutch with #H10737 Enclosure	H90033	2	10	1.8	\$ 261
	53 ¹⁵ / ₁₆ "W - for 56 ⁵ / ₈ "W model #H10732/H10732K Hutch with #H10736 Enclosure	H90032	2	9	1.8	\$ 230
41 ¹ / ₂ "W - for 44 ⁵ / ₈ "W model #H107313/H107313K Hutch with #H107353 Enclosure	H90031	2	7	1.7	\$ 220	
<p>NOTES: Tackboards are sized ³/₈" narrower than respective stack-on storage back enclosure, allowing ³/₈" each side to route task light cords. Specify fabric selection from pages 310-311. Board is attached using latch & hook tape provided. H90034 can also be used with H10738 on H10634 and H94234 stack-ons.</p>						

SPECIFYING EXAMPLE: H90035.APN15

NOTE: See pages 260 through 269 for shared components.

How to specify	1st Option
Select Model Number from above	Select Laminate See pages 48-49
H 1 0 7 3 4 .	N N
H 1 0 7 3 5 8 .	N

Icon Legend on page 10

▶ Shared components on this page can be used with modular, full pedestal, and 3/4 pedestal models shown on pages 250-259.





▶ Broad family of storage components takes organization way beyond the confines of a desk drawer.
▶ Pencil/media/file mobile pedestal easily stores CD's and conventional supplies. Media organizer allows CD's to be stored in label-up position.

▶ Mobile pedestal tops have smooth, flat edges. Units are standard with counterweight and four 2" diameter, non-locking casters.

▶ Locking units equipped with interchangeable core removable locks.
▶ Mobile pedestals, lateral files, storage cabinets, and bookcases ship assembled.

⚠ **Keyed alike cores must be ordered separately — see model HF23B on page 743 — makes re-keying quick and easy.**



	Description	Model	Ship Weight	Cube	List
	Box/Box/File Mobile Pedestal (with core removable lock) 15 ³ / ₄ "W x 22 ³ / ₄ "D x 28 ³ / ₈ "H — use freestanding or under 24"D, 30"D and 36"D modular shells NOTES: Top box drawer does not lock. File drawer includes hangrails.	H105102	121	8.5	\$ 789
	File/File Mobile Pedestal (with core removable lock) 15 ³ / ₄ "W x 22 ³ / ₄ "D x 28 ³ / ₈ "H — use freestanding or under 24"D, 30"D and 36"D modular shells NOTES: File drawers include hangrails.	H105104	121	8.4	\$ 789
	Box/File Mobile Pedestal (with core removable lock) 15 ³ / ₄ "W x 18 ¹ / ₈ "D x 21 ¹ / ₈ "H — use freestanding or under 20"D, 24"D, 30"D and 36"D modular shells	H105106	65	5.8	\$ 660
	Shelf/Box/File Mobile Pedestal (with core removable lock) 15 ³ / ₄ "W x 18 ¹ / ₈ "D x 28 ³ / ₈ "H — use freestanding or under 20"D, 24"D, 30"D and 36"D modular shells NOTES: Interior dimensions of the open storage area of the Shelf/Box/File model are 14 ¹ / ₈ "W x 16 ³ / ₄ "D x 6 ⁵ / ₈ "H.	H105109	73	7.3	\$ 727

Mobile pedestals have smooth, flat edges.

	Lateral File (with core removable lock) 36"W x 24"D x 29 ¹ / ₂ "H — two drawer — matches depth of credenzas and returns 36"W x 20"D x 29 ¹ / ₂ "H — two drawer 36"W x 20"D x 45 ¹ / ₂ "H — three drawer 36"W x 20"D x 59 ¹ / ₈ "H — four drawer NOTES: Includes hangrails, mechanical interlock and, in H10762 and H107690, a counterweight. Interlock inhibits the extension of more than one drawer from opening at a time. 24"D size aligns evenly with 24"D credenzas, credenza shells, returns, return shells, and wardrobe/storage cabinets to provide linear layout continuity.	H107690 H10762 H107698 H107699	191 168 240 296	18.6 15.6 23.2 31.0	\$1058 \$1019 \$1568 \$2164
---	--	---	--------------------------	------------------------------	--------------------------------------

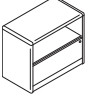
	Lateral File w/Open Shelf (with core removable lock) 36"W x 20"D x 29 ¹ / ₂ "H NOTES: Open storage area measures 33 ⁵ / ₈ "W x 18"D x 12"H; accommodates books or binders, as well as business machines and electronic equipment. Also sized to accept optional stacked paper management model HLVPM2. Drawer design includes integrated hangrails for folders. Accepts bookcase hutch H107292.	H107697	220	15.7	\$ 887
---	--	----------------	-----	------	--------

	Storage Cabinet with doors (with core removable lock) 36"W x 20"D x 29 ¹ / ₂ "H NOTES: One adjustable interior shelf.	H107291	144	15.0	\$ 824
---	--	----------------	-----	------	--------

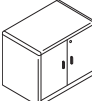
	Storage Cabinet with Doors (with core removable lock) 36"W x 24"D x 29 ¹ / ₂ "H — matches depth of credenzas and returns NOTES: One adjustable interior shelf. 24"D size aligns evenly with 24"D credenzas, credenza shells, returns, return shells, and wardrobe/storage cabinets to provide linear layout continuity.	H107290	162	18.6	\$ 906
---	--	----------------	-----	------	--------

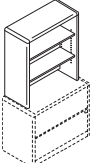
	Bookcase Hutch 32 ⁵ / ₈ "W x 14 ⁵ / ₈ "D x 37 ¹ / ₈ "H NOTES: For use with Lateral Files (H10762, H107690, H107697) and Storage Cabinets (H107291, H107290). Cord pass-through gap behind shelves and a 1 ¹ / ₈ " full-width cord management slot at the bottom of the back panel to facilitate routing cords and reaching wall electrical outlets. When placed on a 29 ¹ / ₂ "H base unit, the total 66 ⁵ / ₈ "H matches the height of credenzas with stack-on storage and the height of the wardrobe/storage cabinet. Two shelves are adjustable in 1 ¹ / ₄ " increments.	H107292 E♦A	93	5.1	\$ 611
---	--	--------------------	----	-----	--------

NOTE: See pages 260 through 269 for shared components.

How to specify	Select Model Number from above	1st Option Select Laminate See pages 48-49
	H 1 0 5 1 0 2 .	N N

10700 Series™ Shared Components and Accessories

GSA SIN 711-8

HON

- ▶ Shared components on this page can be used with modular, full pedestal, and 3/4 pedestal models shown on pages 250-259.
- ▶ Broad family of storage components takes organization way beyond the confines of a desk drawer.
- ▶ Conventional bookcase designs ship fully assembled to ease and speed installation.

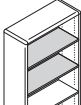

	Description	Model	Ship Weight	Cube	List
	Bookcase w/Fixed Shelves				
	36"W x 13 1/8"D x 29 5/8"H, 2-Shelf	H10752	90	10.9	\$ 564
	36"W x 13 1/8"D x 43 3/8"H, 3-Shelf	H10753	122	15.6	\$ 681
	36"W x 13 1/8"D x 57 1/8"H, 4-Shelf	H10754	156	20.3	\$ 767
	36"W x 13 1/8"D x 71"H, 5-Shelf	H10755	187	25.3	\$ 907
	NOTES: 36"W models with finished back. No assembly required. Ready to set in place.				
	Bookcase w/Adjustable Shelves				
	32 3/8"W x 13 1/8"D x 71"H, 5-Shelf	H107569	170	25.1	\$ 896
	NOTES: 32 3/8"W design with five shelves; two fixed, three adjustable. Shelves adjust in 2 1/2" increments. Finished back. Can be used in combination with peninsula desk models H10724 or H10726. No assembly required. Ready to set in place.				

Shaded shelves are adjustable.

NOTE: See pages 260 through 269 for shared components.

How to specify

Select Model Number from above

H 1 | 0 | 7 | 5 | 2 | .

1st Option

Select Laminate

See pages 48-49

N | N

 Icon Legend on page 10

▶ Broad family of storage components takes storage way beyond the confines of a desk drawer.

▶ The 18"W wardrobe/storage cabinet can be used as wardrobe by removing some or all of the adjustable shelves, coat rod can be removed for storage only.

▶ Locking units equipped with interchangeable core removable locks.

⚠ **Keyed alike cores must be ordered separately — see model HF23B on page 743 — makes re-keying quick and easy.**

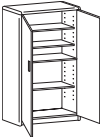
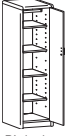
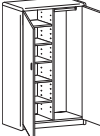
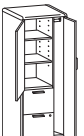

	Description	Model	Ship Weight	Cube	List
 <p>Doors open 110 degrees from closed position.</p>	Storage Cabinet (with core removable lock) 36"W x 24"D x 66 ⁵ / ₈ "H NOTES: Large storage area includes five, full-width (side-to-side) shelves; three are adjustable in 2 ¹ / ₂ " increments. Unit height is designed to match credenza or return plus stack-on height (66 ⁵ / ₈ ").	H107299	341	41.0	\$198
 <p>Doors open 110 degrees from closed position.</p>	Storage Cabinet/Lateral File (with core removable lock) 36"W x 24"D x 66 ⁵ / ₈ "H NOTES: Storage cabinet is standard with one fixed and two full-width adjustable shelves in top compartment; adjustable shelves can be removed. Overall storage compartment measures 31 ¹ / ₄ "W x 22"D x 36 ¹ / ₈ "H and will accommodate supplies, books and binders, as well as business machines and electronic equipment. Cord pass-through gap behind shelves and grommet in back of the cabinet to facilitate routing cords and reaching wall electrical outlets. Two drawer lateral file on bottom. Cabinet and lateral file lock independently.	H107293	365	41.0	\$2196
 <p>Right-hand model H107295R shown.</p>	Wardrobe/Storage Cabinet (with core removable lock) 18"W x 24"D x 66 ⁵ / ₈ "H, with coat rod and 4 adjustable shelves, Hinged Right 18"W x 24"D x 66 ⁵ / ₈ "H, with coat rod and 4 adjustable shelves, Hinged Left NOTES: Unit is standard with four adjustable shelves, coat rod, and core removable lock. Shelves adjust in 2 ¹ / ₂ " increments. Unit height is designed to match credenza or return plus stack-on storage height. Cabinet can be used as a wardrobe by removing four adjustable shelves. Coat rod can be removed from cabinet for storage only applications.	H107295R H107296L	225	22.9	\$1614
 <p>Doors open 110 degrees from closed position.</p>	Personal Wardrobe/Storage Cabinet (with core removable lock) 36"W x 24"D x 66 ⁵ / ₈ "H NOTES: Spacious design is standard with four adjustable shelves (one shelf is fixed), coat rod and core removable lock which locks both doors. Shelves adjust in 2 ¹ / ₂ " increments. Unit height is designed to match credenza or return plus stack-on storage height.	H10730	335	40.6	\$2181
 <p>Right-hand model H107301R shown.</p>	Personal Storage Towers 24"W x 24"D x 66 ⁵ / ₈ "H, Wardrobe Hinged Right, Storage Cabinet Hinged Left 24"W x 24"D x 66 ⁵ / ₈ "H, Wardrobe Hinged Left, Storage Cabinet Hinged Right NOTES: Spacious design includes a wardrobe closet, storage cabinet, and two file drawers in one compact unit. Wardrobe closet contains a coat rod. Storage cabinet includes three shelves, two are adjustable in 2 ¹ / ₂ " increments. Door hinged left or right models available. File drawers operate on ball-bearing suspensions with full extension. File drawers have high sides to accept hanging folders in letter or legal size. Drawers standard with hangrails. Equipped with interchangeable core removable locks. Upper lock secures storage cabinet and wardrobe closet doors; lower lock secures file drawers. Unit height is designed to match credenza or return plus stack-on storage height.	H107301R H107302L	299	27.8	\$2071



NOTE: See pages 260 through 269 for shared components.

How to specify	Select Model Number from above	1st Option
	H 1 0 7 2 9 3 .	Select Laminat See pages 48-49 N N

Icon Legend on page 10

- ▶ "L" Reception station includes components for both the reception/transaction counter for desk and the reception station for return.
- ▶ Round table design is well suited to a variety of applications, including use in private or open plan offices.

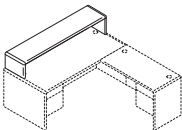
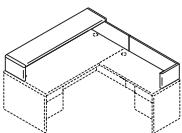
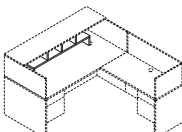

	Description	Model	Ship Weight	Cube	List
	Reception Station/Transaction Counter 68 ⁵ / ₈ "W x 14 ⁵ / ₈ "D x 14 ¹ / ₄ "H Intended for use with H10700 72"W double and single pedestal desk models and 72"W desk shells. NOTES: Cord management grommets on desktops serve as anchor points. Transaction counter organizer (HTCOL52) fits under/inside of transaction counter.	H107720 E♦A	76	3.2	\$ 593
	Reception Station for an "L" Workstation 68 ⁵ / ₈ "W x 75 ¹ / ₂ "D x 14 ¹ / ₄ "H Intended for use with a 72"W x 36"D left single pedestal desk or modular desk shell with a 42"W x 24"D right pedestal return or modular right return shell. Intended for use with a 72"W x 36"D right single pedestal desk or modular desk shell with a 42"W x 24"D left pedestal return or modular left return shell. NOTES: Cord management grommets on desktop and return serves as the anchor points for the reception station for return.	H107721R E♦A	108	4.3	\$ 854
		H107722L E♦A	108	4.3	\$ 854
	Transaction Counter Organizer 48 ³ / ₄ "W x 11 ¹ / ₈ "D x 13"H Fits under Transaction Counter Models H107720, H107721R and H107722L. ▲ Black only. SPECIFYING EXAMPLE: HTCOL52.P	HTCOL52 E♦A	24	1.1	\$ 252
 <i>Base sold separately.</i>	42" Diameter Table Top NOTES: Underside of top features a factory-installed template. The template, which is trilingual, facilitates assembly of the base to the top by designating the specific attachment location for multiple base designs. Bases attach to the top with self drilling screws, no drilling is required. All top + base models are 29 ¹ / ₂ "H. For Base Options see Preside® Table Base pages 700-703. ▲ Requires specification of a support base model shown on pages 700-703. SPECIFYING EXAMPLE: H107242.N	H107242	58	4.1	\$ 571

NOTE: See pages 260 through 269 for shared components.

How to specify

Select Model Number from above

H 1 | 0 | 7 | 7 | 2 | 0 | .

1st Option

Select Laminate









See pages 48-49

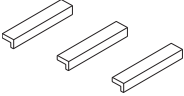





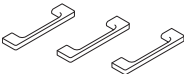

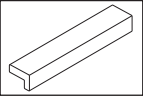
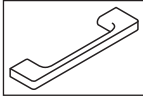
N | N

► Field Installable Drawer/Door Handle Kits for use on 10700 Series™ desks, credenzas, returns, lateral files and storage cabinets.

► Metal template, for field installation of the Linear, Arch, Sweep and Crescent decorative handles, on 10700 and 10500 Series™ drawer fronts, can be ordered through HON Customer Support. Specify as SPLH-SYST-DRKNB.M263164.

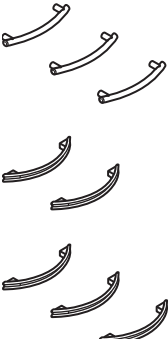

Description	Model	Ship Weight	Cube	List by Paint Grade		
				Core	Metallics	
 Field Installable Drawer/Door Handle Kits Linear, Black, 2-pack Linear, Matte Chrome, 2-pack Linear, Black, 3-pack Linear, Matte Chrome, 3-pack Specify Linear handles in black to coordinate with 10700 or 10500 Series™ models that ship standard with a decorative handle, such as mobile pedestals, storage cabinets and wardrobes.	HLINEARA2	0.4 	0.3	\$ 49		
	HLINEARC2	0.4 	0.3	\$ 49		
	HLINEARA3	0.5 	0.3	\$ 57		
	HLINEARC3	0.5 	0.3	\$ 57		
	HARCHA2	0.4 	0.3	\$ 49		
	HARCHC2	0.4 	0.3	\$ 49		
 Arch, Black, 2-pack Arch, Matte Chrome, 2-pack Arch, Black, 3-pack Arch, Matte Chrome, 3-pack NOTES: Handles are for purchase and field installation on 10700 or 10500 Series™ desks, credenzas, returns, lateral files and modular pedestals. Instructions include mounting hardware and paper template for drilling holes. Applications include: <ul style="list-style-type: none"> • box/file and file/file pedestals = one 2-pack per pedestal • box/box/file and pencil/media/file pedestals = one 3-pack per pedestal • two drawer lateral file = two 2-packs per unit • four drawer lateral file = four 2-packs per unit The Linear and Arch handles can be attached using 96mm (approx. 3¾") or 128mm (approx. 5") hole spacing. Important note: effective January 1, 2007, the holes used for the black drawer/door handle that comes standard on several HON 10700 or 10500 Series™ products, including mobile pedestals, storage cabinet with doors, storage/file cabinet, storage cabinet/lateral file, personal wardrobe/storage cabinets, and personal storage towers, will accept the Linear and Arch handles. Units manufactured prior to January 1, 2007, have 64mm (approx. 2½") hole spacing and will not accept the Linear and Arch handles.	HARCHA3	0.5 	0.3	\$ 57		
	HARCHC3	0.5 	0.3	\$ 57		
						
						
			Linear Handle			
			Arch Handle			

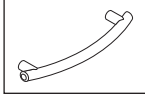
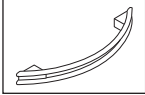
 Field Installable Drawer/Door Handle Kits Sweep Black, 2-pack Sweep Satin Nickel, 2-pack Sweep Black, 3-pack Sweep Satin Nickel, 3-pack Crescent Black, 2-pack Crescent Satin Nickel, 2-pack Crescent Black, 3-pack Crescent Satin Nickel, 3-pack NOTES: Handles are for purchase and field installation on 10700 or 10500 Series™ desks, credenzas, returns, and lateral files, as well as for the modular pedestals used with 10700 and 10500. Applications include: <ul style="list-style-type: none"> • box/file and file/file pedestals = one 2-pack per pedestal • box/box/file and pencil/media/file pedestals = one 3-pack per pedestal • two drawer lateral file = two 2-packs per unit • four drawer lateral file = four 2-packs per unit The hole spacing for the Sweep and Crescent handles is 96mm (approx. 3¾"). Important note: effective January 1, 2007, the holes used for the black drawer/door handle that comes standard on several HON 10700 or 10500 Series™ products, including mobile pedestals, storage cabinet with doors, storage/file cabinet, storage cabinet/lateral file, personal wardrobe/storage cabinets, and personal storage towers, will accept the Sweep and Crescent handles. Units manufactured prior to January 1, 2007, have 64mm (approx. 2½") hole spacing and will not accept the Sweep and Crescent handles. Instructions include mounting hardware and paper template.	HSWEEPA2	0.4 	0.3	\$ 38		
	HSWEEPC2	0.4 	0.3	\$ 38		
	HSWEEPA3	0.5 	0.3	\$ 49		
	HSWEEPC3	0.5 	0.3	\$ 49		
	HCRESCENTA2	0.4 	0.3	\$ 38		
	HCRESCENTC2	0.4 	0.3	\$ 38		
 Crescent Black, 2-pack Crescent Satin Nickel, 2-pack Crescent Black, 3-pack Crescent Satin Nickel, 3-pack Applications include: <ul style="list-style-type: none"> • box/file and file/file pedestals = one 2-pack per pedestal • box/box/file and pencil/media/file pedestals = one 3-pack per pedestal • two drawer lateral file = two 2-packs per unit • four drawer lateral file = four 2-packs per unit The hole spacing for the Sweep and Crescent handles is 96mm (approx. 3¾"). Important note: effective January 1, 2007, the holes used for the black drawer/door handle that comes standard on several HON 10700 or 10500 Series™ products, including mobile pedestals, storage cabinet with doors, storage/file cabinet, storage cabinet/lateral file, personal wardrobe/storage cabinets, and personal storage towers, will accept the Sweep and Crescent handles. Units manufactured prior to January 1, 2007, have 64mm (approx. 2½") hole spacing and will not accept the Sweep and Crescent handles. Instructions include mounting hardware and paper template.	HCRESCENTA3	0.5 	0.3	\$ 49		
	HCRESCENTC3	0.5 	0.3	\$ 49		
						
						
			Sweep Handle			
			Crescent Handle			

NOTE: See pages 260 through 269 for shared components.

How to specify

Select Model Number from above

H | L | I | N | E | A | R | A | 2 |

10700 Series™ Shared Components and Accessories

GSA SIN 711-1, 711-2 Except as Noted

HON

▶ Vertical paper manager designed for desk, credenza, and return tops. Fits under stack-on storage.





▶ For conference table options, see the Preside® table tops and bases on pages 698-703.

▶ Center drawers ideal for pens, pencils and other miscellaneous storage. Feature ball-bearing slide suspension. Compatibility (where to use) information is detailed on page 751.

▶ Task lights are designed for use with stack-on storage and wall mounted storage cabinets.
▶ Task lights feature a new slim profile and electronic ballast for increased energy efficiency.

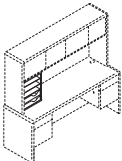
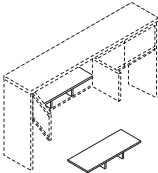
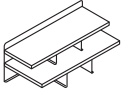
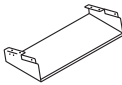
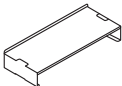
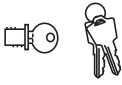
▶ Task lights include a T5 bulb which contains less mercury.



Description	Model	Ship Weight	Cube	List
 <p>Vertical Paper Manager 14⁷/₈"W x 10⁷/₈"D x 19¹¹/₁₆"H</p> <p>NOTES: Keeps papers, files, and books neatly organized and within easy reach from a seated position. Designed for desk, credenza, and return tops. Fits under stack-on storage models. Two pullout drawers and three fixed shelves.</p> <p>SIN 711-8</p>	HLVPM1	27.0	2.8	\$ 298
 <p>Stacked Paper Management 32¹/₂"W x 12⁵/₈"D x 4¹/₄"H</p> <p>NOTES: Segments and organizes stack-on and wall mount storage compartments, as well as bookcase shelves. In some cases, installation may require removing the stack-on or wall mount storage doors.</p> <p>▲ Black only.</p>	HLVPM2 E♦A	22.0	1.25	\$ 144
 <p>Desktop Storage Terrace 26¹/₂"W x 12¹/₂"D x 10¹/₂"H</p> <p>NOTES: Keeps work-in-process, priority files, loose pages, and mail neatly organized and in view. Mixed material design comprised of sturdy laminate shelves with metal back and support panels. Not available in two-tone laminate combination or pattern laminate colors. Choose from Platinum Metallic (T1), Black (P), and Charcoal (S) for the metal components.</p> <p>Sized to fit in stack-on and wall mounted storage cabinets in 10500, 10700, Valido, 94000, Park Avenue Laminate, and 38000 Series. Fits in Voi stack-on and overhead cabinets except for 48"W or smaller sliding door models.</p> <p>Specify: Model.Laminate.Paint SPECIFYING EXAMPLE: HLDST1.N.T1</p> <p><i>Not available in two-tone laminate</i></p>	HLDST1 E♦A	24.0	1.1	\$ 272
 <p>Hanging Paper Shelf 28¹/₁₆"W x 11⁷/₁₆"D x 4⁵/₁₆"H</p> <p>NOTES: Maximizes worksurface space; de-clutters desktop while placing priority communications and active project folders within easy reach. Angled design allows contents to be distinguished at a glance. Mixed material styling features strong painted metal frame with a frosted shelf.</p> <p>Attaches quickly and easily to stack-on and wall mount storage models in the following series: 10500, 10700, Valido, Park Avenue Laminate, 94000, Pennsylvania Avenue, and Voi (except the 36"W overhead hutch with O-legs or panel mount brackets). Not for use with 38000 Series.</p> <p>Choose from Platinum Metallic (T1), Black (P), and Charcoal (S) paint.</p> <p>Specify: Model.Paint SPECIFYING EXAMPLE: HHPS1.T1</p>	HHPS1	7.0	2.9	\$ 175
 <p>Desktop Paper Shelf 28¹/₁₆"W x 11⁵/₈"D x 5"H</p> <p>NOTES: Organizer shelf provides a place and space for work-in-process and piling to keep worksurfaces neat and tidy. Convenient, scalable design with interlocking side supports allow two units to be stacked and integrated. Durable painted metal frame with a frosted shelf; mixed material styling matches hanging paper shelf.</p> <p>Can also be used inside select overhead storage, including the following stack-on with hinged door models: 10500 and Valido 36", 42", 66", 72", 78"W and 10700 68⁵/₈"W.</p> <p>Choose from Platinum Metallic (T1), Black (P), and Charcoal (S) paint.</p> <p>Specify: Model.Paint SPECIFYING EXAMPLE: HDPS1.T1</p>	HDPS1	7.0	2.9	\$ 175
 <p>Black Removable Lock Core Kit— see page 743.</p> <p>NOTES: Lock with a removable cylinder that can be interchanged as needed; allows users to access all furniture pieces in an office with a single key for convenience and security. Makes re-keying quick and easy.</p>	HF23B	0.1	0.1	\$ 28
 <p>Angled Wood Center Drawer 26" x 15³/₈" 22" x 15³/₈"</p> <p>NOTES: Specify laminate for drawer. Model H1522 or H1022 can be used on peninsulas with modesty panel, model H10528.</p> <p>Refer to page 751 for Center Drawer compatibility information</p>	H1526 H1522	12.0  11.0 	1.2 1.1	\$ 182 \$ 168

SIN 711-1, 711-2, 711-11

NOTE: See pages 260 through 269 for shared components.

How to specify

Select Model Number

from above

H | L | V | P | M | 1 | .

1st Option

Select Laminate

See pages 48-49

N |

Icon Legend on page 10

► The power and power/USB hub models bring the ease of plug-and-play to the desktop.

► Models HFLDGRMT3, HGRMTAC, and HGRMTUSB2 fit in 3" round grommet holes in 10700 Series™ desks, credenzas, and returns; not compatible with 10700 products with rectangle-shaped grommets.

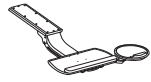

Refer to pages 749-750 for additional product information

SIN 711-1, 711-2, 711-11

Description	Model	Ship Weight	Cube	List by Paint Grade	
				Core	Metallics
Articulating Arm with Keyboard Platform	H1706	16 [S]	1.4	\$ 440	
Articulating Arm with Convertible Keyboard Platform	H2107	16 [S]	1.3	\$ 472	
Sit to Stand Arm with Convertible Keyboard Platform	H2516	17 [S]	1.6	\$ 551	
Slide-Away Keyboard Platform (Specify: Laminate)	H4022	10 [S]	0.6	\$ 194	
Extended Tray Slide-Away Keyboard Platform (Specify: Laminate)	HE4022	12 [S]	0.7	\$ 278	
Metal Keyboard and Mouse Tray (Specify paint)	H4028	11 [S]	1.5	\$ 140	\$ 150
Metal Keyboard Tray (Specify paint)	H4029	11 [S]	1.5	\$ 125	\$ 135
Corner Sleeve — Square Edge (22½" leading edge x 18"D) Specify paint color.	H51206	10 [S]	1.5	\$ 138	\$ 148



SIN 711-1



SIN 711-1

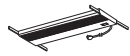

Refer to page 376

Open Market

Description	Model	Ship Weight	Cube	List	
				Weight	Price
LED Task Lights					
Articulating Desk Lamp	HLED1	1.2 [S]	6.5	\$ 350	
Articulating Desk Lamp w/ Occupancy Sensor	HLED10C	1.2 [S]	6.5	\$ 428	
Task Desk Lamp	HLED2	0.7 [S]	3.0	\$ 303	
Task Light — for Stack-on Storage Models 46½"W x 31⅞"D x 1⅞"H, for models H107318, H10734, H10733 or H10732 34⅞"W x 31⅞"D x 1⅞"H, for model H107313 NOTES: Task light and Chicago Code models see page 376.	HH870960 HH870942	12.0 [S] 10.0 [S]	1.1 0.9	\$ 240 \$ 222	

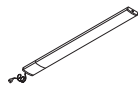

SIN 711-1

Description	Model	Ship Weight	Cube	List	
				Weight	Price
LED Task Lights — for Stack-on Storage Models					
17" LED Light with Power Supply (Single)	HLED17AS	1.2 [S]	0.05	\$ 374	
31" LED Light with Power Supply (Single)	HLED31AS	1.5 [S]	0.09	\$ 503	
17" LED Light with Power Supply for Daisy-chain (Starter)	HLED17A	1.0 [S]	0.05	\$ 411	
31" LED Light with Power Supply for Daisy-chain (Starter)	HLED31A	1.4 [S]	0.09	\$ 553	
17" LED Light with 8" and 30" Jumper Cord for Daisy-chain (Follower)	HLED17AUO	1.0 [S]	0.03	\$ 335	
31" LED Light with 8" and 30" Jumper Cord for Daisy-chain (Follower)	HLED31AUO	1.0 [S]	0.05	\$ 448	
Undercabinet Occupancy Sensor with 1" End to End Connector NOTES: To use the daisy chain application, must start with model HLED17A or HLED31A. No finish specification required. Attaches magnetically to underside of overhead storage, or attaches with provided screws or double-sided tape. Occupancy sensor attaches to a single or starter LED light and will automatically turn the light off after no motion is detected for 30 minutes. Just like all the LED light models, the occupancy sensor features a soft-touch on/off switch. LED task lights have a lifetime of 30,000 hours and have a dimmer feature that allows the user to adjust the amount of light output.	HLEDOSA	0.2 [S]	0.01	\$ 78	



Description	Model	Ship Weight	Cube	List	
				Weight	Price
Field Installable Grommet	HFLDGRMT	0.1 [S]	0.01	\$ 28	
<ul style="list-style-type: none"> Intended for use in tops and end panels to route/hide cords and in modesty panels to facilitate reaching wall electrical outlets. Grommet is field installable. Grommet shape is round. Includes grommet cap and sleeve. Grommet cap measures 3" diameter and includes a ¾" diameter cord access hole. 					<ul style="list-style-type: none"> Grommet sleeve measures 2½" O.D. x ¾" thick. Includes instructions to locate grommet position for desks, credenzas, returns and bridges. ▲ Black Finish ▲ Requires a 2½" diameter hole saw and drill for installation (not included).



Description	Model	Ship Weight	Cube	List	
				Weight	Price
Field Installable Grommet	HFLDGRMT3	0.1 [S]	0.3	\$ 28	
<ul style="list-style-type: none"> Intended for use in tops and end panels to route/hide cords and in modesty panels to facilitate reaching wall electrical outlets. Grommet is field installable. Grommet shape is round. Includes grommet cap and sleeve. Grommet outside dimensions measure 3½" diameter and includes two cord access holes. 					<ul style="list-style-type: none"> Grommet sleeve measures 3" O.D. x 1" thick. Includes instructions to locate grommet position for desks, credenzas, returns and bridges. ▲ Black Finish ▲ Requires a 3" diameter hole saw and drill for installation (not included).

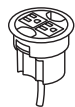

SIN 71-302

Description	Model	Ship Weight	Cube	List	
				Weight	Price
Power Hub, 3" Grommet Mount	HGRMTAC	1.3	0.2	\$ 100	
<ul style="list-style-type: none"> Two grounded AC power outlets. Two cord pass-through holes in cap. 					<ul style="list-style-type: none"> Includes 6' cord with three-prong plug.
▲ Available in Black only (no color designation – Specify: HGRMTAC.X).					



Open Market

Description	Model	Ship Weight	Cube	List	
				Weight	Price
Power/USB Hub, 3" Grommet Mount	HGRMTUSB2	1.3 [S]	0.02	\$ 198	
<ul style="list-style-type: none"> One grounded AC power outlet with 2 USB ports. Two cord pass-through holes in cap. 					<ul style="list-style-type: none"> Includes 6' cord with three-prong plug.
▲ Available in black only (no color designation so use .X – Specify: HGRMTUSB2.X).					







▲ [A, B, I] Icon Legend on page 10

10700 Series™ Shared Components and Accessories

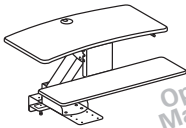
Not on GSA Contract

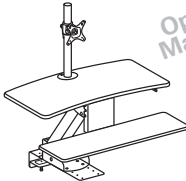

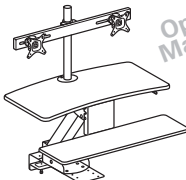
- ▶ These products are designed to allow the user to transition from seating position to standing position throughout the workday.
 - ▶ Gas-assist lever-operated mechanism with positive stop.
 - ▶ Clamp mount compatible with worksurfaces depths of 20"-30".
 - ▶ Clamp requires 3.5" of clearance along back edge of worksurface.
 - ▶ Black seamless worksurfaces.
 - ▶ Silver powder coated metal components.
 - ▶ Lowers below worksurface level on 24" and 30"D worksurfaces.
 - ▶ All models contain a large primary worksurface and a smaller keyboard / mouse surface.
 - ▶ Beveled edges for sleek appearance and comfort while typing.
 - ▶ Monitor arms include height, width, and swivel adjustment.
- ⚠ **Not recommended for use on mobile (castered) worksurfaces.**

	Description	Model	Ship Weight	Cube	List
	Directional™ Desktop Sit-to-Stand Device NOTES: Does not include a monitor arm and is suitable for laptops and/or monitors on their original stands.	HS1100	60 	3.2	\$ 525
	Directional™ Desktop Sit-to-Stand Device with Single Monitor Arm NOTES: Includes a monitor arm for a single monitor.	HS1101	62 	3.2	\$ 615
	Directional™ Desktop Sit-to-Stand Device with Dual Monitor Arm NOTES: Includes a monitor arm for dual monitors.	HS1102	63 	3.2	\$ 700

Mounting and Compatibility:

- This product is intended to be installed on commercial-grade worksurfaces in good condition.
- Compatible with freestanding worksurfaces 24"-30"D or panel-supported worksurfaces 24"-30"D.
- Not for use on mobile worksurfaces.

Clamp Mount

Use when 3.5" minimum overhang is available

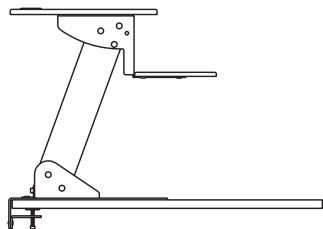

Screw Mount

Use when no overhang is available. Worksurface must be minimum 1" thick.

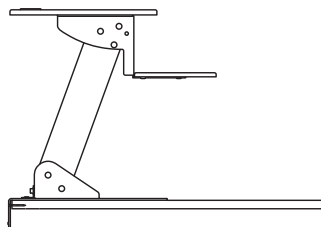

How to specify

Select Model Number from above

H S 1 1 0 0

⚠  Icon Legend on page 10

Components used are listed on pages 272-275. Order components individually. Other configurations are possible, including various sizes of some components.

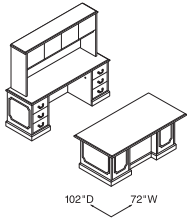

Qty.	Model #	Description	List Price	Price Extension
1	H94271	Double Pedestal Desk 72"W x 36"D x 29½"H	\$2,165	\$2,165
1	H94243	Credenza with Kneespace 72"W x 24"D x 29½"H	\$1,806	\$1,806
1	H94234	Stack-on Storage 70"W x 16⅝"D x 37"H	\$1,303	\$1,303
TOTAL:			\$5,274	

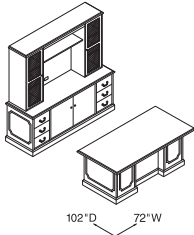

Qty.	Model #	Description	List Price	Price Extension
1	H94271	Double Pedestal Desk 72"W x 36"D x 29½"H	\$2,165	\$2,165
1	H94244	Credenza with Doors 72"W x 24"D x 29½"H	\$2,087	\$2,087
1	H94235	Hutch with Wire Mesh Doors 70"W x 16⅝"D x 48¾"H	\$2,422	\$2,422
TOTAL:			\$6,674	

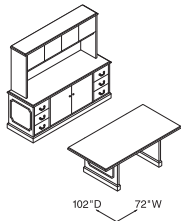

Qty.	Model #	Description	List Price	Price Extension
1	HTLC3672T	Laminate Rectangle Top with Traditional Edge Detail 72"L x 36"W	\$ 989	\$ 989
1	HTLT72	Laminate Traditional Panel Base 29½"H with HTLC3672T Top	\$ 689	\$ 689
1	H94244	Credenza with Doors 72"W x 24"D x 29½"H	\$2,087	\$2,087
1	H94234	Stack-on Storage 70"W x 16⅝"D x 37"H	\$1,303	\$1,303
TOTAL:			\$5,068	

Desk Workstation 72"W x 102"D

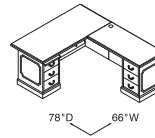

Qty.	Model #	Description	List Price	Price Extension
1	H94284L	Single Pedestal Desk, Left 66"W x 30"D x 29½"H	\$1,780	\$1,780
1	H94215R	Right Return – box/file 48"W x 24"D x 29½"H	\$1,215	\$1,215
TOTAL:			\$2,995	

Desk "L" Workstation – Right 66"W x 78"D

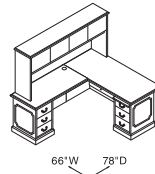

Qty.	Model #	Description	List Price	Price Extension
1	H94283R	Single Pedestal Desk, Right 66"W x 30"D x 29½"H	\$1,780	\$1,780
1	H94216L	Left Return – box/file 48"W x 24"D x 29½"H	\$1,215	\$1,215
1	H94237	Stack-on-Storage 76"W x 16⅝"D x 37"H	\$1,356	\$1,356
TOTAL:			\$4,351	

Desk "L" Workstation – Left 66"W x 78"D

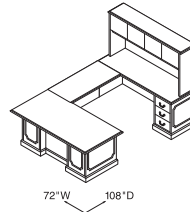

Qty.	Model #	Description	List Price	Price Extension
1	H94286L	Single Pedestal Desk, Left 72"W x 36"D x 29½"H	\$1,894	\$1,894
1	H94270	Bridge 48"W x 24"D x 29½"H	\$ 713	\$ 713
1	H94245R	Single Pedestal Credenza, Right 72"W x 24"D x 29½"H	\$1,561	\$1,561
1	H94234	Stack-on Storage 70"W x 16⅝"D x 37"H	\$1,303	\$1,303
TOTAL:			\$5,471	

Desk "U" Workstation – Right 72"W x 108"D

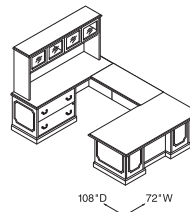

Qty.	Model #	Description	List Price	Price Extension
1	H94285R	Single Pedestal Desk, Right 72"W x 36"D x 29½"H	\$1,894	\$1,894
1	H94270	Bridge 48"W x 24"D x 29½"H	\$ 713	\$ 713
1	H94248L	Credenza w/Lateral, Left 72"W x 24"D x 29½"H	\$1,774	\$1,774
1	H94236	Stack-on Storage w/Glass Doors 70"W x 16⅝"D x 37"H	\$1,743	\$1,743
TOTAL:			\$6,124	

Desk "U" Workstation – Left 72"W x 108"D

94000 Series™ Laminate Wood Desks

GSA SIN 711-8

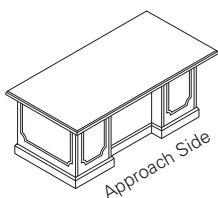

Approach Side

Traditional Edge Detail



- ▶ 18th century elegance, 21st century engineering.
- ▶ Tops are premium abrasion- and stain-resistant high pressure, high-gloss laminate over durable 1/8" solid core high-performance particleboard.
- ▶ Solid wood edge profile.
- ▶ Antique brass drawer pulls; hand-applied raised decorative molding, and plinth style base.
- ▶ Pullout reference/writing shelf is standard on all desk pedestals.
- ▶ Desk, credenza, and return drawers are 5-sided construction, which allows easy drawer alignment or replacement of drawer fronts.
- ▶ Center drawer on desks equipped with built-in pencil tray and central locking (locks all drawers).
- ▶ Drawers operate on full extension, ball-bearing suspensions to ensure smooth, quiet, long-lasting operation.
- ▶ File drawer design includes integrated hangrails for side-to-side letter or legal filing; and front-to-back for letter filing.
- ▶ Locking units equipped with interchangeable core removable locks.
- ▶ 94000 Series™ products produced after 10/26/98 have been improved with a thicker top. Joining with older products before that date may cause misalignment.
- ▶ Adjustable hex leveling glides allow floor-standing furniture to be easily leveled without lifting the unit; glides have 3/4" adjustable range.

⚠ Keyed alike cores must be ordered separately — see model HF23B on page 743 — makes re-keying quick and easy.



Description	Full Width Overhang	Model	Ship Weight	Cube	List
Double Pedestal Desk 2-2 — Box/File 72"W x 36"D x 29½"H NOTES: 7" conference overhang on approach side (provides kneespace for visitors), and a 6¾" conference overhang on each end. Convenient pull out writing shelf above pedestal provides added workspace. Center drawer features central locking (locks all drawers).	7"	H94271	307	52.9	\$2165
Double Pedestal Desk 2-2 — Box/File 66"W x 30"D x 29½"H 60"W x 30"D x 29½"H NOTES: Convenient pull out writing shelf above pedestal provides added workspace. Center drawer features central locking (locks all drawers).	1" 1"	H94276 H94251	340 284	42.8 39.0	\$2109 \$2038
Single Pedestal Desk — Box/File 72"W x 36"D x 29½"H, Right 66"W x 30"D x 29½"H, Right 72"W x 36"D x 29½"H, Left 66"W x 30"D x 29½"H, Left NOTES: Convenient pull out writing shelf above pedestal provides added workspace. Center drawer features central locking (locks all drawers).	7" 1" 7" 1"	H94285R H94283R H94286L H94284L	275 233 275 233	54.0 42.8 54.0 42.8	\$1894 \$1780 \$1894 \$1780
Return — Box/File 48"W x 24"D x 29½"H, Right 42"W x 24"D x 29½"H, Right 48"W x 24"D x 29½"H, Left 42"W x 24"D x 29½"H, Left NOTES: Drawers lock. One round cord grommet in the top. One cord pass-through grommet in the modesty panel to facilitate reaching wall electrical outlets. ⚠ Not designed to be used freestanding.		H94215R H94211R H94216L H94212L	154 146 154 146	24.9 22.1 24.9 22.1	\$1215 \$1125 \$1215 \$1125
Bridge (single ped. desk to single ped. credenza or credenza with lateral) 48"W x 24"D x 29½"H, (clear inside depth is 22½"D) 42"W x 24"D x 29½"H, (clear inside depth is 22½"D) NOTES: One cord pass-through grommet in top center of modesty panel to facilitate reaching wall electrical outlets. Kneespace of desk is limited to 24¾"W if bridge is used with 66"W single pedestal desk.		H94270 E♦A H94260 E♦A	85 76	4.3 4.3	\$ 713 \$ 658
Credenza, Single Pedestal — Box/File 72"W x 24"D x 29½"H, Right 72"W x 24"D x 29½"H, Left NOTES: Drawers lock. One cord pass-through grommet in top center of modesty panel to facilitate reaching wall electrical outlets. See page 273 for optional Overhead Hutch and Stack-on Storage.		H94245R H94246L	230 230	36.0 36.0	\$1561 \$1561
Credenza with 36" Lateral 72"W x 24"D x 29½"H, Right 72"W x 24"D x 29½"H, Left NOTES: Lateral file drawers lock. See page 273 for optional Overhead Hutch and Stack-on Storage.		H94247R H94248L	239 239	36.0 36.0	\$1774 \$1774
Credenza with Doors — Box/File 72"W x 24"D x 29½"H NOTES: All drawers lock. Doors are non-locking. One removable shelf (38¾"W x 13¾"D). Shelf is not adjustable. See page 273 for optional Overhead Hutch and Stack-on Storage.		H94244	313	36.0	\$2087
Credenza with Kneespace — Box/File 72"W x 24"D x 29½"H NOTES: All drawers lock. One cord pass-through grommet in top center of modesty panel to facilitate reaching wall electrical outlets. See page 273 for optional Overhead Hutch and Stack-on Storage.		H94243	253	36.0	\$1806

How to specify	Select Model Number from above H 9 4 2 7 1 .	1st Option Select Laminate See pages 48-49 N N
		E♦A Icon Legend on page 10

- ▶ Stack-on storage equipped with self-closing, adjustable hinged doors.
- ▶ Stack-on storage design includes valance to hide task light.
- ▶ Vertical paper manager keeps papers, files and books organized and within easy reach from a seated position. Fits under stack-on storage models. See page 275.
- ▶ Stacked paper management segments and organizes stack-on storage compartments and bookcase shelves. Unit can be used in models H94237, H94234 and H94236. In some cases, installation may require removing the stack-on storage doors. See page 268.
- ▶ For a variety of work-in-process paper management tools, see page 241.
- ▶ Overhead Hutch features one cord pass-through grommet located in bottom center of back panel.
- ⚠ **Overhead Hutch is not designed to accept task light.**
- ⚠ **Removable lock core kit for locking stack-on storage is model HF27B. See page 743.**



	Description	Model	COM	Ship Weight	Cube	List	
	Stack-on Storage for 78" D "L" Shaped Workstation 76"W x 16 1/8"D x 37"H (Accepts Back Enclosure H107358, Fabric Tackboard H90035 and Task Light HH870960.)	H94237 E♦A		198	18.4	\$1356	
	Stack-on Storage for 78" D "L" Shaped Workstation, Locking 76"W x 16 1/8"D x 37"H (Accepts Back Enclosure H107358, Fabric Tackboard H90035 and Task Light HH870960.) NOTES: Spans the total dimension of "L" shaped layouts comprised of a 48"W return attached to a 30"D single pedestal desk (78"D); or a 42"W return attached to 36"D single pedestal desk (78"D). For vertical paper manager model HLVPM1, see page 275.	H94237K E♦A		198	18.4	\$1436	
	Stack-on Storage 70"W x 16 1/8"D x 37"H (Accepts Back Enclosure H10738, Fabric Tackboard H90034 and Task Light HH870960.)	H94234 E♦A		175	18.0	\$1303	
	Stack-on Storage, Locking 70"W x 16 1/8"D x 37"H (Accepts Back Enclosure H10738, Fabric Tackboard H90034 and Task Light HH870960.) NOTES: For use on 72"W credenza models or on 72"D "L" shaped workstations comprised of a 30"D single pedestal desk and a 42"W return. Inside storage contains two compartments each sized: 31 3/4"W x 12 1/8"D x 12"H. Vertical paper manager, model HLVPM1, fits under stack-on storage. See page 275.	H94234K E♦A		175	18.0	\$1383	
	Stack-on Storage with Glass Doors 70"W x 16 1/8"D x 37"H (Accepts Back Enclosure H10738 and Fabric Tackboard H90034.) (Use Task Light HH870960, see below) NOTES: Elegant wood-framed, clear glass door design. For use on 72"W credenza models or on 72"D "L" shaped workstations comprised of a 30"D single pedestal desk and a 42"W return. No lock option for glass doors. For vertical paper manager model HLVPM1, see page 275.	H94236 E♦A		171	18.0	\$1743	
	Back Enclosure for Stack-on Storage 76"W model #H94237 70"W model #H94234 or H94236	H107358 H10738		34 31	1.3 1.3	\$ 238 \$ 218	
	NOTES: Specify laminate with a single designator. Non-tackable surface. Feature full width 1 1/8" slot at bottom to facilitate routing cords and reaching wall electrical outlets. SPECIFYING EXAMPLE: H107358.N						
	Tackboards for use with Stack-on Storage Back Enclosures (Back Enclosures must be ordered separately.) 71 1/2"W for 76"W model #H94237 Stack-on with #H107358 Enclosure 65 5/16"W for 70"W model #H94234 or H94236 Stack-on with #H10738 Enclosure	H90035 H90034		2 2	13 11	2.8 2.0	\$ 289 \$ 276
	NOTES: Specify fabric selection from pages 310-311. Upcharges may apply to premium fabric grades. Tackboards are sized 3/4" narrower than respective stack-on storage back enclosure, allowing 3/8" each side to route task light cords. Attached to back enclosure using latch & hook tape provided. SPECIFYING EXAMPLE: H930035.APN15						
	Recessed Task Light 46 1/2"W x 3 1/16"D for Models H94234, H94234K, H94236, H94237 and H94237K. Chicago code version (with fused plug)	HH870960 HH870960CH		12 [S] 12 [S]	1.1 1.1	\$ 240 \$ 300	
	Overhead Hutch w/Wire Mesh Doors 70"W x 16 1/8"D x 48 3/4"H NOTES: Each side storage compartment contains: 1-lower opening 16 1/4"W x 13 1/16"D x 15 5/8"H and 2-upper openings 16 1/4"W x 13 1/16"D x 14 3/8"H. Clearance for computer, etc.: 32 1/16"W x 12 5/8"D x 31 3/4"H. No lock option for mesh doors. ⚠ 14 3/4" H center shelf does not adjust. Not designed to accept task light.	H94235		260	43.3	\$2422	

How to specify	Select Model Number from above H 9 4 2 3 7 .	1st Option Select Laminate See pages 48-49 N N
----------------	---	--

94000 Series™ Laminate Wood Desks

GSA SIN 711-8



- ▶ Personal wardrobe/storage cabinet is standard with four adjustable shelves (one shelf is fixed) plus a generous wardrobe section with a coat rod.
- ▶ Bookcase with glass doors brings order, utility and a touch of elegance to the traditional office.
- ▶ File drawers accommodate letter and legal width side-to-side filing, and letter-width front-to-back filing; use hanging folders with a maximum overall height of 9⁵/₈".
- ▶ Adjustable hex leveling glides allow floor-standing furniture to be easily leveled without lifting the unit; glides have 3/4" adjustable range.
- ▶ For conference table options, see the Preside® table tops and bases on pages 698-703. Order edge option "T" for 94000 Desks edge compatibility.
- ▶ Removable lock core kit – HFZ3B – allows multiple units to be keyed alike. See page 743.



	Description	Model	Ship Weight	Cube	List
	Computer Work Table with cord grommet 36"W x 30"D x 29 ¹ / ₂ "H NOTES: One removable shelf (32 ¹³ / ₁₆ "W x 12 ⁵ / ₈ "D).	H94226	130	23.8	\$ 984
	Lateral Files (with core removable lock) 37 ¹ / ₂ "W x 20 ¹ / ₂ "D x 29 ¹ / ₂ "H — two drawer 37 ¹ / ₂ "W x 20 ¹ / ₂ "D x 59 ¹ / ₈ "H — four drawer NOTES: High capacity file storage. Includes hangrails; mechanical interlock inhibits the extension of more than one drawer at a time. Two drawer design is equipped with a counterweight.	H94223 H94229	172 300	17.7 34.0	\$1247 \$2140
	Storage Cabinet (with core removable lock) 37 ¹ / ₂ "W x 20 ¹ / ₂ "D x 29 ¹ / ₂ "H NOTES: Bookcase hutch H94210 can be used with H94291. One adjustable shelf, adjusts in 1/4" increments.	H94291	165	16.7	\$1118
	Bookcase Hutch 35 ³ / ₄ "W x 14 ⁵ / ₁₆ "D x 37"H, (3 shelves; 2 adjustable, includes bottom of unit) Designed to be used on model H94223 lateral file or model H94291 storage cabinet. NOTES: One cord pass-through grommet located at bottom center of back panel. Two adjustable shelves, adjust in 1/4" increments.	H94210	95	14.0	\$ 834
	Bookcase 35 ³ / ₄ "W x 14 ⁵ / ₁₆ "D x 35 ¹ / ₂ "H, 2-Shelf 35 ³ / ₄ "W x 14 ⁵ / ₁₆ "D x 49 ⁵ / ₈ "H, 3-Shelf 35 ³ / ₄ "W x 14 ⁵ / ₁₆ "D x 64"H, 4-Shelf 35 ³ / ₄ "W x 14 ⁵ / ₁₆ "D x 78 ¹ / ₄ "H, 5-Shelf NOTES: Fixed shelves.	H94221 H94222 H94224 H94225	100 130 160 200	14.8 20.6 26.3 32.3	\$ 780 \$ 873 \$ 990 \$1086
	Bookcase with Glass Doors 35 ³ / ₄ "W x 14 ⁵ / ₁₆ "D x 49 ⁵ / ₈ "H NOTES: Upscale design brings order, utility and a touch of elegance to the traditional office. Wood-framed, clear glass doors with hinges provide easy access to interior. Three fixed shelves provide spacious storage. Shelf measures 32 ³ / ₄ "W x 11 ³ / ₄ "D. ⚠ Doors are not designed to lock.	H94220	155	20.6	\$1393
	Storage Cabinet/Lateral File (with core removable lock) 37 ¹ / ₂ "W x 24"D x 66 ¹ / ₂ "H NOTES: Standard with one fixed and two full-width adjustable shelves in top compartment; adjustable shelves can be removed. Overall storage compartment measures 33 ³ / ₄ "W x 22"D x 36 ¹ / ₈ "H and will accommodate supplies, books and binders, as well as business machines and electronic equipment. Cord pass-through gap behind shelves and grommet in back of the cabinet to facilitate routing cords and reaching wall electrical outlets. Two drawer lateral file on bottom. Lateral file comes with mechanical interlock and hangrails. Cabinet and lateral file lock independently. Unit height is designed to match credenza or return plus stack-on storage height or the two drawer lateral file or storage cabinet plus the bookcase hutch height (66 ¹ / ₂ "H).	H94435	355	44.4	\$2281
	Personal Wardrobe/Storage Cabinet (with core removable lock) 37 ¹ / ₂ "W x 24"D x 66 ¹ / ₂ "H NOTES: Spacious design is standard with four adjustable shelves (one shelf is fixed) plus a generous wardrobe section with a coat rod. Shelves adjust in 2 ¹ / ₂ " increments. One lock secures both doors. Unit height is designed to match credenza plus stack-on storage height or the two drawer lateral file or storage cabinet plus the bookcase hutch height (66 ¹ / ₂ "H).	H94430	351	44.4	\$2242

Doors open 110 degrees from closed position.

How to specify	<p>Select Model Number from above</p> <p>H 9 4 2 2 6 .</p>	<p>1st Option</p> <p>Select Laminate</p> <p>See pages 48-49</p> <p>N N </p>
----------------	--	---

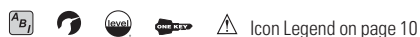

Icon Legend on page 10

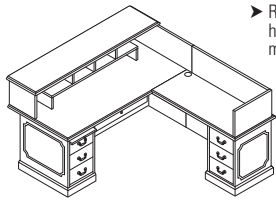

- ▶ Reception station/transaction counter has traditional-styled decorative molding on the approach side.
- ▶ Reception station for "L" workstation includes components for both the reception/transaction counter for desk and the reception station for return.
- ▶ Transaction Counter Organizer model HTCOL52 fits under/inside of transaction counter.
- ▶ For conference table options, see the Preside® table tops and bases on pages 698-703. Order edge option "T" for 94000 Desks edge compatibility.



	Description	Model	Ship Weight	Cube	List
	Reception Station/Transaction Counter 71 ³ / ₄ "W x 16 ¹ / ₈ "D x 14 ¹ / ₄ "H Designed for use with 72"W single pedestal desk models H94285R or H94286L.	H94720 E ◆A	75	2.6	\$ 813
	Reception Station for an "L" Workstation 71 ³ / ₄ "W x 82 ³ / ₄ "D x 14 ¹ / ₄ "H Designed for use with 72"W single pedestal desk H94286L and 48"W return H94215R (shown) Designed for use with 72"W single pedestal desk H94285R and 48"W return H94216L.	H94721R E ◆A H94722L E ◆A	100	4.0	\$ 983 \$ 983
<i>Model H94721R shown</i>					
	Transaction Counter Organizer 48 ³ / ₄ "W x 11 ¹ / ₈ "D x 13"H Fits under Transaction Counter on models H94720, H94721R and H94722L. ▲ Black only. SPECIFYING EXAMPLE: HTCOL52.P	HTCOL52 E ◆A	24	1.1	\$ 252
	Vertical Paper Manager 14 ⁷ / ₈ "W x 10 ⁷ / ₈ "D x 19 ¹¹ / ₁₆ "H NOTES: Keeps papers, files, and books neatly organized and within easy reach from a seated position. Designed for desk, credenza, and return tops. Fits under stack-on storage models. Two pullout drawers and three fixed shelves. SPECIFYING EXAMPLE: HLVPM1.N	HLVPM1	27	2.8	\$ 298
<i>Not available in two-tone laminate</i>					
	Angled Wood Center Drawer 26" x 15 ³ / ₈ " 22" x 15 ³ / ₈ " NOTES: Specify laminate. SPECIFYING EXAMPLE: H1526.N	H1526 H1522	12 11	1.2 1.1	\$ 182 \$ 168
<i>Refer to page 751 for Center Drawer compatibility information</i>					
SIN 711-1, 711-2, 711-11					
	Articulating Arm with Keyboard Platform Articulating Arm with Convertible Keyboard Platform Sit to Stand Arm with Convertible Keyboard Platform Slide-Away Keyboard Platform (Specify: Laminate) Extended Tray Slide-Away Keyboard Platform (Specify: Laminate)	H1706 H2107 H2516 H4022 HE4022	16 16 17 10 12	1.4 1.3 1.6 0.6 0.7	\$ 440 \$ 472 \$ 551 \$ 194 \$ 278
<i>Refer to pages 749-750 for additional product information</i>					
SIN 711-1, 711-2, 711-11					

How to specify	Select Model Number from above H 9 4 7 2 0 .	1st Option Select Laminate See pages 48-49 N N
----------------	---	--

basyx by HON® BL Series

Not on GSA Contract

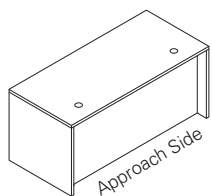

- ▶ Scratch- and stain-resistant thermal-fused laminate surfaces.
- ▶ Durable 1" thick tops and end panels.

- ▶ Full height modesty panels.
- ▶ Desk, credenza shells, and peninsula assemble quickly and easily.
- ▶ Breakfront design creates a high end aesthetic for private offices and executive workstations.
- ▶ Breakfront desk features fixed and adjustable shelves.

- ▶ Desk shells come standard with Black 3" round grommets.
- ▶ Recessed modesty panel design on desk shells provides overhang for visitor meetings and conferencing.
- ▶ Glass modesty replaces laminate modesty included with desk.
- ▶ Credenza shells come standard with Black grommets.

- ▶ Adjustable floor leveling glides provide 3/4" of adjustment.
- ▶ Three laminate color options — Mahogany (NN), Medium Cherry (A1A1) or Espresso (ESES).
- ▶ **basyx by HON® 5-year Limited Warranty.**







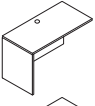

	Description	Overhang	Model	Ship Weight	Cube	List
<p>Open Market</p>	Breakfront Desk Shell with Bow Front Top 72"W x 42"D x 29"H NOTES: Two cord management grommets in tops.	12 ⁹ / ₁₀ "	HBL2111BF E◆A	156	9.6	\$ 532
<p>Open Market</p>	Breakfront Desk Shell with Rectangle Top 72"W x 36"D x 29"H NOTES: Two cord management grommets in tops.	6 ⁷ / ₁₀ "	HBL2101BF E◆A	152	8.4	\$ 474
<p>Open Market</p>	Glass Modesty Panel For 72"W Breakfront Desk Shell		HBL72BFMODG	18	2.0	\$ 225
<p>Open Market</p>	Desk Shell 72"W x 42"D x 29"H, Bow Top 72"W x 36"D x 29"H, Rectangle Top 66"W x 30"D x 29"H, Rectangle Top 60"W x 30"D x 29"H, Rectangle Top NOTES: Two cord management grommets in tops.	16 ¹ / ₂ " 10" 4 ¹ / ₂ " 4 ¹ / ₂ "	HBL2111 E◆A HBL2101 E◆A HBL2102 E◆A HBL2103 E◆A	176 161 132 122	8.3 7.2 7.1 5.2	\$ 443 \$ 395 \$ 348 \$ 323
<p>Open Market</p>	Peninsula with End Panel 72"W x 36"D x 29"H NOTES: Support column available in Black only. For use in "U" or "L" configuration. ▲ Not designed to be used freestanding.		HBL2115 E◆A	132	12.6	\$ 395
<p>Open Market</p>	Credenza Shell 72"W x 24"D x 29"H 60"W x 24"D x 29"H NOTES: Two cord management grommets in the top and one cord pass-through grommet in the top center of modesty panel.		HBL2121 E◆A HBL2123 E◆A	119 111	5.7 6.0	\$ 319 \$ 283

How to specify	Select Model Number from above H B L 2 1 1 1 B F .	1st Option Select Laminate NN Mahogany A1A1 Medium Cherry ESES Espresso N N
----------------	--	--

▲ E◆A Icon Legend on page 10

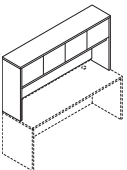
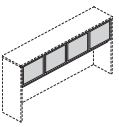
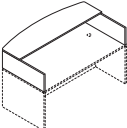
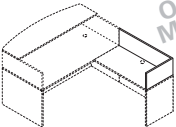





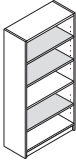

- ▶ Scratch- and stain-resistant thermal-fused laminate surfaces.
- ▶ Durable 1" thick tops and end panels.
- ▶ Full height modesty panels.
- ▶ Adjustable floor leveling glides provide 3/4" of adjustment.
- ▶ 72"W and 60"W hutches with doors include fully enclosed back with a grommet to facilitate routing cords.
- ▶ Return shells are non-handed.
- ▶ Returns, bridges, and reception stations assemble quickly and easily.
- ▶ Personal wardrobe cabinet features coat rod, fixed shelf, and lock.
- ▶ Personal wardrobe cabinet comes with metal handle in Silver finish.
- ▶ HBL2211 and HBL2213 can be used to quickly convert existing 72"W desks and 42 1/4"W returns into reception stations.
- ▶ 3" diameter grommet(s) in tops of desks to route cords; grommet cap is black.
- ▶ Return shells and bridge come standard with 3" round Black grommets.
- ▶ **basyx by HON® 5-year Limited Warranty.**

	Description	Model	Ship Weight	Cube	List
 	<p>Return Shell 48 1/4"W x 24"D x 29"H 42 1/4"W x 24"D x 29"H</p> <p>NOTES: One cord management grommet in the top and one cord pass-through grommet in the top center of modesty panel.</p>	HBL2145 E◆A	79	3.9	\$ 217
		HBL2146 E◆A	73	3.5	\$ 200
	<p>Bridge 47 3/4"W x 24"D x 29"H</p> <p>NOTES: One cord management grommet in the top and one cord pass-through grommet in the top center of modesty panel.</p>	HBL2155 E◆A	64	3.1	\$ 183
	<p>Corner Unit 18" x 36" x 36" x 18" x 29"H</p> <p>NOTES: Intended for use with 24"D x 29"H returns or bridges. ▲ Not designed to be used freestanding.</p>	HBL42CU E◆A	114	5.1	\$ 349
	<p>Hutch with Doors 72"W x 14 5/8"D x 37 1/8"H 60"W x 14 5/8"D x 37 1/8"H</p> <p>NOTES: 72"W Hutch with four doors fits on the 72"W desk or credenza. It can also span an "L" configuration where the width of the return and the depth of the desk or credenza combined equal 72". Example: 42"W return and a 30"D desk shell. 60"W Hutch with doors fits on the 60"W desk or credenza shell.</p>	HBL2180 E◆A HBL2183 E◆A	154 148	7.0 7.1	\$ 431 \$ 391
	<p>Glass Doors for 72" Hutch</p>	HBL72HDG	9	1.5	\$ 275
	<p>Reception Station with Bow Front Transaction Counter 72"W x 42"D x 14"H</p> <p>NOTES: Can be used on 72"W x 42"D bow top and 72"W x 36"D rectangle top desks.</p>	HBL2211 E◆A	79 S	4.8	\$ 291
	<p>Reception Station for Returns 42 1/4"W x 24"D x 13"H</p> <p>NOTES: To be used with model HBL2211 in an "L" configuration on a 42 1/4" return shell.</p>	HBL2213 E◆A	28 S	1.9	\$ 125
	<p>Personal Wardrobe Cabinet 18"W x 24"D x 65"H</p> <p>NOTES: Door is non-handed and can be converted to left or right open configuration.</p>	HBLPWC E◆A	84	6.1	\$ 499

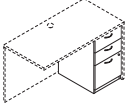
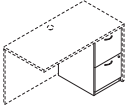
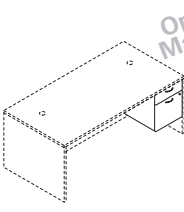
How to specify	<p>Select Model Number from above</p> <p>H B L 2 1 4 5 .</p>	<p>1st Option</p> <p>Select Laminat</p> <p>NN Mahogany A1A1 Medium Cherry ESES Espresso</p> <p>N N </p>
----------------	--	--

▲ E◆A S Icon Legend on page 10

- ▶ Lateral file and pedestals ship assembled.
- ▶ Pedestals are designed to be used under the desk, credenza, and return shells.
- ▶ Drawers operate on full extension, ball-bearing suspensions to ensure smooth, quiet, long-lasting operation.
- ▶ Hangrails are included in each file drawer for side-to-side letter or legal filing, and for front-to-back letter filing.
- ▶ Lateral file and pedestals come standard with metal handle in Silver finish.
- ▶ **basyx by HON® 5-year Limited Warranty.**

	Description	Model	Ship Weight	Cube	List
	Open Market Bookcases — 5-Shelf 32"W x 13 ¹³ / ₁₆ "D x 65 ³ / ₄ "H NOTES: Features three adjustable shelves and one fixed shelf.	HBL2194 E◆A	167.0	11.1	\$ 284
	Open Market Lateral Files — 2-Drawer 35 ¹ / ₂ "W x 22"D x 29"H NOTES: Features inner lock mechanism. Drawers lock. Removable top for use under shells. Features full extension drawers with ball-bearing suspensions.	HBL2171	176.0	19.3	\$ 508
	Open Market Pedestals, Box/Box/File 15 ⁵ / ₈ "W x 21 ³ / ₄ "D x 27 ³ / ₄ "H NOTES: Drawers lock. Not to be used freestanding. For use under shells (sold separately). Unfinished top.	HBL2162	77.0	8.7	\$ 329
	Open Market Pedestal, File/File 15 ⁵ / ₈ "W x 21 ³ / ₄ "D x 27 ³ / ₄ "H NOTES: Drawers lock. Not to be used freestanding. For use under shells (sold separately). Unfinished top.	HBL2163	77.0	8.7	\$ 329
	Open Market Pedestal, Box/File 15 ⁵ / ₈ "W x 21 ³ / ₄ "D x 19 ¹ / ₄ "H NOTES: Drawers lock. Not to be used freestanding. For use under shells (sold separately). Unfinished top.	HBL2164	57.0	5.5	\$ 254
	Open Market Field Installed Contemporary Pull — 2-pack Silver NOTES: For use on Lateral Files, Pedestals, and Personal Wardrobe Cabinets. ▲ Silver finish only, no specification needed.	HBLPCONTEMP	0.1 	0.3	\$ 10
	Open Market Field Installed Bridge Pull — 2-pack Silver NOTES: For use on Lateral Files, Pedestals, and Personal Wardrobe Cabinets. ▲ Polished finish only, no specification needed.	HBLPBRIDGE	0.1 	0.3	\$ 10
	Open Market Field Installed Classic Pull — 2-pack Black NOTES: For use on Lateral Files, Pedestals, and Personal Wardrobe Cabinets. ▲ Black finish only, no specification needed.	HBLPCCLASSIC	0.1 	0.3	\$ 10

How to specify	Select Model Number from above H B L 2 1 9 4 .	1st Option Select Laminate NN Mahogany A1A1 Medium Cherry ESES Espresso N N
----------------	--	---

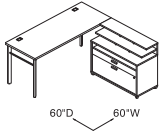

L-Station with Storage
60"W x 60"D

Qty.	Model #	Description	List Price	Price Extension
1	HMNG60WKS	Worksurface 60"W x 23 1/2"D	\$209	\$ 209
2	HMNGDLEG	Desk Leg (single) 2 1/4"W x 23 1/2"D x 28 1/2"H	\$ 88	\$ 176
1	HMNG36FCD	File Center, 2 drawer 36"W x 16"D x 22"H	\$566	\$ 566
1	HMNG36STDM	Stadium 36"W x 21"D x 12 1/2"D x 7 1/2"H	\$127	\$ 127
TOTAL:			\$1,078	

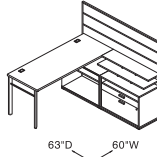

L-Station with Storage and Work Wall
60"W x 63"D

Qty.	Model #	Description	List Price	Price Extension
1	HMNG60WKS	Worksurface 60"W x 23 1/2"D	\$209	\$ 209
1	HMNGDLEG	Desk Leg (single) 2 1/4"W x 23 1/2"D x 28 1/2"H	\$ 88	\$ 88
1	HMNGWKWL	Work Wall 60"W x 17"D x 50"H	\$542	\$ 542
1	HMNG30FCD	File Center, 2 drawer 30"W x 16"D x 22"H	\$509	\$ 509
1	HMNG30FCO	File Center, open 36"W x 16"D x 22"H	\$319	\$ 319
1	HMNG30STDM	Stadium 30"W x 21"D x 12 1/2"D x 7 1/2"H	\$116	\$ 116
TOTAL:			\$1,783	

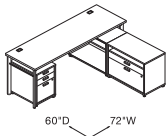

L-Station with Storage
72"W x 60"D

Qty.	Model #	Description	List Price	Price Extension
1	HMNG72WKS	Worksurface 72"W x 23 1/2"D	\$242	\$ 242
2	HMNGDLEG	Desk Leg (single) 2 1/4"W x 23 1/2"D x 28 1/2"H	\$ 88	\$ 176
1	HMNG15PED	Pedestal, P/P/F 15 1/4"W x 21 1/2"D x 22"H	\$364	\$ 364
1	HMNG30FCD	File Center, 2 drawer 30"W x 16"D x 22"H	\$509	\$ 509
1	HMNG30FCO	File Center, open 36"W x 16"D x 22"H	\$319	\$ 319
TOTAL:			\$1,610	

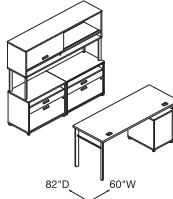

Desk, Credenza Workstation with Overhead Storage
60"W x 82"D

Qty.	Model #	Description	List Price	Price Extension
1	HMNG60WKS	Worksurface 60"W x 23 1/2"D	\$209	\$ 209
2	HMNGDLEG	Desk Leg (single) 2 1/4"W x 23 1/2"D x 28 1/2"H	\$ 88	\$ 176
1	HMNG15PED	Pedestal, P/P/F 15 1/4"W x 21 1/2"D x 22"H	\$364	\$ 364
2	HMNG30FCD	File Center, 2 drawer 30"W x 16"D x 22"H	\$509	\$1,018
1	HMNG60OVRD	Overhead 60"W x 14 1/2"D x 17 1/4"H	\$305	\$ 305
1	HMNGOHLEG	Overhead Leg 1 3/4"W x 14 1/2"D x 16"H	\$111	\$ 111
TOTAL:			\$2,183	

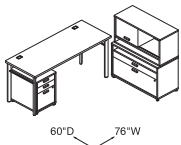

L-Station with Pedestal, Storage and Overhead
76"W x 60"D

Qty.	Model #	Description	List Price	Price Extension
1	HMNG60WKS	Worksurface 60"W x 23 1/2"D	\$209	\$ 209
2	HMNGDLEG	Desk Leg (single) 2 1/4"W x 23 1/2"D x 28 1/2"H	\$ 88	\$ 176
1	HMNG15PED	Pedestal, P/P/F 15 1/4"W x 21 1/2"D x 22"H	\$364	\$ 364
1	HMNG36OVRD	Overhead 36"W x 14 1/2"D x 17 1/4"H	\$221	\$ 221
1	HMNG36FCD	File Center, 2 drawer 36"W x 16"D x 22"H	\$566	\$ 566
TOTAL:			\$1,536	

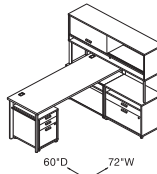

L-Station with Storage and Overhead
72"W x 60"D



Qty.	Model #	Description	List Price	Price Extension
1	HMNG72WKS	Worksurface 72"W x 23 1/2"D	\$242	\$ 242
2	HMNGDLEG	Desk Leg (single) 2 1/4"W x 23 1/2"D x 28 1/2"H	\$ 88	\$ 176
1	HMNG15PED	Pedestal, P/P/F 15 1/4"W x 21 1/2"D x 22"H	\$364	\$ 364
1	HMNG30FCD	File Center, 2 drawer 30"W x 16"D x 22"H	\$509	\$ 509
1	HMNG30FCO	File Center, open 30"W x 16"D x 22"H	\$319	\$ 319
1	HMNG60OVRD	Overhead 60"W x 14 1/2"D x 17 1/4"H	\$305	\$ 305
1	HMNGOHLEG	Overhead Leg 1 3/4"W x 14 1/2"D x 16"H	\$111	\$ 111
TOTAL:			\$2,026	

basyx by HON® Manage® Laminate Desks Worksurfaces

Not on GSA Contract



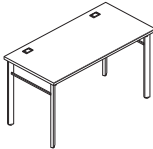
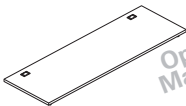
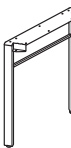









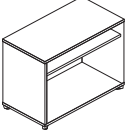



- ▶ Non-handed desk design simplifies ordering and supports both left-handed and right-handed users.
- ▶ Worksurfaces offer 72"W or 60"W options.
- ▶ Two factory-installed steel beams reinforce the worksurface for strength and rigidity.
- ▶ 1" thick desk top provides a sturdy, durable worksurface.
- ▶ Worksurfaces may be supported by two desk legs or one desk leg and the work wall.
- ▶ Durable, thermal-fused laminate is scratch- and spill-resistant.
- ▶ Desk legs have leveling glides to compensate for uneven floors.
- ▶ Divider offers visual privacy and layered storage for the user.
- ▶ Two laminate color options — Wheat (WH) or Chestnut (C1).
- ▶ **basyx by HON® 5-year Limited Warranty.**

	Description	Model	Ship Weight	Cube	List
 <p>Open Market</p>	Table Desk 60"W x 23½"D 48"W x 23½"D NOTES: Two cord management grommets in tops.	HMNG60WKS E♦A HMNG48WKS E♦A	78 59 [S]	7.3 6.0	\$ 372 \$ 357
	 <p>Open Market</p>	Worksurface 72"W x 23½"D 60"W x 23½"D NOTES: Two cord management grommets in tops. ▲ Specify laminate only.	HMNG72WKS HMNG60WKS	57 47 [S]	5.0 4.0
 <p>Open Market</p>	Desk Leg 2¼"W x 23½"D x 28½"H ▲ Specify paint only. SPECIFYING EXAMPLE: HMNGDLEG.A1	HMNGDLEG	14 [S]	2.0	\$ 88
 <p>Open Market</p>	Desk Divider Includes Metal Divider and Laminate Shelf ▲ Available in Ash paint only. Specify laminate only. SPECIFYING EXAMPLE: HMNGDIV.C1	HMNGDIV	11 [S]	1.0	\$ 129

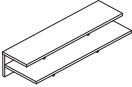
How to specify	1st Option	2nd Option
Select Model Number from above H M N G 6 0 W K S L .	Select Laminate C1 Chestnut WH Wheat Not specified for model HMNGDLEG C 1 .	Select Paint Color A1 Ash Not specified for models HMNG72WKS, HMNG60WKS and HMNGDIV A 1







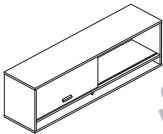

▲ E♦A [S] Icon Legend on page 10

- ▶ Durable, thermal-fused laminate is scratch- and spill-resistant.
- ▶ File Centers with drawers and Pedestals ship fully assembled.
- ▶ Ball-bearing suspensions on drawers provide full extension and smooth, quiet access to documents.
- ▶ Choose from 36"W or 30"W File Centers with two drawers and a top opening or 30"W with one shelf.
- ▶ Pedestals feature two pencil drawers and one file drawer for a variety of storage needs.
- ▶ The Stadium model sits atop a work surface or file center offering layered storage options.
- ▶ **basyx by HON® 5-year Limited Warranty.**

	Description	Model	Ship Weight	Cube	List
 	<p>File Center 36"W x 16"D x 22"H, 2-drawer 30"W x 16"D x 22"H, 2-drawer 30"W x 16"D x 22"H, Open</p> <p>NOTES: File centers with 2-drawers feature inner lock mechanism.</p>	HMNG36FCD	92 	11.0	\$ 566
		HMNG30FCD	80 	10.0	\$ 509
		HMNG30FCO  	50 	3.0	\$ 319
	<p>Pedestals 15 3/4"W x 21"D x 22"H, Pencil/Pencil/File</p> <p>NOTES: Pedestal includes two pencil drawers and a file drawer.</p>	HMNG15PED	69 	7.0	\$ 364
	<p>Stadium 36"W x 12 1/2"D x 7 1/2"H 30"W x 12 1/2"D x 7 1/2"H</p>	HMNG36STDM  	21 	1.0	\$ 127
		HMNG30STDM  	18 	1.0	\$ 116

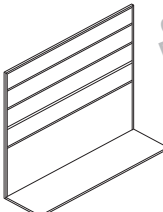
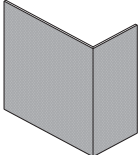
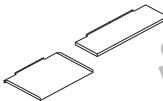
How to specify	1st Option	2nd Option
<p>Select Model Number from above</p> <p>H M N G 3 6 F C D .</p>	<p>Select Laminate</p> <p>C1 Chestnut WH Wheat C 1 .</p>	<p>Select Paint Color</p> <p>A1 Ash A 1 </p>

- ▶ Durable, thermal-fused laminate is scratch- and spill-resistant.
- ▶ 36" Overhead Storage can be used on top of the 36" File Center to create a low profile storage solution.
- ▶ Overheads feature one non-locking sliding door.
- ▶ Work Walls add privacy and can support one end of a worksurface as well as storage accessories.
- ▶ Model HMNGSHTR ships with both shelf and tray.
- ▶ Freestanding Privacy Screen features a durable metal frame, mesh screen and can be configured in either left- or right-hand arrangements.
- ▶ **basyx by HON® 5-year Limited Warranty.**

	Description	Model	Ship Weight	Cube	List
 <p>Open Market</p>	Overhead Storage 60"W x 14½"D x 17¾"H 36"W x 14½"D x 17¾"H Specify: Model.Laminate.Paint SPECIFYING EXAMPLE: HMNG60OVRD.C1.A1	HMNG60OVRD E♦A HMNG36OVRD E♦A	80  60 	5.0 2.0	\$ 305 \$ 221
	 <p>Open Market</p>	Overhead Legs 1¾"W x 14½"D x 16"H NOTES: Overhead legs ship 2/carton. Specify paint only. SPECIFYING EXAMPLE: HMNGOHLEG.A1	HMNGOHLEG	12 	1.0
 <p>Open Market</p>	Work Wall 60"W x 17"D x 50"H Specify: Model.Laminate.Paint SPECIFYING EXAMPLE: HMNGWKWL.C1.A1 NOTES: Not designed to be freestanding. ▲ Work Wall must be installed with one or more file centers for support.	HMNGWKWL E♦A	88	8.0	\$ 542
 <p>Open Market</p>	Freestanding Privacy Screen 49"W x 24½"D x 50"H Specify paint only. SPECIFYING EXAMPLE: HMNGFPS.A1	HMNGFPS E♦A	23	6.0	\$ 404
 <p>Open Market</p>	Work Wall Accessories Work Wall Shelf and Tray Shelf: 17½"W x 5½"D Tray: 13"W x 9"D NOTES: Specify one model—ships with both shelf and tray. Specify paint only. SPECIFYING EXAMPLE: HMNGSHTR.A1	HMNGSHTR	3	1.0	\$ 65
 <p>Open Market</p>	Mesh Modesty Panels 72"W 60"W 48"W ▲ Available in Black Mesh fabric only, no need to specify.	HBMP72MOD HBMP60MOD HBMP48MOD	4  3  2 	0.3 0.3 0.2	\$ 140 \$ 124 \$ 113

How to specify	Select Model Number from above H M N G 6 0 O V R D .	1st Option Select Laminate C1 Chestnut WH Wheat C 1 .	2nd Option Select Paint Color A1 Ash A 1
----------------	--	--	---

How to specify	Select Model Number from above H M N G S H T R .	1st Option Select Paint Color A1 Ash A 1
----------------	--	---

▲ E♦A  Icon Legend on page 10

► STEEL DESKS
 SPECIFY: Model Number.
 Top Laminate
 Paint Color
 EXAMPLE: H38934.NS

► 38000 TACKBOARDS
 (Fabric listed on pages 310-311)
 SPECIFY: Model Number
 Fabric Style.
 Color Code
 Paint Color
 EXAMPLE: HT72.CE18.P

Steel Desks Finishes Availability

			38000 Series™ ④	38000 Stack-on Hutch ④	Mentor® Series ④	Metro Classic Series ④	34000 Series ④
L1 LAMINATES		CODES					
Woodgrain	Bourbon Cherry	H	•		•	•	•
	Cognac	COGN	•		•	•	•
	Harvest	C	•		•	•	•
	Mahogany	N	•		•	•	•
	Mocha	MOCH	•		•	•	•
	Natural Maple	D	•		•	•	•
	Pinnacle	PINC	•				
	Shaker Cherry	F	•		•	•	•
Solid	Black	P	•		•	•	•
	Brilliant White	WHIT	•		•	•	•
	Charcoal	S	•		•	•	•
	Light Gray <input type="checkbox"/>	Q	•		•	•	•
	Loft	LOFT	•		•	•	•
	Whitestone	K4	•		•	•	•
Patterned	Sheer Mesh*	A5	•		•	•	•
	Silver Mesh*	B9	•		•	•	•
	Steel Mesh*	A9	•		•	•	•
	Taupe Mesh*	A8	•		•	•	•
	Canyon Zephyr	K9	•		•	•	•
	Desert Zephyr	K8	•		•	•	•
	Shadow Zephyr	K1	•		•	•	•
	Gray	G2	•		•	•	•
	Grey Tigris	L6	•		•	•	•
	White	G1	•		•	•	•
PAINTS		CODES					
Core	Black	P	•	•	•	•	•
	Charcoal	S	•	•	•	•	•
	Greige	T5	•	•	•	•	•
	Light Gray	Q	•	•	•	•	•
	Loft	LOFT	•	•	•	•	•
	Muslin	T3	•	•	•	•	•
	Putty	L	•	•	•	•	•
	Shadow	SHDW	•	•	•	•	•
Choice/ Metallic	Brilliant White	WHIT	•	•			
	Champagne Metallic	T4	•	•			
	Platinum Metallic	T1	•	•			

* Mesh laminate colors will have the following pre-set edgeband colors:
 Sheer Mesh Muslin
 Silver Mesh Loft
 Steel Mesh Charcoal
 Taupe Mesh Greige

ColorCorrect®
CHOICE COLORS

			38000 Series™ ©	38000 Stack-on Hutch ©	Mentor® Series ©	Metro Classic Series ©	34000 Series ©
PAINTS		CODES					
Haworth®	Beige	D1	•	•			
	Chalk ¹	T3	•	•			
	Charcoal	D2	•	•			
	Graphite	D5	•	•			
	Putty	D6	•	•			
	Sand	D3	•	•			
	Smoke	D7	•	•			
Herman Miller®	Inner Tone	J2	•	•			
	Inner Tone Light	J5	•	•			
	Light Tone	J6	•	•			
	Medium Tone	H8	•	•			
	Slate Gray	H7	•	•			
Knoll®	Jet Black ²	P	•	•			
	Medium Gray	K1	•	•			
	Pumice	K4	•	•			
	Soft Gray	K3	•	•			
	Taupe	K5	•	•			
Steelcase®	Black ³	P	•	•			
	Cream	K6	•	•			
	Grey Value 1	K9	•	•			
	Midnight	K7	•	•			
	Tan Value 1	K8	•	•			

¹ Haworth Chalk is the same as HON Muslin. When ordering this color use the HON Muslin paint code T3.

² Knoll Jet Black is the same as HON Black. When ordering this color use the HON Black paint code P.

³ Steelcase Black is the same as HON Black. When ordering this color use the HON Black paint code P.

NOTES: Choice color selections do not require a customer approval. The colors can be ordered with the HON paint code noted above.

Pricing for eligible product is listed on the individual list pricer pages under the column Choice/Metallic column.

No minimum order is required for Choice Colors.

Refer to page 9 for detailed information on the ColorCorrect® Program.

Custom Paint Colors

Custom Paint Colors require a special request submitted within MyProjects. Refer to page 9 for detailed information regarding Custom Paints.

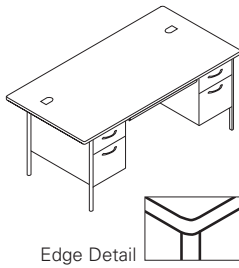

- ▶ Leg available in Chrome.
- ▶ Attractive radius leg design and arched drawer pulls.
- ▶ Legs ship unattached.
- ▶ 3/4 height modesty panels.

- ▶ Rounded edge desk top with soft feel-vinyl edge.
- ▶ Wire management grommets in desk tops and pedestals.
- ▶ Laminate tops are constructed of 1 1/8" thick particleboard.
- ▶ 13 1/2" deep, central locking center drawer equipped with HON "One Key" interchangeable lock cores.

- ▶ High-sided file drawers accept hanging files without hangrails. Spring-loaded follower blocks are standard.
- ▶ 3/4 extension box drawers with one divider provide 20" deep filing capacity.
- ▶ Reinforced double "O" frame inner structure keeps desk solid and sturdy for years of use.

- ▶ 90% extension triple-tied cradles on all file drawers provide 21" deep filing capacity.
 - ▶ Vinyl edge and grommets match specified chassis color.
 - ▶ All interior drawer bodies are gray, pre-painted steel.
- ⚠ **Keyed alike cores must be ordered separately — see page 743.**



	Description	Model	Ship Weight	Cube	List
	Double Pedestal Desk with Center Drawer (6" overhang on 3 sides) — 2/2 72"W x 36"D x 29 1/2"H, Chrome Leg and Pull NOTES: Model H88976 requires Model H38242N 60"W Stack-on as top of desk extends over end panels.	H88976 E◆A	203	37.7	\$1474
	Double Pedestal Desk with Center Drawer — 2/2 60"W x 30"D x 29 1/2"H, Chrome Leg and Pull	H88962 E◆A	178	26.7	\$1221
	Single Pedestal Desk with Center Drawer – Right, box/file 66"W x 30"D x 29 1/2"H, Chrome Leg and Pull	H88265R E◆A	162	29.2	\$1109
	Single Pedestal Desk with Center Drawer – Left, box/file 66"W x 30"D x 29 1/2"H, Chrome Leg and Pull	H88266L E◆A	162	29.2	\$1109
	Single Pedestal Desk with Center Drawer – Right, box/file 60"W x 30"D x 29 1/2"H, Chrome Leg and Pull	H88263R E◆A	145	26.7	\$1053
	Single Pedestal Desk with Center Drawer – Right, box/file 48"W x 30"D x 29 1/2"H, Chrome Leg and Pull	H88251R E◆A	130	21.6	\$ 997

How to specify	1st Option	2nd Option
Select Model Number from above H 8 8 9 7 6 .	Select Laminate See page 283 N .	Select Paint Color See pages 283-284 S

Mentor® Series Steel Desks

GSA SIN 711-2 Except as Noted

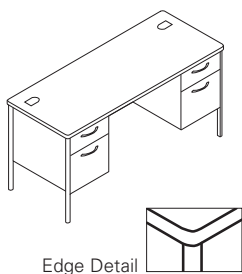

- ▶ Leg available in Chrome.
- ▶ Attractive radius leg design and arched drawer pulls.
- ▶ Legs ship unattached.
- ▶ 3/4 height modesty panels.
- ▶ Rounded edge desk top with soft feel-vinyl edge.
- ▶ Wire management grommets in desk tops and pedestals.
- ▶ Laminate tops are constructed of 1/8" thick particleboard.
- ▶ High-sided file drawers accept hanging files without hangrails. Spring-loaded follower blocks are standard.
- ▶ 3/4 extension box drawers with one divider provide 20" deep filing capacity.
- ▶ Reinforced double "O" frame inner structure keeps desk solid and sturdy for years of use.
- ▶ 90% extension triple-tied cradles on all file drawers provide 21" deep filing capacity.
- ▶ Vinyl edge, grommets and painted leg matches specified chassis color.
- ▶ All interior drawer bodies are gray, pre-painted steel.



	Description	Model	Ship Weight	Cube	List
	Double Pedestal Credenza with Kneespace, box/file (non-locking) 60"W x 24"D x 29½"H, Chrome Leg and Pull	H88231 E♦A	149	21.8	\$1205
	Return, Right, box/file (non-locking) 42"W x 24"D x 29½"H, Chrome Leg and Pull	H88235R E♦A	92	15.5	\$ 774
	Return, Left, box/file (non-locking) 42"W x 24"D x 29½"H, Chrome Leg and Pull	H88236L E♦A	92	15.5	\$ 774
	Articulating Arm with Keyboard Platform	H1706	16 [S]	1.4	\$ 440
	Articulating Arm with Convertible Keyboard Platform	H2107	16 [S]	1.3	\$ 472
	Sit to Stand Arm with Convertible Keyboard Platform	H2516	17 [S]	1.6	\$ 551

Refer to page 749 for additional product information

SIN 711-1, 711-2



SIN 711-1, 711-2

360° Swivel CPU Holder					
<ul style="list-style-type: none"> • Vertically mounts to underside of worksurface. • 360° swivel. • Supports up to 55 lbs. • Height adjustable from 16" to 22" below worksurface. • Width adjustable to accept units from 3¼" to 6". 	HCPU	16 [S]	0.5	\$ 230	
⚠ Silver only					

How to specify	1st Option	2nd Option
Select Model Number from above H 8 8 2 3 1 .	Select Laminate See page 283 N .	Select Paint Color See pages 283-284 S



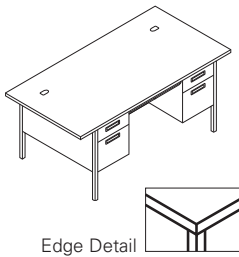

- ▶ Wire grommets in desk and credenza tops accept 38000 Series™ Stack-on Units.
- ▶ 3/4 height modesty panels.
- ▶ Legs shipped unattached.
- ▶ Color of pulls and grommets match paint selection for core colors.
- ▶ “Tru-fit” mitered drawer fronts for better visual alignment.
- ▶ Color of legs match paint selection.
- ▶ Central locking center drawer standard, with HON “One Key” interchangeable lock cores.
- ▶ High-sided file drawers accept hanging files without hangrails. Spring-loaded follower blocks standard.
- ▶ 90% extension triple-tied cradles on all file drawers.
- ▶ 3/4 extension box drawers with one divider standard.
- ▶ Reinforced, double “O” frame inner structure keeps desk solid and sturdy for years of use.
- ▶ All interior drawer bodies are gray pre-painted steel.

⚠ **Keyed alike cores ordered separately — see page 743.**



	Description	Model	Ship Weight	Cube	List
 HP3276	Double Pedestal — 2/2 (locking) 72”W x 36”D x 29½”H (6” overhang on 3 sides) NOTES: HP3276 requires Model H38242N 60”W Stack-on as top of desk extends over end panels.	HP3276 E ⚡	218.0	37.7	\$1446
	60”W x 30”D x 29½”H (Non-Locking, 24”D chassis) (6” overhang on approach side only)	HP3261 E ⚡	165.0	26.7	\$1013
	60”W x 30”D x 29½”H (locking)	HP3262 E ⚡	186.0	26.7	\$1181
 HP3262	Single Pedestal (locking) 66”W x 30”D x 29½”H — 2R 66”W x 30”D x 29½”H — 2L	HP3265R E ⚡	167.0	29.2	\$1090
	48”W x 30”D x 29½”H — 2R	HP3266L E ⚡	167.0	29.2	\$1090
 HP3251R	Return, Right — box/file (non-locking) 42”W x 24”D x 29½”H	HP3235R E ⚡	95.0	15.5	\$ 763
	Return, Left — box/file (non-locking) 42”W x 24”D x 29½”H	HP3236L E ⚡	95.0	15.5	\$ 763
 HP3231	Credenza w/Kneespace — 2/2 (non-locking) 60”W x 24”D x 29½”H Accommodates optional HD2 or HD8 center drawer. NOTES: Non-locking.	HP3231 E ⚡	165.0	21.8	\$1181
	Stack-on Full Clearance w/o doors 66”W x 13½”D x 34¾”H 60”W x 13½”D x 34¾”H 48”W x 13½”D x 34¾”H NOTES: Interior is 12¾”H. Specify: Paint color. For additional 38000 Series™ Stack-on accessory items, see pages 295-296. HP3276 requires Model H386566N 60”W Stack-on as top of desk extends over end panels.	H386566N E ⚡ 68.0 6.3 \$ 753 H386560N E ⚡ 64.0 5.7 \$ 699 H386548N E ⚡ 53.0 4.7 \$ 637			
 SIN 711-1, 711-2	Chrome Leg Packs — Field Installable 4 pk-29½”H	HC14	7.2	0.2	\$ 114
 SIN 711-3	Double-Rail Hanging File Racks — 2 Pack (for side-to-side) ⚠ Gray only	H519495	0.5	0.5	\$ 30

How to specify	1st Option	2nd Option
Select Model Number from above H P 3 2 7 6 .	Select Laminate See page 283 Not specified for models H386566N, H386560N and H386548N N .	Select Paint Color See page 283-284 S

34000 Series Steel Desks

GSA SIN 711-2 Except as Noted

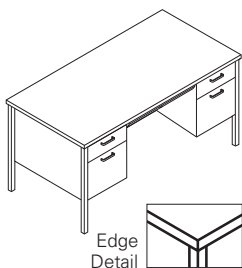

- ▶ "Tru-fit" mitered drawer fronts for better visual alignment.
- ▶ 3/4 height modesty panels.
- ▶ Chrome legs shipped unattached.
- ▶ Laminate tops.
- ▶ Central locking center drawer standard, with HON "One Key" interchangeable lock cores.
- ▶ 90% extension triple-tied cradles on all file drawers.
- ▶ High-sided file drawers accept hanging files without hangrails. Spring-loaded follower blocks standard.
- ▶ 3/4 extension box drawers with one divider standard.
- ▶ Reinforced, double "O" frame inner structure keeps desk solid and sturdy for years of use.
- ▶ All interior drawer bodies are gray, pre-painted steel.

⚠ **Keyed-alike cores ordered separately — see page 743.**



	Description	Model	Ship Weight	Cube	List
	Double Pedestal — 2/2 (locking) 60"W x 30"D x 29½"H	H34962 E♦A	162.0	26.7	\$1117
	Single Pedestal, box/file (locking) 66"W x 30"D x 29½"H, Right 66"W x 30"D x 29½"H, Left 48"W x 30"D x 29½"H, Right 45¼"W x 24"D x 29½"H, Right	H34973R E♦A H34974L E♦A H34251 E♦A H34002R E♦A	161.0 161.0 115.0 83.0	29.2 29.2 21.6 16.6	\$ 965 \$ 965 \$ 851 \$ 728
	Return, Box/File (non-locking) 42"W x 24"D x 29½"H, Right 42"W x 24"D x 29½"H, Left	H34834R E♦A H34835L E♦A	89.0 89.0	15.5 15.5	\$ 640 \$ 640
NOTES: Returns are for use with 66"W Single Pedestal Desks.					
	Credenza with Kneespace — 2/2 (non-locking) 60"W x 24"D x 29½"H ⚠ Not designed to accommodate center drawer.	H34480 E♦A	160.0	21.8	\$1122
	Articulating Arm with Keyboard Platform Articulating Arm with Convertible Keyboard Platform Sit to Stand Arm with Convertible Keyboard Platform	H1706 H2107 H2516	16.0 [S] 16.0 [S] 17.0 [S]	1.4 1.3 1.6	\$ 440 \$ 472 \$ 551
Refer to page 749 for additional product information					
SIN 711-1, 711-2					
	Chrome Leg Packs — Field Installable 4 pk-29½"H	HC14	7.2 [S]	0.2	\$ 114
SIN 711-1, 711-2					
	Double-Rail Hanging File Racks — 2 Pack (for side-to-side) ⚠ Gray only	H519495	0.5	0.5	\$ 30
SIN 711-3					

How to specify	1st Option	2nd Option
Select Model Number from above	Select Laminate	Select Paint Color
See page 283	See page 283	See page 283-284
H 3 4 9 6 2 .	N .	S



Components used are listed on pages 291-296. Order components individually.
Other configurations are possible, including various sizes of some components.

3/4 HEIGHT PEDESTALS

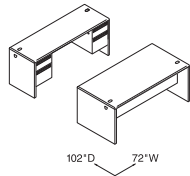

Desk Workstation with Credenza
72\"/>

Qty.	Model #	Description	List Price	Price Extension
1	H38180	Double Pedestal Desk 72\"/>	\$1,693	\$1,693
1	H38854	Credenza with Kneespace 72\"/>	\$1,469	\$1,469
TOTAL:			\$3,162	

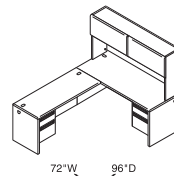

Desk "L" Workstation
72\"/>

Qty.	Model #	Description	List Price	Price Extension
1	H38293R	Single Pedestal Desk 72\"/>	\$1,508	\$1,508
1	H386572N	Stack-on Storage w/o Doors 72 3/4\"/>	\$ 796	\$ 796
1	H38218L	Left, Return, box/file 60\"/>	\$1,001	\$1,001
1	H387215	Flipper Doors 2@36\"/>	\$ 494	\$ 494
TOTAL:			\$3,799	

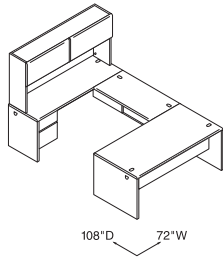

Desk "U" Workstation
72\"/>

Qty.	Model #	Description	List Price	Price Extension
1	H38293R	Single Pedestal Desk 72\"/>	\$1,508	\$1,508
1	H386572N	Stack-on Storage w/o Doors 72 3/4\"/>	\$ 796	\$ 796
1	H38210	Bridge 48\"/>	\$ 506	\$ 506
1	H387215	Flipper Doors 2@36\"/>	\$ 494	\$ 494
1	H38855L	Single Pedestal Credenza 72\"/>	\$1,252	\$1,252
TOTAL:			\$4,556	

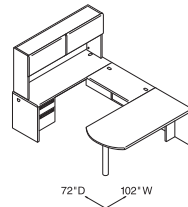

Peninsula "U" Workstation
72\"/>

Qty.	Model #	Description	List Price	Price Extension
1	H38941	Peninsula with Full End Panel 70\"/>	\$1,178	\$1,178
1	H386572N	Stack-on Storage w/o Doors 72 3/4\"/>	\$ 796	\$ 796
1	H38220	Bridge 42\"/>	\$ 482	\$ 482
1	H387215	Flipper Doors 2@36\"/>	\$ 494	\$ 494
1	H38855L	Single Pedestal Credenza, Left 72\"/>	\$1,252	\$1,252
TOTAL:			\$4,202	

38000 Series™ — Typical

Components used are listed on pages 291-296. Order components individually.
Other configurations are possible, including various sizes of some components.

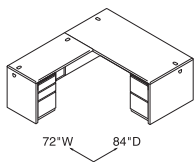

Modular Desk Workstation
84\"/>

Qty.	Model #	Description	List Price	Price Extension
1	H38934	Shell Desk 72\"/>	\$1,026	\$1,026
1	H18823R	Flagship Mobile Pedestal – file/file 15\"/>	\$ 658	\$ 658
1	H38944L	Return Shell, Left 48\"/>	\$ 714	\$ 714
1	H18717R	Standard Height Mobile Pedestal – box/box/file 15\"/>	\$ 612	\$ 612
TOTAL:			\$3,010	

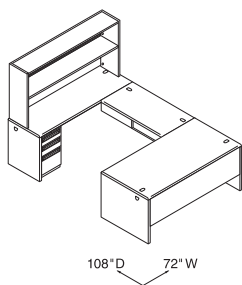

Modular Desk \"U\" Workstation
72\"/>

Qty.	Model #	Description	List Price	Price Extension
1	H38934	Shell Desk 72\"/>	\$1,026	\$1,026
1	H18823R	Flagship Mobile Pedestal – file/file 15\"/>	\$ 658	\$ 658
1	H38210	Bridge 48\"/>	\$ 506	\$ 506
1	H38925	Shell Desk 72\"/>	\$ 993	\$ 993
1	H18717R	Standard Height Mobile Pedestal – box/box/file 15\"/>	\$ 612	\$ 612
1	H386572N	Stack-on Storage w/o Doors 72\"/>	\$ 796	\$ 796
TOTAL:			\$4,591	

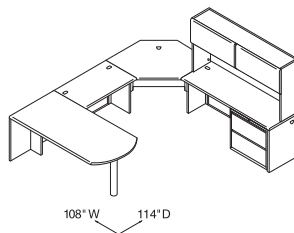

Peninsula \"U\" Workstation
108\"/>

Qty.	Model #	Description	List Price	Price Extension
1	H38928	Corner Unit	\$1,152	\$1,152
1	H38941	Peninsula with End Panel 70\"/>	\$1,178	\$1,178
1	H38220	Bridge 42\"/>	\$ 482	\$ 482
1	H38947R	Shell Return, Right 72\"/>	\$ 951	\$ 951
1	H9170R	Flagship Lateral File 30\"/>	\$ 847	\$ 847
1	H386572N	Stack-on Storage w/o Doors 72\"/>	\$ 796	\$ 796
1	H387215	Flipper Doors 2@36\"/>	\$ 494	\$ 494
TOTAL:			\$5,900	

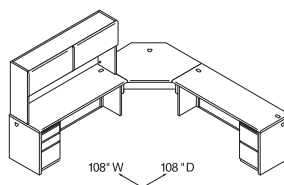

Corner Unit with Returns Workstation
108\"/>

Qty.	Model #	Description	List Price	Price Extension
1	H38928	Corner Unit	\$1,152	\$1,152
1	H38948L	Shell Return, Left 72\"/>	\$ 951	\$ 951
1	H18717R	Standard Height Mobile Pedestal – box/box/file 15\"/>	\$ 612	\$ 612
1	H386572N	Stack-on Storage w/o Doors 72\"/>	\$ 796	\$ 796
1	H387215	Flipper Doors 2@36\"/>	\$ 494	\$ 494
1	H38947R	Shell Return – Right 72\"/>	\$ 951	\$ 951
1	H18817R	Standard Height Mobile Pedestal – file/file 15\"/>	\$ 612	\$ 612
TOTAL:			\$5,568	

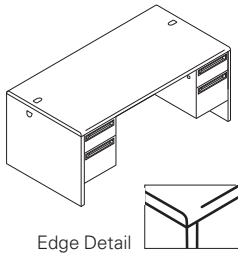

- ▶ 3/4 height modesty panels unless noted.
- ▶ Color of pulls and grommets match paint selection for core colors.
- ▶ One pencil tray standard per unit except returns.
- ▶ Laminate particleboard tops feature attractive, radius edges on front and rear edges of desks. Returns and bridges have radius front and flat rear edge to match the side edge it attaches to.
- ▶ Wire grommets standard in all tops.
- ▶ Wire grommets in end panels allow cable connections between desks.
- ▶ "Tru-fit" mitered drawer fronts for better visual alignment.
- ▶ Optional center drawer features steel ball-bearing suspension.
- ▶ High-sided file drawers accept hanging files without hangrails.
- ▶ Spring-loaded follower blocks standard.
- ▶ Three-part full extension steel ball-bearing suspension on all file drawers for full access to interior contents.
- ▶ Box drawers feature two-part, 3/4" extension steel ball-bearing suspension.
- ▶ Baked enamel finish over rust-inhibiting phosphate pre-treatment.



	Description	Full Width Overhang	Model	Ship Weight	Cube	List by Paint Grade		
						Core	Metallics	Custom
	Double Pedestal — 2/2 w/Locks							
	72"W x 36"D x 29½"H — 2R	6"	H38180	256	51.7	\$1693	\$1767	\$1838
	66"W x 30"D x 29½"H		H38170	224	40.1	\$1620	\$1694	\$1765
	60"W x 30"D x 29½"H		H38155	217	36.6	\$1447	\$1521	\$1592
	Single Pedestal w/Lock							
	72"W x 36"D x 29½"H — 2R	6"	H38293R	214	51.7	\$1508	\$1582	\$1653
	66"W x 30"D x 29½"H — 2R		H38291R	181	40.1	\$1390	\$1464	\$1535
	48"W x 30"D x 29½"H — 2R		H38251	155	29.6	\$1230	\$1304	\$1375
	72"W x 36"D x 29½"H — 2L	6"	H38294L	214	51.7	\$1508	\$1582	\$1653
	66"W x 30"D x 29½"H — 2L		H38292L	181	40.1	\$1390	\$1464	\$1535
	48"W x 30"D x 29½"H — 2L		H38252L	155	29.6	\$1230	\$1304	\$1375
	Flush Return — box/file w/Lock							
	60"W x 24"D x 29½"H — 2R		H38217R	138	30.1	\$1001	\$1046	\$1090
	48"W x 24"D x 29½"H — 2R		H38215R	124	24.1	\$ 912	\$ 957	\$1001
	60"W x 24"D x 29½"H — 2L		H38218L	138	30.1	\$1001	\$1046	\$1090
	48"W x 24"D x 29½"H — 2L		H38216L	124	24.1	\$ 912	\$ 957	\$1001
NOTES: Returns have 2 grommets each in worksurface top and full height modesty panel.								
	Credenza w/Doors w/Locks							
72"W x 24"D x 29½"H		H38853	230	35.6	\$1597	\$1671	\$1742	
NOTES: Pedestals lock.								
	Credenza w/Kneespace w/Locks							
	72"W x 24"D x 29½"H		H38854	172	35.6	\$1469	\$1543	\$1614
	Kneespace: 39¾"W							
	66"W x 24"D x 29½"H		H38851	166	32.7	\$1437	\$1511	\$1582
	Kneespace: 33¾"W							
	60"W x 24"D x 29½"H		H38852	154	29.8	\$1412	\$1486	\$1557
	Kneespace: 27¾"W							
NOTES: Pedestals lock.								
	Single Pedestal Credenza — 2R w/Lock							
	72"W x 24"D x 29½"H		H38856R	159	35.6	\$1252	\$1326	\$1397
	66"W x 24"D x 29½"H		H38858R	153	32.7	\$1161	\$1235	\$1306
NOTES: Pedestal locks.								
	Single Pedestal Credenza — 2L w/Lock							
	72"W x 24"D x 29½"H		H38855L	159	35.6	\$1252	\$1326	\$1397
	66"W x 24"D x 29½"H		H38857L	153	32.7	\$1161	\$1235	\$1306
NOTES: Pedestal locks.								

NOTE: See page 293 for 38000 Series™ shared components.

How to specify	1st Option	2nd Option
Select Model Number from above	Select Laminate	Select Paint Color
See page 283	See page 283	See pages 283-284
H 3 8 1 8 0 .	N .	S

38000 Series™ Modular Desks

GSA SIN 711-2

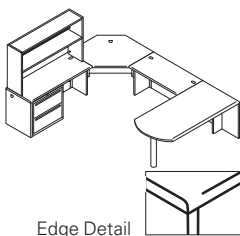

- ▶ 38000 Series™ Modular Desks offers designer styling, configuration flexibility and storage versatility.
- ▶ Create both individual managerial stations and task-oriented work areas.

- ▶ Designed with adaptability for today's electronic office.
- ▶ Color of pulls and grommets match paint selection for core colors.
- ▶ Wire grommets standard in all tops, except peninsulas.

- ▶ Wire grommets in end panels allow cable connections between desks.
- ▶ Optional center drawer features steel ball-bearing suspension.

- ▶ For components that can be shared with 38000 Series™, see page 293.
- ▶ 3/4 height modesty panels unless noted.

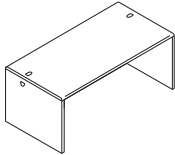

List by Paint Grade

Description	Inside Shell Dimensions	Full Width Overhang	Model	Ship Weight	Cube	Choice/		
						Core	Metallics	Custom
 Desk Shell 72"W x 36"D x 29½"H 72"W x 30"D x 29½"H 66"W x 30"D x 29½"H 60"W x 30"D x 29½"H 48"W x 30"D x 29½"H 72"W x 24"D x 29½"H 66"W x 24"D x 29½"H 60"W x 24"D x 29½"H 48"W x 24"D x 29½"H	69½" W x 28¾"D	6"	H38934 E⚡	134	7.1	\$1026	\$1100	\$1171
	69½" W x 28¾"D		H38935 E⚡	118	6.0	\$ 998	\$1072	\$1143
	63½" W x 28¾"D		H38933 E⚡	108	6.0	\$ 983	\$1057	\$1128
	57½" W x 28¾"D		H38932 E⚡	103	5.1	\$ 934	\$1008	\$1079
	45½" W x 28¾"D		H38931 E⚡	89	5.1	\$ 864	\$ 938	\$1009
	69½" W x 22¾"D		H38925 E⚡	99	5.0	\$ 993	\$1067	\$1138
	63½" W x 22¾"D		H38923 E⚡	95	5.0	\$ 949	\$1023	\$1094
	57½" W x 22¾"D		H38922 E⚡	89	4.2	\$ 902	\$ 976	\$1047
	45½" W x 22¾"D		H38921 E⚡	83	4.2	\$ 845	\$ 919	\$ 990

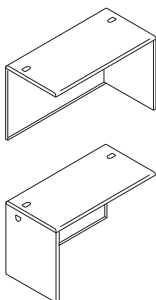

Return

- 72"W x 24"D x 29½"H, Right
- 60"W x 24"D x 29½"H, Right
- 48"W x 24"D x 29½"H, Right
- 42"W x 24"D x 29½"H, Right
- 72"W x 24"D x 29½"H, Left
- 60"W x 24"D x 29½"H, Left
- 48"W x 24"D x 29½"H, Left
- 42"W x 24"D x 29½"H, Left

- 69½"W x 22¾"D (2 grommets)
- 57½"W x 22¾"D (2 grommets)
- 45½"W x 22¾"D (2 grommets)
- 39½"W x 22¾"D (2 grommets)
- 69½"W x 22¾"D (2 grommets)
- 57½"W x 22¾"D (2 grommets)
- 45½"W x 22¾"D (2 grommets)
- 39½"W x 22¾"D (2 grommets)

- H38947R E⚡ 87 6.0 \$ 951 \$ 996 \$1040
- H38945R E⚡ 80 5.1 \$ 853 \$ 898 \$ 942
- H38943R E⚡ 71 4.2 \$ 714 \$ 759 \$ 803
- H38949R E⚡ 65 4.2 \$ 665 \$ 710 \$ 754
- H38948L E⚡ 87 6.0 \$ 951 \$ 996 \$1040
- H38946L E⚡ 80 5.1 \$ 853 \$ 898 \$ 942
- H38944L E⚡ 71 4.2 \$ 714 \$ 759 \$ 803
- H38950L E⚡ 65 4.2 \$ 665 \$ 710 \$ 754

NOTES: Modular returns feature full height modesty panels.

⚠ **Not designed to be used freestanding.**

Recommended Pedestal Options:

38000 Series™	36" Deep Desk			30" Deep Desk			24" Deep Desk		
	Ability to Attach	Ability to Use Wire Port	Ability to Attach Hutch	Ability to Attach	Ability to Use Wire Port	Ability to Attach Hutch	Ability to Attach	Ability to Use Wire Port	Ability to Attach Hutch
Contain®, Flagship® or Brigade™ Pedestals									
16¼"D Hanging Pedestal	•	•	•	•	•	•	•	•	•
22¼"D Hanging Pedestal	•	•	•	•	•	•	•	•	•
16¼"D Freestanding or Mobile	•	•	•	•	•	•	•	•	•
22¼"D Freestanding or Mobile	•	•	•	•	•	•	•	•	•
28¼"D Freestanding or Mobile	•	•	•	•	•	•	•	•	•

Use of a pedestal spacer or 28"H standard height pedestals will block wire access from the grommet to the kneespace area.

NOTES: Stack-on units can be attached regardless of pedestal configuration.

Personalize Your Storage Needs With These Possible Solutions:

Use coordinating HON components such as Pedestals shown on page 466 and Lateral Files shown on pages 468-469 and 437-442.

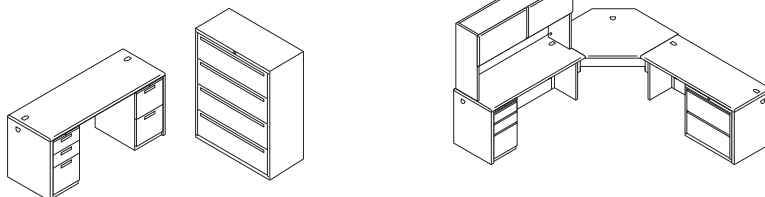

NOTE: Ability to use all HON laterals and pedestals.

NOTE: See page 293 for shared components.

How to specify	1st Option	2nd Option
Select Model Number from above	Select Laminate	Select Paint Color
See page 283	See page 283	See pages 283-284
H 3 8 9 3 4 .	N .	S







▶ Full end panel legs have neat, contemporary appearance.
▶ 3/4 height modesty panels unless noted.

▶ Our broadest selection of components, including components for "U" and "L" workstation arrangements.

▶ All worksurfaces shown are particleboard.

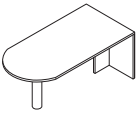
▶ Color of grommets match paint selection for core colors.

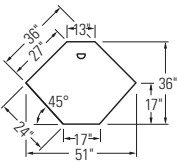
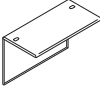

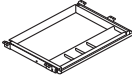
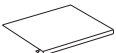
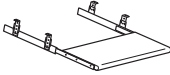
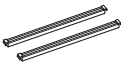
Description	Model	Ship Weight	Cube	List by Paint Grade		
				Core	Choice/Metallics	Custom
 <p>Peninsula with Support Column and End Panel 70"W x 36"D x 29½"H 70"W x 30"D x 29½"H 66"W x 30"D x 29½"H</p> <p>NOTES: Use to create "L" configuration with a Return or "U" configuration with a Bridge and Credenza, Desk or Corner Unit. ⚠ Not designed to be used freestanding.</p>	<p>H38941 E♦A H38942 E♦A H38966 E♦A</p>	<p>136.0 130.0 117.0</p>	<p>15.5 13.2 13.2</p>	<p>\$1178 \$1119 \$1088</p>	<p>\$1223 \$1164 \$1133</p>	<p>\$1267 \$1208 \$1177</p>
 <p>Corner Unit 24" x 36" x 24" x 29½"H Leading edge is 17"W; leading edge to rear edge is 36"D.</p> <p>⚠ Designed to be used with Returns or Bridges.</p> 	H38928 E♦A	85.0	7.4	\$1152	\$1226	\$1297
 <p>Bridge 48"W x 24"D x 29½"H 42"W x 24"D x 29½"H</p> <p>NOTES: Full height modesty panel.</p>	<p>H38210 E♦A H38220 E♦A</p>	<p>54.0 [S] 50.0 [S]</p>	<p>4.2 4.2</p>	<p>\$ 506 \$ 482</p>	<p>\$ 524 \$ 500</p>	<p>\$ 539 \$ 515</p>
 <p>Metal Center Drawers with core removable locks 24¾"W x 14¾"D for H38180, H38170, H38155 19"W x 14¾"D for H38293R, H38294L, H38291R, H38292L</p> <p>Specify: Paint color.</p> <p>Refer to page 751</p>	<p>HD8 HD2</p>	<p>12.0 [S] 9.0 [S]</p>	<p>1.2 1.0</p>	<p>\$ 227 \$ 227</p>	<p>\$ 237 \$ 237</p>	<p>\$ 245 \$ 245</p>
 <p>Polymer Center Drawer</p> <ul style="list-style-type: none"> • Color: Black. • Material: ABS. • Opening Requirements: 23"W x 16¼"D x 2"H. • Retracts on 16" ball bearing slides. • Can be used on worksurfaces with Coordinate™ and basyx by HON® Height Adjustable Bases as long as it is attached with spacer model HKBS. • Can store up to 25 lbs. <p>⚠ Black finish only, no specification needed.</p> <p>Open Market</p>	HCD1	7.0	0.5	\$ 96		
 <p>Corner Sleeve — Square Edge 22½" leading edge x 18"D</p> <p>Specify: Paint color.</p> <p>Refer to page 744</p>	H51206	10.0 [S]	1.5	\$ 138	\$ 148	\$ 155
 <p>Slide-Away Keyboard Platform (Specify: Laminate) Metal Keyboard and Mouse Tray (Specify paint) Metal Keyboard Tray (Specify paint)</p> <p>Refer to page 750 for additional product information</p>	<p>H4022 H4028 H4029</p>	<p>10.0 [S] 11.0 [S] 11.0 [S]</p>	<p>0.6 1.5 1.5</p>	<p>\$ 194 \$ 140 \$ 125</p>	<p> \$ 150 \$ 135</p>	
 <p>Double-Rail Hanging File Racks — 2 Pack (for side-to-side)</p> <p>SIN 711-3</p>	H519495	0.5	0.5	\$ 30		

NOTE: 38000 Series™ Stack-on units and accessories listed on pages 293-296.

How to specify	1st Option	2nd Option
<p>Select Model Number from above</p> <p>H 3 8 9 4 1 .</p>	<p>Select Laminate</p> <p>See page 283</p> <p>N .</p>	<p>Select Paint Color</p> <p>See pages 283-284</p> <p>S </p>







AB, Level, Icon Legend on page 10

38000 Series™ Shared Components and Accessories

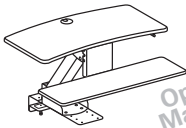
Not on GSA Contract

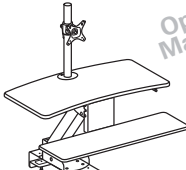
HON

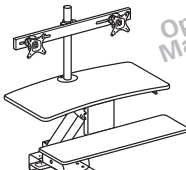
- ▶ These products are designed to allow the user to transition from seating position to standing position throughout the workday.
 - ▶ Gas-assist lever-operated mechanism with positive stop.
 - ▶ Clamp mount compatible with worksurfaces depths of 20"-30".
 - ▶ Clamp requires 3.5" of clearance along back edge of worksurface.
 - ▶ Black seamless worksurfaces.
 - ▶ Silver powder coated metal components.
 - ▶ Lowers below worksurface level on 24" and 30"D worksurfaces.
 - ▶ All models contain a large primary worksurface and a smaller keyboard / mouse surface.
 - ▶ Beveled edges for sleek appearance and comfort while typing.
 - ▶ Monitor arms include height, width, and swivel adjustment.
- ⚠ **Not recommended for use on mobile (castered) worksurfaces.**

	Description	Model	Ship Weight	Cube	List
	Directional™ Desktop Sit-to-Stand Device NOTES: Does not include a monitor arm and is suitable for laptops and/or monitors on their original stands.	HS1100	60 	3.2	\$ 525
	Directional™ Desktop Sit-to-Stand Device with Single Monitor Arm NOTES: Includes a monitor arm for a single monitor.	HS1101	62 	3.2	\$ 615
	Directional™ Desktop Sit-to-Stand Device with Dual Monitor Arm NOTES: Includes a monitor arm for dual monitors.	HS1102	63 	3.2	\$ 700

Mounting and Compatibility:

- This product is intended to be installed on commercial-grade worksurfaces in good condition.
- Compatible with freestanding worksurfaces 24"-30"D or panel-supported worksurfaces 24"-30"D.
- Not for use on mobile worksurfaces.

Clamp Mount

Use when 3.5" minimum overhang is available

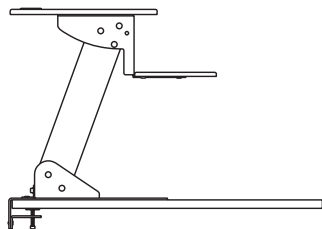
**Screw Mount**

Use when no overhang is available. Worksurface must be minimum 1" thick.

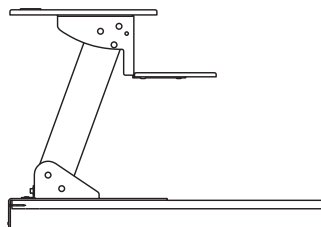

How to specify

Select Model Number
from above

H S 1 1 0 0

⚠  Icon Legend on page 10

- ▶ Flipper doors are standard with a core removable lock located on the underside of stack-on shelf.
- ▶ Many Stack-on sizes available, from 48" to 72" wide.

- ▶ Equipped with HON "One Key" interchangeable core removable locks.
- ▶ Stack-on units attach to worksurface with double stick tape or with screws provided.

- ▶ Stack-ons also compatible with Abode™, Mentor®, Metro Classic, and 66000 Series Computer Furniture.
- ▶ Cabinet/door combination kits available for field installation.

- ▶ Two dividers standard with every stack-on.
- ▶ Color of grommets match paint selection for core colors.

- ⚠ **Keyed alike cores must be ordered separately — see page 743.**
- ⚠ **Stack-on Units not designed to be used on Corner Units.**

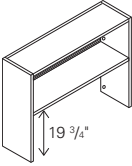

Description	Model	Ship Weight	Cube	List by Paint Grade		
				Core	Choice/Metallics	Custom
 <p>Stack-on Full Clearance w/o doors 72"W x 13 1/2"D x 34 3/4"H 66"W x 13 1/2"D x 34 3/4"H 60"W x 13 1/2"D x 34 3/4"H 48"W x 13 1/2"D x 34 3/4"H</p> <p>Specify: Paint color. NOTES: Interior is 12 3/4"H.</p>	H386572N E-4A	72	6.8	\$ 796	\$ 847	\$ 896
	H386566N E-4A	68	6.3	\$ 753	\$ 804	\$ 853
	H386560N E-4A	64	5.7	\$ 699	\$ 750	\$ 799
	H386548N E-4A	53	4.7	\$ 637	\$ 688	\$ 737

How to specify	<p>Select Model Number from above</p> <p>H 3 8 6 5 7 2 N .</p>	<p>1st Option</p> <p>Select Paint Color</p> <p>See pages 283-284</p> <p>P </p>
----------------	--	---

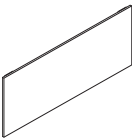
Description	Model	Ship Weight	Cube	List by Paint Grade		
				Core	Choice/Metallics	Custom
 <p>Front Flipper Doors 2 @ 36"W x 15"H, Flipper Doors for 72"W Stack-on 2 @ 33"W x 15"H, Flipper Doors for 66"W Stack-on 2 @ 30"W x 15"H, Flipper Doors for 60"W Stack-on 1 @ 48"W x 15"H, Flipper Door for 48"W Stack-on</p> <p>Specify: Paint color.</p>	H387215	19	0.9	\$ 494	\$ 512	\$ 538
	H386615	17	0.9	\$ 483	\$ 501	\$ 527
	H386015	16	0.9	\$ 468	\$ 486	\$ 512
	H384815	12	0.5	\$ 283	\$ 301	\$ 327

How to specify	<p>Select Model Number from above</p> <p>H 3 8 7 2 1 5 .</p>	<p>1st Option</p> <p>Select Lock Option</p> <p>L Lock X Omit Lock (deduct \$20) See page 743 for omit lock ordering instructions</p> <p>L .</p>	<p>2nd Option</p> <p>Select Paint Color</p> <p>See pages 283-284</p> <p>P </p>
----------------	--	---	---



38000 Series™ Steel Stack-on Units

GSA SIN as Noted



- ▶ See specifying information below for Choice/Metallic paint and pages 9, 283 and 284 for Custom Paint ordering instructions.
- ▶ Tackboards feature painted steel backs and can be installed in the field.





Description	Model	Ship Weight	Cube	List by Paint Grade		
				Core	Choice/Metallics	Custom
 Shelf Dividers — package of 6 Specify: Paint color. Shelf dividers can only be used on stack-ons manufactured after 7/3/2000.	H38SHFDV	3 	0.2	\$ 128	\$ 139	\$ 147

SIN 711-3

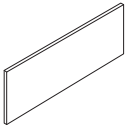
How to specify	Select Model Number from above H 3 8 S H F D V .	1st Option Select Paint Color See pages 283-284 P
----------------	---	---

Description	Model	Ship Weight		
		Weight	Cube	List
 Tackboard for Stack-on — 19 ³ / ₈ "H 72"W 66"W 60"W 48"W	HT72ND HT66ND HT60ND HT48ND	26.0 24.0 22.0 18.0	2.3 2.1 1.9 1.5	\$ 451 \$ 434 \$ 420 \$ 374

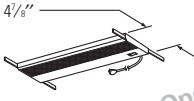
SIN 711-2









 Recessed Task Light for use under 72", 66" and 60"W Stack-on or Open Shelf 46 ¹ / ₂ "W x 3 ¹ / ₁₆ "D x 1 ¹ / ₈ "H	HH870960	12.0 	1.1	\$ 240
---	-----------------	--	-----	--------

Refer to page 376

Open Market

 Task Desk Lamp	HLED2	0.7 	3.0	\$ 303
--	--------------	---	-----	--------

SIN 711-1

 LED Task Lights 17" LED Light with Power Supply (Single) 31" LED Light with Power Supply (Single)	HLED17AS HLED31AS	1.2  1.5 	0.05 0.09	\$ 374 \$ 503
17" LED Light with Power Supply for Daisy-chain (Starter) 31" LED Light with Power Supply for Daisy-chain (Starter)	HLED17A HLED31A	1.0  1.4 	0.05 0.09	\$ 411 \$ 553
17" LED Light with 8" Jumper Cord for Daisy-chain (Follower) 31" LED Light with 8" Jumper Cord for Daisy-chain (Follower)	HLED17AUO HLED31AUO	1.0  1.0 	0.03 0.05	\$ 335 \$ 448
Undercabinet Occupancy Sensor with 1" End to End Connector	HLEDOSA	0.2 	0.01	\$ 78

NOTES: To use the daisy chain application, must start with model HLED17A or HLED31A. No finish specification required. Attaches magnetically to underside of overhead storage, or attaches with provided screws or double-sided tape. Occupancy sensor attaches to a single or starter LED light and will automatically turn the light off after no motion is detected for 30 minutes. Just like all the LED light models, the occupancy sensor features a soft-touch on/off switch. LED task lights have a lifetime of 50,000 hours and have a dimmer feature that allows the user to adjust the amount of light output.

How to specify	Select Model Number from above H T 7 2 N D .	1st Option Select Fabric Color See pages 310-311 A P N 1 5 .	2nd Option Select Paint Color See pages 283-284 P
----------------	---	--	---

Icon Legend on page 10

Finishes Availability

			Systems Worksurfaces	Abode™ Components
L1 LAMINATES		CODES		
Woodgrain	Bourbon Cherry	H	•	
	Cognac	COGN	•	
	Harvest	C	•	
	Mahogany	N	•	
	Mocha	MOCH	•	
	Natural Maple	D	•	
	Pinnacle	PINC	•	
	Shaker Cherry	F	•	
	Brilliant White	WHIT	•	
	Whitestone	K4	•	
Patterned	Sheer Mesh	A5	•	
	Silver Mesh	B9	•	
	Steel Mesh	A9	•	
	Taupe Mesh	A8	•	
	Canyon Zephyr	K9	•	
	Desert Zephyr	K8	•	
	Shadow Zephyr	K1	•	
	Gray	G2	•	
	Grey Tigris	L6	•	
	White	G1	•	
L2 LAMINATES		CODES		
Woodgrain	Lowell Ash <i>NEW! 1/30/2017</i>	LLA1	•	
	Natural Recon <i>NEW! 1/30/2017</i>	LNR1	•	
	Phantom Ecu <i>NEW! 1/30/2017</i>	LPE1	•	
	Portico Teak <i>NEW! 1/30/2017</i>	LPT1	•	
	Skyline Walnut <i>NEW! 1/30/2017</i>	LSW1	•	
PAINTS / GROMMETS		CODES		
Core	Black	P	•	•
	Charcoal	S	•	•
	Greige	T5	•	•
	Light Gray	Q	•	•
	Loft	LOFT	•	•
	Muslin	T3	•	•
	Putty	L	•	•
	Shadow	SHDW	•	•
Metallic	Brilliant White	WHIT	•	•
	Champagne Metallic	T4	•	•
	Platinum Metallic	T1	•	•
T-MOLD		CODES		
	Black	P	•	
	Brilliant White	WHIT	•	
	Charcoal	S	•	
	Greige	R	•	
	Light Gray	Q	•	
	Loft	LOFT	•	
	Muslin	T	•	
	Platinum	K	•	
	Shadow	SHDW	•	
	EDGE BAND		CODES	
	Black	P	•	
	Bourbon Cherry	H	•	
	Brilliant White	WHIT	•	
	Charcoal	S	•	
	Cognac	COGN	•	
	Greige	R	•	
	Harvest	C	•	
	Light Gray	Q	•	
	Loft	LOFT	•	
	Lowell Ash <i>NEW! 1/30/2017</i>	DL	•	
	Mahogany	N	•	
	Mocha	MOCH	•	
	Muslin	T	•	
	Natural Maple	D	•	
	Natural Recon <i>NEW! 1/30/2017</i>	NR	•	
	Phantom Ecu <i>NEW! 1/30/2017</i>	PE	•	
	Pinnacle	PINC	•	
	Platinum	K	•	
	Portico Teak <i>NEW! 1/30/2017</i>	DP	•	
	Shadow	SHDW	•	
	Shaker Cherry	F	•	
	Skyline Walnut <i>NEW! 1/30/2017</i>	SW	•	

- ▶ LAMINATE TOPS
SPECIFY: Model Number.
Laminate
Edge Color
Grommet Color
EXAMPLE: HWR2424PK8.R.T5
- ▶ PAINTED PRODUCTS
SPECIFY: Model Number.
Paint Color
EXAMPLE: HRVSHV24.T1

Edge Treatments



"T" Thin T-Mold

"P" Edgeband

(Color must be selected.)

WORKING WITH ABODE™ COMPONENTS

Configurations

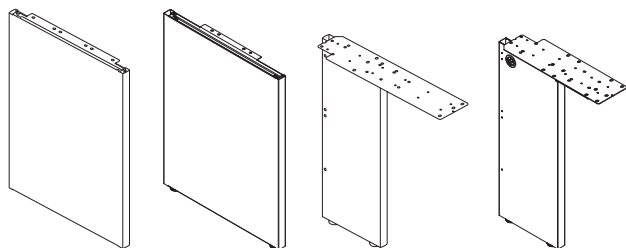

End Panels and Support Legs

Each are available in two options: freestanding or panel-mount. The only difference between the two options are the panel-mount models come with a left- or right-handed bracket to attach the support to a panel in a systems application.

The 11"D end panel is used to support peninsulas.

Corner Desk Legs

Corner desk legs have a 90-degree bend and welded construction. The strong construction allows gussets or half-height modesty panels to be used with corner legs.

Bridge Kits

Bridge kits include: two flat brackets, two modesty panel-to-end panel attachment brackets, and two tie straps. This kit is used when attaching a bridge unit between two rectangular worksurfaces.

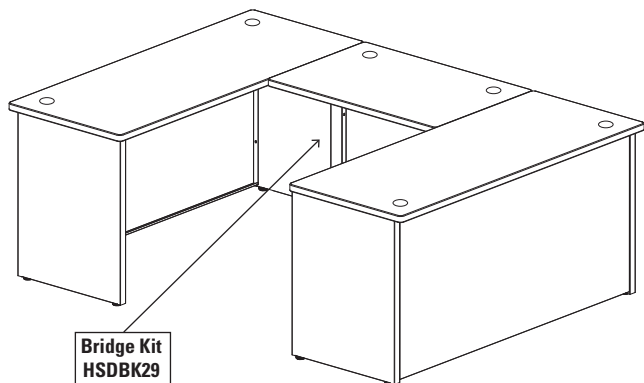

There are some bridge instances where only half of a bridge kit is needed (e.g., using a bridge between a rectangular worksurface and a corner or peninsula). A return kit may be ordered for these instances.

Support Column

Support columns are used to support one end of curvilinear worksurfaces. Includes column, worksurface bracket kit HWSA2, attaching hardware, and adjustable glides.

Return Kits

Return kits include: one flat bracket, one modesty panel-to-end panel attachment bracket, and one tie strap. These are used when attaching a return to a primary desk. Return kits can also be used in some bridge applications — one example is shown below when using a peninsula.

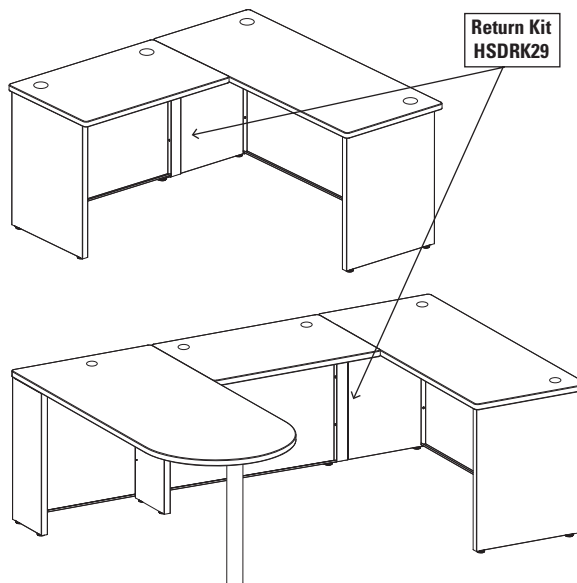

Desk-to-Panel Attachment Kits

Desk-to-panel attachment kits are used to connect a worksurface and modesty panel perpendicular to a panel of corresponding width. Opposing end of worksurface must be attached with an end panel, support leg, or corner leg mounted directly under this worksurface.

When using a corner or corner cove worksurface with the rear corner attached to a panel, and opposing end of worksurface is attached to a freestanding desk, use corner w/desk attachment kit. Hand of unit is determined from the user's side of the desk (right-hand unit attaches to right side of modesty).

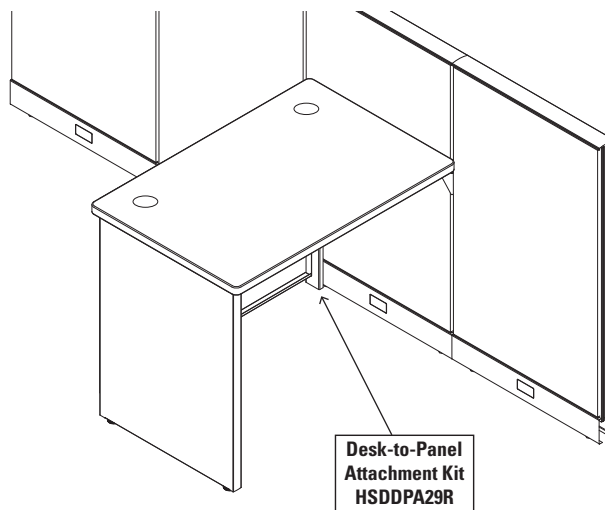

Corner w/Desk Panel Attachment Kit

Corner w/desk panel attachment kit connects the rear corner of a corner or corner cove worksurface and modesty panel to a panel when the opposing end of the worksurface shares a support leg with an adjacent freestanding desk and the support leg is mounted under the freestanding desk. Hand of unit is determined from the user's side of the desk (left-hand unit attaches to left side of modesty).

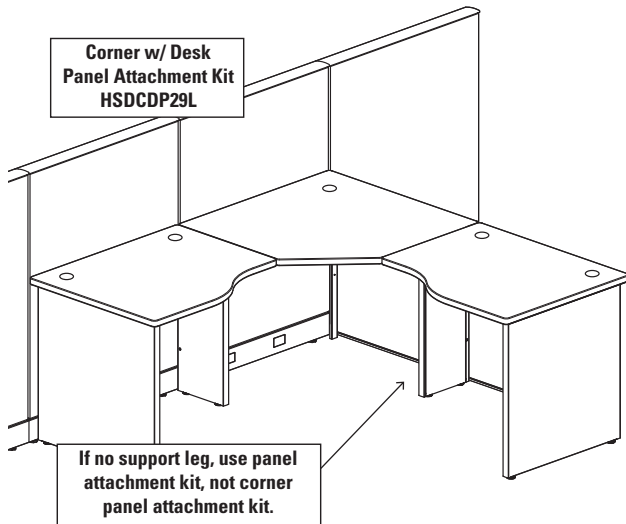

Corner Worksurfaces

Corner worksurfaces accommodate 90-degree corner desk legs.

In-Line Connections of Desks

Shared leg can be used in in-line connections to support adjacent rectangular desks.

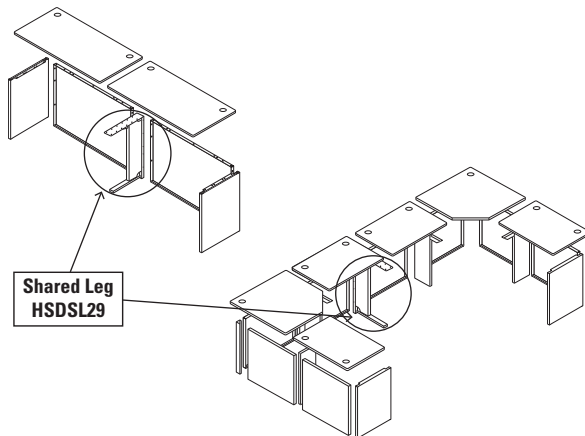

Pedestals and Storage

Pedestals must be ordered smaller than the depth of the worksurface. For example, 20"D peds should be used with 24"D worksurfaces. 20"D or 23"D pedestals can be used with 30"D worksurfaces. Using 18"D laterals or personal files provide additional storage options under 24"D worksurfaces.

Modesty Panels

The following are some general guidelines for Abode™ modesty panels:

- **Desk:** Modesty panel width is the same width as the worksurface
- **Return:** Modesty panel width is 6" greater than the width of the worksurface
- **Bridge connecting two rectangular worksurfaces:** Modesty panel width is 12" greater than the width of the bridge worksurface
- **Bridge connecting a rectangular worksurface and corner or peninsula:** Modesty panel width is 6" greater than the width of the worksurface
- **Corner connecting to an adjacent worksurface:** Modesty panel width is the same width as the worksurface.

Stand-Alone Corner Modesty Panels

Stand-alone corner modesty panels are used only when one or both sides of a corner or corner cove worksurface are freestanding and NOT attached to another worksurface. Specify the width the same as the width of the worksurface.

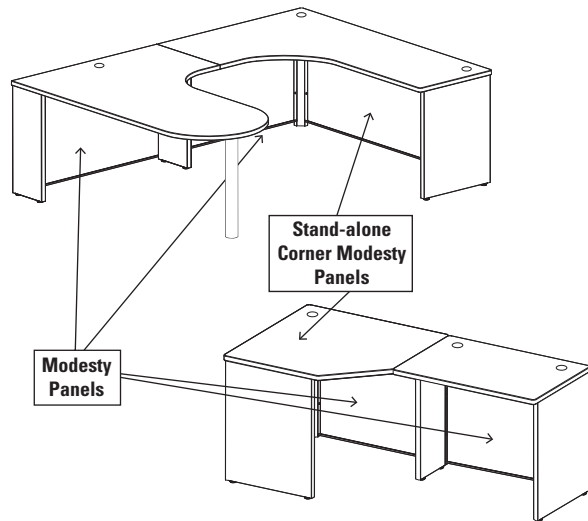

Gussets "G"

Gussets can be used in place of a modesty panel with desks 36"W to 60"W. Gussets can also be used with corner desk legs.

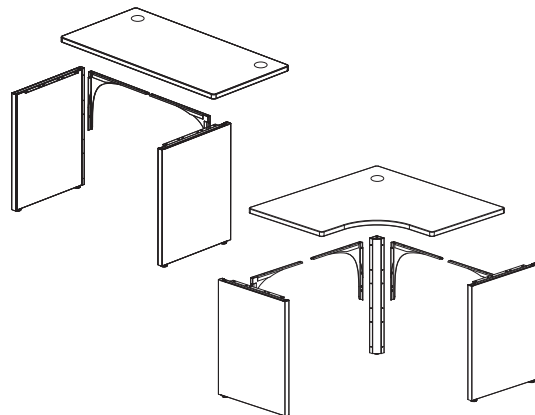

Abode™ Freestanding Desk

The following five pages contain examples of Abode™ workstations. Each “typical” is shown in 3D hidden line perspective. Along with each typical is a complete listing of all the components. Use the information and format to better understand the layout and specifying of Abode™.

Line Item	Product Description	Qty	Model #	Fabric Grade	List Price	Price Extension
1	T-Mold Edge Worksurface 24”D x 36”W	1	HWR2436T		\$267	\$267
2	Freestanding End Panel Support 24”D x 29½”H	2	HSDEP2429F		\$176	\$352
3	Full-Height Modesty Panel 36”W x 29½”H	1	HSDMP369		\$165	\$165
					TOTAL:	\$784

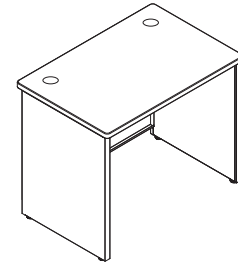

Abode™ Panel-Attached Desk

Line Item	Product Description	Qty	Model #	Fabric Grade	List Price	Price Extension
1	T-Mold Edge Worksurface 24”D x 36”W	1	HWR2436T		\$267	\$267
2	Freestanding End Panel Support 24”D x 29½”H	1	HSDEP2429F		\$176	\$176
3	Full-Height Modesty Panel 36”W x 29½”H	1	HSDMP369		\$165	\$165
4	Desk-to-Panel Attachment Kit – Right-Handed 29½”H	1	HSDDPA29R		\$ 87	\$ 87
					TOTAL:	\$695

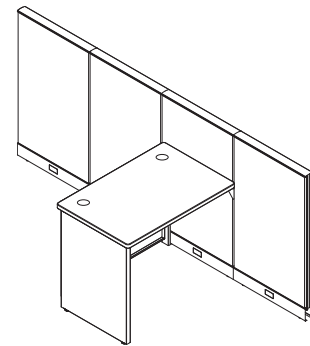

Abode™ Return Desk

(Attached to a primary or return desk)

Line Item	Product Description	Qty	Model #	Fabric Grade	List Price	Price Extension
1	T-Mold Edge Worksurface 24”D x 36”W	1	HWR2436T		\$267	\$ 267
2	T-Mold Edge Worksurface 24”D x 60”W	1	HWR2460T		\$383	\$ 383
3	Full-Height Modesty Panel 42”W x 29½”H	1	HSDMP429		\$169	\$ 169
4	Freestanding End Panel Support 24”D x 29½”H	3	HSDEP2429F		\$176	\$ 528
5	Return Kit 29½”H	1	HSDRK29		\$ 90	\$ 90
6	Full-Height Modesty Panel 60”W x 29½”H	1	HSDMP609		\$180	\$ 180
					TOTAL:	\$1,617

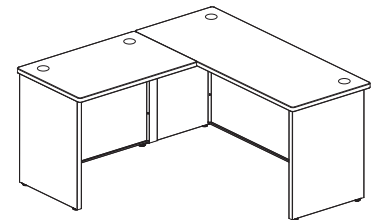

Abode™ Return Desk

(Attached to a panel-hung worksurface)

Line Item	Product Description	Qty	Model #	Fabric Grade	List Price	Price Extension
1	T-Mold Edge Worksurface 24”D x 48”W	1	HWR2448T		\$329	\$ 329
2	Full-Height Modesty Panel 54”W x 29½”H	1	HSDMP549		\$178	\$ 178
3	Freestanding End Panel Support 24”D x 29½”H	1	HSDEP2429F		\$176	\$ 176
4	Return Kit 29½”H	1	HSDRK29		\$ 90	\$ 90
5	End Panel Support – Right 24”D x 29½”H	1	HRVEP2429R		\$202	\$ 202
6	End Panel Support – Left 24”D x 29½”H	1	HRVEP2429L		\$202	\$ 202
7	T-Mold Edge Worksurface 24”D x 60”W	1	HWR2460T		\$383	\$ 383
					TOTAL:	\$1,560

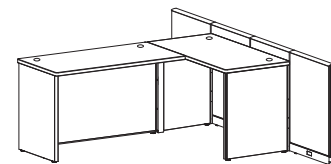

Line Item	Product Description	Qty	Model #	Fabric Grade	List Price	Price Extension
1	T-Mold Edge Worksurface 24"D x 42"W	1	HWR2442T		\$310	\$ 310
2	T-Mold Edge Worksurface 24"D x 72"W	2	HWR2472T		\$430	\$ 860
3	Full-Height Modesty Panel 54"W x 29½"H	1	HSDMP549		\$178	\$ 178
4	Bridge Kit	1	HSDBK29		\$180	\$ 180
5	Full-Height Modesty Panel 72"W x 29½"H	2	HSDMP729		\$187	\$ 374
6	Freestanding End Panel Support 24"D x 29½"H	4	HSDEP2429F		\$176	\$ 704
TOTAL:						\$2,606

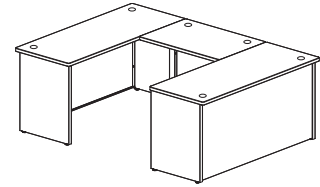

(Attached to a primary desk)

Abode™ Bridge Desk and Peninsula

Line Item	Product Description	Qty	Model #	Fabric Grade	List Price	Price Extension
1	T-Mold Edge Worksurface 24"D x 36"W	1	HWR2436T		\$267	\$ 267
2	T-Mold Edge Worksurface 24"D x 60"W	1	HWR2460T		\$383	\$ 383
3	T-Mold Edge Peninsula Worksurface 30"W x 60"L	1	HWP3060T		\$445	\$ 445
4	Full-Height Modesty Panel 42"W x 29½"H	1	HSDMP429		\$169	\$ 169
5	Full-Height Modesty Panel 30"W x 29½"H	1	HSDMP309		\$163	\$ 163
6	Freestanding End Panel Support 24"D x 29½"H	2	HSDEP2429F		\$176	\$ 352
7	Full-Height Modesty Panel 60"W x 29½"H	1	HSDMP609		\$180	\$ 180
8	Freestanding End Panel Support 11"D x 29½"H	1	HSDEP1129F		\$165	\$ 165
9	Freestanding Support Leg 24"D x 29½"H	1	HSDSL2429F		\$184	\$ 184
10	Support Column for Peninsula	1	HCNLEG29		\$197	\$ 197
11	Return Kit 29½"H	1	HSDRK29		\$ 90	\$ 90
TOTAL:						\$2,595

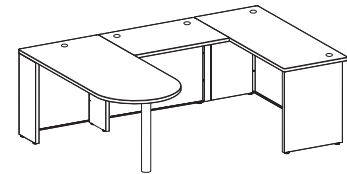

(Stand alone)

Abode™ Corner Desk

Line Item	Product Description	Qty	Model #	Fabric Grade	List Price	Price Extension
1	T-Mold Edge Corner Worksurface 24"D x 36"W	1	HWCS3624T		\$459	\$ 459
2	Stand-Alone Corner Modesty Panel 36"W x 29½"H	2	HSDCMP3629		\$165	\$ 330
3	Freestanding End Panel Support 24"D x 29½"H	2	HSDEP2429F		\$176	\$ 352
4	Corner Desk Leg 29½"H	1	HSDDL29		\$149	\$ 149
TOTAL:						\$1,290

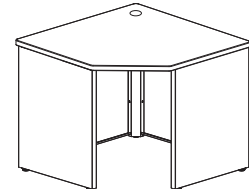

(With adjacent desk attached at one side)

Abode™ Corner Desk

Line Item	Product Description	Qty	Model #	Fabric Grade	List Price	Price Extension
1	T-Mold Edge Corner Worksurface 24"D x 36"W	1	HWCS3624T		\$459	\$ 459
2	T-Mold Edge Worksurface 24"D x 36"W	1	HWR2436T		\$267	\$ 267
3	Stand-Alone Corner Modesty Panel 36"W x 29½"H	1	HSDCMP3629		\$165	\$ 165
4	Full-Height Modesty Panel 36"W x 29½"H	2	HSDMP369		\$165	\$ 330
5	Freestanding End Panel Support 24"D x 29½"H	2	HSDEP2429F		\$176	\$ 352
6	Freestanding Support Leg 24"D x 29½"H	1	HSDSL2429F		\$184	\$ 184
7	Corner Desk Leg 29½"H	1	HSDDL29		\$149	\$ 149
TOTAL:						\$1,906

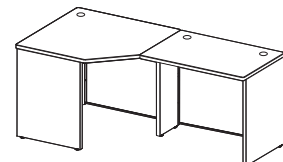

Abode™ Bridge Desk

(Attached between corner and primary desk)

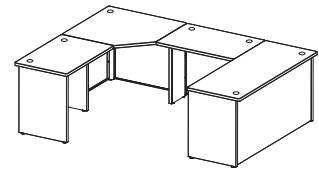

Line Item	Product Description	Qty	Model #	Fabric Grade	List Price	Price Extension
1	T-Mold Edge Worksurface 24"D x 36"W	2	HWR2436T		\$267	\$ 534
2	T-Mold Edge Worksurface 24"D x 72"W	1	HWR2472T		\$430	\$ 430
3	T-Mold Edge Corner Worksurface 24"D x 36"W	1	HWCS3624T		\$459	\$ 459
4	Full-Height Modesty Panel 42"W x 29½"H	1	HSDMP429		\$169	\$ 169
5	Return Kit 29½"H	1	HSDRK29		\$ 90	\$ 90
6	Freestanding Support Leg 24"D x 29½"H	2	HSDSL2429F		\$184	\$ 368
7	Freestanding End Panel Support 24"D x 29½"H	3	HSDEP2429F		\$176	\$ 528
8	Full-Height Modesty Panel 72"W x 29½"H	1	HSDMP729		\$187	\$ 187
9	Full-Height Modesty Panel 36"W x 29½"H	3	HSDMP369		\$165	\$ 495
10	Corner Desk Leg 29½"H	1	HSDDL29		\$149	\$ 149
TOTAL:						\$3,409

Abode™ Corner Desk

(Attached to a panel with an adjacent desk at one side)

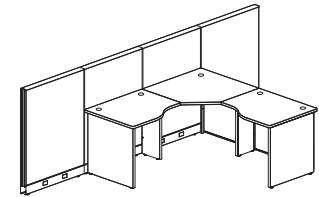

Line Item	Product Description	Qty	Model #	Fabric Grade	List Price	Price Extension
1	T-Mold Edge Corner Worksurface 24"D x 36"W	1	HWCS3624T		\$459	\$ 459
2	T-Mold Edge Wave Worksurface 30"W x 24/30"D	1	HWV30ABT		\$258	\$ 258
3	T-Mold Edge Wave Worksurface 30"W x 24/30"D	1	HWV30BAT		\$258	\$ 258
4	Full-Height Modesty Panel 36"W x 29½"H	1	HSDMP369		\$165	\$ 165
5	Full-Height Modesty Panel 30"W x 29½"H	1	HSDMP309		\$163	\$ 163
6	Freestanding End Panel Support 30"D x 29½"H	1	HSDEP3029F		\$195	\$ 195
7	Freestanding Support Leg 24"D x 29½"H	1	HSDSL2429F		\$184	\$ 184
8	Corner w/Desk Panel Attachment Kit – Left-Handed 29"H	1	HSDCPA29L		\$ 87	\$ 87
9	Full End Panel 30"D x 29½"H	1	HRVEP3029L		\$220	\$ 220
10	Universal Support Leg 30"D x 29½"H	1	HRVCLG24		\$179	\$ 179
TOTAL:						\$2,168

"U" with Jetty and Corner Cove

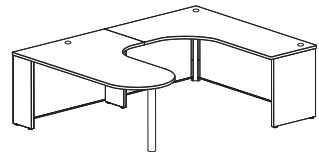

Line Item	Product Description	Qty	Model #	Fabric Grade	List Price	Price Extension
1	Edgeband Jetty – Right-Handed 48"D x 72"W x 24" x 30"	1	HWJ59ABRT		\$600	\$ 600
2	Edgeband Corner Cove – Right-Handed 72" x 48" x 24" x 24"	1	HWV95AART		\$778	\$ 778
3	Full-Height Modesty Panel 48"W x 29½"H	2	HSDMP489		\$176	\$ 352
4	Stand-Alone Corner Modesty Panel 72"W x 29½"H	1	HSDCMP7229		\$187	\$ 187
5	Freestanding End Panel Support 11"D x 29½"H	1	HSDEP1129F		\$165	\$ 165
6	Freestanding Support Leg 24"D x 29½"H	1	HSDSL2429F		\$184	\$ 184
7	Freestanding End Panel Support 24"D x 29½"H	1	HSDEP2429F		\$176	\$ 176
8	Corner Desk Leg 29½"H	1	HSDDL29		\$149	\$ 149
9	Support Column	1	HCNLEG29		\$197	\$ 197
TOTAL:						\$2,788

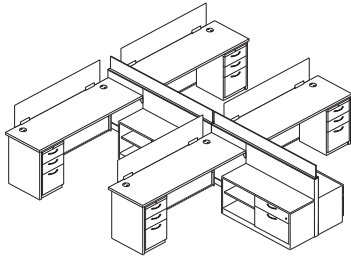

Abode™ with Abound®

Qty.	Model #	Description	List Price	Price Extension
4	HWR2472P	Systems Rectangular Worksurface Edgeband 24"D x 72"W	\$ 496	\$ 1,984
2	HRVF3524P	Abound® Panel Frame 35"H x 24"W	\$ 210	\$ 420
2	HRVF3548P	Abound® Panel Frame 35"H x 48"W	\$ 242	\$ 484
4	HRVT3024T	Abound® Fabric Tile 30"H x 24"W	\$ 90	\$ 360
4	HRVT3048T	Abound® Fabric Tile 30"H x 48"W	\$ 123	\$ 492
2	HRVT0772F	Abound® Frameless Glass 71/2"H x 72"W	\$ 760	\$ 1,520
2	HRVC30PF	Abound® Finished End Trim 30"H	\$ 68	\$ 136
2	HSDDPA29L	Abode™ Desk-to-Panel Attachment Kits – Left 29 1/2"H	\$ 87	\$ 174
2	HSDDPA29R	Abode™ Desk-to-Panel Attachment Kits – Right 29 1/2"H	\$ 87	\$ 174
4	HSDMP729	Abode™ Full-Height Modesty Panel 72"W	\$ 187	\$ 748
4	HSDEP2429F	Abode™ Freestanding End Panel 24"D	\$ 176	\$ 704
2	HSCBX224818RBFOMA	Contain® Low Credenza, Box/Lateral – Right 48"W	\$1,472	\$ 2,944
2	HSCBX224818LBFOMA	Contain® Low Credenza, Box/Lateral – Left 48"W	\$1,472	\$ 2,944
4	H19717A	Flagship® Freestanding Support Ped B/B/F	\$ 602	\$ 2,408
4	HLSL1260	Voi® Above Privacy Screen 60"W x 13"H	\$ 392	\$ 1,568
4	HSCAPB	Credenza Storage-to-Panel Bracket	\$ 178	\$ 712
TOTAL:			\$17,772	

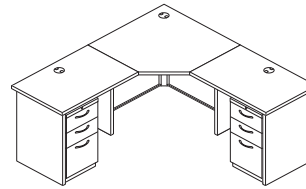

Corner with Return

Qty.	Model #	Description	List Price	Price Extension
2	HWR2436P	Systems Rectangular Worksurface Edgeband 24"D x 36"W	\$324	\$ 648
1	HWCS3624P	Systems Corner Worksurface Edgeband 24"D x 36"W	\$489	\$ 489
2	HSDEP2429F	Abode™ Freestanding End Panel 24"D	\$176	\$ 352
2	HSDSL2429F	Abode™ Freestanding Support Leg 24"D	\$184	\$ 368
1	HSDDL29	Abode™ Corner Desk Leg 29 1/2"H	\$149	\$ 149
4	HSDMP369	Abode™ Full-Height Modesty Panel 36"W	\$165	\$ 660
2	H19717A	Flagship® Freestanding Support Ped B/B/F	\$602	\$1,204
TOTAL:			\$3,870	

Abode™ — Typical

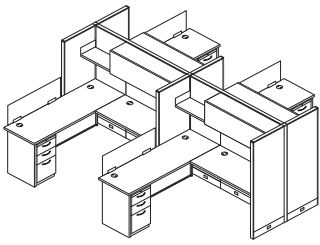

Abode™ with Accelerate®

Qty.	Model #	Description	List Price	Price Extension
8	HETP6524FP	Accelerate® Tackable Panel 65"H x 24"W	\$329	\$ 2,632
2	HETP6548FP	Accelerate® Tackable Panel 65"H x 48"W	\$422	\$ 844
6	HETC24	Accelerate® Top Cap 24"W	\$ 31	\$ 186
2	HETC72	Accelerate® Top Cap 72"W	\$ 89	\$ 178
4	HWR2472P	Systems Rectangular Worksurface Edgeband 24"D x 72"W	\$496	\$ 1,984
4	HWR2448P	Systems Rectangular Worksurface Edgeband 24"D x 48"W	\$379	\$ 1,516
2	HEC65PT	Accelerate® "T" Connector 65"H	\$138	\$ 276
1	HEC65PX	Accelerate® "X" Connector 65"H	\$138	\$ 138
6	HEFEC65P	Accelerate® Panel Finished End Covers 65"H	\$ 55	\$ 330
6	HWSB2	Accelerate® Worksurface Bracket Kit	\$ 40	\$ 240
4	HHN831124	Flat Bracket 24"D	\$ 57	\$ 228
4	H19717A	Flagship® Freestanding Support Ped B/B/F	\$602	\$ 2,408
2	HSDDPA29L	Abode™ Desk-to-Panel Attachment Kits – Left 29½"H	\$ 87	\$ 174
2	HSDDPA29R	Abode™ Desk-to-Panel Attachment Kits – Right 29½"H	\$ 87	\$ 174
4	HSDEP2429F	Abode™ Freestanding End Panel 24"D	\$176	\$ 704
4	HSDMP729	Abode™ Full-Height Modesty Panel 72"W	\$187	\$ 748
4	HRVOH48FM	Systems Overhead Storage Flipper Door 48"W	\$574	\$ 2,296
4	HRVSH24	Systems Overhead Storage Shelf 24"W	\$211	\$ 844
4	HLSL1242	Voi® Above Privacy Screen 42"W x 13"H	\$298	\$ 1,192
TOTAL:			\$17,092	

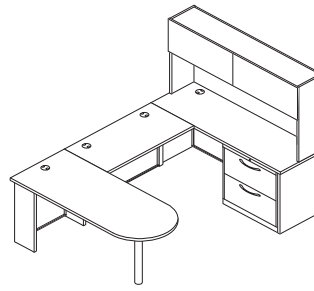

Peninsula U

Qty.	Model #	Description	List Price	Price Extension
1	HWR2472P	Systems Rectangular Worksurface Edgeband 24"D x 72"W	\$496	\$ 496
1	HWR2448P	Systems Rectangular Worksurface Edgeband 24"D x 48"W	\$379	\$ 379
1	HWP3072P	Systems Peninsula Worksurface Edgeband 30"D x 72"W	\$713	\$ 713
1	H386572N	Stack-on Full Clearance w/o Doors 13"D x 72"W x 34¾"H	\$796	\$ 796
1	H387215	Flipper Doors w/ Lock 36"W x 16"H	\$494	\$ 494
1	HT72ND	Tackboard for 72"W Hutch 72"	\$451	\$ 451
1	HCNLEG29	Support Column for Peninsula 29"H	\$197	\$ 197
2	HSDEP2429F	Abode™ Freestanding End Panel 24"D	\$176	\$ 352
1	HSDEP1129F	Abode™ Freestanding End Panel 11"D	\$165	\$ 165
1	HSDSL2429F	Abode™ Freestanding Support Leg 24"D	\$184	\$ 184
1	HSDRK29	Abode™ Return Kit	\$ 90	\$ 90
1	HSDMP729	Abode™ Full-Height Modesty Panel 72"W	\$187	\$ 187
1	HSDMP549	Abode™ Full-Height Modesty Panel 54"W	\$178	\$ 178
1	HSDMP309	Abode™ Full-Height Modesty Panel 30"W	\$163	\$ 163
1	H9170A	Flagship® 2 Drawer "A" Pull Lateral 30"W	\$847	\$ 847
TOTAL:			\$5,692	

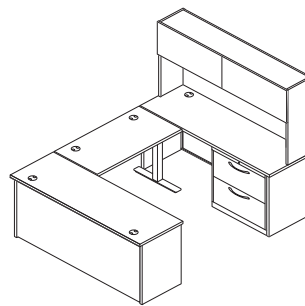

Workstation U

Qty.	Model #	Description	List Price	Price Extension
2	HWR2472P	Systems Rectangular Worksurface Edgeband 24"D x 72"W	\$ 496	\$ 992
1	HHAW2448P	Systems Height Adjustable Worksurface 24"D x 48"W	\$ 403	\$ 403
1	H386572N	Stack-on Full Clearance w/o Doors 13"D x 72"W x 34¾"H	\$ 796	\$ 796
1	H387215	Flipper Doors w/ Lock 36"W x 16"H	\$ 494	\$ 494
1	HT72ND	Tackboard for 72"W Hutch 72"	\$ 451	\$ 451
2	HSDMP729	Abode™ Full-Height Modesty Panel 72"W	\$ 187	\$ 374
4	HSDEP2429F	Abode™ Freestanding End Panel 24"D	\$ 176	\$ 704
1	HHAB3S24F	Systems Height Adjustable Base 24"D	\$1,250	\$1,250
2	H9170A	Flagship® 2 Drawer "A" Pull Lateral 30"W	\$ 847	\$1,694
TOTAL:			\$7,158	





▶ End panels available in freestanding or panel-mount.

▶ Corner desk legs have 90° bend and welded construction.

▶ Gussets can be used in place of a modesty panel with desks 36"W to 60"W.

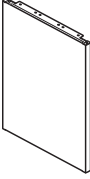
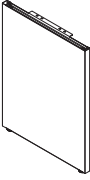
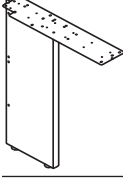
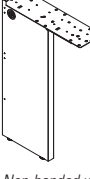
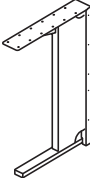
⚠ **All Abode™ Components are compatible with Abound® and Accelerate® panel systems and Systems Worksurfaces.**

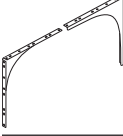









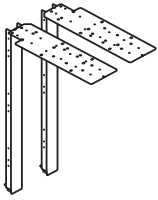

Description	Model	Ship Weight	Cube	List by Paint Grade	
				Core	Choice/Metallics
 <p>Freestanding End Panel Supports 11"D 24"D 30"D</p>	HSDEP1129F	15	1.1	\$ 165	\$ 192
	HSDEP2429F	25	1.1	\$ 176	\$ 203
	HSDEP3029F	30	1.1	\$ 195	\$ 222
 <p>Panel Mounted Full End Panel Supports* 29½"H x 11"D — Right — Panel-Mount 29½"H x 11"D — Left — Panel-Mount 29½"H x 24"D — Right — Panel-Mount 29½"H x 24"D — Left — Panel-Mount 29½"H x 30"D — Right — Panel-Mount 29½"H x 30"D — Left — Panel-Mount</p> <p><i>Specify paint</i></p> <p>NOTES: The use of an end panel at the end of a worksurface will increase the rigidity of the workstation. If the panel is a greater dimension than the worksurface, an end panel is required if the run of the worksurfaces is 8 feet or greater. ⚠ *Must be connected into panel slots. When an installation of worksurfaces is 8 feet or greater, a full end panel or universal support leg must be used at 90 degree panel junctions or in a shared position to support adjoining worksurfaces.</p>	HRVEP1129R	16	1.4	\$ 188	\$ 217
	HRVEP1129L	16	1.4	\$ 188	\$ 217
	HRVEP2429R	21	1.4	\$ 202	\$ 231
	HRVEP2429L	21	1.4	\$ 202	\$ 231
	HRVEP3029R	23	1.4	\$ 220	\$ 249
	HRVEP3029L	23	1.4	\$ 220	\$ 249
 <p>Freestanding Support Leg 24"D 30"D</p> <p>NOTES: To be used when connecting a non-rectangular worksurface to a rectangular worksurface.</p>	HSDSL2429F	25	1.1	\$ 184	\$ 211
	HSDSL3029F	25	1.1	\$ 208	\$ 235
 <p>Panel Mounted Support Leg* 29½"H to support 24"D 29½"H to support 30"D</p> <p><i>Non-handed unit Specify paint</i></p> <p>⚠ *Must be connected into panel slots. When an installation of worksurfaces is 8 feet or greater, a full end panel or universal support leg must be used at 90 degree panel junctions or in a shared position to support adjoining worksurfaces.</p>	HRVCLG24	16	1.4	\$ 179	\$ 208
	HRVCLG30	17	1.4	\$ 195	\$ 224
 <p>Abode™ Shared Leg</p> <p>NOTES: To be used when joining two rectangular surfaces. Can be used as a stand alone support in panel systems. 1½" radius opening for cord management.</p>	HSDSL29	18	1.5	\$ 338	\$ 365
 <p>Corner Desk Leg 29½"H</p>	HSDDL29	7	0.4	\$ 149	\$ 176
 <p>Gussets (1 pair)</p> <p>NOTES: Gussets may be used instead of a modesty panel to create freestanding desks.</p>	HSDG	7	0.5	\$ 102	\$ 119
 <p>Flat Bracket 24"D 30"D</p> <p>⚠ Charcoal only.</p>	HHN831124	3	0.3	\$ 57	N/A
	HHN831130	3	0.4	\$ 57	N/A

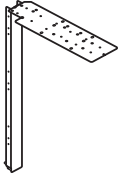
How to specify	Select Model Number from above	1st Option
	H S D E P 1 1 2 9 F . T 1	Select Paint Color See page 297

Icon Legend on page 10

- ▶ Bridge kits include two flat brackets, two modesty panel-to-end panel attachment brackets, and two tie straps.
- ▶ Return kits include one flat bracket, one modesty panel-to-end panel attachment bracket, and one tie strap.



Description	Model	Ship Weight	Cube	List by Paint Grade	
				Core	Choice/Metallics
 <p>Bridge Kit 29½"H</p> <p>NOTES: Add 12" to your modesty width when using a Bridge Kit.</p>	HSDBK29	10 	0.4	\$ 180	\$ 207
 <p>Return Kit 29½"H</p> <p>NOTES: Add 6" to your modesty width when using a Return Kit.</p>	HSDRK29	6 	0.4	\$ 90	\$ 117
 <p>Desk-to-Panel Attachment Kits for Abode™ Desk-to-Panel Attachment Kit 29½"H 29½"H</p>	HSDDPA29L HSDDPA29R	5  5 	0.3 0.3	\$ 87 \$ 87	\$ 97 \$ 97
 <p>Corner with Desk Panel Attachment Kit for Abode™ Corner with Desk-to-Panel Attachment Kit 29½"H 29½"H</p> <p>NOTES: This Attachment Kit utilizes the same modesty panel specification rules as the Freestanding Corner Leg.</p>	HSDCPA29L HSDCPA29R	5  5 	0.3 0.3	\$ 87 \$ 87	\$ 97 \$ 97

How to specify	<p>Select Model Number from above</p> <p>H S D B K 2 9 .</p>	<p>1st Option</p> <p>Select Paint Color</p> <p>See page 297</p> <p>T 1 </p>
----------------	--	---

  Icon Legend on page 10

- ▶ Desk: Modesty panel width is the same width as the worksurface.
- ▶ Return: Modesty panel width is 6" greater than the width of the return worksurface.
- ▶ Bridge connecting two rectangular worksurfaces: Modesty panel width is 12" greater than the width of the bridge worksurface.
- ▶ Bridge connecting a rectangular worksurface and corner or peninsula: Modesty panel width is 6" greater than the width of the worksurface.
- ▶ Corner connecting to an adjacent worksurface: Modesty panel width is the same width as the worksurface.



	Description	Model	Ship Weight	Cube	List by Paint Grade	
					Core	Choice/Metallics
	Full-Height Modesty Panel					
	29½"H x 24"W	HSDMP249	5.0 <input type="checkbox"/>	0.6	\$ 158	\$ 175
	29½"H x 30"W	HSDMP309	7.0 <input type="checkbox"/>	0.6	\$ 163	\$ 180
	29½"H x 36"W	HSDMP369	8.0	0.8	\$ 165	\$ 182
	29½"H x 42"W	HSDMP429	9.0	0.9	\$ 169	\$ 186
	29½"H x 48"W	HSDMP489	11.0	1.0	\$ 176	\$ 193
	29½"H x 54"W	HSDMP549	12.0	2.2	\$ 178	\$ 195
	29½"H x 60"W	HSDMP609	13.0	2.2	\$ 180	\$ 197
	29½"H x 66"W	HSDMP669	15.0	2.6	\$ 184	\$ 201
	29½"H x 72"W	HSDMP729	16.0	3.0	\$ 187	\$ 204
△ To be used in all applications except when connecting a Corner Leg to an End Panel or a Corner Leg to a Shared Leg.						
	Full-Height Stand-Alone Corner Modesty Panel					
	29½"H x 36"W	HSDCMP3629	7.0	1.9	\$ 165	\$ 182
	29½"H x 42"W	HSDCMP4229	9.0	1.9	\$ 169	\$ 186
	29½"H x 48"W	HSDCMP4829	10.0	2.3	\$ 176	\$ 193
	29½"H x 60"W	HSDCMP6029	14.0	4.7	\$ 180	\$ 197
29½"H x 72"W	HSDCMP7229	16.0	5.4	\$ 187	\$ 204	
NOTES: To be used when connecting a Corner Leg to an End Panel or Shared Leg.						
	Half-Height Modesty Panel					
	14"H x 24"W	HSDMP244	5.1 <input type="checkbox"/>	0.4	\$ 148	\$ 165
	14"H x 30"W	HSDMP304	6.6 <input type="checkbox"/>	0.4	\$ 152	\$ 169
	14"H x 36"W	HSDMP364	8.1 <input type="checkbox"/>	0.5	\$ 154	\$ 171
	14"H x 42"W	HSDMP424	9.6 <input type="checkbox"/>	0.6	\$ 162	\$ 179
	14"H x 48"W	HSDMP484	11.0 <input type="checkbox"/>	0.6	\$ 165	\$ 182
	14"H x 54"W	HSDMP544	13.0 <input type="checkbox"/>	0.8	\$ 168	\$ 185
	14"H x 60"W	HSDMP604	14.0 <input type="checkbox"/>	0.8	\$ 170	\$ 187
	14"H x 66"W	HSDMP664	16.0 <input type="checkbox"/>	1.0	\$ 176	\$ 193
	14"H x 72"W	HSDMP724	17.0 <input type="checkbox"/>	1.0	\$ 178	\$ 195
	Half-Height Stand-Alone Corner Modesty Panel					
	14"H x 36"W	HSDCMP3614	4.0 <input type="checkbox"/>	0.5	\$ 154	\$ 171
	14"H x 42"W	HSDCMP4214	4.0 <input type="checkbox"/>	0.6	\$ 162	\$ 179
	14"H x 48"W	HSDCMP4814	5.0 <input type="checkbox"/>	0.6	\$ 165	\$ 182
	14"H x 60"W	HSDCMP6014	6.0 <input type="checkbox"/>	0.8	\$ 170	\$ 187
14"H x 72"W	HSDCMP7214	7.0 <input type="checkbox"/>	1.0	\$ 178	\$ 195	

How to specify	Select Model Number from above	1st Option
	H S D M P 2 4 9 .	Select Paint Color See page 297 T 1

Icon Legend on page 10

- LAMINATE TOPS**
SPECIFY: Model Number.
Laminate
Edge Color
Grommet Color
EXAMPLE: HWR2424PK8.R.T5
- PAINTED PRODUCTS**
SPECIFY: Model Number.
Paint Color
EXAMPLE: HRVSHV24.T1
- PANEL FRAMES**
SPECIFY: Model Number.
Paint
EXAMPLE: HRVF3524P.T3

		Frames and Trim ©	Hard-Surface Tile ©	Painted Metal Tiles, Custom Bracket Kit and Paper Management ©	Door Panel ©	Worksurfaces, Countertops and Corner Shelves with T-Mold ©	Worksurfaces, Countertops and Corner Shelves with Edgeband ©	Worksurface Supports ©	Duplex Receptacles and Ported Tile Grommets ©	Steel Overhead Storage ©	Laminate Front Overhead ©	Laminate Keyboard Platforms ©	Metal Keyboard Platforms ©
L1 LAMINATES		CODES											
Woodgrain	Bourbon Cherry	H	•	•	•	•	•	•			•	•	
	Cognac	COGN	•	•	•	•	•	•			•	•	
	Harvest	C	•	•	•	•	•	•			•	•	
	Mahogany	N	•	•	•	•	•	•			•	•	
	Mocha	MOCH	•	•	•	•	•	•			•	•	
	Natural Maple	D	•	•	•	•	•	•			•	•	
	Pinnacle	PINC	•	•	•	•	•	•			•	•	
Shaker Cherry	F	•	•	•	•	•	•			•	•		
Solid	Brilliant White	WHIT	•	•	•	•	•	•					
	Whitestone	K4	•	•	•	•	•	•					
Patterned	Sheer Mesh	A5	•	•	•	•	•	•					
	Silver Mesh	B9	•	•	•	•	•	•					
	Steel Mesh	A9	•	•	•	•	•	•					
	Taupe Mesh	A8	•	•	•	•	•	•					
	Canyon Zephyr	K9	•	•	•	•	•	•					
	Desert Zephyr	K8	•	•	•	•	•	•					
	Shadow Zephyr	K1	•	•	•	•	•	•					
	Gray	G2	•	•	•	•	•	•					
	Grey Tigris	L6	•	•	•	•	•	•					
	White	G1	•	•	•	•	•	•					
	L2 LAMINATES	CODES											
Woodgrain	Lowell Ash NEW! 1/30/2017	LLA1	•			•							
	Natural Recon NEW! 1/30/2017	LNRI	•			•							
	Phantom Ecru NEW! 1/30/2017	LPE1	•			•							
	Portico Teak NEW! 1/30/2017	LPT1	•			•							
	Skyline Walnut NEW! 1/30/2017	LSW1	•			•							
PAINTS / GROMMETS		CODES											
Core	Black	P	•	•	•	•	•	•	•	•	•	•	•
	Charcoal	S	•	•	•	•	•	•	•	•	•	•	•
	Greige	T5	•	•	•	•	•	•	•	•	•	•	•
	Light Gray	Q	•	•	•	•	•	•	•	•	•	•	•
	Loft	LOFT	•	•	•	•	•	•	•	•	•	•	•
	Muslin	T3	•	•	•	•	•	•	•	•	•	•	•
	Putty*	L	•	•	•	•	•	•	•	•	•	•	•
	Shadow	SHDW	•	•	•	•	•	•	•	•	•	•	•
Metallic	Brilliant White	WHIT	•	•	•	•	•	•	•	•	•	•	•
	Champagne Metallic*	T4	•	•	•	•	•	•	•	•	•	•	•
	Platinum Metallic	T1	•	•	•	•	•	•	•	•	•	•	•
T-MOLD		CODES											
	Black	P				•							
	Brilliant White	WHIT				•							
	Charcoal	S				•							
	Greige	R				•							
	Light Gray	Q				•							
	Loft	LOFT				•							
	Muslin	T				•							
	Platinum	K				•							
Shadow	SHDW				•								
EDGE BAND		CODES											
	Black	P											•
	Bourbon Cherry	H											•
	Brilliant White	WHIT											•
	Charcoal	S											•
	Cognac	COGN											•
	Greige	R											•
	Harvest	C											•
	Light Gray	Q											•
	Loft	LOFT											•
	Lowell Ash NEW! 1/30/2017	DL											•
	Mahogany	N											•
	Mocha	MOCH											•
	Muslin	T											•
	Natural Maple	D											•
	Natural Recon NEW! 1/30/2017	NR											•
	Phantom Ecru NEW! 1/30/2017	PE											•
	Pinnacle	PINC											•
	Platinum	K											•
	Portico Teak NEW! 1/30/2017	DP											•
	Shadow	SHDW											•
	Shaker Cherry	F											•
	Skyline Walnut NEW! 1/30/2017	SW											•

Suffix "A"



Satin Chrome
Arch Pull

Edge Treatments



"T" Thin T-Mold



"P" Edgeband

(Color must be selected.)

- ▶ HOW TO ORDER
 - 1) Select desired model numbers.
 - 2) Order worksurfaces to correspond to width of panel behind them.
 - 3) Select desired top edge treatment.
 - 4) Replace the (?) after each model number with the suffix representing the chosen top edge treatment.

Touch-up paint model HPMARKER1 available in L, P, Q, S, T3 and T5 paint. Model HPKT001 available in L, P, Q, S, T3 and T5 paint. Use Paint codes for grommet colors.

- ▶ DUPLEX COLOR SELECTION
 - For Champagne Metallic Paint, Greige is suggested for the duplex and grommet color.
 - For Putty paint color, Greige is the suggested duplex and grommet color.
 - For Black paint color, Charcoal is the suggested duplex color.
 - For Light Gray paint, Platinum Metallic is the suggested duplex color.

Recommended Edgeband Color Selection:

Laminate		Edgeband	
Bourbon Cherry	H	Bourbon Cherry	H
Cognac	COGN	Cognac	COGN
Harvest	C	Harvest	C
Mahogany	N	Mahogany	N
Mocha	MOCH	Mocha	MOCH
Natural Maple	D	Natural Maple	D
Pinnacle	PINC	Pinnacle	PINC
Shaker Cherry	F	Shaker Cherry	F
Brilliant White	WHIT	Brilliant White	WHIT
Sheer Mesh	A5	Muslin	T
Silver Mesh	B9	Loft	LOFT
Lowell Ash	LLA1	Lowell Ash	DL
Natural Recon	LNRI	Natural Recon	NR
Phantom Ecru	LPE1	Phantom Ecru	PE
Portico Teak	LPT1	Portico Teak	DP
Skyline Walnut	LSW1	Skyline Walnut	SW

*Putty and Champagne Metallic are not available on grommets. Please see grommet color suggestions above.

Icon Legend on page 10 ©

About® Ordering Information

► **NEW!** Grade A Reflections. Available January 30, 2017.

► FOR TILES
SPECIFY: Model Number
Fabric Style.
Fabric Color
EXAMPLE: HRVT1524T.APN15

► 6" x 6" fabric samples are recommended to determine color and pattern on panels.

HON

About Panel Fabrics...Ordering Codes

For COM Fabrics, see pages 6-7.

PRICE CODE A

Appoint

Artichoke	APN11
Blackberry	APN32
Bronze	APN22
Carbon	APN28
Chai	APN12
Cherry	APN30
Copper <input type="checkbox"/>	APN18
Dark Pewter	APN17
Dune	APN15
Espresso	APN23
Framboise	APN31
Frost	APN34
Hummus <input type="checkbox"/>	APN14
Jet	APN27
Lawn	APN25
Mandarin	APN29
Morel	APN09
Nimbus	APN16
Platinum	APN24
Turmeric <input type="checkbox"/>	APN10
Turquoise	APN26
Walnut <input type="checkbox"/>	APN13

Bix*

Bridge	BX06
Field	BX08
Fort	BX09
Hay	BX03
River	BX07
Shell	BX04
Stone	BX02

Element*

Flint	GN65
Indigo	GN67
Latte	GN73
Millet	GN72
Parchment	GN53
Sea	GN74
Veil	GN13
Warm Beige	GN55
Wisp	GN75

Etch*

Aquatint	ECH01
Crosshatch	ECH04
Engrave	ECH02
Intaglio	ECH06
Lithograph	ECH03
Mezzotint	ECH07
Woodcut	ECH05

Hatch*

Canvas	HC15
Chroma	HC55
Clay	HC25
Easel	HC20
Glaze	HC50
Graphite	HC40
Monochrome	HC30
Patina	HC45
Sketch	HC35

Landscape

Azure	LN55
Cornsilk	LN15
Drift NEW! 1/30/2017	LN05
Khaki	LN20
Maize	LN40
Sheen NEW! 1/30/2017	LN10
Slate	LN35
Tangelo	LN50
Tide	LN45
Umber	LN25
Urban	LN30

Lucy*

Aspen	LC32
Cornsilk	LC30
Dusk	LC22
Fawn	LC33
Graphite	LC34
Mist	LC20
Neutra	LC24
Pewter	LC35
Snowdrop	LC28

Reflections - **NEW! Available**

1/30/2017

Galvanized	REF29
Ice	REF20
Loggia	REF21
Mistral	REF28
Moonstone	REF23
Pewter	REF22
Stainless	REF24
Vanilla	REF25
Winter	REF27

Refuge

Dune	RFG92
Eclipse NEW! 1/30/2017	RFG90
Frost	RFG93
Glacier NEW! 1/30/2017	RFG91
Tidal	RFG94
Sandbar <input type="checkbox"/>	RFG95
Artesian	RFG96
Hemp <input type="checkbox"/>	RFG97
Mineral	RFG98

Sarto

Ash	SRT88
Desert <input type="checkbox"/>	SRT33
Fog	SRT14
Lemongrass	SRT49
Meadow <input type="checkbox"/>	SRT25
Mist	SRT45
Mushroom	SRT76
Oyster	SRT18
Reef	SRT64
Sesame	SRT93
Shale	SRT52
Wheat <input type="checkbox"/>	SRT13

Tango

Aficionado <input type="checkbox"/>	TG94
Azul <input type="checkbox"/>	TG93
Bongo <input type="checkbox"/>	TG31
Dip <input type="checkbox"/>	TG35
Palma <input type="checkbox"/>	TG91
Pecan <input type="checkbox"/>	TG39
Pistachio <input type="checkbox"/>	TG38
Playa <input type="checkbox"/>	TG33
Salsa <input type="checkbox"/>	TG37
Sol <input type="checkbox"/>	TG92
Tequila <input type="checkbox"/>	TG30

Tempest*

Dragonfly	TP30
Frost	TP15
Full Stream	TP80
Ginger <input type="checkbox"/>	TP25
Goldrush	TP10
Sandstorm <input type="checkbox"/>	TP50
Slate	TP45
Tumbleweed	TP70
Wind Chill	TP40
Zebra	TP35

* Directional fabrics

► **NEW!** Grade B Coast. Available January 30, 2017.

► **FOR TILES**
 SPECIFY: Model Number
 Fabric Style.
 Fabric Color
 EXAMPLE: HRVT1524TP.APN15

► 6" x 6" fabric samples are recommended to determine color and pattern on panels.

About Panel Fabrics...Ordering Codes

For COM Fabrics, see pages 6-7.

PRICE CODE B

Coast - *NEW!* Available 1/30/2017

Channel	COA14
Dune	COA03
Headlands	COA10
Marsh	COA02
Pebble	COA12
Pier	COA13
Shoal	COA01
Silt	COA06
Tide	COA08

Mica

Anthracite	MCA11
Breeze	MCA18
Bronze	MCA13
Buff	MCA14
Cremini	MCA17
Crystal	MCAWT
Dew	MCA20
Dove	MCA12
Fresh	MCA16
Mineral	MCA15
Nectar	MCA19
Shale	MCA10

Spin

Alabaster	SPIN02
Cavern	SPIN03
Cobblestone	SPIN04
Ember	SPIN06
Flame	SPIN07
Heron	SPIN13
Oat	SPIN01
Ocean	SPIN12
Plum	SPIN15
Pool	SPIN11
Raven	SPIN10
Rhubarb	SPIN14
Tropic	SPIN08
Willow	SPIN05

Terrain

Bay	TRRN05
Bayou	TRRN35
Canyon	TRRN30
Cliff	TRRN45
Crest	TRRN25
Delta	TRRN10
Plateau	TRRN15
Ridge	TRRN20
Valley	TRRN40

PLAINS TILES — Colored, polymer tiles

Frost	PL01
Sunrise	PL02

* Directional fabrics

Abound® Typical

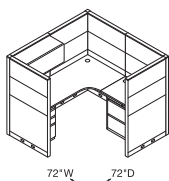

L-Shape Workstation
72\"/>

Qty.	Model #	Description	List Price	Price Extension
1	H19723R	Flagship Series Pedestal "R" Pull Freestanding B/B	\$649	\$ 649
1	H9170R	Flagship 30"W 2-Drw "R" Pull Lateral 30"W x 28"H x 18"D	\$847	\$ 847
2	HH871236	Electrical Power Harness 3-1 & 2-2 Systems 36"W	\$185	\$ 370
1	HH873501	Circuit 1	\$ 37	\$ 37
1	HH873504	Circuit 4	\$ 37	\$ 37
1	HH879072	Base In-Feed Cable Base 3-1 & 2-2 Systems	\$206	\$ 206
2	HRVC65PF	Abound Finished End Painted 65"	\$ 87	\$ 174
3	HRVC65PL	Abound L Connector Painted 65"	\$144	\$ 432
6	HRVF6536P	Abound Panel Frame 65"H x 36"W	\$259	\$1,554
6	HRVTC36	Abound Top Cap Trim 36"W	\$ 49	\$ 294
1	HCTL242	Cantilever One Pair 24"D	\$ 75	\$ 75
24	HRVFSB36	Abound Segment Bar 36"W	\$ 18	\$ 432
1	HRVOH36FM	Abound Overhead Metal Flipper Door 36"	\$525	\$ 525
24	HRVT1536T	Abound Fabric Tile (Fabric Grade A) 15"H x 36"W	\$ 75	\$1,800
12	HRVT3036T	Abound Fabric Tile (Fabric Grade A) 30"H x 36"W	\$107	\$1,284
1	HWR2436P	Systems Rectangular Worksurface Edgeband 24"D x 36"W	\$324	\$ 324
1	HVV93AALP	Systems Left Corner Cove Worksurface Edgebd 72" x 36" x 24" x 24"	\$626	\$ 626
TOTAL:			\$9,666	

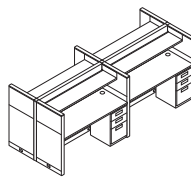

Touch-Down Station
120\"/>

Qty.	Model #	Description	List Price	Price Extension
2	HH871160	Electrical Pass-Thru Cable 3-1 & 2-2 Systems 60"W	\$121	\$ 242
1	HH871224	Electrical Power Harness 3-1 & 2-2 Systems 24"W	\$185	\$ 185
1	HH873501	Circuit 1	\$ 37	\$ 37
1	HH873502	Circuit 2	\$ 37	\$ 37
1	HH873503	Circuit 3	\$ 37	\$ 37
1	HH873504	Circuit 4	\$ 37	\$ 37
1	HH879072	Base In-Feed Cable Base 3-1 & 2-2 Systems	\$206	\$ 206
6	HRVC50PF	Abound Finished End Painted 50"	\$ 82	\$ 492
2	HRVC50PT	Abound T Connector Painted 50"	\$137	\$ 274
1	HRVC50PX	Abound X Connector Painted 50"	\$132	\$ 132
6	HRVF5024P	Abound Panel Frame 50"H x 24"W	\$230	\$1,380
2	HRVF5060P	Abound Panel Frame 50"H x 60"W	\$288	\$ 576
6	HRVTC24	Abound Top Cap Trim 24"W	\$ 31	\$ 186
2	HRVTC60	Abound Top Cap Trim 60"W	\$ 71	\$ 142
8	HWSB2	Worksurface Bracket Kit	\$ 40	\$ 320
12	HRVFSB24	Abound Segment Bar 24"W	\$ 17	\$ 204
4	HRVFSB60	Abound Segment Bar 60"W	\$ 21	\$ 84
4	HRVSH60	Abound Open Shelf 60"	\$323	\$ 1,292
12	HRVT1524T	Abound Fabric Tile (Fabric Grade A) 15"H x 24"W	\$ 66	\$ 792
4	HRVT1560T	Abound Fabric Tile (Fabric Grade A) 15"H x 60"W	\$ 96	\$ 384
12	HRVT3024T	Abound Fabric Tile (Fabric Grade A) 30"H x 24"W	\$ 90	\$1,080
4	HRVT3060T	Abound Fabric Tile (Fabric Grade A) 30"H x 60"W	\$137	\$ 548
4	HWR2460P	Systems Rectangular Worksurface Edgeband 24"D x 60"W	\$447	\$ 1,788
TOTAL:			\$10,455	

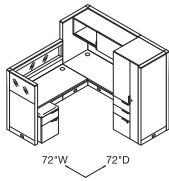

L-Shape Workstation
with Storage Tower
72\"/>

Qty.	Model #	Description	List Price	Price Extension
1	HH871248	Electrical Power Harness 3-1 & 2-2 Systems 48"W	\$ 194	\$ 194
1	HH873501	Circuit 1	\$ 37	\$ 37
1	HH873504	Circuit 4	\$ 37	\$ 37
1	HH879072	Base In-Feed Cable Base 3-1 & 2-2 Systems	\$ 206	\$ 206
1	HLSL1448S	Overhead Cabinet w/Sliding Door 48"W x 14 1/4"D x 14"H	\$ 954	\$ 954
1	HLSL2016MP2	Mobile Ped 20" x 15 1/2" x 21 1/2"	\$ 716	\$ 716
1	HLSL2016PH2	Ped Cushion (Fabric Grade 2) 20" x 15 1/2" x 1"	\$ 297	\$ 297
1	HLSLPMB	Stack-on Storage Panel Mounted Bracket	\$ 114	\$ 114
2	HLSLR2448	Rectangle Worksurface 24"D x 48" W	\$ 264	\$ 528
1	HLSLW446RP	Personal Storage Tower (RH) 24"D x 24"W x 65"H	\$2,311	\$ 2,311
1	HRVC15PFV	Abound Variable Height Finished End Painted 15"	\$ 55	\$ 55
1	HRVC50PF	Abound Finished End Painted 50"	\$ 82	\$ 82
1	HRVC50PL	Abound L Connector Painted 50"	\$ 137	\$ 137
1	HRVC65PF	Abound Finished End Painted 65"	\$ 87	\$ 87
2	HRVC65PL	Abound L Connector Painted 65"	\$ 144	\$ 288
1	HRVF5024P	Abound Panel Frame 50"H x 24"W	\$ 230	\$ 230
1	HRVF5048P	Abound Panel Frame 50"H x 48"W	\$ 263	\$ 263
3	HRVF6524P	Abound Panel Frame 65"H x 24"W	\$ 249	\$ 747
1	HRVF6548P	Abound Panel Frame 65"H x 48"W	\$ 284	\$ 284
4	HRVTC24	Abound Top Cap Trim 24"W	\$ 31	\$ 124
2	HRVTC48	Abound Top Cap Trim 48"W	\$ 58	\$ 116
1	HHN831124	Flat Bracket 24"D	\$ 57	\$ 57
2	HRVFSB24	Abound Segment Bar 24"W	\$ 17	\$ 34
2	HRVFSB48	Abound Segment Bar 48"W	\$ 20	\$ 40
1	HRVT1524G	Abound 15" High Clear Glass Tile 15"H x 24"W	\$ 420	\$ 420
1	HRVT1548G	Abound 15" High Clear Glass Tile 15"H x 48"W	\$ 540	\$ 540
2	HRVT3024T	Abound Fabric Tile (Fabric Grade A) 30"H x 24"W	\$ 90	\$ 180
2	HRVT3048T	Abound Fabric Tile (Fabric Grade A) 30"H x 48"W	\$ 123	\$ 246
6	HRVT6024T	Abound Fabric Tile (Fabric Grade A) 60"H x 24"W	\$ 149	\$ 894
2	HRVT6048T	Abound Fabric Tile (Fabric Grade A) 60"H x 48"W	\$ 232	\$ 464
1	HSTB2W1	Bracket to Attach Towers to Worksurfaces	\$ 68	\$ 68
2	HWSB2	Worksurface Bracket Kit	\$ 40	\$ 80
TOTAL:			\$10,830	

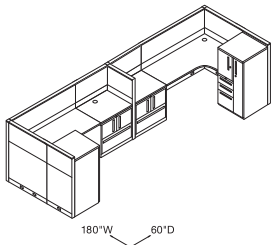

Teaming Station
180"W x 60"D

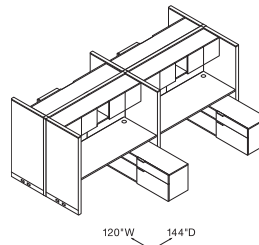

Teaming Station
120"W x 144"D

Qty.	Model #	Description	List Price	Price Extension
2	HFC1830DLFN	Flagship Lat File Bottom Door Top N Pull	\$1,063	\$ 2,126
2	HH871030	Electrical Pass-Thru w/o Power Block 3-1 & 2-2 30"	\$ 107	\$ 214
2	HH871260	Electrical Power Harness 3-1 & 2-2 Systems 60"W	\$ 194	\$ 388
1	HH873501	Circuit 1	\$ 37	\$ 37
1	HH873502	Circuit 2	\$ 37	\$ 37
2	HH873504	Circuit 4	\$ 37	\$ 74
1	HH879072	Base In-Feed Cable Base 3-1 & 2-2 Systems	\$ 206	\$ 206
3	HRVC50PF	Abound Finished End Painted 50"	\$ 82	\$ 246
2	HRVC50PL	Abound L Connector Painted 50"	\$ 137	\$ 274
1	HRVC50PT	Abound T Connector Painted 50"	\$ 137	\$ 137
3	HRVF5024P	Abound Panel Frame 50"H x 24"W	\$ 230	\$ 690
2	HRVF5030P	Abound Panel Frame 50"H x 30"W	\$ 242	\$ 484
2	HRVF5036P	Abound Panel Frame 50"H x 36"W	\$ 242	\$ 484
2	HRVF5060P	Abound Panel Frame 50"H x 60"W	\$ 288	\$ 576
2	HRVTC90	Abound Top Cap Trim 90"W	\$ 107	\$ 214
2	HRVTC60	Abound Top Cap Trim 60"W	\$ 71	\$ 142
1	HCTL242	Worksurface Cantilever 24"D	\$ 75	\$ 75
6	HRVFSB24	Abound Segment Bar 24"W	\$ 17	\$ 102
4	HRVFSB30	Abound Segment Bar 30"W	\$ 17	\$ 68
4	HRVFSB36	Abound Segment Bar 36"W	\$ 18	\$ 72
4	HRVFSB60	Abound Segment Bar 60"W	\$ 21	\$ 84
2	HRVT1524M	Abound Markerboard Tile 15"H x 24"W	\$ 213	\$ 426
4	HRVT1524ST	Abound Plains Tile and Mounting Kit 15"H x 24"W	\$ 253	\$ 1,012
4	HRVT1530ST	Abound Plains Tile and Mounting Kit 15"H x 30"W	\$ 294	\$ 1,176
4	HRVT1536ST	Abound Plains Tile and Mounting Kit 15"H x 36"W	\$ 361	\$ 1,444
4	HRVT1560ST	Abound Plains Tile and Mounting Kit 15"H x 60"W	\$ 447	\$ 1,788
6	HRVT3024T	Abound Fabric Tile (Fabric Grade A) 30"H x 24"W	\$ 90	\$ 540
4	HRVT3030T	Abound Fabric Tile (Fabric Grade A) 30"H x 30"W	\$ 95	\$ 380
4	HRVT3036T	Abound Fabric Tile (Fabric Grade A) 30"H x 36"W	\$ 107	\$ 428
4	HRVT3060T	Abound Fabric Tile (Fabric Grade A) 30"H x 60"W	\$ 137	\$ 548
2	HSTB2W1	Bracket to Attach Towers to Worksurfaces	\$ 68	\$ 136
2	HWR2430P	Systems Rectangular Worksurface Edgeband 24"D x 30"W	\$ 299	\$ 598
2	HWSB2	Worksurface Bracket Kit	\$ 40	\$ 80
1	HWV73AALP	Systems Lft Corner Cove Worksurface Edgebd 60" x 36" x 24" x 24"	\$ 572	\$ 572
1	HWV73AARP	Systems Rt Corner Cove Worksurface Edgebd 60" x 36" x 24" x 24"	\$ 572	\$ 572
1	HRVTC24	Abound Top Cap Trim 24"W	\$ 31	\$ 31
TOTAL:			\$16,461	

Qty.	Model #	Description	List Price	Price Extension
2	HH871036	Electrical Pass-Thru w/o Power Block 3-1 & 2-2 36"	\$ 107	\$ 214
1	HH871230	Electrical Power Harness 3-1 & 2-2 Systems 30"W	\$ 185	\$ 185
2	HH871236	Electrical Power Harness 3-1 & 2-2 Systems 36"W	\$ 185	\$ 370
2	HH873501	Circuit 1	\$ 37	\$ 74
2	HH873502	Circuit 2	\$ 37	\$ 74
4	HH873504	Circuit 4	\$ 37	\$ 148
1	HH879072	Base In-Feed Cable Base 3-1 & 2-2 Systems	\$ 206	\$ 206
4	HLSL1472D	Overhead Cab-4 Doors w/12" Cubbie 14 1/4"D x 72"W x 14"H	\$1,239	\$ 4,956
2	HLSL2060LL2	Low Credenza (LH Drws) 20" x 60" x 21 1/2"	\$1,131	\$ 2,262
2	HLSL2060LR2	Low Credenza (RH Drws) 20" x 60" x 21 1/2"	\$1,131	\$ 2,262
4	HLSLPMB	Stack-on Storage Panel Mounted Bracket	\$ 114	\$ 456
6	HRVC65PF	Abound Finished End Painted 65"	\$ 87	\$ 522
2	HRVC65PT	Abound T Connector Painted 65"	\$ 144	\$ 288
1	HRVC65PX	Abound X Connector Painted 65"	\$ 137	\$ 137
6	HRVF6530P	Abound Panel Frame 65"H x 30"W	\$ 254	\$ 1,524
6	HRVF6536P	Abound Panel Frame 65"H x 36"W	\$ 259	\$ 1,036
6	HRVTC30	Abound Top Cap Trim 30"W	\$ 38	\$ 228
2	HRVTC72	Abound Top Cap Trim 72"W	\$ 90	\$ 180
4	HLSL25SC72	External Stiffener 72"W	\$ 97	\$ 388
12	HRVT6030T	Abound Fabric Tile (Fabric Grade A) 60"H x 30"W	\$ 170	\$ 2,040
8	HRVT6036T	Abound Fabric Tile (Fabric Grade A) 60"H x 36"W	\$ 193	\$ 1,544
4	HWR3072P	Systems Rectangular Worksurface Edgeband 30"D x 72"W	\$ 556	\$ 2,224
8	HWSB2	Worksurface Bracket Kit	\$ 40	\$ 320
TOTAL:			\$21,638	

About® Open Base Typicals

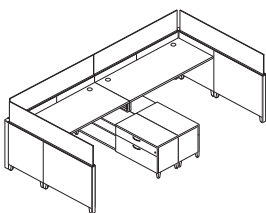

U-Shape Teaming Station
144" W x 72" D

Qty.	Model #	Description	List Price	Price Extension
2	HLSLZ5SC72	External Stiffener 72"W	\$ 97	\$ 194
2	HRFF3530P	About Panel Frame 35"H x 30"W	\$ 215	\$ 430
4	HRVT3030T	About Fabric Tile (Fabric Grade A) 30"H x 30"W	\$ 95	\$ 380
4	HRFF3536P	About Panel Frame 35"H x 36"W	\$ 220	\$ 880
8	HRVT3036T	About Fabric Tile (Fabric Grade A) 30"H x 36"W	\$ 107	\$ 856
2	HRFF3542P	About Panel Frame 35"H x 42"W	\$ 229	\$ 458
4	HRVT3042T	About Fabric Tile (Fabric Grade A) 30"H x 42"W	\$ 116	\$ 464
2	HRVC35PF	About Finished End Painted 35"	\$ 68	\$ 136
2	HRVC35PL	About L Connector Painted 35"	\$ 121	\$ 242
4	HRVT1572F	Frameless Frosted Glass 15"H x 72"W	\$ 853	\$ 3,412
2	HSCACW35	Contain® 35 LB Credenza Counterweight Kit	\$ 179	\$ 358
2	HSCAUC1836	Contain® Credenza Cushion (Fabric Grade 2) 36"W x 18"D	\$ 293	\$ 586
2	HSCAWS6530	Worksurface O-Leg 6.5"H x 30"W	\$ 206	\$ 412
1	HSCSF227218LBFOLA	Contain® Footed Metal Credenza with Laminate Front, Left 22" x 72" x 18"	\$2,107	\$ 2,107
1	HSCSF227218RBFOLA	Contain® Footed Metal Credenza with Laminate Front, Right 22" x 72" x 18"	\$2,107	\$ 2,107
2	HWR3072P	Systems Rectangular Worksurface Edgeband 30"D x 72"W	\$ 556	\$ 1,112
2	HWSB2	Worksurface Bracket Kit	\$ 40	\$ 80
TOTAL:			\$14,214	

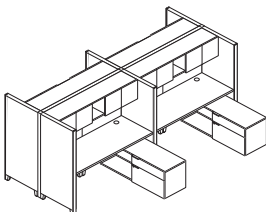

Teaming Station
144" W x 120" D

Qty.	Model #	Description	List Price	Price Extension
6	HRFF6530P	About Panel Frame 65"H x 30"W	\$ 254	\$ 1,524
12	HRVT6030T	About Fabric Tile (Fabric Grade A) 60"H x 30"W	\$ 170	\$ 2,040
4	HRFF6536P	About Panel Frame 65"H x 36"W	\$ 259	\$ 1,036
8	HRVT6036T	About Fabric Tile (Fabric Grade A) 60"H x 36"W	\$ 193	\$ 1,544
6	HRVTC30	About Top Cap Trim 30"W	\$ 38	\$ 228
2	HRVTC72	About Top Cap Trim 72"W	\$ 90	\$ 180
4	HLSLZ5SC72	External Stiffener 72"W	\$ 97	\$ 388
4	HLSL1472D	Overhead Cab-4 Doors with Cubbie 14.25"D x 72"W x 14"H	\$1,239	\$ 4,956
2	HLSL2060LL2	Low Credenza (LH Drws) 20" x 60" x 21 1/2"	\$1,131	\$ 2,262
2	HLSL2060LR2	Low Credenza (RH Drws) 20" x 60" x 21 1/2"	\$1,131	\$ 2,262
4	HLSLPMB	Stack-on Storage Panel Mounted Bracket	\$ 114	\$ 456
6	HRVC65PF	About Finished End Painted 65"	\$ 87	\$ 522
2	HRVC65PT	About T Connector Painted 65"	\$ 144	\$ 288
1	HRVC65PX	About X Connector Painted 65"	\$ 137	\$ 137
4	HWR2472P	Systems Rectangular Worksurface Edgeband 24"D x 72"W	\$ 496	\$ 1,984
8	HWSB2	Worksurface Bracket Kit	\$ 40	\$ 320
TOTAL:			\$20,127	

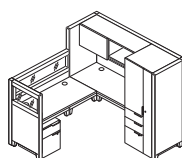

L-Shape Workstation with Storage Tower
72" W x 72" D

Qty.	Model #	Description	List Price	Price Extension
1	HRFF5024P	About Panel Frame 50"H x 24"W	\$ 230	\$ 230
2	HRVT3024T	About Fabric Tile (Fabric Grade A) 30"H x 24"W	\$ 90	\$ 180
1	HRVT1524G	About 15" High Clear Glass Tile 12"H x 24"W	\$ 420	\$ 420
2	HRVFSB24	About 24"W Segment Bar	\$ 17	\$ 34
1	HRFF5048P	About Panel Frame 50"H x 48"W	\$ 263	\$ 263
2	HRVT3048T	About Fabric Tile (Fabric Grade A) 30"H x 48"W	\$ 123	\$ 246
1	HRVT1548G	About 15" High Clear Glass Tile 15"H x 48"W	\$ 540	\$ 540
2	HRVFSB48	About 48"W Segment Bar	\$ 20	\$ 40
3	HRFF6524P	About Panel Frame 65"H x 24"W	\$ 249	\$ 747
6	HRVT6024T	About Fabric Tile (Fabric Grade A) 60"H x 24"W	\$ 149	\$ 894
1	HRFF6548P	About Panel Frame 65"H x 48"W	\$ 284	\$ 284
2	HRVT6048T	About Fabric Tile (Fabric Grade A) 60"H x 48"W	\$ 232	\$ 464
1	HLSL1448S	Overhead Cabinet with Sliding Door 48"W x 14 1/4"D x 14"H	\$ 954	\$ 954
1	HLSL2016MP2	Mobile Ped 20" x 15 1/8" x 21 1/2"	\$ 716	\$ 716
1	HLSL2016PH2	Ped Cushion 20 x 15 1/8 x 1	\$ 297	\$ 297
1	HLSLPMB	Stack-on Storage Panel Mounted Bracket	\$ 114	\$ 114
1	HLSLW446RP	Personal Storage Tower (RH) 24"D x 24"W x 65"H	\$2,311	\$ 2,311
1	HRVC15PFV	About Variable Height Finished End Painted 15"	\$ 55	\$ 55
1	HRVC50PF	About Finished End Painted 50"	\$ 82	\$ 82
1	HRVC50PL	About L Connector Painted 50"	\$ 137	\$ 137
1	HRVC65PF	About Finished End Painted 65"	\$ 87	\$ 87
2	HRVC65PL	About L Connector Painted 65"	\$ 144	\$ 288
1	HSTB2W1	Bracket to Attach Towers to Worksurfaces	\$ 68	\$ 68
2	HWR2448P	Systems Rectangular Worksurface Edgeband 24"D x 48"W	\$ 379	\$ 758
2	HWSB2	Worksurface Bracket Kit	\$ 40	\$ 80
1	HRVTC24	About Top Cap Trim 24"W	\$ 31	\$ 31
1	HRVTC48	About Top Cap Trim 48"W	\$ 58	\$ 58
1	HRVTC72	About Top Cap Trim 72"W	\$ 90	\$ 90
1	HNN831124	Flat Bracket 24"D	\$ 57	\$ 57
TOTAL:			\$10,525	

Panel Frame

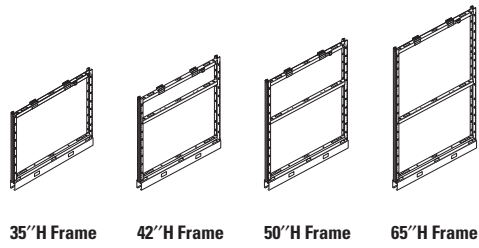

Open Base Panel Frame

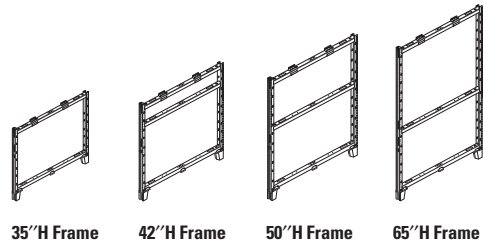

Stacking Frames

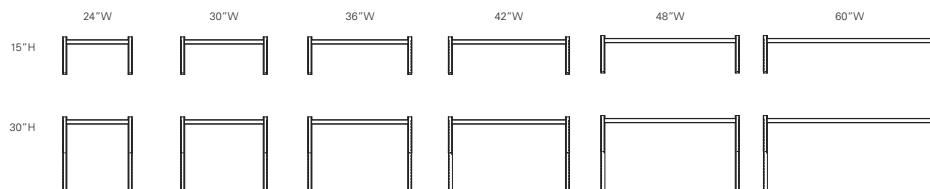
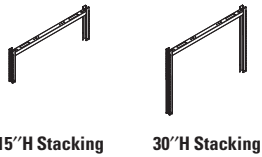

Reminder: Panel frame top caps must be ordered separately. Please refer to page 323. Do not specify top caps when putting frameless glass on top of the panel frame or when using a countertop workspace.

About® Frames Overview

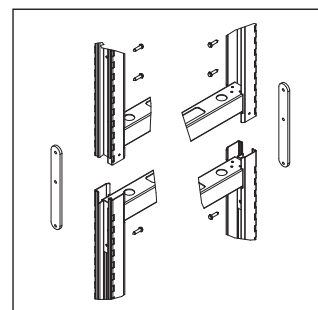
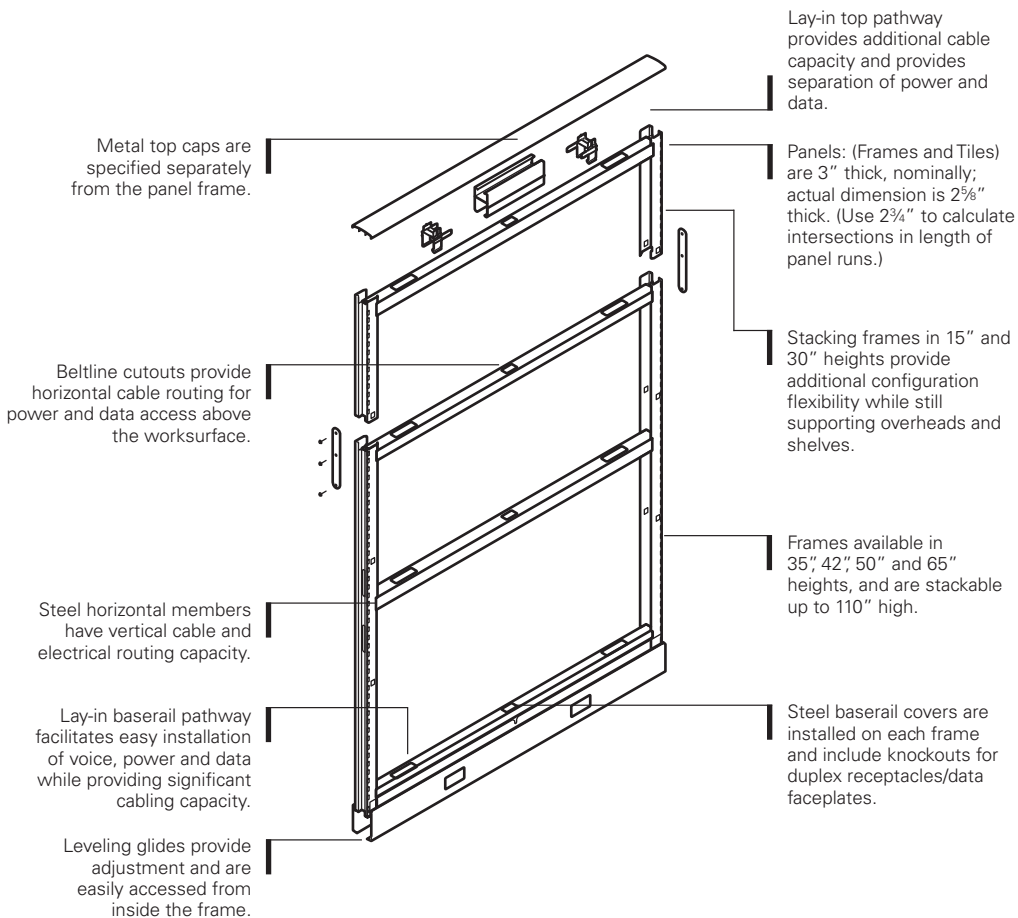

Stacking connection provides a solid metal-to-metal connection, allowing the stacking frame to accept hang-on components, per configuration guidelines.

Construction and Features

Specifications—formed, steel vertical members, with tubular steel horizontal members are welded into a sturdy, structural panel frame. Panel frames are shipped with base pathway covers installed.

Tiles, Panel Top Caps, and Segment Bars are ordered separately.

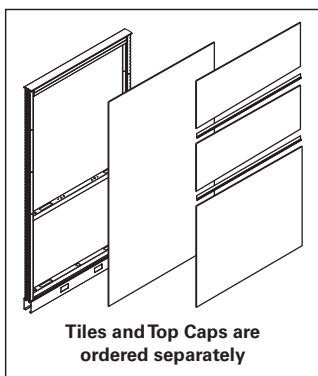

Additional design and specification information available at hon.com.

Frame Dimensions (Actual)

Depth: 2⁵/₈" (use 2³/₄" to calculate intersections in length of panel run)

Widths: 24", 30", 36", 42", 48", 60"

Heights*: Painted trim: 34¹/₂", 42", 49¹/₂", 64¹/₂"

Stacking Frames: 15"H, 30"H

*with levelers fully retracted

Stacking frames can be added to the top of any 35"H, 50"H or 65"H frame. Adding stacking frames to 42"H frames is not recommended due to inconsistencies in segmentation. 15"H and 30"H stacking frames can be used to add up to 45" of additional height to a standard frame. Do not combine differing frame widths in a single stack.

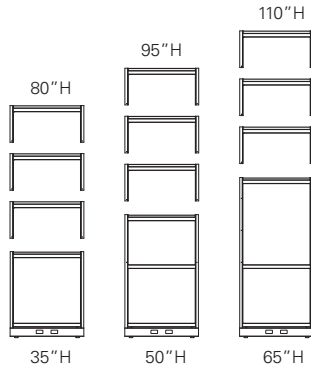

NOTE: When stacking on 42¹/₂"H frames, panel slots will be off by 1/2" compared to any other height panel. When stacking on 42¹/₂"H frames, hanging accessories will be 1/2" off in height compared to accessories hanging on panels at any height other than 42¹/₂"H.

Building horizontally with Abound frames

Important planning guidelines: For adequate stability, one of two methods of stabilization must be adhered to:

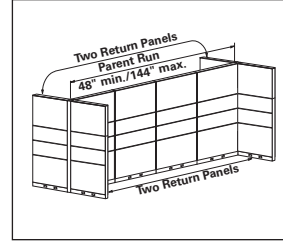

Method 1—Opposing returns:

A parent run must be a minimum of 48" and a maximum of 144" between return panels. The parent run must have a minimum of two return panels running in opposing directions on each end of run.

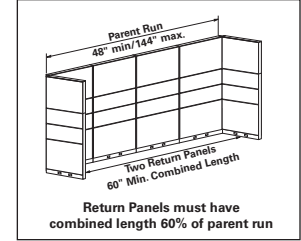

Method 2—Single-sided returns:

A parent run must be a minimum of 48" and a maximum of 144" between return panels. The parent run must have a minimum of two return panels totaling at least 60% of its length, extending in one direction. Return panels must not be any more than 30" shorter in height than parent run. When using 120° connections, 12" must be added to length of return panels as determined by methods 1 and 2. Any run under 100" must have a minimum combined length of 60" of return panels.

About® Frames Overview

Intersecting connections

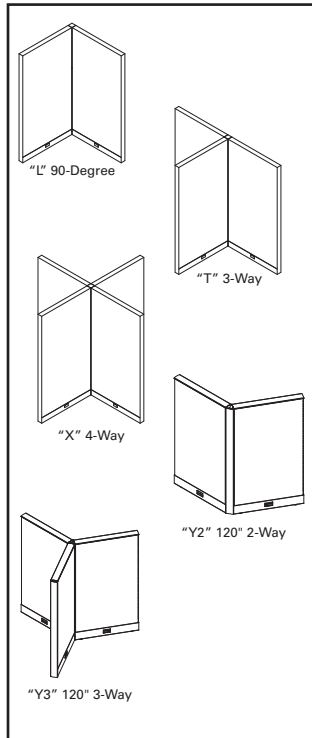

“L”, “T”, “X”, “Y2” and “Y3” connector kits are used when connecting frames at intersecting runs. For “L”, “T” and “X” connector kits, add 2¾” to the total length of the panel run for each intersection, whether located in the middle or at the end of the run.

Wall starter kits provide a means to affix a panel run to a permanent building wall. Kit adds 1½/32” to length of panel run.

Segment Bars — horizontal cross members required between tile segments. Must be specified on each side of frame. One Segment Bar is needed for each reveal between tiles.

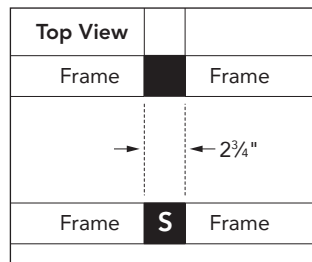
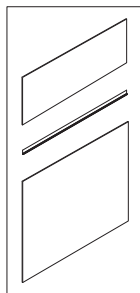

Extended straight connector kit “S” can be used to keep continuous runs dimensionally consistent with opposing panel runs which incorporate “T” or “X” intersections. (Add 2¾” to the length of the run for every extended straight connector used.)

In-line connections

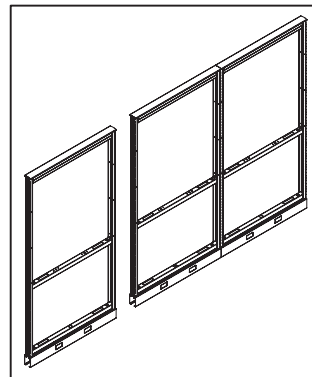

Direct connections between same height frames in a continuous run are accomplished with provided hardware. There is no incremental increase in dimension along the run.

End of Run

Finished end trim must be specified for the unconnected sides of panel frames. The Abound end trim adds 3/8” to the length of the panel run. When adding a stacking frame, order finished end trim in the height that matches the stacking frame height. Move the end cap from the standard frame end trim to the stacking frame end trim.

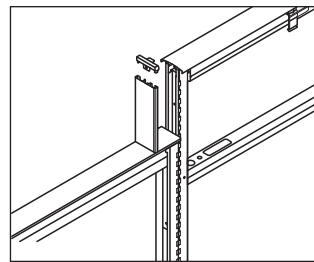

In-line Variable Height Trim In-line connections between different height panels require trim to cover the exposed frame of the taller panel. The bottom of the trim is contoured to match the profile of the frame top cap.

Multiple-height connections are accomplished by combining standard height panel connectors (35”H, 42”H, 50”H and 65”H) with shorter connectors (7”H, 15”H, 22”H and 30”H). Start from the bottom-up — select the standard connector that corresponds to the height and connection type of the shortest panel, then use the shorter connectors to build up to each subsequent panel height. (See examples.)

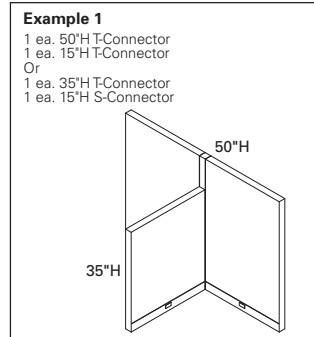

In variable height “T” connections — as shown above — you would use the connectors as indicated.

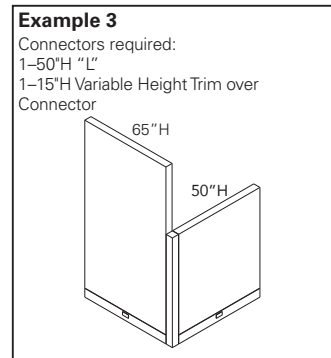
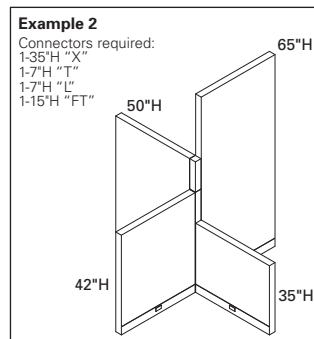

Example above represents Abound variable height “L” for 65” to 50” connection over connector.

Variable Height Connection Trim

L, X and T connections between different height panels require trim to cover the exposed frame of the taller panel. The bottom of the trim is flat to match the profile of the Universal Connector top cap. Models are designated as “Variable Height Finished End over Connector Trim”. For variable height connections in a Y configuration, contact the HON Product Solutions group.

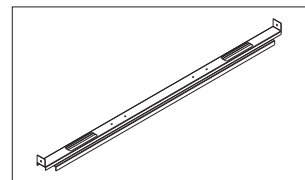

Optional Stiffener Support

Stiffener supports can be used to provide additional rigidity to a panel when fabric tiles are on both sides of the frame. May also be used for routing power/data at non-standard heights.

Connector Kits — Abound

- "L" 90° Connector Kit
- "T" 3-way Connector Kit
- "X" 4-way Connector Kit
- "S" "S" Extended Straight Connector Kit
- "Y2" 2-way 120° Connector Kit
- "Y3" 3-way 120° Connector Kit
- "W" Wall Starter Kit
- "F" End Trim Kit
- "V" Variable Height Finished End
- "FT" Variable Height Finished End over Connector

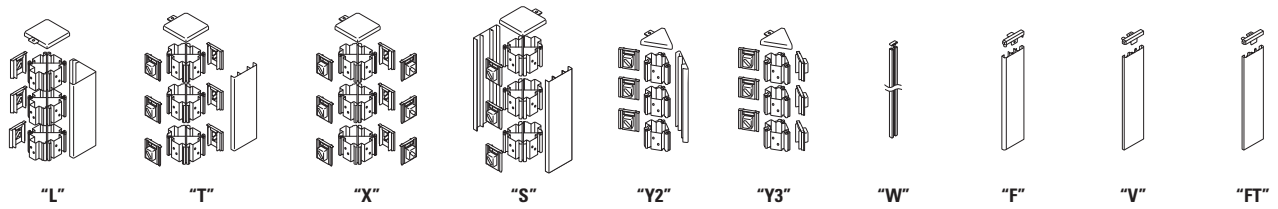

- Abound Connector Kits include universal connector block(s), bracket clips and painted metal trim.
- The universal connector block can be used for an L, T, X, or Extended Straight connections, simplifying staging and installation at the project site as well as future reconfigurations.
- Bracket clips are attached to the connector blocks as needed based upon connection type.
- While the connectors themselves are universal, Abound connector kits must be specified by connection type (X, L, T, S, 120 degree) in order to receive the correct type of trim.

Abound® Tile Overview

Abound tiles come in a variety of styles.

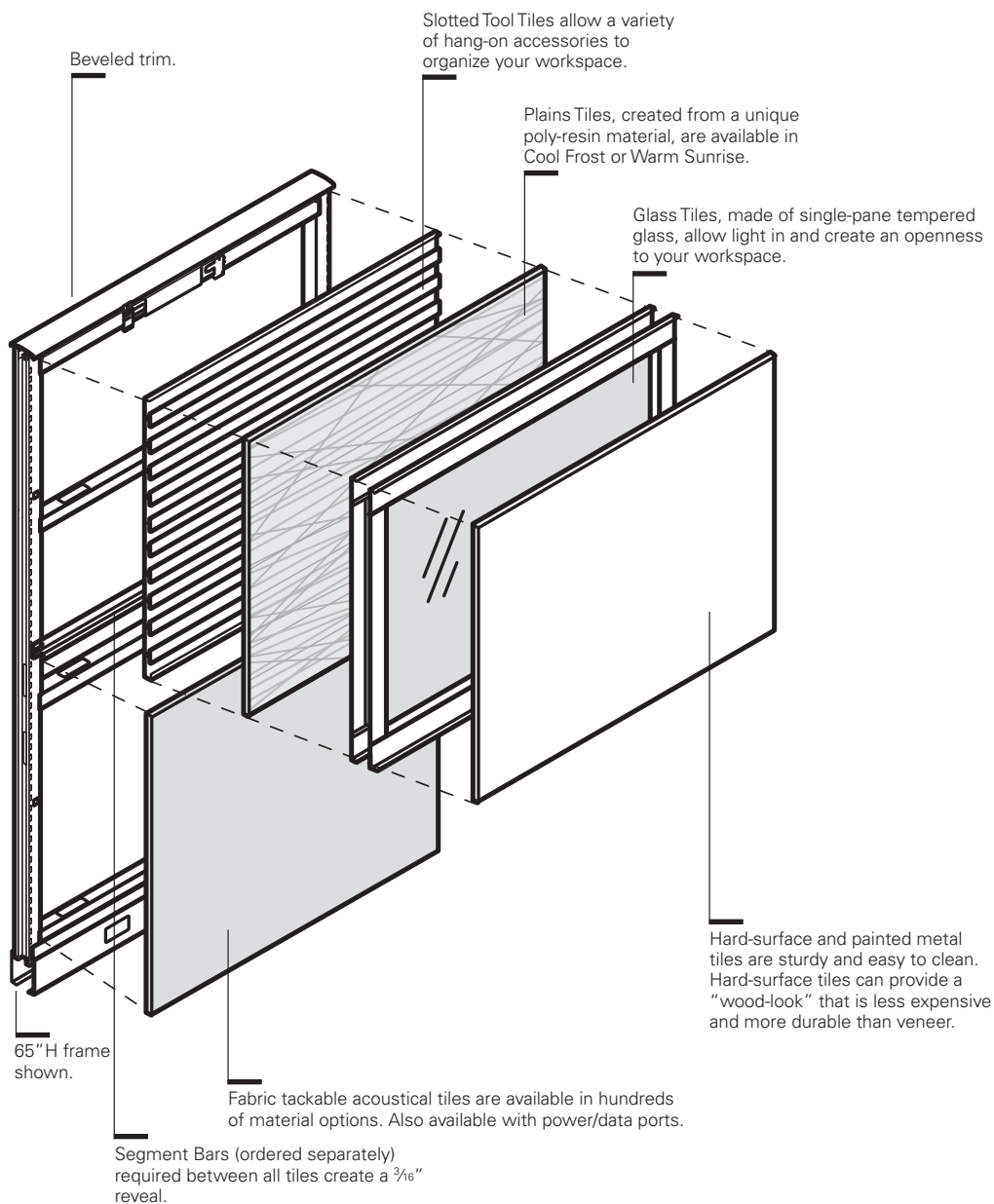

*Aesthetics of opposing tile surface and/or frame interior should be considered when selecting light colored sheer materials.

Tile Heights

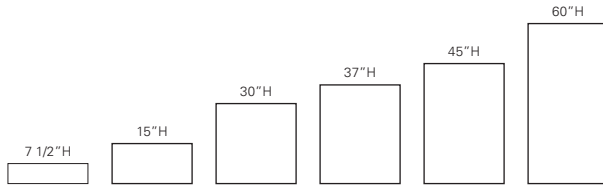

Monolithic tiles are 5" shorter than frame heights to account for top trim and base raceway.

Typical Tile Height Configurations

Segment bars are required between any two tiles — order separately based on tile configuration on each side of frame. Note: Most CAD specification programs will calculate quantity of segment bars required.

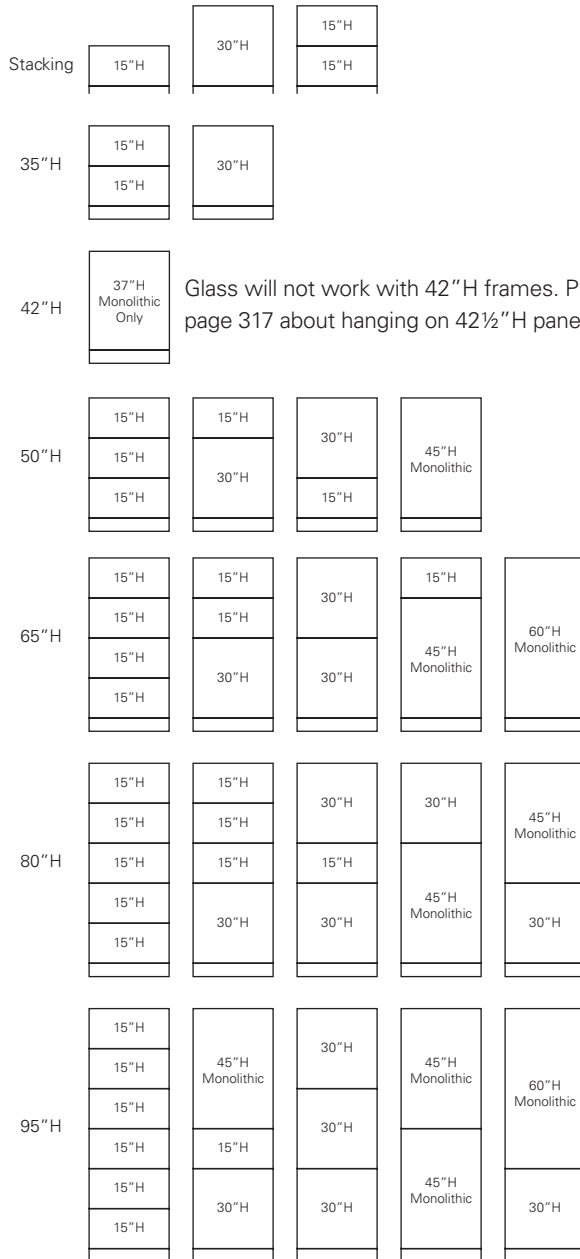

*Additional tile combinations to those shown above are possible; heights above 65" require stacking frames - maximum height is 110".

To calculate the total height of tiles(s) required, deduct 5" (height of base/top trim) from the total nominal panel height.
EXAMPLE: 65"H Frame takes 2 30"H tiles. $65 - 5 = 2 \times 30$ or $45 + 15$

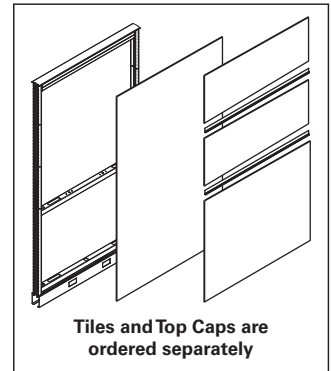

Tiles can be ordered in the size that matches the frame height plus the stacker height.

EXAMPLE: If you are using a 35"H frame plus a 30"H stacker, you can order 2 – 30"H tiles or 1 – 60"H tile.

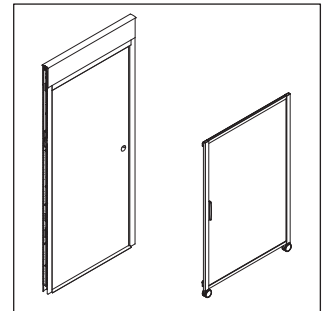

Door panels include frame, 42"W door, hinges and attaching hardware. Two 7½"H fabric tiles for the top of the door frame are required and ordered separately (HRVD0742T).

Sliding doors are available in 50", 65", and 80"H models and can mount to 30", 36", 42", and 48"W panels. The doors provide a 36"W opening and are 42"W, nominally. The doors ship non-handed. A Mounting Bracket Kit must be ordered for each door corresponding to the mounting panel's width (30", 36", 42", or 48"W).

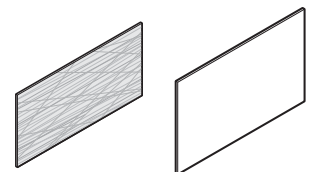

Plains Tiles and Hard-surface Tiles include tile and Custom Bracket Kit.

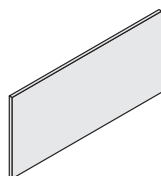

Fabric Tackable Acoustical Tile

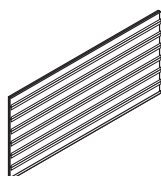

Slotted Tool Tile

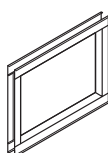

Glass Tile

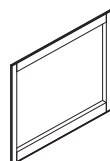

Pass-thru Tile

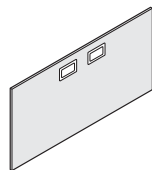

Fabric Tackable Acoustical Ported Tile

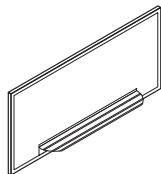

Markerboard Tile
*Markerboard tray ordered separately

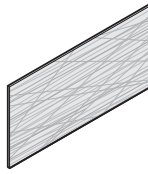

Plains Tile

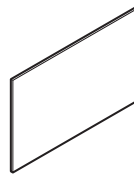

Hard-surface Tiles

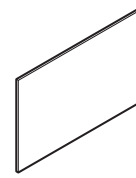

Painted Metal Tile

Tiles — Tackable Acoustical, Tackable Acoustical/Ported

	24"W	30"W	36"W	42"W	48"W	60"W
7 1/2"H						
15"H						
30"H						
37"H						
45"H						
60"H						

Glass Tile Kits, Markerboard, Plains, Painted Metal Tiles

	24"W	30"W	36"W	42"W	48"W	60"W
15"H						
30"H						

Pass-thru Tiles

	24"W	30"W	36"W	42"W	48"W	60"W
30"H						

Slotted Tool Tile

	24"W	30"W	36"W	42"W	48"W	60"W
15"H						

Hard-surface Tiles

	24"W	30"W	36"W	42"W	48"W	60"W
15"H						
30"H						
37"H						

- ▶ Includes frame, baserail covers, attaching hardware and bottom segment bar.
- ▶ Frames, top caps and tiles are ordered and shipped separately.
- ▶ Frames are 2 5/8" thick with a 5"H baserail.
- ▶ Frames are standard with two adjustable leveling glides which can be adjusted from the bottom of the glide or from the interior of frame.
- ▶ Two wire and data management openings standard per raceway, 24" panel has one opening.
- ▶ Lay-in wire management available in base. Horizontal cable routing available at beltline.
- ▶ Lay-in top pathway provides additional data cabling capacity.
- ▶ For workspaces that can be used with both Abound® and Accelerate® systems, see pages 395-406.
- ▶ **When stacking on 42 1/2" H frames, panel slots will be off by 1/2" compared to any other height panel.**
- ▶ **When stacking on 42 1/2" H frames, hanging accessories will be 1/2" off in height compared to accessories hanging on panels at any height other than 42 1/2" H.**



	Description	Model	Ship Weight	Cube	List by Paint Grade	
					Core	Metallics
	35"H Panel Frame					
	35"H x 24"W	HRVF3524P	8.0	1.7	\$ 210	\$ 246
	35"H x 30"W	HRVF3530P	11.0	2.1	\$ 215	\$ 251
	35"H x 36"W	HRVF3536P	13.0	2.4	\$ 220	\$ 256
	35"H x 42"W	HRVF3542P	16.0	2.8	\$ 229	\$ 265
	35"H x 48"W	HRVF3548P	18.0	3.2	\$ 242	\$ 278
	35"H x 60"W	HRVF3560P	23.0	4.0	\$ 269	\$ 305
	42"H Panel Frame					
	42"H x 24"W	HRVF4224P	11.0	2.0	\$ 215	\$ 251
	42"H x 30"W	HRVF4230P	14.0	2.4	\$ 224	\$ 260
	42"H x 36"W	HRVF4236P	17.0	2.9	\$ 229	\$ 265
	42"H x 42"W	HRVF4242P	19.0	3.4	\$ 243	\$ 279
	42"H x 48"W	HRVF4248P	22.0	3.8	\$ 254	\$ 290
	42"H x 60"W	HRVF4260P	28.0	4.7	\$ 283	\$ 319
	⚠ When stacking on 42 1/2" H frames, panel slots will be off by 1/2" compared to any other height panel. ⚠ When stacking on 42 1/2" H frames, hanging accessories will be 1/2" off in height compared to accessories hanging on panels at any height other than 42 1/2" H.					
	50"H Panel Frame					
	50"H x 24"W	HRVF5024P	14.0	2.3	\$ 230	\$ 266
	50"H x 30"W	HRVF5030P	17.0	2.9	\$ 242	\$ 278
	50"H x 36"W	HRVF5036P	20.0	3.4	\$ 242	\$ 278
	50"H x 42"W	HRVF5042P	24.0	4.0	\$ 257	\$ 293
	50"H x 48"W	HRVF5048P	27.0	4.5	\$ 263	\$ 299
	50"H x 60"W	HRVF5060P	34.0	5.6	\$ 288	\$ 324
	65"H Panel Frame					
	65"H x 24"W	HRVF6524P	17.0	3.0	\$ 249	\$ 285
	65"H x 30"W	HRVF6530P	22.0	3.7	\$ 254	\$ 290
	65"H x 36"W	HRVF6536P	25.0	4.4	\$ 259	\$ 295
	65"H x 42"W	HRVF6542P	30.0	5.1	\$ 270	\$ 306
	65"H x 48"W	HRVF6548P	35.0	5.8	\$ 284	\$ 320
	65"H x 60"W	HRVF6560P	43.0	7.2	\$ 312	\$ 348
	Panel Top Cap					
	24"W	HRVTC24	1.6	0.3	\$ 31	\$ 51
	30"W	HRVTC30	1.8	0.3	\$ 38	\$ 58
	36"W	HRVTC36	2.0	0.3	\$ 49	\$ 69
	42"W	HRVTC42	2.2	0.3	\$ 52	\$ 72
	48"W	HRVTC48	3.4	0.4	\$ 58	\$ 78
	54"W	HRVTC54	3.7	0.5	\$ 71	\$ 91
	60"W	HRVTC60	3.9	0.6	\$ 71	\$ 91
	66"W	HRVTC66	4.0	0.6	\$ 86	\$ 106
	72"W	HRVTC72	5.3	0.8	\$ 90	\$ 110
	78"W	HRVTC78	6.5	0.8	\$ 93	\$ 113
	84"W	HRVTC84	6.7	0.9	\$ 102	\$ 122
90"W	HRVTC90	7.0	0.9	\$ 107	\$ 127	
96"W	HRVTC96	7.2	0.9	\$ 113	\$ 133	

NOTES: Top caps can span more than one panel in an inline connection.

⚠ **Top cap models are to be used on Abound® frames only.**

How to specify	Select Model Number from above	1st Option
	H R V F 3 5 2 4 P .	Select Trim Color See page 309 T 4



About® Open Base Panel Frames

GSA SIN 711-1



- ▶ Includes frame, attaching hardware and bottom segment bar.
- ▶ Tiles and top caps are ordered and shipped separately.
- ▶ Frames are 2 3/4" thick with a 5"H open base.



- ▶ Frames are standard with two adjustable leveling glides which can be adjusted from the bottom of the glide.
- ▶ Horizontal cable routing available at beltline.

- ▶ Lay-in top pathway provides additional data cabling capacity.
- ▶ See page 323 for top cap options.
- ▶ For worksurfaces that can be used with About® and Accelerate® systems, see pages 395-406.

⚠ When stacking on 42 1/2"H frames, panel slots will be off by 1/2" compared to any other height panel.

⚠ When stacking on 42 1/2"H frames, hanging accessories will be 1/2" off in height compared to accessories hanging on panels at any height other than 42 1/2"H.

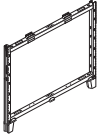
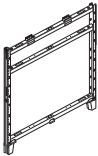
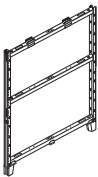
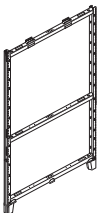

Description	Model	Ship Weight	Cube	List by Paint Grade	
				Core	Metallics
 <p>35"H Open Base Panel Frame 35"H x 24"W 35"H x 30"W 35"H x 36"W 35"H x 42"W 35"H x 48"W 35"H x 60"W</p>	HRFF3524P	8	1.7	\$ 210	\$ 246
	HRFF3530P	11	2.1	\$ 215	\$ 251
	HRFF3536P	13	2.4	\$ 220	\$ 256
	HRFF3542P	16	2.8	\$ 229	\$ 265
	HRFF3548P	18	3.2	\$ 242	\$ 278
	HRFF3560P	23	4.0	\$ 269	\$ 305
 <p>42"H Open Base Panel Frame 42"H x 24"W 42"H x 30"W 42"H x 36"W 42"H x 42"W 42"H x 48"W 42"H x 60"W</p> <p>⚠ When stacking on 42 1/2"H frames, panel slots will be off by 1/2" compared to any other height panel. ⚠ When stacking on 42 1/2"H frames, hanging accessories will be 1/2" off in height compared to accessories hanging on panels at any height other than 42 1/2"H.</p>	HRFF4224P	11	2.0	\$ 215	\$ 251
	HRFF4230P	14	2.4	\$ 224	\$ 260
	HRFF4236P	17	2.9	\$ 229	\$ 265
	HRFF4242P	19	3.4	\$ 243	\$ 279
	HRFF4248P	22	3.8	\$ 254	\$ 290
	HRFF4260P	28	4.7	\$ 283	\$ 319
 <p>50"H Open Base Panel Frame 50"H x 24"W 50"H x 30"W 50"H x 36"W 50"H x 42"W 50"H x 48"W 50"H x 60"W</p>	HRFF5024P	14	2.3	\$ 230	\$ 266
	HRFF5030P	17	2.9	\$ 242	\$ 278
	HRFF5036P	20	3.4	\$ 242	\$ 278
	HRFF5042P	24	4.0	\$ 257	\$ 293
	HRFF5048P	27	4.5	\$ 263	\$ 299
	HRFF5060P	34	5.6	\$ 288	\$ 324
 <p>65"H Open Base Panel Frame 65"H x 24"W 65"H x 30"W 65"H x 36"W 65"H x 42"W 65"H x 48"W 65"H x 60"W</p>	HRFF6524P	17	3.0	\$ 249	\$ 285
	HRFF6530P	22	3.7	\$ 254	\$ 290
	HRFF6536P	25	4.4	\$ 259	\$ 295
	HRFF6542P	30	5.1	\$ 270	\$ 306
	HRFF6548P	35	5.8	\$ 284	\$ 320
	HRFF6560P	43	7.2	\$ 312	\$ 348
 <p>Raceway to Open Base Conversion Kit</p>	HRVFFOOT	4	0.1	\$ 150	\$ 170

How to specify	Select Model Number from above H R F F 3 5 2 4 P .	1st Option Select Trim Color See page 309 T 4
----------------	--	---

Icon Legend on page 10

- ▶ Frames, top caps and tiles are ordered and shipped separately.
- ▶ Includes attachment hardware.
- ▶ Stacking frames can be added to the top of any 35"H, 50" or 65"H frame.
- ▶ No paint selection necessary on stacking frames.
- ▶ Overhead storage units can be suspended from stacking frames. See pages 368-369.
- ▶ Segment Bars do not need to be specified for monolithic tiles, when only a single tile is attached to the frame.
- ▶ For worksurfaces that can be used with both About® and Accelerate® systems, see pages 395-406.
- ⚠ **When stacking on 42 1/2" H frames, panel slots will be off by 1/2" compared to any other height panel.**
- ⚠ **When stacking on 42 1/2" H frames, hanging accessories will be 1/2" off in height compared to accessories hanging on panels at any height other than 42 1/2" H.**
- ⚠ **Not designed to combine differing frame widths in a single stack.**
- ⚠ **Stacking frames not designed to be used as a base frame.**
- ⚠ **Segment bars available in Black only.**
- ⚠ **Segment Bars are formed, steel cross members and are required between tiles and on each side of the frame.**



	Description	Model	Ship Weight	Cube	List
	15"H Stacking Panel Frame				
	15"H x 24"W	HRVF1524	8	0.8	\$ 195
	15"H x 30"W	HRVF1530	10	0.9	\$ 204
	15"H x 36"W	HRVF1536	12	1.1	\$ 210
	15"H x 42"W	HRVF1542	14	1.3	\$ 218
	15"H x 48"W	HRVF1548	16	1.5	\$ 220
	15"H x 60"W	HRVF1560	20	1.8	\$ 227
	30"H Stacking Panel Frame				
	30"H x 24"W	HRVF3024	10	1.4	\$ 206
	30"H x 30"W	HRVF3030	12	1.8	\$ 218
	30"H x 36"W	HRVF3036	14	2.1	\$ 225
	30"H x 42"W	HRVF3042	16	2.4	\$ 234
	30"H x 48"W	HRVF3048	18	2.8	\$ 238
	30"H x 60"W	HRVF3060	22	3.4	\$ 252
	Full Segment Bars				
	24"W	HRVFSB24	2	0.4	\$ 17
	30"W	HRVFSB30	2	0.4	\$ 17
	36"W	HRVFSB36	3	0.5	\$ 18
	42"W	HRVFSB42	3	0.5	\$ 19
	48"W	HRVFSB48	3	0.6	\$ 20
	60"W	HRVFSB60	4	0.7	\$ 21

⚠ **Must order one segment bar per panel reveal, per panel side.**

How to specify

Select Model Number from above
H | R | V | F | 1 | 5 | 2 | 4

Icon Legend on page 10

desks workstations storage & files seating tables education/learning accessories bundles index

About® Stiffener Supports

GSA SIN 711-1



- ▶ Tile stiffener supports can be used to increase the stiffness of a panel and can also be used to mount power/data anywhere vertically on an Abound frame. Can only be used when there are fabric tiles on both sides of the frame.
 - ▶ Self-drilling screws included.
 - ▶ For worksurfaces that can be used with both Abound® and Accelerate® systems, see pages 395-406.
- ⚠ **Black only. No need to specify paint.**



	Description	Model	Ship Weight	Cube	List
	Stiffener Support				
	24"W	HRVSS24	1	0.4	\$ 48
	30"W	HRVSS30	1	0.4	\$ 50
	36"W	HRVSS36	4	0.5	\$ 54
	42"W	HRVSS42	4	0.5	\$ 68
	48"W	HRVSS48	4	0.5	\$ 76
	60"W	HRVSS60	4	0.7	\$ 83
	⚠ Black only. No need to specify paint.				

Door Panel Frame

► Includes frame, 42"W door, hinges and attaching hardware.

► Lockset or Knob ordered separately.

⚠ 7 1/2" H tiles above the door are required and must be specified and ordered separately.

► See page 323 for top cap specification.



Description	Model	Ship Weight	Cube	L1 List by Paint Grade	
				Core	Metallics
Door Panel — Laminate 42"W x 95"H ⚠ Fabric tiles for above the door are required for door installation. Order tiles separately — see below. ⚠ Two tiles are required for installation. ⚠ Top Cap must be ordered separately.	HRVD9542P	155	5.4	\$2032	\$2068



How to specify





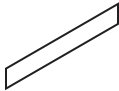

Select Model Number from above H R V D 9 5 4 2 P .	1st Option Select Trim Color See page 309 T 4 .	2nd Option Select Door Laminate L2 Laminate Upcharge \$60 See page 309 K 2
--	---	---

Description	Model	Ship Weight	Cube	List by Fabric Grade						
				A	B	C	D	E	F	G
Fabric Tiles for Door Panel 7 1/2"H x 42"W ⚠ Must be ordered with the Door Panel model above. ⚠ Required for door installation. ⚠ Two tiles must be ordered for installation. Tiles ship 1/pkg.	HRVD0742T	3	1.2	\$ 75	\$ 79	\$ 83	\$ 93	\$ 96	\$ 100	\$ 104



How to specify

Select Model Number from above H R V D 0 7 4 2 T .	1st Option Select Fabric Color See pages 310-311 A P N 1 5
--	--

Description	Model	Ship Weight	Cube	List
 Lockset (Door Knob) Polished Brass, keyed on one side	HN899900	2.0 	0.1	\$ 106
 Door Lever Brushed Aluminum, keyed on one side	HN899910	2.0 	0.1	\$ 296
 Carpet Grippers NOTES: Used with Glide Towers Shipped 12 per package No need to specify finish	HICG12	0.5 	0.1	\$ 17

About® Sliding Door

GSA SIN 711-1

HON

▶ The Sliding Doors are available in 50", 65", and 80"H models and can mount to 30", 36", 42", and 48"W panels.

▶ All doors are 42" wide, provide a 36"W opening, and are non-handed.

⚠ **A Mounting Bracket Kit must be ordered for each door corresponding to the mounting panels width (30", 36", 42", or 48"W).**

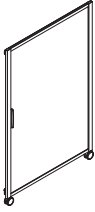
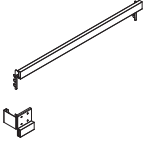

Description	Model	Ship Weight	Cube	List by Paint Grade	
				Core	Metallics
 <p>About Sliding Door 50"H x 42"W 65"H x 42"W 80"H x 42"W</p> <p>⚠ Door is only available in Frosted Translucent. Specify paint for frame. ⚠ Can only install Sliding Door at the end of a run, not at a corner.</p>	HH15042SD	28	5.5	\$1858	\$1894
	HH16542SD	38	7.1	\$2120	\$2156
	HH18042SD	46	8.6	\$2593	\$2629
	<p>⚠ Door is only available in Frosted Translucent. Specify paint for frame. ⚠ Can only install Sliding Door at the end of a run, not at a corner.</p>				
 <p>Mounting Kit for About Sliding Door For 30"W panel For 36"W panel For 42"W panel For 48"W panel</p> <p>NOTES: Specify paint.</p>	HHKDMK30	4	0.4	\$ 158	\$ 170
	HHKDMK36	5	0.5	\$ 165	\$ 177
	HHKDMK42	6	0.5	\$ 171	\$ 183
	HHKDMK48	7	0.5	\$ 180	\$ 192
	NOTES: Specify paint.				

How to specify

Select Model Number
from above

H | H | 1 | 5 | 0 | 4 | 2 | S | D | .

1st Option

Select Paint Color

See page 309

T | 1 |

Icon Legend on page 10

- ▶ All connectors include a light-gap strip.
 - ▶ Abound connectors utilize a universal connector block designed to make one connection to the panel.
 - ▶ Bracket clips come standard.
 - ▶ 7”H connectors include one connector block; 15”H, 22”H, 30”H include two connector blocks; 50”H includes three connector blocks and 65”H includes four connector blocks.
 - ▶ Connectors ship complete with trim.
 - ▶ No universal top cap with 7”H-30”H connectors. These are to be used where base height connectors are also used, therefore additional top caps are not necessary.
 - ▶ Outer trim snaps easily into place.
 - ▶ Extended Straight Connectors are used to keep a frame run dimensionally consistent with opposing frame runs. Add 2 3/4” to the length of the run with each Extended Straight Connector used.
- ⚠ **Trim with Abound connectors can only be attached to connectors, not on panels.**

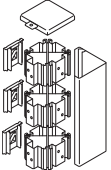
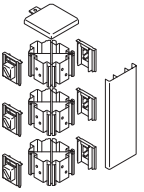
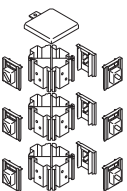
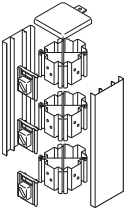

Description	Model	Ship		List by Paint Grade	
		Weight	Cube	Core	Metallics
 <p>“L” 90° Painted Connector 7”H Frame (Does not include top cap, see bullet above) 15”H Frame (Does not include top cap, see bullet above) 22”H Frame (Does not include top cap, see bullet above) 30”H Frame (Does not include top cap, see bullet above) 35”H Frame 42”H Frame 50”H Frame 65”H Frame 80”H Frame</p>	HRVC7PL	1 <input type="checkbox"/>	0.1	\$ 83	\$ 100
	HRVC15PL	2 <input type="checkbox"/>	0.1	\$ 94	\$ 111
	HRVC22PL	2 <input type="checkbox"/>	0.2	\$ 106	\$ 123
	HRVC30PL	3 <input type="checkbox"/>	0.3	\$ 121	\$ 138
	HRVC35PL	3 <input type="checkbox"/>	0.3	\$ 121	\$ 138
	HRVC42PL	4 <input type="checkbox"/>	0.4	\$ 132	\$ 149
	HRVC50PL	5 <input type="checkbox"/>	0.5	\$ 137	\$ 154
	HRVC65PL	6 <input type="checkbox"/>	0.6	\$ 144	\$ 161
HRVC80PL	6 <input type="checkbox"/>	0.8	\$ 150	\$ 167	
 <p>“T” 3-Way Painted Connector 7”H Frame (Does not include top cap, see bullet above) 15”H Frame (Does not include top cap, see bullet above) 22”H Frame (Does not include top cap, see bullet above) 30”H Frame (Does not include top cap, see bullet above) 35”H Frame 42”H Frame 50”H Frame 65”H Frame 80”H Frame</p>	HRVC7PT	1 <input type="checkbox"/>	0.1	\$ 83	\$ 100
	HRVC15PT	2 <input type="checkbox"/>	0.1	\$ 94	\$ 111
	HRVC22PT	2 <input type="checkbox"/>	0.2	\$ 106	\$ 123
	HRVC30PT	3 <input type="checkbox"/>	0.3	\$ 121	\$ 138
	HRVC35PT	3 <input type="checkbox"/>	0.3	\$ 121	\$ 138
	HRVC42PT	4 <input type="checkbox"/>	0.4	\$ 132	\$ 149
	HRVC50PT	5 <input type="checkbox"/>	0.5	\$ 137	\$ 154
	HRVC65PT	6 <input type="checkbox"/>	0.6	\$ 144	\$ 161
HRVC80PT	6 <input type="checkbox"/>	0.8	\$ 150	\$ 167	
 <p>“X” 4-Way Painted Connector 7”H Frame (Does not include top cap, see bullet above) 15”H Frame (Does not include top cap, see bullet above) 22”H Frame (Does not include top cap, see bullet above) 30”H Frame (Does not include top cap, see bullet above) 35”H Frame 42”H Frame 50”H Frame 65”H Frame 80”H Frame</p>	HRVC7PX	1 <input type="checkbox"/>	0.1	\$ 66	\$ 76
	HRVC15PX	2 <input type="checkbox"/>	0.1	\$ 76	\$ 86
	HRVC22PX	2 <input type="checkbox"/>	0.2	\$ 84	\$ 94
	HRVC30PX	3 <input type="checkbox"/>	0.3	\$ 94	\$ 104
	HRVC35PX	3 <input type="checkbox"/>	0.3	\$ 94	\$ 104
	HRVC42PX	4 <input type="checkbox"/>	0.4	\$ 127	\$ 137
	HRVC50PX	6 <input type="checkbox"/>	0.5	\$ 132	\$ 142
	HRVC65PX	7 <input type="checkbox"/>	0.6	\$ 137	\$ 147
HRVC80PX	6 <input type="checkbox"/>	0.8	\$ 144	\$ 154	
 <p>“S” Extended Straight Painted Connector 7”H Frame (Does not include top cap, see bullet above) 15”H Frame (Does not include top cap, see bullet above) 22”H Frame (Does not include top cap, see bullet above) 30”H Frame (Does not include top cap, see bullet above) 35”H Frame 42”H Frame 50”H Frame 65”H Frame 80”H Frame</p>	HRVC7PS	1 <input type="checkbox"/>	0.1	\$ 103	\$ 120
	HRVC15PS	2 <input type="checkbox"/>	0.1	\$ 113	\$ 130
	HRVC22PS	2 <input type="checkbox"/>	0.2	\$ 122	\$ 139
	HRVC30PS	3 <input type="checkbox"/>	0.3	\$ 132	\$ 149
	HRVC35PS	3 <input type="checkbox"/>	0.3	\$ 132	\$ 149
	HRVC42PS	4 <input type="checkbox"/>	0.4	\$ 152	\$ 169
	HRVC50PS	6 <input type="checkbox"/>	0.5	\$ 159	\$ 176
	HRVC65PS	7 <input type="checkbox"/>	0.6	\$ 169	\$ 186
HRVC80PS	7 <input type="checkbox"/>	0.8	\$ 182	\$ 199	

How to specify

<p>Select Model Number from above</p> <p>H R V C 3 5 P L .</p>	<p>1st Option</p> <p>Select Paint Color</p> <p>See page 309</p> <p>T 4 </p>
--	---







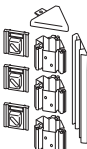

About® Connectors

GSA SIN 711-1

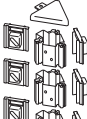

- ▶ 35"H-42"H connectors include two universal connector blocks, 50"H includes three brackets and 65"H includes four brackets.
- ▶ Use Y Connectors for 120° applications.
- ▶ About connectors utilize a universal connector block designed to make one connection to the panel.
- ▶ Connectors ship complete with trim.
- ▶ Bracket clips come standard.
- ▶ Outer trim snaps easily into place.



























Description	Model	Ship Weight	Cube	List by Paint Grade	
				Core	Metallics
 "Y" 120° Degree, Two-Sided, Painted Connector 35"H Frame 42"H Frame 50"H Frame 65"H Frame	HRVC35PY2	3 	0.3	\$ 121	\$ 138
	HRVC42PY2	4 	0.4	\$ 132	\$ 149
	HRVC50PY2	5 	0.5	\$ 144	\$ 161
	HRVC65PY2	6 	0.6	\$ 159	\$ 176
 "Y" 120° Degree, Three-Sided, Painted Connector 35"H Frame 42"H Frame 50"H Frame 65"H Frame	HRVC35PY3	3 	0.3	\$ 106	\$ 123
	HRVC42PY3	4 	0.4	\$ 121	\$ 138
	HRVC50PY3	5 	0.5	\$ 132	\$ 149
	HRVC65PY3	6 	0.6	\$ 144	\$ 161

How to specify	<p>Select Model Number from above</p> <p>H R V C 3 5 P Y 2 .</p>	<p>1st Option</p> <p>Select Paint Color</p> <p>See page 309</p> <p>T 3 </p>
----------------	--	---

- ▶ Snaps easily onto end of frame.
- ▶ 35”H end trim includes top cap and vertical trim.
- ▶ 15”H and 30”H Finished End Trims do not include a top cap. These are only used for stacking frames which utilize the top trim and cap from the base frame to which they are attached.
- ▶ 42”, 50” and 65”H finished end trim includes painted top transition piece, vertical trim and carpet grippers for extra stability.
- ▶ End trim is full length to floor; no baserail cap is necessary.
- ▶ Finished Ends include top cap trim. Adds 1½” to panel run.
- ▶ Wall Starter Kit allows panel to start from a wall. Specify trim color.
- ▶ Wall Starter adds 1½” to length of panel run.
- ▶ Anchor devices are not supplied with the wall starter kits.

⚠ **Variable height trim and finished ends can only be attached to panels, not attached to connectors.**



Description	Model	Ship Weight	Cube	List by Paint Grade	
				Core	Metallics
 <p>Finished End</p> <p>15”H Finished End</p> <p>30”H Finished End</p> <p>35”H Finished End</p> <p>42”H Finished End</p> <p>50”H Finished End</p> <p>65”H Finished End</p> <p>80”H Finished End</p>	HRVC15PF	1 	0.1	\$ 55	\$ 72
	HRVC30PF	2 	0.3	\$ 68	\$ 85
	HRVC35PF	2 	0.3	\$ 68	\$ 85
	HRVC42PF	2 	0.4	\$ 76	\$ 93
	HRVC50PF	3 	0.5	\$ 82	\$ 99
	HRVC65PF	4 	0.6	\$ 87	\$ 104
	HRVC80PF	4 	0.8	\$ 92	\$ 109
 <p>Variable Height Painted Finished End</p> <p>7” Variable Height Finished End</p> <p>15” Variable Height Finished End</p> <p>22” Variable Height Finished End</p> <p>30” Variable Height Finished End</p>	HRVC7PFV	1 	0.1	\$ 55	\$ 65
	HRVC15PFV	1 	0.1	\$ 55	\$ 65
	HRVC22PFV	2 	0.2	\$ 68	\$ 78
	HRVC30PFV	2 	0.3	\$ 68	\$ 78
 <p>Variable Height Painted Finished End Over Connector</p> <p>7” Variable Height Finished End Over Connector</p> <p>15” Variable Height Finished End Over Connector</p> <p>22” Variable Height Finished End Over Connector</p> <p>30” Variable Height Finished End Over Connector</p>	HRVC7PFT	1 	0.1	\$ 55	\$ 65
	HRVC15PFT	1 	0.1	\$ 55	\$ 65
	HRVC22PFT	2 	0.2	\$ 68	\$ 78
	HRVC30PFT	2 	0.3	\$ 68	\$ 78
 <p>Frameless Glass Variable Height Trim</p> <p>7½”H</p>	HRVC7FFV	1	0.1	\$ 49	\$ 58
	HRVC15FFV	1	0.1	\$ 74	\$ 83
Specify paint only.					
⚠ Model only used with Frameless Glass on page 340.					
SPECIFYING EXAMPLE: HRVC7FFV.T1					
 <p>Wall Starter Kit</p> <p>65”H</p>	HRVC65PW	5 	0.6	\$ 159	\$ 176
⚠ Wall Starter in Black only. Top cap for Wall Starter can be specified in all standard paints.					
 <p>Permanent Wall Hanger Kit</p> <p>2½”W x 7⁄8”D x 66”H</p> <p>4¼”W x 7⁄8”D x 66”H</p>	HRVC35PCE	6 	0.7	\$ 197	\$ 217
	HRVC35PCM	3 	0.7	\$ 102	\$ 112
⚠ Anchor devices are not supplied with this model. Refer to Abound® Installation instructions for appropriate hardware. Attachment to masonry walls is not recommended.					
Specify paint					

How to specify	<p>Select Model Number from above</p> <p>H R V C 7 P F T .</p>	<p>1st Option</p> <p>Select Paint Color</p> <p>See page 309</p> <p>T 3 </p>
----------------	--	---

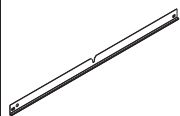

Description

Model

Ship
Weight

Cube

List by Paint Grade

Core

Metallics

Wall Hanger Segment Bars

24"W

HRVFSBW24

2

0.4

\$ 28

30"W

HRVFSBW30

2

0.4

\$ 28

36"W

HRVFSBW36

3

0.5

\$ 30

42"W

HRVFSBW42

3

0.5

\$ 33

48"W

HRVFSBW48

3

0.6

\$ 36

60"W

HRVFSBW60

4

0.7

\$ 40

Includes two tile bars. Top bar may only be used in the top uppermost position on Wall Track. Bottom bar can be used in the bottom position at any point on the wall hangers. When segmenting tiles on Wall Hangers, standard Segment Bars (page 325) must be ordered for placement between each tile reveal or at the top position of a single tile that is not in the uppermost position.

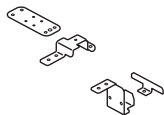

Off-Module Bracket Kit

HRVOMOD

2

0.1

\$ 76

\$ 86

- Includes top and bottom attachment brackets and top trim finished end.
- Installation requires defacing of the top tile.

Cannot be mounted in locations where the bottom bracket covers electrical cutouts in the base pathway on parent run panels.



Icon Legend on page 10

- ▶ Tiles attach directly onto the panels. No additional hardware is needed.
- ▶ Tiles are non-dedicated.

- ▶ For monolithic applications, subtract 5" from the frame height to determine monolithic tile height.

- ▶ For worksurfaces that can be used with both About® and Accelerate® systems, see pages 395-406.
- ☑ Fabric tiles have a Class A fire rating.

- ⚠ Tiles do not include segment bars, must be ordered separately. See page 325. Not needed on monolithic tiles.

- ⚠ Glass will not work with 42" H frames.
- ⚠ One segment bar required per panel reveal, per panel side.



Description	Model	Ship Weight	Cube	List by Fabric Grade						
				A	B	C	D	E	F	G
7½" H Tackable Acoustical Fabric Tiles										
7½" H x 24" W	HRVT0724T	2 [S]	0.4	\$ 59	\$ 62	\$ 64	\$ 70	\$ 75	\$ 80	\$ 83
7½" H x 30" W	HRVT0730T	2 [S]	0.5	\$ 69	\$ 72	\$ 76	\$ 82	\$ 89	\$ 92	\$ 95
7½" H x 36" W	HRVT0736T	2 [S]	0.6	\$ 74	\$ 77	\$ 81	\$ 87	\$ 94	\$ 97	\$ 100
7½" H x 42" W	HRVT0742T	2 [S]	0.7	\$ 82	\$ 86	\$ 90	\$ 100	\$ 103	\$ 107	\$ 111
7½" H x 48" W	HRVT0748T	2 [S]	0.8	\$ 87	\$ 91	\$ 95	\$ 105	\$ 108	\$ 112	\$ 116
7½" H x 60" W	HRVT0760T	3 [S]	1.0	\$ 118	\$ 122	\$ 127	\$ 139	\$ 143	\$ 146	\$ 149
15" H Tackable Acoustical Fabric Tiles										
15" H x 24" W	HRVT1524T	2 [S]	0.8	\$ 66	\$ 74	\$ 82	\$ 98	\$ 116	\$ 132	\$ 140
15" H x 30" W	HRVT1530T	2 [S]	0.9	\$ 69	\$ 79	\$ 89	\$ 111	\$ 132	\$ 143	\$ 153
15" H x 36" W	HRVT1536T	2 [S]	1.1	\$ 75	\$ 85	\$ 95	\$ 117	\$ 138	\$ 149	\$ 159
15" H x 42" W	HRVT1542T	2 [S]	1.3	\$ 79	\$ 91	\$ 106	\$ 139	\$ 150	\$ 160	\$ 171
15" H x 48" W	HRVT1548T	2 [S]	1.5	\$ 84	\$ 96	\$ 111	\$ 144	\$ 155	\$ 165	\$ 176
15" H x 60" W	HRVT1560T	3 [S]	1.8	\$ 96	\$ 108	\$ 123	\$ 156	\$ 167	\$ 177	\$ 188
30" H Tackable Acoustical Tiles										
30" H x 24" W	HRVT3024T	2 [S]	1.4	\$ 90	\$ 100	\$ 111	\$ 133	\$ 160	\$ 171	\$ 181
30" H x 30" W	HRVT3030T	2 [S]	1.8	\$ 95	\$ 107	\$ 122	\$ 147	\$ 181	\$ 225	\$ 235
30" H x 36" W	HRVT3036T	2 [S]	2.1	\$ 107	\$ 123	\$ 135	\$ 188	\$ 226	\$ 237	\$ 247
30" H x 42" W	HRVT3042T	3 [S]	2.4	\$ 116	\$ 131	\$ 143	\$ 197	\$ 234	\$ 246	\$ 256
30" H x 48" W	HRVT3048T	3 [S]	2.8	\$ 123	\$ 138	\$ 150	\$ 204	\$ 241	\$ 253	\$ 263
30" H x 60" W	HRVT3060T	4 [S]	3.4	\$ 137	\$ 152	\$ 164	\$ 218	\$ 255	\$ 267	\$ 277
37" H Tackable Acoustical Tiles										
37" H x 24" W	HRVT3724T	2 [S]	2.0	\$ 107	\$ 122	\$ 140	\$ 193	\$ 225	\$ 237	\$ 247
37" H x 30" W	HRVT3730T	3 [S]	2.4	\$ 119	\$ 134	\$ 152	\$ 205	\$ 237	\$ 249	\$ 259
37" H x 36" W	HRVT3736T	4 [S]	2.9	\$ 137	\$ 156	\$ 177	\$ 241	\$ 288	\$ 299	\$ 310
37" H x 42" W	HRVT3742T	4 [S]	3.4	\$ 153	\$ 173	\$ 197	\$ 278	\$ 326	\$ 336	\$ 347
37" H x 48" W	HRVT3748T	5 [S]	3.8	\$ 160	\$ 182	\$ 205	\$ 288	\$ 337	\$ 349	\$ 360
37" H x 60" W	HRVT3760T	6	4.6	\$ 185	\$ 211	\$ 242	\$ 324	\$ 384	\$ 395	\$ 407

⚠ Segment bars ordered separately. See page 325.

How to specify	Select Model Number from above	1st Option
	H R V T 1 5 2 4 T .	Select Fabric Color See pages 310-311 P N 1 1

About® Tackable Acoustical Tiles

GSA SIN 711-1



▶ Tiles are non-dedicated.
▶ Tiles attach directly onto the panels. No additional hardware is needed.

▶ For monolithic applications, subtract 5" from the frame height to determine monolithic tile height.

▶ For worksurfaces that can be used with both About® and Accelerate® systems, see pages 395-406.
☑ Fabric tiles have a Class A fire rating.

⚠ Tiles do not include segment bars, must be ordered separately. See page 325. Not needed on monolithic tiles.

⚠ One segment bar required per panel reveal, per panel side.



Description	Model	Ship Weight	Cube	List by Fabric Grade						
				A	B	C	D	E	F	G
45"H Tackable Acoustical Tiles										
45"H x 24"W	HRVT4524T	2	2.3	\$ 118	\$ 138	\$ 159	\$ 225	\$ 273	\$ 284	\$ 296
45"H x 30"W	HRVT4530T	3	2.9	\$ 135	\$ 155	\$ 180	\$ 263	\$ 311	\$ 323	\$ 335
45"H x 36"W	HRVT4536T	5	3.4	\$ 157	\$ 179	\$ 202	\$ 285	\$ 334	\$ 346	\$ 357
45"H x 42"W	HRVT4542T	5	4.0	\$ 180	\$ 200	\$ 225	\$ 307	\$ 356	\$ 368	\$ 380
45"H x 48"W	HRVT4548T	6	4.5	\$ 201	\$ 229	\$ 246	\$ 329	\$ 378	\$ 390	\$ 401
45"H x 60"W	HRVT4560T	7	5.6	\$ 222	\$ 249	\$ 280	\$ 361	\$ 421	\$ 433	\$ 445
60"H Tackable Acoustical Tiles										
60"H x 24"W	HRVT6024T	3	3.0	\$ 149	\$ 182	\$ 216	\$ 304	\$ 358	\$ 371	\$ 482
60"H x 30"W	HRVT6030T	4	3.7	\$ 170	\$ 208	\$ 245	\$ 337	\$ 402	\$ 415	\$ 479
60"H x 36"W	HRVT6036T	6	4.4	\$ 193	\$ 231	\$ 266	\$ 359	\$ 424	\$ 438	\$ 502
60"H x 42"W	HRVT6042T	6	5.1	\$ 210	\$ 254	\$ 290	\$ 399	\$ 464	\$ 477	\$ 568
60"H x 48"W	HRVT6048T	7	5.8	\$ 232	\$ 276	\$ 312	\$ 421	\$ 530	\$ 544	\$ 634
60"H x 60"W	HRVT6060T	9	7.2	\$ 251	\$ 299	\$ 335	\$ 483	\$ 565	\$ 577	\$ 668

⚠ Segment bars ordered separately. See page 325.

How to specify

Select Model Number from above

H R V T 4 5 2 4 T .

1st Option

Select Fabric Color

See pages 310-311

P N 1 1

Icon Legend on page 10

- ▶ 15" Power/Data tile can be used on 50"H frames, or higher, for beltline access.
- ▶ 30" Port tiles can be used in base position on 50"H or higher frames for data/power access at beltline.
- ▶ Power/Data tiles are tackable and acoustical.
- ▶ Tiles attach directly onto the panels. No additional hardware is needed. Tiles are non-dedicated.
- ▶ Receptacle openings with blank covers have one in 24"W tiles and 2 in wider tiles.
- ▶ Power/Data grommet opening is 2¹¹/₁₆"W x 1¹/₈"H. With glides retracted grommets are 30¹/₂" from the floor and 10¹/₂" from the edge of the frame.
- ▶ Power/Data ports are factory installed.
- ▶ For workspaces that can be used with both About® and Accelerate® systems, see pages 395-406.
- ▶ Fabric tiles have a Class A fire rating.
- ▶ Tiles do not include segment bars, must be ordered separately. See page 325. Can be used in any combination.
- ▶ One segment bar required per panel reveal, per panel side.
- ▶ Electrical mounting brackets must be ordered separately. See page 392.



Description	Model	Ship Weight	Cube	List by Fabric Grade						
				A	B	C	D	E	F	G
15"H Power/Data Fabric Tiles										
15"H x 24"W	HRVT1524E	2 [S]	0.8	\$ 125	\$ 133	\$ 141	\$ 157	\$ 175	\$ 191	\$ 199
15"H x 30"W	HRVT1530E	2 [S]	0.9	\$ 128	\$ 138	\$ 148	\$ 170	\$ 191	\$ 202	\$ 212
15"H x 36"W	HRVT1536E	2 [S]	1.1	\$ 134	\$ 144	\$ 154	\$ 176	\$ 197	\$ 208	\$ 218
15"H x 42"W	HRVT1542E	2 [S]	1.3	\$ 138	\$ 150	\$ 165	\$ 198	\$ 209	\$ 219	\$ 230
15"H x 48"W	HRVT1548E	2 [S]	1.5	\$ 143	\$ 155	\$ 170	\$ 203	\$ 214	\$ 224	\$ 235
15"H x 60"W	HRVT1560E	3 [S]	1.8	\$ 154	\$ 166	\$ 181	\$ 214	\$ 225	\$ 235	\$ 246
30"H Power/Data Fabric Tiles										
30"H x 24"W	HRVT3024E	2 [S]	1.4	\$ 147	\$ 157	\$ 168	\$ 190	\$ 217	\$ 228	\$ 238
30"H x 30"W	HRVT3030E	2 [S]	1.8	\$ 153	\$ 165	\$ 180	\$ 205	\$ 239	\$ 283	\$ 293
30"H x 36"W	HRVT3036E	2 [S]	2.1	\$ 166	\$ 182	\$ 194	\$ 247	\$ 285	\$ 296	\$ 306
30"H x 42"W	HRVT3042E	3 [S]	2.4	\$ 178	\$ 193	\$ 205	\$ 259	\$ 296	\$ 308	\$ 318
30"H x 48"W	HRVT3048E	3 [S]	2.8	\$ 183	\$ 198	\$ 210	\$ 264	\$ 301	\$ 313	\$ 323
30"H x 60"W	HRVT3060E	4 [S]	3.4	\$ 196	\$ 211	\$ 223	\$ 277	\$ 314	\$ 326	\$ 336
37"H Power/Data Fabric Tiles										
37"H x 24"W	HRVT3724E	2 [S]	2.0	\$ 166	\$ 181	\$ 199	\$ 252	\$ 284	\$ 296	\$ 306
37"H x 30"W	HRVT3730E	3 [S]	2.4	\$ 180	\$ 195	\$ 213	\$ 266	\$ 298	\$ 310	\$ 320
37"H x 36"W	HRVT3736E	4 [S]	2.9	\$ 193	\$ 212	\$ 233	\$ 297	\$ 344	\$ 355	\$ 366
37"H x 42"W	HRVT3742E	4 [S]	3.4	\$ 207	\$ 227	\$ 251	\$ 332	\$ 380	\$ 390	\$ 401
37"H x 48"W	HRVT3748E	5 [S]	3.8	\$ 221	\$ 243	\$ 266	\$ 349	\$ 398	\$ 410	\$ 421
37"H x 60"W	HRVT3760E	6	4.7	\$ 246	\$ 272	\$ 303	\$ 385	\$ 445	\$ 456	\$ 468

▶ Segment bars ordered separately. See page 325.

How to specify	1st Option	2nd Option
<p>Select Model Number from above</p> <p>H R V T 1 5 2 4 E .</p>	<p>Select Fabric Color</p> <p>See pages 310-311</p> <p>P N 1 1 .</p>	<p>Select Electrical Power/Data Grommet Color</p> <p>See page 309</p> <p>T 5 </p>

About® Power/Data Fabric Tiles

GSA SIN 711-1



- ▶ Tiles are non-dedicated.
- ▶ Tiles attach directly onto the panels. No additional hardware is needed.
- ▶ Power/Data grommet opening is 2 1/16" W x 1 3/8" H. With glides retracted grommet are 30 1/2" from the floor and 10 1/2" from the edge of the frame.
- ▶ Power/Data ports are factory installed.
- ▶ For worksurfaces that can be used with both About® and Accelerate® systems, see pages 395-406.
- ☐ Fabric tiles have a Class A fire rating.
- ⚠ Tiles do not include segment bars, must be ordered separately. See page 325. Can be used in any combination.
- ⚠ One segment bar required per panel reveal, per panel side.
- ⚠ Electrical mounting brackets must be ordered separately. See page 392.



Description	Model	Ship Weight	Cube	List by Fabric Grade						
				A	B	C	D	E	F	G
45"H Power/Data Fabric Tiles										
45"H x 24"W	HRVT4524E	2	2.3	\$ 180	\$ 200	\$ 221	\$ 287	\$ 335	\$ 346	\$ 358
45"H x 30"W	HRVT4530E	3	2.9	\$ 195	\$ 215	\$ 240	\$ 323	\$ 371	\$ 383	\$ 395
45"H x 36"W	HRVT4536E	5	3.4	\$ 219	\$ 241	\$ 264	\$ 347	\$ 396	\$ 408	\$ 419
45"H x 42"W	HRVT4542E	5	4.0	\$ 241	\$ 261	\$ 286	\$ 368	\$ 417	\$ 429	\$ 441
45"H x 48"W	HRVT4548E	6	4.5	\$ 263	\$ 291	\$ 308	\$ 391	\$ 440	\$ 452	\$ 463
45"H x 60"W	HRVT4560E	7	5.6	\$ 285	\$ 312	\$ 343	\$ 424	\$ 484	\$ 496	\$ 508
60"H Power/Data Fabric Tiles										
60"H x 24"W	HRVT6024E	3	3.0	\$ 208	\$ 241	\$ 275	\$ 363	\$ 417	\$ 430	\$ 471
60"H x 30"W	HRVT6030E	4	3.7	\$ 232	\$ 270	\$ 307	\$ 399	\$ 464	\$ 477	\$ 541
60"H x 36"W	HRVT6036E	6	4.4	\$ 253	\$ 291	\$ 326	\$ 419	\$ 484	\$ 498	\$ 562
60"H x 42"W	HRVT6042E	6	5.1	\$ 272	\$ 316	\$ 352	\$ 461	\$ 526	\$ 539	\$ 630
60"H x 48"W	HRVT6048E	7	5.8	\$ 294	\$ 338	\$ 374	\$ 483	\$ 592	\$ 606	\$ 696
60"H x 60"W	HRVT6060E	9	7.2	\$ 314	\$ 362	\$ 398	\$ 546	\$ 628	\$ 640	\$ 731

⚠ Segment bars ordered separately. See page 325.

How to specify	1st Option	2nd Option
<p>Select Model Number from above</p> <p>H R V T 4 5 2 4 E .</p>	<p>Select Fabric Color</p> <p>See pages 310-311</p> <p>P N 1 1 .</p>	<p>Select Electrical Power/Data Grommet Color</p> <p>See page 309</p> <p>T 5 </p>

Icon Legend on page 10

- ▶ Tiles are made from high-pressure laminate.
- ▶ Available in all standard HON laminates.



- ▶ On woodgrain laminates, grain direction is vertical.
- ▶ Tiles attach with Custom Tile Bracket Kit — included.

- ▶ Specify paint color.
- ▶ 15”H and 30”H tiles are non-dedicated and can be used in any tile position (except on 42”H frames.)
- ▶ For worksurfaces that can be used with both Abound® and Accelerate® systems, see pages 395-406.

- ⚠ **All tiles ship with Custom Bracket Kit.**
- ⚠ **One segment bar is required per panel reveal, per panel side.**

- ⚠ **Tiles do not ship with segment bars — must be ordered separately. See page 325. Segment bars are not needed for 42”H monolithic tiles.**

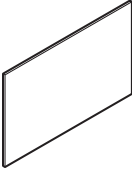
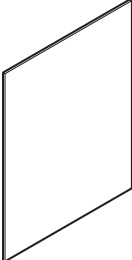

Description	Model	Ship Weight	Cube	List Price by Laminate Grade	
				L1	L2
 <p>15” Hard-surface Tile and Mounting Kit 15”H x 24”W 15”H x 30”W 15”H x 36”W 15”H x 42”W 15”H x 48”W 15”H x 60”W</p>	HRVT1524HS	11	0.8	\$ 192	\$ 202
	HRVT1530HS	13	0.9	\$ 203	\$ 213
	HRVT1536HS	15	1.1	\$ 218	\$ 228
	HRVT1542HS	17	1.3	\$ 230	\$ 240
	HRVT1548HS	21	1.5	\$ 241	\$ 256
	HRVT1560HS	25	1.8	\$ 275	\$ 290
 <p>30” Hard-surface Tile and Mounting Kit 30”H x 24”W 30”H x 30”W 30”H x 36”W 30”H x 42”W 30”H x 48”W 30”H x 60”W</p>	HRVT3024HS	17	1.4	\$ 238	\$ 253
	HRVT3030HS	19	1.8	\$ 255	\$ 270
	HRVT3036HS	21	2.1	\$ 283	\$ 298
	HRVT3042HS	24	2.4	\$ 310	\$ 325
	HRVT3048HS	28	2.8	\$ 326	\$ 346
	HRVT3060HS	30	3.4	\$ 360	\$ 380
 <p>37” Hard-surface Tile and Mounting Kit 37”H x 24”W 37”H x 30”W 37”H x 36”W 37”H x 42”W 37”H x 48”W 37”H x 60”W</p>	HRVT3724HS	17	1.4	\$ 288	\$ 308
	HRVT3730HS	17	1.8	\$ 318	\$ 338
	HRVT3736HS	19	2.1	\$ 350	\$ 370
	HRVT3742HS	21	2.4	\$ 385	\$ 405
	HRVT3748HS	24	2.8	\$ 415	\$ 440
	HRVT3760HS	30	3.4	\$ 472	\$ 497

How to specify	Select Model Number from above	1st Option	2nd Option
	Select Laminate Color See page 309	Select Paint Color See page 309	
	H R V T 1 5 2 4 H S .	H .	T 1

About® Clear Glass Tiles

GSA SIN 711-1



- ▶ Glass is off-set and may be placed on either side of the frame.
- ▶ Tile is a single-pane, tempered glass.
- ▶ For worksurfaces that can be used with both About® and Accelerate® systems, see pages 395-406.
- ☑ Glass tiles have a Class A fire rating.
- ⚠ Tiles do not include segment bars, must be ordered separately. See page 325. Can be used in any combination.
- ⚠ Glass tiles cannot be placed in the second tier (20"-35" range) due to interference with the horizontal support.
- ⚠ Glass tiles cannot be placed in the bottom tier of a frame.
- ⚠ Glass tiles will not work with 42" H frames — use stackers with glass on 42 1/2" H panels.
- ⚠ When stacking on 42 1/2" H frames, panel slots will be off by 1/2" compared to any other height panel.



	Description	Model	Ship Weight	Cube	List by Paint Grade	
					Core	Metallics
	15"H Clear Glass Tiles					
	15"H x 24"W	HRVT1524G	12	0.8	\$ 420	\$ 439
	15"H x 30"W	HRVT1530G	15	0.9	\$ 445	\$ 464
	15"H x 36"W	HRVT1536G	17	1.1	\$ 471	\$ 490
	15"H x 42"W	HRVT1542G	19	1.3	\$ 503	\$ 523
	15"H x 48"W	HRVT1548G	20	1.5	\$ 540	\$ 560
	15"H x 60"W	HRVT1560G	26	1.8	\$ 645	\$ 665
	30"H Clear Glass Tiles					
	30"H x 24"W	HRVT3024G	15	1.4	\$ 560	\$ 580
	30"H x 30"W	HRVT3030G	21	1.8	\$ 598	\$ 618
	30"H x 36"W	HRVT3036G	22	2.1	\$ 637	\$ 657
	30"H x 42"W	HRVT3042G	25	2.4	\$ 688	\$ 708
	30"H x 48"W	HRVT3048G	28	2.9	\$ 739	\$ 759
	30"H x 60"W	HRVT3060G	33	3.4	\$ 868	\$ 888

⚠ Segment bars ordered separately. See page 325.

How to specify	1st Option
Select Model Number from above	Select Interior Shroud Paint Color
See page 309. Available in all Core/Metallic paint colors.	
H R V T 1 5 2 4 G .	T 1



- ▶ Tile is a single-pane, tempered glass.
- ▶ Glass is off-set and may be placed on either side of the frame.

- ▶ For worksurfaces that can be used with both About® and Accelerate® systems, see pages 395-406.
- ☑ Glass tiles have a Class A fire rating.

⚠ Tiles do not include segment bars, must be ordered separately. See page 325. Can be used in any combination.

⚠ Not designed to be used on the second tier of the system due to interference with the horizontal supports.

⚠ Glass tiles cannot be placed in the bottom tier of a frame.

⚠ Glass will not work with 42"H frames.



	Description	Model	Ship Weight	Cube	List by Paint Grade	
					Core	Metallics
	15"H Frosted Glass Tiles					
	15"H x 24"W	HRVT1524R	12	0.8	\$ 518	\$ 537
	15"H x 30"W	HRVT1530R	15	0.9	\$ 556	\$ 575
	15"H x 36"W	HRVT1536R	17	1.1	\$ 594	\$ 613
	15"H x 42"W	HRVT1542R	19	1.3	\$ 637	\$ 657
	15"H x 48"W	HRVT1548R	20	1.5	\$ 686	\$ 706
	15"H x 60"W	HRVT1560R	26	1.8	\$ 802	\$ 822
	30"H Frosted Glass Tiles					
	30"H x 24"W	HRVT3024R	15	1.4	\$ 732	\$ 752
	30"H x 30"W	HRVT3030R	21	1.8	\$ 782	\$ 802
	30"H x 36"W	HRVT3036R	22	2.1	\$ 833	\$ 853
	30"H x 42"W	HRVT3042R	25	2.4	\$ 897	\$ 917
	30"H x 48"W	HRVT3048R	28	2.9	\$ 960	\$ 980
	30"H x 60"W	HRVT3060R	33	3.4	\$1102	\$1122

⚠ Segment bars ordered separately. See page 325.

How to specify	Select Model Number from above	1st Option
	H R V T 1 5 2 4 R .	Select Interior Shroud Paint Color See page 309. Available in all Core/Metallic paint colors. T 1

About® Frameless Glass

GSA SIN 711-1



- ▶ Tile is a single-pane, 3/8" laminated safety glass.
- ▶ Available in clear or frosted glass.

- ▶ New top cap ships with Frameless Glass which fits around the glass insert.
- ▶ Frameless Glass can span multiple panels with one piece of glass.
- ☑ Glass tiles have a Class A fire rating.

- ⚠ **Frameless Glass can only be used on the top of panels. Glass integrates into top cap trim.**
- ⚠ **Frameless Glass cannot be used on top of glass tiles.**

- ⚠ **Frameless Glass can only be used on same height panels or panels one step apart in height.**
- ⚠ **Power and data cords cannot lay in the top of panel frames when using frameless glass.**

- ⚠ **Variable height trim for Frameless Glass must be ordered when using panel heights one step up; see page 331.**
- ⚠ **Cannot hang or stack on top of Frameless Glass.**

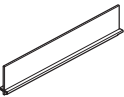

Description	Model	Ship Weight	Cube	Clear Glass	Frosted Glass
 7 1/2"H Frameless Glass					
7 1/2"H x 24"W	HRVT0724F	18	0.5	\$ 373	\$ 408
7 1/2"H x 30"W	HRVT0730F	18	0.5	\$ 400	\$ 437
7 1/2"H x 36"W	HRVT0736F	21	0.6	\$ 463	\$ 506
7 1/2"H x 42"W	HRVT0742F	25	0.7	\$ 489	\$ 535
7 1/2"H x 48"W	HRVT0748F	28	0.8	\$ 522	\$ 572
7 1/2"H x 54"W (24" + 30")	HRVT0754F	28	0.8	\$ 581	\$ 635
7 1/2"H x 60"W	HRVT0760F	35	1.0	\$ 639	\$ 700
7 1/2"H x 66"W (30" + 36")	HRVT0766F	35	1.0	\$ 700	\$ 766
7 1/2"H x 72"W (36" + 36")	HRVT0772F	42	1.9	\$ 760	\$ 832
7 1/2"H x 78"W (48" + 30")	HRVT0778F	42	1.9	\$ 817	\$ 894
7 1/2"H x 84"W (36" + 48" or 42" + 42")	HRVT0784F	50	2.1	\$ 873	\$ 956
7 1/2"H x 90"W (42" + 48")	HRVT0790F	50	2.1	\$ 932	\$1019
7 1/2"H x 96"W (48" + 48" or 36" + 60")	HRVT0796F	57	2.4	\$ 987	\$1079

NOTES: For models 54"W–96"W, glass can span multiple panel widths. See examples of panel sizes by glass width above.

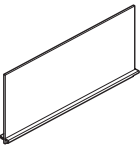
Description	Model	Ship Weight	Cube	Clear Glass	Frosted Glass
 15"H Frameless Glass					
15"H x 24"W	HRVT1524F	28	1.5	\$ 419	\$ 456
15"H x 30"W	HRVT1530F	28	1.5	\$ 446	\$ 487
15"H x 36"W	HRVT1536F	34	1.8	\$ 518	\$ 565
15"H x 42"W	HRVT1542F	39	2.0	\$ 551	\$ 601
15"H x 48"W	HRVT1548F	45	2.3	\$ 590	\$ 644
15"H x 54"W (24" + 30")	HRVT1554F	51	2.6	\$ 652	\$ 713
15"H x 60"W	HRVT1560F	57	2.8	\$ 718	\$ 784
15"H x 66"W (30" + 36")	HRVT1566F	62	3.2	\$ 785	\$ 857
15"H x 72"W (36" + 36")	HRVT1572F	67	3.5	\$ 853	\$ 931
15"H x 78"W (48" + 30")	HRVT1578F	63	3.7	\$ 970	\$1058
15"H x 84"W (36" + 48" or 42" + 42")	HRVT1584F	78	3.9	\$1084	\$1183
15"H x 90"W (42" + 48")	HRVT1590F	74	4.2	\$1116	\$1218
15"H x 96"W (48" + 48" or 36" + 60")	HRVT1596F	89	4.4	\$1148	\$1254

NOTES: For models 54"W–96"W, glass can span multiple panel widths. See suggested panel sizes by glass width above.

How to specify	1st Option	2nd Option
<p>Select Model Number from above</p> <p>H R V T 0 7 2 4 F .</p>	<p>Select Glass Option</p> <p>G Clear R Frosted (Not specified for HRVT24R-60R models)</p> <p>G .</p>	<p>Select Paint Color</p> <p>See page 309 Core Paint Choice (no upcharge) Choice/Metallic Paint (\$36 upcharge)</p> <p>T 1 </p>

Icon Legend on page 10

► Order one 7½"H fabric tiles per pass-thru tile, if finishing only one side of panel.

► For worksurfaces that can be used with both About® and Accelerate® systems, see pages 395-406.

⚠ **Must order a quantity of two (2) 7½"H fabric tiles per pass-thru tile, if finishing both sides of panel.**

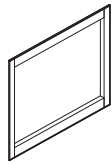

Description	Model	Ship Weight	Cube	List by Paint Grade	
				Core	Metallics
30"H Pass-Thru Tile Kit					
22½"H x 24"W	HRVT3024P	8	1.2	\$ 115	\$ 135
22½"H x 30"W	HRVT3030P	8	1.5	\$ 131	\$ 151
22½"H x 36"W	HRVT3036P	9	1.8	\$ 144	\$ 164
22½"H x 42"W	HRVT3042P	10	2.1	\$ 151	\$ 171
22½"H x 48"W	HRVT3048P	11	2.3	\$ 167	\$ 187
22½"H x 60"W	HRVT3060P	12	2.9	\$ 174	\$ 194

NOTES: Pass-thru opening is 22½"H. To be used with 30"H tiles. Order one 7½"H fabric tiles per pass-thru tile, if finishing only one side of panel.

⚠ **Must order a quantity of two (2) 7½"H fabric tiles per pass-thru tile, if finishing both sides of panel.**

How to specify

<p>Select Model Number from above</p> <p>H R V T 3 0 2 4 P .</p>	<p>1st Option</p> <p>Select Paint Color</p> <p>See page 309</p> <p>T 1</p>
---	---



Description	Model	Ship Weight	Cube	List by Fabric Grade						
				A	B	C	D	E	F	G
7½"H Fabric Tackable Tile										
7½"H x 24"W	HRVT0724T	2 <input type="checkbox"/>	1.4	\$ 59	\$ 62	\$ 64	\$ 70	\$ 75	\$ 80	\$ 83
7½"H x 30"W	HRVT0730T	2 <input type="checkbox"/>	1.8	\$ 69	\$ 72	\$ 76	\$ 82	\$ 89	\$ 92	\$ 95
7½"H x 36"W	HRVT0736T	2 <input type="checkbox"/>	2.1	\$ 74	\$ 77	\$ 81	\$ 87	\$ 94	\$ 97	\$ 100
7½"H x 42"W	HRVT0742T	2 <input type="checkbox"/>	2.4	\$ 82	\$ 86	\$ 90	\$ 100	\$ 103	\$ 107	\$ 111
7½"H x 48"W	HRVT0748T	2 <input type="checkbox"/>	2.8	\$ 87	\$ 91	\$ 95	\$ 105	\$ 108	\$ 112	\$ 116
7½"H x 60"W	HRVT0760T	3 <input type="checkbox"/>	3.4	\$ 118	\$ 122	\$ 127	\$ 139	\$ 143	\$ 146	\$ 149

How to specify

<p>Select Model Number from above</p> <p>H R V T 0 7 2 4 T .</p>	<p>1st Option</p> <p>Select Fabric Color</p> <p>See pages 310-311</p> <p>A P N 1 5</p>
---	---

About® Slotted Tool Tiles

GSA SIN 711-1

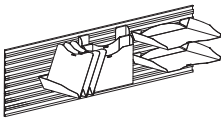

Tool Tile shown with Paper Management Accessories

- ▶ Tiles made from sturdy aluminum extrusion and steel supports with a powder coat finish.
- ▶ Choose from hang-on accessories for a variety of organizational options. See page 343.

▶ For workspaces that can be used with both About® and Accelerate® systems, see pages 395-406.

⚠ Tiles do not include segment bars, must be ordered separately. See page 325. Can be used in any combination.

⚠ Weight capacity of hang-on accessories should not exceed 80 pounds.

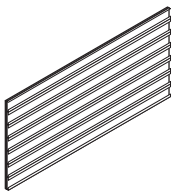

Description

Model

Ship Weight

Cube

List by Paint Grade

Core

Metallics

15"H Slotted Tool Tiles
 15"H x 24"W
 15"H x 30"W
 15"H x 36"W
 15"H x 42"W
 15"H x 48"W
 15"H x 60"W

HRVT1524W
HRVT1530W
HRVT1536W
HRVT1542W
HRVT1548W
HRVT1560W

11 0.8
 13 0.9
 15 1.1
 17 1.3
 20 1.5
 24 1.8

\$ 235 \$ 264
 \$ 252 \$ 281
 \$ 271 \$ 300
 \$ 287 \$ 316
 \$ 306 \$ 335
 \$ 323 \$ 352

⚠ Segment bars ordered separately. See page 325.

How to specify

Select Model Number from above

H R V T 1 5 2 4 W .

1st Option

Select Paint Color

See page 309

T 4

Systems Paper Management Support Bar

GSA SIN 711-1

- ▶ Paper management bar attaches to Systems Panels to accommodate work flow accessories.

▶ For workspaces that can be used with both About® and Accelerate® systems, see pages 395-406.

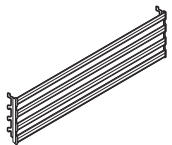

Description

Model

Ship Weight

Cube

List by Paint Grade

Core

Metallics

Systems Paper Management Support Bars
 24"W x 5"H
 30"W x 5"H
 36"W x 5"H
 42"W x 5"H
 48"W x 5"H
 60"W x 5"H

HNPMBSW24
HNPMBSW30
HNPMBSW36
HNPMBSW42
HNPMBSW48
HNPMBSW60

1.3 0.4
 1.5 0.5
 2.0 0.6
 5.0 0.7
 7.0 0.8
 9.0 0.9

\$ 179 \$ 191
 \$ 190 \$ 202
 \$ 197 \$ 209
 \$ 208 \$ 220
 \$ 216 \$ 228
 \$ 246 \$ 258

⚠ Recommended weight capacity not to exceed 80 pounds.

How to specify

Select Model Number from above

H N P M B S W 2 4 .

1st Option

Select Paint Color

See page 309

T 4



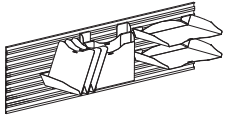





Icon Legend on page 10

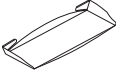

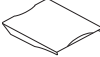
Tool Tile shown with Paper Management Accessories

- ▶ For use with Slotted Tool Tiles and Systems Paper Management Support Bars on page 342.
- ▶ Paper Shelf holds letter size paper and inter-office envelopes.
- ▶ Folder Bin accommodates manila envelopes and can be hung from other folder binds to maximize storage.
- ▶ Accessory Shelf holds office supplies and personal effects.
- ▶ Sorter Tray provides 3 slots for organizing files.



	Description	Model	Ship Weight	Cube	List by Paint Grade	
					Core	Metallics
	Accessories for Slotted Tool Tiles Paper Shelf 15"W x 9 1/2"D x 2"H	HPPMPS	2 	0.3	\$ 90	\$ 102
	Accessory Shelf 21 3/4"W x 9"D x 2"H	HPPMAS	2 	0.3	\$ 94	\$ 106
	Tray 9"W x 10 3/4"D x 2"H	HPPMPT	2 	0.3	\$ 115	\$ 127
	Pencil Holder 5 1/4"W x 1 1/2"D x 5"H	HPPMPB	1 	0.2	\$ 94	\$ 106
	Sorter Tray 6"W x 10"D x 2 1/2"H	HPPMST	2 	0.3	\$ 123	\$ 135
	Folder Bin 12 1/4"W x 1 1/4"D x 9"H	HPPMFB	2 	0.3	\$ 94	\$ 106

How to specify	Select Model Number from above	1st Option
	H P P M P S .	Select Paint Color See page 309 T 4

About® Markerboard Tiles

GSA SIN 711-1



- ▶ Markerboard tile has a painted, steel surface.
- ▶ Accepts magnetic accessories.
- ▶ Markerboard tray attaches to the tile magnetically. Order separately.
- ▶ For worksurfaces that can be used with both About® and Accelerate® systems, see pages 395-406.
- ⚠ Tiles do not include segment bars, must be ordered separately. See page 325. Can be used in any combination.



	Description	Model	Ship		
			Weight	Cube	List
	15"H Markerboard Tiles				
	15"H x 24"W	HRVT1524M	4	1.2	\$ 213
	15"H x 30"W	HRVT1530M	4	1.8	\$ 229
	15"H x 36"W	HRVT1536M	5	2.5	\$ 240
	15"H x 42"W	HRVT1542M	5	3.4	\$ 254
	15"H x 48"W	HRVT1548M	6	4.3	\$ 261
	15"H x 60"W	HRVT1560M	7	6.7	\$ 273
	30"H Markerboard Tiles				
	30"H x 24"W	HRVT3024M	6	1.2	\$ 234
	30"H x 30"W	HRVT3030M	7	1.8	\$ 251
	30"H x 36"W	HRVT3036M	8	2.5	\$ 277
	30"H x 42"W	HRVT3042M	10	3.4	\$ 294
	30"H x 48"W	HRVT3048M	11	4.3	\$ 323
	30"H x 60"W	HRVT3060M	13	6.7	\$ 359
	Magnetic Markerboard Tray 15" Natural Aluminum	HRVTRAYM	4	0.4	\$ 52
	⚠ Natural Aluminum only, no need to specify paint. ⚠ Segment bars ordered separately. See page 325.				

How to specify	<p>Select Model Number from above</p> <p>H R V T 1 5 2 4 M .</p>	<p>1st Option</p> <p>Select Paint Color</p> <p>See page 309</p> <p>T 1 </p>
----------------	---	---

Icon Legend on page 10

► Painted steel construction.

► For worksurfaces that can be used with both About® and Accelerate® systems, see pages 395-406.

⚠ Tiles do not include segment bars, must be ordered separately. See page 325. Can be used in any combination.

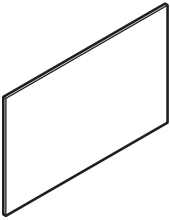
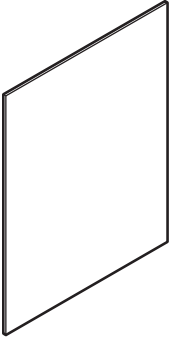

Description	Model	Ship Weight	Cube	List by Paint Grade	
				Core	Metallics
 <p>15"H Painted Metal Tile</p> <p>15"H x 24"W</p> <p>15"H x 30"W</p> <p>15"H x 36"W</p> <p>15"H x 42"W</p> <p>15"H x 48"W</p> <p>15"H x 60"W</p>	HRVT1524PM	4	1.2	\$ 136	\$ 157
	HRVT1530PM	4	1.8	\$ 144	\$ 165
	HRVT1536PM	5	2.5	\$ 157	\$ 178
	HRVT1542PM	5	3.4	\$ 169	\$ 190
	HRVT1548PM	6	4.3	\$ 186	\$ 207
	HRVT1560PM	7	6.7	\$ 205	\$ 226
 <p>30"H Painted Metal Tile</p> <p>30"H x 24"W</p> <p>30"H x 30"W</p> <p>30"H x 36"W</p> <p>30"H x 42"W</p> <p>30"H x 48"W</p> <p>30"H x 60"W</p> <p>⚠ Segment bars ordered separately. See page 325.</p>	HRVT3024PM	6	1.2	\$ 199	\$ 232
	HRVT3030PM	7	1.8	\$ 216	\$ 249
	HRVT3036PM	8	2.5	\$ 244	\$ 277
	HRVT3042PM	10	3.4	\$ 261	\$ 294
	HRVT3048PM	11	4.3	\$ 291	\$ 324
	HRVT3060PM	13	6.7	\$ 327	\$ 360

How to specify

<p>Select Model Number from above</p> <p>H R V T 1 5 2 4 P M .</p>	<p>1st Option</p> <p>Select Paint Color</p> <p>See page 309</p> <p>T 3</p>
--	--

Icon Legend on page 10

Abound® Plains Tile

GSA SIN 711-1

HON

► Plains tile is made of a tri-colored polymer material.











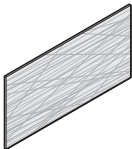

► Plains tiles are crafted by hand. Pattern variations between tiles reflect the unique nature of the material.

► Tiles attach with Custom Mounting Kit, included. Specify paint color.

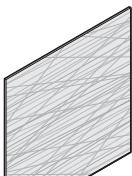
► For worksurfaces that can be used with both Abound® and Accelerate® systems, see pages 395-406.

⚠ Tiles do not include segment bars, must be ordered separately. See page 325. Can be used in any combination.



	Description	Model	Ship		Core/Metallic
			Weight	Cube	List
	15"H Plains Tiles				
	15"H x 24"W	HRVT1524ST	10 	0.9	\$ 253
	15"H x 30"W	HRVT1530ST	12 	1.0	\$ 294
	15"H x 36"W	HRVT1536ST	14 	1.2	\$ 361
	15"H x 42"W	HRVT1542ST	16 	1.4	\$ 382
	15"H x 48"W	HRVT1548ST	19 	1.6	\$ 402
	15"H x 60"W	HRVT1560ST	23 	2.0	\$ 447
	30"H Plains Tiles				
	30"H x 24"W	HRVT3024ST	14 	1.6	\$ 417
	30"H x 30"W	HRVT3030ST	16 	2.0	\$ 462
	30"H x 36"W	HRVT3036ST	18 	2.3	\$ 595
	30"H x 42"W	HRVT3042ST	20 	2.7	\$ 650
	30"H x 48"W	HRVT3048ST	23 	3.2	\$ 682
	30"H x 60"W	HRVT3060ST	25 	3.9	\$ 853

⚠ Segment bars ordered separately. See page 325.

How to specify	1st Option	2nd Option
Select Model Number from above H R V T 1 5 2 4 S T .	Select Plains Tile Color PL01 Frost PL02 Sunrise P L 0 1 .	Select Paint Color See page 309. No upcharge for Metallic Paint. T 1

 Icon Legend on page 10

► Custom Material Bracket Kits can be ordered to use with Customers Own Material.

► Coat hooks hang directly into slotted Abound panel frame.

⚠ Coat hooks are available in black only and ship 6 per package.



	Description	Model	Ship		List
			Weight	Cube	
	Custom Material Mounting Bracket Kit				
	15"H x 24"W	HRVT1524CK	1	0.8	\$ 58
	15"H x 30"W	HRVT1530CK	1	0.9	\$ 62
	15"H x 36"W	HRVT1536CK	1	1.1	\$ 66
	15"H x 42"W	HRVT1542CK	1	1.3	\$ 68
	15"H x 48"W	HRVT1548CK	2	1.5	\$ 71
	15"H x 60"W	HRVT1560CK	2	1.8	\$ 80
	30"H x 24"W	HRVT3024CK	3	1.4	\$ 58
	30"H x 30"W	HRVT3030CK	3	1.8	\$ 62
	30"H x 36"W	HRVT3036CK	3	2.1	\$ 66
	30"H x 42"W	HRVT3042CK	4	2.4	\$ 68
	30"H x 48"W	HRVT3048CK	5	2.8	\$ 71
	30"H x 60"W	HRVT3060CK	5	3.4	\$ 80
	Coat Hooks Package of six	HHPMC6	1	0.2	\$ 79
	NOTES: Compatible with Accelerate® and Abound® panels. ⚠ Black only.				

desks workstations storage & files seating tables education/learning accessories bundles index

How to specify

Select Model Number from above

H | R | V | T | 1 | 5 | 2 | 4 | C | K

► LAMINATE TOPS
SPECIFY: Model Number.
Laminate.
Edge Color.
Grommet Color
EXAMPLE: HWR2424PK8.R.T5

► PANELS
SPECIFY: Model Number.
Fabric
Paint
EXAMPLE: HETP3520FP.CE18.S

► CONNECTORS
SPECIFY: Model Number.
Paint
EXAMPLE: HEC35PS.T3

Accelerate® Finishes Availability

		Codes	Panels/Connectors/ Finished End Covers	Worksurfaces, Countertops and Corner Shelves with T-Mold	Worksurfaces, Countertops and Corner Shelves with Edgeband	Worksurface Supports	Overhead Cabinets/Shelves	Duplex Receptacles and Ported Tile Grommets
L1 LAMINATES								
Woodgrain	Bourbon Cherry	H		•	•			
	Cognac	COGN		•	•			
	Harvest	C		•	•			
	Mahogany	N		•	•			
	Mocha	MOCH		•	•			
	Natural Maple	D		•	•			
	Pinnacle	PINC		•	•			
	Shaker Cherry	F		•	•			
	Brilliant White	WHIT		•	•			
	Whitestone	K4		•	•			
Patterned	Sheer Mesh	A5		•	•			
	Silver Mesh	B9		•	•			
	Steel Mesh	A9		•	•			
	Taupe Mesh	A8		•	•			
	Canyon Zephyr	K9		•	•			
	Desert Zephyr	K8		•	•			
	Shadow Zephyr	K1		•	•			
	Gray	G2		•	•			
	Grey Tigris	L6		•	•			
	White	G1		•	•			
L2 LAMINATES								
Woodgrain	Lowell Ash <i>NEW! 1/30/2017</i>	LLA1		•	•			
	Natural Recon <i>NEW! 1/30/2017</i>	LNR1		•	•			
	Phantom Ecu <i>NEW! 1/30/2017</i>	LPE1		•	•			
	Portico Teak <i>NEW! 1/30/2017</i>	LPT1		•	•			
	Skyline Walnut <i>NEW! 1/30/2017</i>	LSW1		•	•			
PAINTS/GROMMETS								
Core	Black	P	•	•	•	•	•	•
	Charcoal	S	•	•	•	•	•	•
	Greige	T5	•	•	•	•	•	•
	Light Gray	Q	•	•	•	•	•	•
	Loft	LOFT	•	•	•	•	•	•
	Muslin	T3	•	•	•	•	•	•
	Putty	L	•	•	•	•	•	•
	Shadow	SHDW	•	•	•	•	•	•
Metallic	Brilliant White	WHIT	•	•	•	•	•	•
	Champagne Metallic	T4	•	•	•	•	•	•
	Platinum Metallic	T1	•	•	•	•	•	•
T-MOLD								
	Black	P		•				
	Brilliant White	WHIT		•				
	Charcoal	S		•				
	Greige	R		•				
	Light Gray	Q		•				
	Loft	LOFT		•				
	Muslin	T		•				
	Platinum	K		•				
Shadow	SHDW		•					
EDGEBAND								
	Black	P			•			
	Bourbon Cherry	H			•			
	Brilliant White	WHIT			•			
	Charcoal	S			•			
	Cognac	COGN			•			
	Greige	R			•			
	Harvest	C			•			
	Light Gray	Q			•			
	Loft	LOFT			•			
	Lowell Ash <i>NEW! 1/30/2017</i>	DL			•			
	Mahogany	N			•			
	Mocha	MOCH			•			
	Muslin	T			•			
	Natural Maple	D			•			
	Natural Recon <i>NEW! 1/30/2017</i>	NR			•			
	Phantom Ecu <i>NEW! 1/30/2017</i>	PE			•			
	Pinnacle	PINC			•			
	Platinum	K			•			
	Portico Teak <i>NEW! 1/30/2017</i>	DP			•			
	Shadow	SHDW			•			
	Shaker Cherry	F			•			
	Skyline Walnut <i>NEW! 1/30/2017</i>	SW			•			

Recommended Edgeband Color Selection:

Laminate	Edgeband
Bourbon Cherry H	Bourbon Cherry H
Cognac COGN	Cognac COGN
Harvest C	Harvest C
Mahogany N	Mahogany N
Mocha MOCH	Mocha MOCH
Natural Maple D	Natural Maple D
Pinnacle PINC	Pinnacle PINC
Shaker Cherry F	Shaker Cherry F
Brilliant White WHIT	Brilliant White WHIT
Sheer Mesh A5	Muslin T
Silver Mesh B9	Loft LOFT
Lowell Ash LLA1	Lowell Ash DL
Natural Recon LNR1	Natural Recon NR
Phantom Ecu LPE1	Phantom Ecu PE
Portico Teak LPT1	Portico Teak DP
Skyline Walnut LSW1	Skyline Walnut SW

Replacement Duplex Receptacle Covers are made from a polymer material and are available in the following colors only:

Black P
Muslin T3
Shadow SHDW

Below is a list of suggested Receptacle Cover colors that will coordinate with HON Paint options:

Paint	Receptacle Color
Brilliant White WHIT	Muslin T3
Charcoal S	Black P
Greige T5	Muslin T3
Light Gray Q	Muslin T3
Loft LOFT	Muslin T3
Muslin T3	Muslin T3
Putty L	Muslin T3
Shadow SHDW	Shadow SHDW

► DUPLEX COLOR SELECTION

- For Champagne Metallic Paint, Greige is suggested for the duplex and grommet color.
- For Putty paint color, Greige is the suggested duplex and grommet color.
- For Black paint color, Charcoal is the suggested duplex color.
- For Light Gray paint, Platinum Metallic is the suggested duplex color.

Accelerate® Ordering Information

► **NEW!** Grade A Reflections. Available January 30, 2017.

► **FOR PANELS SPECIFY:** Model Number
Fabric Pattern
Fabric Color
Paint Color
EXAMPLE: HETP3520FF.GN65.S

► 6" x 6" fabric samples are recommended to determine color and pattern on panels.

► Non-tackable panels have a unique substrate which may cause a slight color variation with certain, light-colored fabrics.

Accelerate® Panel Fabrics...Ordering Codes

For COM Fabrics, see pages 6-7.

PRICE CODE A

Appoint	Element*	Lucy*	Tango
Artichoke APN11	Flint GN65	Aspen LC32	Aficionado TG94
Blackberry APN32	Indigo GN67	Cornsilk LC30	Azul TG93
Bronze APN22	Latte GN73	Dusk LC22	Bongo TG31
Carbon APN28	Millet GN72	Fawn LC33	Dip TG35
Chai APN12	Parchment GN53	Graphite LC34	Palma TG91
Cherry APN30	Sea GN74	Mist LC20	Pecan TG39
Copper [] APN18	Veil GN13	Neutra LC24	Pistachio TG38
Dark Pewter APN17	Warm Beige GN55	Pewter LC35	Playa TG33
Dune APN15	Wispy GN75	Snowdrop LC28	Salsa TG37
Espresso APN23			Sol TG92
Framboise APN31	Etch*	Reflections - NEW! Available	Tequila TG30
Frost APN34	Aquatint ECH01	1/30/2017	
Hummus [] APN14	Crosshatch ECH04	Galvanized REF29	Tempest*
Jet APN27	Engrave ECH02	Ice REF20	Dragonfly TP30
Lawn APN25	Intaglio ECH06	Loggia REF21	Frost TP15
Mandarin APN29	Lithograph ECH03	Mistral REF28	Full Stream TP80
Morel APN09	Mezzotint ECH07	Moonstone REF23	Ginger [] TP25
Nimbus APN16	Woodcut ECH05	Pewter REF22	Goldrush TP10
Platinum APN24		Stainless REF24	Sandstorm [] TP50
Turmeric [] APN10	Hatch*	Vanilla REF25	Slate TP45
Turquoise APN26	Canvas HC15	Winter REF27	Tumbleweed TP70
Walnut [] APN13	Chroma HC55		Wind Chill TP40
	Clay HC25	Refuge	Zebra TP35
	Easel HC20	Dune RFG92	
Bix*	Glaze HC50	Eclipse NEW! 1/30/2017 RFG90	
Bridge BX06	Graphite HC40	Frost RFG93	
Field BX08	Monochrome HC30	Glacier NEW! 1/30/2017 RFG91	
Fort BX09	Patina HC45	Tidal RFG94	
Hay BX03	Sketch HC35	Sandbar [] RFG95	
River BX07		Artesian RFG96	
Shell BX04	Landscape	Hemp [] RFG97	
Stone BX02	Azure LN55	Mineral RFG98	
	Cornsilk LN15		
	Drift NEW! 1/30/2017 LN05	Sarto	
	Khaki LN20	Ash SRT88	
	Maize LN40	Desert [] SRT33	
	Sheen NEW! 1/30/2017 LN10	Fog SRT14	
	Slate LN35	Lemongrass SRT49	
	Tangelo LN50	Meadow [] SRT25	
	Tide LN45	Mist SRT45	
	Umber LN25	Mushroom SRT76	
	Urban LN30	Oyster SRT18	
		Reef SRT64	
		Sesame SRT93	
		Shale SRT52	
		Wheat [] SRT13	

* Directional fabrics

► **NEW!** Grade B Coast. Available January 30, 2017.

► FOR PANELS SPECIFY: Model Number
Fabric Pattern
Fabric Color
Paint Color
EXAMPLE: HETP3520FP.GN65.S

► 6" x 6" fabric samples are recommended to determine color and pattern on panels.

► Non-tackable panels have a unique substrate which may cause a slight color variation with certain, light-colored fabrics.

Accelerate® Panel Fabrics...Ordering Codes

For COM Fabrics, see pages 6-7.

PRICE CODE B							
Coast - <i>NEW!</i> Available 1/30/2017		Mica	Spin	Terrain			
Channel	COA14	Anthracite	MCA11	Alabaster	SPIN02	Bay	TRRN05
Dune	COA03	Breeze	MCA18	Cavern	SPIN03	Bayou	TRRN35
Headlands	COA10	Bronze	MCA13	Cobblestone	SPIN04	Canyon	TRRN30
Marsh	COA02	Buff	MCA14	Ember	SPIN06	Cliff	TRRN45
Pebble	COA12	Cremini	MCA17	Flame	SPIN07	Crest	TRRN25
Pier	COA13	Crystal	MCAWT	Heron	SPIN13	Delta	TRRN10
Shoal	COA01	Dew	MCA20	Oat	SPIN01	Plateau	TRRN15
Silt	COA06	Dove	MCA12	Ocean	SPIN12	Ridge	TRRN20
Tide	COA08	Fresh	MCA16	Plum	SPIN15	Valley	TRRN40
		Mineral	MCA15	Pool	SPIN11		
		Nectar	MCA19	Raven	SPIN10		
		Shale	MCA10	Rhubarb	SPIN14		
				Tropic	SPIN08		
				Willow	SPIN05		

* Directional fabrics

Accelerate® Typicals

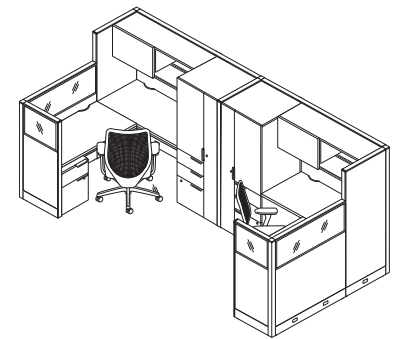

Qty	Product Description	Model #	Fabric Grade	List Price	Price Extension
2	Accelerate® Top Cap 72"W	HETC72		\$ 89	\$ 178
2	Tackable Panel 50"H x 72"W	HETP5072FP	A	\$536	\$1,072
1	"L" Connector 50"H	HEC50PL		\$125	\$ 125
2	Panel Finished End Covers 50"H	HEFEC50P		\$ 48	\$ 96
2	Electrical Power Harness Panels w/Duplex Capacity	HH871272		\$194	\$ 388
1	Duplex Receptacle Circuit 1 3-1 & 2-2	HH871501		\$ 37	\$ 37
1	Duplex Receptacle Circuit 4 3-1 & 2-2	HH871504		\$ 37	\$ 37
1	Base In-Feed Cable Base 3-1 & 2-2	HH879072		\$206	\$ 206
1	Rectangle Worksurface 48"W x 24"D	HWR2448SP		\$379	\$ 379
	Edgeband w/Scallops				
1	Rectangle Worksurface 72"W x 24"D	HWR2472SP		\$496	\$ 496
	Edgeband w/Scallops				
1	24"D Cantilever – One Pair	HCTL242		\$ 75	\$ 75
1	Flat Bracket 24"D	HHN831124		\$ 57	\$ 57
1	External Stiffener 48"W	HLSLZ5SC60		\$ 87	\$ 87
1	Flagship® Series Freestanding Pedestal "A" Pull B/B 15"W x 22 7/8"D x 28"H	H19723A		\$649	\$ 649
1	Flagship® Series Freestanding Pedestal "A" Pull F/F 15"W x 22 7/8"D x 28"H	H19823A		\$649	\$ 649
1	Pedestal-to-Panel Bracket, Left	HPD2PNBRK2L		\$ 96	\$ 96
1	Pedestal-to-Panel Bracket, Right	HPD2PNBRK2R		\$ 96	\$ 96
1	Lota® Mid-Back Chair	H2281	1	\$545	\$ 545
				TOTAL:	\$5,268

Qty	Product Description	Model #	Fabric Grade	List Price	Price Extension
2	Tackable Top-Tier Glass Panel 50"H x 20"W	HETP5020DP	A	\$ 468	\$ 936
2	Tackable Top-Tier Glass Panel 50"H x 42"W	HETP5042DP	A	\$ 555	\$ 1,110
5	Tackable Panel 65"H x 24"W	HETP6524FP	A	\$ 329	\$ 1,645
2	Tackable Panel 65"H x 48"W	HETP6548FP	A	\$ 422	\$ 844
2	Accelerate® Top Cap 72"W	HETC72		\$ 89	\$ 178
3	Accelerate® Top Cap 24"W	HETC24		\$ 31	\$ 93
2	Accelerate® Top Cap 20"W	HETC20		\$ 31	\$ 62
2	Accelerate® Top Cap 42"W	HETC42		\$ 51	\$ 102
4	Worksurface Bracket Kits	HWSB2		\$ 40	\$ 160
2	Flat Bracket 24"D	HHN831124		\$ 57	\$ 114
2	Straight Connector Kits	HSCKTPS		\$ 15	\$ 30
2	"L" Connector 50"H	HEC50PL		\$ 125	\$ 250
2	"L" Connector 65"H	HEC65PL		\$ 138	\$ 276
1	"T" Connector 65"H	HEC65PT		\$ 138	\$ 138
2	Panel Finished End Covers 50"H	HEFEC50P		\$ 48	\$ 96
1	Panel Finished End Covers 65"H	HEFEC65P		\$ 55	\$ 55
2	In-line Variable Height Finishing Kit 15"H	HEVHF15P		\$ 47	\$ 94
2	Electrical Power Harness 3-1 & 2-2 48"W	HH871248		\$ 194	\$ 388
1	Electrical Pass-Thru w/o Power Block 3-1 & 2-2 48"W	HH871501		\$ 37	\$ 37
1	Base In-Feed Cable Base 3-1 & 2-2	HH879072		\$ 206	\$ 206
1	Duplex Receptacle Circuit 1 3-1 & 2-2	HH871501		\$ 37	\$ 37
1	Duplex Receptacle Circuit 2 3-1 & 2-2	HH871502		\$ 37	\$ 37
1	Duplex Receptacle Circuit 4 3-1 & 2-2	HH871504		\$ 37	\$ 37
1	Duplex Receptacle Circuit 1 3-1 & 2-2	HH871506		\$ 37	\$ 37
2	Rectangle Worksurface 42"W x 20"D	HWR1842SP		\$ 311	\$ 622
	Edgeband w/Scallops				
2	Rectangle Worksurface 48"W x 24"D	HWR2448SP		\$ 379	\$ 758
	Edgeband w/Scallops				
2	Worksurface to Tower Bracket Kits	HSTB2W1		\$ 68	\$ 136
2	Stack-on Storage w/Sliding Doors 14 1/4"D x 48"W x 13"H	HLSL1448S		\$ 954	\$ 1,908
2	Voi® for Systems Stack-on Storage Panel Mounted Bracket	HLSLPMB		\$ 114	\$ 228
2	Voi® Mobile Pedestal 15 3/4"W x 21 1/16"D x 21 7/16"H	HLSL2016MP2	1	\$ 716	\$ 1,432
2	Voi® Pedestal Cushion	HLSL2016PH2		\$ 297	\$ 594
1	Voi® Personal Storage Tower (LH) 24"D x 24"W x 65"H	HLSLW446LP		\$2,311	\$ 2,311
1	Voi® Personal Storage Tower (RH) 24"D x 24"W x 65"H	HLSLW446RP		\$2,311	\$ 2,311
2	Nucleus® ilira® -stretch Back Work Chair	HN1	1	\$ 788	\$ 1,576
				TOTAL:	\$18,838

Qty	Product Description	Model #	Fabric Grade	List Price	Price Extension
1	Tackable Panel 42½"H x 24"W	HETP4224FP	A	\$ 272	\$ 272
1	Tackable Panel 42½"H x 48"W	HETP4248FP	A	\$ 344	\$ 344
2	Tackable Panel 65"H x 24"W	HETP6524FP	A	\$ 329	\$ 658
1	Tackable Panel 65"H x 60"W	HETP6560FP	A	\$ 450	\$ 450
1	Tackable Top-Tier Glass Panel 65"H x 36"W	HETP6536DP	A	\$ 552	\$ 552
1	Accelerate® Top Cap 60"W	HETC60		\$ 70	\$ 70
3	Accelerate® Top Cap 24"W	HETC24		\$ 31	\$ 93
1	Accelerate® Top Cap 48"W	HETC48		\$ 58	\$ 58
2	Accelerate® Countertop Kit	HECB42		\$ 44	\$ 88
1	24"D Cantilever – One Pair	HCTL242		\$ 75	\$ 75
1	"L" Connector 42½"H	HEC42PL		\$ 108	\$ 108
2	"L" Connector 65"H	HEC65PL		\$ 138	\$ 276
1	Straight Connector Kit	HSCKTSP		\$ 15	\$ 15
1	In-line Variable Height Finishing Kit 22½"H	HEVHF22P		\$ 57	\$ 57
1	Panel Finished End Covers 42½"H	HEFEC42P		\$ 45	\$ 45
1	Panel Finished End Covers 65"H	HEFEC65P		\$ 55	\$ 55
1	Electrical Power Harness 3-1 & 2-2 60"W	HH871260		\$ 194	\$ 194
1	Duplex Receptacle Circuit 1 3-1 & 2-2	HH871501		\$ 37	\$ 37
1	Duplex Receptacle Circuit 4 3-1 & 2-2	HH871504		\$ 37	\$ 37
1	Base In-Feed Cable Base 3-1 & 2-2	HH879072		\$ 206	\$ 206
1	Rectangle Worksurface 48"W x 24"D	HWR2448SP		\$ 379	\$ 379
	Edgeband w/Scallops				
1	Corner Cove 36" x 60"-24L/24R	HWV73AARSP		\$ 572	\$ 572
	Edgeband w/Scallops				
1	Straight Countertops – Edgeband 48"W x 15"D	HBCSR1548P		\$ 279	\$ 279
1	Worksurface to Tower Bracket Kit	HSTB2W1		\$ 68	\$ 68
1	Worksurface Bracket Kit	HWSB2		\$ 40	\$ 40
1	60" Flipper Door Overhead	HRVOH60FM		\$ 759	\$ 759
1	Task Light 60"W	HH870960		\$ 240	\$ 240
1	Lateral File Bottom Shelf w/Doors Top "A" Pull	HFC1830DLFA		\$1,063	\$1,063
1	Ignition® Mid-Back Work Chair	HIWM3	1	\$ 673	\$ 673
1	Accelerate® Top Cap 36"W	HETC36		\$ 48	\$ 48
1	External Stiffener 48"W	HLSLZ5SC60		\$ 87	\$ 87
				TOTAL:	\$7,898

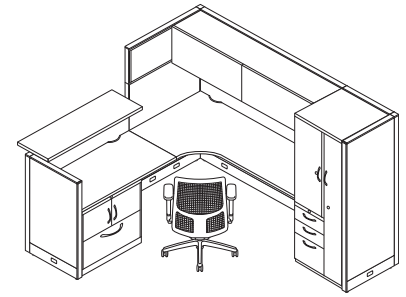

Qty	Product Description	Model #	Fabric Grade	List Price	Price Extension
2	Tackable Panel 42½"H x 24"W	HETP4224FP	A	\$272	\$ 544
2	Tackable Panel 42½"H x 60"W	HETP4260FP	A	\$383	\$ 766
2	Accelerate® Top Cap 60"W	HETC60		\$ 70	\$ 140
2	Accelerate® Top Cap 24"W	HETC24		\$ 31	\$ 62
4	Accelerate® Countertop Kit	HECB42		\$ 44	\$ 176
2	Worksurface Bracket Kit	HWSB2		\$ 40	\$ 80
1	Universal Support Leg 24"D	HRVCLG24		\$179	\$ 179
2	"L" Connector 42½"H	HEC42PL		\$108	\$ 216
2	Panel Finished End Covers 42½"H	HEFEC42P		\$ 45	\$ 90
1	Base In-Feed Cable Base 3-1 & 2-2	HH879072		\$206	\$ 206
1	Electrical Pass-Thru Cable w/Duplex For 24"W Panel	HH871124		\$115	\$ 115
2	Electrical Power Harness 3-1 & 2-2 60"W	HH871260		\$194	\$ 388
2	Duplex Receptacle Circuit 4 3-1 & 2-2	HH871504		\$ 37	\$ 74
2	Rectangle Worksurface 60"W x 24"D	HWR2460SP		\$447	\$ 894
	Edgeband w/Scallops				
2	Straight Countertop 60"W x 15"D	HBCSR1560P		\$354	\$ 708
2	Flagship® Mobile Series Pedestal "A" Pull B/B/F 15"W x 22½"D x 28"H	H18723A		\$658	\$1,316
2	Ignition® Mid-Back Work Chair	HIWM3	1	\$673	\$1,346
				TOTAL:	\$7,300



Accelerate® Typicals

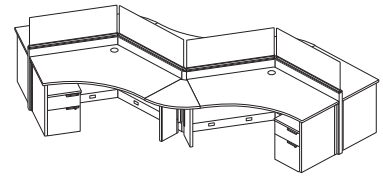

Qty	Product Description	Model #	Fabric Grade	List Price	Price Extension
3	Systems Corner Worksurface w/ 120° Curve Edge 42"W x 24"D	HBWCT4224P		\$781	\$ 2,343
3	Systems 60° Wedge Worksurface Edgeband 24"W x 24"D	HBWQT2424P		\$370	\$ 1,110
3	120° 2-way Connector 35"H	HEC35P2		\$ 94	\$ 282
2	Panel Finished End Covers 35"H	HEFEC35P		\$ 42	\$ 84
4	Frameless Glass 15"H x 42"W	HEFG1542		\$489	\$ 1,956
4	Tackable Panel 35"H x 42"W	HETP3542FP	A	\$293	\$ 1,172
4	Electrical Power Harness 3-1 & 2-2 Systems 42"W	HH871242		\$194	\$ 776
1	Duplex Receptacle Circuit 1 3-1 & 2-2 Systems	HH871501		\$ 37	\$ 37
2	Duplex Receptacle Circuit 2 3-1 & 2-2 Systems	HH871502		\$ 37	\$ 74
2	Duplex Receptacle Circuit 3 3-1 System Only	HH871503		\$ 37	\$ 74
3	Duplex Receptacle Circuit 4 3-1 & 2-2 Systems	HH871504		\$ 37	\$ 111
1	Base In-Feed Cable Base 3-1 & 2-2 Systems	HH879072		\$206	\$ 206
3	Mobile Pedestal 20"W x 15½"D x 21½"H	HLSL2016MP2		\$716	\$ 2,148
3	Pedestal Cushion 20"W x 15½"D x 1"H	HLSL2016PH2	2	\$297	\$ 891
2	Abound® Left End Panel 29"H x 24"D	HRVEP2429L		\$202	\$ 404
2	Abound® Right End Panel 29"H x 24"D	HRVEP2429R		\$202	\$ 404
2	Systems Rectangular Worksurface Edgeband 24"D x 42"W	HWR2442P		\$356	\$ 712
6	Universal Support Leg 24"D	HRVCLG24		\$179	\$ 1,074
				TOTAL:	\$13,858

Intersecting connections

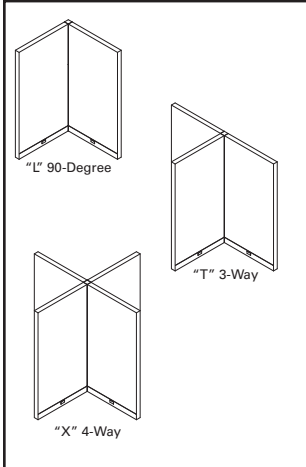

"L", "T" and "X" connector kits are used when connecting frames at intersecting runs. For "L", "T" and "X" connector kits, add 2 1/4" to the total length of the panel run for each intersection, whether located in the middle or at the end of the run.

Wall starter kits provide a means to affix a panel run to a permanent building wall. Kit adds 7/8" to length of panel run.

Stacking panels

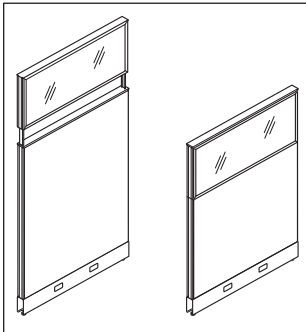

Stackers add 15" to the height of the base panel and can be ordered separately or as part of the panel model, see pages 360 and 364.

When adding stackers to an existing panel, a new connector must be ordered, to the tallest panel height. Please note that Stacking Panels are not to be used freestanding and must match the panel width of the panel it is stacking on.

Cannot use a stacking panel on a Top Tier Glass Panel model.

Stackers ship with pins to connect stacker to post connector for added rigidity.

Stackers can be stacked up to 80"H on a base panel. Stackers are weight bearing and can accommodate overhead storage.

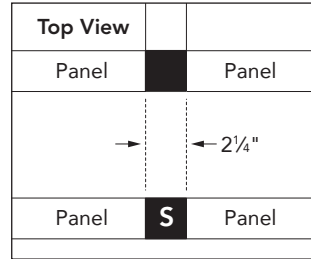

Extended straight connector kit "S" can be used to keep continuous runs dimensionally consistent with opposing panel runs which incorporate "T" or "X" intersections. (Add 2 1/4" to the length of the run for every extended straight connector used.)

In-line connections

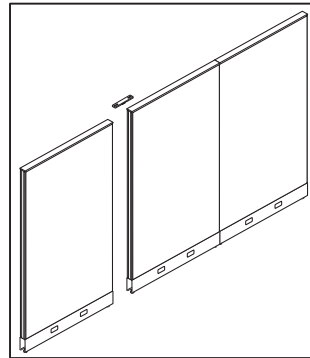

There is no incremental increase in dimension along the panel run when using an in-line connector kit.

End of run

Finished end trim must be specified for the unconnected sides of panel. When adding a stacking panel, order finished end trim in the height that matches the total stacked height. Move the end cap from the standard frame end trim to the stacking frame end trim.

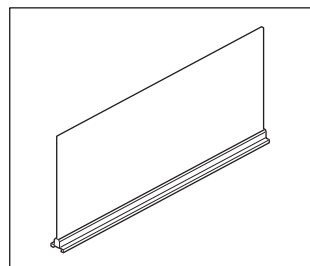

Accelerate® frameless glass is single pane, 3/8" thick laminate safety glass, available in clear or frosted glass.

Frameless glass can only be used on the tallest panel in a typical, not at inline or post connectors with variable

height. Frameless glass is not allowed on top of glass stackers or glass header panels and hanging or stacking on frameless glass is not permitted.

Frameless glass can span multiple panels with one piece of glass, creating a clean, seamless look.

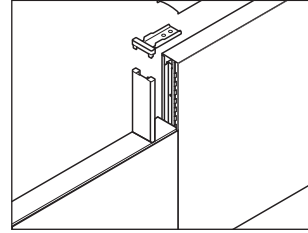

In-line Variable Height Trim In-line connections between different height panels require trim to cover the exposed frame of the taller panel.

Variable Height Connector Trim

L, X and T connections between different height panels require trim to cover the exposed connector. The bottom of the trim is flat to match the profile of the top cap. Models are designated as "Variable Height Connector Trim". For variable height connections in a Y configuration, contact the Accelerate Specials Department.

Multiple-height connections are accomplished by combining standard height panel connectors (35"H, 42"H, 50"H and 65"H) with shorter trim kits (7"H, 15"H, 22"H and 30"H). Start from the top-down — select the standard connector that corresponds to the height and connection type of the tallest panel. (See examples.)

Example 1

Connectors required:
1-50"H "T" Connector
2-15"H Connector VH Kit
2-35"H End Trim
1-65"H End Trim

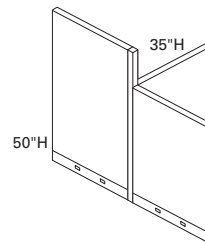

In variable height "T" connections — as shown above — you would use the connectors as indicated.

Example 2

Connectors required:
1-50"H "X" Connector
2-7 1/2"H Connector VH Kit
2-50"H End Trim
2-42"H End Trim

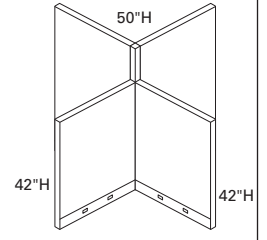

Example 3

Connectors required:
1-65"H "T" Connector
1-15"H Connector VH Kit
1-22 1/2"H Connector VH Kit
1-65"H End Trim
1-50"H End Trim
1-42"H End Trim

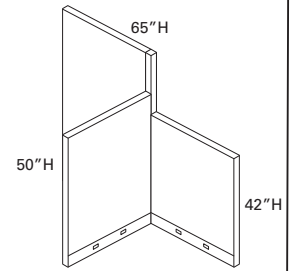

Example above represents Accelerate variable height "L" for 65" to 50".

Tackable and Non-Tackable Panels

Non-tackable panels have a unique substrate which may cause a slight color variation with certain, light-colored fabrics.

Top Caps

Top caps must be specified as a separate model from the panel. Top caps can span more than one panel when panels are connected in an in-line.

Panels

- Accelerate® Panels are 2 1/8" thick and available in 4 heights / 8 widths.

NOTE: Actual panel height varies depending on position of levelers.

NOMINAL PANEL HEIGHT	PANEL WIDTHS							
	20"	24"	30"	36"	42"	48"	60"	72"
35"	20"	24"	30"	36"	42"	48"	60"	72"
42 1/2"	20"	24"	30"	36"	42"	48"	60"	72"
50"	20"	24"	30"	36"	42"	48"	60"	72"
65"	20"	24"	30"	36"	42"	48"	60"	72"

Maximum Receptacle Capacity in Panel Base Pathways

Widths	20	24	30	36	42	48	60	72
Maximum of 1 duplex per panel side	N/A	X						
Maximum of 2 duplexes per panel side	N/A		X	X	X	X	X	X

The center of the duplex is always 12" from the end of the panel on all Accelerate® panels.

Panel Specification and Installation Notes

Definitions:

Parent Panel Run – Panels (or a single panel) configured in a straight line intended to divide space. It is usually longer than the panels used to stabilize it.

Return Panels – Panels attached to a parent run for the purpose of stabilizing it. Return panels may also have the effect of dividing space.

Note: Return panels must be no more than 30" lower than the maximum height of the parent panel run. When stacking, the maximum height allowed is 80". This includes frameless glass. If attaching overhead storage, return panels must be the same height as parent run.

Method 1: Opposing Returns

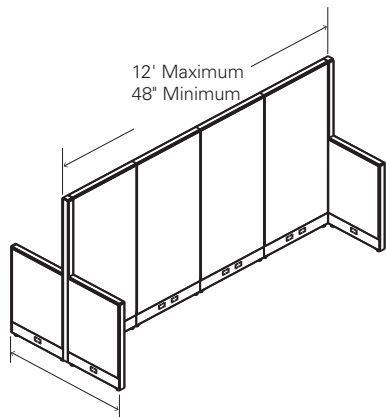

A parent panel run must be a minimum of 4 feet and a maximum of 12 feet, and must have a minimum of two return panels extended in opposing directions on each side of the parent run.

Panel Run Length	Minimum Return Panels	Minimum Return Panels with Stack-ons
48"	20"	20"
54"	20"	20"
60"	20"	20"
66"	20"	20"
72"	20"	20"
78"	20"	20"
84"	20"	20"
90"	20"	20"
96"	20"	20"
102"	20"	20"
108"	24"	24"
114"	24"	24"
120"	24"	24"
144"	24"	24"

Method 2: Single Sided

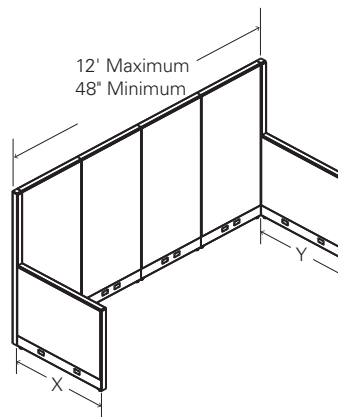

A parent panel run must be a minimum of 4 feet and a maximum of 12 feet, and must have a minimum of two return panels (X+Y) extended in one direction (one at the beginning and at the end of the parent run) as defined below.

Panel Run Length	Minimum Return Panels Total (X+Y)	Minimum Return Panels Total (X+Y) with Stack-ons
48"	84"	84"
54"	84"	84"
60"	84"	84"
66"	84"	84"
72"	84"	84"
78"	84"	84"
84"	84"	84"
90"	84"	84"
96"	84"	84"
102"	84"	84"
108"	84"	96"
114"	84"	96"
120"	84"	96"
144"	84"	96"

Connector Kits — Accelerate®

- TPS** In-line Connector
- PS** Extended Straight Connector
- PL** "L" Connector
- PT** "T" Connector
- PX** "X" Connector
- P2** 120° 2-way Connector
- P3** 120° 3-way Connector
- CV** Connector Variable Height Finishing Kit
- VH** In-line Variable Height Finishing Kit

Additional Models for Use with Connector Kits

- FE** Finished End Covers
- WS** Wall Starter Kit
- WT** Wall Track

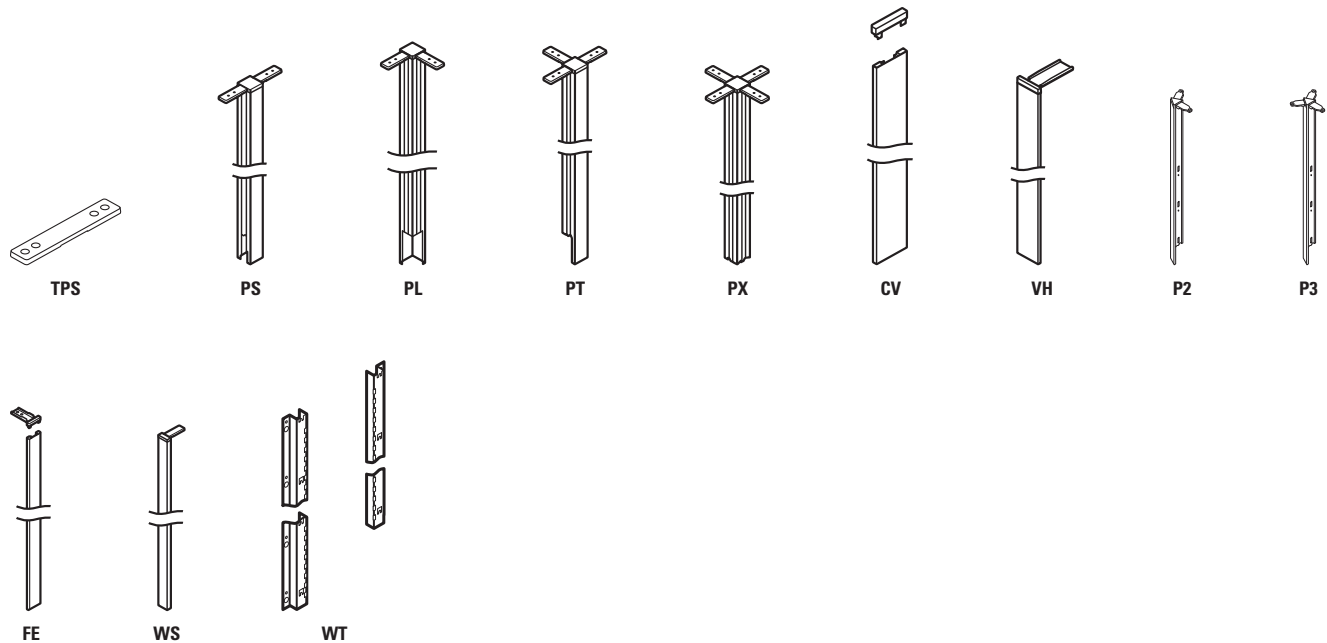

Panel-to-Panel Connector

- Attaches same height, panel-to-panel in a straight run with screws.
- Ensures alignment on panels in a straight run.

Wall Starter Kit (see page 367)

- Anchor devices are not supplied with the wall starter kit. Refer to Accelerate® Installation Instructions for appropriate hardware.
- Adds 7/8" to length of run.

Accelerate® Tackable Raceway Panels

GSA SIN 711-1



- ▶ Panels are 2 1/8" thick.
- ▶ Panels have steel top caps.
- ▶ Baseraills ship standard with panels.
- ▶ Top caps ordered separately; see page 363.
- ▶ Packaging: stretch wrapped with edge protection.
- ▶ Base rail matches trim color.
- ▶ For worksurfaces that can be used with Abound® and Accelerate® systems, see pages 395-406.
- ▶ Specify top caps separately; see page 363.
- ▶ Panel end trim ordered separately; see page 367.
- ▶ Panels may be connected end to end, with wall starter kit, or with panel connectors; see pages 366-367.
- ▶ Order connecting hardware separately; see page 366.
- ▶ Order Accelerate® connectors separately; see page 366.
- ▶ Panels have a class A fire rating.
- ▶ Bulk packing is available in quantities of 3 or 9.
- ▶ Fabrics and finishes available on pages 349-351.
- ▶ For information regarding the use of tackable and non-tackable panels in the same application, see page 355.
- ▶ **Baseraill cutout covers are not replaceable once removed.**
- ▶ **Raceway panels option only.**
- ▶ **Do not remove electrical knock outs unless duplex is needed. For replacement covers, see page 390.**
- ▶ **Caution when mixing Non-Tackable and Tackable panels in an in-line run, as non-tackable panels have a unique substrate which may cause a slight color variation with certain, lightcolored fabrics.**
- ▶ **Accepts electrical power kits, except for 20"W. See page 389 for electrical.**
- ▶ **Stack on panels add 15" of height and can be added to any monolithic panel. See stackers on page 364.**
- ▶ **Stackers are weight bearing and can accommodate overhead storage.**



Description	Model	Ship Weight	Cube	Core List Price by Code	
				A	B
35"H Tackable Acoustical Panels					
35"H x 20"W	HETP3520FP	13	1.0	\$ 246	\$ 265
35"H x 24"W	HETP3524FP	14	1.2	\$ 255	\$ 297
35"H x 30"W	HETP3530FP	16	1.5	\$ 268	\$ 313
35"H x 36"W	HETP3536FP	18	1.8	\$ 288	\$ 335
35"H x 42"W	HETP3542FP	20	2.1	\$ 293	\$ 346
35"H x 48"W	HETP3548FP	23	2.4	\$ 309	\$ 364
35"H x 60"W	HETP3560FP	27	3.0	\$ 336	\$ 401
35"H x 72"W	HETP3572FP	33	3.6	\$ 466	\$ 539
42 1/2"H Tackable Acoustical Panels					
42 1/2"H x 20"W	HETP4220FP	14	1.2	\$ 260	\$ 292
42 1/2"H x 24"W	HETP4224FP	16	1.5	\$ 272	\$ 304
42 1/2"H x 30"W	HETP4230FP	18	1.8	\$ 286	\$ 325
42 1/2"H x 36"W	HETP4236FP	20	2.2	\$ 302	\$ 344
42 1/2"H x 42"W	HETP4242FP	23	2.6	\$ 330	\$ 379
42 1/2"H x 48"W	HETP4248FP	25	3.0	\$ 344	\$ 403
42 1/2"H x 60"W	HETP4260FP	30	3.7	\$ 383	\$ 452
42 1/2"H x 72"W	HETP4272FP	36	4.4	\$ 491	\$ 570
50"H Tackable Acoustical Panels					
50"H x 20"W	HETP5020FP	16	1.4	\$ 298	\$ 361
50"H x 24"W	HETP5024FP	17	1.7	\$ 311	\$ 374
50"H x 30"W	HETP5030FP	20	2.2	\$ 319	\$ 363
50"H x 36"W	HETP5036FP	22	2.6	\$ 329	\$ 379
50"H x 42"W	HETP5042FP	25	3.0	\$ 370	\$ 428
50"H x 48"W	HETP5048FP	28	3.5	\$ 391	\$ 456
50"H x 60"W	HETP5060FP	32	4.3	\$ 426	\$ 500
50"H x 72"W	HETP5072FP	38	5.2	\$ 536	\$ 622
65"H Tackable Acoustical Panels					
65"H x 20"W	HETP6520FP	19	1.9	\$ 317	\$ 365
65"H x 24"W	HETP6524FP	20	2.3	\$ 329	\$ 377
65"H x 30"W	HETP6530FP	23	2.8	\$ 347	\$ 398
65"H x 36"W	HETP6536FP	26	3.4	\$ 372	\$ 430
65"H x 42"W	HETP6542FP	29	3.9	\$ 406	\$ 471
65"H x 48"W	HETP6548FP	32	4.5	\$ 422	\$ 495
65"H x 60"W	HETP6560FP	37	5.6	\$ 450	\$ 532
65"H x 72"W	HETP6572FP	43	6.8	\$ 606	\$ 698

How to specify	1st Option	2nd Option
<p>Select Model Number from above</p> <p>H E T P 3 5 2 0 F P .</p>	<p>Select Fabric</p> <p>See pages 350-351</p> <p>A P N 1 5 .</p>	<p>Select Trim Color</p> <p>See page 349</p> <p>Core Paint Choice (no upcharge)</p> <p>Choice/Metallic Paint (\$30 upcharge)</p> <p>S</p>

Icon Legend on page 10

- ▶ Panels are 2 1/8" thick.
- ▶ Panels have steel top caps.
- ▶ Baserails ship standard with panels.
- ▶ Top caps ordered separately; see page 363.
- ▶ Packaging: stretch wrapped with edge protection.
- ▶ Base rail matches trim color.
- ▶ Panel end trim ordered separately; see page 367.
- ▶ For worksurfaces that can be used with Abound™ and Accelerate® systems, see pages 395-406.
- ▶ Panels may be connected end to end, with wall starter kit, or with panel connectors; see pages 366-367.
- ▶ Order connecting hardware separately; see page 366.
- ▶ Order Accelerate® connectors separately; see page 366.
- ▶ Bulk packing is available in quantities of 3 or 9.
- ▶ Fabrics and finishes available on pages 349-351.
- ▶ Panels have a class C fire rating.
- ▶ For information regarding the use of tackable and non-tackable panels in the same application, see page 355.
- ▶ **Caution when mixing Non-Tackable and Tackable panels in an in-line run, as non-tackable panels have a unique substrate which may cause a slight color variation with certain, lightcolored fabrics.**
- ▶ **Baseraill cutout covers are not replaceable once removed.**
- ▶ **Raceway panels option only.**
- ▶ **Do not remove electrical knock outs unless duplex is needed. For replacement covers, see page 390.**
- ▶ **Accepts electrical power kits, except for 20"W. See page 389 for electrical.**

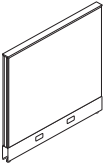
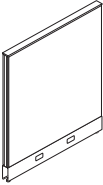
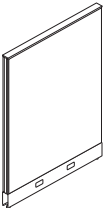
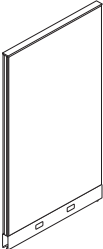

Description	Model	Ship		Core List Price by Code	
		Weight	Cube	A	B
 <p>35"H Non-Tackable Panels</p> <p>35"H x 20"W 35"H x 24"W 35"H x 30"W 35"H x 36"W 35"H x 42"W 35"H x 48"W 35"H x 60"W 35"H x 72"W</p>	HENTP3520FP	16 [S]	1.0	\$ 200	\$ 242
	HENTP3524FP	18 [S]	1.2	\$ 207	\$ 249
	HENTP3530FP	22 [S]	1.5	\$ 216	\$ 261
	HENTP3536FP	24 [S]	1.8	\$ 232	\$ 279
	HENTP3542FP	28 [S]	2.1	\$ 235	\$ 288
	HENTP3548FP	31 [S]	2.4	\$ 248	\$ 303
	HENTP3560FP	37	3.0	\$ 268	\$ 333
	HENTP3572FP	44	3.6	\$ 373	\$ 446
 <p>42 1/2"H Non-Tackable Panels</p> <p>42 1/2"H x 20"W 42 1/2"H x 24"W 42 1/2"H x 30"W 42 1/2"H x 36"W 42 1/2"H x 42"W 42 1/2"H x 48"W 42 1/2"H x 60"W 42 1/2"H x 72"W</p>	HENTP4220FP	18 [S]	1.2	\$ 212	\$ 244
	HENTP4224FP	20 [S]	1.5	\$ 221	\$ 253
	HENTP4230FP	24 [S]	1.8	\$ 233	\$ 272
	HENTP4236FP	28 [S]	2.2	\$ 243	\$ 285
	HENTP4242FP	31 [S]	2.6	\$ 266	\$ 315
	HENTP4248FP	35 [S]	3.0	\$ 276	\$ 335
	HENTP4260FP	41	3.7	\$ 306	\$ 375
	HENTP4272FP	50	4.4	\$ 395	\$ 474
 <p>50"H Non-Tackable Panels</p> <p>50"H x 20"W 50"H x 24"W 50"H x 30"W 50"H x 36"W 50"H x 42"W 50"H x 48"W 50"H x 60"W 50"H x 72"W</p>	HENTP5020FP	20	1.4	\$ 244	\$ 307
	HENTP5024FP	23	1.7	\$ 253	\$ 316
	HENTP5030FP	27	2.2	\$ 259	\$ 303
	HENTP5036FP	31	2.6	\$ 265	\$ 315
	HENTP5042FP	35	3.0	\$ 300	\$ 358
	HENTP5048FP	39	3.5	\$ 316	\$ 381
	HENTP5060FP	46	4.3	\$ 345	\$ 419
	HENTP5072FP	56	5.2	\$ 431	\$ 517
 <p>65"H Non-Tackable Panels</p> <p>65"H x 20"W 65"H x 24"W 65"H x 30"W 65"H x 36"W 65"H x 42"W 65"H x 48"W 65"H x 60"W 65"H x 72"W</p>	HENTP6520FP	25 [S]	1.9	\$ 259	\$ 307
	HENTP6524FP	28 [S]	2.3	\$ 269	\$ 317
	HENTP6530FP	32 [S]	2.8	\$ 283	\$ 334
	HENTP6536FP	37 [S]	3.4	\$ 302	\$ 360
	HENTP6542FP	42 [S]	3.9	\$ 330	\$ 395
	HENTP6548FP	46 [S]	4.5	\$ 342	\$ 415
	HENTP6560FP	55	5.6	\$ 362	\$ 444
	HENTP6572FP	68	6.8	\$ 490	\$ 582

How to specify	1st Option	2nd Option
<p>Select Model Number from above</p> <p>H E N T P 4 2 2 4 F P .</p>	<p>Select Fabric See pages 350-351</p> <p>G N 6 5 .</p>	<p>Select Trim Color See page 349 Core Paint Choice (no upcharge) Choice/Metallic Paint (\$30 upcharge)</p> <p>S </p>

Icon Legend on page 10

Accelerate® Top-Tier Glass Panels

GSA SIN 711-1



- ▶ On top-tier panel models, the glass tier is 15"H.
- ▶ Glass is clear or frosted, tempered safety glass.
- ▶ Panels are 2 1/8" thick.
- ▶ Panels have steel baserails.
- ▶ Packaging: stretch wrapped with edge protection.
- ▶ Base rail matches trim color.
- ▶ Top caps ordered separately; see page 363.
- ▶ For worksurfaces that can be used with Abound® and Accelerate® systems, see pages 395-406.
- ▶ Panel end trim ordered separately; see page 367.
- ▶ Panels may be connected end to end, with wall starter kit, or with panel connectors; see pages 366-367.
- ▶ Order connecting hardware separately; see page 366.
- ▶ Order Accelerate® connectors separately; see page 366.
- ▶ Panels have a class A fire rating.
- ▶ Bulk packing is available in quantities of 3 or 9.
- ▶ Fabrics and finishes available on pages 349-351.
- ▶ For information regarding the use of tackable and non-tackable panels in the same application, see page 355.
- ⚠ Raceway panels option only.
- ⚠ Do not remove electrical knock outs unless duplex is needed. For replacement covers, see page 390.
- ⚠ Accepts electrical power kits, except for 20"W. See page 389 for electrical.
- ⚠ Cannot stack stacker on top-tier glass panels.



Description	Model	Ship Weight	Cube	Core List Price by Code	
				A	B
50"H Tackable Panels — Top-Tier Glass					
50"H x 20"W	HETP5020DP	21	1.4	\$ 468	\$ 531
50"H x 24"W	HETP5024DP	23	1.7	\$ 486	\$ 549
50"H x 30"W	HETP5030DP	27	2.2	\$ 497	\$ 541
50"H x 36"W	HETP5036DP	31	2.6	\$ 507	\$ 557
50"H x 42"W	HETP5042DP	34	3.0	\$ 555	\$ 613
50"H x 48"W	HETP5048DP	39	3.5	\$ 581	\$ 646
50"H x 60"W	HETP5060DP	46	4.3	\$ 628	\$ 703
50"H x 72"W	HETP5072DP	55	5.2	\$ 830	\$ 915
65"H Tackable Panels — Top-Tier Glass					
65"H x 20"W	HETP6520DP	24	1.9	\$ 489	\$ 537
65"H x 24"W	HETP6524DP	27	2.3	\$ 504	\$ 552
65"H x 30"W	HETP6530DP	30	2.8	\$ 521	\$ 572
65"H x 36"W	HETP6536DP	34	3.4	\$ 552	\$ 610
65"H x 42"W	HETP6542DP	39	3.9	\$ 592	\$ 657
65"H x 48"W	HETP6548DP	43	4.5	\$ 612	\$ 685
65"H x 60"W	HETP6560DP	51	5.6	\$ 640	\$ 724
65"H x 72"W	HETP6572DP	60	6.8	\$ 903	\$ 995

How to specify	1st Option	2nd Option	3rd Option
Select Model Number from above H E T P 5 0 2 0 D P .	Select Fabric See pages 350-351 A P N 1 5 .	Select Trim Color See page 349 Core Paint Choice (no upcharge) Choice/Metallic Paint (\$30 upcharge) S .	Select Glass Q Clear Glass R Frosted Glass (\$30 upcharge) Q

Icon Legend on page 10

- ▶ On top-tier panel models, each tier is 15"H.
- ▶ Glass is tempered safety glass.
- ▶ Panels are 2 1/8" thick.
- ▶ Panels have steel baserails.
- ▶ Top caps ordered separately; see page 363.
- ▶ Packaging: stretch wrapped with edge protection.
- ▶ Base rail matches trim color.
- ▶ Panel end trim ordered separately; see page 367.
- ▶ Panels may be connected end to end, with wall starter kit, or with panel connectors; see pages 366-367.
- ▶ For worksurfaces that can be used with Abound® and Accelerate® systems, see pages 395-406.
- ▶ Order connecting hardware separately; see page 366.
- ▶ Order Accelerate® connectors separately; see page 366.
- ▶ Panels have a class C fire rating.
- ▶ Bulk packing is available in quantities of 3 or 9.
- ▶ Fabrics and finishes available on pages 349-351.
- ▶ For information regarding the use of tackable and non-tackable panels in the same application, see page 355.
- ▶ **Accepts electrical power kits, except for 20"W. See page 389 for electrical.**
- ▶ **Raceway panels option only.**
- ▶ **Baserail cutout covers are not replaceable once removed.**
- ▶ **Do not remove electrical knock outs unless duplex is needed. For replacement covers, see page 390.**



Description	Model	Ship Weight	Cube	Core List Price by Code	
				A	B
50"H Non-Tackable Panels — Top-Tier Glass					
50"H x 20"W	HENTP5020DP	24 [S]	1.9	\$ 384	\$ 447
50"H x 24"W	HENTP5024DP	29 [S]	1.7	\$ 394	\$ 457
50"H x 30"W	HENTP5030DP	34 [S]	2.2	\$ 403	\$ 447
50"H x 36"W	HENTP5036DP	40 [S]	2.6	\$ 410	\$ 460
50"H x 42"W	HENTP5042DP	44 [S]	3.0	\$ 448	\$ 506
50"H x 48"W	HENTP5048DP	50 [S]	3.5	\$ 468	\$ 533
50"H x 60"W	HENTP5060DP	60	4.3	\$ 504	\$ 579
50"H x 72"W	HENTP5072DP	73	5.2	\$ 669	\$ 754
65"H Non-Tackable Panels — Top-Tier Glass					
65"H x 20"W	HENTP6520DP	30 [S]	1.9	\$ 400	\$ 448
65"H x 24"W	HENTP6524DP	35 [S]	2.3	\$ 410	\$ 458
65"H x 30"W	HENTP6530DP	39 [S]	2.8	\$ 423	\$ 474
65"H x 36"W	HENTP6536DP	45 [S]	3.4	\$ 447	\$ 505
65"H x 42"W	HENTP6542DP	52 [S]	3.9	\$ 478	\$ 543
65"H x 48"W	HENTP6548DP	56 [S]	4.5	\$ 495	\$ 568
65"H x 60"W	HENTP6560DP	69	5.6	\$ 515	\$ 599
65"H x 72"W	HENTP6572DP	85	6.8	\$ 730	\$ 822

How to specify	1st Option	2nd Option	3rd Option
Select Model Number from above H E N T P 5 0 2 4 D P .	Select Fabric See pages 350-351 G N 6 5 .	Select Trim Color See page 349 Core Paint Choice (no upcharge) Choice/Metallic Paint (\$30 upcharge) S .	Select Glass Q Clear Glass R Frosted Glass (\$30 upcharge) Q

Accelerate® Panel Door







GSA SIN 711-1

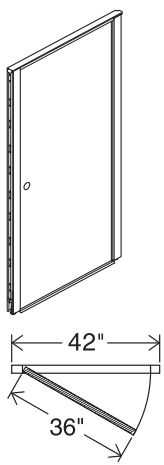
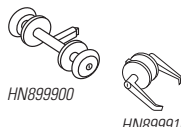

- ▶ Order handle separately. See handle model options below.
- ▶ Door is non-handed.
- ▶ Door measures 36"W, opening needed for door is 42"W.
- ▶ Specify top caps separately when ordering the laminate panel door; see page 363.
- ▶ Order connecting hardware separately; see page 366.
- ▶ Order Accelerate® connectors separately; see page 366.
- ▶ Fabrics and finishes available on pages 349-351.
- ▶ The Sliding Doors are available in 50", 65", and 80"H models and can mount to 30", 36", 42", and 48"W panels.
- ▶ All doors are 42" wide, provide a 36"W opening, and are non-handed.
- ▶ For information regarding the use of tackable and non-tackable panels in the same application, see page 355.

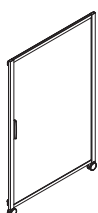
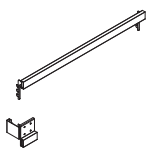
- ⚠ **Must be used with a base panel and stacker equaling 80"H.**
- ⚠ **A Mounting Bracket Kit must be ordered for each sliding door corresponding to the mounting panels width (30", 36", 42", or 48"W).**



Description	Model	Ship Weight	Cube	List by Paint Grade	
				Core	Metallics
 <p>Door Panel — Laminate 42"W x 80"H</p> <p>NOTES: Ships with door, frame, hinges and hardware.</p>	HEPDMK42P	155.0	7.3	\$1699	\$1729
 <p>Standard Lock Set Door knob (polished brass) Door lever (brushed aluminum)</p> <p>NOTES: Door knob and lever are both keyed on one side.</p>	HN899900 HN899910	2.0  0.1	0.1	\$ 106	\$ 296
 <p>Abound® and Accelerate® Sliding Door 50"H x 42"W 65"H x 42"W 80"H x 42"W</p> <p>⚠ Door is only available in Frosted Translucent. Specify paint for frame. ⚠ Can only install Sliding Door at the end of a run, not at a corner.</p>	HH15042SD HH16542SD HH18042SD	28.0 5.5 38.0 7.1 46.0 8.6		\$1858 \$2120 \$2593	\$1894 \$2156 \$2629
 <p>Accelerate® Mounting Kit for Sliding Door For 30"W panel For 36"W panel For 42"W panel For 48"W panel</p> <p>NOTES: Specify paint.</p>	HESDMK30 HESDMK36 HESDMK42 HESDMK48	4.0 0.4 5.0 0.5 6.0 0.5 7.0 0.5		\$ 149 \$ 157 \$ 164 \$ 171	\$ 161 \$ 169 \$ 176 \$ 183
 <p>Carpet Grippers</p> <p>NOTES: Used with Glide Towers Shipped 12 per package No need to specify paint</p>	HICG12	0.5  0.1		\$ 17	
 <p>Coat Hooks Package of six</p> <p>NOTES: Compatible with Accelerate® and Abound® panels. ⚠ Black only.</p>	HHPMC6	1.0  0.2		\$ 79	

How to specify	1st Option	2nd Option
<p>Select Model Number from above</p> <p>H E P D M K 4 2 P .</p>	<p>Select Trim Color</p> <p>See page 349</p> <p>T 4 .</p>	<p>Select Door Laminate</p> <p>L2 Laminate Upcharge \$60</p> <p>See page 349</p> <p>H </p>

- ▶ Models below are specified for panel models on pages 358-361.
- ▶ Top caps ship separately from panels.
- ▶ Top caps are able to span multiple panels for a clean aesthetic.
- ▶ Top caps are bulk packed for ease at installation sites.



Description	Model	Ship Weight	Cube	List by Paint Grade
				Core/Choice/Metallic
 Panel Top Cap				
20"W	HETC20	1.5	0.3	\$ 31
24"W	HETC24	1.6	0.3	\$ 31
30"W	HETC30	1.8	0.3	\$ 37
36"W	HETC36	2.0	0.3	\$ 48
42"W	HETC42	2.2	0.3	\$ 51
48"W	HETC48	3.4	0.4	\$ 58
60"W	HETC60	3.9	0.6	\$ 70
66"W	HETC66	4.0	0.6	\$ 85
72"W	HETC72	5.3	0.8	\$ 89
78"W	HETC78	6.5	0.8	\$ 92
84"W	HETC84	6.7	0.9	\$ 101
90"W	HETC90	7.0	0.9	\$ 106
96"W	HETC96	7.2	0.9	\$ 112

How to specify	Select Model Number from above	1st Option
	H E T C 2 0 .	Select Paint Color See page 349 T 3

 Icon Legend on page 10

Accelerate® Stacking Panels

GSA SIN 711-1



- ▶ Stacking panels ship without top caps.
- ▶ Stacker ships with pins to connect stacker to post connector for added rigidity.
- ▶ Stacker ships with pins to connect stacker to post connector for added rigidity.
- ▶ Select complete panels with top-tier glass, or add glass/fabric stackers separately to existing panels. See page 360 for complete panels information.
- ⚠ **Not to be used freestanding.**
- ⚠ **Stackers can be stacked up to 80" H on a base panel or 30" of stacker height total, whichever comes first.**
- ⚠ **Stackers are weight bearing and can accommodate overhead storage.**
- ⚠ **Stacking model must match the width of the panel it is stacking on.**
- ⚠ **Total panel height cannot exceed 80" high. Glass stacker must be the top tier. A stacking panel cannot be placed above a glass panel or glass stacker. Frameless Glass can be installed on a fabric stacker.**

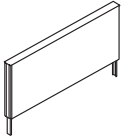

Description	Model	Ship Weight	Cube	Core List Price by Code	
				A	B
 15"H Stacking Panels — Fabric 15"H x 20"W 15"H x 24"W 15"H x 30"W 15"H x 36"W 15"H x 42"W 15"H x 48"W 15"H x 60"W 15"H x 72"W	HES1520F	6	0.5	\$ 182	\$ 230
	HES1524F	7	0.6	\$ 198	\$ 246
	HES1530F	8	0.8	\$ 213	\$ 264
	HES1536F	9	0.9	\$ 230	\$ 288
	HES1542F	11	1.1	\$ 248	\$ 313
	HES1548F	12	1.2	\$ 263	\$ 336
	HES1560F	14	1.5	\$ 297	\$ 381
	HES1572F	17	1.8	\$ 542	\$ 634

How to specify	Select Model Number from above H E S 1 5 2 0 F .	1st Option Select Fabric Color See page 350-351 A P N 1 1
----------------	--	---

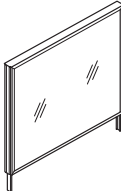
Description	Model	Ship Weight	Cube	Clear		Frosted	
				Clear	Frosted	Clear	Frosted
 30"H Stacking Panels — Glass 30"H x 20"W 30"H x 24"W 30"H x 30"W 30"H x 36"W 30"H x 42"W 30"H x 48"W 30"H x 60"W	HES3020G	14	1.0	\$ 528	\$ 558	\$ 528	\$ 558
	HES3024G	17	1.2	\$ 555	\$ 585	\$ 555	\$ 585
	HES3030G	20	1.5	\$ 630	\$ 660	\$ 630	\$ 660
	HES3036G	23	1.8	\$ 650	\$ 680	\$ 650	\$ 680
	HES3042G	26	2.1	\$ 720	\$ 750	\$ 720	\$ 750
	HES3048G	29	2.4	\$ 776	\$ 806	\$ 776	\$ 806
	HES3060G	36	3.0	\$ 889	\$ 919	\$ 889	\$ 919

NOTES: 30"H stacker ships with pins to connect stacker to post connector for added rigidity.

 15"H Stacking Panels — Glass 15"H x 20"W 15"H x 24"W 15"H x 30"W 15"H x 36"W 15"H x 42"W 15"H x 48"W 15"H x 60"W 15"H x 72"W	HES1520G	8	0.5	\$ 352	\$ 382
	HES1524G	9	0.6	\$ 371	\$ 401
	HES1530G	11	0.8	\$ 420	\$ 450
	HES1536G	12	0.9	\$ 434	\$ 464
	HES1542G	14	1.1	\$ 480	\$ 510
	HES1548G	16	1.2	\$ 517	\$ 547
	HES1560G	19	1.5	\$ 592	\$ 622
	HES1572G	22	1.8	\$ 721	\$ 751

How to specify	Select Model Number from above H E S 3 0 2 0 G .	1st Option Select Paint Color See page 349 Core Paint Choice (no upcharge) Choice/Metallic Paint (\$30 upcharge) T 1 .	2nd Option Select Glass Q Glass R Frosted Glass Q
----------------	--	--	--

Icon Legend on page 10

⚠ **Frameless Glass can only be used on the tallest panel of the typical.**











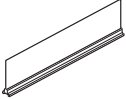







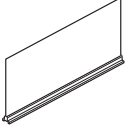

⚠ **Frameless Glass comes with a panel top cap. Do not order a separate top cap model for your panel frame when using Frameless Glass.**

- Glass is a single-pane, 3/8" laminated safety glass.
- Available in clear or frosted glass.
- Frameless Glass can span multiple panels with one piece of glass.

☑ Glass tiles have a Class A fire rating.
 ⚠ **Frameless Glass cannot be used on top of glass stackers or headers.**

⚠ **Frameless Glass can only be used on the top of panels. Glass integrates into top cap trim.**
 ⚠ **Cannot hang or stack on top of Frameless Glass.**



	Description	Model	Ship Weight	Cube	Clear Glass	Frosted Glass
	7 1/2" H Frameless Glass					
	7 1/2" H x 20" W	HEFG0720 	17	0.4	\$ 276	\$ 306
	7 1/2" H x 24" W	HEFG0724 	18	0.5	\$ 326	\$ 363
	7 1/2" H x 30" W	HEFG0730 	18	0.5	\$ 352	\$ 393
	7 1/2" H x 36" W	HEFG0736 	21	0.6	\$ 403	\$ 450
	7 1/2" H x 42" W	HEFG0742 	25	0.7	\$ 431	\$ 481
	7 1/2" H x 48" W	HEFG0748 	28	0.8	\$ 464	\$ 518
	7 1/2" H x 54" W	HEFG0754 	28	0.8	\$ 523	\$ 584
	7 1/2" H x 60" W	HEFG0760 	35	1.0	\$ 567	\$ 633
	7 1/2" H x 66" W	HEFG0766 	35	1.0	\$ 634	\$ 706
	7 1/2" H x 72" W	HEFG0772 	42	1.9	\$ 671	\$ 749
	15" H Frameless Glass					
	15" H x 20" W	HEFG1520 	27	1.3	\$ 342	\$ 372
	15" H x 24" W	HEFG1524 	28	1.5	\$ 370	\$ 407
	15" H x 30" W	HEFG1530 	28	1.5	\$ 396	\$ 437
	15" H x 36" W	HEFG1536 	34	1.8	\$ 455	\$ 502
	15" H x 42" W	HEFG1542 	39	2.0	\$ 489	\$ 539
	15" H x 48" W	HEFG1548 	45	2.3	\$ 528	\$ 582
	15" H x 54" W	HEFG1554 	51	2.6	\$ 577	\$ 638
	15" H x 60" W	HEFG1560 	57	2.8	\$ 703	\$ 769
	15" H x 66" W	HEFG1566 	62	3.2	\$ 644	\$ 716
	15" H x 72" W	HEFG1572 	67	3.5	\$ 759	\$ 837

How to specify	1st Option	2nd Option
<p>Select Model Number from above</p> <p>H E F G 1 5 2 0 .</p>	<p>Select Paint Color</p> <p>See page 349</p> <p>Core Paint Choice (no upcharge)</p> <p>Choice/Metallic Paint (\$17 upcharge)</p> <p>T 1 .</p>	<p>Select Glass Option</p> <p>Q Clear</p> <p>R Frosted</p> <p>Q </p>

    Icon Legend on page 10

- ▶ Specify connectors based on number and placement of panels.
- ▶ Connectors ship complete with all hardware necessary to complete connection.
- ▶ Specify connector to fit height of tallest panel.
- ▶ Connectors are made of extruded aluminum.
- ▶ Straight Connector model HSCKTPTS ships standard in bulk pack.
- ▶ All connectors (except 120° models) are adaptable with power pole for ceiling in feeds; see page 390.
- ⚠ **In-line connector must be specified for all in-line connections.**



	Description	Model	Ship Weight	Cube	List by Paint Grade	
					Core	Metallics
	120° 2-way Connector					
	For 35"H Panels	HEC35P2	6.0	0.4	\$ 94	\$ 103
	For 42½"H Panels	HEC42P2	6.0	0.5	\$ 108	\$ 117
	For 50"H Panels	HEC50P2	7.0	0.6	\$ 125	\$ 134
	For 57½"H Panels	HEC57P2	8.0	0.6	\$ 133	\$ 142
	For 65"H Panels	HEC65P2	8.0	0.7	\$ 138	\$ 147
	For 72½"H Panels	HEC72P2	9.0	0.8	\$ 144	\$ 153
	For 80"H Panels	HEC80P2	9.0	0.9	\$ 151	\$ 160
	120° 3-way Connector					
	For 35"H Panels	HEC35P3	6.0	0.4	\$ 94	\$ 103
	For 42½"H Panels	HEC42P3	6.0	0.5	\$ 108	\$ 117
	For 50"H Panels	HEC50P3	7.0	0.6	\$ 125	\$ 134
	For 57½"H Panels	HEC57P3	8.0	0.6	\$ 133	\$ 142
	For 65"H Panels	HEC65P3	8.0	0.7	\$ 138	\$ 147
	For 72½"H Panels	HEC72P3	9.0	0.8	\$ 144	\$ 153
	For 80"H Panels	HEC80P3	9.0	0.9	\$ 151	\$ 160
	In-line Connector	HSCKTPTS	0.5	0.1	\$ 15	N/A
	NOTES: No need to specify. SPECIFYING EXAMPLE: HSCKTPTS.X					
	Extended Straight Connector					
	For 35"H Panels	HEC35PS	6.0	0.4	\$ 94	\$ 103
	For 42½"H Panels	HEC42PS	6.0	0.5	\$ 108	\$ 117
	For 50"H Panels	HEC50PS	7.0	0.6	\$ 125	\$ 134
	For 57"H Panels	HEC57PS	8.0	0.6	\$ 133	\$ 142
	For 65"H Panels	HEC65PS	8.0	0.7	\$ 138	\$ 147
	For 72½"H Panels	HEC72PS	9.0	0.8	\$ 146	\$ 155
	For 80"H Panels	HEC80PS	9.0	0.9	\$ 151	\$ 160
	"L" Connector					
	For 35"H Panels	HEC35PL	6.0	0.4	\$ 94	\$ 103
	For 42½"H Panels	HEC42PL	6.0	0.5	\$ 108	\$ 117
	For 50"H Panels	HEC50PL	7.0	0.6	\$ 125	\$ 134
	For 57"H Panels	HEC57PL	8.0	0.6	\$ 133	\$ 142
	For 65"H Panels	HEC65PL	8.0	0.7	\$ 138	\$ 147
	For 72½"H Panels	HEC72PL	9.0	0.8	\$ 146	\$ 155
	For 80"H Panels	HEC80PL	9.0	0.9	\$ 151	\$ 160
	"T" Connector					
	For 35"H Panels	HEC35PT	6.0	0.4	\$ 94	\$ 103
	For 42½"H Panels	HEC42PT	6.0	0.5	\$ 108	\$ 117
	For 50"H Panels	HEC50PT	7.0	0.6	\$ 125	\$ 134
	For 57"H Panels	HEC57PT	8.0	0.6	\$ 133	\$ 142
	For 65"H Panels	HEC65PT	8.0	0.7	\$ 138	\$ 147
	For 72½"H Panels	HEC72PT	9.0	0.8	\$ 146	\$ 155
	For 80"H Panels	HEC80PT	9.0	0.9	\$ 151	\$ 160
	"X" Connector					
	For 35"H Panels	HEC35PX	6.0	0.4	\$ 94	\$ 103
	For 42½"H Panels	HEC42PX	6.0	0.5	\$ 108	\$ 117
	For 50"H Panels	HEC50PX	7.0	0.6	\$ 125	\$ 134
	For 57"H Panels	HEC57PX	8.0	0.6	\$ 133	\$ 142
	For 65"H Panels	HEC65PX	8.0	0.7	\$ 138	\$ 147
	For 72½"H Panels	HEC72PX	9.0	0.8	\$ 146	\$ 155
	For 80"H Panels	HEC80PX	9.0	0.9	\$ 151	\$ 160

How to specify	Select Model Number from above H E C 3 5 P 2 .	1st Option Select Paint Color See page 349 T 3
----------------	--	--

Icon Legend on page 10

- ▶ In-line Variable Height Finishing Kit is used to connect a finished in-line panel connection.
- ▶ Variable height finishing kit is used at a drop in height an L, T, X, or S connection.
- ▶ All kits come with all hardware needed to install the kit.
- ⚠ Variable height kit needs to be specified any time a change of panel height occurs.
- ⚠ Finished end covers must be specified at all end of panel runs.



Description	Model	Ship Weight	Cube	List by Paint Grade	
				Core	Metallics
 <p>Finished End Covers 35"H 42½"H 50"H 57½"H 65"H 72½"H 80"H</p>	HEFEC35P	3	0.4	\$ 42	\$ 51
	HEFEC42P	3	0.5	\$ 45	\$ 54
	HEFEC50P	4	0.6	\$ 48	\$ 57
	HEFEC57P	5	0.6	\$ 51	\$ 60
	HEFEC65P	5	0.7	\$ 55	\$ 64
	HEFEC72P	6	0.8	\$ 59	\$ 68
	HEFEC80P	6	0.9	\$ 62	\$ 71

NOTES: Finished End Covers include top bracket, end trim clips and end trim.

 <p>In-line Variable Height Finishing Kit 7½"H 15"H 22½"H 30"H</p>	HEVHF07P	2	0.2	\$ 44	\$ 53
	HEVHF15P	2	0.4	\$ 47	\$ 56
	HEVHF22P	3	0.4	\$ 57	\$ 66
	HEVHF30P	3	0.4	\$ 67	\$ 76

NOTES: In-line Variable Height Finishing Kits include top and bottom bracket, end trim clips and end trim. In-line Variable Height Finishing Kit is used to connect a finished in-line panel connection.

 <p>Connector Variable Height Finishing Kit 7½"H 15"H 22½"H 30"H</p>	HECVH07P	2	0.2	\$ 44	\$ 53
	HECVH15P	2	0.4	\$ 47	\$ 56
	HECVH22P	3	0.4	\$ 57	\$ 66
	HECVH30P	3	0.4	\$ 67	\$ 76

NOTES: Connector Variable Height Finishing Kits include top and bottom bracket, end trim and end trim connection piece.

 <p>Wall Starter Kit 35"H 42½"H 50"H 57½"H 65"H 72½"H 80"H</p>	HEWS35P	4	0.4	\$ 72	\$ 81
	HEWS42P	4	0.5	\$ 77	\$ 86
	HEWS50P	5	0.6	\$ 81	\$ 90
	HEWS57P	6	0.6	\$ 86	\$ 95
	HEWS65P	6	0.7	\$ 92	\$ 101
	HEWS72P	7	0.8	\$ 99	\$ 108
	HEWS80P	7	0.9	\$ 104	\$ 113

 <p>Permanent Wall Hanger Kit 2½"W x 7/8"D x 66"H 4¼"W x 7/8"D x 66"H</p>	HRVC35PCE	6	0.7	\$ 197	\$ 217
	HRVC35PCM	3	0.7	\$ 102	\$ 112

⚠ Anchor devices are not supplied with this model. Refer to Abound® Installation instructions for appropriate hardware. Attachment to masonry walls is not recommended.

Specify paint

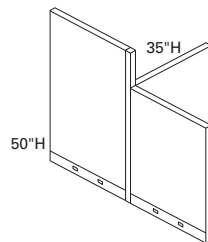

T-Connection
Connector, Variable Height Finishing Kit

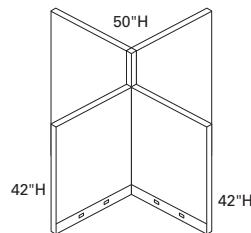

X-Connection
Connector, Variable Height Finishing Kit

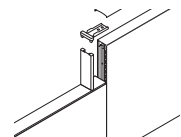

In-line Variable Height Trim Kit

How to specify	1st Option
Select Model Number from above H E F E C 3 5 P .	Select Paint Color See page 349 T 3

Icon Legend on page 10

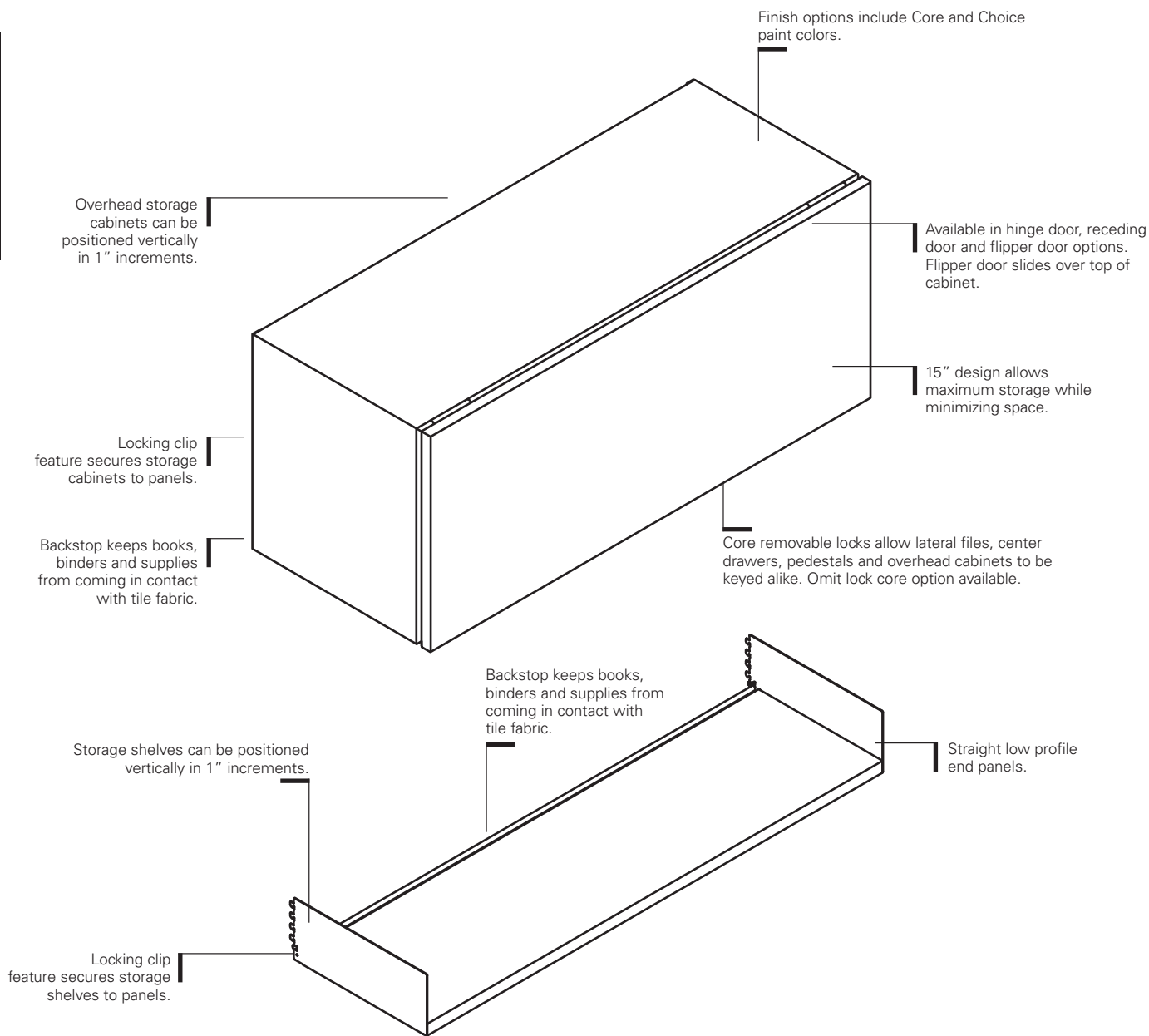

Product dimensions

Overhead Storage Cabinet

Width 24", 30", 36", 42", 48", 60"

Inside width Flipper and Receding door — $\frac{3}{8}$ " less than width
Hinged door — $\frac{1}{4}$ " less than width

Depth $14\frac{7}{8}$ "

Inside depth $12\frac{7}{8}$ "

Height 15"

Inside height $12\frac{3}{4}$ "

Open Shelf

Width 24", 30", 36", 42", 48", 60"

Depth $14\frac{3}{8}$ "

Height $5\frac{5}{8}$ "

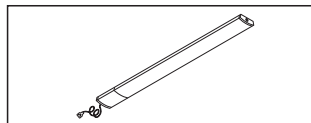

Task lights can be mounted beneath storage shelves and overhead storage cabinets.

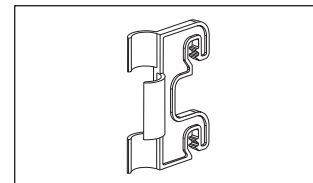

Cord retainer clips fasten into panel slots to anchor power cords. Available in black only. Clips are provided with undershelf mounted task lights.

Specification Guidelines

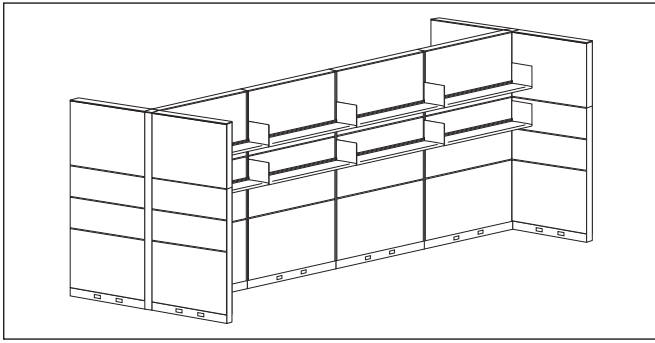

In a panel run, only two overhead storage cabinets or open storage shelves are recommended per panel side. When suspending overhead storage off-module only one storage unit per panel side is allowed.

When overhead storage units are suspended from stacking frames, the following guidelines should be adhered to:

Stacking frames should be added to all the parent run panels, and to each return-panel run. Stacking panels added to return panel must match the parent run configuration.

A maximum of two overhead storage units should be suspended from each side of stacking frames on any given panel.

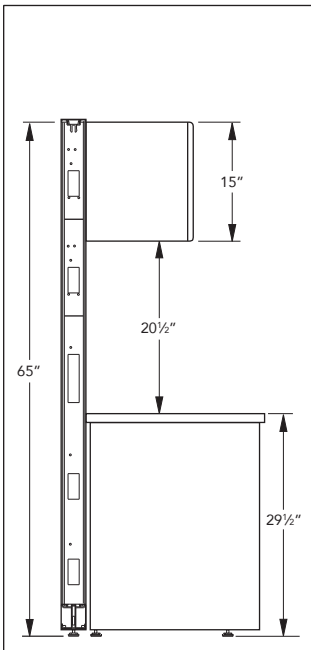

Overhead Storage cabinets and the **Open Shelf** can also be mounted to a maximum height of 65"H on Abound frames.

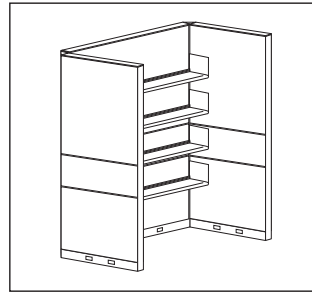

No limitation to the number of units on structural frames when units are spaced 12" apart and when the run is supported with return panels on each side of storage shelves or overhead storage cabinets.

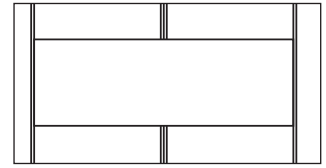

Storage shelf and overhead width must correspond with width of panel(s). It is possible to span two panels when combined panel width equals cabinet or shelf width.

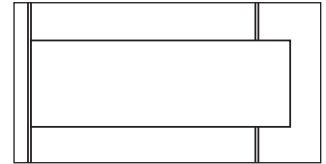

About Overhead Cabinets can be mounted on a panel equal to or up to 18" narrower than cabinet.

Only applies to Overhead models.

Systems Overhead and Shelves

GSA SIN 711-1

HON

- ▶ Overhead Storage Cabinets with doors are standard with a factory installed core removable lock located on the underside of the cabinet.
- ▶ All units feature an anti-dislodgement device.
- ▶ 60" and 72"W units are one piece cabinet with two doors.

- ▶ Abound overheads have the ability to hang on either side of the frame.
- ▶ Omit lock option.
- ▶ Upmount kits can be used with all Abound overheads.

▶ **Abound Overheads attach with off-modular brackets allowing the overhead to be used with the Accelerate® panel system. See pages 368-369 for overhead specifying.**

▶ **Keyed alike cores must be ordered separately — see page 743.**

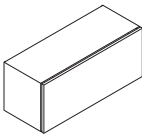
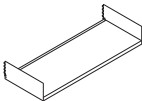
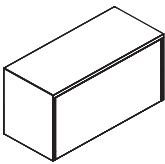

Description	Model	Ship Weight	Cube	List by Paint Grade	
				Core	Metallics
 <p>Metal Flipper Door Overheads 24"W x 14³/₈"D x 15"H 30"W x 14³/₈"D x 15"H 36"W x 14³/₈"D x 15"H 42"W x 14³/₈"D x 15"H 48"W x 14³/₈"D x 15"H 60"W x 14³/₈"D x 15"H 72"W x 14³/₈"D x 15"H</p>	HRVOH24FM	35	3.6	\$ 493	\$ 542
	HRVOH30FM	38	4.4	\$ 501	\$ 550
	HRVOH36FM	41	5.3	\$ 525	\$ 574
	HRVOH42FM	46	6.1	\$ 551	\$ 600
	HRVOH48FM	52	6.9	\$ 574	\$ 623
	HRVOH60FM	62	8.6	\$ 759	\$ 808
	HRVOH72FM	82	10.6	\$ 870	\$ 919
 <p>Open Shelf 24"W x 14³/₈"D x 5⁵/₈"H 30"W x 14³/₈"D x 5⁵/₈"H 36"W x 14³/₈"D x 5⁵/₈"H 42"W x 14³/₈"D x 5⁵/₈"H 48"W x 14³/₈"D x 5⁵/₈"H 60"W x 14³/₈"D x 5⁵/₈"H 72"W x 14³/₈"D x 5⁵/₈"H</p>	HRVSH24	13 <input type="checkbox"/>	1.2	\$ 211	\$ 228
	HRVSH30	15 <input type="checkbox"/>	1.5	\$ 229	\$ 246
	HRVSH36	16 <input type="checkbox"/>	1.8	\$ 244	\$ 261
	HRVSH42	17 <input type="checkbox"/>	1.9	\$ 252	\$ 269
	HRVSH48	18 <input type="checkbox"/>	2.3	\$ 264	\$ 281
	HRVSH60	20	2.9	\$ 323	\$ 340
	HRVSH72	32	3.6	\$ 424	\$ 441
 <p>Receding Door Overhead 30"W x 13³/₈"D x 15"H 36"W x 13³/₈"D x 15"H 42"W x 13³/₈"D x 15"H 48"W x 13³/₈"D x 15"H 60"W x 13³/₈"D x 15"H</p>	HRVOH1530RM	38	5.7	\$ 637	\$ 690
	HRVOH1536RM	41	6.8	\$ 671	\$ 724
	HRVOH1542RM	46	7.8	\$ 714	\$ 767
	HRVOH1548RM	52	8.9	\$ 773	\$ 826
	HRVOH1560RM	62	11.2	\$1172	\$1225

How to specify	1st Option	2nd Option
<p>Select Model Number from above</p> <p>H R V O H 2 4 F M .</p>	<p>Select Paint Color</p> <p>See page 349</p> <p>T 4 .</p>	<p>Select Lock Option</p> <p>L Lock X Omit Lock (deduct \$20) (where applicable)</p> <p>See page 743</p> <p>L </p>

- ▶ Brushed aluminum finish around low-glare porcelain coated steel magnetic writing surface.
- ▶ Brushed aluminum marker tray attaches to frame.
- ▶ Width of markerboard must correspond to the width of the panel.
- ▶ Markerboards will attach to the Abound and Accelerate® frame with brackets provided.
- ▶ Able to use multiple markerboards next to each other and multiple boards per panel.

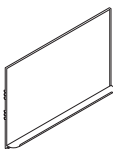

Description	Model	Ship		
		Weight	Cube	List
 <p>Markerboards 36"W x 24"H 42"W x 24"H 48"W x 24"H</p>	HHMRK36	15 <input type="checkbox"/>	3.2	\$ 468
	HHMRK42	17 <input type="checkbox"/>	4.0	\$ 508
	HHMRK48	19 <input type="checkbox"/>	4.6	\$ 547

How to specify
<p>Select Model Number from above</p> <p>H H M R K 3 6 </p>

- ▶ Works with both Abound® and Accelerate® panel systems.
- ▶ Specify fabric, see pages 310-311 for fabric options.
- ▶ **No color specification required.**



Description	Model	Ship		
		Weight	Cube	List
 <p>Tackboard 20"W x 18"¹⁸H 24"W x 18"¹⁸H 30"W x 18"¹⁸H 36"W x 18"¹⁸H 42"W x 18"¹⁸H 48"W x 18"¹⁸H 60"W x 18"¹⁸H 72"W x 18"¹⁸H</p>	HETB2018	2	0.5	\$ 92
	HETB2418	3	0.6	\$ 113
	HETB3018	3	0.7	\$ 133
	HETB3618	8	0.9	\$ 150
	HETB4218	10	1.0	\$ 168
	HETB4818	12	1.2	\$ 185
	HETB6018	13	1.5	\$ 206
HETB7218	15	1.8	\$ 226	

SPECIFYING EXAMPLE: HETB2018.APN15



- ▶ Storage Cabinets with doors are standard with a factory installed core removable lock located on the underside of the cabinet.
- ▶ All units feature an anti-dislodgement device.
- ▶ Accepts under cabinet lighting.
- ▶ ETA overheads and shelves ship flat packed.
- ▶ Only one installer is needed to assemble an ETA overhead on a panel (all sizes).
- ▶ Attachment brackets are attached to the back of the unit (included).
- ▶ ETA overheads and shelves are slightly less deep than built-up models. Please note when using next to built-up models.
- ▶ Order overhead and shelf to match the width of panel being used.
- ▶ **Keyed alike cores must be ordered separately — see page 743.**
- ▶ **Cannot be used in off-modular applications because attachment bracket is attached to the back of the case and cannot be moved.**

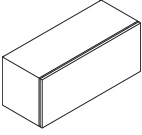
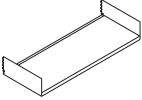

Description	Model	Ship Weight	Cube	List by Paint Grade	
				Core	Choice/Metallics
 <p>Flipper Door Overheads 24"W x 13"D x 15"H 30"W x 13"D x 15"H 36"W x 13"D x 15"H 42"W x 13"D x 15"H 48"W x 13"D x 15"H 60"W x 13"D x 15"H 72"W x 13"D x 15"H</p>	HEOHRTA1524FD E⬢A	21 [S]	1.6	\$ 381	\$ 430
	HEOHRTA1530FD E⬢A	24 [S]	1.6	\$ 388	\$ 437
	HEOHRTA1536FD E⬢A	27 [S]	1.6	\$ 406	\$ 455
	HEOHRTA1542FD E⬢A	30 [S]	1.8	\$ 426	\$ 475
	HEOHRTA1548FD E⬢A	33 [S]	2.1	\$ 444	\$ 493
	HEOHRTA1560FD E⬢A	42 [S]	2.5	\$ 587	\$ 636
	HEOHRTA1572FD E⬢A	49 [S]	3.0	\$ 730	\$ 779
 <p>Open Shelves 24"W x 13"D x 5 5/8"H 30"W x 13"D x 5 5/8"H 36"W x 13"D x 5 5/8"H 42"W x 13"D x 5 5/8"H 48"W x 13"D x 5 5/8"H 60"W x 13"D x 5 5/8"H 72"W x 13"D x 5 5/8"H</p>	HESHRTA24 E⬢A	10 [S]	1.9	\$ 177	\$ 194
	HESHRTA30 E⬢A	11 [S]	1.9	\$ 191	\$ 208
	HESHRTA36 E⬢A	12 [S]	1.9	\$ 204	\$ 221
	HESHRTA42 E⬢A	13 [S]	2.1	\$ 211	\$ 228
	HESHRTA48 E⬢A	14 [S]	2.4	\$ 222	\$ 239
	HESHRTA60 E⬢A	16 [S]	3.0	\$ 271	\$ 288
	HESHRTA72 E⬢A	18 [S]	3.5	\$ 320	\$ 337

How to specify

<p>Select Model Number from above</p> <p>H E O H R T A 1 5 2 4 F D . T 1 </p>	<p>1st Option</p> <p>Select Paint Color</p> <p>See page 349</p>
---	---

- ▶ Works with both Abound® and Accelerate®.
- ▶ Specify fabric, see pages 350-351 for fabric options.



Description	Model	Ship		
		Weight	Cube	List
 18"H <p>Tackboard 20"W x 18"H 24"W x 18"H 30"W x 18"H 36"W x 18"H 42"W x 18"H 48"W x 18"H 60"W x 18"H 72"W x 18"H</p>	HETB2018	2	0.5	\$ 92
	HETB2418	3	0.6	\$ 113
	HETB3018	3	0.7	\$ 133
	HETB3618	8	0.9	\$ 150
	HETB4218	10	1.0	\$ 168
	HETB4818	12	1.2	\$ 185
	HETB6018	13	1.5	\$ 206
	HETB7218	15	1.8	\$ 226

SPECIFYING EXAMPLE: HETB2018.APN15

How to specify

<p>Select Model Number from above</p> <p>H E T B 2 0 1 8 . A P N 1 5 </p>	<p>1st Option</p> <p>Select Fabric Color</p>
---	--

Icon Legend on page 10

Systems Overhead Storage

GSA SIN 711-1



- ▶ Overhead Storage Cabinets with doors are standard with a factory installed core removable lock located on the underside of the cabinet.
- ▶ Abund overheads have the ability to hang on either side of the frame.
- ▶ Omit lock option.
- ▶ Upmount kits can be used with all Abund overheads.
- ▶ **Abund Overheads attach with off-modular brackets allowing the overhead to be used with the Accelerate® panel system. See pages 368-369 for overhead specifying.**
- ▶ **Keyed alike cores must be ordered separately — see page 743.**

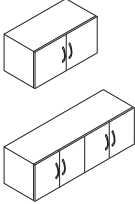

Description	Model	Ship Weight	Cube	List by Paint Grade	
				Core	Metallics
 <p>Steel Front Hinged Door Overhead with Arch Pull 24"W x 15"D x 15"H 30"W x 15"D x 15"H 36"W x 15"D x 15"H 42"W x 15"D x 15"H 48"W x 15"D x 15"H</p>	HRVOHV24HMA	32	5.6	\$ 665	\$ 714
	HRVOHV30HMA	36	6.8	\$ 688	\$ 737
	HRVOHV36HMA	42	7.7	\$ 713	\$ 762
	HRVOHV42HMA	52	8.1	\$ 737	\$ 786
	HRVOHV48HMA	56	9.2	\$ 763	\$ 812
	<p>Open Storage Cabinet 24"W x 15"D x 15"H 30"W x 15"D x 15"H 36"W x 15"D x 15"H 42"W x 15"D x 15"H 48"W x 15"D x 15"H</p>				
<p>Abund®/Accelerate® Horizontal Wall Track for Overhead Storage 60"W HTWTH 5 0.8 \$ 72 N/A</p> <p>NOTES: Use when mounting overhead storage and when a permanent wall hanger kit is not desired. For 72"W overheads, use two wall tracks cut to 36". ▲ Cannot be used with ETA storage or Voi®. Can only be used with systems flipper door and hinged door overheads.</p>					

How to specify	1st Option	2nd Option
<p>Select Model Number from above</p> <p>Select the Pull</p> <p>A Satin Chrome Arch</p> <p>H R V O H V 2 4 H M A .</p>	<p>Select Lock Option</p> <p>L Lock X Omit Lock (deduct \$20) (where applicable) See page 743</p> <p>L .</p>	<p>Select Paint Color</p> <p>See page 349</p> <p>T 4 </p>

Systems Laminate Front Overhead Storage

GSA SIN 711-1

- ▶ Laminate fronts are available in L1 woodgrain only.
- ▶ Overhead Storage Cabinets with doors are standard with a factory installed core removable lock located on the underside of the cabinet.
- ▶ Abund overheads have the ability to hang on either side of the frame.
- ▶ Omit lock option.
- ▶ Upmount kits can be used with all Abund overheads.
- ▶ **Abund Overheads attach with off-modular brackets allowing the overhead to be used with the Accelerate® panel system. See pages 368-369 for overhead specifying.**
- ▶ **Keyed alike cores must be ordered separately — see page 743.**

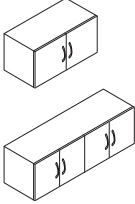

Description	Model	Ship Weight	Cube	List by Paint Grade										
				Core	Metallics									
 <p>Laminate Front Hinged Door Overheads with Arch Pull 24"W x 15"D x 15"H 30"W x 15"D x 15"H 36"W x 15"D x 15"H 42"W x 15"D x 15"H 48"W x 15"D x 15"H</p>	HRVOHV24HLA	35	5.6	\$ 818	\$ 867									
	HRVOHV30HLA	40	6.8	\$ 843	\$ 892									
	HRVOHV36HLA	48	7.7	\$ 867	\$ 916									
	HRVOHV42HLA	53	8.1	\$ 891	\$ 940									
	HRVOHV48HLA	64	9.2	\$ 915	\$ 964									
	<p>How to specify</p> <table border="1"> <thead> <tr> <th>1st Option</th> <th>2nd Option</th> <th>3rd Option</th> </tr> </thead> <tbody> <tr> <td> <p>Select Model Number from above</p> <p>Select the Pull</p> <p>A Satin Chrome Arch</p> <p>H R V O H V 2 4 H L A .</p> </td> <td> <p>Select Lock Option</p> <p>L Lock X Omit Lock (deduct \$20) See page 743</p> <p>L .</p> </td> <td> <p>Select Front Laminate Color</p> <p>L1 Woodgrain only. See page 309</p> <p>H .</p> </td> </tr> <tr> <td colspan="3"> <p>Select Case Paint Color</p> <p>See page 309</p> <p>T 4 </p> </td> </tr> </tbody> </table>						1st Option	2nd Option	3rd Option	<p>Select Model Number from above</p> <p>Select the Pull</p> <p>A Satin Chrome Arch</p> <p>H R V O H V 2 4 H L A .</p>	<p>Select Lock Option</p> <p>L Lock X Omit Lock (deduct \$20) See page 743</p> <p>L .</p>	<p>Select Front Laminate Color</p> <p>L1 Woodgrain only. See page 309</p> <p>H .</p>	<p>Select Case Paint Color</p> <p>See page 309</p> <p>T 4 </p>	
1st Option	2nd Option	3rd Option												
<p>Select Model Number from above</p> <p>Select the Pull</p> <p>A Satin Chrome Arch</p> <p>H R V O H V 2 4 H L A .</p>	<p>Select Lock Option</p> <p>L Lock X Omit Lock (deduct \$20) See page 743</p> <p>L .</p>	<p>Select Front Laminate Color</p> <p>L1 Woodgrain only. See page 309</p> <p>H .</p>												
<p>Select Case Paint Color</p> <p>See page 309</p> <p>T 4 </p>														

- ▶ Voi® Overhead Storage can be used with Accelerate® and Abound® panels.
- ▶ All Overhead Cabinets shown below can be used as a wall mount, panel mount or stack-on storage with O-leg.
- ▶ Can be mounted on O-legs, panel brackets or wall mount brackets. See page 374.
- ▶ Tackboards are available for wall mount storage applications.
- ▶ Sliding Door pulls are specified and ship with all models (use is optional).
- ▶ Overhead cabinets with four doors are available in laminate or mixed materials.
- ▶ Overhead and Stack-on storage units do not lock.
- ▶ For all color specifying combinations, see matrix on page 175.
- ▶ Storage cases accept binder height items.
- ▶ Storage cube fits inside stack-on storage or overhead cabinet units to provide paper management.
- ▶ Wall mount brackets specified with unit. Brackets attach to case horizontally.
- ▶ For panel mounted applications, brackets and hardware are ordered separately, see page 416. Brackets attach to panel and case is screwed into brackets. Two brackets needed for 60" unit; three brackets needed for 66" and larger.
- ▶ If Wall Bracket option is selected, \$150 upcharge applies.

⚠ Stack-on Storage must be placed over two full-height supports. Cannot be placed over non-supported sections such as returns using a flat bracket or tower-to-worksurface bracket.

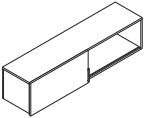

Description	Model	Ship Weight	Cube	L1 List	L2 Upcharges	
					Cabinet	Door
 <p>Overhead Cabinet with One Sliding Door</p> <p>36"W x 14 1/4"D x 14"H</p> <p>42"W x 14 1/4"D x 14"H</p> <p>48"W x 14 1/4"D x 14"H</p> <p>60"W x 14 1/4"D x 14"H</p> <p>66"W x 14 1/4"D x 14"H</p> <p>72"W x 14 1/4"D x 14"H</p> <p>78"W x 14 1/4"D x 14"H</p>	HLSL1436S	39	9.7	\$ 883	\$ 25	\$ 20
	HLSL1442S	48	9.7	\$ 926	\$ 25	\$ 20
	HLSL1448S	57	12.1	\$ 954	\$ 25	\$ 20
	HLSL1460S	69	13.3	\$1027	\$ 30	\$ 25
	HLSL1466S	83	14.6	\$1134	\$ 30	\$ 25
	HLSL1472S	95	15.9	\$1239	\$ 35	\$ 25
	HLSL1478S	105	18.5	\$1348	\$ 35	\$ 25

NOTES: Only available in laminate.

How to specify	1st Option	2nd Option	3rd Option	4th Option
<p>Select Model Number from above</p> <p>H L S L 1 4 7 8 S .</p>	<p>Select Cabinet Laminate</p> <p>See page 175</p> <p>N .</p>	<p>Select Door Laminate</p> <p>See page 175</p> <p>N .</p>	<p>Select Pull Color</p> <p>T4 Champagne <input type="checkbox"/></p> <p>T1 Platinum <input type="checkbox"/></p> <p>WHIT White <input type="checkbox"/></p> <p>X No Option</p> <p>X .</p>	<p>Specify Bracket Option</p> <p>X No Bracket</p> <p>W Wall Bracket (\$150 upcharge)</p> <p>W</p>

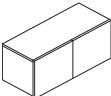
Description	Model	Ship Weight	Cube	L1 List	L2 Upcharges	
					Cabinet	Door
 <p>Overhead Cabinet with Doors</p> <p>36"W x 14 1/4"D x 14"H, 2 doors</p> <p>42"W x 14 1/4"D x 14"H, 2 doors</p> <p>48"W x 14 1/4"D x 14"H, 3 doors</p> <p>60"W x 14 1/4"D x 14"H, 4 doors</p>	HLSL1436D	39	9.7	\$ 745	\$ 25	\$ 20
	HLSL1442D	48	9.7	\$ 828	\$ 25	\$ 20
	HLSL1448D	57	12.1	\$ 920	\$ 25	\$ 30
	HLSL1460D	115	13.3	\$1027	\$ 30	N/A

⚠ 2-Door and 3-Door Overhead Cabinet with Doors models HLSL1436D – HLSL1448D available in laminate only. The 60" model HLSL1460D is available in all door finish options—see 2nd Option below.

 <p>Overhead Cabinet with 4 Doors/Cubbies</p> <p>66"W x 14 1/4"D x 14"H with 6" Cubbie</p> <p>72"W x 14 1/4"D x 14"H with 12" Cubbie</p> <p>78"W x 14 1/4"D x 14"H with 18" Cubbie</p>	HLSL1466D	126	14.6	\$1134	\$ 30	N/A
	HLSL1472D	139	15.9	\$1239	\$ 35	N/A
	HLSL1478D	153	18.5	\$1348	\$ 35	N/A

How to specify	1st Option	2nd Option	3rd Option																				
<p>Select Model Number from above</p> <p>H L S L 1 4 6 0 D .</p>	<p>Select Cabinet Laminate</p> <p>See page 175</p> <p>N .</p>	<p>Select Door Material for 2/3/4 Door Models</p> <p>Upcharges for door selection:</p> <table border="1"> <thead> <tr> <th></th> <th>2-Door</th> <th>3-Door</th> <th>4-Door</th> </tr> </thead> <tbody> <tr> <td>T4G Champagne Polymer with Frosted glass</td> <td>\$158</td> <td>\$236</td> <td>\$315</td> </tr> <tr> <td>T1G Platinum Polymer with Frosted glass</td> <td>\$158</td> <td>\$236</td> <td>\$315</td> </tr> <tr> <td>T4FT01 Champagne with Frosted Translucent Acrylic</td> <td>\$180</td> <td>\$270</td> <td>\$360</td> </tr> <tr> <td>T1FT01 Platinum with Frosted Translucent Acrylic</td> <td>\$180</td> <td>\$270</td> <td>\$360</td> </tr> </tbody> </table> <p>Also available in laminate doors. See page 175.</p> <p>Not specified for models HLSL1436D – HLSL1448D. These models are available in laminate only.</p> <p>T 4 G .</p>		2-Door	3-Door	4-Door	T4G Champagne Polymer with Frosted glass	\$158	\$236	\$315	T1G Platinum Polymer with Frosted glass	\$158	\$236	\$315	T4FT01 Champagne with Frosted Translucent Acrylic	\$180	\$270	\$360	T1FT01 Platinum with Frosted Translucent Acrylic	\$180	\$270	\$360	<p>Select Bracket Option</p> <p>X No Bracket</p> <p>W Wall Bracket (\$150 upcharge)</p> <p>X</p>
	2-Door	3-Door	4-Door																				
T4G Champagne Polymer with Frosted glass	\$158	\$236	\$315																				
T1G Platinum Polymer with Frosted glass	\$158	\$236	\$315																				
T4FT01 Champagne with Frosted Translucent Acrylic	\$180	\$270	\$360																				
T1FT01 Platinum with Frosted Translucent Acrylic	\$180	\$270	\$360																				

Voi® Overhead and Stack-on Storage

GSA SIN as Noted



- ▶ Voi® Overhead Storage can be used with Accelerate® and Abound® panels.
- ▶ Overhead and Stack-on storage units do not lock.
- ▶ Use O-Leg Support models for Overhead Cabinets.
- ▶ If Wall Bracket option is selected, \$150 upcharge applies.
- ▶ Storage cube fits inside stack-on storage or wall mount units to provide paper management.
- ▶ Storage Cubes are available in the following colors: Autumn (AUTM), Citron (CITR), Flame (FLAM), Pool (POOL) and Sisal (SISL).

⚠ **Stack-on Storage must be placed over two full-height supports. Cannot be placed over non-supported sections such as returns using a flat bracket or tower-to-worksurface bracket.**

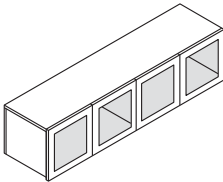

Description	Model	Ship Weight	Cube	List Price by Laminate Grade	
				L1	L2
 <p>Overhead Cabinet with 4 Frosted, Metal Frame Doors 60"W x 14 1/4"D x 14"H ⚠ Must specify an X or W for attachment bracket option below.</p>	HLSL1460M	115	11.4	\$1676	\$1706

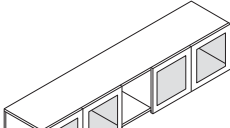

SIN 711-2

 <p>Overhead Cabinet with 4 Frosted, Metal Frame Doors 78"W x 14 1/4"D x 14"H with 18" Cubbie 72"W x 14 1/4"D x 14"H with 12" Cubbie 66"W x 14 1/4"D x 14"H with 6" Cubbie ⚠ Must specify an X or W for attachment bracket option below.</p>	HLSL1478M	153	14.7	\$1996	\$2031
	HLSL1472M	139	13.6	\$1889	\$1924
	HLSL1466M	126	12.5	\$1782	\$1812

SIN 711-2

 <p>Storage Cube 12"W x 12"D SPECIFYING EXAMPLE: HLSL1212.CITR</p>	HLSL1212	1	0.3	\$ 269	N/A
--	-----------------	---	-----	--------	-----

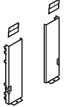
SIN 711-2

Description	Model	Ship Weight	Cube	List by Paint Grade	
				Core	Choice/Metallics
 <p>Voi® for Systems Stack-on Storage Panel Mounted Bracket Used to panel-mount stack-on storage units Specify paint NOTES: Ships with one set of three brackets, which includes one right, one center and one left bracket. When using a 60"W overhead on a 60"W panel or a 72"W overhead on a 72"W panel, only two of the three brackets provided are required. SPECIFYING EXAMPLE: HLSLPMB.T1</p>	HLSLPMB	3 	1.0	\$ 114	\$ 124

SIN 711-2

 <p>O-Leg Support for Overhead Cabinet Ships 2/pack 14 1/8"D x 20 1/2"H for 65"H Overhead Cabinet 14 1/8"D x 5 1/2"H for 50"H Overhead Cabinet</p>	HLSL650S	8	1.1	\$ 413	\$ 417
	HLSL500S	6	1.0	\$ 344	\$ 348

SIN 711-3

How to specify	1st Option	2nd Option	3rd Option
<p>Select Model Number from above</p> <p>H L S L 1 4 6 0 M . N .</p>	<p>Select Cabinet Laminate</p> <p>See page 175</p>	<p>Select Door Material</p> <p>T4G Champagne Metal Doors with Frosted Glass (no upcharge) T1G Platinum Metal Doors with Frosted Glass (no upcharge) T4FT01 Champagne Metal Doors with Frosted Translucent Acrylic (\$43 upcharge) T1FT01 Platinum Metal Doors with Frosted Translucent Acrylic (\$43 upcharge)</p> <p>T 4 G .</p>	<p>Select Bracket Option</p> <p>X No Bracket W Wall Bracket (\$150 upcharge)</p> <p>X </p>

- ▶ Overall case depth is 19"D including the sliding door.
- ▶ Use Shared Overhead and attachments in small footprint applications.

- ▶ Sliding door is 15"H, providing a 1" valance below the case which can be used as a finger pull if desired.

- ▶ Shared Overhead panel mount brackets and overhead post legs allow overhead to span over all panel systems or run down the spine wall, centered on top of the panel.

- ▶ Post legs can attach to all low credenza models and all worksurface models.
- ▶ Markerboard insert is laminate with black edges, no frame.

⚠ **Overhead units do not lock.**
 ⚠ **Shared Overhead must be ordered as left or right to determine open storage location.**



	Description	Model	Ship Weight	Cube	L1 List	L2 Upcharges	
						Cabinet	Door
	Shared Overhead Storage — Left						
	60"W x 17"D x 14"H	HLSL1760SOL	115	14.8	\$1130	\$ 20	\$ 40
	72"W x 17"D x 14"H	HLSL1772SOL	139	17.0	\$1362	\$ 25	\$ 40
	Shared Overhead Storage — Right						
	60"W x 17"D x 14"H	HLSL1760SOR	115	14.8	\$1130	\$ 20	\$ 40
	72"W x 17"D x 14"H	HLSL1772SOR	139	17.0	\$1362	\$ 25	\$ 40

	Description	Model	Ship Weight	Cube	List Price by Paint Grade	
					Core	Metallics
	Post Legs for Shared Storage					
	14"H Post Legs	HLSL140SPL	10	1.1	\$ 299	\$ 303
	22"H Post Legs	HLSL220SPL	13	3.7	\$ 331	\$ 335
NOTES: 14"H post legs on worksurfaces will span 35"H panel or shorter. 14"H post legs on low credenzas will span 30"H panel or shorter. 22"H post legs on worksurfaces will span 50"H panel or shorter. 22"H post legs on low credenzas will span 35"H panel or shorter. Specify paint. SPECIFYING EXAMPLE: HLSL140SPL.T4						

	Panel Mount Bracket for Shared Overhead					
	Panel Mount Bracket for Overhead Storage — Accelerate®	HLSLPMBSOA	4	0.1	\$ 119	\$ 123
	Panel Mount Bracket for Overhead Storage — Abound®	HLSLPMBSOB	4	0.1	\$ 119	\$ 123
	Panel Mount Bracket for Overhead Storage — Accelerate®/Abound® 42 1/2"H panels only	HLSLPMBSO42	4	0.1	\$ 111	\$ 115
NOTES: Specify paint. SPECIFYING EXAMPLE: HLSLPMBSOA.T4						

	Markerboard for Shared Storage					
	30"W x 15"D for use with 60"W Shared Overhead	HLSL1530SOMB	6	1.0	\$ 118	
	36"W x 15"D for use with 72"W Shared Overhead	HLSL1536SOMB	8	1.0	\$ 159	
NOTES: No specification necessary.						

How to specify	1st Option	2nd Option	3rd Option
Select Model Number from above H L S L 1 7 6 0 S O L . N .	Select Chassis Laminate See page 175 N .	Select Door Front Laminate See page 175 N .	Select Pull Color T4 Champagne Metallic T1 Platinum Metallic WHIT White T 4

How to specify	1st Option
Select Model Number from above H L S L 1 4 0 S P L . T 4 H L S L P M B S O I . T 4	Select Paint Color See page 175 T 4

Icon Legend on page 10



Specify paint
SIN 711-3

How to specify

Description	Model	Ship Weight	Cube	List by Paint Grade	
				Core	Metallics
Overhead Shelf Dividers Shelf Dividers — package of 6	H38SHFDV	3.0	0.2	\$ 128	\$ 139

Select Model Number from above H N C C .	1st Option Select Paint Color See page 349 T 1
--	---



Open Market

Description	Model	Ship Weight	Cube	Basic (No suffix required)	Chicago Code "CH"
Task Lights <ul style="list-style-type: none"> Slim profile design mounts recessed under storage unit and shelves with spring steel clips. T5 bulb included which contains less mercury than other types of bulbs. 9-foot black cord and switch off right rear corner. Electronic ballast for increased energy efficiency. 2 lights (HH870930) can be mounted under 60"W storage cabinets. For 24"W storage cabinets or shelves, 18 ³ / ₈ "W x 3 ¹¹ / ₁₆ "D x 1 ¹ / ₈ "H For 30"W and 36"W storage cabinets or shelves, 22 ⁷ / ₈ "W x 3 ¹¹ / ₁₆ "D x 1 ¹ / ₈ "H For 42"W and 48"W storage cabinets or shelves, 34 ⁵ / ₈ "W x 3 ¹¹ / ₁₆ "D x 1 ¹ / ₈ "H For 60"W and 72"W storage cabinets or shelves, 46 ¹ / ₂ "W x 3 ¹¹ / ₁₆ "D x 1 ¹ / ₈ "H ▲ Color: Black.					
	HH870924(?)	5.0	0.4	\$ 201	\$ 262
	HH870930(?)	7.0	0.6	\$ 205	\$ 268
	HH870942(?)	10.0	0.9	\$ 222	\$ 282
	HH870960(?)	12.0	1.1	\$ 240	\$ 300

Chicago Code Version —
Specify: Model/"CH".
EXAMPLE: HH870924CH

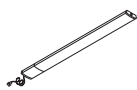

SIN 711-1

Description	Model	Ship Weight	Cube	List
LED Task Lights 17" LED Light with Power Supply (Single) 31" LED Light with Power Supply (Single)	HLED17AS HLED31AS	1.2 1.5	0.05 0.09	\$ 374 \$ 503
17" LED Light with Power Supply for Daisy-chain (Starter) 31" LED Light with Power Supply for Daisy-chain (Starter)	HLED17A HLED31A	1.0 1.4	0.05 0.09	\$ 411 \$ 553
17" LED Light with 8" Jumper Cord for Daisy-chain (Follower) 31" LED Light with 8" Jumper Cord for Daisy-chain (Follower)	HLED17AUO HLED31AUO	1.0 1.0	0.03 0.05	\$ 335 \$ 448
Undercabinet Occupancy Sensor with 1" End to End Connector	HLEDOSA	0.2	0.01	\$ 78

NOTES: To use the daisy chain application, must start with model HLED17A or HLED31A. No finish specification required. Attaches magnetically to underside of overhead storage, or attaches with provided screws or double-sided tape. Occupancy sensor attaches to a single or starter LED light and will automatically turn the light off after no motion is detected for 30 minutes. Just like all the LED light models, the occupancy sensor features a soft-touch on/off switch. LED task lights have a lifetime of 50,000 hours and have a dimmer feature that allows the user to adjust the amount of light output.

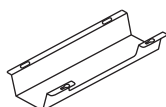

SIN 711-1

Cable Management Troughs 17"W — Single 17"W — 10-Pack 36"W — Single 36"W — 10-Pack	HCTROUGH17 HCTROUGH1710 HCTROUGH36 HCTROUGH3610	2.7 14.0 4.9 30.0	0.5 0.5 0.9 0.9	\$ 60 \$ 568 \$ 101 \$ 959
---	--	----------------------------	--------------------------	-------------------------------------

- Cable management troughs ship flat packed.
- The troughs attach to underneath the worksurface with screws.
- The 17"W has one wire access cut out on the user side. The 36" has two wire access cut outs. These cut outs give users access to inside the trough without having to detach it from the worksurface.
- Color: Graphite.
- Material: Metal.
- TAA Compliant.

► Upmount Bracket allows mounting of Overhead Cabinet up to 15" above height of panel.

► Upmount kits for Abound overheads can be used with flipper or receding door overheads. See page 370.

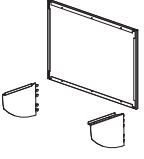

Description	Model	Ship Weight	Cube	List by Paint Grade	
				Core	Metallics
 <p>Upmount Kits for Overheads 24"W 30"W 36"W 42"W 48"W 60"W</p> <ul style="list-style-type: none"> Includes two upmount brackets, full back panel and installation hardware. Brackets require a clearance of 6 1/2" below bottom of overhead cabinet. Full back panel adds 1/2" to depth of overhead case. <p>⚠ Kit width must correspond to the width of the overhead case.</p>	<p>HRVUP24 HRVUP30 HRVUP36 HRVUP42 HRVUP48 HRVUP60</p>	<p>7.0 8.0 10.0 11.0 12.0 16.0</p>	<p>0.3 0.3 0.4 0.4 0.5 0.6</p>	<p>\$ 140 \$ 146 \$ 151 \$ 159 \$ 165 \$ 177</p>	<p>\$ 158 \$ 164 \$ 169 \$ 177 \$ 183 \$ 195</p>

 <p>Overhead Shelf Dividers Shelf Dividers — package of 6</p> <p>Specify paint SIN 711-3</p>	H38SHFDV	3.0	0.2	\$ 128	\$ 139
---	-----------------	-----	-----	--------	--------

How to specify	Select Model Number from above	1st Option
	H 3 8 S H F D V .	Select Paint Color See page 349 T 1

Description	Model	Ship Weight	Cube	List by Paint Grade	
				Core	Metallics
 <p>Cord Cover</p> <ul style="list-style-type: none"> Allows routing of task light cords. Vertical height 10". Vertical height 15". Cord cover can be positioned into panel slots and used under task lights and under worksurfaces. 	<p>HECC10 HECC15</p>	<p>0.7 1.0 </p>	<p>0.2 0.3</p>	<p>\$ 34 \$ 34</p>	<p>\$ 41 \$ 41</p>

How to specify	Select Model Number from above	1st Option
	H E C C 1 0 .	Select Paint Color See page 349 T 1

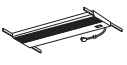
Description	Model	Ship Weight	Cube	Basic	Chicago
				(No suffix required)	Code "CH"
 <p>Task Lights</p> <ul style="list-style-type: none"> Slim profile design mounts recessed under storage unit and shelves with spring steel clips. T5 bulb included which contains less mercury than other types of bulbs. 9-foot black cord and switch off right rear corner. Electronic ballast for increased energy efficiency. 2 lights (HH870930) can be mounted under 60"W storage cabinets. <p>For 24"W storage cabinets or shelves, 18 7/8"W x 3 1/16"D x 1 1/8"H</p> <p>For 30"W and 36"W storage cabinets or shelves, 22 7/8"W x 3 1/16"D x 1 1/8"H</p> <p>For 42"W and 48"W storage cabinets or shelves, 34 5/8"W x 3 1/16"D x 1 1/8"H</p> <p>For 60"W and 72"W storage cabinets or shelves, 46 1/2"W x 3 1/16"D x 1 1/8"H</p> <p>NOTES: For LED light options, see page 376.</p> <p>⚠ Color: Black.</p>	<p>HH870924(?) HH870930(?) HH870942(?) HH870960(?)</p>	<p>5.0 7.0 10.0 12.0 </p>	<p>0.4 0.6 0.9 1.1</p>	<p>\$ 201 \$ 205 \$ 222 \$ 240</p>	<p>\$ 262 \$ 268 \$ 282 \$ 300</p>

Open Market

Chicago Code Version —
Specify: Model/"CH".
EXAMPLE: HH870924CH

About® Electrical and Data



About® features capabilities for cable management, including electrical, voice, and data. The 8-wire electrical system can be integrated at base pathway and beltline. The open structure of the frame allows voice and data cables to be routed both vertically and horizontally.

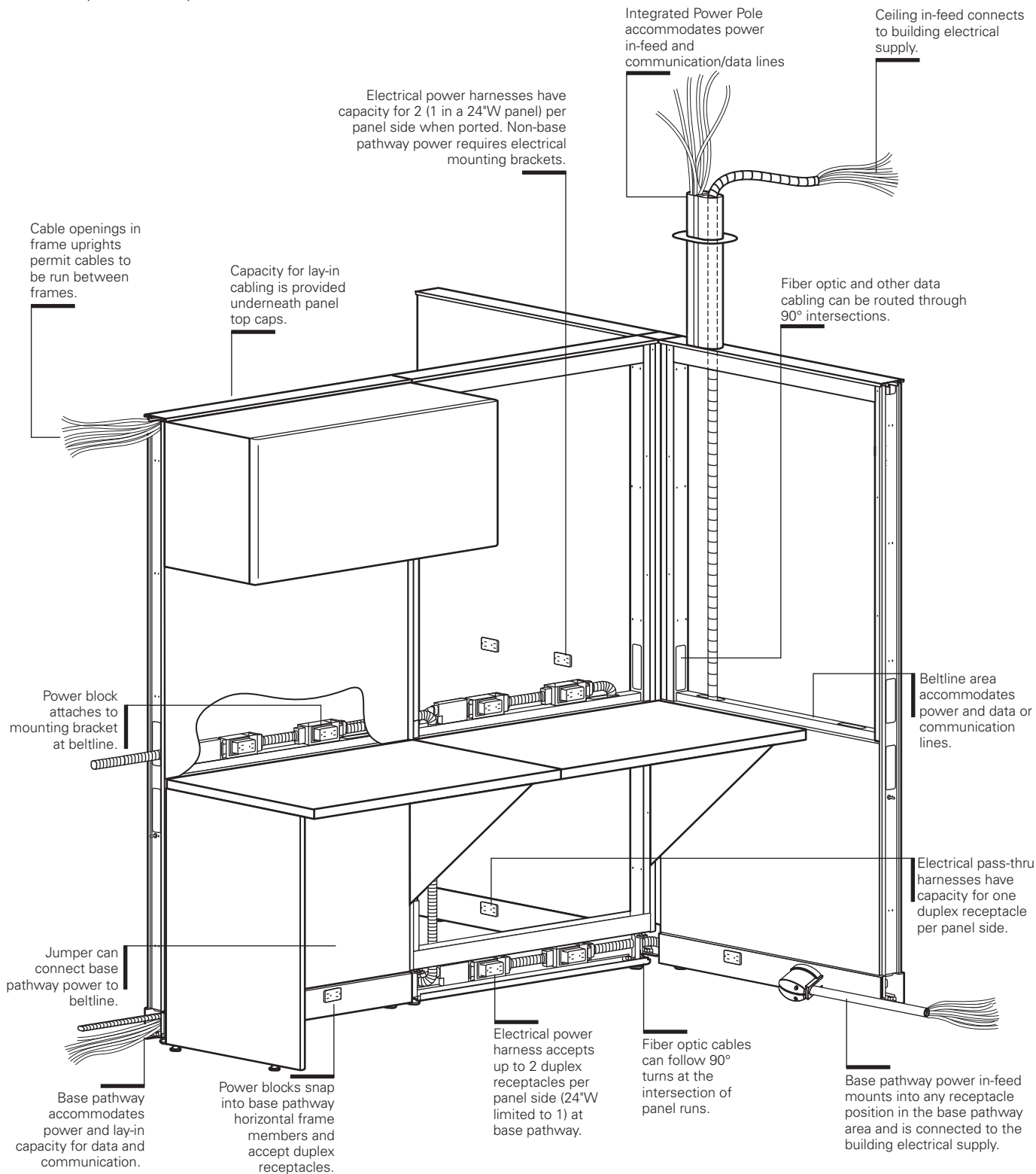

The Abound electrical systems

Abound offers a choice of three electrical systems:

- Four-circuit, 3 + 1
- Four-circuit, 2 + 2
- Three-circuit, separate neutrals

All three systems utilize an 8-wire electrical system, rated at 20 amps per circuit (15 amps Canadian). See pages 384-385 for a detailed explanation of each electrical system.

Abound frames and electrical components are UL Listed. Electrical components are also CSA certified.

Installation and use of the electrical system, the number of receptacles used on a given circuit and connections to the building power supply should be in compliance with all local and national electrical codes.

Caution: Electrical equipment cords or extension cords MUST NOT BE ROUTED through cable openings in frame sides.

Abound's electrical harnesses are UL listed and are considered raceways themselves as defined by the National Electrical Code. This means there is no separation requirement between the electrical harnesses and communications cables per Sec. 800-52 of the National Electrical Code. Communication cables may be placed next to Abound's electrical components without a metal septum and will still meet the guidelines of the Telecommunications Industry Association for separation of power and data.

In-feeds

Power in-feed cables deliver power from building to system. In-feed cables are housed in conduit to separate electrical system from communications and data lines.

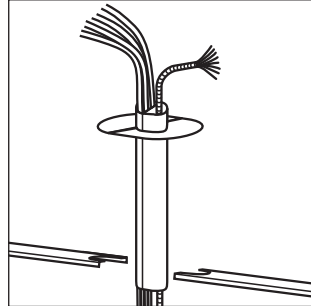

Integrated power and communications poles provide capacity for routing power supply directly through the top of any structural or stacking frame using same width trim/connector kit in place of top cap. Avoid glass or translucent tiles in upper position of frames with integrated power poles. Power pole has a cavity on each side of a center septum. When using a ceiling power in-feed, consider that the in-feed must connect into an electrical harness located in an adjacent panel. (See pages 386-388 for cable capacity.)

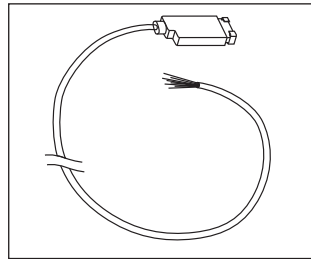

Ceiling power in-feed connects to a prewired electrical harness in the beltline or base pathway, traverses through an adjacent panel and terminates in the junction box at the top of the integrated power pole. For use with integrated power pole models HEP65 and HEP35. No portion of the flex cable can be exposed after installation.

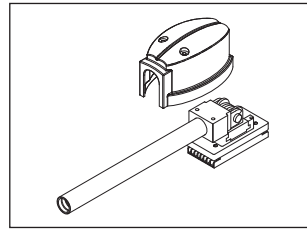

Sealtight base pathway power in-feed attaches to a receptacle opening at the base pathway. A heavy rubber sheathing shields conduit, allowing in-feed to be exposed.

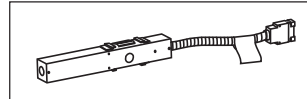

Hardware (New York Code) Power In-Feed (model H871400) is used when local electrical codes require hardware entry. When used in 24"W, 30"W and 36"W panels, power can be routed only in one direction. When used in 42", 48"W and 60"W panels, an electrical pass-thru cable or harness for that panel width can be used to route power back in the opposite direction. Unit must connect to a power or pass-thru harness positioned in the base pathway area of an adjacent panel. Customer to furnish all cabling and wiring from power entry to power source. Junction box can be positioned at any duplex receptacle location.

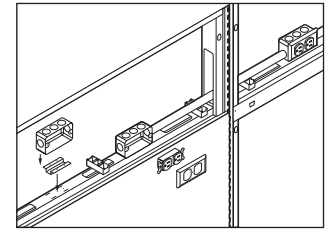

Hardware (Chicago Code) Junction Box

Wiring harnesses and snap connectors are not allowed in Chicago — base pathways must be comprised of all metallic components. Concealed mounting is the only option at beltline. For the base pathway, junction box (model HH873500) clips directly into receptacle locations. Customer must furnish conduit, wiring, standard duplex receptacles with metal covers for the beltline and designer-type receptacles for the base pathway. Power entry can be routed from the ceiling, via an Abound power pole, or from the floor into a junction box (model HH873500).

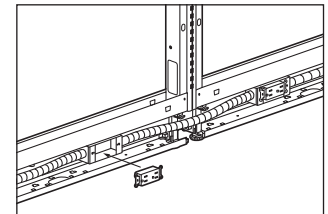

Power

Power blocks on electrical power harness and pass-thru harness accept duplex receptacles.

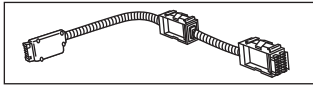

Electrical power harnesses are used to distribute power in panels. Abound electrical can be located at base pathway or beltline only. Connectors at both ends of power harnesses allow power distribution in either direction.

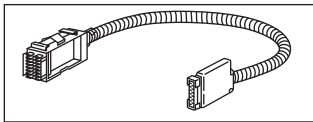

Electrical pass-thru harnesses have capacity to handle one duplex receptacle on each side of the panel when exposed.

A 60" pass-thru harness can be used to jump up to a single duplex receptacle per side at beltline and connecting to a power harness at base pathway.

Electrical power harnesses and pass-thru cables cannot be routed at 90° at beltline once frames are connected to connector blocks.

Electrical pass-thru cables distribute power through any panel where receptacles are not required. Cable length cannot be stretched.

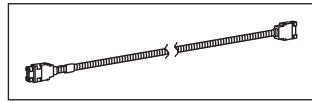

Electrical jumper cables connect power from base pathway or beltline to a harness located on any horizontal member as needed. Jumper cable plugs into power block end of electrical power harness or electrical pass-thru harness.

Model HH871366 is 66" to jumper up to 30 inches vertically – base pathway to beltline or beltline to base pathway.

Jumper can also be used from beltline to adjacent beltline at 90° juncture.

Power Blocks

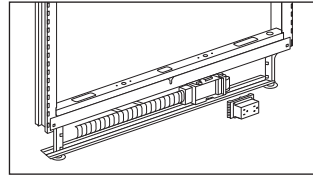

Base pathway mounting: Power blocks snap directly onto brackets in base pathway area.

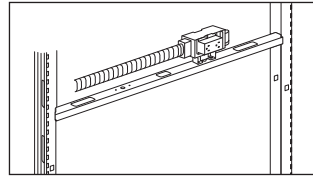

Beltline electrical mounting: For ported receptacles at beltline mount power blocks onto Electrical Mounting Brackets which screw into the panel frame. Electrical Mounting Brackets must be ordered separately. Data/Electrical Port Tiles must be used where exposed receptacles will be located.

Receptacles

Duplex receptacles snap into power blocks of power harnesses or pass-through harnesses. Duplexes are available in multiple colors. Each receptacle is labeled to indicate which circuit it will be connected to.

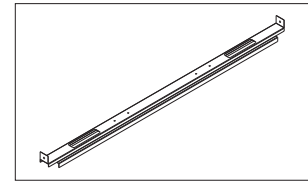
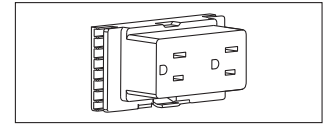

Optional Stiffener Support

Stiffener supports can be used to provide additional rigidity to a panel when fabric tiles are on both sides of the frame. May also be used for routing power/data at non-standard heights.

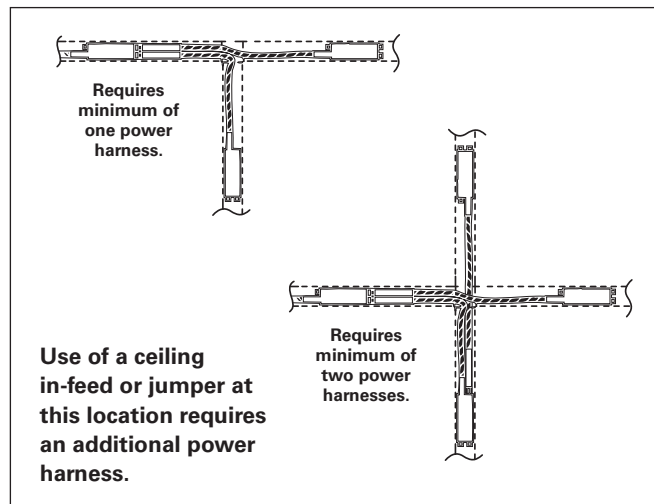

All electrical power harnesses and pass-thru harnesses will stretch 3½", allowing them to span "T" and "X" intersections and "S" extended straight connections.

Accelerate® features capabilities for cable management, including electrical, voice, and data. The 8-wire electrical system can be integrated at base pathway. See Systems electrical pages 389-392 for electrical models to be used with Accelerate® Systems products.

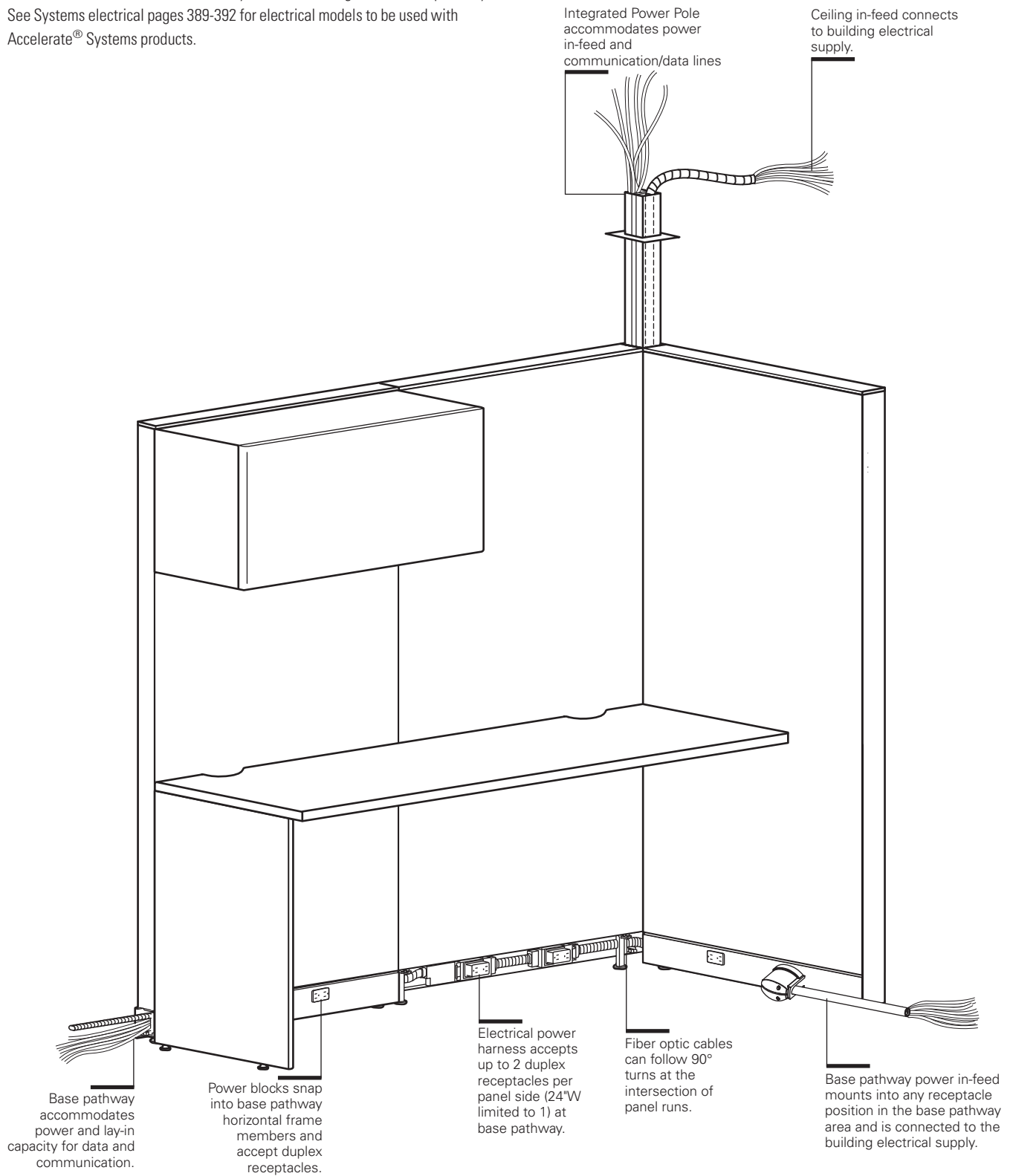

The Accelerate electrical systems

Accelerate offers a choice of three electrical systems:

- Four-circuit, 3 + 1
- Four-circuit, 2 + 2
- Three-circuit, separate neutrals

All three systems utilize an 8-wire electrical system, rated at 20 amps per circuit (15 amps Canadian). See pages 384-385 for a detailed explanation of each electrical system.

Accelerate panels and electrical components are UL Listed. Electrical components are also CSA certified.

Installation and use of the electrical system, the number of receptacles used on a given circuit and connections to the building power supply should be in compliance with all local and national electrical codes.

Caution: Electrical equipment cords or extension cords MUST NOT BE ROUTED through cable openings in frame sides.

Accelerate's electrical harnesses are UL listed and are considered raceways themselves as defined by the National Electrical Code. This means there is no separation requirement between the electrical harnesses and communications cables per Sec. 800-52 of the National Electrical Code. Communication cables may be placed next to Accelerate's electrical components without a metal septum and will still meet the guidelines of the Telecommunications Industry Association for separation of power and data.

In-feeds

Power in-feed cables deliver power from building to system. In-feed cables are housed in conduit to separate electrical system from communications and data lines.

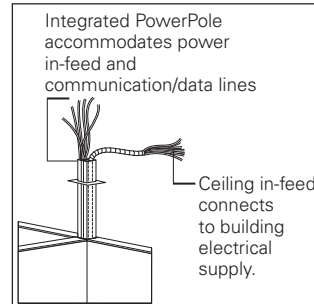

Integrated power and communications poles provide capacity for routing power supply directly through the top of any connector. Power pole has a cavity on each side of a center septum. When using a ceiling power in-feed, consider that the in-feed must connect into an electrical harness located in an adjacent panel. (See pages 386-388 for cable capacity.)

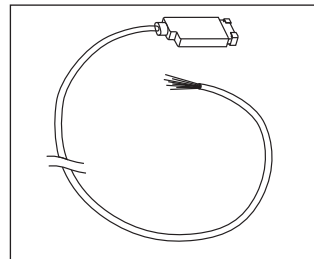

Ceiling power in-feed connects to a prewired electrical harness in the beltline or base pathway, traverses through an adjacent panel and terminates in the junction box at the top of the integrated power pole. For use with integrated power pole models HECPP. No portion of the flex cable can be exposed after installation.

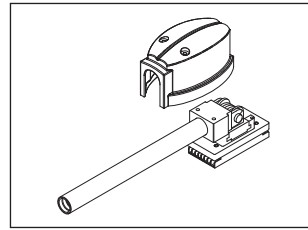

Sealight base pathway power in-feed attaches to a receptacle opening at the base pathway. A heavy rubber sheathing shields conduit, allowing in-feed to be exposed.

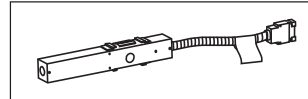

Hardwire (New York Code) Power In-Feed (model H871400) is used when local electrical codes require hardwire entry. When used in 24"W, 30"W and 36"W panels, power can be routed only in one direction. When used in 42", 48"W and 60"W panels, an electrical pass-thru cable or harness for that panel width can be used to route power back in the opposite direction. Unit must connect to a power or pass-thru harness positioned in the base pathway area of an adjacent panel. Customer to furnish all cabling and wiring from power entry to power source. Junction box can be positioned at any duplex receptacle location.

Hardwire (Chicago Code) Junction Box

Wiring harnesses and snap connectors are not allowed in Chicago — base pathways must be comprised of all metallic components. Concealed mounting is the only option at beltline. For the base pathway, junction box (model HH871500) clips directly into receptacle locations. Customer must furnish conduit, wiring, standard duplex receptacles with metal covers for the beltline and designer-type receptacles for the base pathway. Power entry can be routed from the ceiling, via an Accelerate power pole, or from the floor into a junction box (model HH871500). See Systems electrical pages 389-392 for electrical models to be used with Accelerate® Systems products.

Duplex Receptacles

For Duplex Receptacle models that can be used on Accelerate® panel systems, please see page 391.

All Systems electrical components can be found on page 389.

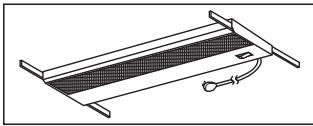

Lighting

Task lights can be recessed under storage cabinets or storage shelves.

Task lights in four sizes are available to correspond to cabinet or shelf width. They have 9' power cords in black, connected in the right rear corner. All models feature electronic ballast for longer bulb life and cooler operating temperature. Task lights with a fused plug to meet Chicago electrical code are also available.

Recommendation: Provide a separate circuit for task lights for proper long-term operation without RF interference to computers that may be in use.

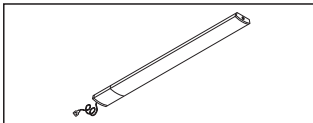

LED Task Lights

No finish specification required. Attaches magnetically to underside of overhead storage, or attaches with provided screws.

Occupancy sensor attaches to a single or starter LED light and will automatically turn the light off after no motion is detected for 30 minutes.

Just like all the LED light models, the occupancy sensor features a soft-touch on/off switch. LED task lights have a lifetime of 50,000 hours and have a dimmer feature that allows the user to adjust the amount of light output.

Daisy chain options are available. To use the daisy chain application, must start with model HLED17A or HLED31A.

Voice/Data Receptacles

Abound not only provides space for large volumes of voice and data cables, it also offers several means of mounting commercially available voice and data components.

Commercially available modular data faceplates can be mounted in vacant base receptacle openings or can be mounted in data/electrical port tiles above or below the worksurface.

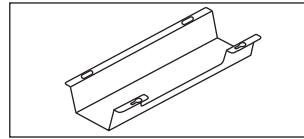

Cable management troughs attach to worksurfaces with provided screws. The graphite metal troughs are designed with cord access cut outs. These cut outs give users access to inside the trough without having to detach it from the worksurface.

To Order:

1. Determine which electrical system you will use after consulting your electrician and computer support personnel:

- **The Four-circuit system (4-Hot/2-Neutral/2-Ground)**
 - 3 + 1 option
 - 2 + 2 option
- **The Three-circuit system (3-Hot/3-Neutral/2-Ground)**

2. Determine location, quantity and circuit of duplexes.
3. Determine the appropriate choice and use of Isolated, Isolated/Dedicated and Separate Neutral circuits.
4. Specify appropriate Power Harnesses* and Pass-Thru Cables.*
5. Determine the location, quantity and type of Power In-feed needed.

* Select Power Harness models (HH8712XX) and Pass-Thru Cables (HH8711XX) with the last two digits being 1" (or 2") smaller than the associate panel width.

Electrical System Options

The four-circuit, eight-wire electrical system is widely specified and trusted by hundreds of thousands of end-users. This proven system delivers four circuits for every power infeed in either a 3 + 1 or 2 + 2 configuration. The isolated/dedicated circuits are ideal for sensitive computing equipment, while the common circuits are suitable for faxes, copiers, task lights and other peripherals.

Both the 3 + 1 and 2 + 2 systems use the same pre-wired components, making it easy to adjust as electrical needs change.

You can also choose a three-circuit, eight-wire system that has a dedicated neutral for every hot circuit. The three-circuit components have model numbers with an "A" suffix and appear in a gray box in this pricer.

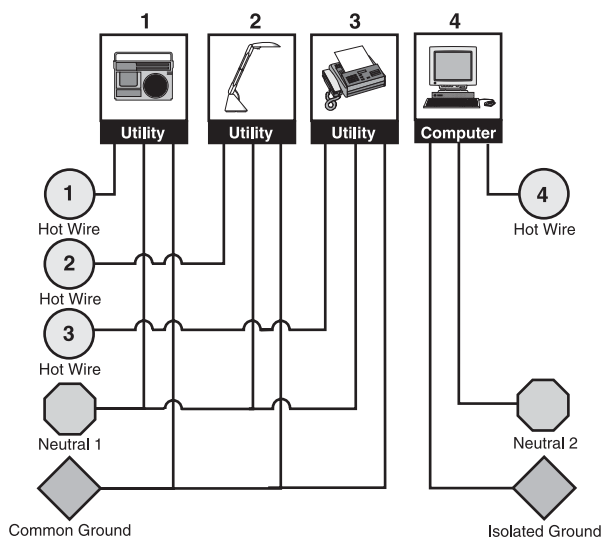
Four-circuit, 3 + 1 Receptacle Option

The 3 + 1 option is the electrical standard used by The HON Company for many years in most of their systems products. This wiring option provides three utility circuits plus an isolated/dedicated circuit for more sensitive equipment.

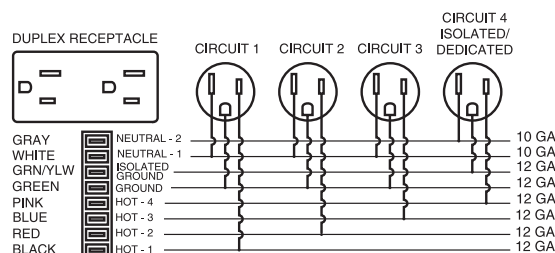
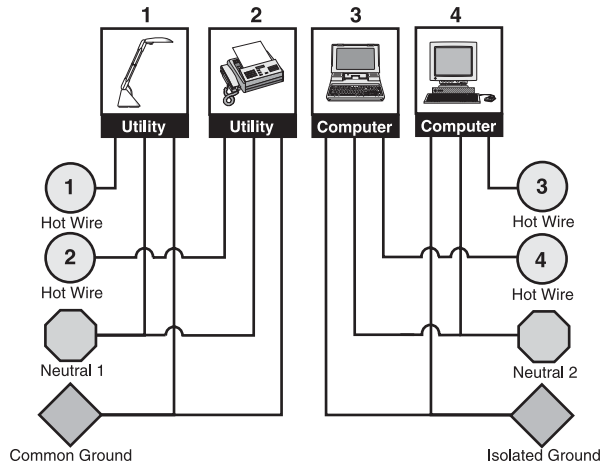
**Four-circuit, 2 + 2 Receptacle Option**

The 2 + 2 option is a wiring option that provides two utility circuits and two isolated circuits for more extensive computer usage applications.

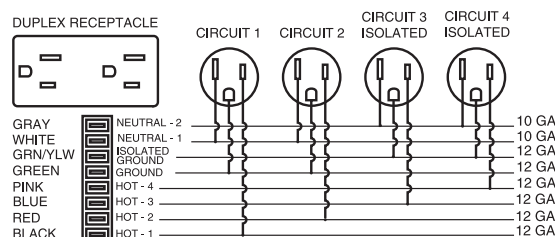

Three-circuit, separate neutrals

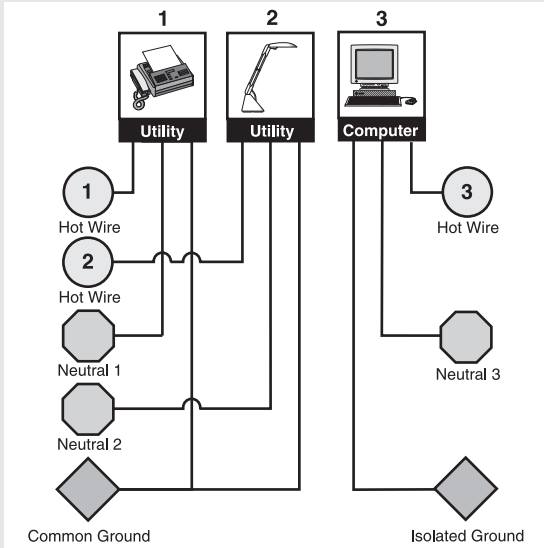

The Three-circuit, separate neutrals configuration is a wiring option that provides separate neutrals for each of the three circuits. Two circuits share a common ground, and one circuit is isolated/dedicated. The three-circuit components have model numbers with an "A" suffix and appear in a gray box in this pricer.

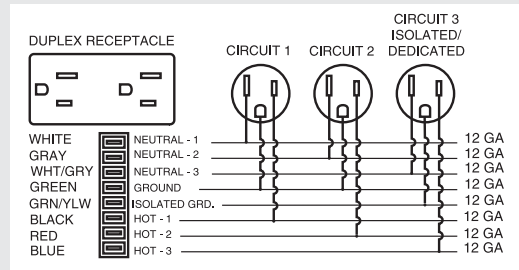

Two 8-wire, 20 AMP (15 AMP Canadian) electrical systems are offered					
Electrical System	Circuitry	Receptacle Capacity			
Four-circuit 4-Hot/2-Neutral/2-Ground (10 gauge neutral wires)	3 + 1	Common Circuit-1 HH873501	Common Circuit-2 (1) HH873502	Common Circuit-3 HH873503	Iso/Dedicated Circuit-4 HH873504
	2 + 2	Common Circuit-1 HH873501	Common Circuit-2 HH873502	Isolated Circuit-3 HH873506	Isolated Circuit-4 HH873504
Three-circuit 3-Hot/3-Neutral/2-Ground (12 gauge neutral wires)	w/separate neutrals	Common Circuit-1 HH873501A	Common Circuit-2 HH873502A	Iso/Dedicated Circuit-3 HH873503A	N/A

- Notes:
- Four-circuit components and three-circuit components (with suffix "A") cannot be used together.
 - Components of the two systems are keyed differently to prevent components of one system from being connected to components of another system.
 - HON Cat. Nos. are printed on the UL labels, and components are color-coded to provide visual identification of the different components.
 - Four-circuit components have black plastic parts.
 - Three-circuit components have rust-colored terminal ends and receptacle backs are rust colored.

(1) Circuit-2 (one of the 3 common circuits sharing a neutral wire) cannot be used with a single-phase building electrical supply.

Typical power usage by the most commonly specified office equipment.

Source: Industry Analysis, Inc., Rochester, NY

EQUIPMENT	AMPS	EQUIPMENT	AMPS	EQUIPMENT	AMPS
Computers		Copiers		FAX Machines	
Personal Computer	3	Desktop Copier	15	InkJet FAX	less than 1
Notebook Computer	3	Console Copier	20	Thermal FAX	less than 1
		Copier/Duplicator	30	Plain paper FAX	8
Monitors		Printers		Task Lights	
13" Color Monitor	2	Dot Matrix	less than 1	36" T8 Fluorescent	0.2/bulb
17" Color Monitor	3	InkJet	less than 1	48" T8 Fluorescent	0.3/bulb
21" Color Monitor	4	Personal Laser or LED	8		
		Workgroup Laser or LED	15		

Duplex Receptacles



15 AMP Receptacle

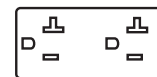

20 AMP Receptacle
(Required by some large copiers.)

Systems Electrical Specifying Information

- About panels are UL listed.
- Electrical components are UL Listed and CSA Certified.
- It is the customer's responsibility to ensure that use of the pre-wired electrical system, the number of receptacles used on a given circuit, and connection to a building power source, be in compliance with all local and national electrical codes.
- Contact Customer Service for additional information.
- Pedestals and Lateral Files, positioned under work surfaces, may render some receptacles inaccessible, and may prohibit use of grommets.

- Four-circuit components and Three-circuit components (with suffix "A") cannot be used together. See pages 384-385.
- ⚠ **A licensed electrician must make connections to a building electrical supply.**

- ⚠ **Three-way panel connections require at least one power harness.**
- ⚠ **4-way panel connections require at least two power harnesses.**

Definition of components:

Electrical Power Harness

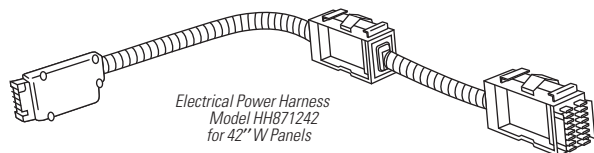

- Used to distribute power in panels.
- Power distribution in either direction.
- Specify Power Harness to match panel width.
- Double-sided: receptacles can be inserted into both sides of Power Blocks.
- ⚠ **Three-way panel connections require at least one power harness.**
- ⚠ **4-way panel connections require at least two power harnesses.**

Electrical Pass-Thru Cables

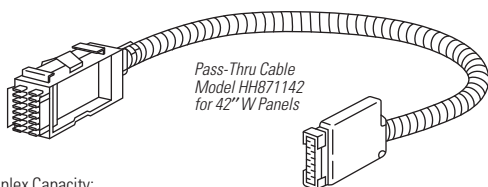

Pass-Thru Cable With Duplex Capacity:

- Use in panels where multiple receptacles are not required.
- Added feature: has capacity for one receptacle on each side of a panel. Feature offers future expansion and is an alternative to Power Harnesses.

Various Electrical Layouts



Straight Line

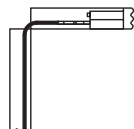

90 Degree Corner

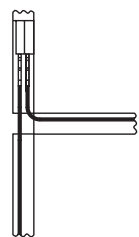

"T" Connection

When ending power in two return panels, wiring pigtails must be returned to original panel run.

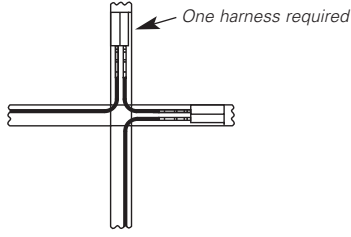

"X" or Cross Connection

To power a 4-way panel connection from one direction, specify at least two double block harnesses.

Duplex Receptacles

- 15 amp outlet configuration.
- Models HH871601 and HH871601A have a 20 amp outlet configuration.
- Fit back-to-back into the Power Block(s) of Power and Pass-Thru Harnesses.
- Labeled with the provided circuit. Circuits connected to the Isolated Ground are identified with an orange triangle; circuits that do not share a neutral or ground have an orange circuit number.

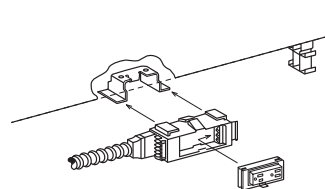

Power In-Feed (Base) Models HH879072 (72") and HH879168 (168")

- Used to connect the panel electrical system to the building electrical supply at a power block.
- Plugs into any receptacle position; can be rotated Left or Right.
- Conduit is UL listed Black Liquid-tight conduit (outside diameter is 1/8").
- ⚠ **A licensed electrician must make connections to a building electrical supply.**
- ⚠ **Must be positioned through a receptacle opening in the baserail cover, prior to an electrician connecting to the power source.**

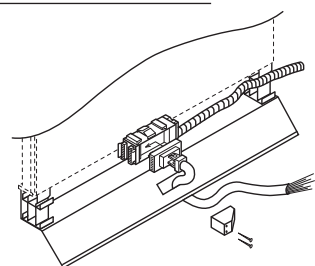

Power In-Feed Model (Ceiling) HH871912 and HH871972

- Used to connect the panel electrical system to the building electrical supply.
- ⚠ **A licensed electrician must make connections to a building electrical supply.**
- ⚠ **Model uses UL recognized flex-cable conduit — no portion can be left exposed (i.e., must be in a power pole).**
- ⚠ **Power Pole HEP35/HEP36 must be ordered separately.**

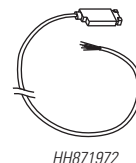

HH871972

Note: In-feed cables listed above may be field-cut to desired length.

Electrical Jumper Cables

- ⚠ **When used to connect power between the base pathway and the beltline area, the jumper must be connected to a power block at one end of a run, routed into an adjacent panel that does not contain a power harness, then routed back into the panel containing a power harness or pass-thru cable and connected to a power harness in the other pathway.**

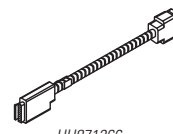

HH871366

Electrical Mounting Brackets

- Use to mount ported receptacles at beltline.
- Screw into the panel frame.
- ⚠ **One mounting bracket required at beltline for each 24" W pass-thru or power harness. Two required for 30"-60" W power harness.**

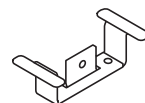

HH8988EBN

Base Pathway Receptacle Locations

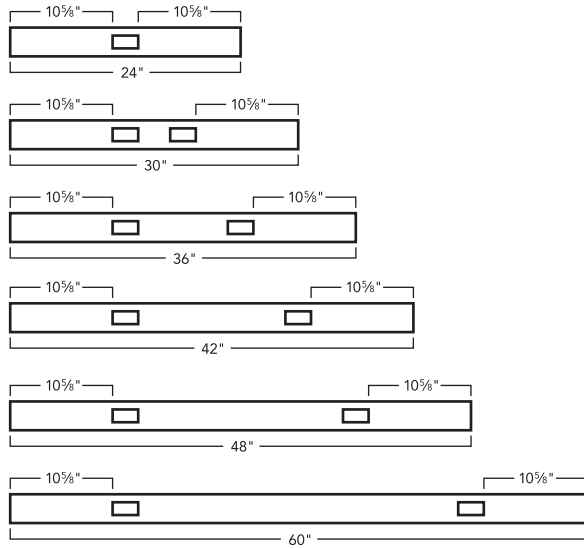

Abound® Lay-in Cable Capacity

The top and base pathway allow continuous voice and data lines to run through and between panels without interruption. Lay-in is provided for environments where systems furniture or cabling are subject to frequent change. All capacities are for Cat 6 cable with a 0.25" diameter.

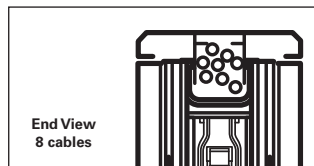

Top pathway accepts up to 8 voice/data cables (.25" dia.).

Circuit Usage

Strategy 1

Circuits to Equipment
Assign specific uses for each of the circuits:

- For example, in a four-circuit system:
Circuit 1 — Calculators, fans, etc.
Circuit 2 — Task lights (could be wired to wall switch)
Circuit 3 — Computer monitors
Circuit 4 — CPUs

Strategy 2

Circuits to Workstations
Assign specific workstations to each of the three available circuits. Use circuit 4 for power-sensitive electronic equipment.

Placement of pedestals and lateral files may render some duplex locations inaccessible. Pedestal placement may also affect compatibility with pull-up receptacles.

Abound® Lay-In Cable Capacity

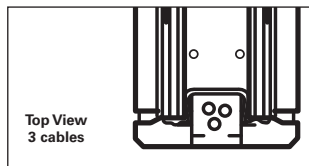

Variable height junctions accept up to 3 voice/data cables (.25" dia.).

Abound® Cable Capacity

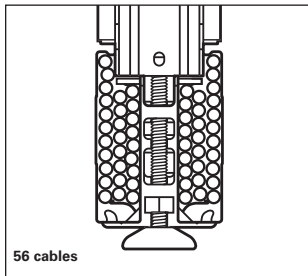

Abound® base pathway accepts up to 56 voice/data cables (.25" dia.) (6.03 sq. in.) at 60% fill.

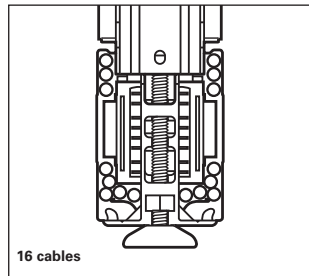

When electrical system shares base pathway, the cable capacity in Abound is reduced to 16 cables (2.25 sq. in.). Cable quantities listed are at 60% fill ratio.

Accelerate® Cable Capacity

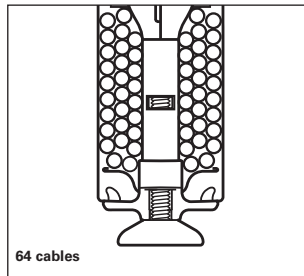

Accelerate® base pathway accepts up to 64 voice/data cables (.25" dia.) (6.27 sq. in.) at 60% fill.

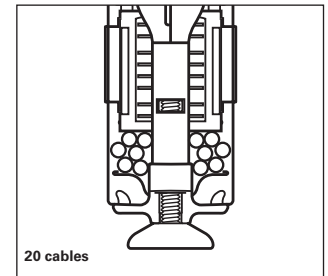

When the electrical system shares the base pathway, the cable capacity in Accelerate® is reduced to 20 cables (.25" dia.) (2.03 sq. in.) at 60% fill ratio.

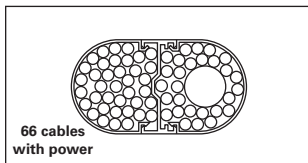

Cable capacity of the power pole, in addition to electrical in-feed is 2.79 sq. in. on one side and 2.91 sq. in. on the other for a total capacity of 66 cables with power of .25" diameter.

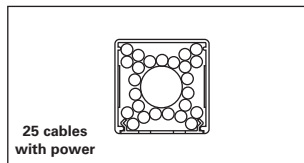

Integrated Power Pole: 2" x 2" overall, 3.3"² interior accommodates a total of 25 cables with power of .25" diameter. Available in two heights: 6'6" or 13', the power pole connects via the universal connector and the overall height is the sum of the connector and the power pole. Constructed of aluminum with a powder coat paint finish in the specified color. Power pole requires a Ceiling In-Feed.

Ceiling In-Feeds: UL listed as raceways. This means the electrical components are completely shielded and meet any requirements for separation of electrical components and communications cables per Section 800-52 of the National Electrical Code.

Systems Electrical and Data



Around String-in Capacity

Openings in frame sides permit electrical data and communication cables to be run between frames in Around. Using tackable acoustical tiles, the beltline pathway accommodates up to 62 cables (.25" dia) or 46 cables with electrical components installed.

DO NOT run electrical equipment or extension cords through cable openings in frame sides. Use beltline or base-mounted electrical system for all electrical supply.

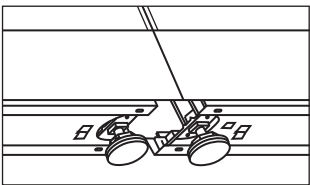
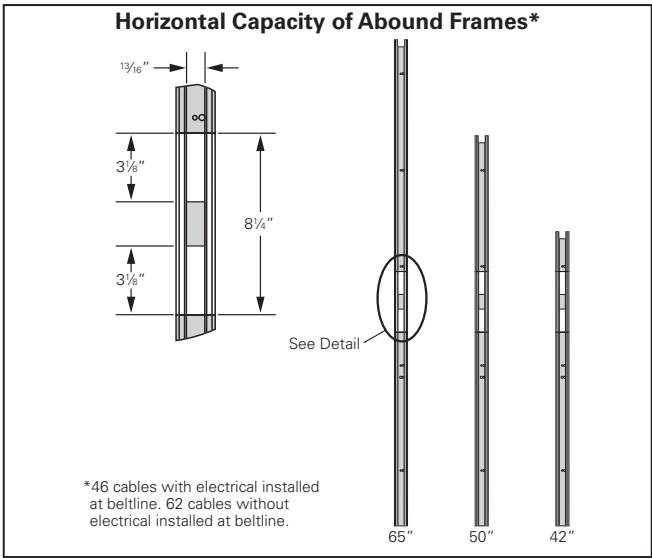

Cables can enter/exit panel through underside of base pathway at juncture between frames. Openings are sized as follows (in sq. in.):

Straight connection	6.0
"S" Extended Straight Connection	10.0
"L" 90° Connection	8.9
"T" Connection	15.9
"X" Connection	17.9
"Y" Connection	—

When leveling glides are fully retracted, panel-to-floor clearance is 7/16". This may affect the volume of cabling that can be fed into the frame from the bottom of the pathway.

Vertical Capacity

Vertical Capacity Through panel Frames

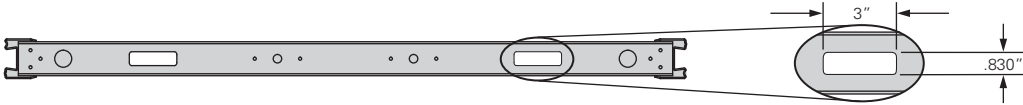







	Panel Width	Qty. of .25" Cables at 45% Fill Ratio	Qty. of .25" Cables at 60% Fill Ratio	Total Space (sq. in.)
Around	24" – 60"W	48	64	5.26

- A 60% fill ratio is achievable; however, when electrical components are installed in the beltline area, cabling capacity through the beltline area will be limited to approximately 45% fill ratio.

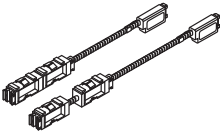
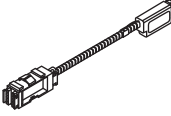
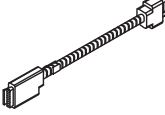
► Duplex receptacles on page 391. **⚠ Four-circuit components and three-circuit components (with "A" suffix) not designed to be used together. See pages 384-385.**

⚠ To connect power between the base pathway and the beltline area, four-circuit jumper cables (H8713xx) must be connected to a power block at one end of a run, routed into an adjacent panel that contains no power harness, then routed back into the panel that contains a power harness (or pass-thru cable), and connected to a power harness in the other pathway.

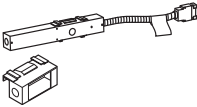

Description	Max. Recept. Cap. per Panel Side	Four-circuit 3+1 2+2	Three-circuit, Separate Neutrals	Ship Weight	Cube	List	
 <p>Electrical Power Harnesses, Frames — w/duplex capacity</p>	For 24"W	1	HH871224	HH871224A	2.0 [S]	0.5	\$ 185
	For 30"W	2	HH871230	HH871230A	2.0 [S]	0.5	\$ 185
	For 36"W	2	HH871236	HH871236A	2.5 [S]	0.5	\$ 185
	For 42"W	2	HH871242	HH871242A	3.0 [S]	0.5	\$ 194
	For 48"W	2	HH871248	HH871248A	3.0 [S]	0.5	\$ 194
	For 60"W	2	HH871260	HH871260A	3.0 [S]	0.5	\$ 194
	For 72"W (for use with Accelerate® 72"W panels only)	2	HH871272	HH871272A	5.0 [S]	0.5	\$ 194
 <p>Electrical Pass-Thru Cables, Frames — w/duplex capacity</p>	For 24"W	1	HH871124	HH871124A	2.0 [S]	0.5	\$ 115
	For 30"W	1	HH871130	HH871130A	2.0 [S]	0.5	\$ 115
	For 36"W	1	HH871136	HH871136A	2.0 [S]	0.5	\$ 115
	For 42"W	1	HH871142	HH871142A	2.5 [S]	0.5	\$ 121
	For 48"W	1	HH871148	HH871148A	2.5 [S]	0.5	\$ 121
	For 60"W	1	HH871160	HH871160A	3.0 [S]	0.5	\$ 121
	For 72"W (for use with Accelerate® 72"W panels only)	1	HH871172	HH871172A	5.0 [S]	0.5	\$ 121
 <p>Electrical Pass-Thru Harness without Power Block</p>	For 24"W Frames	0	HH871024	HH871024A	2.0 [S]	0.5	\$ 107
	For 30"W Frames	0	HH871030	HH871030A	2.0 [S]	0.5	\$ 107
	For 36"W Frames	0	HH871036	HH871036A	2.0 [S]	0.5	\$ 107
	For 42"W Frames	0	HH871042	HH871042A	3.0 [S]	0.5	\$ 111
	For 48"W Frames	0	HH871048	HH871048A	3.0 [S]	0.5	\$ 111
	For 60"W Frames	0	HH871060	HH871060A	3.0 [S]	0.5	\$ 111
	For 72"W Frame Runs	0	HH871072	HH871072A	4.0 [S]	0.5	\$ 153
	For 96"W Frame Runs	0	HH871096	HH871096A	5.0 [S]	0.5	\$ 184
	For 120"W Frame Runs	0	HH8710120	HH8710120A	6.0 [S]	0.5	\$ 216
	For 144"W Frame Runs	0	HH8710144	HH8710144A	7.0 [S]	0.5	\$ 242
 <p>Electrical Jumper Cables Jumper for up to 36" vertical jump, 66" long</p>			HH871366	HH871366A	3.0 [S]	0.5	\$ 124
 <p>Power In-Feed Cables — Base In-Feed 72" long conduit, Sealtight Cable — 7/8" diameter 168" long conduit, Sealtight Cable — 7/8" diameter</p>			HH879072 HH879168	HH879072A HH879168A	4.5 [S] 9.0 [S]	0.3 0.4	\$ 206 \$ 481
 <p>Ceiling In-Feed 144" long conduit, Flex Cable — 7/8" dia. 216" long conduit, Flex Cable — 7/8" dia.</p>			HH871912 HH871918	HH871912A HH871918A	4.0 [S] 4.0 [S]	0.5 0.5	\$ 214 \$ 279
<p>⚠ Must be used with Power Pole. Power in-feed models HH871912 and HH871918 plug into the end of any power block. No portion of the cable can be exposed after installation.</p>							
 <p>Hardwire Applications Hardwire Power In-feed</p>			HH871400	HH871400A	4.0 [S]	0.3	\$ 201
<p>⚠ Customer to furnish all cabling and wiring from power entry to power source (approved for use by city of New York).</p>							
 <p>Hardwire Junction Box (6-pack)</p>			HH871500		4.5 [S]	0.1	\$ 430
<p>⚠ For use with Accelerate® and Abound® Beltline only.</p>							
<p>Hardwire Junction Box (6-pack) ⚠ For use with Abound® Raceway panels only.</p>							
<p>HH873500 4.5 [S] 0.2 \$ 401</p>							
<p>NOTES: Junction Box can be positioned at any Duplex Receptacle location in 30"W or wider panels. ⚠ Customer must furnish conduit, wiring and designer type receptacles. (Approved for use by city of Chicago.)</p>							

How to specify	<p>Select Model Number from above</p> <p>H H 8 7 1 0 4 8 .</p>	<p>1st Option</p> <p>Select Color</p> <p>See page 309</p> <p>P</p>
----------------	---	---

Icon Legend on page 10

► Cable ports accommodate up to four individual voice and data outlets, and can be mounted anywhere there is an electrical receptacle opening.



Description	Model	Ship Weight	Cube	List by Paint Grade	
				Core	Metallics
 Abound® Integrated Power Pole For 35"H-50"H Frames. Poles are 78"H. For 65"H-95"H Frames. Poles are 52"H. NOTES: Power Pole includes ceiling trim piece.	HEP35	9 [S]	0.6		\$ 336
	HEP65	6 [S]	0.4		\$ 237

 Power Pole Trim Kit (Abound® only)	24"W	HRVP24P	2 [S]	0.3		\$ 120
	30"W	HRVP30P	3 [S]	0.4		\$ 126
	36"W	HRVP36P	4 [S]	0.5		\$ 133
	42"W	HRVP42P	5 [S]	0.5		\$ 136
	48"W	HRVP48P	6 [S]	0.6		\$ 140
	60"W	HRVP60P	7 [S]	0.7		\$ 148

Description	Model	Ship Weight	Cube	Core List
 Power Pole — w/o Receptacles (Voi® only) 10'5"	HH870070	140	0.5	\$ 375

Specify paint color for HH870070, not available in Putty

Description	Model	Ship Weight	Cube	List by Paint Grade		
				Core	Choice/Metallics	Custom
 Accelerate® Integrated Power Pole 78"H x 2"W x 2"D 156"H x 2"W x 2"D	HECPP	14 [S]	0.5	\$ 240	\$ 260	\$ 262
	HECPP156	28 [S]	1.0	\$ 585	\$ 605	\$ 607

Description	Model	Ship Weight	Cube	List
 Receptacle Cover Replacements Quantity 25	HEREPCVR	1 [S]	0.1	\$ 64

▲ For use with Accelerate® panels only.
 ▲ Specify Color — Available in Black (P), Muslin (T3) and Shadow (SHDW) only.

How to specify	Select Model Number from above H R V P 2 4 P	1st Option Select Paint Color See page 309 T 4
----------------	--	--

► Cable ports accommodate up to four individual voice and data outlets, and can be mounted anywhere there is an electrical receptacle opening.

► Data/Electrical Port Kit used for field installations of additional data accessories.

⚠ **Four-circuit components and three-circuit components (with "A" suffix) not designed to be used together. See pages 384-385.**
 ⚠ **Duplex receptacle models shown below are for use with Abound® models only.**



Maximum Receptacle Capacity in Abound Panel Base Raceways

Widths	24	30	36	42	48	60
Maximum of 1 duplex per panel side		X				
Maximum of 2 duplexes per panel side			X	X	X	X



Each marked with Circuit Number

Description

Abound® Duplex Receptacles

- Circuit 1
- Circuit 2
- Circuit 3
- Circuit 4

Circuit 1 — 20 amp outlet
 Circuit 3 (2 + 2)

Specify color.

⚠ **Duplex receptacle models above are for use with Abound® models only.**

	Four-circuit 3 + 1 2 + 2	Three-circuit, Separate Neutrals	Ship Weight	Cube	List
HH873501		HH873501A	0.5 [S]	0.1	\$ 37
HH873502		HH873502A	0.5 [S]	0.1	\$ 37
HH873503		HH873503A	0.5 [S]	0.1	\$ 37
HH873504			0.5 [S]	0.1	\$ 37
HH871601		HH871601A	1.0 [S]	0.1	\$ 37
HH873506		HH873506A	0.5 [S]	0.1	\$ 37



Each marked with Circuit Number

Description

Accelerate® Duplex Receptacles

- Circuit 1
- Circuit 2
- Circuit 3 (except 2 + 2 — see below)
- Circuit 4 — isolated, dedicated circuit

Circuit 1 (20 amp outlet configuration)
 Circuit 3 (2 + 2)
 Specify Paint.

NOTES: Use with Accelerate® models.

SPECIFYING EXAMPLE: HH871501.S

See page 349 for color options.

	Four-circuit 3 + 1/2 + 2	Three-circuit, Separate Neutrals	Ship Weight	Cube	Core List
HH871501		HH871501A	1.0 [S]	0.5	\$ 37
HH871502		HH871502A	1.0 [S]	0.5	\$ 37
HH871503		HH871503A	1.0 [S]	0.5	\$ 37
HH871504			1.0 [S]	0.5	\$ 37
HH871601			1.0 [S]	0.5	\$ 37
HH871506			1.0 [S]	0.5	\$ 37



Description

Data/Electrical Port Kit

Specify color

	Four-circuit 3 + 1 2 + 2	Three-circuit, Separate Neutrals	Ship Weight	Cube	List
HHT2DP			1.0 [S]	0.1	\$ 21

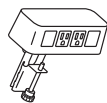

Open Market

Description

Power & Data Center

2 Receptacles 2 Data Accessory

- Standard with two receptacles and openings for two data ports.
- 6' power cord with standard three-prong plug.
- Fits on any worksurface with a 4" overhang.
- UL Listed.

⚠ **Color finish coordinates with HON's Loft. Specify LOFT when ordering. Example: HCOMDOME2.LOFT.**

Model	Ship Weight	Cube	List
HCOMDOME2	2.5 [S]	0.2	\$ 259

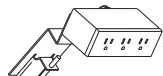

Open Market

Description

Power Modules

- 3 Receptacles with Worksurface Clamp
- 3 Receptacles with Under-Worksurface Mounting Bracket
- 2 Receptacles 2 USB with Worksurface Clamp
- 2 Receptacles 2 USB with Under-Worksurface Mounting Bracket

- 6' power cord with standard three-prong plug.
- Under-worksurface mounting bracket models work with any top that has a 5" x 5" square clearance.
- Worksurface clamp models work on any top with a 4" overhang.
- UL Listed.

⚠ **Color finish coordinates with HON's Charcoal or White. Specify S for Charcoal or WHIT for White when ordering. Example: HPWRMOD3WC.S.**

Model	Ship Weight	Cube	List
HPWRMOD3WC	2.3 [S]	0.2	\$ 272
HPWRMOD3UWM	2.3 [S]	0.2	\$ 272
HPWRMOD2WC	2.3 [S]	0.2	\$ 436
HPWRMOD2UWM	2.3 [S]	0.2	\$ 436

Model HPWRMOD3WC shown

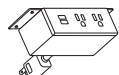

Model HPWRMOD2UWM shown



How to specify

Select Model Number from above	1st Option
Select Color	Select Color
HH873501	See page 349
P	

ABJ ⚠ [S] Icon Legend on page 10

▶ AMP Data Faceplates attach to bottom of panel or at worksurface height in front of baserail covers for easy cable routing.

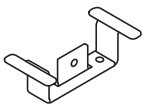
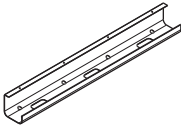
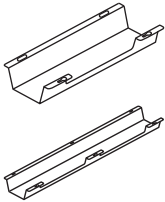
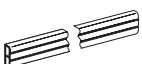
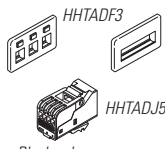
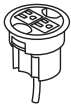

	Description	Model	Ship Weight	Cube	List
	Electrical Mounting Brackets (pack of 12) ▲ 1 bracket required at beltline for each pass-thru harness and 24"W power harness and 2 for 30"-60"W power harness.	HH8988EBN	3.0	0.1	\$ 56
	Cable Management Tray 24" 36"	HHCMT24 HHCMT36	2.0 3.0	0.3 0.4	\$ 66 \$ 80
	Cable Management Troughs 17"W — Single 17"W — 10-Pack 36"W — Single 36"W — 10-Pack • Cable management troughs ship flat packed. • The troughs attach to underneath the worksurface with screws. • The 17"W has one wire access cut out on the user side. The 36" has two wire access cut outs. These cut outs give users access to inside the trough without having to detach it from the worksurface. • Color: Graphite. • Material: Metal. • TAA Compliant. • Slim profile design.	HCTROUGH17 HCTROUGH1710 HCTROUGH36 HCTROUGH3610	2.7 14.0 4.9 30.0	0.5 0.5 0.9 0.9	\$ 60 \$ 568 \$ 101 \$ 959
	Wire Manager • HHEM model clips to bottom of panels. (62"L) • Slits in wire manager allows cable to be passed into unit.	HHEM620	10.0	0.5	\$ 93
	AMP Data Faceplates Three-port flex-mode faceplate Four-port flex-mode faceplate ▲ Data faceplates available in Black (E4) only.	HHTADF3 HHTADF4 HHTADJ5 HHTADJ6	1.0 1.0 1.0 1.0	0.2 0.2 0.1 0.1	\$ 22 \$ 22 \$ 37 \$ 50
	Power Hub, 3" Grommet Mount • Fits in 3" round grommet holes on the following product lines: Coordinate, Huddle, Motivate, all laminate and veneer casegoods series, and Systems Worksurfaces. • Two grounded AC power outlets. • Includes 6' cord with three-prong plug. • Field installed with Plug-and-play ease. ▲ Available in black only (no color designation so use .X – Specify: HGRMTAC.X).	HGRMTAC	1.3	0.2	\$ 100
	Power/USB Hub, 3" Grommet Mount • One grounded AC power outlet with 2 USB ports. • UL Listed. ▲ Available in black only (no color designation so use .X – Specify: HGRMTUSB2.X).	HGRMTUSB2	1.3	0.2	\$ 198

SIN 71-302

Open Market

Worksurfaces are 1 1/8" thick with particle-board core and with top surfaces finished in high-pressure laminate. Bottom surfaces are covered with a backer sheet.

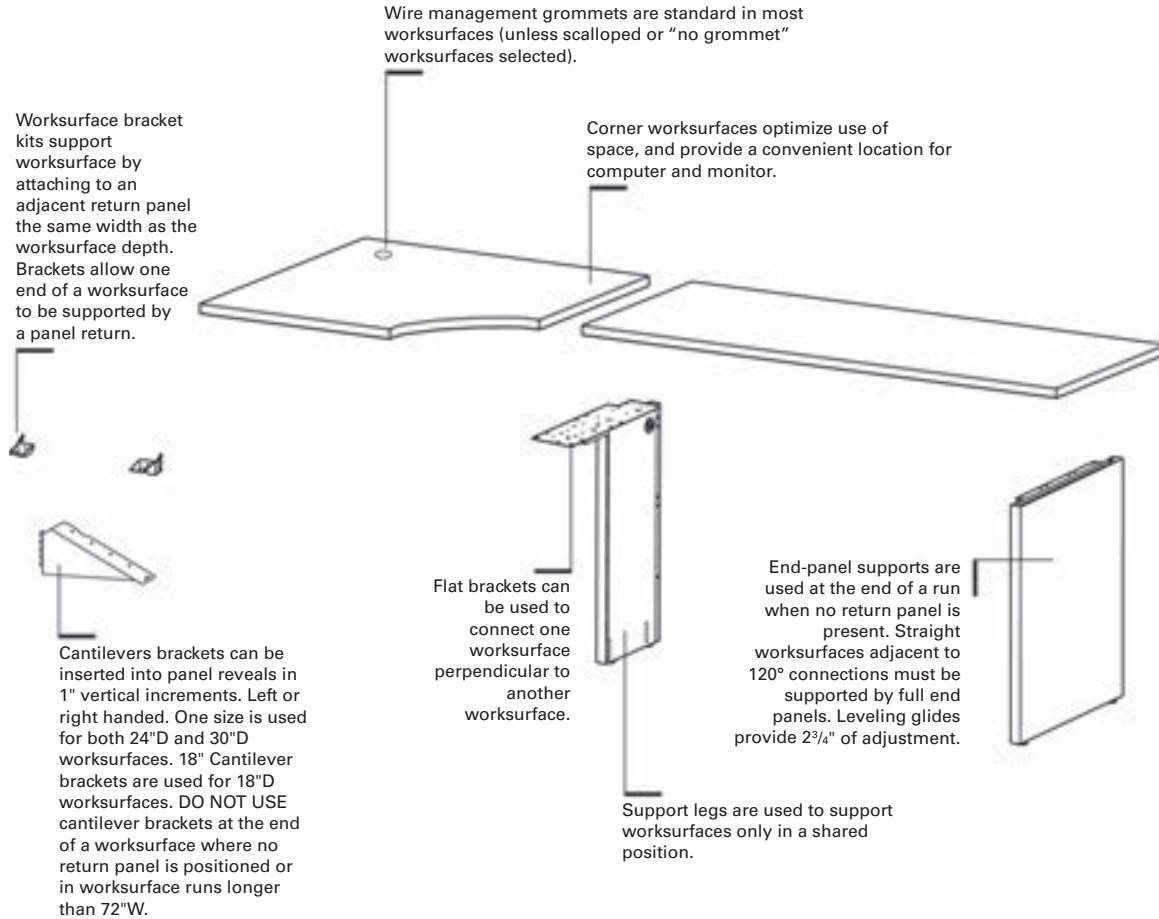

Primary worksurfaces are available in 18", 24" and 30" depths. Nominal worksurface width is equal to nominal panel width. Other support hardware is ordered separately.

Corner worksurfaces with woodgrain laminate have grain direction diagonal to adjacent worksurfaces. One rear center support bracket is included. All other support hardware is ordered separately.

Wire management grommets are standard in most worksurfaces. Grommets are available in the same colors as t-mold and edgeband. Worksurfaces less than 48"W have one grommet/scalloped on edge of worksurface. Rectangular worksurfaces over 42"W have two grommets/scallops. Peninsulas have one grommet or scallop. Corner Worksurfaces have one grommet or two scallops (one on each back edge). D-Shaped worksurfaces and countertops do not have grommets or scallops.

Edgeband and T-Mold Edge trim is available on laminate tops in standard colors (customer specified) to match or complement solid, patterned, or woodgrain laminates.

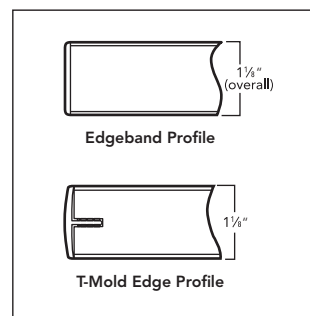

Systems Working with Worksurfaces and Supports

Optional width worksurfaces are available for use with panel runs having a TEE or Extended Straight connection.

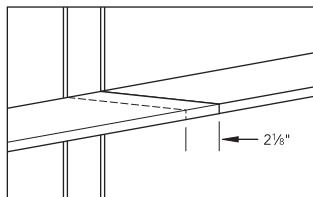

Worksurfaces can be configured at 29 1/2" with end-panel supports and support legs, or at various heights on 1" increments using specific product configurations.

Worksurface support options include:

- Open leg models
- Support column
- Flat brackets
- Worksurface bracket kit
- Cantilever bracket
- Universal support leg
- End-panel support
- Freestanding pedestal

Other worksurface supports include:

- Support columns
- External channel supports
- Support pedestals
- Pedestals with panel-to-pedestal bracket
- Desking freestanding shared leg

Support Guidelines:

- Unsupported panel runs greater than 72"W need floor support for improved stability.
- Worksurface bracket kit should be used to tie panels to worksurfaces for added stability.
- A panel run without a return needs a floor support.
- Unsupported worksurface spans of 60"W-84"W require an external worksurface support channel. It is recommended for 48"W-60"W.
- Cantilevers only to be used on worksurface runs 48"W or less.

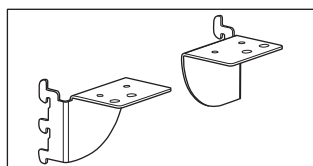

Worksurface bracket kit allows one end of a worksurface to be supported by a return panel. Return panel width must be the same as the depth of the worksurface.

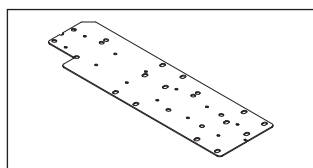

Flat brackets can be used to connect one worksurface perpendicular to another work-surface.

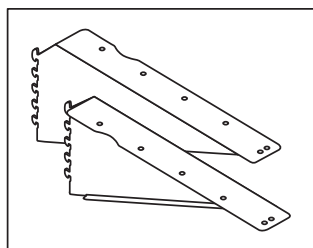

Cantilever brackets are left or right handed. They can be inserted into panel reveals in 1" vertical increments. One size is used for both 24" and 30"D worksurfaces. 18" Cantilever brackets are used for 18"D worksurfaces. Both left and right brackets are required in shared applications.

Important: Do not use cantilever brackets at the end of a worksurface where no 90° return panel is positioned.

- Do not use to support worksurfaces from which a hanging pedestal is suspended, or which a peninsula worksurface is attached.
- Do not use to support worksurfaces supported with permanent wall hanger kit.

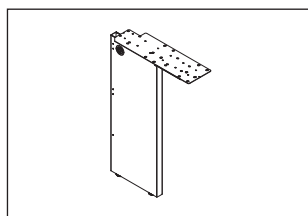

Universal support legs are used to support worksurfaces only in a shared position.

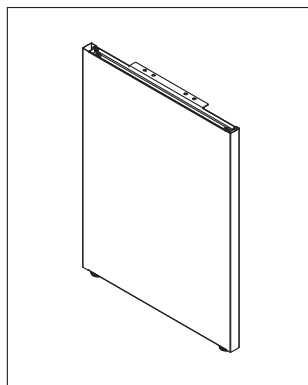

End-panel supports are used in place of return panels at the end of worksurface runs. Straight worksurfaces adjacent to 120° connections must be supported by full end panels. End-panel supports are ordered for right- or left-handed application. Leveling glides provide 1 1/2" of adjustment.

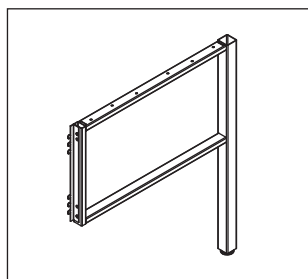

Open Leg models are used to support various worksurface configurations and include attaching hardware and leveling glides.

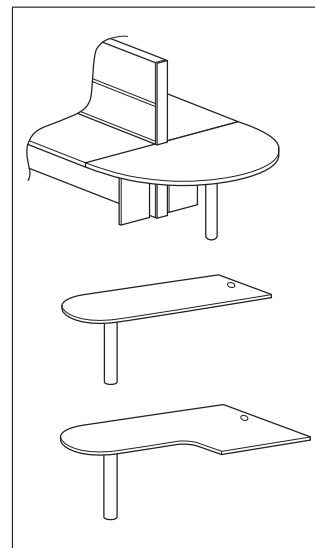

D-Shaped, Peninsula and Jetty worksurfaces require support columns (ordered separately).

Countertops are available in straight or corner configurations. Mounting hardware is included.

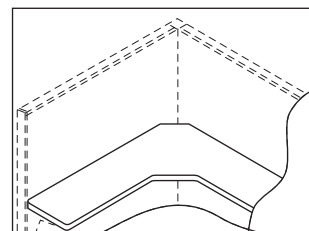

Corner shelves are available in T-Mold or Edgeband options. Attachment brackets are included.

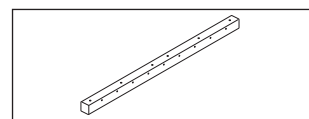

- Unsupported worksurface spans of 60"W-84"W require an external worksurface support channel. It is recommended for 48"W-60"W.

EXTERNAL CHANNEL SELECTION GUIDE

Support Combination		Rectangle Worksurface Width			
		54	60	66	72
Worksurface End Support 1	Worksurface End Support 2	Recommended	Required	Required	Required
	End Panel	End Panel	42"	48"	54"
End Panel	Pedestal	NA	NA	NA	42"
End Panel	Worksurface Brackets	42"	48"	54"	60"
End Panel	Cantilever	42"	48"	54"	60"
End Panel	Open Leg	42"	48"	54"	60"
Pedestal	Pedestal	NA	NA	NA	NA
Pedestal	Worksurface Brackets	NA	NA	NA	42"
Pedestal	Cantilever	NA	NA	NA	42"
Pedestal	Open Leg	NA	NA	NA	42"
Worksurface Brackets	Worksurface Brackets	42"	48"	54"	60"
Worksurface Brackets	Cantilever	42"	48"	54"	60"
Worksurface Brackets	Open Leg	42"	48"	54"	60"

See page 184 for External Channel models. Supports above are recommended for worksurfaces 54"W or 60"W. For 66"-72" worksurfaces, the supports are required.

- ▶ Worksurfaces may be used with Accelerate®, Abound® and Voi® products.
- ▶ Worksurfaces are constructed of laminate on 1/8" solid core high-performance particleboard.
- ▶ Specify T or P after the model number for T-mold or Edgeband options.
- ▶ Models up to 42"W are standard with one centered grommet. Models 48"W and wider are standard with two grommets.
- ▶ Accelerate® adds a "C" prefix and "T" suffix and Abound® adds a "B" prefix and "T" suffix to the Model Number for primary worksurfaces to span a TEE or EXTENDED STRAIGHT connection. Add upcharge of \$30 List per model.
- ▶ Add suffix "N" to Model Number for worksurfaces with no grommets. No upcharge.
- ▶ Add suffix "S" to Model Number before edge detail selection for worksurfaces with scallops. No upcharge.
- ▲ **EXTENDED STRAIGHT worksurfaces are available with grommets only.**
- ▲ **Use edgeband only with Voi® supports.**
- ▲ **60"W, 66"W and 72"W worksurfaces require one or more of the following: worksurface support brackets, end panel, external channel universal support leg or pedestal support in conjunction with cantilever brackets.**
- ▲ **T-mold worksurfaces cannot be used with Voi®.**
- ▲ **If the panel is a greater dimension than the worksurface and the run of worksurfaces is greater than 6 feet, a floor support or worksurface bracket is required.**
- ▲ **When a run of worksurfaces equals or exceeds 6 feet, a floor support is required for worksurface structural assurance.**
- ▲ **All worksurfaces load tested to BIFMA standards.**

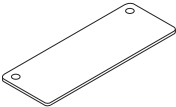
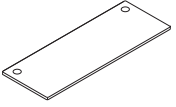

Description	Model	Ship Weight	Cube	L1 List Price		L2 List Price		
				"T"	"P"	"T"	"P"	
T-Mold Edge	Primary and/or Return Worksurfaces							
	24"W x 18"D	HWR1824(?)	23	2.1	\$ 242	\$ 280	\$ 252	\$ 290
	30"W x 18"D	HWR1830(?)	28	2.1	\$ 250	\$ 290	\$ 260	\$ 300
	36"W x 18"D	HWR1836(?)	35	2.5	\$ 259	\$ 300	\$ 269	\$ 310
	42"W x 18"D	HWR1842(?)	39	2.8	\$ 270	\$ 311	\$ 280	\$ 321
	48"W x 18"D	HWR1848(?)	44	3.2	\$ 298	\$ 345	\$ 308	\$ 355
	54"W x 18"D	HWR1854(?)	48	4.0	\$ 331	\$ 383	\$ 346	\$ 398
	60"W x 18"D	HWR1860(?)	53	4.0	\$ 342	\$ 393	\$ 357	\$ 408
	66"W x 18"D	HWR1866(?)	65	4.7	\$ 367	\$ 422	\$ 382	\$ 437
	72"W x 18"D	HWR1872(?)	67	4.7	\$ 376	\$ 433	\$ 391	\$ 448
Edgeband								
	24"W x 24"D	HWR2424(?)	31	2.2	\$ 246	\$ 286	\$ 256	\$ 296
	30"W x 24"D	HWR2430(?)	37	2.2	\$ 254	\$ 299	\$ 264	\$ 309
	36"W x 24"D	HWR2436(?)	46	2.5	\$ 267	\$ 324	\$ 282	\$ 339
	42"W x 24"D	HWR2442(?)	52	2.5	\$ 310	\$ 356	\$ 325	\$ 371
	48"W x 24"D	HWR2448(?)	58	3.3	\$ 329	\$ 379	\$ 344	\$ 394
	54"W x 24"D	HWR2454(?)	64	4.0	\$ 351	\$ 401	\$ 371	\$ 421
	60"W x 24"D	HWR2460(?)	70	4.0	\$ 383	\$ 447	\$ 403	\$ 467
	66"W x 24"D	HWR2466(?)	86	4.8	\$ 409	\$ 480	\$ 429	\$ 500
	72"W x 24"D	HWR2472(?)	89	4.8	\$ 430	\$ 496	\$ 450	\$ 516

W=panel width
D=worksurface depth

How to specify	1st Option	2nd Option	3rd Option
Select Model Number from above	Select Laminate	Select Edge Color	Select Grommet Color
Select Edge Profile	See page 349	See page 349	See page 349
T Thin T-Mold P Edgeband			
For Tee-Span or Extended straight connection: Accelerate® adds a "C" prefix and "T" suffix (\$30 upcharge per model)			
Abound® adds a "B" prefix and "T" suffix (\$30 upcharge per model)			
Scalloped Option: Add "S" suffix before edge detail selection (no upcharge)			
No Grommet option: Add "N" suffix (no upcharge)			
H W R 2 4 2 4 T .	A 5 .	K .	T 1
H C W R 2 4 2 4 T T .	A 5 .	K .	T 1
H B W R 2 4 2 4 T T .	A 5 .	K .	T 1
H W R 2 4 2 4 S T .	A 5 .	K 	
H W R 2 4 2 4 T N .	A 5 .	K 	

Systems Worksurfaces — Primary

GSA SIN 711-1



- ▶ Worksurfaces may be used with Accelerate®, Abound® and Voi® products.
- ▶ Worksurfaces are constructed of laminate on 1 1/8" solid core high-performance particleboard.
- ▶ Specify T or P after the model number for T-mold or Edgeband options.
- ▶ Models up to 42"W are standard with one centered grommet. Models 48"W and wider are standard with two grommets.
- ▶ Accelerate® adds a "C" prefix and "T" suffix and Abound® adds a "B" prefix and "T" suffix to the Model Number for primary worksurfaces to span a TEE or EXTENDED STRAIGHT connection. Add upcharge of \$30 List per model.
- ▶ Add suffix "N" to Model Number for worksurfaces with no grommets. No upcharge.
- ▶ Add suffix "S" to Model Number before edge detail selection for worksurfaces with scallops. No upcharge.
- ▶ **EXTENDED STRAIGHT worksurfaces are available with grommets only.**
- ▲ **Use edgeband only with Voi® supports.**
- ▲ **60"W, 66"W and 72"W worksurfaces require one or more of the following: worksurface support brackets, end panel, external channel universal support leg or pedestal support in conjunction with cantilever brackets.**
- ▲ **T-mold worksurfaces cannot be used with Voi®.**
- ▲ **If the panel is a greater dimension than the worksurface and the run of worksurfaces is greater than 6 feet, a floor support or worksurface bracket is required.**
- ▲ **When a run of worksurfaces equals or exceeds 6 feet, a floor support is required for worksurface structural assurance.**
- ▲ **All worksurfaces load tested to BIFMA standards.**

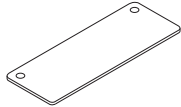
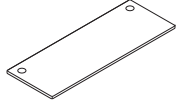

Description	Model	Ship Weight	Cube	L1 List Price		L2 List Price	
				"T"	"P"	"T"	"P"
T-Mold Edge	Primary and/or Return Worksurfaces						
	24"W x 30"D	47	2.2	\$ 259	\$ 299	\$ 271	\$ 311
	30"W x 30"D	56	2.6	\$ 264	\$ 345	\$ 276	\$ 357
	36"W x 30"D	62	3.1	\$ 288	\$ 364	\$ 303	\$ 379
	42"W x 30"D	64	3.6	\$ 337	\$ 388	\$ 352	\$ 403
	48"W x 30"D	68	4.0	\$ 355	\$ 408	\$ 370	\$ 423
	54"W x 30"D	80	5.0	\$ 384	\$ 439	\$ 404	\$ 459
	60"W x 30"D	101	5.0	\$ 423	\$ 487	\$ 443	\$ 507
	66"W x 30"D	105	6.0	\$ 448	\$ 520	\$ 468	\$ 540
	72"W x 30"D	105	6.0	\$ 477	\$ 556	\$ 497	\$ 576
Edgeband							
							

W=panel width
D=worksurface depth

EXTERNAL CHANNEL SELECTION GUIDE							
Support Combination		Rectangle Worksurface Width					
Worksurface End Support 1	Worksurface End Support 2	54	60	66	72	84	
End Panel	End Panel	42"	48"	54"	60"	72"	
End Panel	Pedestal	NA	NA	NA	42"	48"	
End Panel	Worksurface Brackets	42"	48"	54"	60"	72"	
End Panel	Cantilever	42"	48"	54"	60"	72"	
End Panel	Open Leg	42"	48"	54"	60"	72"	
Pedestal	Pedestal	NA	NA	NA	NA	NA	
Pedestal	Worksurface Brackets	NA	NA	NA	42"	48"	
Pedestal	Cantilever	NA	NA	NA	42"	48"	
Pedestal	Open Leg	NA	NA	NA	42"	48"	
Worksurface Brackets	Worksurface Brackets	42"	48"	54"	60"	72"	
Worksurface Brackets	Cantilever	42"	48"	54"	60"	72"	
Worksurface Brackets	Open Leg	42"	48"	54"	60"	72"	

See page 184 for External Channel models.

How to specify	1st Option	2nd Option	3rd Option
Select Model Number from above	Select Laminate	Select Edge Color	Select Grommet Color
Select Edge Profile	See page 349	See page 349	See page 349
T Thin T-Mold P Edgeband			
For Tee-Span or Extended straight connection: Accelerate® adds a "C" prefix and "T" suffix (\$30 upcharge per model) Abound® adds a "B" prefix and "T" suffix (\$30 upcharge per model) Scallop Option: Add "S" suffix before edge detail selection (no upcharge) No Grommet option: Add "N" suffix (no upcharge)			
HWR 3 0 2 4 T .	A 5 .	K .	T 1
HCWR 3 0 2 4 TT .	A 5 .	K .	T 1
H B WR 3 0 2 4 TT .	A 5 .	K .	T 1
HWR 3 0 2 4 ST .	A 5 .	K .	
HWR 3 0 2 4 TN .	A 5 .	K .	

Icon Legend on page 10

- ▶ Worksurfaces may be used with Accelerate®, Abound® and Voi® products.
- ▶ Worksurfaces are constructed of laminate on 1½" solid core particleboard.
- ▶ Refer to Worksurface Supports, pages 414-417.
- ▶ Universal support leg can be used to share support when worksurfaces are placed side-by-side.
- ▶ Add suffix "N" to Model Number for worksurfaces with no grommets. No upcharge.
- ▶ Add suffix "S" to Model Number before edge detail selection for worksurfaces with scallops. No upcharge.
- ▶ Curvilinear surfaces specified with edgeband will have a T-mold edge on curved areas of the worksurface.
- ▶ T-mold worksurfaces cannot be used with Voi®.
- ▶ Use edgeband only with Voi® supports.
- ▶ 60"W, 66"W and 72"W worksurfaces require one or more of the following: worksurface support brackets, end panel, external channel universal support leg or pedestal support in conjunction with cantilever brackets. A full end panel can also be used for support in place of cantilever brackets.
- ▶ If the panel is a greater dimension than the worksurface and the run of worksurfaces is greater than 6 feet, a floor support or worksurface bracket is required.
- ▶ When a run of worksurfaces equals or exceeds 6 feet, a floor support is required for worksurface structural assurance.



Description	S	Model	Ship Weight	Cube	L1 List Price		L2 List Price	
					"T"	"P"	"T"	"P"
T-Mold Edge								
Wave Worksurfaces								
30"W x 24"D ¹ x 30"D ²	11½"	HWW30AB(?)	36	2.6	\$ 258	\$ 389	\$ 270	\$ 401
36"W x 24"D ¹ x 30"D ²	13½"	HWW36AB(?)	42	3.1	\$ 293	\$ 419	\$ 308	\$ 434
42"W x 24"D ¹ x 30"D ²	15½"	HWW42AB(?)	43	3.6	\$ 371	\$ 445	\$ 386	\$ 460
48"W x 24"D ¹ x 30"D ²	15½"	HWW48AB(?)	48	4.0	\$ 396	\$ 472	\$ 411	\$ 487
54"W x 24"D ¹ x 30"D ²	21½"	HWW54AB(?)	54	5.0	\$ 441	\$ 514	\$ 461	\$ 534
60"W x 24"D ¹ x 30"D ²	27½"	HWW60AB(?)	57	5.0	\$ 473	\$ 565	\$ 493	\$ 585
66"W x 24"D ¹ x 30"D ²	33½"	HWW66AB(?)	66	6.0	\$ 513	\$ 603	\$ 533	\$ 623
72"W x 24"D ¹ x 30"D ²	39½"	HWW72AB(?)	74	6.0	\$ 555	\$ 648	\$ 575	\$ 668

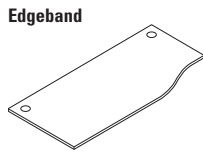

W=panel width
D=worksurface depth

T-Mold Edge								
30"W x 24"D ¹ x 30"D ²	11½"	HWW30BA(?)	36	2.6	\$ 258	\$ 389	\$ 270	\$ 401
36"W x 24"D ¹ x 30"D ²	13½"	HWW36BA(?)	42	3.1	\$ 293	\$ 419	\$ 308	\$ 434
42"W x 24"D ¹ x 30"D ²	15½"	HWW42BA(?)	43	3.6	\$ 371	\$ 445	\$ 386	\$ 460
48"W x 24"D ¹ x 30"D ²	15½"	HWW48BA(?)	48	4.0	\$ 396	\$ 472	\$ 411	\$ 487
54"W x 24"D ¹ x 30"D ²	21½"	HWW54BA(?)	54	5.0	\$ 441	\$ 514	\$ 461	\$ 534
60"W x 24"D ¹ x 30"D ²	27½"	HWW60BA(?)	57	5.0	\$ 473	\$ 565	\$ 493	\$ 585
66"W x 24"D ¹ x 30"D ²	33½"	HWW66BA(?)	66	6.0	\$ 513	\$ 603	\$ 533	\$ 623
72"W x 24"D ¹ x 30"D ²	39½"	HWW72BA(?)	74	6.0	\$ 555	\$ 648	\$ 575	\$ 668

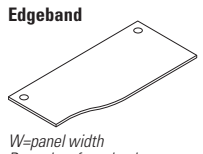

W=panel width
D=worksurface depth

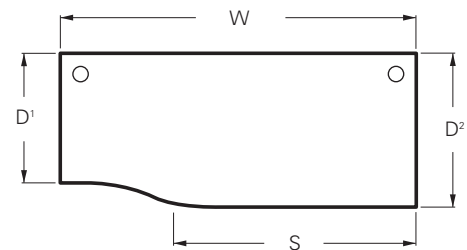
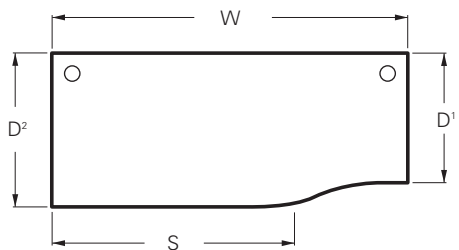

See matrix on page 396.

How to specify	1st Option	2nd Option	3rd Option
Select Model Number from above	Select Laminate	Select Edge Color	Select Grommet Color
Select Edge Profile	See page 349	See page 349	See page 349
T Thin T-Mold P Edgeband			
No Grommet option: Add "N" suffix (no upcharge)			
Scalloped Option: Add "S" suffix before edge detail selection (no upcharge)			
H W W 3 0 A B S T .	A 5 .	K	
H W W 3 0 A B T .	A 5 .	K .	T 1
H W W 3 0 A B T N .	A 5 .	K	

Systems Worksurfaces — Wedge

GSA SIN 711-1



- ▶ Worksurfaces may be used with Accelerate®, Abound® and Voi® products.
- ▶ Worksurfaces are constructed of laminate on 1 1/8" solid core particleboard.
- ▶ Refer to Worksurface Supports, pages 414-417.
- ▶ Universal support leg can be used to share support when worksurfaces are placed side-by-side.
- ▶ Add suffix "N" to Model Number for worksurfaces with no grommets. No upcharge.
- ▶ Add suffix "S" to Model Number before edge detail selection for worksurfaces with scallops. No upcharge.
- ⚠ 60"W, 66"W and 72"W worksurfaces require one or more of the following: worksurface support brackets, end panel, external channel universal support leg or pedestal support in conjunction with cantilever brackets. A full end panel can also be used for support in place of cantilever brackets.
- ⚠ Use edgeband only with Voi® supports.
- ⚠ When a run of worksurfaces equals or exceeds 6 feet, a floor support is required for worksurface structural assurance.
- ⚠ T-mold worksurfaces cannot be used with Voi®.

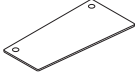
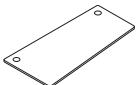

Description	Model	Ship Weight	Cube	L1 List Price		L2 List Price	
				"T"	"P"	"T"	"P"
 Wedge Worksurfaces 48"A x 24"B x 30"C 54"A x 24"B x 30"C 60"A x 24"B x 30"C 66"A x 24"B x 30"C 72"A x 24"B x 30"C	HWD244830(?)	64	4.8	\$ 453	\$ 520	\$ 468	\$ 535
	HWD245430(?)	80	4.8	\$ 488	\$ 559	\$ 508	\$ 579
	HWD246030(?)	101	4.8	\$ 522	\$ 598	\$ 542	\$ 618
	HWD246630(?)	105	5.7	\$ 557	\$ 637	\$ 577	\$ 657
	HWD247230(?)	109	5.7	\$ 591	\$ 679	\$ 611	\$ 699
 Wedge Worksurfaces 48"A x 30"B x 24"C 54"A x 30"B x 24"C 60"A x 30"B x 24"C 66"A x 30"B x 24"C 72"A x 30"B x 24"C	HWD304824(?)	64	4.8	\$ 453	\$ 520	\$ 468	\$ 535
	HWD305424(?)	80	4.8	\$ 488	\$ 559	\$ 508	\$ 579
	HWD306024(?)	101	4.8	\$ 522	\$ 598	\$ 542	\$ 618
	HWD306624(?)	105	5.7	\$ 557	\$ 637	\$ 577	\$ 657
	HWD307224(?)	109	5.7	\$ 591	\$ 679	\$ 611	\$ 699

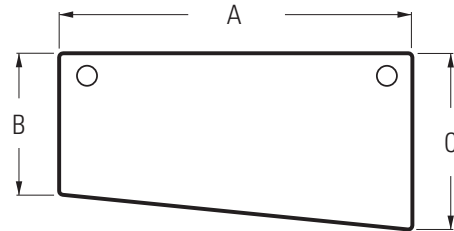
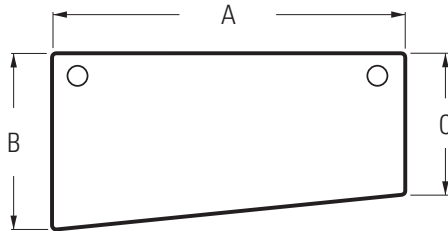

See matrix on page 396.

How to specify	1st Option	2nd Option	3rd Option
Select Model Number from above Select Edge Profile T Thin T-Mold P Edgeband No Grommet option: Add "N" suffix (no upcharge) Scalloped Option: Add "S" suffix before edge detail selection (no upcharge)	Select Laminate See page 349	Select Edge Color See page 349	Select Grommet Color See page 349
HWD 2 4 4 8 3 0 S T .	A 5 .	K	
HWD 2 4 4 8 3 0 T .	A 5 .	K .	T 1
HWD 2 4 4 8 3 0 T N .	A 5 .	K	

▶ Worksurfaces may be used with Accelerate®, Abound® and Voi® products.

▶ Add suffix "N" to Model Number for worksurfaces with no grommets. No upcharge.

▶ Add suffix "S" to Model Number before edge detail selection for worksurfaces with scallops. No upcharge.

▶ Worksurfaces are constructed of laminate on 1/8" solid core high-performance particleboard.
 ▶ Specify T or P after the model number for T-mold or Edgeband options.
 ▶ Refer to Worksurface Supports, pages 414-417.

⚠ **Curvilinear surfaces specified with edgeband will have a T-mold edge on curved areas of the worksurface.**
 ⚠ **T-mold worksurfaces cannot be used with Voi®.**

⚠ **Use edgeband only with Voi® supports.**



Description	Model	Ship Weight	Cube	L1 List Price		L2 List Price	
				"T"	"P"	"T"	"P"
T-Mold Edge Corner Worksurfaces with Curved User Edge							
36"W x 24"D	HWC3624(?)	53	3.7	\$ 489	\$ 508	\$ 504	\$ 523
42"W x 24"D	HWC4224(?)	65	4.9	\$ 537	\$ 538	\$ 552	\$ 553
48"W x 24"D	HWC4824(?)	76	6.3	\$ 568	\$ 604	\$ 583	\$ 619
42"W x 30"D	HWC4230(?)	72	6.3	\$ 606	\$ 631	\$ 621	\$ 646
48"W x 30"D	HWC4830(?)	77	6.3	\$ 645	\$ 681	\$ 660	\$ 696

- HWC3624(?) will not accept the H4022, H4028, or H4029 keyboard platforms.
- One small worksurface bracket standard with each worksurface.

⚠ **Corner worksurfaces must match exactly the panel behind them, i.e.: a 36" panel must be used on the back two sides of model HWC3624(?).**

Edgeband

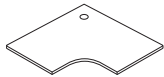

W=panel width
D=worksurface depth

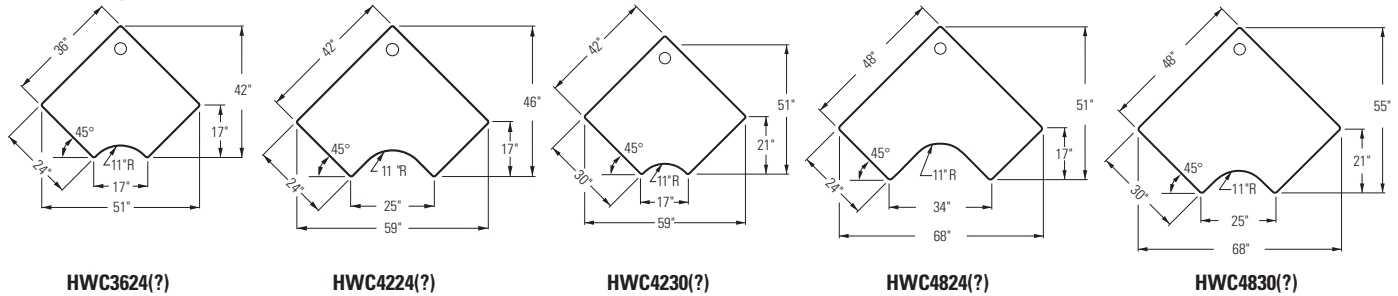

How to specify	1st Option	2nd Option	3rd Option
<p>Select Model Number from above</p> <p>Select Edge Profile</p> <p>T Thin T-Mold P Edgeband</p> <p>No Grommet option: Add "N" suffix (no upcharge)</p> <p>Scalloped Option: Add "S" suffix before edge detail selection (no upcharge)</p>	<p>Select Laminate</p> <p>See page 349</p>	<p>Select Edge Color</p> <p>See page 349</p>	<p>Select Grommet Color</p> <p>See page 349</p>
HWC3624ST	A5	K	
HWC4224T	A5	K	T1
HWC4824TN	A5	K	

Systems Worksurfaces — Corner

GSA SIN 711-1



- ▶ Worksurfaces may be used with Accelerate®, Abound® and Voi® products.
- ▶ Add suffix “N” to Model Number for worksurfaces with no grommets. No upcharge.
- ▶ Add suffix “S” to Model Number before edge detail selection for worksurfaces with scallops. No upcharge.
- ▶ Worksurfaces are constructed of laminate on 1/8” solid core high-performance particleboard.
- ▶ Refer to Worksurface Supports, pages 414-417.
- ▶ Specify T or P after the model number for T-mold or Edgeband options.

△ Use edgeband only with Voi® supports.
 △ T-mold worksurfaces cannot be used with Voi®.



Description	Model	Ship Weight	Cube	L1 List Price		L2 List Price	
				“T”	“P”	“T”	“P”
T-Mold Edge Corner Worksurfaces with Straight User Edge							
36”W x 24”D	HWCS3624(?)	53 [S]	3.7	\$ 459	\$ 489	\$ 474	\$ 504
42”W x 24”D	HWCS4224(?)	65 [S]	4.9	\$ 518	\$ 511	\$ 533	\$ 526
48”W x 24”D	HWCS4824(?)	76	6.3	\$ 553	\$ 566	\$ 568	\$ 581
42”W x 30”D	HWCS4230(?)	72	6.3	\$ 561	\$ 617	\$ 576	\$ 632
48”W x 30”D	HWCS4830(?)	77	6.3	\$ 632	\$ 626	\$ 647	\$ 641

Edgeband

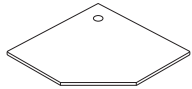

W=panel width
D=worksurface depth

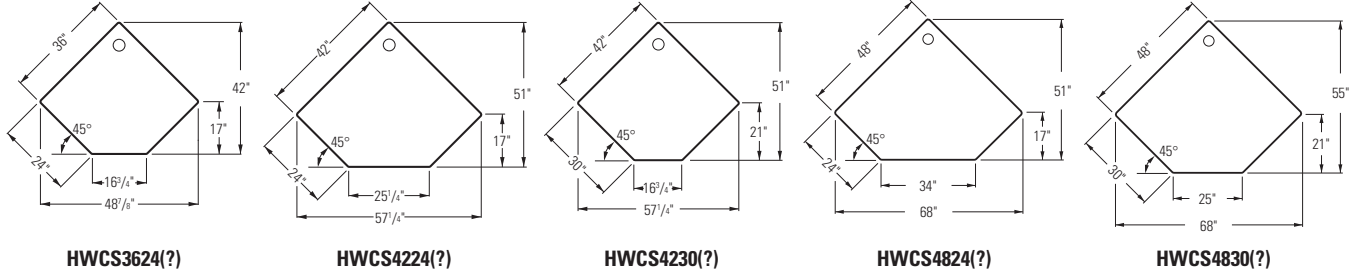

△ Corner worksurfaces must match exactly the panel behind them, i.e.: a 36” panel must be used on the back two sides of model HWCS3624(?).

- HWCS3624(?) will not accept the H4022, H4028, or H4029 keyboard platforms.
- One small worksurface bracket standard with each worksurface.

How to specify	1st Option	2nd Option	3rd Option
<p>Select Model Number from above</p> <p>Select Edge Profile</p> <p>T Thin T-Mold P Edgeband</p> <p>No Grommet option: Add “N” suffix (no upcharge)</p> <p>Scalloped Option: Add “S” suffix before edge detail selection (no upcharge)</p> <p>HWCS3624ST .</p> <p>HWCS4224T .</p> <p>HWCS4230TN .</p>	<p>Select Laminate</p> <p>See page 349</p> <p>A5 .</p> <p>A5 .</p> <p>A5 .</p>	<p>Select Edge Color</p> <p>See page 349</p> <p>K</p> <p>K .</p> <p>K</p>	<p>Select Grommet Color</p> <p>See page 349</p> <p>T1</p>

A_B_I, Voi, Level, S Icon Legend on page 10

▶ Worksurfaces may be used with Accelerate®, Abound® and Voi® products.

▶ Worksurfaces are constructed of laminate on 1/8" solid core high-performance particleboard.

⚠ **Curvilinear surfaces specified with edgeband will have a T-mold edge on curved areas of the work surface.**

⚠ **T-mold worksurfaces cannot be used with Voi®.**



Edgeband

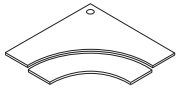

W=panel width
D=work surface depth

Description

Split Top Corner Worksurfaces with Curved User Edge
42"W x 24"D

- Two cantilever brackets standard per work surface.
- One small work surface bracket standard with each work surface.

⚠ **Available in edgeband with grommet only.**

⚠ **Corner worksurfaces must match exactly the panel behind them, i.e.: a 42" panel must be used on the back two sides of model HWSC4224P.**

⚠ **Requires adjustable height mechanism. Must order separately, see below.**

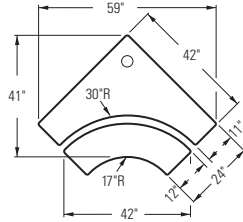

HWSC4224P

Model	Ship Weight	Cube	L1 List Price	L2 List Price
HWSC4224P	65	4.9	\$ 671	\$ 686

- ▶ Stable, durable design.
- ▶ Supports large widths and can be customized for workstations.

- ▶ Slim arms for better knee clearance.
- ▶ Height adjustable within 19" range (12.5" above and 6.5" below work surface).

- ▶ 30" platform tilt feature (15° positive and 15° negative tilt).



Description

Adjustable Height Mechanism

- Corner work surface and adjustable height mechanism are ordered and shipped separately.

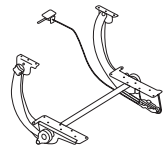

Model	Ship Weight	Cube	List
HHKHS100	40	2.4	\$ 658

How to specify

Select Model Number from above	1st Option Select Laminate	2nd Option Select Edge Color	3rd Option Select Grommet Color
See page 349 H W S C 4 2 2 4 P .	See page 349 A 5 .	See page 349 K .	See page 349 T 1

Icon Legend on page 10

Systems Worksurfaces — 120 Degree Corner

GSA SIN 711-1



- ▶ Worksurfaces are constructed of laminate on 1/8" solid core high-performance particleboard.
- ▶ Specify T or P after the model number for T-mold or Edgeband options.
- ▶ Add suffix "N" to Model Number for worksurfaces with no grommets. No upcharge.
- ▶ Add suffix "S" to Model Number before edge detail selection for worksurfaces with scallops. No upcharge.
- ▶ Cannot use keyboard tray or pedestal under 120 degree corner worksurface.
- ▶ Refer to Worksurface Supports, pages 414-417.
- ▶ If used at an end of run, full end panel needs to be ordered — see page 414.
- △ Curvilinear surfaces specified with edgeband will have a T-mold edge on curved areas of the worksurface.
- △ T-mold worksurfaces cannot be used with Voi®.



Description	Model	Ship Weight	Cube	L1 List Price		L2 List Price	
				"T"	"P"	"T"	"P"
T-Mold Edge	Abound® and Accelerate® 120 Degree Corner Worksurfaces with Curved User Edge						
36"W x 24"D	HBWCT3624(?)	75	7.7	\$ 643	\$ 729	\$ 658	\$ 744
42"W x 24"D	HBWCT4224(?)	96	9.2	\$ 746	\$ 781	\$ 761	\$ 796
48"W x 24"D	HBWCT4824(?)	107	9.2	\$ 773	\$ 906	\$ 788	\$ 921
42"W x 30"D	HBWCT4230(?)	102	11.4	\$ 773	\$1027	\$ 788	\$1042
48"W x 30"D	HBWCT4830(?)	112	11.4	\$ 803	\$1092	\$ 818	\$1107

- HBWCT3624(?) will not accept the H4022, HE4022, H4028, or H4029 keyboard platforms.
- One small worksurface bracket standard with each worksurface.

△ **Corner worksurfaces must match exactly the panel behind them, i.e.: a 36" panel must be used on the back two sides of model HBWCT3624(?).**

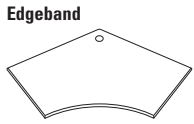

W=panel width
D=worksurface depth

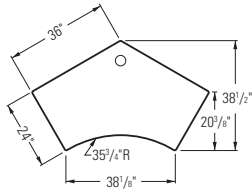

HBWCT3624(?)

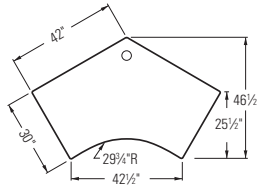

HBWCT4230(?)

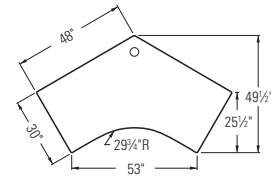

HBWCT4830(?)

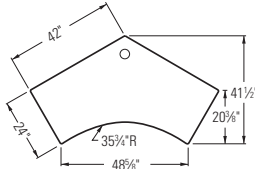

HBWCT4224(?)

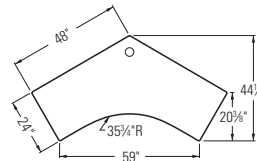

HBWCT4824(?)

How to specify	1st Option	2nd Option	3rd Option
Select Model Number from above	Select Laminate	Select Edge Color	Select Grommet Color
Select Edge Profile	See page 349	See page 349	See page 349
T Thin T-Mold P Edgeband			
No Grommet option: Add "N" suffix (no upcharge)			
Scalloped Option: Add "S" suffix before edge detail selection (no upcharge)			
H B W C T 3 6 2 4 S T .	A 5 .	K	
H B W C T 3 6 2 4 T N .	A 5 .	K	
H B W C T 3 6 2 4 T .	A 5 .	K .	T 1

ABJ HON level Icon Legend on page 10

▶ Worksurfaces may be used with Accelerate®, Abound® and Voi® products.

▶ Worksurfaces are constructed of laminate on 1/8" solid core high-performance particleboard.
▶ Includes a rear-support bracket in Charcoal only.

▶ Add suffix "N" to Model Number for worksurfaces with no grommets. No upcharge.
▶ Add suffix "S" to Model Number before edge detail selection for worksurfaces with scallops. No upcharge.
▶ Refer to Worksurface Supports, pages 414-417.

⚠ T-mold worksurfaces cannot be used with Voi®.
⚠ Panel-hung application requires two panels of corresponding width joined at 90°.
⚠ When a run of worksurfaces equals or exceeds 6 feet, a floor support is required for worksurface structural assurance.
⚠ Use edgeband only with Voi® supports.

⚠ 60"W, 66"W and 72"W worksurfaces require one or more of the following: worksurface support brackets, end panel, external channel universal support leg or pedestal support in conjunction with cantilever brackets.

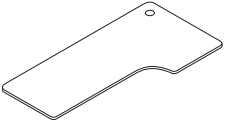
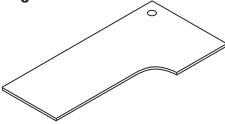
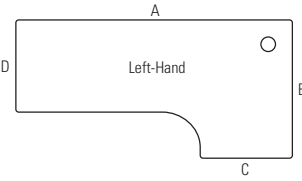
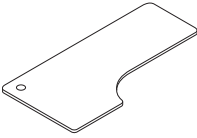
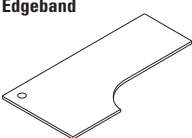
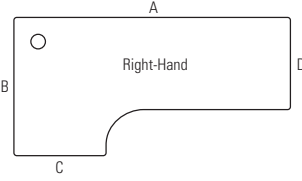

Description		Model	Ship Weight	Cube	L1 List Price		L2 List Price	
					"T"	"P"	"T"	"P"
T-Mold Edge	Corner Cove Worksurfaces, Left Hand							
	60"A x 36"B x 24"C x 24"D	HWV73AAL(?)	67	5.9	\$ 541	\$ 572	\$ 566	\$ 597
	60"A x 36"B x 30"C x 24"D	HWV73BAL(?)	76	5.9	\$ 564	\$ 591	\$ 589	\$ 616
	60"A x 48"B x 24"C x 24"D	HWV75AAL(?)	85	7.7	\$ 623	\$ 626	\$ 653	\$ 656
	60"A x 48"B x 24"C x 30"D	HWV75ABL(?)	94	7.7	\$ 646	\$ 649	\$ 676	\$ 679
	60"A x 48"B x 30"C x 24"D	HWV75BAL(?)	92	7.7	\$ 646	\$ 649	\$ 676	\$ 679
	60"A x 48"B x 30"C x 30"D	HWV75BBL(?)	99	7.7	\$ 669	\$ 672	\$ 699	\$ 702
Edgeband	72"A x 36"B x 24"C x 24"D	HWV93AAL(?)	75	7.0	\$ 623	\$ 626	\$ 653	\$ 656
	72"A x 36"B x 30"C x 24"D	HWV93BAL(?)	83	7.0	\$ 646	\$ 649	\$ 676	\$ 679
	72"A x 48"B x 24"C x 24"D	HWV95AAL(?)	96	9.2	\$ 778	\$ 782	\$ 813	\$ 817
	72"A x 48"B x 24"C x 30"D	HWV95ABL(?)	107	9.2	\$ 803	\$ 804	\$ 838	\$ 839
	72"A x 48"B x 30"C x 24"D	HWV95BAL(?)	102	9.2	\$ 803	\$ 804	\$ 838	\$ 839
	72"A x 48"B x 30"C x 30"D	HWV95BBL(?)	112	9.2	\$ 825	\$ 830	\$ 860	\$ 865
								
T-Mold Edge	Corner Cove Worksurfaces, Right Hand							
	60"A x 36"B x 24"C x 24"D	HWV73AAR(?)	67	5.9	\$ 541	\$ 572	\$ 566	\$ 597
	60"A x 36"B x 30"C x 24"D	HWV73BAR(?)	76	5.9	\$ 564	\$ 591	\$ 589	\$ 616
	60"A x 48"B x 24"C x 24"D	HWV75AAR(?)	85	7.7	\$ 623	\$ 626	\$ 653	\$ 656
	60"A x 48"B x 24"C x 30"D	HWV75ABR(?)	94	7.7	\$ 646	\$ 649	\$ 676	\$ 679
	60"A x 48"B x 30"C x 24"D	HWV75BAR(?)	92	7.7	\$ 646	\$ 649	\$ 676	\$ 679
	60"A x 48"B x 30"C x 30"D	HWV75BBR(?)	99	7.7	\$ 669	\$ 672	\$ 699	\$ 702
Edgeband	72"A x 36"B x 24"C x 24"D	HWV93AAR(?)	75	7.0	\$ 623	\$ 626	\$ 653	\$ 656
	72"A x 36"B x 30"C x 24"D	HWV93BAR(?)	83	7.0	\$ 646	\$ 649	\$ 676	\$ 679
	72"A x 48"B x 24"C x 24"D	HWV95AAR(?)	96	9.2	\$ 778	\$ 782	\$ 813	\$ 817
	72"A x 48"B x 24"C x 30"D	HWV95ABR(?)	107	9.2	\$ 803	\$ 804	\$ 838	\$ 839
	72"A x 48"B x 30"C x 24"D	HWV95BAR(?)	102	9.2	\$ 803	\$ 804	\$ 838	\$ 839
	72"A x 48"B x 30"C x 30"D	HWV95BBR(?)	112	9.2	\$ 825	\$ 830	\$ 860	\$ 865
								

How to specify	1st Option	2nd Option	3rd Option
Select Model Number from above	Select Laminate	Select Edge Color	Select Grommet Color
Select Edge Profile	See page 349	See page 349	See page 349
T Thin T-Mold P Edgeband			
No Grommet option: Add "N" suffix (no upcharge)			
Scalloped Option: Add "S" suffix before edge detail selection (no upcharge)			
H W V 7 3 A A L S T .	A 5 .	K 	
H W V 7 3 A A L T .	A 5 .	K .	T 1
H W V 7 3 A A L T N .	A 5 .	K 	

- ▶ Worksurfaces may be used with Accelerate®, Abound® and Voi® products.
 - ▶ Specify T or P after the model number for T-mold or Edgeband options.
 - ▶ Worksurfaces are constructed of laminate on 1/8" solid core high-performance particleboard.
 - ▶ Order support column separately — see page 415.
 - ▶ Can also be attached perpendicular to a primary worksurface using Flat Brackets. Do not attach to a worksurface supported with Cantilever Brackets.
 - ▶ Add suffix "N" to Model Number for worksurfaces with no grommets. No upcharge.
 - ▶ Add suffix "S" to Model Number before edge detail selection for worksurfaces with scallops. No upcharge.
 - ▶ Refer to Worksurface Supports, pages 414-417.
- ▲ **Use edgeband only with Voi® supports.**

- ▲ **Curvilinear surfaces specified with edgeband will have a T-mold edge on curved areas of the worksurface.**
- ▲ **T-mold worksurfaces cannot be used with Voi®.**
- ▲ **Not designed to be used freestanding.**



	Description	Model	Ship		L1 List Price		L2 List Price	
			Weight	Cube	"T"	"P"	"T"	"P"
T-Mold Edge 	Jetty Worksurfaces, Left Hand							
	48" A x 66" B x 24" C x 30" D	HWJ58ABL(?)	84	9.2	\$ 571	\$ 786	\$ 601	\$ 816
	48" A x 66" B x 30" C x 30" D	HWJ58BBL(?)	91	9.2	\$ 585	\$ 787	\$ 615	\$ 817
	48" A x 72" B x 24" C x 30" D	HWJ59ABL(?)	88	9.2	\$ 600	\$ 791	\$ 630	\$ 821
	48" A x 72" B x 30" C x 30" D	HWJ59BBL(?)	94	9.2	\$ 608	\$ 788	\$ 638	\$ 818

▲ **Requires support column — see page 415. Order support column separately.**



T-Mold Edge 	Jetty Worksurfaces, Right Hand							
	48" A x 66" B x 24" C x 30" D	HWJ58ABR(?)	84	9.2	\$ 571	\$ 786	\$ 601	\$ 816
	48" A x 66" B x 30" C x 30" D	HWJ58BBR(?)	91	9.2	\$ 585	\$ 787	\$ 615	\$ 817
	48" A x 72" B x 24" C x 30" D	HWJ59ABR(?)	88	9.2	\$ 600	\$ 791	\$ 630	\$ 821
	48" A x 72" B x 30" C x 30" D	HWJ59BBR(?)	94	9.2	\$ 608	\$ 788	\$ 638	\$ 818

▲ **Requires support column — see page 415. Order support column separately.**

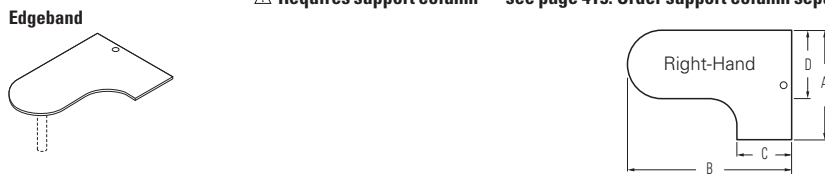

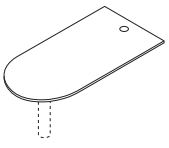
	Peninsula Worksurfaces T-Mold and Edgeband Options							
	24" W x 60" L	HWP2460(?)	65	4.9	\$ 322	\$ 368	\$ 342	\$ 388
	24" W x 66" L	HWP2466(?)	72	4.6	\$ 396	\$ 449	\$ 416	\$ 469
	24" W x 72" L	HWP2472(?)	95	5.5	\$ 445	\$ 506	\$ 465	\$ 526
	30" W x 60" L	HWP3060(?)	68	5.0	\$ 445	\$ 589	\$ 465	\$ 609
	30" W x 66" L	HWP3066(?)	75	6.0	\$ 540	\$ 648	\$ 560	\$ 668
	30" W x 72" L	HWP3072(?)	98	6.0	\$ 628	\$ 713	\$ 648	\$ 733

▲ **Peninsula worksurface width must correspond to the width of its support panel. Requires support column — see page 415. Order support column separately.**

How to specify	1st Option	2nd Option	3rd Option
Select Model Number from above	Select Laminate	Select Edge Color	Select Grommet Color
Select Edge Profile	See page 349	See page 349	See page 349
T Thin T-Mold P Edgeband			
No Grommet option: Add "N" suffix (no upcharge)			
Scalloped Option: Add "S" suffix before edge detail selection (no upcharge)			
HWJ58ABLST	A5	K	
HWJ58ABLT	A5	K	T1
HWJ59ABLTN	A5	K	

- ▶ Worksurfaces are constructed of laminate on 1/8" solid core high-performance particleboard.
- ▶ Choose from T-mold or Edgeband edge options.

Half Round Worksurfaces

- ▶ Order Support Column and End Panels separately.
- ▶ Mate only with other T-Mold and Edgeband worksurfaces.

Quarter Round Worksurfaces

- ▶ Two Flat Brackets and one Tie Bracket included.
- ▶ Mate only with other T-Mold and Edgeband worksurfaces.

60° Wedge Worksurfaces

- ▶ Two flat brackets and one tie bracket included.
- ▶ Mate only with other T-Mold and Edgeband worksurfaces.
- ▶ Refer to Worksurface Supports, pages 414-417.

▲ Curvilinear surfaces specified with edgeband will have a T-mold edge on curved areas of the worksurface.

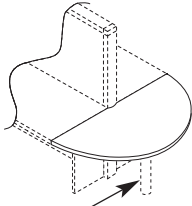

Description	Model	Ship Weight	Cube	L1 List Price		L2 List Price	
				"T"	"P"	"T"	"P"
 <p>About® Half-Round Worksurfaces 30"D x 50"L Connects to two 24"D Worksurfaces 36"D x 62"L Connects to two 30"D Worksurfaces</p>	HBWD2450(?)	52	5.0	\$ 303	\$ 582	\$ 318	\$ 597
	HBWD3062(?)	58	6.1	\$ 375	\$ 679	\$ 395	\$ 699
<p>Accelerate® Half-Round Worksurfaces 30"D x 50"L Connects to two 24"D Worksurfaces 36"D x 62"L Connects to two 30"D Worksurfaces</p> <p>NOTES: Order one Support Column and two Universal Support Legs or Full End Panel — see pages 414-415.</p>	HCWD2450(?)	52	5.0	\$ 303	\$ 582	\$ 318	\$ 597
	HCWD3062(?)	58	6.1	\$ 375	\$ 679	\$ 395	\$ 699

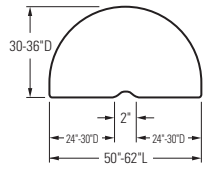

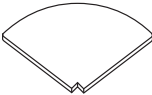
 <p>About® Quarter-Round Worksurfaces 24"W x 24"W Connects to two 24"D Worksurfaces 30"W x 30"W Connects to two 30"D Worksurfaces</p>	HBWQ2424(?)	18	2.6	\$ 327	\$ 333	\$ 342	\$ 348
	HBWQ3030(?)	25	3.7	\$ 336	\$ 419	\$ 356	\$ 439
<p>Accelerate® Quarter-Round Worksurfaces 24"W x 24"W Connects to two 24"D Worksurfaces 30"W x 30"W Connects to two 30"D Worksurfaces</p>	HCWQ2424(?)	18	2.6	\$ 327	\$ 333	\$ 342	\$ 348
	HCWQ3030(?)	25	3.7	\$ 336	\$ 419	\$ 356	\$ 439

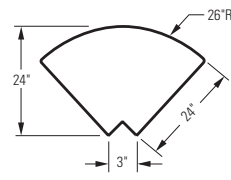

HBWQ2424(?)
HCWQ2424(?)

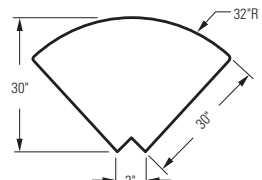

HBWQ3030(?)
HCWQ3030(?)

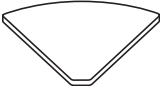
 <p>About® and Accelerate® 60° Wedge Worksurfaces for use with 120 degree Universal Connector 24"W x 24"W 30"W x 30"W</p>	HBWQT2424(?)	18	2.6	\$ 308	\$ 370	\$ 323	\$ 385
	HBWQT3030(?)	25	3.7	\$ 321	\$ 430	\$ 341	\$ 450

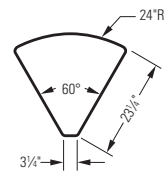

HBWQT2424(?)

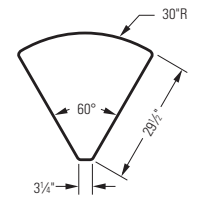

HBWQT3030(?)

How to specify	1st Option	2nd Option
<p>Select Model Number from above</p> <p>Select Edge Profile T Thin T-Mold P Edgeband</p> <p>H B W D 2 4 5 0 T .</p> <p>H C W D 2 4 5 0 T .</p>	<p>Select Laminate</p> <p>See page 349</p> <p>A 5 .</p> <p>A 5 .</p>	<p>Select Edge Color</p> <p>See page 349</p> <p>K </p> <p>K </p>

Systems Countertops — Straight and Corner

GSA SIN 711-1



- ▶ Countertops constructed with high-pressure laminate.
- ▶ Countertops have T-Mold or Edgeband options.
- ▶ Specify laminate and T-Mold or Edgeband options color.

▲ **Curvilinear surfaces specified with edgeband will have a T-mold edge on curved areas of the worksurface.**

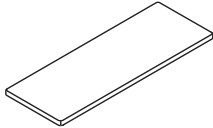
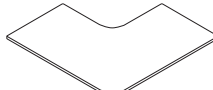

	Description	Model	Ship		L1 List Price		L2 List Price	
			Weight	Cube	"T"	"P"	"T"	"P"
Edgeband 	Abound® and Accelerate® 15" Straight Countertops							
	24"W x 15"D	HBCSR1524(?)	19	1.4	\$ 177	\$ 207	\$ 187	\$ 217
	30"W x 15"D	HBCSR1530(?)	25	1.4	\$ 182	\$ 229	\$ 192	\$ 239
	36"W x 15"D	HBCSR1536(?)	27	1.6	\$ 191	\$ 256	\$ 201	\$ 266
	42"W x 15"D	HBCSR1542(?)	32	1.8	\$ 211	\$ 264	\$ 221	\$ 274
	48"W x 15"D	HBCSR1548(?)	38	2.1	\$ 229	\$ 279	\$ 239	\$ 289
	60"W x 15"D	HBCSR1560(?)	48	2.6	\$ 243	\$ 354	\$ 258	\$ 369
	66"W x 15"D	HBCSR1566(?)	53	2.7	\$ 271	\$ 366	\$ 286	\$ 381
72"W x 15"D	HBCSR1572(?)	59	3.1	\$ 283	\$ 380	\$ 298	\$ 395	
Edgeband 	Abound® and Accelerate® 15"D Corner Countertops							
	24"W x 24"D	HBCSR2424(?)	44	1.4	\$ 415	\$ 397	\$ 430	\$ 412
	30"W x 30"D	HBCSR3030(?)	51	1.4	\$ 437	\$ 463	\$ 452	\$ 478
	36"W x 36"D	HBCSR3636(?)	58	1.6	\$ 462	\$ 514	\$ 482	\$ 534

How to specify	1st Option	2nd Option
Select Model Number from above Select Edge Profile T Thin T-Mold P Edgeband H B C S R 1 5 2 4 T .	Select Laminate See page 349 A 5 .	Select Edge Color See page 349 K

Icon Legend on page 10



Description	Model	Ship Weight	Cube	List by Paint Grade		
				Core	Metallics	
<p>Abound® Raised Straight Countertop Kits</p>	24"W	HRVBR1524	5	1.0	\$ 120	\$ 137
	30"W	HRVBR1530	5	1.0	\$ 126	\$ 143
	36"W	HRVBR1536	6	2.0	\$ 134	\$ 151
	42"W	HRVBR1542	6	2.0	\$ 139	\$ 156
	48"W	HRVBR1548	7	2.0	\$ 144	\$ 161
	60"W	HRVBR1560	8	2.0	\$ 172	\$ 189
	66"W	HRVBR1566	8	3.0	\$ 184	\$ 201
	72"W	HRVBR1572	9	3.0	\$ 197	\$ 214
<p>⚠ Do not order top caps for the panels the Countertop Kits will be installed on. Countertop Kits come with the necessary top caps and hardware.</p>						
<p>Abound® Raised Corner Countertop Kits</p>	24"W	HRVBR1524P	5	1.0	\$ 151	\$ 168
	30"W	HRVBR1530P	6	1.0	\$ 159	\$ 176
	36"W	HRVBR1536P	6	2.0	\$ 166	\$ 183
<p>⚠ Do not order top caps for the panels the Countertop Kits will be installed on. Countertop Kits come with the necessary top caps and hardware.</p>						
<p>Abound® Straight Countertop Kits</p>	24"W	HBCKIT24	5	0.7	\$ 43	N/A
	30"W	HBCKIT30	5	0.9	\$ 45	N/A
	36"W	HBCKIT36	6	0.9	\$ 47	N/A
	42"W	HBCKIT42	6	1.2	\$ 49	N/A
	48"W	HBCKIT48	7	1.4	\$ 51	N/A
	60"W	HBCKIT60	8	1.8	\$ 54	N/A
	66"W	HBCKIT66	8	1.8	\$ 56	N/A
	72"W	HBCKIT72	9	1.9	\$ 58	N/A
<p>⚠ Do not order top caps for the panels the Countertop Kits will be installed on. Countertop Kits come with the necessary top caps and hardware.</p>						
<p>Abound® Corner Countertop Kits</p>	24"W	HBCKKIT24	5	0.7	\$ 53	N/A
	30"W	HBCKKIT30	6	1.0	\$ 60	N/A
	36"W	HBCKKIT36	6	1.0	\$ 62	N/A
<p>⚠ Do not order top caps for the panels the Countertop Kits will be installed on. Countertop Kits come with the necessary top caps and hardware.</p>						
<p>Accelerate® Countertop Bracket Kit</p>	24"W	HECB01	1	0.1	\$ 44	\$ 47
	<p>⚠ For use with all panel heights, except 42 1/2".</p>					
<p>Accelerate® Countertop Bracket Kit for 42 1/2" H Panels</p>	42 1/2"W	HECB42	1	0.1	\$ 44	\$ 47
	<p>⚠ For use with 42 1/2" H Panels only.</p>					
<p>⚠ Bracket kits include one right and one left hand bracket. Order two sets of brackets for the straight countertop models and three sets for the corner countertop models. To be used on Accelerate® panels only. SPECIFYING EXAMPLE: HECB01.LOFT</p>						

How to specify	Select Model Number from above	1st Option
	H R V B R 1 5 2 4 .	Select Paint Color See page 309 A 5

Systems Shelves — Corner Shelves

GSA SIN 711-1 Except as Noted

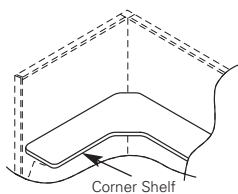

▶ Worksurfaces may be used with both Abound® and Accelerate® systems products.

▶ T-Mold or Edgeband options.
▶ Diagonal leading edge = 10 1/2"

▶ Diagonal depth = 22 1/2"
▶ Includes panel attachment brackets.

⚠ Curvilinear surfaces specified with edgeband will have a T-mold edge on curved areas of the worksurface.



Description	Model	Ship Weight	Cube	L1 List Price		L2 List Price	
				"T"	"P"	"T"	"P"
T-Mold Edge Corner Shelves 36" x 36" x 12"D 42" x 42" x 12"D	HCS3636(?) HCS4242(?)	33 33	3.6 3.6	\$ 378 \$ 396	\$ 378 \$ 395	\$ 398 \$ 421	\$ 398 \$ 420

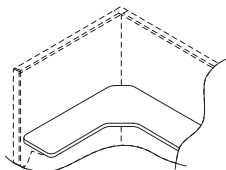

Edgeband

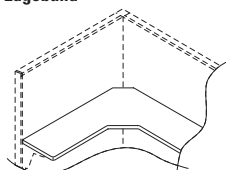

How to specify	1st Option	2nd Option	3rd Option
Select Model Number from above Select Edge Profile T Thin T-Mold P Edgeband H C S 3 6 3 6 T .	Select Laminate See page 349 A 5 .	Select Edge Color See page 349 K .	Select Paint Color See page 309 T 1

Description	Model	Ship Weight	Cube	List by Paint Grade Core
 SIN 71-302 Power Hub, 3" Grommet Mount • Fits in 3" round grommet holes on the following product lines: 10500, 10700, Coordinate, Pennsylvania Avenue and Voi desks; Systems Worksurfaces; Huddle and Motivate tables and SmartLink. • Two grounded AC power outlets. • Includes 6' cord with three-prong plug. • Field installed with Plug-and-play ease. ⚠ Available in black only (no color designation so use .X – Specify: HGRMTAC.X).	HGRMTAC	1.3	0.2	\$ 100

- ▶ Height Adjustable Base is a 3-stage column design.
- ▶ Base rises from 23³/₈" to 49¹/₄" for a sit-to-stand desk option.
- ▶ Height Adjustable Bases ship complete with a preassembled motor.

- ▶ HHAB3S24F accommodates rectangular workspaces between 24"D x 48"W and 36"D x 72"W. Systems, Voi®, 10500, and Preside® all have workspaces within this range.

- ▶ 3-Leg Base can accommodate configurations between 24"D x 48"W x 60"L and 30"D x 72"W x 72"L.
- ▶ 3-Leg Base can accommodate two workspaces to create configurations within specified dimensions.

- ▶ Base telescopes to accommodate any workspace between 48"W and 72"W.
- ▶ Standard height-adjustable control ships with base.

- ▶ Silver finish matches any neutral HON paint or finish color.

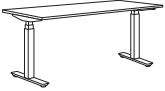
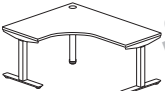

	Description	Model	Ship Weight	Cube	List
	Height Adjustable Base – 3 Stage 24"D Feet and Worksurface Brackets ▲ Available in silver finish only, no specification needed. Suggested coordinated paint, Platinum Metallic.	HHAB3S24F E♦A	80	2.8	\$1250
<i>Base shown with worksurface attached.</i>					
	3-Leg Height Adjustable Base – 3 Stage 24"D Feet and Worksurface Brackets ▲ Available in silver finish only, no specification needed. Suggested coordinated paint, Platinum Metallic.	HHAB3S3C24F E♦A	102	4.4	\$1700
<i>Base shown with worksurface attached.</i>					





- ▶ Optional Memory Control allows preset workspace heights for consistency. Ships separately.

- ▶ Dynamic load capacity when workspace is moving is 300 lbs.

- ▶ Silver finish matches any neutral HON paint or finish color.

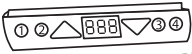
- ▶ HON's Optional Memory Control (HHABMEM) does not work with the *basyx* by HON® Height Adjustable Base.

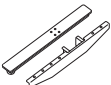

	Description	Model	Ship Weight	Cube	List
	Height Adjustable Base – Optional Memory Control ▲ Available in black finish only, no specification needed. Memory controller includes digital display and four memory presets.	HHABMEM	0.5	0.4	\$ 75
<i>Open Market</i>					
	Under Worksurface Power Module – 4 Outlets, 10' Cord <ul style="list-style-type: none"> • Includes 10' cord with three-prong plug. • Fits in cable management troughs. See page 392. • 4 outlets on side create easy access. NOTES: Power Modules will also work with standing-height applications for 10500 Series™ and Voi® desks. ▲ Available in black finish only, no specification needed.	HPWRMOD2 E♦A	1.5	0.2	\$ 340
<i>Open Market</i>					
	3" Round Power Grommet – 2 Outlets, 10' Cord <ul style="list-style-type: none"> • Includes 10' cord with three-prong plug. • Fits in 3" round grommet holes on the following product lines: Coordinate, Huddle, Motivate, all laminate and veneer casegoods series, and Systems Workspaces. • Two grounded AC power outlets. • Field installed with Plug-and-play ease. NOTES: Power Modules will also work with standing-height applications for 10500 Series™ and Voi® desks. ▲ Available in black finish only, no specification needed.	HGRMTAC2 E♦A	1.5	0.2	\$ 126
<i>Open Market</i>					
	Corner-Cove Extension Kit – For use with Right-Hand Corner-Coves Corner-Cove Extension Kit – For use with Left-Hand Corner-Coves NOTES: Use the Corner-Cove Extension Kit with the 2-leg base when a Corner-Cove is used. ▲ Available in silver finish only, no specification needed. Suggested coordinated paint, Platinum Metallic.	HHABCCEXTL E♦A HHABCCEXTR E♦A	13.0 13.0	0.3 0.3	\$ 83 \$ 83
<i>Open Market</i>					
	Caster Add-On Kit ▲ Available in black finish only, no specification needed.	HHABCASTER E♦A	1.0	0.1	\$ 65
<i>Open Market</i>					

How to specify

Select Model Number from above

H | H | A | B | 3 | S | 3 | C | 2 | 4 | F |

Icon Legend on page 10

► Systems Rectangle Worksurfaces for Height Adjustable Bases designed for use in panel systems. Worksurface is 2" shorter in width and 3/4" shorter in depth than standard worksurfaces to provide clearance between panels and other worksurfaces.

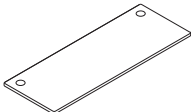

Description	Model	Ship Weight	Cube	L1 List Price	L2 List Price
 <p>Systems Rectangle Worksurfaces for Height Adjustable Bases</p> <p>46 3/4" W x 23 1/4" D</p> <p>52" W x 23 1/4" D</p> <p>58" W x 23 1/4" D</p> <p>64" W x 23 1/4" D</p> <p>70" W x 23 1/4" D</p>	HHAW2448P	58	3.3	\$ 403	\$ 418
	HHAW2454P	64	4.0	\$ 425	\$ 445
	HHAW2460P	70	4.0	\$ 471	\$ 491
	HHAW2466P	86	4.8	\$ 504	\$ 524
	HHAW2472P	89	4.8	\$ 520	\$ 540
<p>▲ Must be used as worksurfaces on Coordinate™ Height Adjustable Bases within Panel Systems, as these are 1" shorter in width on each side to provide clearance between panels and other worksurfaces.</p> <p>▲ Available in all standard systems' laminate and edgbanding options. Only offered with grommets. Specify Model.LaminateColor.EdgeColor.GrommetColor SPECIFYING EXAMPLE: HHAW2448P.A5.K.T1</p>					

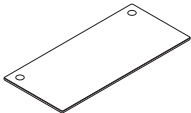
 <p>Systems Rectangle Worksurfaces for Height Adjustable Bases</p> <p>46 3/4" W x 29 1/4" D</p> <p>52" W x 29 1/4" D</p> <p>58" W x 29 1/4" D</p> <p>64" W x 29 1/4" D</p> <p>70" W x 29 1/4" D</p>	HHAW3048P	68	4.0	\$ 432	\$ 447
	HHAW3054P	80	5.0	\$ 463	\$ 483
	HHAW3060P	101	5.0	\$ 512	\$ 532
	HHAW3066P	105	6.0	\$ 545	\$ 565
	HHAW3072P	105	6.0	\$ 581	\$ 601
<p>▲ Must be used as worksurfaces on Coordinate™ Height Adjustable Bases within Panel Systems, as these are 1" shorter in width on each side to provide clearance between panels and other worksurfaces.</p> <p>▲ Available in all standard systems' laminate and edgbanding options. Only offered with grommets. Specify Model.LaminateColor.EdgeColor.GrommetColor SPECIFYING EXAMPLE: HHAW3048P.A5.K.T1</p>					

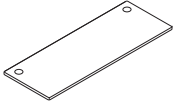
 <p>Voi® Rectangle Worksurfaces for Height Adjustable Bases</p> <p>48" W x 24" D</p> <p>54" W x 24" D</p> <p>60" W x 24" D</p> <p>66" W x 24" D</p> <p>72" W x 24" D</p> <p>48" W x 30" D</p> <p>54" W x 30" D</p> <p>60" W x 30" D</p> <p>66" W x 30" D</p> <p>72" W x 30" D</p> <p>60" W x 36" D</p> <p>66" W x 36" D</p> <p>72" W x 36" D</p>	HLSLR2448	61	3.4	\$ 264	\$ 279
	HLSLR2454	68	4.2	\$ 284	\$ 284
	HLSLR2460	75	4.2	\$ 309	\$ 329
	HLSLR2466	82	5.0	\$ 336	\$ 356
	HLSLR2472	89	5.0	\$ 347	\$ 367
	HLSLR3048	75	4.2	\$ 284	\$ 299
	HLSLR3054	84	5.1	\$ 317	\$ 337
	HLSLR3060	92	5.1	\$ 354	\$ 374
	HLSLR3066	101	6.1	\$ 381	\$ 401
	HLSLR3072	110	6.1	\$ 414	\$ 434
	HLSLR3660	110	6.1	\$ 444	\$ 469
	HLSLR3666	120	7.2	\$ 480	\$ 505
	HLSLR3672	130	7.2	\$ 539	\$ 564
	<p>▲ For use with Coordinate™ Height Adjustable Bases only in Freestanding Applications, which are applications where the tables/desks are not attached or adjacent to another unit, table/desk or systems panel. The widths are true to stated dimensions. If used with Panel Systems or other than in Freestanding Applications, worksurfaces will not provide proper clearance between panels or other worksurfaces, and may cause injury or worksurface damage (not covered by warranty).</p> <p>▲ For 36" D rectangular worksurfaces, the height adjustable base must be centered in the middle of the worksurface.</p>				

How to specify	1st Option	2nd Option	3rd Option	4th Option
Select Model Number from above	Select Laminate	Select Edge Color	Select Grommet Color	Select Grommet Option and Color
	See page 309	See page 309 Specify for Systems Worksurfaces only	See page 309 Specify for Systems Worksurfaces only	Specify for Voi® Worksurfaces only X No Grommet G Grommet If choosing the grommet option Select Grommet Color P Black Grommet WHIT Brilliant White Grommet T5 Greige Grommet T1 Platinum Grommet
H H A W 2 4 4 8 P .	A 5 .	K .	T 1 	G T 5
H L S L R 2 4 4 8 .	N N .			

► Corner-Cove Worksurfaces for Height Adjustable Bases designed for use in panel systems. Worksurface is 1" shorter in width and 1" shorter than standard worksurfaces in depth on side of corner to provide clearance between panels and other worksurfaces.

► Use the Corner-Cove Extension Kit on page 409 with the 2-leg base when a Corner-Cove Worksurface is used.

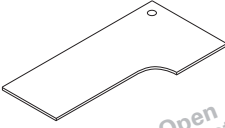

Edgeband	Description	Model	Ship		L1 List	L2 List
			Weight	Cube	Price	Price
 <p>Open Market</p>	Corner-Cove Worksurfaces for Height Adjustable Bases, Left Hand					
	58" A x 34 1/4" B x 23 1/4" C x 23 1/4" D	HHAWV603624LP	67.0	6.1	\$ 572	\$ 597
	70" A x 34 1/4" B x 23 1/4" C x 23 1/4" D	HHAWV723624LP	75.0	6.8	\$ 626	\$ 656
	58" A x 46 1/4" B x 23 1/4" C x 23 1/4" D	HHAWV604824LP	85.0	7.4	\$ 626	\$ 656
	58" A x 46 1/4" B x 29 1/4" C x 29 1/4" D	HHAWV604830LP	99.0	7.4	\$ 672	\$ 702
	70" A x 46 1/4" B x 23 1/4" C x 23 1/4" D	HHAWV724824LP	105.0	8.8	\$ 782	\$ 817
	70" A x 46 1/4" B x 29 1/4" C x 29 1/4" D	HHAWV724830LP	112.0	8.8	\$ 830	\$ 865

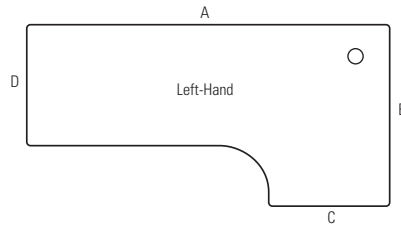

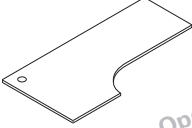
 <p>Open Market</p>	Corner-Cove Worksurfaces for Height Adjustable Bases, Right Hand					
	58" A x 34 1/4" B x 23 1/4" C x 23 1/4" D	HHAWV603624RP	67.0	6.1	\$ 572	\$ 597
	70" A x 34 1/4" B x 23 1/4" C x 23 1/4" D	HHAWV723624RP	75.0	6.8	\$ 626	\$ 656
	58" A x 46 1/4" B x 23 1/4" C x 23 1/4" D	HHAWV604824RP	85.0	7.4	\$ 626	\$ 656
	58" A x 46 1/4" B x 29 1/4" C x 29 1/4" D	HHAWV604830RP	99.0	7.4	\$ 672	\$ 702
	70" A x 46 1/4" B x 23 1/4" C x 23 1/4" D	HHAWV724824RP	105.0	8.8	\$ 782	\$ 817
	70" A x 46 1/4" B x 29 1/4" C x 29 1/4" D	HHAWV724830RP	112.0	8.8	\$ 830	\$ 865

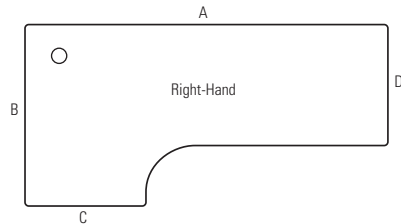

How to specify	1st Option	2nd Option	3rd Option
Select Model Number from above	Select Laminate See page 309	Select Edge Color See page 309	Select Grommet Color See page 309
H H A W V 6 0 3 6 2 4 L P .	A 5 .	K .	T 1

Icon Legend on page 10

- ▶ Laminate or mixed material floating modesty panels options are available for attachment under 10500 Series worksurfaces. The modesty panel and attachment bracket are packaged separately.
- ▶ If using a 54"W or 60"W floating modesty panel, it is not necessary to specify an external support channel under the worksurface.
- ▶ When using a floating modesty panel under the worksurface, the depth clearance for center drawers and keyboard platforms decreases by 8".

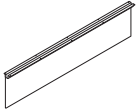

Description	Model	Ship Weight	Cube	L1 List	L2 Upcharge
 <p>Laminate Floating Modesty Panel 30"W x 14"H 36"W x 14"H 42"W x 14"H 48"W x 14"H 54"W x 14"H 60"W x 14"H</p> <p>NOTES: The attachment bracket and modesty panel are packaged separately. Specify: Model.Laminate.Paint</p> <p>SPECIFYING EXAMPLE: HLSL3014L.N.P (Black is the only paint option for this model)</p> <p>⚠ When specifying the 54"W or 60"W Laminate Floating Modesty Panel, it is not necessary to specify an external channel. ⚠ 30"W and 36"W screens attach with L-brackets, not the external channel.</p>	HLSL3014L	10	0.8	\$ 148	\$ 10
	HLSL3614L	12	0.8	\$ 156	\$ 10
	HLSL4214L	14	0.8	\$ 169	\$ 10
	HLSL4814L	16	1.1	\$ 186	\$ 12
	HLSL5414L	18	1.1	\$ 204	\$ 12
	HLSL6014L	20	1.1	\$ 220	\$ 12

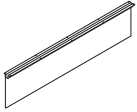
Description	Model	Ship Weight	Cube	List
 <p>Mixed Material Floating Modesty Panel 30"W x 14"H 36"W x 14"H 42"W x 14"H 48"W x 14"H 54"W x 14"H 60"W x 14"H</p> <p>NOTES: The attachment bracket and modesty panel are packaged separately. Specify: Model.Mixed Material.Paint</p> <p>SPECIFYING EXAMPLE: HLSL3014MM.FT01.P (Frosted Translucent mixed material and Black paint are the only options for this model)</p> <p>⚠ When specifying the 54"W or 60"W Mixed Material Floating Modesty Panel, it is not necessary to specify an external channel.</p>	HLSL3014MM	8	2.0	\$ 597
	HLSL3614MM	8	2.0	\$ 641
	HLSL4214MM	9	2.3	\$ 716
	HLSL4814MM	11	2.6	\$ 794
	HLSL5414MM	13	3.3	\$ 862
	HLSL6014MM	13	3.3	\$ 984

Support Combination		Rectangle Worksurface Width				
Support 1	Support 2	72 in	66 in	60 in	48 in	42 in
O-Leg	O-Leg	HLSL6014	HLSL5414	HLSL4814	HLSL3614	HLSL3014
O-Leg	L-Shaped End Panel	HLSL4814	HLSL4214	HLSL3614	NA	NA
O-Leg	4½" Diameter Support Column	HLSL4814	HLSL4814	HLSL4814	HLSL3614	HLSL3014
O-Leg	2" Square Post Leg	HLSL4814	HLSL4814	HLSL4814	HLSL3614	HLSL3014
L-Shaped End Panel	L-Shaped End Panel	HLSL3614	HLSL3014	NA	NA	NA
L-Shaped End Panel	4½" Diameter Support Column	HLSL3614	HLSL3614	HLSL3614	NA	NA
L-Shaped End Panel	2" Square Post Leg	HLSL3614	HLSL3614	HLSL3614	NA	NA
T-Shaped End Panel	O-Leg	HLSL5414	HLSL4814	HLSL4214	HLSL3014	NA
T-Shaped End Panel	L-Shaped End Panel	HLSL3614	HLSL3014	NA	NA	NA
T-Shaped End Panel	4½" Diameter Support Column	HLSL3614	HLSL3014	NA	NA	NA
T-Shaped End Panel	2" Square Post Leg	HLSL3614	HLSL3014	NA	NA	NA

Support Combination		Bullet Worksurface Width		
Support 1	Support 2	72 in	66 in	60 in
O-Leg	4½" Diameter Support Column	HLSL4814	HLSL4814	HLSL4814
O-Leg	2" Square Post Leg	HLSL4814	HLSL4814	HLSL4814
L-Shaped End Panel	4½" Diameter Support Column	HLSL3614	HLSL3614	HLSL3614
L-Shaped End Panel	2" Square Post Leg	HLSL3614	HLSL3614	HLSL3614
T-Shaped End Panel	4½" Diameter Support Column	HLSL3614	HLSL3614	HLSL3614
T-Shaped End Panel	2" Square Post Leg	HLSL3614	HLSL3614	HLSL3614

How to specify	<p>Select Model Number from above</p> <p>H L S L 3 0 1 4 M M .</p>	<p>1st Option</p> <p>Select Mixed Material</p> <p>FT01 Frosted Translucent</p> <p>F T 0 1 </p>
----------------	--	---

- ▶ Height Adjustable Base is a dual motor 2-stage column design.
- ▶ Frame rises from 28^{3/8}" to 48^{3/8}" for a sit-to-stand desk option.
- ▶ Height Adjustable Bases shipped complete with a preassembled motor.
- ▶ Base telescopes to accommodate any worksurface between 48"W and 72"W.
- ▶ Height Adjustable Base accommodates rectangular worksurfaces between 24"D x 48"W and 36"D x 72"W. Systems, Voi®, 10500, and Preside® all have worksurfaces within this range.
- ▶ **basyx by HON® 5-year Limited Warranty.**
- ▶ **When attaching a Keyboard Tray, remember to also specify a Keyboard Spacer Kit (HKBS).**

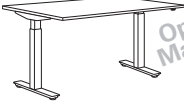
Description	Model	Ship Weight	Cube	List
 <p>Height Adjustable Base – 2 Stage 24"D Feet and Worksurface Brackets</p> <p>△ Available in silver finish only. No specification needed.</p>	HBHAB2S24F E♣A	77	2.8	\$1100

Base shown with work surface attached.

How to specify

Select Model Number from above

H | B | H | A | B | 2 | S | 2 | 4 | F

GSA SIN 711-2

HON® Worksurfaces

- ▶ Systems Rectangle Worksurfaces for Height Adjustable Bases designed for use in panel systems. Worksurface is 2" shorter in width and 1/4" shorter in depth to provide clearance between panels and other worksurfaces.
- ▶ Standard height-adjustable control ships with base.
- ▶ Dynamic load capacity when work surface is moving is 250 lbs.

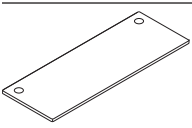
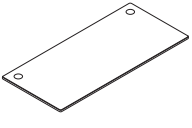
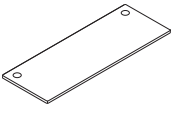

Description	Model	Ship Weight	Cube	List Price by Laminate Grade	
				L1	L2
 <p>Systems Rectangle Worksurfaces for Height Adjustable Bases</p> <p>46^{3/4}"W x 23^{1/4}"D 52"W x 23^{1/4}"D 58"W x 23^{1/4}"D 64"W x 23^{1/4}"D 70"W x 23^{1/4}"D</p> <p>△ Must be used as worksurfaces on Height Adjustable Bases within Panel Systems, as these are 1" shorter in width on each side to provide clearance between panels and other worksurfaces.</p> <p>△ Available in all standard systems' laminate and edgebanding options. Only offered with grommets.</p> <p>Specify Model.LaminateColor.EdgeColor.GrommetColor SPECIFYING EXAMPLE: HHAW2448P.A5.K.T1</p>	HHAW2448P	58	3.3	\$ 403	\$ 418
	HHAW2454P	64	4.0	\$ 425	\$ 445
	HHAW2460P	70	4.0	\$ 471	\$ 491
	HHAW2466P	86	4.8	\$ 504	\$ 524
	HHAW2472P	89	4.8	\$ 520	\$ 540
	<p>△ Must be used as worksurfaces on Height Adjustable Bases within Panel Systems, as these are 1" shorter in width on each side to provide clearance between panels and other worksurfaces.</p> <p>△ Available in all standard systems' laminate and edgebanding options. Only offered with grommets.</p> <p>Specify Model.LaminateColor.EdgeColor.GrommetColor SPECIFYING EXAMPLE: HHAW3048P.A5.K.T1</p>				
 <p>Systems Rectangle Worksurfaces for Height Adjustable Bases</p> <p>46^{3/4}"W x 29^{1/4}"D 52"W x 29^{1/4}"D 58"W x 29^{1/4}"D 64"W x 29^{1/4}"D 70"W x 29^{1/4}"D</p> <p>△ Must be used as worksurfaces on Height Adjustable Bases within Panel Systems, as these are 1" shorter in width on each side to provide clearance between panels and other worksurfaces.</p> <p>△ Available in all standard systems' laminate and edgebanding options. Only offered with grommets.</p> <p>Specify Model.LaminateColor.EdgeColor.GrommetColor SPECIFYING EXAMPLE: HHAW3048P.A5.K.T1</p>	HHAW3048P	68	4.0	\$ 432	\$ 447
	HHAW3054P	80	5.0	\$ 463	\$ 483
	HHAW3060P	101	5.0	\$ 512	\$ 532
	HHAW3066P	105	6.0	\$ 545	\$ 565
	HHAW3072P	105	6.0	\$ 581	\$ 601
	<p>△ For use with Height Adjustable Bases only in Freestanding Applications, which are applications where the tables/desks are not attached or adjacent to another unit, table/desk or systems panel. The widths are true to stated dimensions. If used with Panel Systems or other than in Freestanding Applications, worksurfaces will not provide proper clearance between panels or other worksurfaces, and may cause injury or work surface damage (not covered by warranty).</p>				
 <p>Voi® Rectangle Worksurfaces for Height Adjustable Bases</p> <p>48"W x 24"D 54"W x 24"D 60"W x 24"D 66"W x 24"D 72"W x 24"D</p> <p>48"W x 30"D 54"W x 30"D 60"W x 30"D 66"W x 30"D 72"W x 30"D</p> <p>60"W x 36"D 66"W x 36"D 72"W x 36"D</p> <p>△ For use with Height Adjustable Bases only in Freestanding Applications, which are applications where the tables/desks are not attached or adjacent to another unit, table/desk or systems panel. The widths are true to stated dimensions. If used with Panel Systems or other than in Freestanding Applications, worksurfaces will not provide proper clearance between panels or other worksurfaces, and may cause injury or work surface damage (not covered by warranty).</p>	HLSLR2448	61	3.4	\$ 264	\$ 279
	HLSLR2454	68	4.2	\$ 284	\$ 304
	HLSLR2460	75	4.2	\$ 309	\$ 329
	HLSLR2466	82	5.0	\$ 336	\$ 356
	HLSLR2472	89	5.0	\$ 347	\$ 367
	HLSLR3048	75	4.2	\$ 284	\$ 299
	HLSLR3054	84	5.1	\$ 317	\$ 337
	HLSLR3060	92	5.1	\$ 354	\$ 374
	HLSLR3066	101	6.1	\$ 381	\$ 401
	HLSLR3072	110	6.1	\$ 414	\$ 434
	HLSLR3660	110	6.1	\$ 444	\$ 469
	HLSLR3666	120	7.2	\$ 480	\$ 505
	HLSLR3672	130	7.2	\$ 539	\$ 564

How to specify

<p>Select Model Number from above</p> <p>H H A W 2 4 7 2 P . A 5 .</p> <p>H L S L R 2 4 4 8 . N N .</p>	<p>1st Option</p> <p>Select Laminate</p> <p>See page 349 for Systems Worksurfaces See page 175 for Voi® Worksurfaces</p>	<p>2nd Option</p> <p>Select Edge Color</p> <p>See page 349</p> <p>Specify for Systems Worksurfaces only</p>	<p>3rd Option</p> <p>Select Grommet Color</p> <p>See page 349</p> <p>Specify for Systems Worksurfaces only</p>	<p>4th Option</p> <p>Select Grommet Option and Color</p> <p>Specify for Voi® Worksurfaces only</p> <p>X No Grommet G Grommet</p> <p>If choosing the grommet option Select Grommet Color</p> <p>P Black Grommet WHIT Brilliant White Grommet T5 Greige Grommet T1 Platinum Grommet</p>
	<p>H H A W 2 4 7 2 P . A 5 .</p> <p>H L S L R 2 4 4 8 . N N .</p>	<p>K .</p>	<p>T 1</p>	<p>G T 5</p>

ABJ △ E♣A Icon Legend on page 10

Systems Worksurface Supports

GSA SIN 711-1



Full End Panel

- ▶ Levelers provide 1/2" vertical adjustment.

Support Leg

- ▶ Use at 90° panel junctions or in a shared position to support adjoining worksurfaces.
- ▶ Provided with flat bracket.
- ▶ Levelers provide 1/2" vertical adjustment.

Open Leg

- ▶ Open leg includes attaching hardware and leveling glides.
- ▶ Leveling glides provide 2/4" of adjustment.
- ▶ Open leg is universal shared with a left and right-hand attachment bracket.

- ▶ Use the anti-dislodgement bracket when using a worksurface in a peninsula application with a post or O-leg.
- ▶ The supports included on this page can be used with Systems and Worksurfaces.

△ End panel support with bracket will attach to both Accelerate® and Abound® panels.

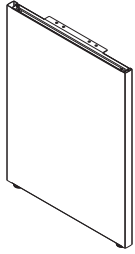

Specify paint

Description	Model	Ship Weight	Cube	List by Paint Grade	
				Core	Choice/Metallics
Abound® and Accelerate® Full End Panel*					
29 1/2"H x 11"D — Right — Panel-Mount	HRVEP1129R	16 [S]	1.4	\$ 188	\$ 217
29 1/2"H x 11"D — Left — Panel-Mount	HRVEP1129L	16 [S]	1.4	\$ 188	\$ 217
29 1/2"H x 24"D — Right — Panel-Mount	HRVEP2429R	21 [S]	1.4	\$ 202	\$ 231
29 1/2"H x 24"D — Left — Panel-Mount	HRVEP2429L	21	1.4	\$ 202	\$ 231
29 1/2"H x 30"D — Right — Panel-Mount	HRVEP3029R	23	1.4	\$ 220	\$ 249
29 1/2"H x 30"D — Left — Panel-Mount	HRVEP3029L	23	1.4	\$ 220	\$ 249

NOTES: The use of an end panel at the end of a worksurface will increase the rigidity of the workstation. If the panel is a greater dimension than the worksurface, an end panel is required if the run of the worksurfaces is 8 feet or greater.

△ ***Must be connected into panel slots. When an installation of worksurfaces is 8 feet or greater, a full end panel or universal support leg must be used at 90 degree panel junctions or in a shared position to support adjoining worksurfaces.**

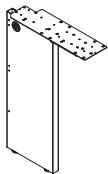

Non-handed unit
Specify paint

Abound® and Accelerate® Universal Support Leg*					
29 1/2"H to support 24"D	HRVCLG24	16 [S]	1.4	\$ 179	\$ 208
29 1/2"H to support 30"D	HRVCLG30	17 [S]	1.4	\$ 195	\$ 224

△ ***Must be connected into panel slots. When an installation of worksurfaces is 8 feet or greater, a full end panel or universal support leg must be used at 90 degree panel junctions or in a shared position to support adjoining worksurfaces.**

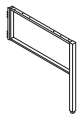

Open Leg Models*					
29 1/2"H x 24"D	HOLEG24	11 [S]	1.2	\$ 188	\$ 217
29 1/2"H x 30"D	HOLEG30	15 [S]	1.8	\$ 204	\$ 233

△ ***Must be connected into frame slots. Specify paint.**

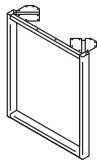

O-Leg Support for Worksurfaces					
20"D x 28 1/2"H	HLSL2028O	15	3.7	\$ 256	\$ 260
24"D x 28 1/2"H	HLSL2428O	17	3.7	\$ 279	\$ 283
30"D x 28 1/2"H	HLSL3028O	19	5.4	\$ 310	\$ 314

NOTES: Ship fully assembled, 1/pack. Non-handed.

How to specify	1st Option
Select Model Number from above H R V E P 1 1 2 9 R .	Select Paint Color See page 309 T 1

Description	Model	Ship Weight	Cube	List by Paint Grade	
				Core	Choice/Metallics
Laminate End Panel Support with Panel Bracket					
29 1/2"H x 24"D, Left handed	HLSL2428EBL	3	2.2	\$ 226	\$ 230
29 1/2"H x 24"D, Right handed	HLSL2428EBR	3	2.2	\$ 226	\$ 230
29 1/2"H x 30"D, Left handed	HLSL3028EBL	3	3.2	\$ 241	\$ 245
29 1/2"H x 30"D, Right handed	HLSL3028EBR	3	3.2	\$ 241	\$ 245

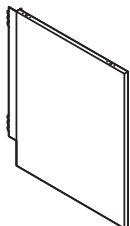

NOTES: Includes laminate end panel and brackets to attach end panel support to a panel. Order to correspond to worksurface depth. Handed end panel brackets are designed to work with edgeband worksurfaces only. Specify laminate and paint. Can be used with Abound® and Accelerate® Systems products.

How to specify	1st Option	2nd Option
Select Model Number from above H L S L 2 4 2 8 E B L .	Select Laminate L2 Laminate Upcharge \$10 See page 349 H .	Select Paint Color See page 309 T 1

Support Column

- ▶ Used to support one end of a peninsula, round or half-round worksurface. (Includes panel support brackets.)
- ▶ Levelers provide 1 1/2" vertical adjustment.

Flat Brackets

- ▶ Flat Brackets can be used to connect one worksurface perpendicular to another worksurface.

- ▶ The supports included on this page can be used with Systems Worksurfaces.







⚠ **Worksurfaces should not be supported with Cantilever brackets when using Permanent-Wall Hanger Kit.**

Accessory Cantilever

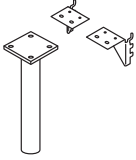
- ⚠ **Use with runs 72" or less – avoid installation on only one side of a straight connection except to support corner worksurfaces. Floor support is required for runs longer than 72".**
- ⚠ **DO NOT position at the end of a panel run where no 90 degree return panel is positioned.**

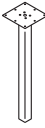
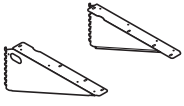
- ⚠ **DO NOT use to support worksurfaces from which a hanging pedestal is suspended, or to which a peninsula worksurface is attached.**
- ⚠ **DO NOT use cantilever brackets to support worksurfaces supported with permanent wall hanger kit.**

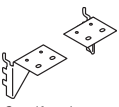

Description	Model	Ship Weight	Cube	List by Paint Grade		
				Core	Choice/Metallics	Custom
 <p>Support Column* For 29 1/2" Height. 3" diameter.</p> <p>⚠ *Brackets must be connected into panel slots.</p> <p><i>Non-handed unit Specify paint</i></p>	HCNLEG29	13	1.1	\$ 197	\$ 224	N/A
 <p>Post Leg Base</p> <ul style="list-style-type: none"> • Single Leg with Hardware Pack • Requires hardware bracket model HWSA2. Please see page 415 for HWSA2 bracket ordering information. 	HMBPOST1	18	2.3	\$ 268	\$ 280	N/A
 <p>Post Leg Base 28 1/2"H x 2" square</p>	HLSL28P	15	1.0	\$ 256	\$ 260	N/A
 <p>Accessory Cantilever* 18"D 24"D</p> <p>⚠ *Must be connected into panel slots. ⚠ Accelerate® only: Cantilevers only to be used on worksurface runs 72"W or less.</p> <p><i>Specify paint</i></p>	HCTL182 HCTL242	4 5	0.3 0.3	\$ 58 \$ 75	\$ 68 \$ 85	N/A N/A
 <p>Flat Bracket 18"D 24"D 30"D</p> <p>⚠ Charcoal only.</p>	HHN831118 HHN831124 HHN831130	3 3 3	0.2 0.3 0.4	\$ 56 \$ 57 \$ 57	N/A N/A N/A	N/A N/A N/A
 <p>Worksurface Bracket Kit* One Pair</p> <p>⚠ Always use when the depth side of a worksurface is against a panel (return/wing panel) of the same dimension. This will increase the sturdiness of the workstation. ⚠ *Must be connected into panel slots.</p> <p><i>Specify paint</i></p>	HWSB2	1	0.1	\$ 40	\$ 43	N/A
 <p>Anti-Dislodgement Bracket Kit</p> <p>NOTES: To be used with model HMBPOST1 support leg.</p>	HWSA2	1	0.1	\$ 38	\$ 41	N/A

How to specify	Select Model Number from above	1st Option
	H C T L 2 4 2 .	Select Paint Color See page 309 T 1

Worksurface Brackets

GSA SIN 711-1 Except as Noted



- ▶ The Pedestal to Panel Bracket Kits are used to attach a 22 $\frac{7}{8}$ "D pedestal to a 24"D worksurface, or 28 $\frac{7}{8}$ "D pedestal to a 30"D worksurface.
- ▶ The Worksurface to Tower Bracket Kit replaces the need for a panel attached end panel.
- ▶ Use the anti-dislodgement bracket when using a worksurface in a peninsula application with a post or O-leg.



Description	Model	Ship Weight	Cube	List by Paint Grade		
				Core	Choice/Metallics	Custom
 Flagship® Pedestal to Panel Bracket Kit, Left Flagship® Pedestal to Panel Bracket Kit, Right Bracket to attach 22 $\frac{7}{8}$ "D pedestals to 24"D worksurface or 28 $\frac{7}{8}$ "D pedestals to 30"D worksurface.	HPD2PNBRK2L	3	0.3	\$ 96	\$ 104	\$ 106
	HPD2PNBRK2R	3	0.3	\$ 96	\$ 104	\$ 106

 Worksurface to Tower Bracket Kit Bracket to attach storage towers to worksurfaces. SIN 711-2 NOTES: Replaces the need for a panel attached end panel. Standard with hardware to attach bracket to panel and worksurface. ⚠ Bracket cannot be used as a support when placing Stack-on Storage on worksurface over bracket. Must use two full-sized supports when using Stack-on Storage. ⚠ Not for use with systems support pedestals.	HSTB2W1	4	0.6	\$ 68	\$ 81	\$ 92
--	---------	---	-----	-------	-------	-------

 Voi® for Systems O-Leg-to-Panel Attachment Bracket Left handed bracket (quantity 1) Right handed bracket (quantity 1) NOTES: Used to connect Voi O-Leg to a systems panel for additional workstation rigidity. Bracket designed to work with edgeband worksurfaces only. Brackets are handed, come one per package and include self-tapping screws. Specify paint.	HLSLPBL HLSLPBR	3 3	0.4 0.4	\$ 87 \$ 87	\$ 91 \$ 91	N/A N/A
---	--------------------	--------	------------	----------------	----------------	------------

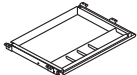
 Polymer Center Drawer • Color: Black. • Material: ABS. • Opening Requirements: 23"W x 16 $\frac{1}{4}$ "D x 2"H. • Retracts on 16" ball bearing slides. • Can be used on worksurfaces with Coordinate™ and <i>basyx</i> by HON® Height Adjustable Bases as long as it is attached with spacer model HKBS. • Can store up to 25 lbs. ⚠ Black finish only, no specification needed.	HCD1	7	0.5	\$ 96		
---	------	---	-----	-------	--	--

How to specify	Select Model Number from above H P D 2 P N B R K 2 L .	1st Option Select Paint Color See page 309 T 1
----------------	--	--

Permanent-Wall Hanger Kit
 ▶ Used to hang storage cabinets and bookshelves from permanent wall, and/or to attach worksurfaces to permanent wall.

▶ Wall track has 1/8" x 1/2" slots on 1" centers.

▶ Customer to furnish connecting hardware. (Refer to Installation Instructions for appropriate hardware.)
 ▶ Includes a cover for top of channel.

⚠ **Worksurfaces should not be supported with Cantilever brackets when using Permanent-Wall Hanger Kit.**

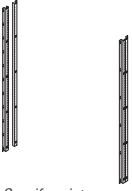

Description	Model	Ship Weight	Cube	List by Paint Grade		
				Core	Choice/Metallics	Custom
 Abound® and Accelerate® Permanent-Wall Hanger Kit Wall Hanger Kit (2 pieces) 2 1/8"W x 7/8"D x 66"H	HRVC35PCE	6.0	0.7	\$ 197	\$ 217	N/A
	HRVC35PCM	3.0	0.7	\$ 102	\$ 112	N/A
Wall Hanger Kit 4 1/4"W x 7/8"D x 66"H NOTES: Anchor devices are not supplied with these models. Refer to Abound® or Accelerate® Installation instructions for appropriate hardware. ⚠ Attachment to masonry walls is not recommended.						

Specify paint

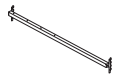

Worksurface-to-Wing Panel Bracket

24"W	HWSR24	2.5	0.4	\$ 50	N/A	N/A
30"W	HWSR30	3.0	0.4	\$ 50	N/A	N/A
36"W	HWSR36	3.5	0.5	\$ 50	N/A	N/A
42"W	HWSR42	4.0	0.5	\$ 50	N/A	N/A
48"W	HWSR48	4.5	0.6	\$ 50	N/A	N/A

NOTES:

- To be used when the adjacent wing panel is wider than the worksurface depth.
- Specify support to the same width as your adjacent wing panel, not the depth of your worksurface.
- Support spans the entire width of the wing panel.
- Supports are non-handed.

How to specify

<p>Select Model Number from above</p> <p>H R V C 3 5 P C E . T 1 </p>	<p>1st Option</p> <p>Select Paint Color</p> <p>See page 309</p>
--	--

Standing-Height Worksurface Supports

GSA SIN 711-2



- ▶ O-leg glides have 2" adjustability.
- ▶ Shared O-legs create a cleaner aesthetic in all applications where two legs are used side-by-side.
- ▶ O-Leg to Panel Attachment Brackets are used to connect Voi® O-Legs to a systems panel for additional worksurface rigidity.
- ⚠ O-legs may only be attached to worksurfaces, not storage units.

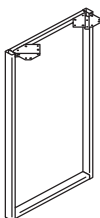

Description	Model	Ship Weight	Cube	List Price by Paint Grade	
				Core	Metallics
Standing-Height O-Leg Support for Worksurfaces 24"D x 41"H	HLSL24410	16	5.3	\$ 375	\$ 381
30"D x 41"H	HLSL30410	17	6.5	\$ 419	\$ 425

NOTES: Ship fully assembled, 1/package. Non-handed.

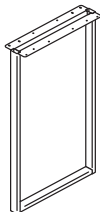

Standing-Height O-Leg Shared Support for Worksurfaces 24"D x 41"H	HLSL2441SL	16	5.3	\$ 422	\$ 428
30"D x 41"H	HLSL3041SL	17	6.5	\$ 468	\$ 474

NOTES: Ship fully assembled, 1/package. Non-handed.

How to specify

Select Model Number from above

H | L | S | L | 2 | 4 | 4 | 1 | 0 | .

1st Option

Select Paint Color

See page 309

T | 1 |

▶ 28"H fits under all HON worksurfaces and desk shells.

▶ Ball-bearing suspension on file drawer (90% extension), and box drawer (90% extension on both drawers).

▶ File drawers have high sides for filing front-to-back.
▶ Available in "R" pull only.

⚠ **Freestanding models must be used under a worksurface only.**

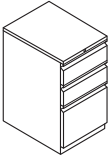
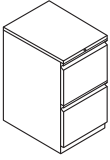
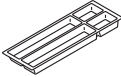

	Description	Model	Ship Weight	Cube	List by Paint Grade		
					Core	Choice/Metallics	Custom
	Standard Height Freestanding Support Pedestals — Box/Box/File						
	15"W x 19 7/8"D x 28"H	HVFB20R	89.0	7.0	\$ 466	\$ 494	\$ 510
	15"W x 22 1/8"D x 28"H	HVFB23R	95.0	8.0	\$ 480	\$ 508	\$ 525
	Standard Height Freestanding Support Pedestals — File/File						
	15"W x 19 7/8"D x 28"H	HVFF20R	88.0	7.0	\$ 466	\$ 494	\$ 510
	15"W x 22 1/8"D x 28"H	HVFF23R	94.0	8.0	\$ 480	\$ 508	\$ 525
	Optional Pencil Tray						
	⚠ For use with mobile and freestanding pedestal models shown above.	HV-UT1	0.5	0.1	\$ 58	N/A	N/A

desks workstations storage & files seating tables education/learning accessories bundles index

How to specify	Select Model Number from above	1st Option	2nd Option
	H V F B 2 0 R .	Select Lock Option L Lock (no upcharge) L .	Select Paint Color See page 309 P

Voi® Laminate Support Pedestals

GSA SIN 711-3



- ▶ Please see Voi® section of the pricer for full Voi® laminate offering, which is compatible with all HON systems series.
 - ▶ Voi® Support and Power-Ready Pedestals can be used with worksurfaces.
 - ▶ A variety of pedestals, end panels, and O-legs can be combined to create a conventional or contemporary desk.
 - ▶ Chassis and drawer front woodgrain and solid laminates are specified separately (see SIF options below).
 - ▶ File drawers accept hanging folders in letter or legal size.
 - ▶ Multiple handle locations possible per customer preference.
 - ▶ Ships with one handle per drawer.
 - ▶ Drawer Organizer model HLSDRWORG works with box drawers.
 - ▶ Box and file drawers operate on ball-bearing suspension with full extension.
 - ▶ Adjustable hex leveling glides allow floor-standing furniture to be easily leveled without lifting the unit; glides have 1/4" adjustable range.
- ⚠ Locking units equipped with HON "One Key" interchangeable core removable locks. Keyed alike core must be ordered separately.
- ⚠ Pedestals ship fully assembled but must attach to a worksurface with a quick release bracket, provided. Pedestals are non-handed and are interchangeable.



	Description	Model	Ship Weight	Cube	L1 List	L2 Upcharges	
						Chassis	Front
	Support Pedestals — Box/Box/File						
	16"W x 20"D x 28½"H	HLSL2028B	73	7.3	\$ 609	\$ 15	\$ 10
	16"W x 24"D x 28½"H	HLSL2428B	85	8.5	\$ 674	\$ 20	\$ 10
	16"W x 30"D x 28½"H	HLSL3028B	105	10.5	\$ 759	\$ 25	\$ 10
	NOTES: Top box drawer does not lock.						
	Support Pedestals — File/File						
	16"W x 20"D x 28½"H	HLSL2028F	72	7.3	\$ 609	\$ 15	\$ 10
	16"W x 24"D x 28½"H	HLSL2428F	84	8.5	\$ 674	\$ 20	\$ 10
	16"W x 30"D x 28½"H	HLSL3028F	104	10.5	\$ 759	\$ 25	\$ 10
	Slim Profile Pedestals — Box/Box/File						
	9½"W x 24"D x 28½"H	HLSL2428S	69	6.9	\$ 669	\$ 20	\$ 10
	9½"W x 30"D x 28½"H	HLSL3028S	56	5.6	\$ 734	\$ 25	\$ 10
	NOTES: Top box drawer does not lock.						

How to specify	1st Option	2nd Option	3rd Option
Select Model Number from above	Select Chassis Laminate See page 175	Select Drawer Front Laminate See page 175	Select Pull Color
H L S L 2 0 2 8 B .	N .	N .	T4 Champagne T1 Platinum WHIT White T 4

Icon Legend on page 10

- ▶ Voi® Support and Power-Ready Storage can be used with Systems Worksurfaces.
- ▶ Ships with one handle per drawer on all units.
- ▶ A variety of pedestals, end panels, and O-legs can be combined to create a conventional or contemporary desk.
- ▶ Bookcase can only mount exterior facing under a worksurface.
- ▶ Chassis and drawer front woodgrain and solid laminates are specified separately (see SIF options below).
- ▶ File drawers accept hanging folders in letter or legal size.
- ▶ Multiple handle locations possible per customer preference.
- ▶ Storage accessory model HLSLDRWORG works with box doors.
- ▶ Standard box drawers operate on ball-bearing suspension with full extension. File, lateral, and wide box drawers operate on ball-bearing suspension with full extension.
- ▶ Adjustable hex leveling glides allow floor-standing furniture to be easily leveled without lifting the unit; glides have 2" adjustable range.
- ▶ When using two lateral files, a 60" worksurface cannot be used, a 66" worksurface must be specified, which will show a gap.
- ⚠ **Cannot fit binders on both shelves of bookcase model HLSL240BC and HLSL300BC.**
- ⚠ **Must be specified under a worksurface 60"W or wider.**
- ⚠ **Locking units equipped with HON "One Key" interchangeable core removable locks. Keyed alike core must be ordered separately.**

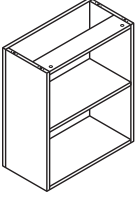
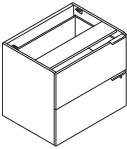
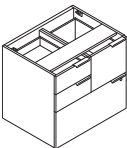

Description	Model	Ship Weight	Cube	L1 List	L2 Upcharges	
					Chassis	Front
 <p>Bookcase Support 24"W x 12"D x 28½"H 30"W x 12"D x 28½"H</p>	HLSL240BC E♦A	60	3.0	\$ 452	\$ 20	N/A
	HLSL300BC E♦A	75	3.0	\$ 474	\$ 25	N/A
 <p>Lateral File — 2 Drawer 31⅝"W x 24"D x 28½"H</p>	HLSL2430L	121	15.6	\$1048	\$ 35	\$ 20
 <p>Multi File Lateral File 31⅝"W x 24"D x 28½"H NOTES: Box drawers do not lock.</p>	HLSL2430MF	163	15.6	\$1243	\$ 35	\$ 20

How to specify	1st Option	2nd Option	3rd Option
<p>Select Model Number from above</p> <p>H L S L 2 4 3 0 L . N .</p>	<p>Select Chassis Laminate See page 175</p> <p>N .</p>	<p>Select Laminate See page 175</p> <p>N .</p>	<p>Select Pull Color</p> <p>T4 Champagne T1 Platinum WHIT White T 4 </p>







Paper Management / Markerboards

GSA SIN 711-1, 711-2

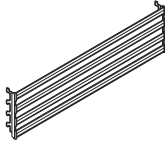

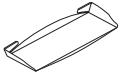
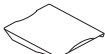
- ▶ Paper management bar attaches to Systems panels/frames to accommodate work flow accessories.
- ▶ Paper Shelf holds letter size paper and inter-office envelopes.
- ▶ Folder Bin accommodates manila envelopes and can be hung from other folder binds to maximize storage.
- ▶ Phone Tray holds telephone at optimum ergonomic angle.
- ▶ CD/Pencil Holder can store up to 3 CD jewel cases, sticky pads or writing instruments.
- ▶ Accessory Shelf holds office supplies and personal effects.
- ▶ Sorter Tray provides 3 slots for organizing files.



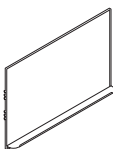

	Description	Model	Ship		List by Paint Grade	
			Weight	Cube	Core	Choice/Metallics
 SIN 711-1	Paper Management Support Bars					
	24"W x 5"H	HNPMBSW24	1.3	0.4	\$ 179	\$ 191
	30"W x 5"H	HNPMBSW30	1.5	0.5	\$ 190	\$ 202
	36"W x 5"H	HNPMBSW36	2.0	0.6	\$ 197	\$ 209
	42"W x 5"H	HNPMBSW42	5.0	0.7	\$ 208	\$ 220
	48"W x 5"H	HNPMBSW48	7.0	0.8	\$ 216	\$ 228
	60"W x 5"H	HNPMBSW60	9.0	0.9	\$ 246	\$ 258
	⚠ Recommended weight capacity not to exceed 80 pounds.					
 SIN 711-2	Paper Shelf 15"W x 9 1/2"D x 2"H	HPPMPS	2.0	0.3	\$ 90	\$ 102
 SIN 711-2	Accessory Shelf 21 3/4"W x 7"D x 2"H	HPPMAS	2.0	0.3	\$ 94	\$ 106
 SIN 711-2	Phone Tray 9"W x 10 3/4"D x 2"H	HPPMPT	2.0	0.3	\$ 115	\$ 127
 SIN 711-2	CD/Pencil Holder 5 1/4"W x 1 1/2"D x 5"H	HPPMPB	1.0	0.2	\$ 94	\$ 106
 SIN 711-2	Sorter Tray 6"W x 10"D x 2 1/2"H	HPPMST	2.0	0.3	\$ 123	\$ 135
 SIN 711-2	Folder Bin 12 1/4"W x 1 1/4"D x 9"H	HPPMFB	2.0	0.3	\$ 94	\$ 106

	Description	Model	Ship		
			Weight	Cube	List
 SIN 711-1	Markerboards				
	36"W x 24"H	HHMRK36	15	3.2	\$ 468
	42"W x 24"H	HHMRK42	17	4.0	\$ 508
	48"W x 24"H	HHMRK48	19	4.6	\$ 547
	⚠ No color specification required.				

How to specify	Select Model Number from above H N P M B S W 2 4 .	1st Option Select Paint Color See page 309 P
----------------	---	--

- ▶ Choose from a variety of task lights that mount under overhead storage or sit on the worksurface.
- ▶ LED Task Lights have a wide range of motion for precise placement.



	Description	Model	Ship		List
			Weight	Cube	
	Articulating Desk Lamp Articulating Desk Lamp w/ Occupancy Sensor <ul style="list-style-type: none"> • Color: Matte Silver. • Full-range dimming from 10% to 100%. • Designed for 50,000 hours of life. • Occupancy sensor is built into the head of the lamp and will automatically shut the lamp off after 6 minutes of undetected movement. • Base swivel is 180 degrees. • Uses only 5 watts of energy. • Light comes with a silver 9' 4" power cord. • Base diameter is 7.5". • 3500K Color Temperature. • 80 Color Rendering Index. • TAA Compliant. 	HLED1 HLED10C	1.2 [S] 1.2 [S]	6.5 6.5	\$ 350 \$ 428
		Task Desk Lamp <ul style="list-style-type: none"> • Color: Brushed Nickel. • Full-range dimming from 10% to 100%. • Designed for 50,000 hours of life. • Lamp is 15.83" tall. • Desk lamp does not articulate at base. The pivoting head provides custom positioning, as it can be twisted 360 degrees. • Uses only 5 watts of energy. • Light comes with a silver 9' 4" power cord. • Base diameter is 6.7". • 3500K Color Temperature. • 80 Color Rendering Index. • TAA Compliant. 	HLED2	0.7 [S]	3.0

How to specify

Select Model Number from above

H | L | E | D | 1

Not on GSA Contract

Electrical Accessories

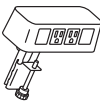
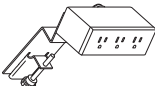
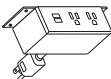
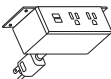

	Description	Model	Ship		List
			Weight	Cube	
 <p><i>Open Market</i></p>	Power & Data Center 2 Receptacles 2 Data Accessory <ul style="list-style-type: none"> • Standard with two receptacles and openings for two data ports. • 6' power cord with standard three-prong plug. • Fits on any worksurface with a 4" overhang. • UL Listed. 	HCOMDOME2	2.5 [S]	0.2	\$ 259
⚠ Color finish coordinates with HON's Loft. Specify LOFT when ordering. Example: HCOMDOME2.LOFT.					
 <p><i>Open Market</i></p>	Power Modules 3 Receptacles with Worksurface Clamp 3 Receptacles with Under-Worksurface Mounting Bracket 2 Receptacles 2 USB with Worksurface Clamp 2 Receptacles 2 USB with Under-Worksurface Mounting Bracket <ul style="list-style-type: none"> • 6' power cord with standard three-prong plug. • Under-worksurface mounting bracket models work with any top that has a 5" x 5" square clearance. • Worksurface clamp models work on any top with a 4" overhang. • UL Listed. 	HPWRMOD3WC HPWRMOD3UWM HPWRMOD2WC HPWRMOD2UWM	2.3 [S] 2.3 [S] 2.3 [S] 2.3 [S]	0.2 0.2 0.2 0.2	\$ 272 \$ 272 \$ 436 \$ 436
 <p>Model HPWRMOD3WC shown</p>					
 <p>Model HPWRMOD2UWM shown</p>					
⚠ Color finish coordinates with HON's Charcoal or White. Specify S for Charcoal or WHIT for White when ordering. Example: HPWRMOD3WC.S.					

Icon Legend on page 10



Optional Accessories — Monitor Arm

GSA SIN as Noted

HON

- ▶ Arms fold back to post to allow more desktop room.
- ▶ Arms feature double extension, allowing 20"+ of back and forth movement.
- ▶ Cable management on both pole and arm assemblies.
- ▶ Counterbalance adjustment provides stability for monitors up to 17 lbs per arm.
- ▶ Made of high quality aluminum alloy material.

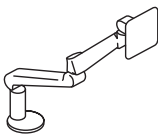
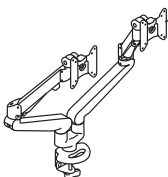

	Description	Model	Ship Weight	Cube	List
 <p>SIN 711-1, 711-2</p>	<p>Single Monitor Arm — Effortless Adjustment</p> <ul style="list-style-type: none"> • Effortless adjustment. • Height adjusts from 6½" to 19½" for a total range of 13". • Monitor extends 21". • Monitor retracts 3½" to save space. • 360° swivel at two points with folding capabilities. • Monitor tilts +30" to -25". • Enclosed cable management. • Includes desk clamp or grommet mount. <p>⚠ Silver finish only, no specification needed.</p>	H5210	11	1.3	\$ 497
 <p>SIN 711-1, 711-2</p>	<p>Dual Monitor Arm — Effortless Adjustment</p> <ul style="list-style-type: none"> • Single mount with dual monitor adjustment. • Effortless adjustment. • Height adjusts from 6½" to 19½" for a total range of 13". • Monitor extends 21". • Monitor retracts 3½" to save space. • 360° swivel at two points with folding capabilities. • Monitor tilts +30" to -25". • Enclosed cable management. • Dual screen models allow screens to be aligned horizontally for optimal ergonomic positioning. • Includes desk clamp or grommet mount. • Includes VESA plate for 75 x 75mm or 100 x 100mm (converter plate for 100mm x 200mm is available separately). <p>⚠ Silver finish only, no specification needed.</p>	H5220	15	1.8	\$ 889
 <p>SIN 711-1, 711-2</p>	<p>CPU Holder</p> <ul style="list-style-type: none"> • Vertically mounts to underside of worksurface. • 360° swivel. • Supports up to 55 lbs. • Height adjustable from 16" to 22" below worksurface. • Width adjustable to accept units from 3¼" to 6". <p>⚠ Silver finish only, no specification needed.</p>	HCPU	16	0.5	\$ 230
 <p>Open Market</p>	<p>Polymer Center Drawer</p> <ul style="list-style-type: none"> • Color: Black. • Material: ABS. • Opening Requirements: 23"W x 16¼"D x 2"H. • Retracts on 16" ball bearing slides. • Can be used on worksurfaces with Coordinate™ and basyx by HON® Height Adjustable Bases as long as it is attached with spacer model HKBS. • Can store up to 25 lbs. <p>⚠ Black finish only, no specification needed.</p>	HCD1	7	0.5	\$ 96

How to specify

Select Model Number
from above









H | 5 | 2 | 1 | 0

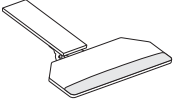

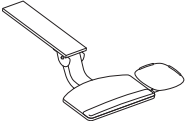
Icon Legend on page 10

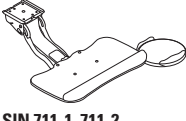
⚠ Black only finish, no specification needed.

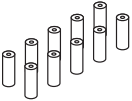
A B J

	Description	Model	Ship Weight	Cube	List
 <p>SIN 711-1, 711-2</p>	<p>Articulating Arm with Keyboard Platform</p> <ul style="list-style-type: none"> • 17" glide track. • Spring assisted. • Height adjustment 6¼" (1¼" above and 5" below track). • Tilt: +10°/-15°. • 25" cut corner platform. • Accommodates keyboard and mouse on same level. • Detachable palm rest. • Cord management clips included. <p>⚠ Black only finish, no specification needed.</p>	H1706	16 	1.4	\$ 440
 <p>SIN 711-1, 711-2</p>	<p>Articulating Arm with Convertible Keyboard Platform</p> <ul style="list-style-type: none"> • 21" glide track. • Lift and lock height adjustment. • Height adjustment 7" (2½" above and 4½" below track). • Release handle for independent tilt adjustment. • Tilt: +/-15°. • Independent tilt and swivel mousing platform. • Positions platform flush with worksurface. • Mouse can be used in-line, over, or forward at platform height or above. • Mouse can be placed at platform height or above height. • Left or right handed mousing; no tools required. • Detachable palm rest. • Cord management clips included. <p>⚠ Black only finish, no specification needed.</p>	H2107	16 	1.3	\$ 472
 <p>SIN 711-1, 711-2</p>	<p>Sit to Stand Arm with Keyboard Platform</p> <ul style="list-style-type: none"> • Sit to stand application. • No knob or lever for adjustment, simply lift into place. • One-hand tilt adjustment for maximum flexibility. • Height adjustment without levers. • +10°/-20° tilt adjustment. • Height adjustment 12½" (7" above and 5½" below). • For use on surfaces 24" or deeper. • Tilt and swivel mouse surface with gel palm rest. • Detachable palm rest. • Mouse pad can mount right or left. <p>⚠ Black only finish, no specification needed.</p>	H2516	17 	1.6	\$ 551
 <p>Open Market</p>	<p>Keyboard Spacer</p> <ul style="list-style-type: none"> • For use when attaching a keyboard tray to Coordinate™ and Voi® or Systems Worksurface with an external channel. • The kit includes ten cylinder spacers and ten screws. • Spacers are ¾"W x 2¼"H. • Specify one kit per keyboard tray. 	HKBS	1 	0.8	\$ 80

How to specify

Select Model Number from above

H | 1 | 7 | 0 | 6 |







   Icon Legend on page 10

Optional Accessories — Desktop Sit-to-Stand

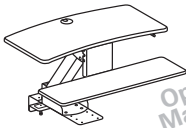
Not on GSA Contract

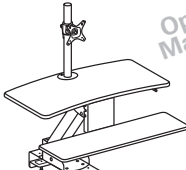

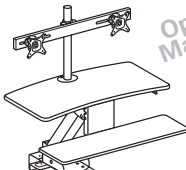
- ▶ These products are designed to allow the user to transition from seating position to standing position throughout the workday.
 - ▶ Gas-assist lever-operated mechanism with positive stop.
 - ▶ Clamp mount compatible with worksurfaces depths of 20"-30".
 - ▶ Clamp requires 3.5" of clearance along back edge of worksurface.
 - ▶ Black seamless worksurfaces.
 - ▶ Silver powder coated metal components.
 - ▶ Lowers below worksurface level on 24" and 30"D worksurfaces.
 - ▶ All models contain a large primary worksurface and a smaller keyboard / mouse surface.
 - ▶ Beveled edges for sleek appearance and comfort while typing.
 - ▶ Monitor arms include height, width, and swivel adjustment.
- ⚠ **Not recommended for use on mobile (castered) worksurfaces.**

Description	Model	Ship Weight	Cube	List
 <p>Directional™ Desktop Sit-to-Stand Device</p> <p>NOTES: Does not include a monitor arm and is suitable for laptops and/or monitors on their original stands.</p> <p><i>Open Market</i></p>	HS1100	60 	3.2	\$ 525
 <p>Directional™ Desktop Sit-to-Stand Device with Single Monitor Arm</p> <p>NOTES: Includes a monitor arm for a single monitor.</p> <p><i>Open Market</i></p>	HS1101	62 	3.2	\$ 615
 <p>Directional™ Desktop Sit-to-Stand Device with Dual Monitor Arm</p> <p>NOTES: Includes a monitor arm for dual monitors.</p> <p><i>Open Market</i></p>	HS1102	63 	3.2	\$ 700

Mounting and Compatibility:

- This product is intended to be installed on commercial-grade worksurfaces in good condition.
- Compatible with freestanding worksurfaces 24"-30"D or panel-supported worksurfaces 24"-30"D.
- Not for use on mobile worksurfaces.

Clamp Mount

Use when 3.5" minimum overhang is available

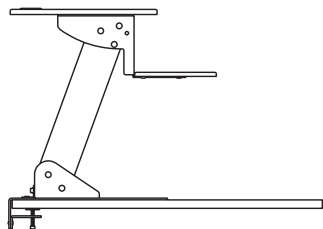

Screw Mount

Use when no overhang is available. Worksurface must be minimum 1" thick.

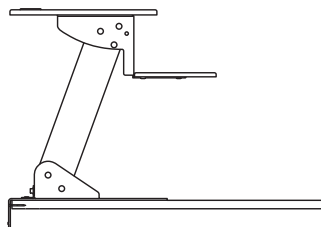

How to specify

Select Model Number from above

H S 1 1 0 0

⚠  Icon Legend on page 10

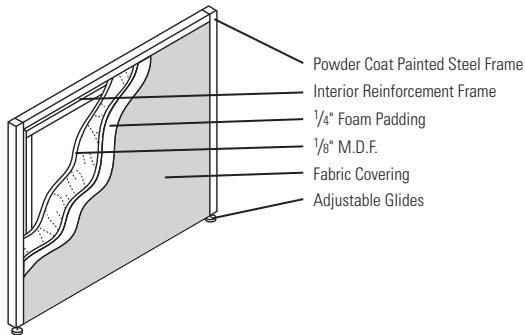
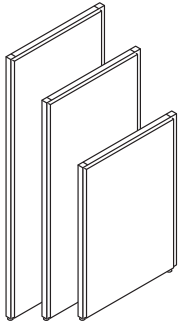
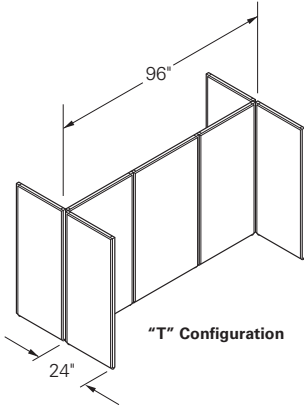
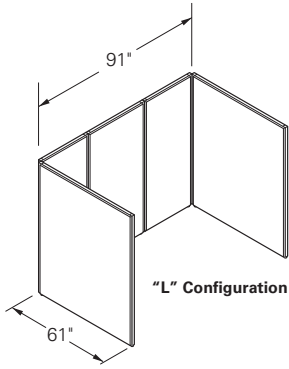

FEATURES

Panels

- Use Versé as a privacy panel (stand alone) to create space division.

QuickConnect (See page 368 for more details on this hardware.)

- Our QuickConnect connectors allow for easy installation. Simply snap on the connectors at the top and bottom of the panel and slide the panels together. There are only two connectors to specify for almost all configurations.

Storage

- Shelving capabilities. Each shelf width must match width of panel.

PANEL DIMENSIONS AND GROWTH ALLOWANCES

- All panel runs must be supported at each end of the panel run and supported at least every 8' within the panel run (maximum of 8' between supports).
- Support can be in the form of an adjustable wall bracket or return panel at 90° to the run.
- When using an "L" configuration, the return panel must measure at least 60% (minimum 36") of the unsupported run.
- When using a "T" configuration, each return panel must measure at least 20% of the unsupported run.
- Return panels can be no more than 24" lower than the panel height in the unsupported run.
- When used in conjunction with hanging shelves, panel width must match width of shelf.

VERSÉ PANELS

Includes

- Adjustable glides with all panels.

What Do I Need?

- QuickConnect Connectors.

Special Notes

- Versé panels feature a soft, padded look.
- Panels packed two per carton when possible.

CONNECTING HARDWARE

Versé QuickConnect User Instructions

- Versé QuickConnect is easy to install. Simply snap on the connectors at the top and bottom of the panel and slide the panels together. There are only two connectors to specify for almost all configurations, including multi-height connections.
- 180° Straight Connector – use when connecting two panels together for a straight connection or for multi-height straight connections.
- 90° Corner Connector – use for 2-way, 3-way and 4-way corner connections. Only one pair is needed per corner connection or for multi-height corner connections.

Connection Type	Connectors Needed
Straight	1 pair – 180°
2-way (L)	1 pair – 90°
3-way (T)	2 pair – 90°
4-way (X)	3 pair – 90°

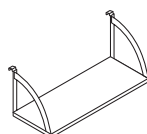
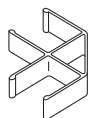
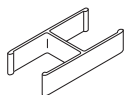

HARDWARE

Special Notes

- Connectors add to the overall dimensions of the panel installation.
- These connector dimensions are important when space planning and sizing your panel layout.
- All hardware items may ship by a parcel service.
- Use HBV-PBS bracket with freestanding furniture for optimal workstation rigidity.

SHELVES

- Steel shelves are 14 ½" high.
- End brackets included.
- Must match panel width.
- Easy assembly; no tools required.

PANEL FABRIC ORDERING CODES

PRICE CODE II

GN Element

Flint	GN65
Indigo	GN67
Latte	GN73
Millet	GN72
Parchment	GN53
Sea	GN74
Veil	GN13
Warm Beige	GN55
Wisp	GN75

2310 Seaway

Shadow2310SHD
Slate2310SLA
Gray2310GRE

PAINTS ORDERING CODES (Panel, T-base, Shelf and Connectors)

- P** Black
- Q** Light Gray
- L** Putty









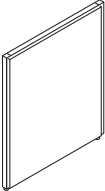

► **basyx** by HON® 5-year Limited Warranty.

► Panels offer privacy as room dividers or in desk-wrap applications.

► Panels feature 1" powder coat painted steel frame construction with interior reinforcement, 1/4" foam padding and 1/8" M.D.F.

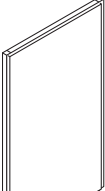
► All panels include adjustable glides.
 ► To free-stand a single Versé panel or to stabilize the end of a panel run, order T-base stabilizing foot shown on page 430.

► See page 428 for available fabrics and finishes.

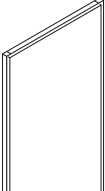
	Description	Model	Ship Weight	Cube	List
 <p>Open Market</p>	42" H Panel				
	42" H x 24" W	HBV-P4224	18 	1.8	\$ 280
	42" H x 30" W	HBV-P4230	22 	2.2	\$ 290
	42" H x 36" W	HBV-P4236	24 	2.7	\$ 294
	42" H x 42" W	HBV-P4242	33 	3.1	\$ 296
	42" H x 48" W	HBV-P4248	34 	3.6	\$ 309
	42" H x 60" W	HBV-P4260	36	4.4	\$ 333
	42" H x 72" W	HBV-P4272	48	5.3	\$ 382
	NOTES: All panels include adjustable glides.				
 <p>Open Market</p>	60" H Panel				
	60" H x 24" W	HBV-P6024	30 	2.5	\$ 311
	60" H x 30" W	HBV-P6030	33 	3.2	\$ 321
	60" H x 36" W	HBV-P6036	35 	3.8	\$ 322
	60" H x 42" W	HBV-P6042	37	4.4	\$ 338
	60" H x 48" W	HBV-P6048	42	5.0	\$ 344
	60" H x 60" W	HBV-P6060	54	6.4	\$ 359
	60" H x 72" W	HBV-P6072	60	7.5	\$ 420
	NOTES: All panels include adjustable glides.				
 <p>Open Market</p>	72" H Panel				
	72" H x 24" W	HBV-P7224	39	3.0	\$ 350
	72" H x 30" W	HBV-P7230	40	3.8	\$ 357
	72" H x 36" W	HBV-P7236	44	4.5	\$ 376
	72" H x 42" W	HBV-P7242	46	5.2	\$ 393
	72" H x 48" W	HBV-P7248	50	6.0	\$ 401
	72" H x 60" W	HBV-P7260	62	7.5	\$ 444
	NOTES: All panels include adjustable glides.				

How to specify	1st Option	2nd Option
<p>Select Model Number from above</p> <p>H B V - P 4 2 2 4 .</p>	<p>Select Upholstery See page 428</p> <p>G N 6 5 .</p>	<p>Select Trim Color</p> <p>P Black Q Light Gray L Putty See page 428 P</p>











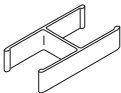

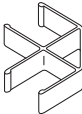







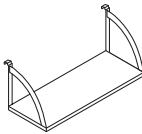







 Icon Legend on page 10

Versé® Panel System

Not on GSA Contract



- ▶ **basyx by HON® 5-year Limited Warranty.**
- ▶ T-base stabilizing foot optional.
- ▶ Extruded aluminum connectors are sold in pairs and are used at top and bottom of panels.
- ▶ Shelves hang over the top of panels; the supporting panel must match the width of the shelf.
- ▶ Shelves feature steel construction with powder coat paint finish.
- ▶ Shelves ship easy to assemble – no tools required.
- ▶ See page 428 for available fabrics and finishes.

	Description	Model	Ship Weight	Cube	List
 Open Market	180° QuickConnect Straight Panel Connector Pair NOTES: 180° connector to be used to connect two panels in a straight connection or for multi-height straight connections.	HBV-QC180	0.1 	0.3	\$ 20
 Open Market	90° QuickConnect Panel Connector Pair NOTES: 90° connector to be used for 2-way, 3-way or 4-way corner connections, or for multi-height connections.	HBV-QC90	0.1 	0.3	\$ 20
 Open Market	Wall Bracket	HBV-PWB1	0.2 	0.3	\$ 46
 Open Market	Panel-to-Worksurface Bracket Pair	HBV-PBS	0.3 	0.3	\$ 39
 Open Market	T-Base Stabilizing Foot 18¾" long NOTES: Adds 1¼" to the height of the panel.	HBV-TBASE	6.0 	0.3	\$ 42
 Open Market	Hanging Shelves 24"W x 12¾"D 30"W x 12¾"D 36"W x 12¾"D 42"W x 12¾"D 48"W x 12¾"D 60"W x 12¾"D NOTES: Shelves hang over the top of panels. Supporting panel must match the width of the shelf.	HBV-VSH24   HBV-VSH30   HBV-VSH36   HBV-VSH42   HBV-VSH48   HBV-VSH60  	9.0  10.0  12.0  13.0  14.0  19.0 	1.2 1.5 1.8 2.0 2.3 2.9	\$ 178 \$ 198 \$ 216 \$ 233 \$ 266 \$ 303

How to specify	Select Model Number from above H B V - Q C 1 8 0 . P 	1st Option Select Trim Color See page 428
----------------	---	---

  Icon Legend on page 10

LATERAL FILES

Advantages:

a) The most efficient means of conventional filing; b) Ideal for active filing in workstations, where higher volume capacity is necessary and retrieval is frequent

Considerations:

2-drawer steel lateral files fit under standard-height worksurfaces when using panel systems.

VERTICAL FILES

Advantages:

a) Economical; b) The most widely used filing method; c) requires minimal floor space

Considerations:

Vertical files are best suited for long-term storage, where retrieval is less frequent. For larger banks of files, lateral files are more space-efficient than vertical files.

SHELF FILES

Advantages:

a) The highest density method of filing; b) Specially designed for end-tab long-term filing

Considerations:

Ideal for medical or dental offices, available as open shelves or with flipper doors.

BOOKCASES

Advantages:

a) These units are ideal for binders, reference books or other items; b) Available with your choice of fixed or movable shelves

Considerations:

If working with panel systems, it is more attractive to specify units that are lower than the panel height.

FILING TECHNIQUES

Type	Standing Files	Hanging Files	End-tab Files
Advantages	Inexpensive. Uses existing file folders.	Easier organization and identification of the file folders. Files viewed from top. Remaining files hold their place when folders are removed. Easier to re-stock.	Easiest and fastest file identification. Files viewed from side. Preferred solution for health care, insurance and other critical files with frequent retrieval. Easiest to re-stock.
Requirements	Follower block or Dividers	Hangrails or high-drawer sides	Front-access shelves
Can be used in	<ul style="list-style-type: none"> Vertical files (front-to-back only) Lateral files (side-to-side only in drawers or roll-out shelves) Shelf files (side-to-side only) 	<ul style="list-style-type: none"> Vertical files (front-to-back only) Lateral files (front-to-back or side-to-side in drawers or roll-out shelves) 	<ul style="list-style-type: none"> Lateral files (side-to-side only in roll-out shelves or fixed shelves) Shelf files (side-to-side only — ideal for high-density)

LATERAL FILING OPTIONS

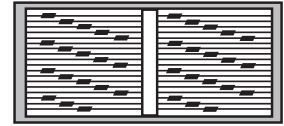

Front-to-back filing:

30" wide files*: 30½" of filing with letter/letter rows.

36" wide files*: 30½" of filing with letter/letter, legal/legal, or letter/legal rows.

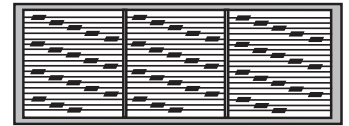

42" wide files**: 45¼" of filing with 3 rows letter or 30½" of 2 rows legal, or 2 standard printout rows.

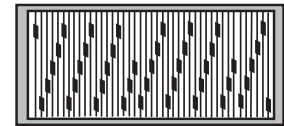

Side-to-side filing:

30" wide files: 27" of filing with letter or legal.

36" wide files: 33" of filing with letter or legal.

42" wide files: 39" of filing with letter or legal.

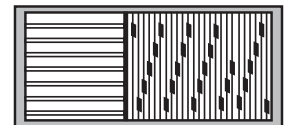

Combination filing:

(front-to-back with side-to-side in one drawer)

30" wide files: not recommended.

36" wide files: 15¼" of front-to-back filing and 20¼" of side-to-side legal filing.

42" wide files: 15¼" of front-to-back filing and 26¼" of side-to-side legal filing.

* Requires H919491 optional hangrails.

** Requires H919492 optional hangrails.

Contain®/Flagship®/Brigade® Series Pedestals Utilization with 38000 Series and 66000 Series.

Pedestal Depths	Abound® and Accelerate® Panel-Hung Worksurfaces			66000 StationMaster		38000 Series Modular Desks		
	18" Deep	24" Deep	30" Deep	24" Deep	29½" Deep	24" Deep	30" Deep	36" Deep
16¼" Deep	•	•	•	•	•	•	•	•
22¼" Deep		•	•		•	•*	•	•
28¼" Deep			•				•	•

* Cannot attach 22¼"D Hanging Pedestal.

WORKING WITH STORAGE PEDESTALS

Storage Pedestals are available in 5 styles:

- Box/File Mobile(Model Nos. beginning with HSPM)
- Freestanding(Model Nos. beginning with HSPF)
- Hanging(Model Nos. beginning with HSPH)
- Worksurface Supporting**(Model Nos. beginning with HSPS)
- Under Worksurface Mobile(Model Nos. beginning with HSPM)

Worksurface height supporting pedestals have a taller base plate, resulting in a taller overall cabinet height. Consideration must be made to ensure that units align visually with each other. The accompanying chart will help you select the correct pedestal for your application.

Pedestal Models (Nos. begin with)	Style	Overall Height	Base Height	Spacer Required Below Worksurface
HSPM or H15	Box/File mobile	22¼"	N/A	N/A
HSPF	Freestanding	28"	3½"	NO
HSPH or H14	Hanging	19¼"	N/A	N/A
HSPS or H19 or H36	Worksurface supporting**	28"	3¼"	NO
HSPM or H18 or H33	Under Worksurface mobile	28"	3¼"	NO

** Units will support conventional 29½"H worksurfaces, WITHOUT SPACERS.

HON Lateral Files at a glance

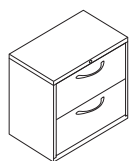

Flagship®

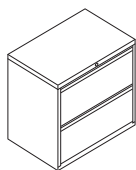
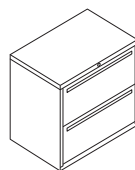
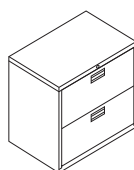
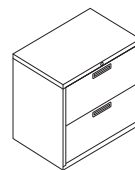
Brigade®
Model H872LBrigade®
Model H772LBrigade®
Model H672L

Model H572L

Flagship Series lateral files are 18"D.

Brigade® 800, 700, 600 and 500 Series lateral files are all 19¼"D.

Series	Widths Available	Heights Available	Suspension Style	Usage	Pull	Safety Interlock	Lock	Features
Flagship®, Brigade® 800, 700, 600 Drawer, Rollout	30" 36" 42"	2 dwr 3 dwr 4 dwr 5 dwr	Heavy Duty ball-bearing (telescoping)	Intensive	Flagship Series 3 Pulls available. See page 434. Brigade® 800 Series Full-width radius designer style with magnetic label holders Brigade® 700 Series Full-width designer style with magnetic label holders Brigade® 600 Series Anodized Aluminum w/label magnetic holder	Positive Mechanical	Core removable	<ul style="list-style-type: none"> • 4 leveling glides • 2 hangrails per drawer • Rack resistant case reinforcement
500	30" 36"	2 dwr 4 dwr 5 dwr ^{††}	Ball-bearing	Moderate	Color-matched polymer	Positive Mechanical	Core removable	<ul style="list-style-type: none"> • 4 leveling glides • 2 hangrails per drawer

^{††} 500 Series 5 drawer model available in 36"W only.

All products meet or exceed ANSI/BIFMA and ISTA performance standards.

CONFIGURATION OPTIONS — LATERAL FILES

A. Standard drawers	B. Receding door with roll-out shelf	Posting shelf															
Most popular. Holds: <ul style="list-style-type: none"> • Standing files • Hanging files • Letter, legal or A4 • Supplies Side-to-side standard, Front-to-back optional	More flexible. Holds: <ul style="list-style-type: none"> • End-tab files • Standing files • Hanging files • Letter, legal or A4 • Larger/boxed supplies Side-to-side standard, Front-to-back optional	Convenient for access, review and replacement of records; only available on select 5-high models.															
SERIES/SUFFIX: Heights Offered: 500L 2, 4, 5 <table border="1"> <tr><td>B</td></tr> <tr><td>A</td></tr> <tr><td>A</td></tr> <tr><td>A</td></tr> <tr><td>A</td></tr> </table> Widths Offered: 30", 36"	B	A	A	A	A	Brigade 600L, 700L, 800L 2, 3, 4, 5 <table border="1"> <tr><td>B</td></tr> <tr><td>AB</td></tr> <tr><td>AB</td></tr> <tr><td>AB</td></tr> <tr><td>A</td></tr> </table> Widths Offered: 30", 36", 42"	B	AB	AB	AB	A	Flagship 2, 3, 4, 5 <table border="1"> <tr><td>B</td></tr> <tr><td>A</td></tr> <tr><td>A</td></tr> <tr><td>A</td></tr> <tr><td>A</td></tr> </table> Widths Offered: 30", 36", 42"	B	A	A	A	A
B																	
A																	
A																	
A																	
A																	
B																	
AB																	
AB																	
AB																	
A																	
B																	
A																	
A																	
A																	
A																	
NOTE: AB designated drawers are available either as all "A" or all "B" within a cabinet.																	

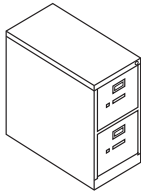

Model H212

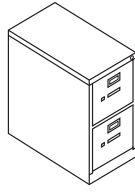

Model H312



Model HH322



Model H512

Vertical files listed below meet or exceed ANSI/BIFMA and ISTA performance standards. They are available in 15"W letter and 18 1/4"W legal widths.

Series	Depth	Heights Available	Suspension Style	Lock	Accepts Hanging Files	Features
210 Series	28 1/2"	2 dwr 4 dwr 5 dwr	Three-part telescoping, ball-bearing steel suspension	INCLUDED core removable	YES (Hangrails not required)	Spring-loaded follower block
310 Series	26 1/2"	2 dwr 4 dwr 5 dwr	Three-part telescoping, ball-bearing steel suspension	INCLUDED core removable	YES (Hangrails not required)	Spring-loaded follower block
H320 Series	26 1/2"	2 dwr 4 dwr	Full cradle suspension	INCLUDED core removable	YES (Hangrails not required)	Adjustable wire follower
510 Series	25"	2 dwr 4 dwr	Full cradle suspension	INCLUDED core removable	YES (Hangrails not required)	Adjustable wire follower

Storage and Files Ordering Information

For all paint options – see page 435.

HON

Pull Options for Contain[®] and Flagship[®] Storage

Suffix "A"

Satin Chrome
Arch Pull

Suffix "N"

Full Face Integral
Drawer Pull

Suffix "R"

Full Radius
Drawer Pull

			Flagship [®] Product ©	Contain [®] Product ©	Brigade Pedestals ©	Optional Laminate Tops © for Pedestals	Brigade 800, 700, 600 Lateral Files ©	500 Lateral Files ©	Brigade Overfiles ©	Optional Laminate Tops for Lateral Files and Contain [®] Credenzas ©	210 Series Vertical Files ©	310/4320 Series Vertical Files ©	510 Series Vertical Files ©	Brigade Storage Cabinets	Brigade 600 Series Shelf Files ©	FlameSafe Files	Brigade Steel Bookcases ©	Optional Laminate Tops © for Steel Bookcases	1870/1890 Series Bookcases
L1 LAMINATES		CODES																	
Woodgrain	Bourbon Cherry	H				•				•									•
	Cognac	COGN		•		•				•									•
	Harvest	C		•		•				•									•
	Mahogany	N		•		•				•									•
	Mocha	MOCH		•		•				•									•
	Natural Maple	D		•		•				•									•
	Pinnacle	PINC		•		•				•									•
	Shaker Cherry	F		•		•				•									•
Solid	Brilliant White	WHIT				•				•									•
	Charcoal	S				•				•									•
	Loft	LOFT				•				•									•
	Whitestone	K4				•				•									•
Patterned	Sheer Mesh*	A5				•				•									•
	Silver Mesh*	B9				•				•									•
	Steel Mesh*	A9				•				•									•
	Taupe Mesh*	A8				•				•									•
	Canyon Zephyr	K9				•				•									•
	Desert Zephyr	K8				•				•									•
	Shadow Zephyr	K1				•				•									•
	Gray	G2				•				•									•
	Grey Tigris	L6				•				•									•
	White	G1				•				•									•
L2 LAMINATES		CODES																	
Woodgrain	Lowell Ash NEW! 1/30/2017	LLA1		•						•									
	Natural Recon NEW! 1/30/2017	LNR1		•						•									
	Phantom Ecrú NEW! 1/30/2017	LPE1		•						•									
	Portico Teak NEW! 1/30/2017	LPT1		•						•									
	Skyline Walnut NEW! 1/30/2017	LSW1		•						•									

NOTES: Arch pulls available in Satin Chrome only.

* Mesh laminate colors will have the following pre-set edgeband colors:

Laminate	Edge
Sheer Mesh	Muslin
Silver Mesh	Loft
Steel Mesh	Charcoal
Taupe Mesh	Greige

		Flagship® Product ①	Contain® Product ②	Brigade Pedestals ③	400 Series Lateral Files ④	Optional Laminate Tops for Pedestals ⑤	Brigade 800, 700, 600 Lateral Files ⑥	500 Lateral Files ⑦	Brigade Overfiles ⑧	Optional Laminate Tops for Lateral Files and Contain® Credenzas ⑨	210 Series Vertical Files ⑩	310/H320 Series Vertical Files ⑪	510 Series Vertical Files ⑫	Brigade Storage Cabinets	Brigade 600 Series Shelf Files ⑬	FlameSafe Files	Brigade Steel Bookcases ⑭	Optional Laminate Tops for Steel Bookcases ⑮	1870/1890 Series Bookcases	
PAINTS		CODES																		
Core	Black	P	•	•	•	•	•	•	•	•	•	•	•	•	•	•	•	•	•	
	Charcoal	S	•	•	•	•	•	•	•	•	•	•	•	•	•	•	•	•	•	
	Greige	T5	•	•	•	•	•	•	•	•	•	•	•	•	•	•	•	•	•	
	Light Gray	Q	•	•	•	•	•	•	•	•	•	•	•	•	•	•	•	•	•	
	Loft	LOFT	•	•	•	•	•	•	•	•	•	•	•	•	•	•	•	•	•	
	Muslin	T3	•	•	•	•	•	•	•	•	•	•	•	•	•	•	•	•	•	
	Putty	L	•	•	•	•	•	•	•	•	•	•	•	•	•	•	•	•	•	
	Shadow	SHDW	•	•	•	•	•	•	•	•	•	•	•	•	•	•	•	•	•	
CHOICE COLORS																				
Choice Metallics	Brilliant White	WHIT	•	•	•	•	•	•	•	•	•	•	•	•	•	•	•	•	•	
	Champagne Metallic	T4	•	•	•	•	•	•	•	•	•	•	•	•	•	•	•	•	•	
	Platinum Metallic	T1	•	•	•	•	•	•	•	•	•	•	•	•	•	•	•	•	•	
Haworth®	Beige	D1	•	•	•	•	•	•	•	•	•	•	•	•	•	•	•	•	•	
	Chalk ¹	T3	•	•	•	•	•	•	•	•	•	•	•	•	•	•	•	•	•	
	Charcoal	D2	•	•	•	•	•	•	•	•	•	•	•	•	•	•	•	•	•	
	Graphite	D5	•	•	•	•	•	•	•	•	•	•	•	•	•	•	•	•	•	
	Putty	D6	•	•	•	•	•	•	•	•	•	•	•	•	•	•	•	•	•	
	Sand	D3	•	•	•	•	•	•	•	•	•	•	•	•	•	•	•	•	•	
	Smoke	D7	•	•	•	•	•	•	•	•	•	•	•	•	•	•	•	•	•	
Herman Miller®	Inner Tone	J2	•	•	•	•	•	•	•	•	•	•	•	•	•	•	•	•	•	
	Inner Tone Light	J5	•	•	•	•	•	•	•	•	•	•	•	•	•	•	•	•	•	
	Light Tone	J6	•	•	•	•	•	•	•	•	•	•	•	•	•	•	•	•	•	
	Medium Tone	H8	•	•	•	•	•	•	•	•	•	•	•	•	•	•	•	•	•	
	Slate Gray	H7	•	•	•	•	•	•	•	•	•	•	•	•	•	•	•	•	•	
Knoll®	Jet Black ²	P	•	•	•	•	•	•	•	•	•	•	•	•	•	•	•	•	•	
	Medium Gray	K1	•	•	•	•	•	•	•	•	•	•	•	•	•	•	•	•	•	
	Pumice	K4	•	•	•	•	•	•	•	•	•	•	•	•	•	•	•	•	•	
	Soft Gray	K3	•	•	•	•	•	•	•	•	•	•	•	•	•	•	•	•	•	
	Taupe	K5	•	•	•	•	•	•	•	•	•	•	•	•	•	•	•	•	•	
Steelcase®	Black ³	P	•	•	•	•	•	•	•	•	•	•	•	•	•	•	•	•	•	
	Cream	K6	•	•	•	•	•	•	•	•	•	•	•	•	•	•	•	•	•	
	Grey Value 1	K9	•	•	•	•	•	•	•	•	•	•	•	•	•	•	•	•	•	
	Midnight	K7	•	•	•	•	•	•	•	•	•	•	•	•	•	•	•	•	•	
	Tan Value 1	K8	•	•	•	•	•	•	•	•	•	•	•	•	•	•	•	•	•	

For Champagne Metallic Paint, Greige is the suggested edgeband color. When Champagne Metallic Paint is selected, pulls are standard in Greige.

¹Haworth Chalk is the same as HON Muslin. When ordering this color use the HON Muslin paint code T3.

²Knoll Jet Black is the same as HON Black. When ordering this color use the HON Black paint code P.

³Steelcase Black is the same as HON Black. When ordering this color use the HON Black paint code P.

NOTES: Choice color selections do not require a customer approval. The colors can be ordered with the HON paint code noted above. If unsure of the color, please request a metal sample from HON Literature Fulfillment.

For HON's ColorCorrect® program, any textured paint will be matched as smooth paint.

Pricing for eligible product is listed on the individual list pricer pages under the column Choice/Metallic column.

No minimum order is required for Choice Colors.

Refer to page 9 for detailed information on the ColorCorrect® program.

Custom Paint Colors

Custom Paint Colors require a special request submitted within MyProjects. Refer to page 9 for detailed information regarding Custom Paints.

Brigade® Standard Height Pedestals

GSA SIN 711-1



- ▶ 28"H fits under all HON worksurfaces and desk shells.
- ▶ Pencil tray standard in top box drawer.
- ▶ Ball-bearing suspension on file and box drawers with 90% extension.
- ▶ File drawers have high sides for filing front-to-back.
- ▶ See pages 479-480 for accessories and pedestal utilization information.
- ▶ Equipped with HON "One Key" interchangeable core removable locks.
- ▶ Front casters are fixed, rear casters swivel on mobile pedestals.
- ▶ "N" Pull matches Brigade 700 Series lateral file pull.
- ▶ "R" pull matches Brigade 800 Series Lateral Pull.

△ **Freestanding support pedestals that are not positioned and attached under a worksurface, require a counterweight kit found on page 479.**



	Description	Model	Ship Weight	Cube	List by Paint Grade		
					Core	Choice/Metallics	Custom
	Standard Height Mobile Pedestals — Box/Box/File						
	15"W x 19 7/8"D x 28"H	H33720(?)	73	6.6	\$ 527	\$ 555	\$ 583
	15"W x 22 7/8"D x 28"H	H33723(?)	77	7.5	\$ 544	\$ 572	\$ 600
	Standard Height Mobile Pedestals — File/File						
	15"W x 19 7/8"D x 28"H	H33820(?)	73	6.6	\$ 527	\$ 555	\$ 583
	15"W x 22 7/8"D x 28"H	H33823(?)	77	7.5	\$ 544	\$ 572	\$ 600
	Standard Height Freestanding Support Pedestals — Box/Box/File						
	15"W x 19 7/8"D x 28"H	H36720(?)	61	6.6	\$ 519	\$ 547	\$ 575
	15"W x 22 7/8"D x 28"H	H36723(?)	83	7.5	\$ 536	\$ 564	\$ 592
	Standard Height Freestanding Support Pedestals — File/File						
	15"W x 19 7/8"D x 28"H	H36820(?)	61	6.6	\$ 519	\$ 547	\$ 575
	15"W x 22 7/8"D x 28"H	H36823(?)	83	7.5	\$ 536	\$ 564	\$ 592

NOTES: See pages 479-480 for Pedestal Accessories.
Additional Flagship pedestal models on pages 466-467.

How to specify	1st Option	2nd Option
Select Model Number from above Select the Pull N Full Face Integral R Full Radius H 3 3 7 2 0 R .	Select Lock Option L Lock L .	Select Paint Color See page 435 P

- ▶ 30", 36" & 42" case widths with drawers, 19 1/4" case depth.
- ▶ Flush top and sides.
- ▶ Reinforced case construction.
- ▶ Four adjustable leveling glides.
- ▶ Full-width radius designer style pull.

- ▶ Features drawer extension restraint; mechanical interlock inhibits the extension of more than one drawer at a time.
- ▶ Three-part, telescoping, steel ball-bearing suspension.
- ▶ Two adjustable hangrails per drawer for side-to-side filing.

- ▶ Counterweight included where applicable to meet ANSI/BIFMA stability requirements.
- ▶ Lock mechanism secures both sides of drawer.
- ▶ Baked enamel finish over rust-inhibiting phosphate pre-treatment.

- ▶ Equipped with HON "One Key" interchangeable core removable locks.
- ▶ Optional laminate tops and accessories — see page 481.

△ **Keyed alike cores must be ordered separately — see page 743.**



	Description	Model	Ship Weight	Cube	List by Paint Grade		
					Core	Choice/Metallics	Custom
	Lateral File — 2 Drawer						
	30"W x 19 1/4"D x 28 3/8"H	H872	118	12.4	\$ 688	\$ 721	\$ 755
	36"W x 19 1/4"D x 28 3/8"H	H882	129	14.8	\$ 769	\$ 802	\$ 836
	42"W x 19 1/4"D x 28 3/8"H	H892	144	17.1	\$ 889	\$ 922	\$ 956
	Lateral File — 3 Drawer						
	30"W x 19 1/4"D x 40 7/8"H	H873	160	17.2	\$ 977	\$1010	\$1044
	36"W x 19 1/4"D x 40 7/8"H	H883	165	20.6	\$1091	\$1124	\$1158
	42"W x 19 1/4"D x 40 7/8"H	H893	176	23.8	\$1265	\$1298	\$1332
	Lateral File — 4 Drawer						
	30"W x 19 1/4"D x 53 1/4"H	H874	175	22.1	\$1186	\$1253	\$1319
	36"W x 19 1/4"D x 53 1/4"H	H884	190	26.4	\$1344	\$1411	\$1477
	42"W x 19 1/4"D x 53 1/4"H	H894	206	30.6	\$1544	\$1611	\$1677
	Lateral File w/Posting Shelf — 5 Drawer						
	30"W x 19 1/4"D x 67"H	H875	204	27.5	\$1575	\$1642	\$1708
	36"W x 19 1/4"D x 67"H	H885	240	32.9	\$1773	\$1840	\$1906
	42"W x 19 1/4"D x 67"H	H895	264	38.0	\$2049	\$2116	\$2182

NOTES: Top drawer is a roll-out shelf.

NOTE: See page 444 for Overfiles and page 481 for Lateral File Accessories.

How to specify

	1st Option	2nd Option
Select Model Number from above	Select Lock Option	Select Paint Color
H 8 7 2 .	L Lock L .	See page 435 T 1

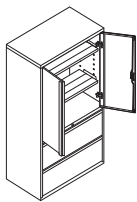

- ▶ 30", 36" & 42" case widths, 19 1/4" case depth.
- ▶ 67"H case — matches height of 800 Series 5 Drawer laterals.
- ▶ Bottom two openings are lateral drawers, remainder of case is storage shelves.

- ▶ Lateral file drawer features are same as 800 Series Laterals shown above.
- ▶ Inside dimension of storage case is 36 1/4"H. Includes 2 adjustable shelves, adjustable in 2" increments. Bottom shelves accept two rows of 3-ring binders; top opening measures: 10 1/4".

- ▶ Storage case is standard with 2 hinged doors. Door pulls match lateral file drawer pulls.
- ▶ Equipped with HON "One Key" interchangeable core removable locks. Locks on storage case and lateral file are keyed alike. Lateral file drawers lock independently from storage case.

- ▶ Four adjustable leveling glides.



	Description	Model	Ship Weight	Cube	List by Paint Grade		
					Core	Choice/Metallics	Custom
	Lateral File w/Storage — 2 Drawer						
	30"W x 19 1/4"D x 67"H	H875LS	174	27.5	\$1264	\$1331	\$1397
	36"W x 19 1/4"D x 67"H	H885LS	210	32.9	\$1393	\$1460	\$1526
	42"W x 19 1/4"D x 67"H	H895LS	228	38.0	\$1592	\$1659	\$1725

NOTE: See page 481 for Lateral File Accessories and page 443 for Wire Dividers.

How to specify

	1st Option	2nd Option
Select Model Number from above	Select Lock Option	Select Paint Color
H 8 7 5 L S .	L Lock L .	See page 435 T 1

Brigade® 800 Series Lateral Files w/Roll-out Shelves

GSA SIN 711-3



- ▶ 30", 36" & 42" case widths with rollout shelves, 19 1/4" case depth.
- ▶ Fixed front bottom drawer on all roll-out shelf units (standard drawer).
- ▶ Flush top and sides.
- ▶ Reinforced case construction.
- ▶ Four adjustable leveling glides.
- ▶ Full-width radius designer pull.
- ▶ Features drawer extension restraint; mechanical interlock inhibits the extension of more than one shelf at a time.
- ▶ Three-part, telescoping, slide suspension operates on steel ball-bearings.
- ▶ Two adjustable hangrails per opening for side-to-side filing.
- ▶ Counterweight included where applicable to meet ANSI/BIFMA stability requirements.
- ▶ Lock mechanism secures both sides of drawer.
- ▶ Baked enamel finish over rust-inhibiting phosphate pre-treatment.
- ▶ Equipped with HON "One Key" interchangeable core removable locks.
- ▶ Optional laminate tops and accessories — see page 481.

△ **Keyed alike cores must be ordered separately — see page 743.**

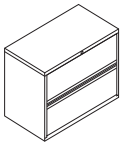
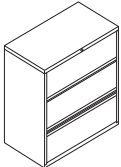
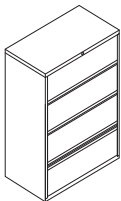
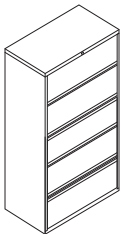

Description	Model	Ship Weight	Cube	List by Paint Grade		
				Core	Choice/Metallics	Custom
 <p>Lateral File with Roll-out Shelves — 2 Openings 30"W x 19 1/4"D x 28 3/8"H 36"W x 19 1/4"D x 28 3/8"H 42"W x 19 1/4"D x 28 3/8"H</p> <p>NOTES: Bottom opening is a fixed front drawer.</p>	H842	118	12.4	\$ 960	\$ 993	\$1027
	H852	129	14.8	\$1062	\$1095	\$1129
	H862	144	17.1	\$1227	\$1260	\$1294
 <p>Lateral File with Roll-out Shelves — 3 Openings 30"W x 19 1/4"D x 40 7/8"H 36"W x 19 1/4"D x 40 7/8"H 42"W x 19 1/4"D x 40 7/8"H</p> <p>NOTES: Bottom opening is a fixed front drawer.</p>	H843	160	17.2	\$1258	\$1291	\$1325
	H853	165	20.6	\$1413	\$1446	\$1480
	H863	176	23.8	\$1628	\$1661	\$1695
 <p>Lateral File with Roll-out Shelves — 4 Openings 30"W x 19 1/4"D x 53 1/4"H 36"W x 19 1/4"D x 53 1/4"H 42"W x 19 1/4"D x 53 1/4"H</p> <p>NOTES: Bottom opening is a fixed front drawer.</p>	H844	175	22.1	\$1583	\$1650	\$1716
	H854	190	26.4	\$1793	\$1860	\$1926
	H864	206	30.6	\$2069	\$2136	\$2202
 <p>Lateral File with Roll-out Shelves and Posting Shelf — 5 Openings 30"W x 19 1/4"D x 67"H 36"W x 19 1/4"D x 67"H 42"W x 19 1/4"D x 67"H</p> <p>NOTES: Bottom opening is a fixed front drawer.</p>	H845	204	27.5	\$2062	\$2129	\$2195
	H855	240	32.9	\$2333	\$2400	\$2466
	H865	264	38.0	\$2686	\$2753	\$2819

NOTE: See page 444 for Overfiles and page 481 for Lateral File Accessories.

How to specify	1st Option	2nd Option
Select Model Number from above H 8 4 2 .	Select Lock Option L Lock L .	Select Paint Color See page 435 T 1





 Icon Legend on page 10

- ▶ 30", 36" & 42" case widths with drawers, 19 1/4" case depth.
- ▶ Flush top and sides.
- ▶ Reinforced case construction.
- ▶ Four adjustable leveling glides.
- ▶ Full-face integral drawer pulls.



- ▶ Features drawer extension restraint; mechanical interlock inhibits the extension of more than one drawer at a time.
- ▶ Three-part, telescoping, steel ball-bearing suspension.

- ▶ Two adjustable hangrails per drawer/rollout shelf for side-to-side filing.
- ▶ Counterweight included where applicable to meet ANSI/BIFMA stability requirements.
- ▶ Lock mechanism secures both sides of drawer.

- ▶ Baked enamel finish over rust-inhibiting phosphate pre-treatment.
- ▶ Optional laminate tops and accessories — see page 481.
- ▶ Equipped with HON "One Key" interchangeable core removable locks.

△ **Keyed alike cores must be ordered separately — see page 743.**

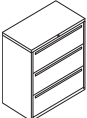
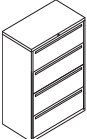

Description	Model	Ship Weight	Cube	List by Paint Grade		
				Core	Choice/Metallics	Custom
 Lateral File — 2 Drawer (locking) 30"W x 19 1/4"D x 28 3/8"H 36"W x 19 1/4"D x 28 3/8"H 42"W x 19 1/4"D x 28 3/8"H	H772	120	12.4	\$ 688	\$ 721	\$ 755
	H782	132	14.3	\$ 769	\$ 802	\$ 836
	H792	148	17.1	\$ 889	\$ 922	\$ 956
 Lateral File — 3 Drawer (locking) 30"W x 19 1/4"D x 40 7/8"H 36"W x 19 1/4"D x 40 7/8"H 42"W x 19 1/4"D x 40 7/8"H	H773	163	17.2	\$ 977	\$1010	\$1044
	H783	169	20.6	\$1091	\$1124	\$1158
	H793	182	23.8	\$1265	\$1298	\$1332
 Lateral File — 4 Drawer (locking) 30"W x 19 1/4"D x 53 1/4"H 36"W x 19 1/4"D x 53 1/4"H 42"W x 19 1/4"D x 53 1/4"H	H774	179	22.1	\$1186	\$1253	\$1319
	H784	196	26.4	\$1344	\$1411	\$1477
	H794	214	30.6	\$1544	\$1611	\$1677
 Lateral File w/Posting Shelf — 5 Drawer (locking) 30"W x 19 1/4"D x 67"H 36"W x 19 1/4"D x 67"H 42"W x 19 1/4"D x 67"H NOTES: Top drawer is a roll-out shelf.	H775	209	27.5	\$1575	\$1642	\$1708
	H785	247	32.9	\$1773	\$1840	\$1906
	H795	274	38.0	\$2049	\$2116	\$2182

NOTE: See page 444 for Overfiles and page 481 for Lateral File Accessories.

How to specify	1st Option	2nd Option
Select Model Number from above H 7 7 2 .	Select Lock Option L Lock L .	Select Paint Color See page 435 T 1

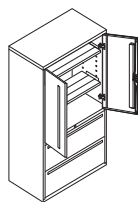

- ▶ 30", 36" & 42" case widths, 19 1/4" case depth.
- ▶ 67"H case — matches height of 700 Series 5 Drawer laterals.
- ▶ Bottom two openings are lateral drawers, remainder of case is storage shelves.

- ▶ Lateral file drawer features are same as 700 Series Laterals shown above.
- ▶ Inside dimension of storage case is 36 1/4"H. Includes 2 adjustable shelves, adjustable in 2" increments. Bottom shelves accept two rows of 3-ring binders; top opening measures: 10 1/4".

- ▶ Storage case is standard with 2 hinged doors. Door pulls match lateral file drawer pulls.
- ▶ Equipped with HON "One Key" interchangeable core removable locks. Locks on storage case and lateral file are keyed alike. Lateral file drawers lock independently from storage case.

- ▶ Four adjustable leveling glides.

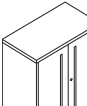

Description	Model	Ship Weight	Cube	List by Paint Grade		
				Core	Choice/Metallics	Custom
 Lateral File w/Storage — 2 Drawer 30"W x 19 1/4"D x 67"H 36"W x 19 1/4"D x 67"H 42"W x 19 1/4"D x 67"H	H775LS	175	27.5	\$1264	\$1331	\$1397
	H785LS	211	32.9	\$1393	\$1460	\$1526
	H795LS	230	38.0	\$1592	\$1659	\$1725

NOTE: See page 481 for Lateral File Accessories and page 443 for Wire Dividers.

How to specify	1st Option	2nd Option
Select Model Number from above H 7 7 5 L S .	Select Lock Option L Lock L .	Select Paint Color See page 435 T 1

Brigade® 700 Series Lateral Files w/Roll-out Shelves

GSA SIN 711-3



- ▶ 30", 36" & 42" case widths with rollout shelves, 19 1/4" case depth.
- ▶ Fixed bottom drawer on all roll-out shelf units (standard drawer).
- ▶ Flush top and sides.
- ▶ Reinforced case construction.
- ▶ Four adjustable leveling glides.
- ▶ Full-face integral drawer pulls.
- ▶ Features shelf extension restraint; mechanical interlock inhibits the extension of more than one shelf at a time.
- ▶ Three-part, telescoping, steel ball-bearing suspension.
- ▶ Two adjustable hangrails per drawer/rollout shelf for side-to-side filing.
- ▶ Counterweight included where applicable to meet ANSI/BIFMA stability requirements.
- ▶ Lock mechanism secures both sides of drawer.
- ▶ Baked enamel finish over rust-inhibiting phosphate pre-treatment.
- ▶ Optional laminate tops and accessories — see page 481.
- ▶ Equipped with HON "One Key" interchangeable core removable locks.

⚠ **Keyed alike cores must be ordered separately — see page 743.**

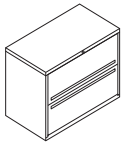
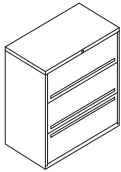
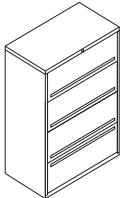
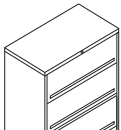

List by Paint Grade

Description	Model	Ship Weight	Cube	Choice/Custom		
				Core	Metallics	Custom
 <p>Lateral File with Roll-out Shelves — 2 Openings 30"W x 19 1/4"D x 28 3/8"H 36"W x 19 1/4"D x 28 3/8"H 42"W x 19 1/4"D x 28 3/8"H</p> <p>NOTES: Bottom opening is a fixed front drawer.</p>	H742	120	12.4	\$ 960	\$ 993	\$1027
	H752	132	14.8	\$1062	\$1095	\$1129
	H762	148	17.1	\$1227	\$1260	\$1294
 <p>Lateral File with Roll-out Shelves — 3 Openings 30"W x 19 1/4"D x 40 7/8"H 36"W x 19 1/4"D x 40 7/8"H 42"W x 19 1/4"D x 40 7/8"H</p> <p>NOTES: Bottom opening is a fixed front drawer.</p>	H743	163	17.2	\$1258	\$1291	\$1325
	H753	169	20.6	\$1413	\$1446	\$1480
	H763	182	23.8	\$1628	\$1661	\$1695
 <p>Lateral File with Roll-out Shelves — 4 Openings 30"W x 19 1/4"D x 53 1/4"H 36"W x 19 1/4"D x 53 1/4"H 42"W x 19 1/4"D x 53 1/4"H</p> <p>NOTES: Bottom opening is a fixed front drawer.</p>	H744	179	22.1	\$1583	\$1650	\$1716
	H754	196	26.4	\$1793	\$1860	\$1926
	H764	214	30.6	\$2069	\$2136	\$2202
 <p>Lateral File with Roll-out Shelves and Posting Shelf — 5 Openings 30"W x 19 1/4"D x 67"H 36"W x 19 1/4"D x 67"H 42"W x 19 1/4"D x 67"H</p> <p>NOTES: Bottom opening is a fixed front drawer.</p>	H745	209	27.5	\$2062	\$2129	\$2195
	H755	247	32.9	\$2333	\$2400	\$2466
	H765	274	38.0	\$2686	\$2753	\$2819

NOTE: See page 444 for Overfiles and page 481 for Lateral File Accessories.

How to specify	1st Option	2nd Option
Select Model Number from above H 7 4 2 .	Select Lock Option L Lock L .	Select Paint Color See page 435 T 1

- ▶ 30", 36" & 42" case widths with drawers, 19 1/4" case depth.
 - ▶ Flush top and sides.
 - ▶ Reinforced case construction.
 - ▶ Four adjustable leveling glides.
 - ▶ Features drawer extension restraint; mechanical interlock inhibits the extension of more than one drawer at a time.
 - ▶ Three-part, telescoping, steel ball-bearing suspension.
 - ▶ Two adjustable hangrails per drawer/roll-out shelf for side-to-side filing.
 - ▶ Counterweight included where applicable to meet ANSI/BIFMA stability requirements.
 - ▶ Lock mechanism secures both sides of drawer.
 - ▶ Baked enamel finish over rust-inhibiting phosphate pre-treatment.
 - ▶ Bright anodized aluminum recessed drawer pull.
 - ▶ Equipped with HON "One Key" interchangeable core removable locks.
 - ▶ Optional laminate tops and accessories — see page 481.
- ⚠ **Keyed alike cores must be ordered separately — see page 743.**



	Description	Model	Ship Weight	Cube	List by Paint Grade		
					Core	Choice/Metallics	Custom
	Lateral File — 2 Drawer						
	30"W x 19 1/4"D x 28 3/8"H	H672	120	12.4	\$ 656	\$ 689	\$ 723
	36"W x 19 1/4"D x 28 3/8"H	H682	132	14.3	\$ 705	\$ 738	\$ 772
	42"W x 19 1/4"D x 28 3/8"H	H692	148	17.1	\$ 833	\$ 866	\$ 900
	Lateral File — 3 Drawer						
	30"W x 19 1/4"D x 40 7/8"H	H673	163	17.2	\$ 901	\$ 934	\$ 968
	36"W x 19 1/4"D x 40 7/8"H	H683	169	20.6	\$ 987	\$1020	\$1054
	42"W x 19 1/4"D x 40 7/8"H	H693	182	23.8	\$1160	\$1193	\$1227
	Lateral File — 4 Drawer						
	30"W x 19 1/4"D x 53 1/4"H	H674	179	22.1	\$1120	\$1187	\$1253
	36"W x 19 1/4"D x 53 1/4"H	H684	196	26.4	\$1226	\$1293	\$1359
	42"W x 19 1/4"D x 53 1/4"H	H694	214	30.6	\$1454	\$1521	\$1587
	Lateral File w/Posting Shelf — 5 Drawer						
	30"W x 19 1/4"D x 67"H	H675	209	27.5	\$1490	\$1557	\$1623
	36"W x 19 1/4"D x 67"H	H685	247	32.9	\$1593	\$1660	\$1726
	42"W x 19 1/4"D x 67"H	H695	274	38.0	\$1922	\$1989	\$2055

NOTES: Top drawer is a roll-out shelf.

How to specify	1st Option	2nd Option
Select Model Number from above	Select Lock Option	Select Paint Color
H 6 7 2 .	L Lock L .	See page 435 T 1

- ▶ 30", 36" & 42" case widths, 19 1/4" case depth.
- ▶ 67"H case — matches height of 600 Series 5 Drawer laterals.
- ▶ Bottom two openings are lateral drawers, remainder of case is storage shelves.
- ▶ Lateral file drawer features are same as 600 Series Laterals shown above.
- ▶ Inside dimension of storage case is 36 1/4"H. Includes 2 adjustable shelves, adjustable in 2" increments. Bottom shelves accept two rows of 3-ring binders; top opening measures: 10 1/4".
- ▶ Storage case is standard with 2 hinged doors. Door pulls match lateral file drawer pulls.
- ▶ Equipped with HON "One Key" interchangeable core removable locks. Locks on storage case and lateral file are keyed alike. Lateral file drawers lock independently from storage case.
- ▶ Four adjustable leveling glides.



	Description	Model	Ship Weight	Cube	List by Paint Grade		
					Core	Choice/Metallics	Custom
	Lateral File w/Storage — 2 Drawer						
	30"W x 19 1/4"D x 67"H	H675LS	175	27.5	\$1264	\$1331	\$1397
	36"W x 19 1/4"D x 67"H	H685LS	211	32.9	\$1393	\$1460	\$1526
	42"W x 19 1/4"D x 67"H	H695LS	230	38.0	\$1532	\$1599	\$1665

NOTE: See page 444 for Overfiles and page 481 for Lateral File Accessories.

How to specify	1st Option	2nd Option
Select Model Number from above	Select Lock Option	Select Paint Color
H 6 7 5 L S .	L Lock L .	See page 435 T 1

Brigade® 600 Series Lateral Files w/Roll-out Shelves

GSA SIN 711-3



- ▶ 30", 36" & 42" case widths with roll-out shelves, 19 1/4" case depth.
- ▶ Flush top and sides.
- ▶ Reinforced case construction.
- ▶ Four adjustable leveling glides.
- ▶ Fixed bottom drawer on all roll-out shelf units (standard drawer).



- ▶ Features drawer extension restraint; mechanical interlock inhibits the extension of more than one shelf at a time.
- ▶ Three-part, telescoping, steel ball-bearing suspension.
- ▶ Two adjustable hangrails per opening for side-to-side filing.

- ▶ Counterweight included where applicable to meet ANSI/BIFMA stability requirements.
- ▶ Lock mechanism secures both sides of drawer.
- ▶ Baked enamel finish over rust-inhibiting phosphate pre-treatment.

- ▶ Bright anodized aluminum recessed drawer pull.
- ▶ Equipped with HON "One Key" interchangeable core removable locks.
- ▶ Optional laminate tops and accessories — see page 481.

⚠ **Keyed alike cores must be ordered separately — see page 743.**

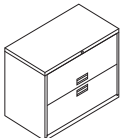
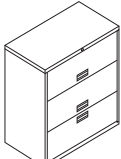

Description	Model	Ship Weight	Cube	List by Paint Grade		
				Core	Choice/Metallics	Custom
 <p>Lateral File with Roll-out Shelves — 2 Openings 30"W x 19 1/4"D x 28 3/8"H 36"W x 19 1/4"D x 28 3/8"H 42"W x 19 1/4"D x 28 3/8"H</p> <p>NOTES: Bottom opening is a fixed front drawer.</p>	H642	120	12.4	\$ 936	\$ 969	\$1003
	H652	132	14.8	\$1037	\$1070	\$1104
	H662	148	17.1	\$1190	\$1223	\$1257
 <p>Lateral File with Roll-out Shelves — 3 Openings 30"W x 19 1/4"D x 40 7/8"H 36"W x 19 1/4"D x 40 7/8"H 42"W x 19 1/4"D x 40 7/8"H</p> <p>NOTES: Bottom opening is a fixed front drawer.</p>	H643	163	17.2	\$1221	\$1254	\$1288
	H653	169	20.6	\$1373	\$1406	\$1440
	H663	182	23.8	\$1570	\$1603	\$1637
 <p>Lateral File with Roll-out Shelves — 4 Openings 30"W x 19 1/4"D x 53 1/4"H 36"W x 19 1/4"D x 53 1/4"H 42"W x 19 1/4"D x 53 1/4"H</p> <p>NOTES: Bottom opening is a fixed front drawer.</p>	H644	179	22.1	\$1527	\$1594	\$1660
	H654	196	26.4	\$1729	\$1796	\$1862
	H664	214	30.6	\$1981	\$2048	\$2114
 <p>Lateral File with Roll-out Shelves and Posting Shelf — 5 Openings 30"W x 19 1/4"D x 67"H 36"W x 19 1/4"D x 67"H 42"W x 19 1/4"D x 67"H</p> <p>NOTES: Bottom opening is a fixed front drawer.</p>	H645	209	27.5	\$1981	\$2048	\$2114
	H655	247	32.9	\$2236	\$2303	\$2369
	H665	274	38.0	\$2576	\$2643	\$2709





NOTE: See page 444 for Overfiles and page 481 for Lateral File Accessories.

How to specify	1st Option	2nd Option
Select Model Number from above H 6 4 2 .	Select Lock Option L Lock L .	Select Paint Color See page 435 T 1

Icon Legend on page 10

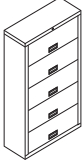
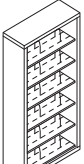
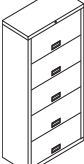
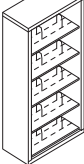
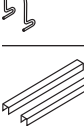
- ▶ 36" wide 5 and 6 fixed shelf files are offered in letter and legal depths, and in jumbo height in legal depth; locking models have one receding door per shelf.
 - ▶ Shelf files accept letter or legal files side-to-side.
 - ▶ Double wall construction provides extra strength.
 - ▶ Receding door models operate on nylon glides installed in the door tracks.
 - ▶ Two wire dividers per shelf are standard. Additional dividers available in 6 or 12 packs.
 - ▶ Can be ganged back-to-back.
 - ▶ Four adjustable leveling glides.
 - ▶ Bright anodized aluminum recessed door pull.
 - ▶ Baked enamel finish over rust-inhibiting phosphate pre-treatment.
 - ▶ All receding door models are equipped with HON "One Key" interchangeable core removable locks operating two 16 gauge lock bars with tabs, which engage both sides of doors.
- ⚠ **Keyed alike cores must be ordered separately — see page 743.**



	Description	Model	Ship Weight	Cube	List by Paint Grade		
					Core	Choice/Metallics	Custom
	Shelf File — 5 Shelf						
	36"W x 13 3/4"D x 64 1/4"H, Letter	H625	165.0	24.2	\$1411	\$1478	\$1544
	36"W x 16 3/4"D x 64 1/4"H, Legal	H625C	170.0	28.7	\$1498	\$1565	\$1631
	Shelf File — 6 Shelf						
	36"W x 13 3/4"D x 75 1/8"H, Letter	H626	178.0	28.3	\$1622	\$1689	\$1755
	36"W x 16 3/4"D x 75 1/8"H, Legal	H626C	190.0	33.6	\$1721	\$1788	\$1854
	NOTES: 10 1/8"H between shelf and door. Shelves are not adjustable.						
	Shelf File — 6 Shelf, Open						
	36"W x 13 3/4"D x 75 1/8"H, Letter	H626N	145.0	28.3	\$1014	\$1081	\$1147
	36"W x 16 3/4"D x 75 1/8"H, Legal	H626CN	160.0	33.6	\$1108	\$1175	\$1241
	NOTES: 10 1/8"H between shelves. Shelves are not adjustable.						
	Jumbo Shelf File — 5 Shelf Legal						
	36"W x 16 3/4"D x 75 1/8"H	HJ625C	193.0	33.6	\$1703	\$1770	\$1836
	NOTES: Use for 3-ring binders. 13"H between shelf and door. Shelves are not adjustable.						
	Jumbo Shelf File — 5 Shelf Legal, Open						
	36"W x 16 3/4"D x 75 1/8"H	HJ625CN	158.0	33.6	\$1080	\$1147	\$1213
	NOTES: 13 3/4"H between shelves. Use for 3-ring binders.						
	Wire Dividers						
	12 Pack	H517514	2.7 	0.1	\$ 87		
	Depth Converter Legal-to-Letter (2/pack)						
		H515700	5.0 	0.5	\$ 102		

How to specify	1st Option	2nd Option
<p>Select Model Number from above</p> <p>H 6 2 5 .</p>	<p>Select Lock Option</p> <p>L Lock</p> <p>Specify for models H625, H625C, H626, H626C, HJ625C</p> <p>L .</p>	<p>Select Paint Color</p> <p>See page 435</p> <p>T 1 </p>

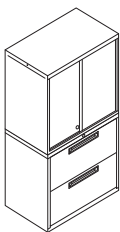

- ▶ Maximizes use of space above lateral files.
- ▶ One adjustable shelf per cabinet, adjustable at 1" increments, up to 6" from center position.
- ▶ Capable of accepting two tiers of 12"H binders (depending on shelf location).
- ▶ Can be used on the floor under 29½"H worksurfaces.
- ▶ Four wire dividers supplied per shelf (total 8 per unit) with locating slots every 3" along shelf and base.
- ▶ Units fasten to new or existing lateral file cabinets (attaching hardware included).
- ▶ Units can be attached to wall behind lateral file, and/or "ganged" together for added stability.
- ▶ Compatible with Flagship, and Brigade 800, 700, 600 Lateral Files.
- ▶ "Slide-by" door design does not intrude into office or aisle space.
- ▶ Units are 18" deep, and available in 30", 36" and 42" widths.
- ▶ When fully opened, door opening is 13¼"W, 16¼"W or 19¼"W.

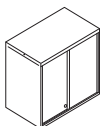

Description	Model	Ship Weight	Cube	List by Paint Grade		
				Core	Choice/ Metallics	Custom
Metal Overfiles with One Adjustable Shelf (locking)						
30"W x 18"D x 27⅞"H	H9317	74	12.3	\$ 921	\$ 954	\$ 988
36"W x 18"D x 27⅞"H	H9318	85	13.5	\$ 991	\$1024	\$1058
42"W x 18"D x 27⅞"H	H9319	96	15.6	\$1052	\$1085	\$1119

How to specify	1st Option	2nd Option
Select Model Number from above H 9 3 1 7 .	Select Lock Option L Lock L .	Select Paint Color See page 435 P

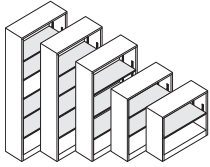

- ▶ Available in 2, 3, 4, 5, and 6 shelf models.
- ▶ Inside shelf depth is 12⁵/₈".
- ▶ Bookcase shelves easily adjust in 1/2" increments (shaded shelves are adjustable).
- ▶ Optional laminate tops available.
- ▶ Baked enamel finish over rust-inhibiting phosphate pre-treatment.



Description	Model	Ship Weight	Cube	List by Paint Grade		
				Core	Choice/Metallics	Custom
Steel Bookcase						
34 ¹ / ₂ "W x 12 ⁵ / ₈ "D x 29"H, 2-Shelf	HS30ABC	44	9.6	\$ 216	\$ 249	\$ 283
34 ¹ / ₂ "W x 12 ⁵ / ₈ "D x 41"H, 3-Shelf	HS42ABC	57	13.3	\$ 259	\$ 292	\$ 326
34 ¹ / ₂ "W x 12 ⁵ / ₈ "D x 59"H, 4-Shelf	HS60ABC	77	18.9	\$ 387	\$ 454	\$ 520
34 ¹ / ₂ "W x 12 ⁵ / ₈ "D x 71"H, 5-Shelf	HS72ABC	87	22.6	\$ 440	\$ 507	\$ 573
34 ¹ / ₂ "W x 12 ⁵ / ₈ "D x 81 ¹ / ₈ "H, 6-Shelf	HS82ABC	97	27.5	\$ 604	\$ 671	\$ 737

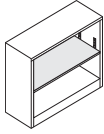

Shaded shelves are adjustable.

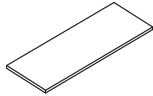

Extra Shelf for all Models	HB9	7	0.3	\$ 74	\$ 87	\$ 97
-----------------------------------	------------	---	-----	-------	-------	-------

NOTES: Edge is 3/4" thick. Specify: Paint

How to specify

<p>Select Model Number from above</p> <p>H S 3 0 A B C .</p>	<p>1st Option</p> <p>Select Paint Color</p> <p>See page 435</p> <p>P </p>
--	---

Description	Model	Ship Weight	Cube	L1	L2
				List	Upcharge
Laminate Top for all Models	H511596	16	0.7	\$ 228	\$ 10

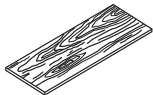

How to specify

<p>Select Model Number from above</p> <p>H 5 1 1 5 9 6 .</p>	<p>1st Option</p> <p>Select Laminate</p> <p>See page 434</p> <p>N </p>
--	--

Brigade® Storage Cabinets





GSA SIN 711-3

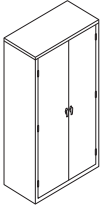
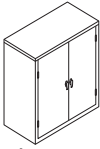
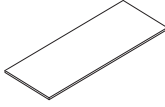

- ▶ Product shipped fully assembled.
- ▶ All shelves are adjustable in 2" increments.
- ▶ Stretch-wrap cartoning.
- ▶ Flush top.
- ▶ Two adjustable leveling glides standard.
- ▶ Reinforced base.
- ▶ One locking handle, one fixed handle.
- ▶ Adjustable shelves.
- ▶ Doors have vertical stiffener standard.
- ▶ Positive door stops.
- ▶ Equipped with HON "One Key" interchangeable core removable locks.

⚠ **Keyed alike cores must be ordered separately — see page 743.**

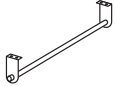

Description	Model	Ship Weight	Cube	List by Paint Grade		
				Core	Choice/Metallics	Custom
 <p>Storage Cabinets 36"W x 18 1/8"D x 72"H 36"W x 24 1/8"D x 72"H NOTES: Includes 5 adjustable shelves.</p>	HSC1872	131	36.5	\$ 854	\$ 921	\$ 987
	HSC2472	149	46.7	\$ 995	\$1062	\$1128
 <p>Storage Cabinet 36"W x 18 1/8"D x 41 3/4"H NOTES: Includes 2 adjustable shelves.</p>	HSC1842	82	21.8	\$ 722	\$ 767	\$ 811
 <p>Additional Shelves 36"W x 18"D 36"W x 24"D</p>	HAS18	6 	0.6	\$ 103	\$ 116	\$ 126
	HAS24	8 	0.7	\$ 130	\$ 143	\$ 153
 <p>Conversion Kit Hanging Bar and brackets to convert a Storage Cabinet into a Wardrobe Cabinet. NOTES: Necessary hardware included to screw into shelf. ⚠ For use on 72"H HSC Model Storage Cabinets shown above, only. ⚠ Anodized Aluminum finish only. No need to specify paint color. SPECIFY: HWC72</p>	HWC72	5 	0.4	\$ 96		

How to specify	1st Option	2nd Option
Select Model Number from above H S C 2 4 7 2 .	Select Lock Option L Lock L .	Select Paint Color See page 435 P

Metal Credenzas with Panel Frames

Guidelines for using Contain[®] Credenzas in place of standard panel systems configurations

Use 1 storage-to-panel bracket set.

The minimum credenza size is 22"H x 36"W x 18"D.
 With a mid-run floor support, the maximum panel run is 144".
 Without a mid-run panel attached floor support, the maximum panel run is 96".
 Overheads and shelves cannot be used with 22"H side mounted credenzas.
 Worksurfaces (if specified) must be mounted on the same side of the parent run as the credenzas.
 Panel frame maximum height is 68".
 Counterweight is required, if using unit with drawers.

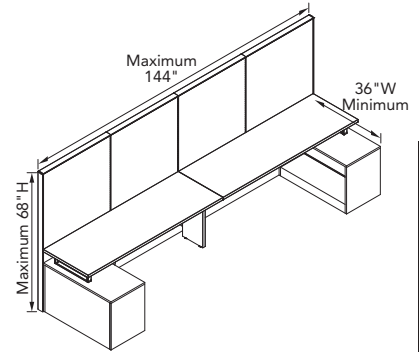

Use 2 storage-to-panel bracket sets per Credenza — 2 LH and 2 RH.

The minimum credenza size is 22"H x 36"W x 18"D.
 The maximum panel run between back-mounted credenzas is 60".
 Overheads and shelves cannot be used with 22"H back mounted credenzas.
 Worksurfaces (if specified) must be mounted on the same side of the parent run as the credenzas.
 Panel frame maximum height is 68".
 Counterweights are required in a single side run configuration as shown.

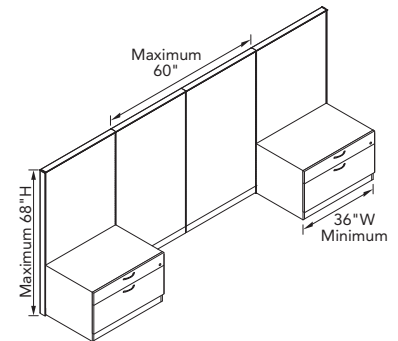

Use 1 storage-to-panel bracket on Credenza LH or RH of set.

The minimum credenza size is 22"H x 36"W x 18"D.
 The minimum size for panel return is 35"H x 36"W.
 With a mid-run panel attached floor support, the maximum panel run is 144".
 Without a mid-run floor support, the maximum panel run is 96".
 Overheads and shelves cannot be used with 22"H side mounted credenzas.
 Worksurfaces (if specified) must be mounted on the same side of the parent run as the credenzas.
 Panel frame maximum height is 68".
 Counterweight is required, if using unit with drawers.
 Mid-run floor support options include:
 Back-to-Back Credenzas
 Panel Attached O-legs
 Panel Attached Support Legs

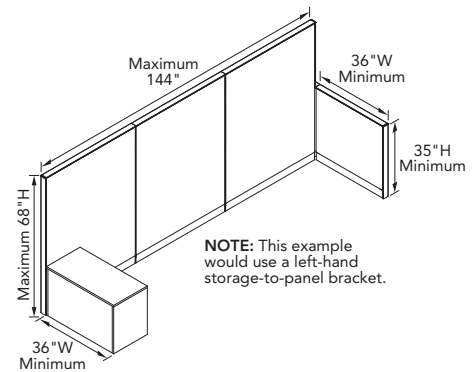

Counterweight Requirements for Contain[®] Credenzas

	24"W Box/File Unit	30"W Box/File Unit	36"W Box/File Unit	42"W Combo Unit	48"W Combo Unit	60"W Combo Unit	72"W Combo Unit
18"D	HSCACW35 35 lbs. (two 12½ lb. and two 5 lb. counterweights)	HSCACW50 50 lbs. (four 12½ lb. counterweights)	HSCACW50 50 lbs. (four 12½ lb. counterweights)	HSCACW25 25 lbs. (two 12½ lb. counterweights)	HSCACW25 25 lbs. (two 12½ lb. counterweights)	HSCACW35 35 lbs. (two 12½ lb. and two 5 lb. counterweights)	HSCACW35 35 lbs. (two 12½ lb. and two 5 lb. counterweights)

Counterweight is not required if credenzas are used within a standard Systems set up and attached with the Credenza Storage-to-Panel Brackets.

Contain[®] Metal Credenzas

GSA SIN 711-3



- ▶ Metal chassis and drawer fronts.
- ▶ Lateral and wide box drawers operate on ball-bearing suspension with full extension.
- ▶ Steel ball-bearing drawer suspensions.
- ▶ Ships complete with standard kickplate.
- ▶ Field installable counterweight sold separately.
- ▶ File drawers accept hanging folders in letter or legal size.
- ▶ Steel frame provides durability.
- ▶ Use with laminate tops and credenza seat cushions. Order separately — see pages 452-453.

⚠ **Locking units equipped with HON "One Key" interchangeable core removable locks. Keyed alike core model HF23S, in Satin, must be ordered separately. See page 452.**

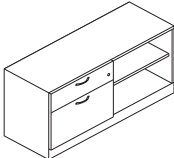
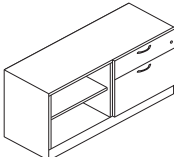
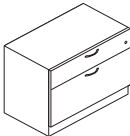
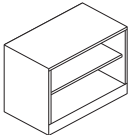

Description	Model	Ship Weight	Cube	List by Paint Grade		
				Core	Choice/Metallics	Custom
 <p>Low Credenza, Box/Lateral Left, Open Shelf Right 72"W x 18"D x 22"H 60"W x 18"D x 22"H 48"W x 18"D x 22"H</p>	HSCBX227218RBFOM(?)	150	20.7	\$1770	\$1837	\$1905
	HSCBX226018RBFOM(?)	130	17.3	\$1597	\$1664	\$1732
	HSCBX224818RBFOM(?)	111	14.0	\$1472	\$1539	\$1607
 <p>Low Credenza, Box/Lateral Right, Open Shelf Left 72"W x 18"D x 22"H 60"W x 18"D x 22"H 48"W x 18"D x 22"H</p>	HSCBX227218LBFOM(?)	150	20.7	\$1770	\$1837	\$1905
	HSCBX226018LBFOM(?)	130	17.3	\$1597	\$1664	\$1732
	HSCBX224818LBFOM(?)	111	14.0	\$1472	\$1539	\$1607
 <p>Low Credenza, Box/Lateral 36"W x 18"D x 22"H 30"W x 18"D x 22"H</p>	HSCBX223618BFM(?)	87	10.6	\$1082	\$1115	\$1150
	HSCBX223018BFM(?)	76	9.0	\$1036	\$1069	\$1104
 <p>Open Shelf 36"W x 18"D x 22"H 30"W x 18"D x 22"H</p>	HSCBX2236180	66	10.6	\$ 771	\$ 804	\$ 839
	HSCBX2230180	60	9.0	\$ 709	\$ 742	\$ 777

How to specify	1st Option	2nd Option
<p>Select Model Number from above</p> <p>Replace (?) with handle choice</p> <p>A Satin Chrome Arch N Full Face Integral R Full Radius Pull</p> <p>Pull not specified for Open Shelf models</p>	<p>Select Paint Color</p> <p>P Black S Charcoal T5 Greige Q Light Gray LOFT Loft T3 Muslin L Putty SHDW Shadow</p> <p>WHIT Brilliant White T4 Champagne Metallic T1 Platinum Metallic</p>	<p>Select Lock Option</p> <p>L Standard Lock X Omit Lock (deduct \$20)</p> <p>Not specified for models HSCBX2236180 and HSCBX2230180</p>
H S C B X 2 2 7 2 1 8 R B F O M A .	P .	L

- ▶ Lateral and wide box drawers operate on ball-bearing suspension with full extension.
- ▶ Steel ball-bearing drawer suspensions.
- ▶ Ships complete with standard footed base.
- ▶ Field installable counterweight sold separately.
- ▶ File drawers accept hanging folders in letter or legal size.
- ▶ Steel frame provides durability.
- ▶ Feet are shipped with the credenza unit and are easily assembled.
- ▶ Use with laminate tops and credenza seat cushions. Order separately — see pages 452-453.
- ⚠ **Locking units equipped with HON "One Key" interchangeable core removable locks. Keyed alike core model HF23S, in Satin, must be ordered separately. See page 452.**



	Description	Model	Ship Weight	Cube	List by Paint Grade		
					Core	Choice/Metallics	Custom
	Footed Low Credenza, Box/Lateral Left, Open Shelf Right						
	72"W x 18"D x 22"H	HSCSF227218RBFOM(?) E♠A	150	17.7	\$1913	\$1980	\$2048
	60"W x 18"D x 22"H	HSCSF226018RBFOM(?) E♠A	130	14.9	\$1740	\$1807	\$1875
	48"W x 18"D x 22"H	HSCSF224818RBFOM(?) E♠A	111	12.0	\$1587	\$1654	\$1722
	Footed Low Credenza, Box/Lateral Right, Open Shelf Left						
	72"W x 18"D x 22"H	HSCSF227218LBFOM(?) E♠A	150	17.7	\$1913	\$1980	\$2048
	60"W x 18"D x 22"H	HSCSF226018LBFOM(?) E♠A	130	14.9	\$1740	\$1807	\$1875
	48"W x 18"D x 22"H	HSCSF224818LBFOM(?) E♠A	111	12.0	\$1587	\$1654	\$1722
	Footed Low Credenza, Box/Lateral						
	36"W x 18"D x 22"H	HSCSF223618BFM(?) E♠A	87	9.1	\$1196	\$1229	\$1264
	30"W x 18"D x 22"H	HSCSF223018BFM(?) E♠A	76	7.7	\$1150	\$1183	\$1218
	Footed Open Shelf						
	36"W x 18"D x 22"H	HSCSF2236180 E♠A	66	9.1	\$ 885	\$ 918	\$ 953
	30"W x 18"D x 22"H	HSCSF2230180 E♠A	60	7.7	\$ 824	\$ 857	\$ 892

How to specify	1st Option	2nd Option	3rd Option
<p>Select Model Number from above</p> <p>Replace (?) with handle choice</p> <p>A Satin Chrome Arch N Full Face Integral R Full Radius Pull</p> <p>Pull not specified for Open Shelf models</p>	<p>Select Paint Color</p> <p>P Black S Charcoal T5 Greige Q Light Gray LOFT Loft T3 Muslin L Putty SHDW Shadow</p> <p>WHIT Brilliant White Champagne T4 Metallic Platinum Metallic</p> <p>T1</p>	<p>Select Lock Option</p> <p>L Standard Lock X Omit Lock (deduct \$20)</p> <p>Not specified for models HSCSF2236180 and HSCSF2230180</p>	<p>Select Foot Color</p> <p>T1 Platinum Metallic</p>
H S C S F 2 2 7 2 1 8 R B F O M A	P	L	T 1

Contain[®] Metal Credenzas with Laminate Fronts

GSA SIN 711-3



- ▶ Lateral and wide box drawers operate on ball-bearing suspension with full extension.
- ▶ Steel ball-bearing drawer suspensions.
- ▶ Ships complete with standard kickplate.
- ▶ Field installable counterweight sold separately.
- ▶ File drawers accept hanging folders in letter or legal size.
- ▶ Steel frame provides durability.
- ▶ Use with laminate tops and credenza seat cushions. Order separately — see pages 452-453.
- ▶ **Available in Satin Chrome Arch only.**
- ▶ **Locking units equipped with HON "One Key" interchangeable core removable locks. Keyed alike core model HF23S, in Satin, must be ordered separately. See page 452.**

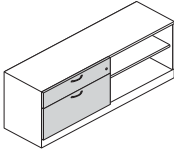
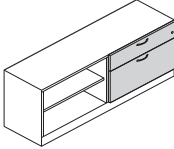
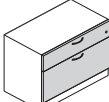

Description	Model	Ship Weight	Cube	List by Paint Grade		
				Core	Choice/Metallics	Custom
 Metal Low Credenza, Laminate Front, Box/Lateral Left, Open Shelf Right 72"W x 18"D x 22"H 60"W x 18"D x 22"H 48"W x 18"D x 22"H	HSCBX227218BFL(?)	152	20.7	\$1964	\$2031	\$2099
	HSCBX226018BFL(?)	132	17.3	\$1791	\$1858	\$1926
	HSCBX224818BFL(?)	113	14.0	\$1666	\$1733	\$1801
▲ Replace (?) with handle choice. Available in Satin Chrome Arch only.						
 Metal Low Credenza, Laminate Front, Box/Lateral Right, Open Shelf Left 72"W x 18"D x 22"H 60"W x 18"D x 22"H 48"W x 18"D x 22"H	HSCBX227218LBFOL(?)	152	20.7	\$1964	\$2031	\$2099
	HSCBX226018LBFOL(?)	132	17.3	\$1791	\$1858	\$1926
	HSCBX224818LBFOL(?)	113	14.0	\$1666	\$1733	\$1801
▲ Replace (?) with handle choice. Available in Satin Chrome Arch only.						
 Metal Low Credenza, Laminate Front Box/Lateral 36"W x 18"D x 22"H 30"W x 18"D x 22"H	HSCBX223618BFL(?)	89	10.6	\$1275	\$1308	\$1343
	HSCBX223018BFL(?)	76	9.0	\$1230	\$1263	\$1298
▲ Replace (?) with handle choice. Available in Satin Chrome Arch only.						

How to specify	1st Option	2nd Option	3rd Option
Select Model Number from above Replace (?) with handle choice A Satin Chrome Arch	Select Paint Color P Black S Charcoal T5 Greige Q Light Gray LOFT Loft T3 Muslin L Putty SHDW Shadow WHIT Brilliant White T4 Champagne Metallic T1 Platinum Metallic	Select Lock Option L Standard Lock X Omit Lock (deduct \$20)	Select Laminate Option L1 (no upcharge) COGN Cognac C Harvest N Mahogany MOCH Mocha D Natural Maple PINC Pinnacle F Shaker Cherry L2 (\$35 upcharge) LLA1 Lowell Ash LNR1 Natural Recon LPE1 Phantom Ecru LPT1 Portico Teak LSW1 Skyline Walnut
H S C B X 2 2 7 2 1 8 R B F O L A .	P .	L .	C

- ▶ Lateral and wide box drawers operate on ball-bearing suspension with full extension.
- ▶ Steel ball-bearing drawer suspensions.
- ▶ Ships complete with standard footed base.
- ▶ Field installable counterweight sold separately.
- ▶ File drawers accept hanging folders in letter or legal size.
- ▶ Steel frame provides durability.
- ▶ Feet are shipped with the credenza unit and are easily assembled.
- ▶ Use with laminate tops and credenza seat cushions. Order separately — see pages 452-453.
- ▶ Available in Satin Chrome Arch only.
- ▶ Locking units equipped with HON "One Key" interchangeable core removable locks. Keyed alike core model HF23S, in Satin, must be ordered separately. See page 452.

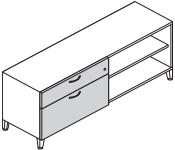
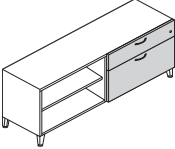
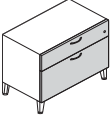

Description	Model	Ship Weight	Cube	List by Paint Grade		
				Core	Choice/Metallics	Custom
 <p>Footed Low Credenza, Laminat Front, Box/Lateral Left, Open Shelf Right</p> <p>72"W x 18"D x 22"H</p> <p>60"W x 18"D x 22"H</p> <p>48"W x 18"D x 22"H</p> <p>△ Replace (?) with handle choice. Available in Satin Chrome Arch only.</p>	HSCSF227218RBFOL(?) E◆A	152	17.7	\$2107	\$2174	\$2242
	HSCSF226018RBFOL(?) E◆A	132	14.9	\$1933	\$2000	\$2068
	HSCSF224818RBFOL(?) E◆A	113	12.0	\$1780	\$1847	\$1915
 <p>Footed Low Credenza, Laminat Front, Box/Lateral Right, Open Shelf Left</p> <p>72"W x 18"D x 22"H</p> <p>60"W x 18"D x 22"H</p> <p>48"W x 18"D x 22"H</p> <p>△ Replace (?) with handle choice. Available in Satin Chrome Arch only.</p>	HSCSF227218LBFOL(?) E◆A	152	17.7	\$2107	\$2174	\$2242
	HSCSF226018LBFOL(?) E◆A	132	14.9	\$1933	\$2000	\$2068
	HSCSF224818LBFOL(?) E◆A	113	12.0	\$1780	\$1847	\$1915
 <p>Footed Low Credenza, Laminat Front Box/Lateral</p> <p>36"W x 18"D x 22"H</p> <p>30"W x 18"D x 22"H</p> <p>△ Replace (?) with handle choice. Available in Satin Chrome Arch only.</p>	HSCSF223618BFL(?) E◆A	89	9.1	\$1390	\$1423	\$1458
	HSCSF223018BFL(?) E◆A	78	7.7	\$1344	\$1377	\$1412

How to specify	1st Option	2nd Option	3rd Option	4th Option	
<p>Select Model Number from above</p> <p>Replace (?) with handle choice</p> <p>A Satin Chrome Arch</p>	<p>Select Paint Color</p> <p>P Black</p> <p>S Charcoal</p> <p>T5 Greige</p> <p>Q Light Gray</p> <p>LOFT Loft</p> <p>T3 Muslin</p> <p>L Putty</p> <p>SHDW Shadow</p> <p>WHIT Brilliant White</p> <p>T4 Champagne Metallic</p> <p>T1 Platinum Metallic</p>	<p>Select Lock Option</p> <p>L Standard Lock</p> <p>X Omit Lock (deduct \$20)</p>	<p>Select Laminat Option</p> <p>L1 (no upcharge)</p> <p>COGN Cognac</p> <p>C Harvest</p> <p>N Mahogany</p> <p>MOCH Mocha</p> <p>D Natural Maple</p> <p>PINC Pinnacle</p> <p>F Shaker Cherry</p> <p>L2 (\$35 upcharge)</p> <p>LLA1 Lowell Ash</p> <p>LNR1 Natural Recon</p> <p>LPE1 Phantom Ecru</p> <p>LPT1 Portico Teak</p> <p>LSW1 Skyline Walnut</p>	<p>Select Foot Color</p> <p>T1 Platinum Metallic</p>	
	H S C S F 2 2 7 2 1 8 R B F O L A .	P .	L .	C .	T 1

- ▶ Square-edge laminate tops provide a finished look to credenzas.
- ▶ Field installable counterweight sold separately.
- ▶ Worksurfaces with O-Legs may be placed upon Low Credenzas to create layering.

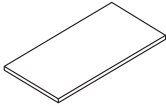

Description	Model	Ship Weight	Cube	List by Laminate Grade	
				L1	L2
 Credenza Laminate Top — Square Edge 72"W x 18"D x 1 1/8" Thick 60"W x 18"D x 1 1/8" Thick 48"W x 18"D x 1 1/8" Thick 36"W x 18"D x 1 1/8" Thick 30"W x 18"D x 1 1/8" Thick	H919472	48.0	3.5	\$ 710	\$ 725
	H919460	32.0	3.0	\$ 606	\$ 621
	H919448	31.0	2.6	\$ 541	\$ 551
	H919436	25.0	1.8	\$ 437	\$ 447
	H919430	20.0	1.6	\$ 349	\$ 359

▲ Specify laminate only.

SPECIFYING EXAMPLE: H919448.C

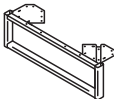
Description	Model	Ship Weight	Cube	List by Paint Grade		
				Core	Choice/ Metallics	Custom
 Worksurface O-Leg 30"W x 6 1/2"H 24"W x 6 1/2"H 20"W x 6 1/2"H	HSCAWS6530	7.0	1.0	\$ 206	\$ 216	\$ 221
	HSCAWS6524	6.0	1.0	\$ 171	\$ 181	\$ 186
	HSCAWS6520	5.0	1.0	\$ 148	\$ 158	\$ 163

▲ Specify paint only.

SPECIFYING EXAMPLE: HSCAWS6530.S

 Credenza Kickplates For 36" Box/File Model For 30" Box/File Model For 24" Box/File Model	HSCK36BF	3.0	0.5	\$ 118	\$ 128	\$ 143
	HSCK30BF	2.0	0.4	\$ 108	\$ 118	\$ 133
	HSCK24BF	2.0	0.4	\$ 97	\$ 107	\$ 122
For 36" Open File Model For 30" Open File Model	HSCK360	3.0	0.5	\$ 118	\$ 128	\$ 143
	HSCK300	2.0	0.4	\$ 108	\$ 118	\$ 133

 Credenza Hangrail Kits 12" for front-to-back filing	HSCAHR12	1.0	0.4	\$ 15	N/A	N/A
---	----------	-----	-----	-------	-----	-----

 Credenza Storage-to-Panel Bracket	HSCAPB	0.2	0.4	\$ 178	\$ 190	\$ 198
---	--------	-----	-----	--------	--------	--------

Credenza Counterweight Kit	HSCACW50	55.0	2.0	\$ 199	N/A	N/A
	HSCACW35	40.0	2.0	\$ 179	N/A	N/A
	HSCACW25	30.0	2.0	\$ 159	N/A	N/A

 Removable Lock Core Kit—Satin	HF23S	0.2	0.1	\$ 34	N/A	N/A
---	-------	-----	-----	-------	-----	-----

• Use when specifying omit lock application.

- Specify quantity of each key number from 101E-225E.
- Includes: 1-core, 2-keys, 1-core removal tool and instructions.
- Removable lock core kits with specific key number must be ordered to facilitate keying alike in the field.
- For specific models, look for the Omit Lock Core icon throughout this publication.

NOTES: If key number isn't specified, number will be at random. Core matches manufactured lock on Contain[®] product but can be used with Contain[®] metal casegoods and laminate product.

How to specify	Select Model Number from above H 9 1 9 4 4 8 .	1st Option Select Laminate Color See page 434 C
----------------	---	--

How to specify	Select Model Number from above H S C A W S 6 5 3 0 .	1st Option Select Paint Color See page 435 S
----------------	---	---

► For matching Pedestal Seats, see page 467.

► Credenza Cushions are available in 24", 30" and 36" size options.

► Choose from multiple upholstery options, see pages 488-497 and 522-523.

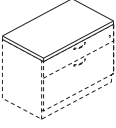

Description	Model	Ship Weight	Cube	Ship											
				1	2	3	4	5	6	7	8	9	10	11	12
 Credenza Cushion 36"W x 18"D for 60" and 72" Credenzas 30"W x 18"D for 48" and 60" Credenzas 24"W x 18"D for 48" Credenzas	HSCAUC1836	16.3	1.6	\$ 255	\$ 293	\$ 331	\$ 370	\$ 419	\$ 469	\$ 519	\$ 568	\$ 618	\$ 667	\$ 717	\$ 767
	HSCAUC1830	16.3	1.6	\$ 237	\$ 275	\$ 313	\$ 352	\$ 401	\$ 451	\$ 501	\$ 550	\$ 600	\$ 649	\$ 699	\$ 749
	HSCAUC1824	16.3	1.9	\$ 222	\$ 260	\$ 298	\$ 337	\$ 386	\$ 436	\$ 486	\$ 535	\$ 585	\$ 634	\$ 684	\$ 734

NOTES: See pages 488-497 and 522-523 for available fabrics.
SPECIFYING EXAMPLE: HSCAUC1836.AB10

How to specify

Select Model Number from above H S C A U C 1 8 3 6 .	1st Option Select Fabric See pages 488-497 and 522-523 A B 1 0
---	--

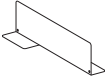
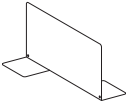
Description	Model	Ship Weight	Cube	List
				Core
 Metal Box Divider 10 pack 2 pack	HSCABD10	7	0.7	\$ 153
	HSCABD02	2	0.7	\$ 38
 Metal File Divider 10 pack 2 pack	HSCAFD10	12	0.7	\$ 184
	HSCAFD02	3	0.7	\$ 48

⚠ **Metal dividers available in Black only. No need to specify.**

Contain[®] Metal Personal Towers

GSA SIN 711-3



- ▶ Metal chassis and drawer fronts.
 - ▶ Steel frame provides durability.
 - ▶ Leveling glides can be adjusted from outside or inside the case.
 - ▶ Heavy-duty, telescoping ball-bearing slides.
 - ▶ Durable baked enamel finish is applied over rust-inhibiting phosphate pre-treatment.
 - ▶ Three locks secure doors and drawers.
- ⚠ Locking units equipped with HON "One Key" interchangeable core removable locks. Keyed alike core model HF23S, in Satin, must be ordered separately. See page 452.



	Description	Model	Ship Weight	Cube	List by Paint Grade		
					Core	Choice/Metallics	Custom
	Personal Tower with Metal Fronts, Door/Box/Box/File						
	65"H x 24"W x 24"D, Wardrobe Left	HSTBX652424LBBFM(?)	255	25.6	\$2435	\$2512	\$2580
	65"H x 24"W x 24"D, Wardrobe Right	HSTBX652424RBBFM(?)	255	25.6	\$2435	\$2512	\$2580
	Personal Tower with Metal Fronts, Door/File/File						
	65"H x 24"W x 24"D, Wardrobe Left	HSTBX652424LFFM(?)	255	25.6	\$2435	\$2512	\$2580
	65"H x 24"W x 24"D, Wardrobe Right	HSTBX652424RFFM(?)	255	25.6	\$2435	\$2512	\$2580
	Personal Tower with Metal Fronts, Door/Box/Box/File						
	50"H x 24"W x 24"D, Wardrobe Left	HSTBX502424LBBFM(?)	215	19.8	\$1997	\$2064	\$2132
	50"H x 24"W x 24"D, Wardrobe Right	HSTBX502424RBBFM(?)	215	19.8	\$1997	\$2064	\$2132
	Personal Tower with Metal Fronts, Door/File/File						
	50"H x 24"W x 24"D, Wardrobe Left	HSTBX502424LFFM(?)	215	19.8	\$1997	\$2064	\$2132
	50"H x 24"W x 24"D, Wardrobe Right	HSTBX502424RFFM(?)	215	19.8	\$1997	\$2064	\$2132

How to specify	1st Option	2nd Option
<p>Select Model Number from above</p> <p>Replace (?) with handle choice</p> <p>A Satin Chrome Arch N Full Face Integral R Full Radius</p>	<p>Select Paint Color</p> <p>P Black S Charcoal T5 Greige Q Light Gray LOFT Loft T3 Muslin L Putty SHDW Shadow</p> <p>WHIT Brilliant White T4 Champagne Metallic T1 Platinum Metallic</p>	<p>Select Lock Option</p> <p>L Standard Lock X Omit Lock</p>
H S T B X 6 5 2 4 2 4 L B B F M A .	P .	L

Icon Legend on page 10

- ▶ A Worksurface to Tower Bracket Kit ships standard with each model.
- ▶ Steel frame provides durability.
- ▶ Leveling glides can be adjusted from outside or inside the case.
- ▶ Heavy-duty, telescoping ball-bearing slides.
- ▶ Durable baked enamel finish is applied over rust-inhibiting phosphate pre-treatment.
- ▶ Two locks secure doors and drawers.
- ▶ Locking units equipped with HON "One Key" interchangeable core removable locks. Keyed alike core model HF23S, in Satin, must be ordered separately. See page 452.



	Description	Model	Ship Weight	Cube	List by Paint Grade		
					Core	Choice/Metallics	Custom
	Side Access Tower with Metal Fronts, Shelves/Box/Box/File						
	65"H x 24"W x 24"D, Wardrobe Left	HSTSBX652424LBBFM(?)	255	25.6	\$2283	\$2360	\$2428
	65"H x 24"W x 24"D, Wardrobe Right	HSTSBX652424RBBFM(?)	255	25.6	\$2283	\$2360	\$2428
	Side Access Tower with Metal Fronts, Shelves/File/File						
	65"H x 24"W x 24"D, Wardrobe Left	HSTSBX652424LFFM(?)	255	25.6	\$2283	\$2360	\$2428
	65"H x 24"W x 24"D, Wardrobe Right	HSTSBX652424RFFM(?)	255	25.6	\$2283	\$2360	\$2428
	Side Access Tower with Metal Fronts, Shelves/Box/Box/File						
	50"H x 24"W x 24"D, Wardrobe Left	HSTSBX502424LBBFM(?)	215	19.8	\$1937	\$2004	\$2072
	50"H x 24"W x 24"D, Wardrobe Right	HSTSBX502424RBBFM(?)	215	19.8	\$1937	\$2004	\$2072
	Side Access Tower with Metal Fronts, Shelves/File/File						
	50"H x 24"W x 24"D, Wardrobe Left	HSTSBX502424LFFM(?)	215	19.8	\$1937	\$2004	\$2072
	50"H x 24"W x 24"D, Wardrobe Right	HSTSBX502424RFFM(?)	215	19.8	\$1937	\$2004	\$2072

How to specify	1st Option	2nd Option
<p>Select Model Number from above</p> <p>Replace (?) with handle choice</p> <p>A Satin Chrome Arch</p> <p>N Full Face Integral</p> <p>R Full Radius</p>	<p>Select Paint Color</p> <p>P Black</p> <p>S Charcoal</p> <p>T5 Greige</p> <p>Q Light Gray</p> <p>LOFT Loft</p> <p>T3 Muslin</p> <p>L Putty</p> <p>SHDW Shadow</p> <p>WHIT Brilliant White</p> <p>T4 Champagne Metallic</p> <p>T1 Platinum Metallic</p>	<p>Select Lock Option</p> <p>L Standard Lock</p> <p>X Omit Lock</p>
H S T S B X 6 5 2 4 2 4 4 L B B F M A .	P .	L

Icon Legend on page 10

Contain[®] Metal Personal Towers with Laminate Fronts

GSA SIN 711-3



- ▶ Metal chassis with laminate drawer/door fronts.
 - ▶ Steel frame provides durability.
 - ▶ Leveling glides can be adjusted from outside or inside the case.
 - ▶ Heavy-duty, telescoping ball-bearing slides.
 - ▶ Durable baked enamel finish is applied over rust-inhibiting phosphate pre-treatment.
 - ▶ Three locks secure doors and drawers.
- ⚠ **Available in Satin Chrome Arch only.**
- ⚠ **Locking units equipped with HON "One Key" interchangeable core removable locks. Keyed alike core model HF23S, in Satin, must be ordered separately. See page 452.**



	Description	Model	Ship Weight	Cube	List by Paint Grade		
					Core	Choice/Metallics	Custom
	Personal Tower with Laminate Fronts, Door/Box/Box/File						
	65"H x 24"W x 24"D, Wardrobe Left	HSTBX652424LBBFL(?)	255	25.6	\$2780	\$2857	\$2925
	65"H x 24"W x 24"D, Wardrobe Right	HSTBX652424RBBFL(?)	255	25.6	\$2780	\$2857	\$2925
	Personal Tower with Laminate Fronts, Door/File/File						
	65"H x 24"W x 24"D, Wardrobe Left	HSTBX652424LFFFL(?)	255	25.6	\$2780	\$2857	\$2925
	65"H x 24"W x 24"D, Wardrobe Right	HSTBX652424RFFFL(?)	255	25.6	\$2780	\$2857	\$2925
	Personal Tower with Laminate Fronts, Door/Box/Box/File						
	50"H x 24"W x 24"D, Wardrobe Left	HSTBX502424LBBFL(?)	215	19.8	\$2297	\$2364	\$2432
	50"H x 24"W x 24"D, Wardrobe Right	HSTBX502424RBBFL(?)	215	19.8	\$2297	\$2364	\$2432
	Personal Tower with Laminate Fronts, Door/File/File						
	50"H x 24"W x 24"D, Wardrobe Left	HSTBX502424LFFFL(?)	215	19.8	\$2297	\$2364	\$2432
	50"H x 24"W x 24"D, Wardrobe Right	HSTBX502424RFFFL(?)	215	19.8	\$2297	\$2364	\$2432

How to specify	1st Option	2nd Option	3rd Option
<p>Select Model Number from above</p> <p>Replace (?) with handle choice</p> <p>A Satin Chrome Arch</p>	<p>Select Paint Color</p> <p>P Black</p> <p>S Charcoal</p> <p>T5 Greige</p> <p>Q Light Gray</p> <p>LOFT Loft</p> <p>T3 Muslin</p> <p>L Putty</p> <p>SHDW Shadow</p> <p>WHIT Brilliant White</p> <p>T4 Champagne Metallic</p> <p>T1 Platinum Metallic</p>	<p>Select Lock Option</p> <p>L Standard Lock</p> <p>X Omit Lock</p>	<p>Select Laminate Option</p> <p>L1 (no upcharge)</p> <p>COGN Cognac</p> <p>C Harvest</p> <p>N Mahogany</p> <p>MOCH Mocha</p> <p>D Natural Maple</p> <p>PINC Pinnacle</p> <p>F Shaker Cherry</p> <p>L2 (\$35 upcharge)</p> <p>LLA1 Lowell Ash</p> <p>LNR1 Natural Recon</p> <p>LPE1 Phantom Ecru</p> <p>LPT1 Portico Teak</p> <p>LSW1 Skyline Walnut</p>
HSTBX652424LBBFLA	P	L	C

Icon Legend on page 10

- ▶ A Worksurface to Tower Bracket Kit ships standard with each model.
- ▶ Metal chassis with laminate drawer/door fronts.
- ▶ Steel frame provides durability.
- ▶ Leveling glides can be adjusted from outside or inside the case.
- ▶ Heavy-duty, telescoping ball-bearing slides.
- ▶ Durable baked enamel finish is applied over rust-inhibiting phosphate pre-treatment.
- ▶ Two locks secure doors and drawers.
- ▶ **Available in Satin Chrome Arch only.**
- ▶ **Locking units equipped with HON "One Key" interchangeable core removable locks. Keyed alike core model HF23S, in Satin, must be ordered separately. See page 452.**



	Description	Model	Ship Weight	Cube	List by Paint Grade		
					Core	Choice/Metallics	Custom
	Side Access Tower with Laminate Fronts, Shelves/Box/Box/File						
	65"H x 24"W x 24"D, Wardrobe Left	HSTSBX652424LBBFL(?)	255	25.6	\$2628	\$2705	\$2773
	65"H x 24"W x 24"D, Wardrobe Right	HSTSBX652424RBBFL(?)	255	25.6	\$2628	\$2705	\$2773
	Side Access Tower with Laminate Fronts, Shelves/File/File						
	65"H x 24"W x 24"D, Wardrobe Left	HSTSBX652424LFFL(?)	255	25.6	\$2628	\$2705	\$2773
	65"H x 24"W x 24"D, Wardrobe Right	HSTSBX652424RFFL(?)	255	25.6	\$2628	\$2705	\$2773
	Side Access Tower with Laminate Fronts, Shelves/Box/Box/File						
	50"H x 24"W x 24"D, Wardrobe Left	HSTSBX502424LBBFL(?)	215	19.8	\$2237	\$2304	\$2372
	50"H x 24"W x 24"D, Wardrobe Right	HSTSBX502424RBBFL(?)	215	19.8	\$2237	\$2304	\$2372
	Side Access Tower with Laminate Fronts, Shelves/File/File						
	50"H x 24"W x 24"D, Wardrobe Left	HSTSBX502424LFFL(?)	215	19.8	\$2237	\$2304	\$2372
	50"H x 24"W x 24"D, Wardrobe Right	HSTSBX502424RFFL(?)	215	19.8	\$2237	\$2304	\$2372

How to specify	1st Option	2nd Option	3rd Option
<p>Select Model Number from above</p> <p>Replace (?) with handle choice</p> <p>A Satin Chrome Arch</p>	<p>Select Paint Color</p> <p>P Black</p> <p>S Charcoal</p> <p>T5 Greige</p> <p>Q Light Gray</p> <p>LOFT Loft</p> <p>T3 Muslin</p> <p>L Putty</p> <p>SHDW Shadow</p> <p>WHIT Brilliant White</p> <p>T4 Champagne Metallic</p> <p>T1 Platinum Metallic</p>	<p>Select Lock Option</p> <p>L Standard Lock</p> <p>X Omit Lock</p>	<p>Select Laminate Option</p> <p>L1 (no upcharge)</p> <p>COGN Cognac</p> <p>C Harvest</p> <p>N Mahogany</p> <p>MOCH Mocha</p> <p>D Natural Maple</p> <p>PINC Pinnacle</p> <p>F Shaker Cherry</p> <p>L2 (\$35 upcharge)</p> <p>LLA1 Lowell Ash</p> <p>LNR1 Natural Recon</p> <p>LPE1 Phantom Ecru</p> <p>LPT1 Portico Teak</p> <p>LSW1 Skyline Walnut</p>
	H S T S B X 6 5 2 4 2 4 L B B F L A .	P .	L .
			C



Contain[®] Footed Metal Personal Towers

GSA SIN 711-3

HON

- ▶ Metal chassis and drawer fronts.
 - ▶ Steel frame provides durability.
 - ▶ Leveling glides can be adjusted from outside or inside the case.
 - ▶ Heavy-duty, telescoping ball-bearing slides.
 - ▶ Durable baked enamel finish is applied over rust-inhibiting phosphate pre-treatment.
 - ▶ Three locks secure doors and drawers.
- ⚠ Locking units equipped with HON "One Key" interchangeable core removable locks. Keyed alike core model HF23S, in Satin, must be ordered separately. See page 452.

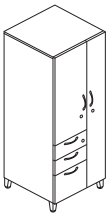
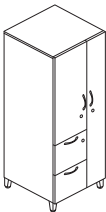
A_BJ

Description	Model	Ship Weight	Cube	List by Paint Grade		
				Core	Choice/ Metallics	Custom
 Footed Personal Tower with Metal Fronts, Door/Box/Box/File 65"H x 24"W x 24"D, Wardrobe Left 65"H x 24"W x 24"D, Wardrobe Right	HSTSF652424LBFFM(?)	255	24.3	\$2547	\$2624	\$2692
	HSTSF652424RBBFFM(?)	255	24.3	\$2547	\$2624	\$2692
 Footed Personal Tower with Metal Fronts, Door/File/File 65"H x 24"W x 24"D, Wardrobe Left 65"H x 24"W x 24"D, Wardrobe Right	HSTSF652424LFFM(?)	255	24.3	\$2547	\$2624	\$2692
	HSTSF652424RFFM(?)	255	24.3	\$2547	\$2624	\$2692
 Footed Personal Tower with Metal Fronts, Door/Box/Box/File 50"H x 24"W x 24"D, Wardrobe Left 50"H x 24"W x 24"D, Wardrobe Right	HSTSF502424LBFFM(?)	215	18.6	\$2109	\$2176	\$2244
	HSTSF502424RBBFFM(?)	215	18.6	\$2109	\$2176	\$2244
 Footed Personal Tower with Metal Fronts, Door/File/File 50"H x 24"W x 24"D, Wardrobe Left 50"H x 24"W x 24"D, Wardrobe Right	HSTSF502424LFFM(?)	215	18.6	\$2109	\$2176	\$2244
	HSTSF502424RFFM(?)	215	18.6	\$2109	\$2176	\$2244

How to specify	1st Option	2nd Option	3rd Option
Select Model Number from above Replace (?) with handle choice A Satin Chrome Arch N Full Face Integral R Full Radius	Select Paint Color P Black S Charcoal T5 Greige Q Light Gray LOFT Loft T3 Muslin L Putty SHDW Shadow WHIT Brilliant White T4 Champagne Metallic T1 Platinum Metallic	Select Lock Option L Standard Lock X Omit Lock	Select Foot Color T1 Platinum Metallic
H S T S F 6 5 2 4 2 4 L B B F M A .	P .	L .	T 1

A_BJ ⚠ Icon Legend on page 10

- ▶ A Worksurface to Tower Bracket Kit ships standard with each model.
- ▶ Metal chassis and drawer fronts.
- ▶ Steel frame provides durability.
- ▶ Leveling glides can be adjusted from outside or inside the case.
- ▶ Heavy-duty, telescoping ball-bearing slides.
- ▶ Durable baked enamel finish is applied over rust-inhibiting phosphate pre-treatment.
- ▶ Two locks secure doors and drawers.
- ▶ Locking units equipped with HON "One Key" interchangeable core removable locks. Keyed alike core model HF23S, in Satin, must be ordered separately. See page 452.



	Description	Model	Ship Weight	Cube	List by Paint Grade		
					Core	Choice/Metallics	Custom
	Footed Side Access Tower with Metal Fronts, Shelves/Box/Box/File						
	65"H x 24"W x 24"D, Wardrobe Left	HSTSSF652424LBBFM(?)	255	24.3	\$2395	\$2472	\$2540
	65"H x 24"W x 24"D, Wardrobe Right	HSTSSF652424RBBFM(?)	255	24.3	\$2395	\$2472	\$2540
	Footed Side Access Tower with Metal Fronts, Shelves/File/File						
	65"H x 24"W x 24"D, Wardrobe Left	HSTSSF652424LFFM(?)	255	24.3	\$2395	\$2472	\$2540
	65"H x 24"W x 24"D, Wardrobe Right	HSTSSF652424RFFM(?)	255	24.3	\$2395	\$2472	\$2540
	Footed Side Access Tower with Metal Fronts, Shelves/Box/Box/File						
	50"H x 24"W x 24"D, Wardrobe Left	HSTSSF502424LBBFM(?)	215	18.6	\$2049	\$2116	\$2184
	50"H x 24"W x 24"D, Wardrobe Right	HSTSSF502424RBBFM(?)	215	18.6	\$2049	\$2116	\$2184
	Footed Side Access Tower with Metal Fronts, Shelves/File/File						
	50"H x 24"W x 24"D, Wardrobe Left	HSTSSF502424LFFM(?)	215	18.6	\$2049	\$2116	\$2184
	50"H x 24"W x 24"D, Wardrobe Right	HSTSSF502424RFFM(?)	215	18.6	\$2049	\$2116	\$2184

How to specify	1st Option	2nd Option	3rd Option
Select Model Number from above Replace (?) with handle choice A Satin Chrome Arch N Full Face Integral R Full Radius	Select Paint Color P Black S Charcoal T5 Greige Q Light Gray LOFT Loft T3 Muslin L Putty SHDW Shadow WHIT Brilliant White T4 Champagne Metallic T1 Platinum Metallic	Select Lock Option L Standard Lock X Omit Lock	Select Foot Color T1 Platinum Metallic
H S T S S F 6 5 2 4 2 4 L B B F M A .	P .	L .	T 1

Icon Legend on page 10

Contain[®] Footed Metal Personal Towers with Laminate Fronts

GSA SIN 711-3



- ▶ Metal chassis with laminate drawer/door fronts.
- ▶ Steel frame provides durability.
- ▶ Leveling glides can be adjusted from outside or inside the case.
- ▶ Heavy-duty, telescoping ball-bearing slides.
- ▶ Durable baked enamel finish is applied over rust-inhibiting phosphate pre-treatment.
- ▶ Three locks secure doors and drawers.
- ▶ **Available in Satin Chrome Arch only.**
- ▶ **Locking units equipped with HON "One Key" interchangeable core removable locks. Keyed alike core model HF23S, in Satin, must be ordered separately. See page 452.**



	Description	Model	Ship Weight	Cube	List by Paint Grade		
					Core	Choice/Metallics	Custom
	Footed Personal Tower with Laminate Fronts, Door/Box/Box/File						
	65"H x 24"W x 24"D, Wardrobe Left	HSTSF652424LBBFL(?)	255	24.3	\$2892	\$2969	\$3037
	65"H x 24"W x 24"D, Wardrobe Right	HSTSF652424RBBFL(?)	255	24.3	\$2892	\$2969	\$3037
	Footed Personal Tower with Laminate Fronts, Door/File/File						
	65"H x 24"W x 24"D, Wardrobe Left	HSTSF652424LFFL(?)	255	24.3	\$2892	\$2969	\$3037
	65"H x 24"W x 24"D, Wardrobe Right	HSTSF652424RFFL(?)	255	24.3	\$2892	\$2969	\$3037
	Footed Personal Tower with Laminate Fronts, Door/Box/Box/File						
	50"H x 24"W x 24"D, Wardrobe Left	HSTSF502424LBBFL(?)	215	18.6	\$2409	\$2476	\$2544
	50"H x 24"W x 24"D, Wardrobe Right	HSTSF502424RBBFL(?)	215	18.6	\$2409	\$2476	\$2544
	Footed Personal Tower with Laminate Fronts, Door/File/File						
	50"H x 24"W x 24"D, Wardrobe Left	HSTSF502424LFFL(?)	215	18.6	\$2409	\$2476	\$2544
	50"H x 24"W x 24"D, Wardrobe Right	HSTSF502424RFFL(?)	215	18.6	\$2409	\$2476	\$2544

How to specify	1st Option	2nd Option	3rd Option	4th Option
<p>Select Model Number from above</p> <p>Replace (?) with handle choice</p> <p>A Satin Chrome Arch</p>	<p>Select Paint Color</p> <p>P Black</p> <p>S Charcoal</p> <p>T5 Greige</p> <p>Q Light Gray</p> <p>LOFT Loft</p> <p>T3 Muslin</p> <p>L Putty</p> <p>SHDW Shadow</p> <p>WHIT Brilliant White</p> <p>T4 Champagne Metallic</p> <p>T1 Platinum Metallic</p>	<p>Select Lock Option</p> <p>L Standard Lock</p> <p>X Omit Lock</p>	<p>Select Laminate Option</p> <p>L1 (no upcharge)</p> <p>COGN Cognac</p> <p>C Harvest</p> <p>N Mahogany</p> <p>MOCH Mocha</p> <p>D Natural Maple</p> <p>PINC Pinnacle</p> <p>F Shaker Cherry</p> <p>L2 (\$35 upcharge)</p> <p>LLA1 Lowell Ash</p> <p>LNR1 Natural Recon</p> <p>LPE1 Phantom Ecru</p> <p>LPT1 Portico Teak</p> <p>LSW1 Skyline Walnut</p>	<p>Select Foot Color</p> <p>T1 Platinum Metallic</p>
	H S T S F 6 5 2 4 2 4 L B B F L A .	P .	L .	C .
				T 1

Icon Legend on page 10

- ▶ A Worksurface to Tower Bracket Kit ships standard with each model.
- ▶ Metal chassis with laminate drawer/door fronts.
- ▶ Steel frame provides durability.
- ▶ Leveling glides can be adjusted from outside or inside the case.
- ▶ Heavy-duty, telescoping ball-bearing slides.
- ▶ Durable baked enamel finish is applied over rust-inhibiting phosphate pre-treatment.
- ▶ Two locks secure doors and drawers.
- ▶ Available in Satin Chrome Arch only.
- ▶ Locking units equipped with HON "One Key" interchangeable core removable locks. Keyed alike core model HF23S, in Satin, must be ordered separately. See page 452.



	Description	Model	Ship Weight	Cube	List by Paint Grade		
					Core	Choice/Metallics	Custom
	Footed Side Access Tower with Laminate Fronts, Shelves/Box/Box/File						
	65"H x 24"W x 24"D, Wardrobe Left	HSTSSF652424LBBFL(?)	255	24.3	\$2740	\$2817	\$2885
	65"H x 24"W x 24"D, Wardrobe Right	HSTSSF652424RBBFL(?)	255	24.3	\$2740	\$2817	\$2885
	Footed Side Access Tower with Laminate Fronts, Shelves/File/File						
	65"H x 24"W x 24"D, Wardrobe Left	HSTSSF652424LFFL(?)	255	24.3	\$2740	\$2817	\$2885
	65"H x 24"W x 24"D, Wardrobe Right	HSTSSF652424RFFL(?)	255	24.3	\$2740	\$2817	\$2885
	Footed Side Access Tower with Laminate Fronts, Shelves/Box/Box/File						
	50"H x 24"W x 24"D, Wardrobe Left	HSTSSF502424LBBFL(?)	215	18.6	\$2349	\$2416	\$2484
	50"H x 24"W x 24"D, Wardrobe Right	HSTSSF502424RBBFL(?)	215	18.6	\$2349	\$2416	\$2484
	Footed Side Access Tower with Laminate Fronts, Shelves/File/File						
	50"H x 24"W x 24"D, Wardrobe Left	HSTSSF502424LFFL(?)	215	18.6	\$2349	\$2416	\$2484
	50"H x 24"W x 24"D, Wardrobe Right	HSTSSF502424RFFL(?)	215	18.6	\$2349	\$2416	\$2484
	Tower Kickplates (Field Installable)						
	For 24" Tower, Left	HSTAKL	2	0.3	\$ 145	\$ 153	\$ 158
	For 24" Tower, Right	HSTAKR	2	0.3	\$ 145	\$ 153	\$ 158
	Specify: Model.Paint						
	SPECIFYING EXAMPLE: HSATKL.P						

How to specify	1st Option	2nd Option	3rd Option	4th Option
Select Model Number from above	Select Paint Color	Select Lock Option	Select Laminate Option	Select Foot Color
Replace (?) with handle choice	P Black	L Standard Lock	L1 (no upcharge)	T1 Platinum Metallic
A Satin Chrome Arch	S Charcoal	X Omit Lock	COGN Cognac	
	T5 Greige		C Harvest	
	Q Light Gray		N Mahogany	
	LOFT Loft		MOCH Mocha	
	T3 Muslin		D Natural Maple	
	L Putty		PINC Pinnacle	
	SHDW Shadow		F Shaker Cherry	
	WHIT Brilliant White		L2 (\$35 upcharge)	
	T4 Champagne Metallic		LLA1 Lowell Ash	
	T1 Platinum Metallic		LNR1 Natural Recon	
			LPE1 Phantom Ecru	
			LPT1 Portico Teak	
			LSW1 Skyline Walnut	
H S T S F 6 5 2 4 2 4 L B B F L A .	P .	L .	C .	T 1

Contain[®] Metal Pedestals

GSA SIN 711-3



- ▶ Ball bearing suspension on box and file drawer. (100%)
- ▶ Drawers color to be interior gray steel.
- ▶ See page 465 for Pedestal Seat.
- ▶ File drawer has high sides and back for filing front to back and side to side.
- ▶ Counterweight standard on all mobile peds.
- ▶ Optional steel tops and pedestal seat cushions available. See pages 463 and 467.
- ▶ **Available drawer fronts; R-Pull, A-Pull and N-Pull. A-Pull available in Satin Chrome only.**
- ▶ **Peds come with a plinth base, footed base or mobile base. New HON foot available in Platinum Metallic only.**



	Description	Model	Ship Weight	Cube	List by Paint Grade		
					Core	Choice/Metallics	Custom
	Hanging Pedestal with Metal Fronts, Box/File						
	18"H x 15"W x 18"D	HSPH181518BFM(?)	35.8	4.4	\$ 530	\$ 558	\$ 586
	18"H x 15"W x 24"D	HSPH181524BFM(?)	39.3	5.7	\$ 564	\$ 592	\$ 620
	18"H x 15"W x 30"D	HSPH181530BFM(?)	45.6	6.4	\$ 597	\$ 625	\$ 653
	Mobile Pedestal with Metal Fronts, Box/File						
	21"H x 15"W x 18"D	HSPM211518BFM(?)	63.5	4.4	\$ 530	\$ 558	\$ 586
	21"H x 15"W x 24"D	HSPM211524BFM(?)	61.9	5.7	\$ 568	\$ 596	\$ 624
	Mobile Pedestal with Metal Fronts, Box/Box/File						
	27"H x 15"W x 18"D	HSPM271518BBFM(?)	63.4	5.3	\$ 686	\$ 714	\$ 742
	27"H x 15"W x 24"D	HSPM271524BBFM(?)	71.9	6.6	\$ 724	\$ 752	\$ 780
	27"H x 15"W x 30"D	HSPM271530BBFM(?)	83.6	8.2	\$ 762	\$ 790	\$ 818
	Mobile Pedestal with Metal Fronts, File/File						
	27"H x 15"W x 18"D	HSPM271518FFM(?)	60.9	5.3	\$ 686	\$ 714	\$ 742
	27"H x 15"W x 24"D	HSPM271524FFM(?)	65.7	6.6	\$ 724	\$ 752	\$ 780
	27"H x 15"W x 30"D	HSPM271530FFM(?)	75.2	8.2	\$ 762	\$ 790	\$ 818
	Plinth Support Pedestal with Metal Fronts, Box/Box/File						
	28"H x 15"W x 18"D	HSPSBX281518BBFM(?)	50.4	5.9	\$ 663	\$ 691	\$ 719
	28"H x 15"W x 24"D	HSPSBX281524BBFM(?)	58.6	7.5	\$ 700	\$ 728	\$ 756
	28"H x 15"W x 30"D	HSPSBX281530BBFM(?)	69.8	9.3	\$ 738	\$ 766	\$ 794
	Plinth Support Pedestal with Metal Fronts, File/File						
	28"H x 15"W x 18"D	HSPSBX281518FFM(?)	45.1	5.9	\$ 663	\$ 691	\$ 719
	28"H x 15"W x 24"D	HSPSBX281524FFM(?)	52.1	7.5	\$ 700	\$ 728	\$ 756
	28"H x 15"W x 30"D	HSPSBX281530FFM(?)	61.1	9.3	\$ 738	\$ 766	\$ 794

How to specify	1st Option	2nd Option
<p>Select Model Number from above</p> <p>Replace (?) with handle choice</p> <p>A Satin Chrome Arch N Full Face Integral R Full Radius</p>	<p>Select Paint Color</p> <p>P Black S Charcoal T5 Greige Q Light Gray LOFT Loft T3 Muslin L Putty SHDW Shadow</p> <p>WHIT Brilliant White T4 Champagne Metallic T1 Platinum Metallic</p>	<p>Select Lock Option</p> <p>L Standard Lock X Omit Lock</p>
H S P H 1 8 1 5 1 8 B F M A .	P .	L

Icon Legend on page 10

- ▶ Ball bearing suspension on box and file drawer. (100%)
- ▶ Drawers color to be interior gray steel.
- ▶ File drawer has high sides and back for filing front to back and side to side.
- ▶ Counterweight standard on all mobile peds.
- ▶ Optional steel tops and pedestal seat cushions available. See pages 463 and 467.
- ▶ Available drawer fronts; R-Pull, A-Pull and N-Pull. A-Pull available in Satin Chrome only.
- ▶ Peds come with a plinth base, footed base or mobile base. New HON foot available in Platinum Metallic only.



	Description	Model	Ship Weight	Cube	List by Paint Grade		
					Core	Choice/Metallics	Custom
	Footed Freestanding Pedestal with Metal Fronts, Box/File 22"H x 15"W x 18"D	HSPFSF221518BFM(?)	66.8	4.4	\$ 622	\$ 650	\$ 678
	22"H x 15"W x 24"D	HSPFSF221524BFM(?)	73.1	5.7	\$ 658	\$ 686	\$ 714
	Footed Support Pedestal with Metal Fronts, Box/Box/File 28"H x 15"W x 18"D	HSPSSF281518BBFM(?)	49.8	5.3	\$ 778	\$ 806	\$ 834
	28"H x 15"W x 24"D	HSPSSF281524BBFM(?)	57.4	6.6	\$ 814	\$ 842	\$ 870
	28"H x 15"W x 30"D	HSPSSF281530BBFM(?)	68.3	8.2	\$ 852	\$ 880	\$ 908
	Footed Support Pedestal with Metal Fronts, File/File 28"H x 15"W x 18"D	HSPSSF281518FFM(?)	47.3	5.3	\$ 778	\$ 806	\$ 834
	28"H x 15"W x 24"D	HSPSSF281524FFM(?)	54.3	6.6	\$ 814	\$ 842	\$ 870
	28"H x 15"W x 30"D	HSPSSF281530FFM(?)	60.0	8.2	\$ 852	\$ 880	\$ 908
	Flush Pedestal Kickplates (Field Installable) Specify: Model.Paint	HSPAK15	2.0	0.2	\$ 98	\$ 106	\$ 111
	SPECIFYING EXAMPLE: HSPAK.P						
	Steel Top Accessory (Field Installable) 15"W x 18"D	HSPAST1518	4.0	1.3	\$ 166	\$ 177	\$ 188
	15"W x 24"D	HSPAST1524	5.0	1.3	\$ 175	\$ 187	\$ 199
	15"W x 30"D	HSPAST1530	6.0	1.5	\$ 189	\$ 203	\$ 217
	Specify: Model.Paint						
	SPECIFYING EXAMPLE: HSPAST.P						

Description	Model	Ship Weight	Cube	List
Counterweight — Freestanding Support Pedestals or Systems Support and Mobile Pedestals	HPCW1	18	0.1	\$ 177

Description	Model	Ship Weight	Cube	Price Code	List
 Pedestal Seat 15"W x 22 1/8"D x 2"H NOTES: For seating fabrics, see pages 488-505 and 522-523. SPECIFYING EXAMPLE: HPSEAT24ND.AB10	HPSEAT24ND	10	1.2	1	\$ 176
				2	\$ 200
				3	\$ 224
				4	\$ 248
				5	\$ 279
				6	\$ 310
				7	\$ 341
				8	\$ 372
				9	\$ 403
				10	\$ 434
				11	\$ 465
				12	\$ 496

How to specify	1st Option	2nd Option	3rd Option
Select Model Number from above Replace (?) with handle choice A Satin Chrome Arch N Full Face Integral R Full Radius	Select Paint Color P Black S Charcoal T5 Greige Q Light Gray LOFT Loft T3 Muslin L Putty SHDW Shadow WHIT Brilliant White T4 Champagne Metallic T1 Platinum Metallic	Select Lock Option L Standard Lock X Omit Lock	Select Foot Color T1 Platinum Metallic
H S P F S F 2 2 1 5 1 8 B F M A	P	L	T 1

Icon Legend on page 10

Contain[®] Metal Pedestals with Laminate Fronts

GSA SIN 711-3



- ▶ Ball bearing suspension on box and file drawer. (100%)
- ▶ Drawers color to be interior gray steel.
- ▶ File drawer has high sides and back for filing front to back and side to side.
- ▶ Counterweight standard on all mobile peds.
- ▶ See page 465 for Pedestal Seat.
- ▶ Optional steel tops and pedestal seat cushions available. See pages 463 and 467.
- ▲ **Drawer Fronts available with Satin Chrome Arch only.**
- ▲ **Peds come with a plinth base, footed base or mobile base. New HON foot available in Platinum Metallic only.**



	Description	Model	Ship Weight	Cube	List by Paint Grade		
					Core	Choice/Metallics	Custom
	Hanging Pedestal with Laminate Fronts, Box/File						
	18"H x 15"W x 18"D, Arch Pull	HSPH181518BFLA(?)	37.6	4.4	\$ 678	\$ 706	\$ 734
	18"H x 15"W x 24"D, Arch Pull	HSPH181524BFLA(?)	43.9	5.7	\$ 711	\$ 739	\$ 767
	18"H x 15"W x 30"D, Arch Pull	HSPH181530BFLA(?)	53.0	6.4	\$ 745	\$ 773	\$ 801
	Mobile Pedestal with Laminate Fronts, Box/File						
	21"H x 15"W x 18"D, Arch Pull	HSPM211518BFLA(?)	65.3	4.4	\$ 678	\$ 706	\$ 734
	21"H x 15"W x 24"D, Arch Pull	HSPM211524BFLA(?)	63.7	5.7	\$ 716	\$ 744	\$ 772
	Mobile Pedestal with Laminate Fronts, Box/Box/File						
	27"H x 15"W x 18"D, Arch Pull	HSPM271518BBFLA(?)	65.0	5.3	\$ 880	\$ 908	\$ 936
	27"H x 15"W x 24"D, Arch Pull	HSPM271524BBFLA(?)	73.5	6.6	\$ 917	\$ 945	\$ 973
	27"H x 15"W x 30"D, Arch Pull	HSPM271530BBFLA(?)	85.2	8.2	\$ 956	\$ 984	\$1012
	Mobile Pedestal with Laminate Fronts, File/File						
	27"H x 15"W x 18"D, Arch Pull	HSPM271518FFLA(?)	63.4	5.3	\$ 880	\$ 908	\$ 936
	27"H x 15"W x 24"D, Arch Pull	HSPM271524FFLA(?)	68.1	6.6	\$ 917	\$ 945	\$ 973
	27"H x 15"W x 30"D, Arch Pull	HSPM271530FFLA(?)	77.6	8.2	\$ 956	\$ 984	\$1012
	Plinth Support Pedestal with Laminate Fronts, Box/Box/File						
	28"H x 15"W x 18"D, Arch Pull	HSPSBX281518BBFLA(?)	51.7	5.9	\$ 857	\$ 885	\$ 913
	28"H x 15"W x 24"D, Arch Pull	HSPSBX281524BBFLA(?)	59.9	7.5	\$ 894	\$ 922	\$ 950
	28"H x 15"W x 30"D, Arch Pull	HSPSBX281530BBFLA(?)	71.1	9.3	\$ 932	\$ 960	\$ 988
	Plinth Support Pedestal with Laminate Fronts, File/File						
	28"H x 15"W x 18"D, Arch Pull	HSPSBX281518FFLA(?)	47.6	5.9	\$ 857	\$ 885	\$ 913
	28"H x 15"W x 24"D, Arch Pull	HSPSBX281524FFLA(?)	54.6	7.5	\$ 894	\$ 922	\$ 950
	28"H x 15"W x 30"D, Arch Pull	HSPSBX281530FFLA(?)	63.6	9.3	\$ 932	\$ 960	\$ 988

How to specify	1st Option	2nd Option	3rd Option
Select Model Number from above Replace (?) with handle choice A Satin Chrome Arch	Select Paint Color P Black S Charcoal T5 Greige Q Light Gray LOFT Loft T3 Muslin L Putty SHDW Shadow WHIT Brilliant White T4 Champagne Metallic T1 Platinum Metallic	Select Lock Option L Standard Lock X Omit Lock	Select Laminate Option L1 (no upcharge) COGN Cognac C Harvest N Mahogany MOCH Mocha D Natural Maple PINC Pinnacle F Shaker Cherry L2 (\$10 upcharge) LLA1 Lowell Ash LNR1 Natural Recon LPE1 Phantom Ecu LPT1 Portico Teak LSW1 Skyline Walnut
H S P H 1 8 1 5 1 8 B F L A A .	P .	L .	C

Icon Legend on page 10

- ▶ Ball bearing suspension on box and file drawer. (100%)
- ▶ Drawers color to be interior gray steel.

- ▶ File drawer has high sides and back for filing front to back and side to side.
- ▶ Counterweight standard on all mobile peds.

- ▶ See page 465 for pedestal seat.
- ▶ Optional steel tops and pedestal seat cushions available. See pages 463 and 467.



▲ **Drawer Fronts available with Satin Chrome Arch only.**

▲ **Peds come with a plinth base, footed base or mobile base. New HON foot available in Platinum Metallic only.**

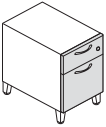
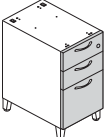
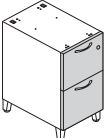

Description	Model	Ship Weight	Cube	List by Paint Grade		
				Core	Choice/Metallics	Custom
 <p>Footed Freestanding Pedestal with Laminate Fronts, Box/File 22"H x 15"W x 18"D, Arch Pull 22"H x 15"W x 24"D, Arch Pull</p>	HSPFSF221518BFLA(?)	69.0	4.4	\$ 770	\$ 798	\$ 826
	HSPFSF221524BFLA(?)	75.3	5.7	\$ 806	\$ 834	\$ 862
 <p>Footed Support Pedestal with Laminate Fronts, Box/Box/File 28"H x 15"W x 18"D, Arch Pull 28"H x 15"W x 24"D, Arch Pull 28"H x 15"W x 30"D, Arch Pull</p>	HSPSSF281518BBFLA(?)	51.4	5.3	\$ 972	\$1000	\$1028
	HSPSSF281524BBFLA(?)	59.0	6.6	\$1008	\$1036	\$1064
	HSPSSF281530BBFLA(?)	69.9	8.2	\$1046	\$1074	\$1102
 <p>Footed Support Pedestal with Laminate Fronts, File/File 28"H x 15"W x 18"D, Arch Pull 28"H x 15"W x 24"D, Arch Pull 28"H x 15"W x 30"D, Arch Pull</p>	HSPSSF281518FFLA(?)	49.7	5.3	\$ 972	\$1000	\$1028
	HSPSSF281524FFLA(?)	56.7	6.6	\$1008	\$1036	\$1064
	HSPSSF281530FFLA(?)	62.4	8.2	\$1046	\$1074	\$1102

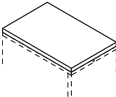
How to specify	1st Option	2nd Option	3rd Option	4th Option
<p>Select Model Number from above</p> <p>Replace (?) with handle choice</p> <p>A Satin Chrome Arch</p>	<p>Select Paint Color</p> <p>P Black S Charcoal T5 Greige Q Light Gray LOFT Loft T3 Muslin L Putty SHDW Shadow</p> <p>WHIT Brilliant White T4 Champagne Metallic T1 Platinum Metallic</p>	<p>Select Lock Option</p> <p>L Standard Lock X Omit Lock</p>	<p>Select Laminate Option</p> <p>L1 (no upcharge)</p> <p>COGN Cognac C Harvest N Mahogany MOCH Mocha D Natural Maple PINC Pinnacle F Shaker Cherry</p> <p>L2 (\$10 upcharge)</p> <p>LLA1 Lowell Ash LNR1 Natural Recon LPE1 Phantom Ecru LPT1 Portico Teak LSW1 Skyline Walnut</p>	<p>Select Foot Color</p> <p>T1 Platinum Metallic</p>
	H S P F S F 2 2 1 5 1 8 B F L A A .	P .	L .	C .
				T 1

Description	Model	Ship Weight	Cube	Price Code	List
 <p>Pedestal Seat 15"W x 22 7/8"D x 2"H</p> <p>NOTES: For seating fabrics, see pages 488-505 and 522-523.</p>	HPSEAT24ND	10 	1.2	1	\$ 176
				2	\$ 200
				3	\$ 224
				4	\$ 248
				5	\$ 279
				6	\$ 310
				7	\$ 341
				8	\$ 372
				9	\$ 403
				10	\$ 434
				11	\$ 465
				12	\$ 496

NOTE: See Brigade™ pedestals on page 436 for additional pedestal options. See pages 479-480 for Pedestal Accessories.

How to specify	1st Option
<p>Select Model Number from above</p> <p>H P S E A T 2 4 .</p>	<p>Select Fabric</p> <p>See pages 488-505 and 522-523 for seating fabric options</p> <p>A B 1 0</p>

    Icon Legend on page 10

Flagship® Hanging and Standard Height Pedestals

GSA SIN 711-1 Except as Noted



- ▶ 28"H fits under all HON worksurfaces and desk shells.
- ▶ Pencil tray standard in top box drawer.
- ▶ One box divider for pedestals with a box drawer.
- ▶ One crossrail standard in each file drawer.
- ▶ Steel ball-bearing suspension on file and box drawers.
- ▶ Full extension on all drawers.
- ▶ File drawers have high sides for filing front-to-back.
- ▶ See pages 479-480 for accessories and pedestal utilization information.
- ▶ Equipped with HON "One Key" interchangeable core removable locks.
- ▶ Hanging units are mounted using keyhole slots in top of pedestals; all hardware provided.
- ▶ Arch pull available in Satin Chrome only.
- ▶ Available in Arch (A), Full Face Integral (N) and Full Radius (R) Drawer Pulls. See page 434 for pull options.
- ▶ Choose from any of three pull options with no upcharge.
- ▶ Counterweight standard in mobile pedestals.
- ▶ Omit lock-option available. See page 743 for ordering instructions.

△ **Freestanding support pedestals that are not positioned and attached under a worksurface, require a counterweight kit found on page 479.**



	Description	Model	Ship Weight	Cube	List by Paint Grade		
					Core	Choice/Metallics	Custom
	Hanging Pedestals — Box/File 15"W x 16 7/8"D x 19 1/2"H 15"W x 22 7/8"D x 19 1/2"H	Open Market H14917(?)	41	4.4	\$ 482	\$ 510	\$ 538
		H14923(?)	48	6.0	\$ 513	\$ 541	\$ 569
	Standard Height Mobile Pedestals — Box/Box/File 15"W x 16 7/8"D x 28"H 15"W x 22 7/8"D x 28"H 15"W x 28 7/8"D x 28"H	Open Market H18717(?)	76	5.9	\$ 612	\$ 640	\$ 668
		H18723(?)	88	8.0	\$ 658	\$ 686	\$ 714
		H18730(?)	102	9.8	\$ 707	\$ 735	\$ 763
	Standard Height Mobile Pedestals — File/File 15"W x 16 7/8"D x 28"H 15"W x 22 7/8"D x 28"H 15"W x 28 7/8"D x 28"H	Open Market H18817(?)	72	5.9	\$ 612	\$ 640	\$ 668
		H18823(?)	85	8.0	\$ 658	\$ 686	\$ 714
		H18830(?)	98	9.8	\$ 707	\$ 735	\$ 763
	Standard Height Freestanding Support Pedestals — Box/Box/File 15"W x 16 7/8"D x 28"H 15"W x 22 7/8"D x 28"H 15"W x 28 7/8"D x 28"H	Open Market H19717(?)	59	5.9	\$ 602	\$ 630	\$ 658
		H19723(?)	73	8.0	\$ 649	\$ 677	\$ 705
		H19730(?)	87	9.8	\$ 697	\$ 725	\$ 753
	Standard Height Freestanding Support Pedestals — File/File 15"W x 16 7/8"D x 28"H 15"W x 22 7/8"D x 28"H 15"W x 28 7/8"D x 28"H	Open Market H19817(?)	55	5.9	\$ 602	\$ 630	\$ 658
		H19823(?)	70	8.0	\$ 649	\$ 677	\$ 705
		H19830(?)	83	9.8	\$ 697	\$ 725	\$ 753

NOTE: See Brigade™ pedestals on page 436 for additional pedestal options. See pages 479-480 for Pedestal Accessories.

How to specify	1st Option	2nd Option
Select Model Number from above A Satin Chrome Arch N Full Face Integral R Full Radius H 1 4 9 1 7 A .	Select Lock Option L Lock (no upcharge) X Omit Lock (deduct \$20) L .	Select Paint Color See page 435 P



- ▶ Pencil tray standard in top box drawer.
- ▶ One box divider for pedestals with a box drawer.
- ▶ One crossrail standard in each file drawer.
- ▶ File drawers have high sides for filing front-to-back.
- ▶ Steel ball-bearing suspension on file drawer, and box drawer.
- ▶ See pages 479-480 for accessories and pedestal utilization information.
- ▶ Arch pull available in Satin Chrome only.
- ▶ Choose from any of three pull options with no upcharge.
- ▶ Available in Arch (A), Full Face Integral (N) and Full Radius (R) Drawer Pulls. See page 434 for pull options.
- ▶ Equipped with HON "One Key" interchangeable core removable locks.
- ▶ Counterweight standard.
- ▶ Omit lock-option available. See page 743 for ordering instructions.



Description	Model	Ship Weight	Cube	List by Paint Grade		
				Core	Choice/Metallics	Custom
Mobile Pedestals — Box/File 15"W x 22 7/8"D x 22"H	H15923(?)	92	6.0	\$ 517	\$ 545	\$ 573

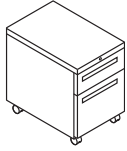

H15923N
SIN 711-1

How to specify	1st Option	2nd Option
Select Model Number from above A Satin Chrome Arch N Full Face Integral R Full Radius H 1 5 9 2 3 A .	Select Lock Option L Lock (no upcharge) X Omit Lock (deduct \$20) X .	Select Paint Color See page 435 T 1

Description	Model	Ship Weight	Cube	Price	
				Code	List
Pedestal Seat 15"W x 22 7/8"D x 2"H NOTES: For seating fabrics, see pages 488-505 and 522-523.	HPSEAT24ND	10	1.2	1	\$ 176
				2	\$ 200
				3	\$ 224
				4	\$ 248
				5	\$ 279
				6	\$ 310
				7	\$ 341
				8	\$ 372
				9	\$ 403
				10	\$ 434
				11	\$ 465
				12	\$ 496

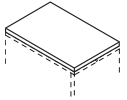

SIN 711-2

NOTE: See Brigade™ pedestals on page 436 for additional pedestal options. See pages 479-480 for Pedestal Accessories.

How to specify	1st Option
Select Model Number from above H P S E A T 2 4 .	Select Fabric See pages 488-505 and 522-523 for seating fabric options A B 1 0





Flagship® 18" Deep Lateral Files with Drawers

GSA SIN 711-3



- ▶ 27 1/4" H lateral file fit under minimum worksurface height of 28 1/2" H.
- ▶ 28" H lateral fit under standard 38000 Series and worksurfaces.
- ▶ Flush top and sides.
- ▶ Reinforced case construction.
- ▶ Lock mechanism serves both sides of drawer.
- ▶ Equipped with HON "One Key" interchangeable core removable locks.
- ▶ Counterweight included where applicable to meet ANSI/BIFMA stability requirements.
- ▶ Three-part, telescoping, steel ball-bearing suspension.
- ▶ Features drawer extension restraint; mechanical interlock inhibits the extension of more than one drawer at a time.
- ▶ Optional laminate tops and accessories — see page 481.
- ▶ Matching Pedestals — see page 466.
- ▶ Optional Posting Shelf on five-opening units.
- ▶ Omit lock-option available. See page 743 for ordering instructions.
- ▶ Arch pull available in Satin Chrome only.
- ▶ Choose from any of three pull options with no upcharge.
- ▶ Available in Arch (A), Full Face Integral (N) and Full Radius (R) Drawer Pulls. See below and page 434 for pull options.

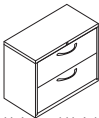
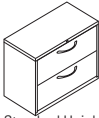

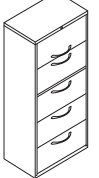
Description	Model	Ship Weight	Cube	List by Paint Grade		
				Core	Choice/ Metallics	Custom
 Universal Height Lateral File — 2 Drawer 30"W x 18"D x 27 1/4"H 36"W x 18"D x 27 1/4"H 42"W x 18"D x 27 1/4"H	H9172(?)	138	12.0	\$ 862	\$ 895	\$ 929
	H9182(?)	156	14.5	\$ 954	\$ 987	\$1021
	H9192(?)	177	16.8	\$1104	\$1137	\$1171
 Standard Height Lateral File — 2 Drawer 30"W x 18"D x 28"H 36"W x 18"D x 28"H 42"W x 18"D x 28"H	H9170(?)	138	12.3	\$ 847	\$ 880	\$ 914
	H9180(?)	156	14.5	\$ 936	\$ 969	\$1003
	H9190(?)	177	16.8	\$1084	\$1117	\$1151
 Lateral File — 3 Drawer 30"W x 18"D x 39 1/8"H 36"W x 18"D x 39 1/8"H 42"W x 18"D x 39 1/8"H	H9173(?)	150	16.9	\$1111	\$1144	\$1178
	H9183(?)	174	20.0	\$1247	\$1280	\$1314
	H9193(?)	197	23.2	\$1442	\$1475	\$1509
 Lateral File w/o Posting Shelf — 4 Drawer 30"W x 18"D x 52 1/2"H 36"W x 18"D x 52 1/2"H 42"W x 18"D x 52 1/2"H	H9174(?)	176	22.1	\$1400	\$1467	\$1533
	H9184(?)	198	26.2	\$1589	\$1656	\$1722
	H9194(?)	213	30.3	\$1824	\$1891	\$1957
 Lateral File — 5 Drawer 30"W x 18"D x 64 1/4"H, w/Posting Shelf 30"W x 18"D x 64 1/4"H, w/o Posting Shelf 36"W x 18"D x 64 1/4"H, w/Posting Shelf 36"W x 18"D x 64 1/4"H, w/o Posting Shelf 42"W x 18"D x 64 1/4"H, w/Posting Shelf 42"W x 18"D x 64 1/4"H, w/o Posting Shelf	H9275(?)	210	26.8	\$1825	\$1892	\$1958
	H9175(?)	203	26.8	\$1788	\$1855	\$1921
	H9285(?)	245	31.8	\$2055	\$2122	\$2188
	H9185(?)	238	31.8	\$2014	\$2081	\$2147
	H9295(?)	271	36.8	\$2372	\$2439	\$2505
	H9195(?)	264	36.8	\$2334	\$2401	\$2467

NOTES: Top drawer is a roll-out shelf.



NOTE: See page 444 for Overfiles and page 481 for Lateral File Accessories.

How to specify	1st Option	2nd Option
Select Model Number from above A Satin Chrome Arch N Full Face Integral R Full Radius H 9 1 7 2 A .	Select Lock Option L Lock (no upcharge) X Omit Lock (deduct \$20) L .	Select Paint Color See page 435 P

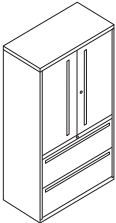

Icon Legend on page 10

- ▶ 64 1/4" H models complement Flagship lateral file heights.
- ▶ Equipped with HON "One Key" interchangeable core removable locks. Locks on storage cabinet doors and lateral file are keyed-alike.
- ▶ Three-part, telescoping, steel ball-bearing suspension.
- ▶ Includes two adjustable shelves, adjustable in 2" increments.
- ▶ Lock mechanism serves both sides of drawer.
- ▶ Features drawer extension restraint; mechanical interlock inhibits the extension of more than one drawer at a time.
- ▶ Wire management grommet in back of unit.
- ▶ Omit lock-option available. See page 743 for ordering instructions.
- ▶ Flush top and sides.
- ▶ Choose from any of three pull options with no upcharge.
- ▶ Arch pull available in Satin Chrome only.
- ▶ Available in Arch (A), Full Face Integral (N) and Full Radius (R) Drawer Pulls. See page 434 for pull options.

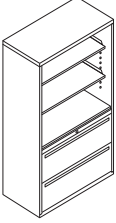

Description	Model	Ship Weight	Cube	List by Paint Grade		
				Core	Choice/Metallics	Custom
 <p>Lateral Files with Storage and Hinged Doors 36"W x 18"D x 64 1/4"H</p> <p>NOTES: Lateral File drawers lock independently from storage case.</p>	H9185LS(?) 	203	31.8	\$1930	\$1997	\$2063

Model H9185LSN shown

 <p>Lateral Files with Open Shelves, No Doors 36"W x 18"D x 64 1/4"H</p>	H9185LSN(?) 	184	31.8	\$1761	\$1828	\$1894
--	--	-----	------	--------	--------	--------

Model H9185LSNN shown

How to specify	1st Option	2nd Option
<p>Select Model Number from above</p> <p>A Satin Chrome Arch N Full Face Integral R Full Radius</p> <p>H 9 1 8 5 L S A .</p>	<p>Select Lock Option</p> <p>L Lock (no upcharge) X Omit Lock (deduct \$40 for models H91756LS and H9185LS) (deduct \$20 for models H9175LSN and H9185LSN)</p> <p>X .</p>	<p>Select Paint Color</p> <p>See page 435</p> <p>P </p>

Flagship® Bookcases

GSA SIN 711-3

HON

- ▶ 64¼"H models complement Flagship lateral file heights.
- ▶ Flush top and sides.
- ▶ Reinforced case construction.
- ▶ Shelves adjust in 2" increments.
- ▶ Wire management grommet in back of unit.

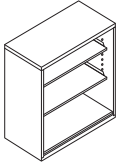
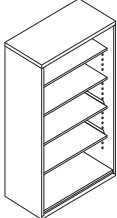

Description	Model	Ship Weight	Cube	List by Paint Grade		
				Core	Choice/ Metallics	Custom
 <p>3 Shelf 36"W x 18"D x 39½"H</p>	HFSC183640W	100	20.0	\$ 748	\$ 781	\$ 815
 <p>5 Shelf 36"W x 18"D x 64¼"H</p>	HFSC183664W	148	31.8	\$1109	\$1176	\$1242

How to specify

Select Model Number
from above

H | F | S | C | 1 | 8 | 3 | 6 | 4 | 0 | W | . | P |

1st Option

Select Paint Color





See page 435

Flagship® Storage Cabinets

GSA SIN 711-3

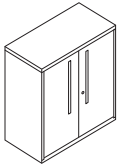
- ▶ 64¼"H models complement Flagship lateral file heights.
- ▶ Flush top and sides.
- ▶ Reinforced case construction.
- ▶ Includes adjustable shelves, adjustable in 2" increments.
- ▶ Arch pull available in Satin Chrome only.
- ▶ Choose from any of three pull options with no upcharge.
- ▶ Available in Arch (A), Full Face Integral (N) and Full Radius (R) Drawer Pulls. See below and page 434 for pull options.
- ▶ Adjustable leveling glide is standard.
- ▶ Equipped with HON "One Key" interchangeable core removable locks.
- ▶ Wire management grommet in back of unit.
- ▶ Omit lock-option available. See page 743 for ordering instructions.

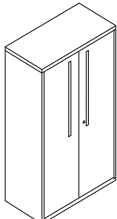

Description	Model	Ship Weight	Cube	List by Paint Grade		
				Core	Choice/ Metallics	Custom
 <p>Storage Cabinets 36"W x 18"D x 39½"H (with lock) 2 adjustable shelves</p> <p><i>Model HFSC183640N shown</i></p>	HFSC183640(?) 	119	20.0	\$ 926	\$ 993	\$1059
 <p>36"W x 18"D x 64¼"H (with lock) 4 adjustable shelves</p> <p><i>Model HFSC183664N shown</i></p>	HFSC183664(?) 	184	31.8	\$1351	\$1418	\$1484

How to specify

Select Model Number
from above

Select the Pull

A Satin Chrome Arch
N Full Face Integral
R Full Radius

H | F | S | C | 1 | 8 | 3 | 6 | 4 | 0 | A | .

1st Option

Select Lock Option

L Lock (no upcharge)
X Omit Lock
(deduct \$20)

L | .

2nd Option

Select Paint Color



See page 435



P |

 Icon Legend on page 10

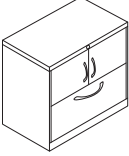
- ▶ File Center tops are 1 1/8" thick.
- ▶ Flush top and sides.
- ▶ 28"H File Center fits under all HON worksurfaces and desk shells.
- ▶ See page 481 for Lateral File Accessories.
- ▶ Heavy duty steel ball-bearing suspension on all drawers.
- ▶ Box drawers contain one divider.
- ▶ Each lateral drawer contains one set of hangrails for side-to-side filing.
- ▶ One lock located in top; secures all drawers.
- ▶ 4 leveling glides standard.
- ▶ Equipped with HON "One Key" interchangeable core removable locks, where applicable.
- ▶ Drawers on all units are locking, doors are non-locking.
- ▶ Standard with counterweight.
- ▶ Reinforced case construction.
- ▶ Available in Arch (A), Full Face Integral (N) and Full Radius (R) Drawer Pulls. See page 434 for pull options.
- ▶ Choose from any of three pull options with no upcharge.
- ▶ Arch pull available in Satin Chrome only.

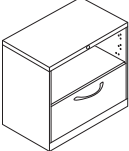

Description	Model	Ship Weight	Cube	List by Paint Grade		
				Core	Choice/Metallics	Custom
 <p>Lateral File, bottom, locking; Shelf with Doors, non-locking, top 30"W x 18"D x 28"H, Standard Height</p> <p>Model: HFC1830DLF(?) </p> <p>Ship Weight: 105 Cube: 12.3 Core: \$1063 Choice/Metallics: \$1096 Custom: \$1131</p> <p>NOTES: Total filing space in top opening is 11 5/8". Accommodates one row of standard height binders.</p>						

 <p>Lateral File, bottom, locking; Shelf without Doors, top 30"W x 18"D x 28"H, Standard Height</p> <p>Model: HFC1830NLF(?) </p> <p>Ship Weight: 99 Cube: 12.3 Core: \$1001 Choice/Metallics: \$1034 Custom: \$1069</p> <p>NOTES: Total filing space in top opening is 11 5/8". Accommodates one row of standard height binders.</p>						
---	--	--	--	--	--	--

How to specify	1st Option	2nd Option
<p>Select Model Number from above</p> <p>Select the Pull</p> <p>A Satin Chrome Arch N Full Face Integral R Full Radius</p> <p>H F C 1 8 3 0 D L F A .</p>	<p>Select Lock Option</p> <p>L Lock (no upcharge) X Omit Lock (deduct \$20)</p> <p>L .</p>	<p>Select Paint Color</p> <p>See page 435</p> <p>T 1 </p>

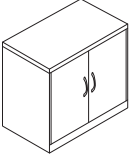
Description	Model	Ship Weight	Cube	List by Paint Grade		
				Core	Choice/Metallics	Custom
 <p>File Center with Doors and Shelf, non-locking 30"W x 18"D x 28"H, Standard Height</p> <p>Model: HFC1830DD(?)</p> <p>Ship Weight: 84 Cube: 12.3 Core: \$ 823 Choice/Metallics: \$ 856 Custom: \$ 891</p> <p>NOTES: Total opening is 23 1/4". Will accommodate one row of binders either above or below the shelf. Shelf adjustable in 2" increments.</p>						

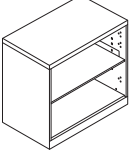
 <p>File Center without Doors, includes one Shelf 30"W x 18"D x 28"H, Standard Height</p> <p>Model: HFC1830NN</p> <p>Ship Weight: 74 Cube: 12.3 Core: \$ 700 Choice/Metallics: \$ 733 Custom: \$ 768</p> <p>NOTES: Total opening is 23 1/4". Will accommodate one row of binders either above or below the shelf. Shelf adjustable in 2" increments.</p>						
--	--	--	--	--	--	--

How to specify	1st Option
<p>Select Model Number from above</p> <p>Select the Pull</p> <p>A Satin Chrome Arch N Full Face Integral R Full Radius</p> <p>H F C 1 8 3 0 D D A .</p>	<p>Select Paint Color</p> <p>See page 435</p> <p>T 1 </p>

Flagship® Standard Height File Center with Bookcase

GSA SIN 711-3



- ▶ File Center tops are 1 1/8" thick.
- ▶ Flush top and sides.
- ▶ 28"H File Centers fit under all HON worksurfaces and desk shells.
- ▶ Heavy duty steel ball-bearing suspension on all drawers.
- ▶ Box drawers contain one divider.
- ▶ One lock located in top; secures all drawers.
- ▶ 4 leveling glides standard.
- ▶ Available in Arch (A), Full Face Integral (N) and Full Radius (R) Drawer Pulls. See page 434 for pull options.
- ▶ Choose from any of three pull options with no upcharge.
- ▶ Arch pull available in Satin Chrome only.
- ▶ Equipped with HON "One Key" interchangeable core removable locks, where applicable.
- ▶ Drawers on all units are locking, doors are non-locking.
- ▶ Standard with counterweight.
- ▶ See page 481 for Lateral File Accessories.
- ▶ Reinforced case construction.

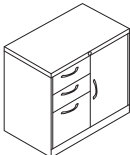
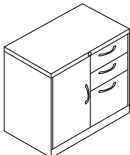
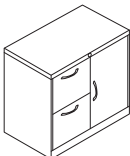
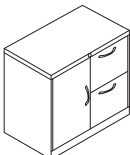

Description	Model	Ship Weight	Cube	List by Paint Grade		
				Core	Choice/Metallics	Custom
 Box/Box/File Left, Bookcase with Door, Right; non-locking 30"W x 18"D x 28"H, Standard Height Model: HFC1830BD(?) NOTES: Total opening is 23 3/4" on door side. Will accommodate one row of binders either above or below the shelf. Shelf adjustable in 2" increments.		110	12.3	\$1311	\$1344	\$1379
 Box/Box/File Right, Bookcase with Door, Left; non-locking 30"W x 18"D x 28"H, Standard Height Model: HFC1830DB(?) NOTES: Total opening is 23 3/4" on door side. Will accommodate one row of binders either above or below the shelf. Shelf adjustable in 2" increments.		110	12.3	\$1311	\$1344	\$1379
 File/File Left, Bookcase with Door, Right; non-locking 30"W x 18"D x 28"H, Standard Height Model: HFC1830FD(?) NOTES: Total opening is 23 3/4" on door side. Will accommodate one row of binders either above or below the shelf. Shelf adjustable in 2" increments.		118	12.3	\$1311	\$1344	\$1379
 File/File Right, Bookcase with Door, Left; non-locking 30"W x 18"D x 28"H, Standard Height Model: HFC1830DF(?) NOTES: Total opening is 23 3/4" on door side. Will accommodate one row of binders either above or below the shelf. Shelf adjustable in 2" increments.		118	12.3	\$1311	\$1344	\$1379

NOTE: See page 481 for Lateral File Accessories.

How to specify	1st Option	2nd Option
Select Model Number from above Select the Pull A Satin Chrome Arch N Full Face Integral R Full Radius H F C 1 8 3 0 B D A .	Select Lock Option L Lock (no upcharge) X Omit Lock (deduct \$20) L .	Select Paint Color See page 435 T 1

- ▶ 28"H File Center fit under standard 38000 Series™ and worksurfaces.
- ▶ 27 1/4"H File Center fit under minimum worksurface height of 28 1/2"H.
- ▶ Box and file drawer locations can be switched in the field.
- ▶ Steel ball-bearing suspension on all drawers.
- ▶ Includes 2 box drawer dividers, crossrail in file drawer and 1 set of lateral file hangrails for side-to-side filing.
- ▶ One cam lock located in center of top secures all drawers.
- ▶ Equipped with HON "One Key" interchangeable core removable lock.
- ▶ See page 481 for accessories.
- ▶ Arch pull available in Satin Chrome only.
- ▶ Available in Arch (A), Full Face Integral (N) and Full Radius (R) Drawer Pulls. See page 434 for pull options.
- ▶ Choose from any of three pull options with no upcharge.
- ▶ Omit lock-option available. See page 743 for ordering instructions.



Description	Model	Ship Weight	Cube	List by Paint Grade		
				Core	Choice/Metallics	Custom
File/Box/Box/Lateral 30"W x 18"D x 28"H (Standard Height)	HFC18730(?)	140	12.3	\$1311	\$1344	\$1378
File/Box/Box/Lateral 30"W x 18"D x 27 1/4"H (Universal Height)	HFC16730(?)	138	12.0	\$1455	\$1488	\$1522

NOTES: 1 file drawer, 2 box drawers and 1 lateral file drawer.

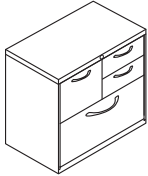

Model HFC18730A shown

NOTE: See page 481 for Lateral File Accessories.

How to specify	1st Option	2nd Option
<p>Select Model Number from above</p> <p>Select the Pull</p> <p>A Satin Chrome Arch N Full Face Integral R Full Radius</p> <p>H F C 1 8 7 3 0 A .</p>	<p>Select Lock Option</p> <p>L Lock (no upcharge) X Omit Lock (deduct \$20)</p> <p>L .</p>	<p>Select Paint Color</p> <p>See page 435</p> <p>T 1 </p>

FlameSafe™ Fire-Resistant Files

Not on GSA Contract

HON

VERTICAL FILES



- ▶ Full suspension.
- ▶ Non-asbestos.
- ▶ Follower block standard (spring-loaded).

- ▶ Chrome drawer pulls, thumb latch and label holder.
- ▶ Rated: Filing Device Class 350, 1700° for one hour with drop test.
- ▶ UL listed.

- ▶ High drawer sides.
- ▶ Available in Putty, Black and Gray only; see page 435.
- ▶ Insulated in drawer face and between drawers.

- ▶ Full Lifetime Warranty.
- ⚠ Lock is NOT core removable.



	Description	Model	Ship Weight	Cube	List
	Vertical File — 2-Drawer, Letter 17 ³ / ₄ "W x 25"D x 27 ³ / ₄ "H	H52	320	10.0	\$2991
	Vertical File — 2-Drawer, Legal 20 ³ / ₄ "W x 25"D x 27 ³ / ₄ "H	H52C	341	13.0	\$3068
	Vertical File — 4-Drawer, Letter 17 ³ / ₄ "W x 25"D x 52 ³ / ₄ "H	H54	546	17.0	\$4607
	Vertical File — 4-Drawer, Legal 20 ³ / ₄ "W x 25"D x 52 ³ / ₄ "H	H54C	596	21.0	\$4702

How to specify	1st Option	2nd Option
Select Model Number from above H 5 2 .	Select Lock Option P Lock P .	Select Paint Color P Black Q Light Gray L Putty P .

LATERAL FILES

- ▶ Telescoping suspension.
- ▶ Non-asbestos.
- ▶ Available in Putty, Black and Gray only; see page 435.

- ▶ Rated: Filing Device Class 350, 1700° for one hour with drop test.
- ▶ Insulated in drawer face and between drawers.
- ▶ UL listed.
- ▶ 4 hangrails per opening, standard.
- ▶ Black, plastic recessed drawer pulls.

- ▶ Full Lifetime Warranty.
- ⚠ Lock is NOT core removable.

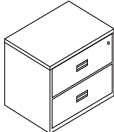

	Lateral File — 2-Drawer 31 ¹ / ₈ "W x 22 ¹ / ₈ "D x 27 ³ / ₄ "H	H32	436	11.0	\$4407
	Lateral File — 4-Drawer 31 ¹ / ₈ "W x 22 ¹ / ₈ "D x 52 ³ / ₄ "H NOTES: Lateral Drawer inside dimensions: 25 ³ / ₁₆ "W x 15 ¹ / ₈ "D x 10 ³ / ₈ "H	H34	723	26.0	\$6651

How to specify	1st Option	2nd Option
Select Model Number from above H 3 2 .	Select Lock Option P Lock P .	Select Paint Color P Black Q Light Gray L Putty P .

Icon Legend on page 10

- ▶ 30" & 36" case widths with drawers, 19 1/4" case depth.
- ▶ Flush top and sides.
- ▶ Reinforced case construction.
- ▶ Four adjustable leveling glides.
- ▶ Features drawer extension restraint; mechanical interlock inhibits the extension of more than one drawer at a time.



- ▶ Ball-bearing slide suspension.
- ▶ Two adjustable hangrails per drawer/roll-out shelf for side-to-side filing.
- ▶ Counterweight included where applicable to meet ANSI/BIFMA stability requirements.

- ▶ Lock mechanism secures both sides of drawer.
- ▶ Baked enamel finish over rust-inhibiting phosphate pre-treatment.
- ▶ Monochromatic drawer pull.

- ▶ Equipped with HON "One Key" interchangeable core removable locks.
- ▶ Optional laminate tops and accessories — see page 481.

⚠ **Keyed alike cores must be ordered separately — see page 743.**

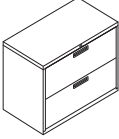

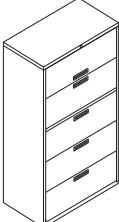
	Description	Model	Ship Weight	Cube	List
	Lateral File — 2 Drawer 30"W x 19 1/4"D x 28 3/8"H	H572	112	12.4	\$ 622
	36"W x 19 1/4"D x 28 3/8"H	H582	128	14.8	\$ 680
	Lateral File — 4 Drawer 30"W x 19 1/4"D x 53 1/4"H	H574	148	22.1	\$1041
	36"W x 19 1/4"D x 53 1/4"H	H584	177	26.4	\$1161
	Lateral File — 5 Drawer 4 Fixed front drawers; 1 Roll-out Shelf; Posting Shelf 36"W x 19 1/4"D x 67"H NOTES: Top drawer is a roll-out shelf.	H585	229	32.9	\$1506

NOTE: See page 444 for Overfiles and page 481 for Lateral File Accessories.

How to specify	Select Model Number from above H 5 7 2 .	1st Option Select Lock Option L Lock L .	2nd Option Select Paint Color See page 435 T 1
----------------	---	--	--

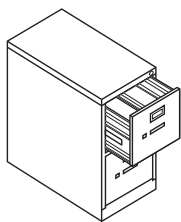

- ▶ High capacity file, 28½" Case depth with 27 front-to-back filing inches per drawer.
- ▶ Letter or legal sizes available.
- ▶ Three-part, telescoping, steel ball-bearing suspension.
- ▶ Bright aluminum drawer pulls, label holders and thumb latch.
- ▶ Standard interchangeable core removable locks. Equipped with HON "One Key" system.
- ▶ Accepts hanging files. High drawer sides hold hanging file folders without use of hangrails.
- ▶ Spring loaded follower block with positive side-action positioning, is adjustable on ½" centers.
- ▶ Baked enamel finish over rust-inhibiting phosphate pre-treatment.



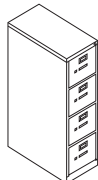
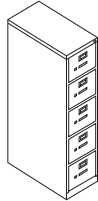

△ **Keyed alike cores must be ordered separately — see page 743.**



Description	Model	Ship Weight	Cube	List by Paint Grade		
				Core	Choice/ Metallics	Custom
 Vertical File — 2 Drawer 15"W x 28½"D x 29"H, Letter 18¼"W x 28½"D x 29"H, Legal	H212	65	9.8	\$ 670	\$ 698	\$ 726
	H212C	71	11.6	\$ 783	\$ 811	\$ 839
 Vertical File — 4 Drawer 15"W x 28½"D x 52"H, Letter 18¼"W x 28½"D x 52"H, Legal	H214	114	17.1	\$ 870	\$ 915	\$ 959
	H214C	123	20.3	\$ 995	\$1040	\$1084
 Vertical File — 5 Drawer 15"W x 28½"D x 60"H, Letter 18¼"W x 28½"D x 60"H, Legal	H215	136	19.6	\$1163	\$1208	\$1252
	H215C	145	23.3	\$1331	\$1376	\$1420

NOTE: See page 482 for Vertical File Accessories.

How to specify	1st Option	2nd Option
Select Model Number from above H 2 1 2 .	Select Lock Option P Lock P .	Select Paint Color See page 435 T 1



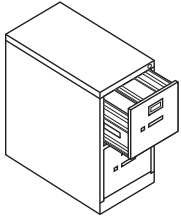

 Icon Legend on page 10



- ▶ 26½" Case depth with 25 front-to-back filing inches per drawer.
- ▶ Letter or legal sizes available.
- ▶ Three-part, telescoping, steel ball-bearing suspension.
- ▶ Bright aluminum drawer pulls, label holders and thumb latch.

- ▶ Standard interchangeable core removable locks. Equipped with HON "One Key" system.
- ▶ Accepts hanging files. High drawer sides hold hanging file folders without use of hangrails.

- ▶ Spring loaded follower block with positive side-action positioning, is adjustable on ½" centers.
- ▶ Baked enamel finish over rust-inhibiting phosphate pre-treatment.

⚠ **Keyed alike cores must be ordered separately — see page 743.**



Description	Model	Ship Weight	Cube	List by Paint Grade		
				Core	Choice/Metallics	Custom
Vertical File — 2 Drawer 15"W x 26½"D x 29"H, Letter 18¼"W x 26½"D x 29"H, Legal	H312	60	8.6	\$ 414	\$ 442	\$ 470
	H312C	66	10.2	\$ 507	\$ 535	\$ 563
Vertical File — 4 Drawer 15"W x 26½"D x 52"H, Letter 18¼"W x 26½"D x 52"H, Legal	H314	107	15.0	\$ 564	\$ 609	\$ 653
	H314C	116	18.0	\$ 664	\$ 709	\$ 753
Vertical File — 5 Drawer 15"W x 26½"D x 60"H, Letter 18¼"W x 26½"D x 60"H, Legal	H315	128	17.3	\$ 829	\$ 874	\$ 918
	H315C	137	21.0	\$ 950	\$ 995	\$1039

NOTE: See page 482 for Vertical File Accessories.

How to specify	1st Option	2nd Option
Select Model Number from above H 3 1 2 .	Select Lock Option P Lock P .	Select Paint Color See page 435 T 1

GSA SIN 711-3

H320 Series Vertical Files

- ▶ High capacity file, 26½" Case depth with 25 front-to-back filing inches per drawer.

- ▶ Letter or legal sizes available.
- ▶ Full cradle drawer suspension.
- ▶ Bright aluminum drawer pulls, label holders and thumb latch.

- ▶ Standard interchangeable core removable locks. Equipped with HON "One Key" system.

- ▶ Accepts hanging files. High drawer sides hold hanging file folders without use of hangrails.
- ▶ Adjustable wire follower.

▶ Baked enamel finish over rust-inhibiting phosphate pre-treatment.
 ⚠ **Keyed alike cores must be ordered separately — see page 743.**



Description	Model	Ship Weight	Cube	List by Paint Grade		
				Core	Choice/Metallics	Custom
Vertical File — 2 Drawer 15"W x 26½"D x 29"H, Letter 18¼"W x 26½"D x 29"H, Legal	HH322	60	8.6	\$ 379	\$ 407	\$ 435
	HH322C	66	10.2	\$ 465	\$ 493	\$ 521
Vertical File — 4 Drawer 15"W x 26½"D x 52"H, Letter 18¼"W x 26½"D x 52"H, Legal	HH324	106	15.0	\$ 527	\$ 572	\$ 616
	HH324C	116	18.0	\$ 620	\$ 665	\$ 709

NOTE: See page 482 for Vertical File Accessories.

How to specify	1st Option	2nd Option
Select Model Number from above H 3 2 2 2 .	Select Lock Option P Lock P .	Select Paint Color See page 435 T 1

Icon Legend on page 10

510 Series Vertical Files

GSA SIN 711-3

HON

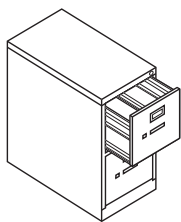

- ▶ 25" Case depth with 23½" front-to-back filing inches per drawer.
 - ▶ Letter and legal sizes are available.
 - ▶ Full cradle drawer suspension.
 - ▶ Bright aluminum drawer pulls, label holders and thumb latch.
 - ▶ Standard interchangeable core removable locks. Equipped with HON "One Key" system.
 - ▶ Accepts hanging files. High drawer sides hold hanging file folders without use of hangrails.
 - ▶ Adjustable wire follower.
 - ▶ Baked enamel finish over rust-inhibiting phosphate pre-treatment.
- ⚠ **Keyed alike cores must be ordered separately — see page 743.**



Description

Model

Ship Weight

Cube

Core

List by Paint Grade

Choice/
Metallics

Custom

Vertical File — 2 Drawer
15"W x 25"D x 29"H, Letter
18¼"W x 25"D x 29"H, Legal

H512
H512C

58
63

8.0
9.7

\$ 361
\$ 444

\$ 389
\$ 472

\$ 417
\$ 500

Vertical File — 4 Drawer
15"W x 25"D x 52"H, Letter
18¼"W x 25"D x 52"H, Legal

H514
H514C

102
112

14.3
17.0

\$ 486
\$ 575

\$ 531
\$ 620

\$ 575
\$ 664



How to specify

Select Model Number
from above

H 5 | 1 | 2 .

1st Option

Select Lock Option

P Lock

P .

2nd Option

Select Paint Color

See page 435







T | 1

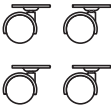

Icon Legend on page 10

► Compatible with Flagship®, Brigade® and Systems Support Pedestals.







	Description	Model	Ship Weight	Cube	List
SIN 711-3	Counterweight — Freestanding Support Pedestals or Systems Support and Mobile Pedestals	HPCW1	18.0	0.1	\$ 177
	Follower Block — 1-Pack. Gray only.	HF80	1.0	0.3	\$ 44
	Double-Rail Hanging File Racks — 2-Pack. Gray only (for side-to-side).	H519495	0.5	0.5	\$ 30
	Adjustable Glides — 4-Pack Field-installable, used to convert mobile pedestals to freestanding support pedestals.	H20040AG	1.0	0.6	\$ 54
	NOTES: Hardware included.				
	Caster Package — Field Installable Four Casters (2 swivel, 2 fixed)	H1050CST	1.0 	0.6	\$ 39
	NOTES: Used to convert Freestanding Support Pedestals to Mobile Pedestals. ⚠ Not designed to be used on pedestals without a counterweight.				
	Lock Core Replacement Kit — Chrome (Specify quantity of each key number from 101E-225E.) Contains one core, two keys, one core removable tool and instructions. Refer to page 743.	HF23C	0.1 	0.1	\$ 36
SIN 711-3	Master Key (one key) — Available to authorized dealers only.	HF22	0.1 	0.1	\$ 21

How to specify

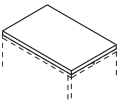
Select Model Number from above

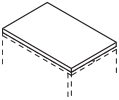
H | F | 2 | 3 | C | .

	Description	Model	Ship Weight	Cube	Price Code	List
	Pedestal Seat 15"W x 18"D x 2"H NOTES: For seating fabrics, see pages 488-505 and 522-523. Works with Contain® and Flagship® Pedestals.	HPSEAT18ND	16.3 	0.9	1	\$ 149
					2	\$ 173
					3	\$ 197
					4	\$ 221
					5	\$ 252
					6	\$ 283
					7	\$ 314
					8	\$ 345
					9	\$ 376
					10	\$ 407
					11	\$ 438
					12	\$ 469
	Pedestal Seat 15"W x 22 7/8"D x 2"H NOTES: For seating fabrics, see pages 488-505 and 522-523. Works with Contain® and Flagship® Pedestals.	HPSEAT24ND	10.0 	1.2	1	\$ 176
					2	\$ 200
					3	\$ 224
					4	\$ 248
					5	\$ 279
					6	\$ 310
					7	\$ 341
					8	\$ 372
					9	\$ 403
					10	\$ 434
					11	\$ 465
					12	\$ 496

How to specify

Select Model Number from above

H | P | S | E | A | T | 2 | 4 | .

1st Option

Select Fabric

See pages 488-505 and 522-523 for seating fabric options

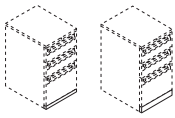

A | B | 1 | 0 |

   Icon Legend on page 10



- ▶ Mounts to base of pedestal to provide a flush appearance to coordinate with laterals, file centers and storage towers.
- ▶ Kick plate is field-installable.

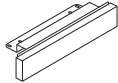

Description	Model	Ship Weight	Cube	List by Paint Grade		
				Core	Choice/ Metallics	Custom
 Flush Front Kick Plate For 28"H Flagship [®] Pedestals	HKP2800	3 	0.2	\$ 100	\$ 108	\$ 113

How to specify

Select Model Number
from above

H | K | P | 2 | 8 | 0 | 0 | .

1st Option

Select Paint Color



See page 435

P

  Icon Legend on page 10



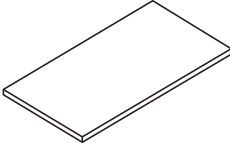
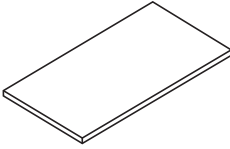
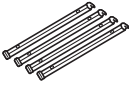
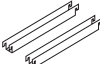





- ▶ Laminate tops are abrasion- and stain-resistant laminate.
- ▶ Hanging file racks and dividers available in Gray only.
- ▶ Compatible with Flagship®, Brigade® 800, 700, 600, and 500 Series Lateral Files.



	Description	Model	Ship Weight	Cube	L1 List	L2 Upcharge
	Square Edge Laminate Top					
	30"W x 19 1/4"D x 1 1/8" Thick	H519489	20.0	2.1	\$ 364	\$ 10
	36"W x 19 1/4"D x 1 1/8" Thick	H519480	25.0	2.5	\$ 399	\$ 10
	42"W x 19 1/4"D x 1 1/8" Thick	H519481	30.0	2.9	\$ 453	\$ 10
	60"W x 19 1/4"D x 1 1/8" Thick	H519490	32.0	3.9	\$ 601	\$ 15
	72"W x 19 1/4"D x 1 1/8" Thick	H519482	40.0	5.0	\$ 658	\$ 15
	84"W x 19 1/4"D x 1 1/8" Thick	H519483	48.0	6.1	\$ 724	\$ 20
NOTES: Compatible with Brigade® 800, 700, 600, and 500 Series Lateral Files.						
	Square Edge Laminate Top					
	30"W x 18"D x 1 1/8" Thick	H919430	20.0	1.6	\$ 349	\$ 10
	36"W x 18"D x 1 1/8" Thick	H919436	25.0	1.8	\$ 437	\$ 10
	42"W x 18"D x 1 1/8" Thick	H919442	30.0	2.1	\$ 479	\$ 10
	60"W x 18"D x 1 1/8" Thick	H919460	32.0	3.0	\$ 606	\$ 15
	66"W x 18"D x 1 1/8" Thick	H919466	40.0	3.2	\$ 693	\$ 15
	72"W x 18"D x 1 1/8" Thick	H919472	48.0	3.5	\$ 710	\$ 15
NOTES: Compatible with Flagship® 18"D Lateral Files only.						
	Single Rail Hanging File Racks (4/pack)	H919491	1.0	0.4	\$ 55	N/A
NOTES: For front-to-back filing — 30"W, 36"W and 42"W files. Order one package per drawer for 42"W files. One package will do two 30"W or 36"W file drawers. Racks span between 15 1/4"W rails. ▲ Gray only.						
	Double-Rail Hanging File Racks (2/pack)	H919492	1.5	0.4	\$ 55	N/A
NOTES: For 3 rows front-to-back — 42"W files. Order one package per drawer. Racks span between 15 1/4"W rails. ▲ Gray only.						
	Dividers (10/pack)	H515704	12.0	0.5	\$ 136	N/A
▲ Gray only.						

How to specify	Select Model Number from above	1st Option
	H 5 1 9 4 8 9 .	Select Laminate See page 434 N

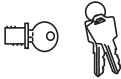
Icon Legend on page 10

	Description	Model	Ship Weight	Cube	List
 SIN 711-3	Follower Block (4/pack)				
	Legal	HF60	8.0 	0.6	\$ 87
	Letter	HF50	7.0 	0.5	\$ 82
  <i>Lock info page 743.</i> SIN 711-3 SIN 711-2 for HF24	Chrome Core Removable Lock Kit (Field installable) Specify key number from 101E-225E. Lock info page 743.	HF24	0.2 	0.2	\$ 50
	Bulk Package — 6 HF24 Lock Kits (Individually shrink wrapped)	HF246	1.2 	0.2	\$ 242
 SIN 711-3	Lock Core Replacement Kit — Chrome (Specify quantity of each key number from 101E-225E.) Contains one core, two keys, one core removable tool and instructions. Refer to page 743.	HF23C	0.1 	0.1	\$ 36

How to specify

Select Model Number from above

H | F | 6 | 0

 Icon Legend on page 10

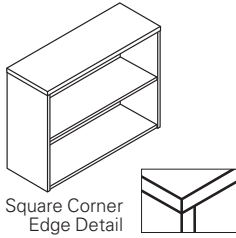

- ▶ 10500 Series™ Casegoods smooth, flat edge detail (see pages 214-246) complements many furniture designs.
- ▶ Fully finished back.
- ▶ Replaces 1980 Series Laminate Bookcases
- ▶ Bottom shelf, top and end panels are 1/8" thick. Interior shelves are 3/4" thick.
- ▶ All surfaces finished in abrasion- and stain-resistant thermal-fused laminate over solid core high-performance particleboard.
- ▶ Adjustable hex leveling glides allow floorstanding bookcases to be easily leveled without lifting the unit; glides have 3/4" adjustable range.

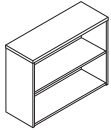

Description	Model	Ship Weight	Cube	L1 List	L2 Upcharge
Laminate Bookcase					
36"W x 13 1/8"D x 29 5/8"H, 2-Shelf	H105532	90	11.0	\$ 438	\$ 15
36"W x 13 1/8"D x 43 3/8"H, 3-Shelf	H105533	122	15.6	\$ 556	\$ 20
36"W x 13 1/8"D x 57 1/8"H, 4-Shelf	H105534	156	20.2	\$ 656	\$ 25
36"W x 13 1/8"D x 71"H, 5-Shelf	H105535	187	25.1	\$ 763	\$ 30

NOTES: Ships fully assembled. Fixed shelves. Inside shelf dimensions on all units are 33 1/16"W x 11 15/16"D x 12 15/16"H.

10500 Series™ Laminate Bookcases

- ▶ Available Laminate Colors:
 - Woodgrain:* Bourbon Cherry (HH), Cognac (COGNCOGN), Harvest (CC), Lowell Ash (LLA1), Mahogany (NN), Mocha (MOCHMOCH), Natural Maple (DD), Natural Recon (LNR1), Phantom Ecru (LPE1), Pinnacle (PINCPINC), Portico Teak (LPT1), Shaker Cherry (FF) and Skyline Walnut (LSW1).
 - Solid:* Black (PP), Brilliant White (WHITWHIT), Charcoal (SS) and Loft (LOFTLOFT).
 - Patterned Top*:* Canyon Zephyr (K9), Desert Zephyr (K8), Grey Tigris (L6), Sheer Mesh (A5) and Silver Mesh (B9).
- *Patterned Laminates are available with the following chassis/edgebanding laminate selection: Black (P), Bourbon Cherry (H), Brilliant White (WHIT), Charcoal (S), Harvest (CC), Loft (LOFT), Mahogany (N), Natural Maple (D) and Shaker Cherry (F). Edgebanding around top will match chassis laminate color selected.
- Two-Tone (top/chassis):* Top and edge banding are the same, chassis is different laminate color: Black/Brilliant White (PWHIT), Black/Charcoal (PS), Black/Loft (PLOFT), Bourbon Cherry/Black (HP), Bourbon Cherry/Brilliant White (HWHIT), Bourbon Cherry/Charcoal (HS), Bourbon Cherry/Loft (HLOFT), Brilliant White/Black (WHITP), Brilliant White/Bourbon Cherry (WHITH), Brilliant White/Charcoal (WHITS), Brilliant White/Harvest (WHITC), Brilliant White/Loft (WHITLOFT), Brilliant White/Lowell Ash (WHITLLA10), Brilliant White/Mahogany (WHITN), Brilliant White/Natural Maple (WHITD), Brilliant White/Natural Recon (WHITLNR1), Brilliant White/Phantom Ecru (WHITLPE1), Brilliant White/Portico Teak (WHITLPT1), Brilliant White/Shaker Cherry (WHITF), Brilliant White/Skyline Walnut (WHITLSW1), Charcoal/Black (SP), Charcoal/Brilliant White (SWHIT), Cognac/Black (COGNP), Cognac/Brilliant White (COGNWHIT), Cognac/Charcoal (COGNS), Cognac/Loft (COGNLOFT), Harvest/Black (CP), Harvest/Brilliant White (CWHIT), Harvest/Charcoal (CS), Harvest/Loft (CLOFT), Loft/Black (LOFTP), Loft/Brilliant White (LOFTWHIT), Loft/Charcoal (LOFTS), Lowell Ash/Black (LLA1P), Lowell Ash/Brilliant White (LLA1WHIT), Lowell Ash/Charcoal (LLA1S), Lowell Ash/Loft (LLA1LOFT), Mahogany/Black (NP), Mahogany/Brilliant White (NWHIT), Mahogany/Charcoal (NS), Mahogany/Loft (NLOFT), Mocha/Black (MOCHP), Mocha/Brilliant White (MOCHWHIT), Mocha/Charcoal (MOCHS), Mocha/Loft (MOCHLOFT), Natural Maple/Black (DP), Natural Maple/Brilliant White (DWHIT), Natural Maple/Charcoal (DS), Natural Maple/Loft (DLOFT), Natural Recon/Black (LNR1P), Natural Recon/Brilliant White (LNR1WHIT), Natural Recon/Charcoal (LNR1S), Natural Recon/Loft (LNR1LOFT), Phantom Ecru/Black (LPE1P), Phantom Ecru/Brilliant White (LPE1WHIT), Phantom Ecru/Charcoal (LPE1S), Phantom Ecru/Loft (LPE1LOFT), Pinnacle/Black (PINCP), Pinnacle/Brilliant White (PINCPWHIT), Pinnacle/Charcoal (PINCS), Pinnacle/Loft (PINCLLOFT), Portico Teak/Black (LPT1P), Portico Teak/Brilliant White (LPT1WHIT), Portico Teak/Charcoal (LPT1S), Portico Teak/Loft (LPT1LOFT), Shaker Cherry/Black (FP), Shaker Cherry/Brilliant White (FHWIT), Shaker Cherry/Charcoal (FS), Shaker Cherry/Loft (FLOFT), Skyline Walnut/Black (LSW1P), Skyline Walnut/Brilliant White (LSW1WHIT), Skyline Walnut/Charcoal (LSW1S), Skyline Walnut/Loft (LSW1LOFT).

Patterned Top

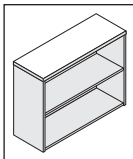

Edge Band Around Top/Laminate Base

Two-Tone Laminate Top/Edge Banding

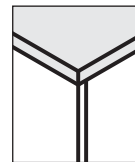
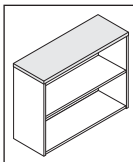

Laminate Base

How to specify	Select Model Number from above	1st Option Select Laminate
	H 1 0 5 1 3 2 .	N N See page 434

1870 Series Laminate Bookcases

GSA SIN 711-8

HON

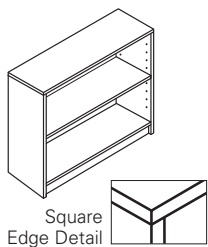

- ▶ Square edge profile complements many different furniture designs.
- ▶ Abrasion- and stain-resistant laminate, over durable solid core, high-performance particleboard.
- ▶ 3/4" thick shelves adjust in 1/4" increments to suit a variety of storage needs (two shelves are fixed in 5- and 6-shelf units).
- ▶ Cam-lock fasteners and wood dowels ensure pieces go together easily and precisely.
- ▶ Equipped with four adjustable leveling glides.
- ▶ Shelves will deflect under large amounts of weight.
- ▶ 1/8" hardboard back panel.
- ▶ All bookcases are 36"W x 11 1/2"D.
- ▶ Optional doors available to conceal lower shelf contents.
- ▶ Choose from Harvest or Mahogany.
- ▶ Easy-to-assemble instructions included.

△ **Designed to be used with small office-home office applications.**



Description	Model	Ship Weight	Cube	List
Laminate Bookcase				
36"W x 11 1/2"D x 29 7/8"H, 2-Shelf (1 adjustable)	H1871 E◆A	48	1.5	\$ 222
36"W x 11 1/2"D x 36 1/8"H, 3-Shelf (2 adjustable)	H1872 E◆A	60	1.7	\$ 245
36"W x 11 1/2"D x 48 3/4"H, 4-Shelf (3 adjustable)	H1874 E◆A	77	2.6	\$ 298
36"W x 11 1/2"D x 60 1/8"H, 5-Shelf (3 adjustable)	H1875 E◆A	92	2.8	\$ 351
36"W x 11 1/2"D x 72 5/8"H, 6-Shelf (4 adjustable)	H1876 E◆A	109	3.4	\$ 403
36"W x 11 1/2"D x 84"H, 6-Shelf (4 adjustable)	H1877 E◆A	124	4.5	\$ 458
Set of doors with hinges used to conceal lower shelf contents 36"W x 25 3/4"H	H1801 E◆A	23	1.0	\$ 183

How to specify

Select Model Number from above

H | 1 | 8 | 7 | 1 | .

1st Option

Select Laminate

COGN Cognac
C Harvest
N Mahogany

N

1890 Series Laminate Bookcases

GSA SIN 711-8

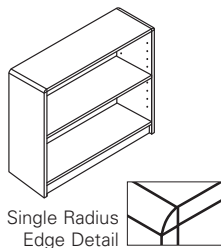

- ▶ Tops feature radius trim made of attractive hardwood – complements many furniture designs.
- ▶ Abrasion- and stain-resistant laminate, over durable solid core, high-performance particleboard.
- ▶ 3/4" thick shelves adjust in 1/4" increments to suit a variety of storage needs (two shelves are fixed in 5- and 6-shelf units).
- ▶ Cam-lock fasteners and wood dowels ensure pieces go together easily and precisely.
- ▶ Equipped with four adjustable leveling glides.
- ▶ Shelves will deflect under large amounts of weight.
- ▶ 1/8" hardboard back panel.
- ▶ All bookcases are 36"W x 11 1/2"D.
- ▶ Extra shelves available as an option.
- ▶ Optional doors available to conceal lower shelf contents.
- ▶ Choose from Harvest or Mahogany.
- ▶ Easy-to-assemble instructions included.

△ **Designed to be used with small office-home office applications.**



Description	Model	Ship Weight	Cube	List
Laminate Bookcase				
36"W x 11 1/2"D x 29 7/8"H, 2-Shelf (1 adjustable)	H1891 E◆A	48	1.5	\$ 252
36"W x 11 1/2"D x 36 1/8"H, 3-Shelf (2 adjustable)	H1892 E◆A	60	1.7	\$ 275
36"W x 11 1/2"D x 48 3/4"H, 4-Shelf (3 adjustable)	H1894 E◆A	77	2.6	\$ 328
36"W x 11 1/2"D x 60 1/8"H, 5-Shelf (3 adjustable)	H1895 E◆A	92	2.8	\$ 381
36"W x 11 1/2"D x 72 5/8"H, 6-Shelf (4 adjustable)	H1896 E◆A	109	3.4	\$ 433
36"W x 11 1/2"D x 84"H, 6-Shelf (4 adjustable)	H1897 E◆A	124	4.5	\$ 488
Set of doors with hinges used to conceal lower shelf contents 36"W x 25 3/4"H	H1801 E◆A	23	1.0	\$ 183

How to specify

Select Model Number from above

H | 1 | 8 | 9 | 1 | .

1st Option

Select Laminate

COGN Cognac
C Harvest
N Mahogany

N

Icon Legend on page 10

► 28"H fits under all *basyx* by HON® worksurfaces and desks.

► Pencil tray standard in top box drawer.

► Ball bearing suspension with 90% extension.

► Steel frame construction for everyday use.

► *basyx* by HON® 5-year Limited Warranty.

Not on GSA Contract

basyx by HON® Mobile Pedestals

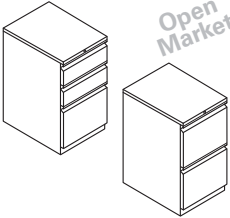

Description	Model	Ship		
		Weight	Cube	List
 <p>Mobile Pedestal 15"W x 20"D x 28"H, Box/Box/File 15"W x 20"D x 28"H, File/File</p>	HBMP2B	60	6.9	\$ 370
	HBMP2F	60	6.9	\$ 370

How to specify	Select Model Number from above H B M P 2 B .	1st Option Select Paint Color P Black Q Light Gray L Putty P
----------------	---	---

Not on GSA Contract

basyx by HON® Storage Cabinets

► *basyx* by HON® 5-year Limited Warranty.

► Shelves adjust in 1³/₁₆" increments.
► Easy to assemble.

► Standard radius handle on right side of door.
► Magnetic door clip keeps doors shut when in unlocked position.

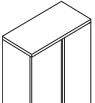
Description	Model	Ship		
		Weight	Cube	List
 <p>ETA Storage Cabinets 36"W x 18"D x 72"H, 5-shelf, locking 36"W x 18"D x 42"H, 3-shelf, locking</p> <p>NOTES: 5-shelf unit has four adjustable shelves.</p>	HC187236 EΦA	101	5.5	\$ 602
	HC184236 EΦA	67	3.7	\$ 491

How to specify	Select Model Number from above H C 1 8 7 2 3 6 .	1st Option Select Paint Color Q Light Gray L Putty Q
----------------	---	---

Not on GSA Contract

basyx by HON® 400 Series Lateral Files

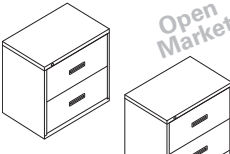

► Reinforced case construction.
► Two adjustable leveling glides in front corners.
► Baked enamel finish.
► Monochromatic drawer pulls.

Description	Model	Ship		
		Weight	Cube	List
 <p>Steel Lateral Files 30"W x 19¹/₄"D x 28³/₈"H — 2 Drawer 30"W x 19¹/₄"D x 53¹/₄"H — 4 Drawer 36"W x 19¹/₄"D x 28³/₈"H — 2 Drawer 36"W x 19¹/₄"D x 53¹/₄"H — 4 Drawer</p> <p>NOTES: Drawers lock. Features ball-bearing slide suspensions.</p>	H432	109	12.4	\$ 566
	H434	169	22.1	\$ 833
	H482	124	12.4	\$ 591
	H484	185	22.1	\$ 952

How to specify	Select Model Number from above H 4 3 2 .	1st Option Select Lock Option L Lock L .	2nd Option Select Paint Color P Black Q Light Gray L Putty P
----------------	---	---	---

Icon Legend on page 10

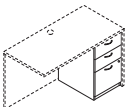
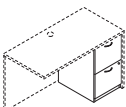
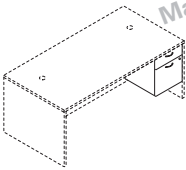
- ▶ Lateral file and pedestals ship assembled.
- ▶ Pedestals are designed to be used under the desk, credenza, and return shells.
- ▶ Drawers operate on full extension, ball-bearing suspensions to ensure smooth, quiet, long-lasting operation.
- ▶ Hangrails are included in each file drawer for side-to-side letter or legal filing, and for front-to-back letter filing.
- ▶ Lateral file and pedestals come standard with **NEW Silver Arch pulls**.
- ▶ Personal wardrobe cabinet features coat rod, fixed shelf, and lock.
- ▶ Bookcase shelves are 1" thick.
- ▶ Bookcase shelves are adjustable in 1/4" increments.
- ▶ Bookcase features finished outer back panel.
- ▶ **basyx by HON® 5-year Limited Warranty.**

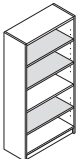





	Description	Model	Ship Weight	Cube	List
	<p>Lateral Files — 2-Drawer 35½"W x 22"D x 29"H</p> <p>NOTES: Features inner lock mechanism. Drawers lock. Removable top for use under shells. Features full extension drawers with ball-bearing suspensions.</p>	HBL2171	176	19.3	\$ 508
	<p>Pedestals, Box/Box/File 15⅝"W x 21¾"D x 27¾"H</p> <p>NOTES: Drawers lock. Not to be used freestanding. For use under shells (sold separately). Unfinished top.</p>	HBL2162	77	8.7	\$ 329
	<p>Pedestal, File/File 15⅝"W x 21¾"D x 27¾"H</p> <p>NOTES: Drawers lock. Not to be used freestanding. For use under shells (sold separately). Unfinished top.</p>	HBL2163	77	8.7	\$ 329
	<p>Pedestal, Box/File 15⅝"W x 21¾"D x 19¼"H</p>	HBL2164	57	5.5	\$ 254
	<p>Personal Wardrobe Cabinet 18"W x 24"D x 65"H</p> <p>NOTES: Door is non-handed and can be converted to left or right open configuration.</p>	HBLPWC E♦A	84	6.1	\$ 499
	<p>Bookcases — 5-Shelf 32"W x 13⅓"D x 65⅝"H</p> <p>NOTES: Features three adjustable shelves and one fixed shelf.</p>	HBL2194 E♦A	167	11.1	\$ 284

How to specify	<p>Select Model Number from above</p> <p>H B L 2 1 7 1 .</p>	<p>1st Option</p> <p>Select Laminate</p> <p>NN Mahogany A1A1 Medium Cherry ESES Espresso</p> <p>N N</p>
----------------	--	---

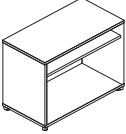
E♦A Icon Legend on page 10

► **basyx by HON® 5-year Limited Warranty.**

- Durable, thermal-fused laminate is scratch- and spill-resistant.
- Ship fully assembled.

	Description	Model	Ship		List
			Weight	Cube	
 	<p>File Center 36"W x 16"D x 22"H, 2-drawer 30"W x 16"D x 22"H, 2-drawer 30"W x 16"D x 22"H, Open</p>	HMNG36FCD	92 	11.0	\$ 566
		HMNG30FCD	80 	10.0	\$ 509
		HMNG30FCO	50 	3.0	\$ 319
	<p>Pedestals 15¾"W x 21"D x 22"H, Pencil/Pencil/File NOTES: Pedestal includes two pencil drawers and a file drawer.</p>	HMNG15PED	69 	7.0	\$ 364

Open Market

Open Market

How to specify	<p>Select Model Number from above</p> <p>H M N G 3 6 F C D .</p>	<p>1st Option</p> <p>Select Laminate</p> <p>C1 Chestnut WH Wheat C 1 .</p>	<p>2nd Option</p> <p>Select Paint Color</p> <p>A1 Ash A 1 </p>
----------------	--	---	--

 Icon Legend on page 10

HON

2017 Seating Pricer



MADE IN THE
USA 
SEE PAGE 3

EFFECTIVE March 1, 2017 Supersedes HON List Pricer dated January 1, 2017

TABLE OF CONTENTS

By Series Name

BY SERIES NAME

Accommodate™	40-46
Adjustable Task/Lab Stools	47
Boda™	48-49
Cambia™ 2160 Series	50-52
Ceres®	53-58
ComforTask® 5900 Series	59-63
ComfortSelect™ Collection	64-67
Convera™ Lounge	68-70
Endorse™ Collection	71-82
Flock®	83-112
Folding Chairs	113
Gamut® 2070 Series	114-116
Grove™	117-129
GuestStacker® 4030 Series	130-131
Ignition®	132-150
Invitation® 2110 Series	151-154
Invitation® Lounge	155-157
Laurus™ Wood Guest	158-160
Lota®	161-166
Motivate® Chairs	167-186
Nucleus®	187-192
High-Density Olson Stacker® 4040 Series	193-194
Pagoda®	195-202
Park Avenue Collection® 5000 Series	203-206
Park Avenue Collection® 5020 Series	207-209
Perpetual® Nesting Chairs	210-212
Pillow-Soft® 2090 Series	213-215
Pillow-Soft® 2190 Series	216-218
Purpose®	219-224
Quotient™	225-228
Riley™	229-236
Solutions Seating® 4000 Series	237-239
Solve™	240-248
Soothe™	249-261
Versant® Tandem	262-268
Volt®	269-276
2400 Series	277-279
6540 Series	280-282
6550 Series	283-285
7700 Series	286-289
7800 Series	290-294
basyx by HON®	295-320

BY APPLICATION

EXECUTIVE AND CONFERENCE

Ceres®	57
Endorse™	75, 78
Gamut®	116
Ignition®	137, 140
Nucleus®	191
Park Avenue Collection®	205, 209
Pillow-Soft®	215, 218
Solutions Seating®	239
6540 Series	282
basyx by HON®	300-308

TASK CHAIRS

Boda™	49
Ceres®	57
ComforTask®	62
ComfortSelect™	65-67
Endorse™	76-78
Gamut®	116
Ignition®	138-139, 144-145
Lota®	164-165
Motivate®	170
Nucleus®	191
Park Avenue Collection®	205, 209
Pillow-Soft®	215, 218
Purpose®	222
Quotient™	228
Solutions Seating®	239
Solve™	244-247
Volt®	271-272, 275-276
7700 Series	288
7800 Series	293-294
basyx by HON®	296-301, 309-310

GUEST CHAIRS

Accommodate™	43, 45
Cambia™	52
Ceres®	58
Flock®	95-96
Gamut®	116
Ignition®	148, 150
Invitation®	153
Laurus™	160
Lota®	166
Nucleus®	192
Pagoda®	198-201
Park Avenue Collection®	205, 209
Pillow-Soft®	215, 218
Riley™	232-235
Solutions Seating®	239
Soothe™	253-255, 261
Versant® Tandem	268
2400 Series	279
6540 Series	282
6550 Series	285
basyx by HON®	313-315

TABLE OF CONTENTS

By Series Name

BY APPLICATION

STACKING AND NESTING CHAIRS

Ceres®	58
Folding Chairs	113
GuestStacker®	131
Ignition®	150
Lota®	166
Motivate®	172, 176, 180
Nucleus®	192
High-Density Olson Stacker®	194
Pagoda®	198-201
Perpetual®	212
basyx by HON®	311-313

COLLABORATIVE AND PUBLIC SPACES

Accommodate™	43-46
Convera™	70
Endorse™	81
Flock®	86-91, 95-96, 99-101
Grove™	121-123, 125-128
Ignition®	148-149
Invitation®	157
Soothe™	253-256
Versant® Tandem	266, 268
basyx by HON®	312-313, 315-316, 318, 320

STOOLS AND MULTI-PURPOSE

Accommodate™	43-46
Adjustable Task/Lab	47
ComforTask®	63
Endorse™	79
Flock®	94-96
Ignition®	140, 149-150
Lota®	166
Motivate®	170, 176-177, 180, 183, 186
Nucleus®	192
Pagoda®	202
Perpetual®	212
Purpose®	223
Quotient™	228
Solve™	244-246
Volt®	271-272, 275-276
7700 Series	288
basyx by HON®	296, 309, 311-312

BIG AND TALL

Endorse™	78
Ignition®	140
basyx by HON®	302

BARIATRIC

Accommodate™	44, 46
Ignition®	149
Riley™	233, 235
Soothe™	253, 255
Versant® Tandem	268

COORDINATING TABLES

Endorse™	82
Flock®	105-110
Invitation®	154
Centerpiece™	206
Riley™	236
Soothe™	257
Versant® Tandem	267
basyx by HON®	317, 319

MADE IN THE USA



PROUDLY MADE IN THE USA

When you buy HON office furniture, you're not just buying inspired, practical solutions — you're buying quality, American-built furniture, backed by a lifetime warranty and a network of dealers.

LOOK FOR THIS ICON ON MODEL PAGES: 



DESIGNED, ENGINEERED
& ASSEMBLED IN THE USA

**PROUDLY DESIGNED, ENGINEERED
& ASSEMBLED IN THE USA**

When you buy HON office furniture, you're not just buying inspired, practical solutions — you're buying quality, American designed, engineered and assembled furniture backed by a lifetime warranty and a network of dealers.

LOOK FOR THIS ICON ON MODEL PAGES: 

WARRANTY INFO

HON®

FULL LIFETIME WARRANTY

YOUR HON FULL LIFETIME WARRANTY

Every time you purchase a HON product, you're making an investment in your future. We're proud to play a part in that future, and you can trust us to do our best for as long as you need us.

The HON Full Lifetime Warranty is our assurance to you that the HON desks, workstations, seating, tables, or storage you purchase will be free from defective material or workmanship for the life of the product.

In the unlikely event that any HON product or component covered by the HON Full Lifetime Warranty should fail under normal workplace use as a result of defective material or workmanship, HON promises to repair it. If we are unable to repair it, we will replace it with comparable product, or, if preferred, we will refund the purchase price.

WHAT'S COVERED BY THE HON FULL LIFETIME WARRANTY?

Your HON Full Lifetime Warranty applies to product manufactured after January 1, 2011. All HON product lines, materials, and components are covered by the HON Full Lifetime Warranty except for the items described below.

The specific product lines, materials, and components listed below are covered under HON's Full 12-Year, Full 10-Year, and Full 5-Year Warranties (from date of purchase).

HON'S FULL 12-YEAR WARRANTY

- Electrical components (LED task lights, lamps and ballasts are not covered)
- Seating *ilira*®-stretch
- Seating controls
- Pneumatic Cylinders
- Wood Seating
- Accessories
- Laminate Surfaces
- Veneer Surfaces

HON'S FULL 10-YEAR WARRANTY

- Soothe™ Patient Recliner Mechanism

HON'S FULL 5-YEAR WARRANTY

- All LED task lights
- Panel and seating textiles
- Electric Height-Adjustable Bases (Including Memory Control)
- Directional™ Desktop Sit-to-Stand
- Soothe™ Patient Recliner Central Lock Mechanism
- Soothe™ Patient Recliner Pivoting Arm

These warranties apply to HON products sold within the United States of America, U.S. Territories, and Canada, as well as U.S. Military and Federal Agency purchases (regardless of location).

IS ANYTHING NOT COVERED?

There are a few exclusions to the HON Full Lifetime Warranty and to the 12-, 10-, and 5-year warranties. These exclusions are:

- All *basyx* by HON® products (these products are covered under a separate *basyx* by HON® warranty).
- Color-fastness or matching of colors, woodgrains, or textures occurring in wood, leather, or other materials that naturally exhibit inherent color variations.
- Customer's own materials (COM) selected by and used at the request of the user.
- Modifications or attachments to the product that are not approved by The HON Company and product failures resulting from such modifications or attachments.
- Product normal wear and tear, which are to be expected over the course of ownership.
- Products that were not installed, used, or maintained in accordance with product instructions and warnings.
- Products used for rental purposes.
- Damage caused by cleaning chemicals.
- Dye transfer caused by external contaminants (including clothing and accessory dyes such as those used on denim jeans) may migrate to lighter colors. This phenomenon is increased by humidity and temperature and is irreversible.

WARRANTY REQUESTS OR QUESTIONS?

Your HON Dealer is our mutual partner in supporting your warranty requests. To obtain service under this warranty, please contact your HON dealer. If you are not sure who your dealer is, please call HON Customer Support at 800.833.3964.

THAT'S YOUR HON FULL LIFETIME WARRANTY AS AN OWNER OF HON PRODUCT, THE WARRANTY EXPLAINED HERE IS YOUR SOLE AND EXCLUSIVE REMEDY. THERE ARE SOME EXCEPTIONS IF YOU PURCHASED THE PRODUCT FOR HOME OR PERSONAL USE WHICH ARE EXPLAINED BELOW. TO THE EXTENT ALLOWED BY LAW, THE HON COMPANY MAKES NO OTHER WARRANTY, EITHER EXPRESS OR IMPLIED, INCLUDING ANY WARRANTY OF MERCHANTABILITY OR FITNESS FOR A PARTICULAR PURPOSE. THE HON COMPANY WILL NOT BE LIABLE FOR ANY CONSEQUENTIAL OR INCIDENTAL DAMAGES.

A WORD ABOUT PURCHASES FOR HOME OR PERSONAL USE

Please note, this section only applies if you purchased your HON product for your home or for your own personal or family use. HON's warranties give you specific legal rights and you may have other rights, which vary from state to state. As a consumer purchaser, the complete exclusion of implied warranties noted in the above paragraph does not apply to you, however, to the extent allowed by applicable state law, the implied warranties are limited to the applicable term of the warranty. Some states do not allow the exclusion or limitation of incidental or consequential damages, so the above exclusion or limitation may not apply to you.



LIMITED 5-YEAR WARRANTY

The HON Company promises to repair or replace any *basyx* by HON® product or component that is found to be defective in material or workmanship within five (5) years from the date of original purchase so long as you, the original purchaser, still own it. This is your sole and exclusive remedy. This warranty is subject to the provisions below. It applies to product manufactured after January 1, 2013.

LIMITATIONS:

- Fabric on chairs is warranted for two years from date of purchase.
- Damage caused by the carrier in-transit is handled under separate terms.

EXCLUSIONS:

This warranty does not apply and no other warranty applies to:

- Normal wear and tear, which are to be expected over the course of ownership.
- Modifications or attachments to the product that are not approved by The HON Company.
- Products that were not installed, used or maintained in accordance with product instructions and warnings.
- Products used for rental purposes.

SEATING USAGE

Normal commercial use for seating is identified as the equivalent of a single shift, forty-(40) hour workweek. To the extent that a seating product is used in a manner exceeding this, the applicable warranty period will be reduced in a pro-rata manner.

A WORD ABOUT COLOR VARIATIONS, FABRICS AND FINISHES:

The HON Company does not warrant the color-fastness or matching of colors, grains or textures of covering materials.

CUSTOMER'S OWN MATERIAL (COM)

Not available on *basyx* by HON® product.

TO THE EXTENT ALLOWED BY LAW, THE HON COMPANY MAKES NO OTHER WARRANTY, EITHER EXPRESS OR IMPLIED, INCLUDING ANY WARRANTY OF MERCHANTABILITY OR FITNESS FOR A PARTICULAR PURPOSE. THE HON COMPANY WILL NOT BE LIABLE FOR ANY CONSEQUENTIAL OR INCIDENTAL DAMAGES.

NOTICE TO PURCHASERS FOR HOME OR PERSONAL USE:

Federal law does not permit the exclusion of certain implied warranties for consumer products. Therefore, if you are purchasing this product for home or personal use, the exclusion of implied warranties noted in the above paragraph does not apply to you. Some states do not allow the exclusion or limitation of incidental or consequential damages, so the above limitation or exclusion may not apply to you. This warranty gives you specific legal rights, and you may also have other rights which vary from state to state.

This warranty applies only to products sold within the United States of America and the Commonwealth of Canada.

TO OBTAIN SERVICE UNDER THIS WARRANTY:

Your *basyx* by HON® Dealer is our mutual partner in supporting your warranty requests. By following the procedures outlined below, you can be assured of the best level of service. Please note: Consent of The HON Company must be obtained before any warranty work is performed. To obtain consent, please take the following steps:

1. Contact the Dealer from whom the product was purchased within 30 days of discovery of the defect. Be prepared to affirm that you are the original purchaser of the product and to provide the serial number(s) from the product in question.
2. Your Dealer will gather all pertinent information regarding the claim, inspect the product and contact a HON Company customer service representative. (Please allow a reasonable amount of time for inspection and review.)
3. If The HON Company affirms that the product in question is eligible under the conditions of the warranty as stated above, the customer service representative or another representative of the Company will determine whether to provide replacement parts, authorize repairs or replace the product.

ENVIRONMENTAL STATEMENT

CLEARING THE AIR.

In 2006, The HON Company became the world's first office furniture manufacturer to have products certified by the Indoor Advantage™ Program. Virtually all manufactured products emit chemical compounds into the air. Indoor Advantage evaluates these compounds to help improve the air quality within enclosed indoor environments.

Developed by Scientific Certification Systems (SCS), Indoor Advantage subjects products to specific indoor air quality standards. Further, Indoor Advantage tests individual components as well as overall assemblies, and provides detailed analysis of a comprehensive range of all chemicals rather than simple pass/fail for only the most common. This enables us to help our suppliers reduce the environmental impact of their products and processes, too.

SCS offers two levels of certification:



Indoor Advantage™ certifies conformance with LEED-CI criteria for EQ4-5, as well as BIFMA X7.1 Low-Emitting Furniture and Seating.



the sustainability certification program for furniture

On the level™

level, the BIFMA e3 sustainability standard, was developed in response to the increasing demand for proof that manufacturers are living up to their environmental claims. level Certification is based on four sustainability attributes: Materials, Energy and Atmosphere, Human and Ecosystem Health, and Social Responsibility.

The HON Company has received level™ 2 certification for 60 product lines. That means more than 80 percent of our product volume has earned this important certification.

The level certification is a multi-attribute certification label for products that have met environmental, social and quality standards.

Laminate Caseworks and Systems are certified as a typical workstation. Individual models contribute to the overall workstation certification.

Products that meet these specifications are identified throughout this publication with the following icons:



Certified **SCS Indoor Advantage™**



Complies to the **BIFMA e3 Sustainability Standard.**

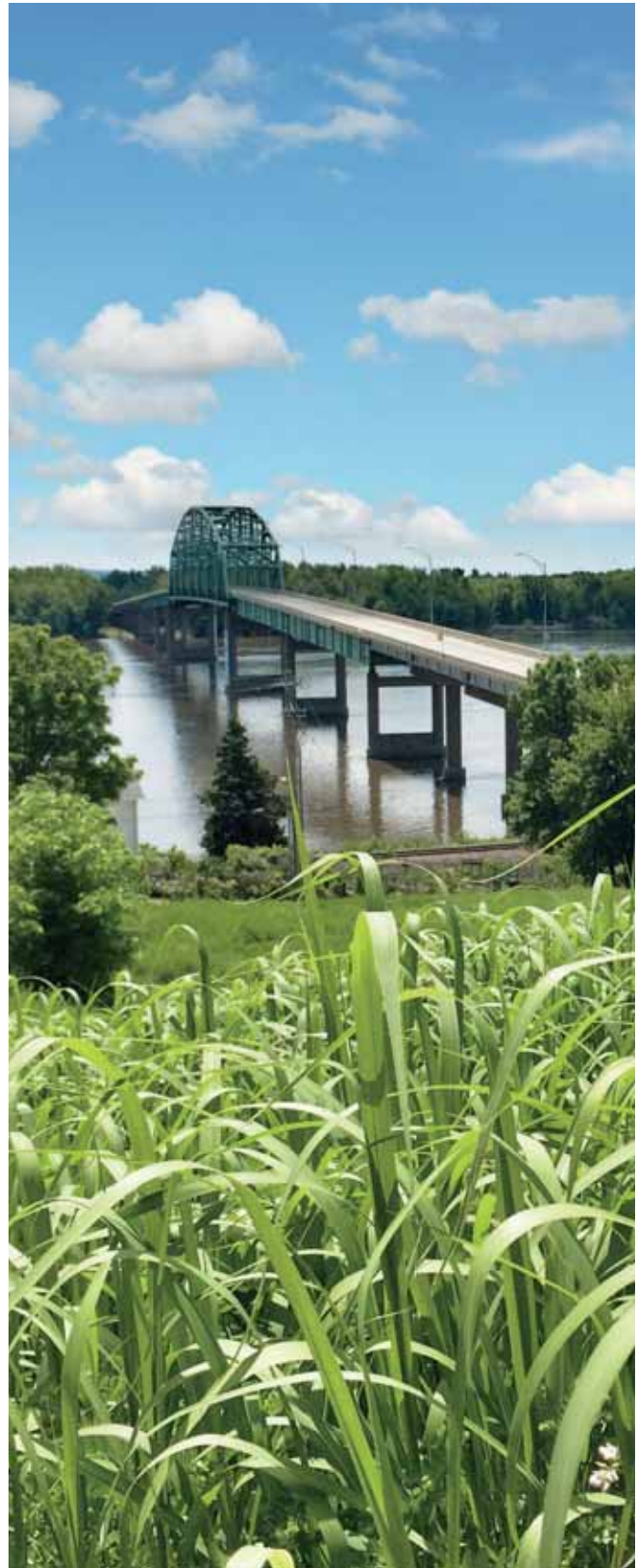

LEGEND

THE FOLLOWING ICONS ARE USED THROUGHOUT THIS PUBLICATION

-  Meets or exceeds ANSI/BIFMA and ISTA performance standards
-  Caution
-  Easy to assemble
-  Shippable by small-package carrier
-  Wheel-chair compatible
-  Soft-tread caster option available
-  Readily Available. For additional lead time information see page 19.
-  Available within a “standard” or “extended” lead time. For additional lead time information see page 19.
-  May have extended lead times. For additional lead time information see page 19.
-  Product shipped two to a carton
-  Product shipped four to a carton
-  Fire Code
-  Core Product Line
-  ColorCorrect® Eligible Product
-  Product scheduled for discontinuation
-  **DE-EMPHASIZED:** Product or fabric/surface material is de-emphasized, effective date as noted. Not carded. View online at honready.hon.com
-  Product is not included on GSA contracts
-  Proudly Made in the USA. See page 3 for more details.
-  Proudly Designed, Engineered & Assembled in the USA. See page 3 for more details.

SEATING FUNCTIONS

Work/task chairs need to be adjusted to deliver optimum support. Cross-reference the letter key below to identify the chairs in this section that best meet your needs.

PROPORTIONAL ADJUSTMENTS

These controls adapt the dimensions of the chair to fit the user.

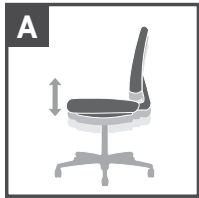

A. Pneumatic seat height adjustment — Regulates height of chair relative to floor.

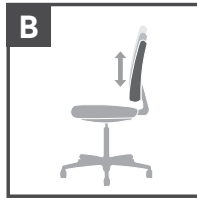

B. Back height adjustment — Positions lumbar support within a fixed range.

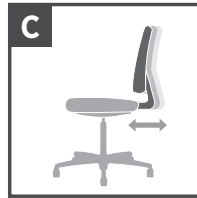

C. Seat depth adjustment — Positions chair back relative to seat.

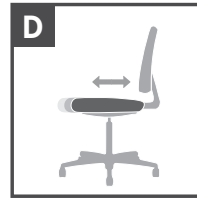

D. Seat glide mechanism — Seat cushion travels forward and back, then locks into position.

ARM OPTIONS

These adjustments accommodate different sized users and support keyboarding.



Q. Adjustable height arms — Provide improved upper-torso support. Can be adjusted periodically to relieve strain and provide variety.



R. Adjustable width arms (patented) — Quick-adjust design places arms close to body for keyboarding, or out to sides for ease of entry.

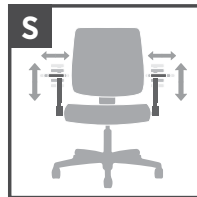

S. Height and width adjustable arms — Controls both height and width of arms for optimum comfort.



T. Loop arms — Largely specified for aesthetics. Frequently used in management settings.

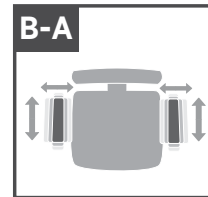

B-A. All-adjustable arms — Arms adjust in height, width, and depth.

SEATING FUNCTIONS

POSTURE CONTROLS

The controls modify the position and angle of the seat and back to respond to changing tasks.



E. 360° Swivel

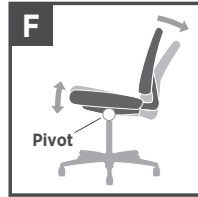

F. Tilt — Pivot point located directly above center of chair base.

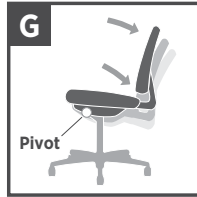

G. Mid-range knee tilt — Pivot point located slightly ahead of center of chair base. Allows user to recline at a slightly more relaxed angle than conventional tilt.

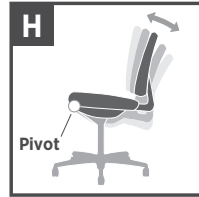

H. Knee tilt — Pivot point located near front edge of chair. Allows user to keep feet flat on floor while chair reclines.

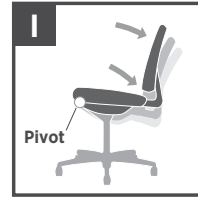

I. Synchronized knee tilt — Back reclines at a 2-to-1 ratio to seat angle. Pivot point located near front edge of chair.

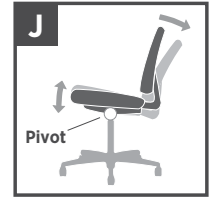

J. Synchro-tilt — Back reclines at a 2-to-1 ratio to seat angle. Allows user to recline while keeping seat cushion relatively level to floor.



K. Tilt tension — Controls rate and ease of recline.



L. Tilt lock — Locks out tilt function when chair is in upright position.



M. Posture mechanism/lock — Back angle adjusts independently of seat, and can be locked in an infinite number of positions within a fixed range.



N. Multi-task control — Adjusts seat and back angles independently with a single lever (infinite locking within a fixed range).



O. Asynchronous control — High performance system with three levers to modify: angle of back relative to seat, tilt (free float or infinite locking) and forward tilt.



W. Integral lumbar support — Easily adjusts to enhance comfort.



X. Dual-clutch posture control — Adjusts seat and back angles independently with two levers (infinite locking within a fixed range).

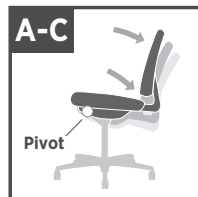

A-C. Synchronized tilt — Back reclines at a 2.5 to 1 ratio to seat angle. Variable lock.



A-D. Side tilt tension — Controls rate and ease of recline. Conveniently located on the right side.



A-E. Back reclines at a 2 to 1 ratio to seat angle. Back angle adjusts independently of seat and can be locked in infinite number of positions within a fixed range.



A-F. Back reclines at a 2 to 1 ratio to seat angle. Back angle adjusts independently of seat and can be locked in infinite number of positions within a fixed range.

LEGEND

THE FOLLOWING ICONS ARE USED TO DENOTE PRODUCT AND FABRIC OPTION LEAD TIMES

PRODUCT LEAD TIME INDICATOR



Product is readily available. See honready.com/leadtime for product lead times by series.



Product is available within a “standard” or “extended” lead time. The lead time will be determined by the combination of product and fabric. See honready.com/leadtime for product lead times by series.



Product may have extended lead times. See honready.com/leadtime for product lead times by series.

FABRIC/FINISH LEAD TIME INDICATOR



Fabric is readily available. Products using these fabrics will receive the best available product lead time and are a good option for standards programs as they will be in the HON portfolio for several years. See honready.com/leadtime for product lead times by series.



Fabric is available within standard lead times. Products using these fabrics will receive a “standard” or “extended” lead time. The lead time will be determined by the combination of product and fabric. See honready.com/leadtime for product lead times by series.



Fabric may have extended lead times. Products using these fabrics will typically have a 4+ week lead time. See honready.com/leadtime for product lead times by series.

CALCULATE LEAD TIME

READILY AVAILABLE LEAD TIME

◆ PRODUCT + ◆ FABRIC/FINISH OPTIONS

STANDARD LEAD TIME

◆ PRODUCT + ◆ FABRIC/FINISH OPTIONS

◆ PRODUCT + ◆ FABRIC/FINISH OPTIONS

◆ PRODUCT + ◆ FABRIC/FINISH OPTIONS

EXTENDED LEAD TIME

◆ PRODUCT + ◆ FABRIC/FINISH OPTIONS

◆ PRODUCT + ◆ FABRIC/FINISH OPTIONS

◆ PRODUCT + ◆ FABRIC/FINISH OPTIONS

◆ PRODUCT + ◆ FABRIC/FINISH OPTIONS

◆ PRODUCT + ◆ FABRIC/FINISH OPTIONS

FABRIC PATTERNS & CODES

GRADE 1		GRADE 1 <i>continued</i>		GRADE 1 <i>continued</i>		GRADE 1 <i>continued</i>	
ARRONDI *	RO	COMPASS	COMP	DAPPER	DAPR	OPTIC	OP
◇ Carob *	RO49	◇ Beach	COMP16	◇ Ash	DAPR20	◇ Aurora	OP72
◇ Honey *	RO26	◇ Bittersweet	COMP46	◇ Azalea	DAPR95	◇ Bark	OP24
◇ Jet *	RO10	◇ Chocolate	COMP49	◇ Breeze	DAPR06	◇ Canopy	OP84
◇ Lagoon *	RO96	◇ Ink	COMP10	◇ Canvas	DAPR25	◇ Char	OP49
◇ Sand *	RO24	◇ Meadow	COMP82	◇ Currant	DAPR00	◇ Dune *	OP16
◇ Taupe *	RO22	◇ Midnight	COMP90	◇ Emerald	DAPR75	◇ Forest *	OP82
		◇ Putty	COMP22	◇ Fawn	DAPR35	◇ Ruby	OP42
ATTIRE	AI	◇ Ruby	COMP62	◇ Fern	DAPR85	◇ Sand	OP17
◇ Blaze	AI42	◇ Sterling	COMP19	◇ Jewel	DAPR08	◇ Sky	OP83
◇ Blue Lagoon	AI90	◇ Taupe	COMP26	◇ Marigold	DAPR65	◇ Slate	OP19
◇ Crimson	AI62	◇ Tide	COMP96	◇ Onyx	DAPR10	◇ Sprout	OP74
◇ Fatigue	AI76			◇ Orchid	DAPR90	◇ Starry Night	OP11
◇ Ivy	AI82	COMPASS FOAM*	COMF	◇ Peony	DAPR50	◇ Storm	OP56
◇ Lithium	AI19	◇ Bittersweet	COMF46	◇ Pool	DAPR05	◇ Wildfire	OP66
◇ Onyx	AI10	◇ Ink	COMF10	◇ Rose	DAPR40		
◇ Sable	AI49	◇ Meadow	COMF82	◇ Sapphire	DAPR07	SIERRA VINYL	EE
◇ Taupe	AI26	◇ Midnight	COMF90	◇ Scarlet	DAPR45	(Matching vinyl to SS Leather)	
◇ Turquoise	AI96	◇ Putty	COMF22	◇ Sepia	DAPR30	◇ Black	EE11
		◇ Sterling	COMF19	◇ Slate	DAPR15	◇ Brick	EE62
				◇ Sorbet	DAPR55	◇ Chocolate	EE49
				◇ Spice	DAPR60		
CENTURION	CU			◇ Spring	DAPR80	STITCHERY	RI
◇ Apricot	CU47	CONFETTI	AB	◇ Varsity	DAPR09	◇ Barley	RI24
◇ Bark	CU25	◇ Black	AB10	◇ Zest	DAPR70	◇ Crimson	RI62
◇ Berry *	CU62	◇ Blue	AB90			◇ Deep Bronze	RI26
◇ Black	CU10	◇ Burgundy	AB62	INERTIA	NR	◇ Ganache	RI49
◇ Caramel *	CU26	◇ Gray	AB12	◇ Amethyst	NR61	◇ Indigo	RI90
◇ Cerulean *	CU90			◇ Bronze *	NR28	◇ Jam	RI65
◇ Espresso	CU49	CONTOURETTE	UR	◇ Calypso	NR98	◇ Jet	RI10
◇ Frost	CU22	POLYURETHANE		◇ Cherry	NR66	◇ Keylime	RI78
◇ Glacier *	CU96	◇ Black	UR10	◇ Clover *	NR74	◇ Olivine	RI82
◇ Goldenrod	CU27	◇ Buff	UR22	◇ Cobalt	NR91	◇ Poppy	RI42
◇ Iris	CU50	◇ Coffee Bean	UR49	◇ Coffee	NR49	◇ Salt & Pepper	RI19
◇ Iron Ore	CU19	◇ Flame	UR62	◇ Fog	NR19	◇ Wheat	RI28
◇ Jade	CU83	◇ Graphite	UR19	◇ Fuchsia	NR63		
◇ Marsala	CU63	◇ Luggage	UR26	◇ Gecko	NR76	TECTONIC	NT
◇ Morel	CU24	◇ Marine	UR92	◇ Glow	NR27	◇ Black	NT10
◇ Navy	CU98	◇ Ocean	UR96	◇ Leaf	NR75	◇ Charcoal	NT19
◇ Olivine *	CU82	◇ Pumpkin	UR42	◇ Lime	NR82	◇ Chive	NT78
◇ Peacock	CU97	◇ Sage	UR82	◇ Loft	NR22	◇ Mariner	NT90
◇ Pear	CU84	◇ Steel	UR21	◇ Mandarin	NR47	◇ Periwinkle	NT85
◇ Poppy *	CU42	◇ Taupe	UR28	◇ Meteor	NR30	◇ Taupe	NT26
◇ Ruby	CU67			◇ Mulberry *	NR60	◇ Wine	NT69
◇ Tangerine *	CU46			◇ Mustard	NR26		
◇ Tomato *	CU66			◇ Nickel	NR23		
				◇ Onyx	NR10		
CLASSIC	BK			◇ Regatta	NR90		
◇ Blue	BK85			◇ Shadow	NR20		
◇ Burgundy	BK62			◇ Surf	NR96		
◇ Iron	BK19			◇ Tangelo	NR46		

* Fabric is de-emphasized.

FABRIC PATTERNS & CODES

GRADE 2

APPOINT SEATING	PNS
◆ Blackberry	PNS012
◆ Bronze	PNS002
◆ Carbon	PNS008
◆ Cherry	PNS010
◆ Espresso	PNS003
◆ Framboise	PNS011
◆ Jet	PNS007
◆ Lawn	PNS005
◆ Mandarin	PNS009
◆ Morel	PNS001
◆ Platinum	PNS004
◆ Turquoise	PNS006

BANGLE	SMOMBAN
◆ Baltic	SMOMBAN91
◆ Cork	SMOMBAN02
◆ Granite	SMOMBAN13
◆ Orchid	SMOMBAN24
◆ Sable	SMOMBAN35
◆ Suede	SMOMBAN46
◆ Teak	SMOMBAN57

CLYDE	CLYD
<i>NEW! Available 1/30/17</i>	
◆ Antique	CLYD04
◆ Artifact	CLYD01
◆ Blacksmith	CLYD10
◆ Claret	CLYD13
◆ Craftsman	CLYD08
◆ Crate	CLYD12
◆ Fossil	CLYD02
◆ Heirloom	CLYD05
◆ Iron	CLYD11
◆ Linen	CLYD14
◆ Relic	CLYD06
◆ Seasoned	CLYD03
◆ Trestle	CLYD07
◆ Weathered	CLYD09

DOTTY	DOT
◆ Berry	DOT62
◆ Black	DOT10
◆ Crimini	DOT28
◆ Mosaic	DOT26
◆ Peat	DOT24
◆ Pewter	DOT19
◆ Sepia	DOT49
◆ Tide	DOT90
◆ Toffee	DOT76
◆ Tomatillo	DOT82

GRADE 2 *continued*

ESPLANADE *	PE
◆ Alloy *	PE22
◆ Berry *	PE62
◆ Espresso *	PE49
◆ Flame *	PE42
◆ Khaki *	PE26
◆ Lapis *	PE90
◆ Lawn *	PE82
◆ Licorice *	PE10
◆ Oasis *	PE96
◆ Tourmaline *	PE78

EXPO	SMOMEXP
◆ Festive	SMOMEXP90
◆ Fog	SMOMEXP01
◆ Latte	SMOMEXP12
◆ Leaf	SMOMEXP23
◆ Lemon	SMOMEXP20
◆ Oasis	SMOMEXP64
◆ Raspberry	SMOMEXP42
◆ Sky	SMOMEXP34
◆ Spirit	SMOMEXP75
◆ Sprout	SMOMEXP53
◆ Tuxedo	SMOMEXP25
◆ Viola	SMOMEXP45
◆ Zest	SMOMEXP31

FUSE	SMOMFUS
◆ Azurean	SMOMFUS99
◆ Carmine	SMOMFUS10
◆ Cress	SMOMFUS21
◆ Ginger	SMOMFUS32
◆ Iris	SMOMFUS43
◆ Lunar	SMOMFUS54
◆ Malted	SMOMFUS65
◆ Morel	SMOMFUS76
◆ Pepper	SMOMFUS87
◆ Pimento	SMOMFUS98
◆ Pristine	SMOMFUS09
◆ Saffron	SMOMFUS20
◆ Walnut	SMOMFUS31

GIO *	GO
◆ Glow *	GO40
◆ Icicle *	GO19
◆ Misty *	GO92
◆ Mocha *	GO47
◆ Onyx *	GO10
◆ Rye *	GO24
◆ Sage *	GO80
◆ Vermilion *	GO60

JAMESTOWN VINYL	EJ
◆ Black	EJ10
◆ Oxblood	EJ65
◆ Slate	EJ92

GRADE 2 *continued*

MOGULS	MOG
◆ Birch	MOG43
◆ Flare	MOG88
◆ Graphite	MOG97
◆ Java	MOG42
◆ Mandarin	MOG45
◆ Navy	MOG86
◆ Onyx	MOG99
◆ Verdant	MOG44
◆ Waterfall	MOG26

ORIGIN	SMOMORG
◆ Amethyst	SMOMORG23
◆ Annato	SMOMORG75
◆ Arundel	SMOMORG86
◆ Avalon	SMOMORG97
◆ Basalt	SMOMORG08
◆ Bayou	SMOMORG24
◆ Bottle	SMOMORG25
◆ Caraway	SMOMORG19
◆ Eco	SMOMORG26
◆ Eureka	SMOMORG03
◆ Euro	SMOMORG41
◆ Fez	SMOMORG52
◆ Gaia	SMOMORG63
◆ Garnet	SMOMORG27
◆ Indigo	SMOMORG28
◆ Iron	SMOMORG29
◆ Jet	SMOMORG30
◆ Malt	SMOMORG74
◆ Manta	SMOMORG85
◆ Mikan	SMOMORG96
◆ Myth	SMOMORG31
◆ Poppy	SMOMORG07
◆ Sapphire	SMOMORG32
◆ Sodalite	SMOMORG33
◆ Stately	SMOMORG18
◆ Steel	SMOMORG34
◆ System	SMOMORG35
◆ Twine	SMOMORG45

GRADE 2 *continued*

SEED	SED
<i>NEW! Available 1/30/17</i>	
◆ Apple	SED11
◆ Ash	SED15
◆ Cardinal	SED09
◆ Cinder	SED17
◆ Cream	SED12
◆ Driftwood	SED13
◆ Harbor	SED10
◆ Onyx	SED18
◆ Smoke	SED16
◆ Truffle	SED14

SOCKHOP	HOP
◆ Carbon	HOP18
◆ Garnet	HOP51
◆ Lawn	HOP61
◆ Platinum	HOP21
◆ Pool	HOP16
◆ Pumpkin	HOP50
◆ Rattan	HOP60
◆ Regatta	HOP17
◆ Truffle	HOP70

SPIN SEATING	SPNN
◆ Alabaster	SPNN02
◆ Cavern	SPNN03
◆ Cobblestone	SPNN04
◆ Ember	SPNN06
◆ Flame	SPNN07
◆ Heron	SPNN13
◆ Oat	SPNN01
◆ Ocean	SPNN12
◆ Plum	SPNN15
◆ Pool	SPNN11
◆ Raven	SPNN10
◆ Rhubarb	SPNN14
◆ Tropic	SPNN08
◆ Willow	SPNN05

* Fabric is de-emphasized.

FABRIC PATTERNS & CODES

GRADE 2 *continued*

WHISPER VINYL	WP
◆ Antelope	WP20
◆ Anthracite *	WP35
◆ Black	WP40
◆ Bone	WP17
◆ Bordeaux	WP26
◆ Brick Red	WP99
◆ Brilliant White *	WP16
◆ Camel	WP18
◆ Cappuccino	WP21
◆ Carotene	WP97
◆ Cashew	WP29
◆ Cavern Moss *	WP32
◆ Cerulean	WP36
◆ Charcoal	WP39
◆ Cinnamon	WP25
◆ Cognac	WP62
◆ Cucumber	WP88
◆ Elephant	WP38
◆ Espresso	WP49
◆ Fawn	WP91
◆ Fog	WP100
◆ Forest	WP82
◆ Gravel	WP19
◆ Green Tea *	WP31
◆ Indigo	WP86
◆ Khaki *	WP30
◆ Loden *	WP33
◆ Luggage	WP23
◆ Mahogany	WP93
◆ Mallard	WP90
◆ Merlot	WP27
◆ Molten	WP98
◆ Navy	WP37
◆ Nightshade *	WP10
◆ Ochre	WP96
◆ Paradise	WP85
◆ Patina	WP34
◆ Pewter	WP83
◆ Putty	WP84
◆ Salsa	WP42
◆ Sangre	WP28
◆ Sassafras	WP89
◆ Sisal *	WP22
◆ Storm	WP92
◆ Truffle	WP95
◆ Zest	WP87

GRADE 3

CANTER POLYURETHANE	SMOMCNT
◆ Alfalfa	SMOMCNT84
◆ Ancho	SMOMCNT73
◆ Ballad	SMOMCNT83
◆ Baltic	SMOMCNT94
◆ Basalt	SMOMCNT07
◆ Bordeaux	SMOMCNT38
◆ Brazen	SMOMCNT18
◆ Chestnut	SMOMCNT62
◆ Cordovan	SMOMCNT27
◆ Earth	SMOMCNT28
◆ Ink	SMOMCNT85
◆ Iron	SMOMCNT96
◆ Lucid	SMOMCNT60
◆ Maize	SMOMCNT71
◆ Mica	SMOMCNT17
◆ Night	SMOMCNT16
◆ Nimbus	SMOMCNT82
◆ Onyx	SMOMCNT39
◆ Pyrite	SMOMCNT93
◆ Quarry	SMOMCNT04
◆ Sable	SMOMCNT05
◆ Saddle	SMOMCNT51
◆ Safari	SMOMCNT06
◆ Sand	SMOMCNT40
◆ Storm	SMOMCNT15
◆ Sumac	SMOMCNT26
◆ Tango	SMOMCNT37
◆ Tawny	SMOMCNT48
◆ Thatch	SMOMCNT59
◆ Toasty	SMOMCNT70
◆ Tusk	SMOMCNT81
◆ Verdite	SMOMCNT92
◆ Willow	SMOMCNT95

GRADE 3 *continued*

EPIC <i>NEW! Available 1/30/17</i>	SMOMEPC
◆ Azure	SMOMEPC92
◆ Capri	SMOMEPC03
◆ Espresso	SMOMEPC14
◆ Flare	SMOMEPC25
◆ Granite	SMOMEPC47
◆ Jute	SMOMEPC36
◆ Kiwi	SMOMEPC58
◆ Limestone	SMOMEPC69
◆ Pearl	SMOMEPC80
◆ Porcini	SMOMEPC91
◆ Regal	SMOMEPC02
◆ Slice	SMOMEPC13
◆ Steel	SMOMEPC24

INFINITY	SMOMFIN
◆ Aluminum	SMOMFIN92
◆ Aster	SMOMFIN50
◆ Atoll	SMOMFIN23
◆ Barley	SMOMFIN03
◆ Berry	SMOMFIN36
◆ Beyond	SMOMFIN34
◆ Capri	SMOMFIN54
◆ Dove	SMOMFIN02
◆ Eclipse	SMOMFIN67
◆ Graphite	SMOMFIN99
◆ Gull	SMOMFIN94
◆ Hyacinth	SMOMFIN00
◆ Java	SMOMFIN11
◆ Lemongrass	SMOMFIN22
◆ Links	SMOMFIN33
◆ Macintosh	SMOMFIN44
◆ Maize	SMOMFIN31
◆ Papaya	SMOMFIN32
◆ Pewter	SMOMFIN95
◆ Pumice	SMOMFIN88
◆ Radiant	SMOMFIN12
◆ Rinse	SMOMFIN52
◆ Russet	SMOMFIN10
◆ Sable	SMOMFIN06
◆ Stucco	SMOMFIN90
◆ Terrain	SMOMFIN16
◆ Tyrain	SMOMFIN55
◆ Umber	SMOMFIN65
◆ Vanilla	SMOMFIN76
◆ Vine	SMOMFIN28

GRADE 3 *continued*

KNACK	SMOMKNC
◆ Berry	SMOMKNC62
◆ Brisk	SMOMKNC23
◆ Carbon	SMOMKNC73
◆ Dark Roast	SMOMKNC84
◆ Filament	SMOMKNC95
◆ Fresco	SMOMKNC34
◆ Glaze	SMOMKNC06
◆ Reed	SMOMKNC45
◆ Sax	SMOMKNC56
◆ Teak	SMOMKNC67
◆ Wave	SMOMKNC17
◆ Zest	SMOMKNC78
◆ Zing	SMOMKNC89

MARATHON	SMOMMAR
◆ Alert	SMOMMAR66
◆ Arbor	SMOMMAR77
◆ Caravel	SMOMMAR49
◆ Chili	SMOMMAR60
◆ Clay	SMOMMAR88
◆ Clove	SMOMMAR99
◆ Curry	SMOMMAR10
◆ Cyan	SMOMMAR21
◆ Deep	SMOMMAR32
◆ Flax	SMOMMAR43
◆ Fluorite	SMOMMAR54
◆ Foliage	SMOMMAR71
◆ Herb	SMOMMAR65
◆ Lantern	SMOMMAR76
◆ Marigold	SMOMMAR30
◆ Noir	SMOMMAR87
◆ Oats	SMOMMAR98
◆ Oz	SMOMMAR09
◆ Pinot	SMOMMAR82
◆ Pollen	SMOMMAR20
◆ Rain	SMOMMAR93
◆ Ridge	SMOMMAR04
◆ Sprite	SMOMMAR31
◆ Storm	SMOMMAR42
◆ Sunset	SMOMMAR15
◆ Tint	SMOMMAR53
◆ Toile	SMOMMAR26
◆ Violet	SMOMMAR37
◆ Vivacious	SMOMMAR64
◆ Wren	SMOMMAR75

* Fabric is de-emphasized.

FABRIC PATTERNS & CODES

GRADE 3 *continued*

MILLENNIUM	SMOMMIL
◆ Aglow	SMOMMIL48
◆ Amber	SMOMMIL38
◆ Anchor	SMOMMIL94
◆ Cascade	SMOMMIL50
◆ Cavern	SMOMMIL91
◆ Cerise	SMOMMIL45
◆ Clean	SMOMMIL90
◆ Coastal	SMOMMIL56
◆ Copper	SMOMMIL12
◆ Crisp	SMOMMIL21
◆ Electric	SMOMMIL81
◆ Geode	SMOMMIL03
◆ Lush	SMOMMIL23
◆ Mocha	SMOMMIL34
◆ Monument	SMOMMIL16
◆ Nectar	SMOMMIL14
◆ Onyx	SMOMMIL68
◆ Orchid	SMOMMIL32
◆ Peridot	SMOMMIL22
◆ Plateau	SMOMMIL06
◆ Pool	SMOMMIL54
◆ Pyrite	SMOMMIL87
◆ Safari	SMOMMIL17
◆ Sapphire	SMOMMIL58
◆ Spark	SMOMMIL82
◆ Steel	SMOMMIL95
◆ Tanzanite	SMOMMIL51
◆ Thrill	SMOMMIL41
◆ Voyage	SMOMMIL59
◆ Zinc	SMOMMIL04

GRADE 3 *continued*

ODYSSEY	SMOMODY
◆ Alloy	SMOMODY37
◆ Amp	SMOMODY42
◆ Breeze	SMOMODY94
◆ Captain	SMOMODY69
◆ Carbon	SMOMODY70
◆ Cedar	SMOMODY18
◆ Craft	SMOMODY06
◆ Cruise	SMOMODY53
◆ Dijon	SMOMODY14
◆ Eggplant	SMOMODY72
◆ Emerald	SMOMODY26
◆ Fossil	SMOMODY16
◆ Ink	SMOMODY58
◆ Inlet	SMOMODY91
◆ Iris	SMOMODY78
◆ Kiss	SMOMODY03
◆ Linen	SMOMODY05
◆ Lively	SMOMODY80
◆ Maritime	SMOMODY51
◆ Nettle	SMOMODY92
◆ Oliver	SMOMODY04
◆ Opaque	SMOMODY13
◆ Primary	SMOMODY54
◆ Roast	SMOMODY19
◆ Rue	SMOMODY96
◆ Sangria	SMOMODY44
◆ Skim	SMOMODY02
◆ Smith	SMOMODY83
◆ Tinge	SMOMODY95
◆ Western	SMOMODY33

GRADE 3 *continued*

SILVERTEX™ VINYL	SX
◆ Acid	SX34
◆ Basil	SX20
◆ Bazaar	SX37
◆ Blackberry	SX17
◆ Borscht	SX15
◆ Bottle	SX21
◆ Bronze	SX32
◆ Carbon	SX23
◆ Celery	SX19
◆ Champagne	SX08
◆ Chestnut	SX10
◆ Cream	SX07
◆ Crème de Menthe	SX33
◆ Ice	SX06
◆ Imperial	SX38
◆ Jet	SX05
◆ Lagoon	SX02
◆ Limoncello	SX42
◆ Luggage	SX13
◆ Mandarin	SX11
◆ Marine Blue	SX01
◆ Marsh	SX31
◆ Meteor	SX24
◆ Mocha	SX25
◆ Netra	SX30
◆ Peat	SX35
◆ Peat	SX35
◆ Plata	SX39
◆ Raspberry	SX16
◆ Sage	SX18
◆ Sapphire	SX04
◆ Sterling	SX40
◆ Storm	SX22
◆ Sunkist	SX12
◆ Taupe	SX09
◆ Turquoise	SX03
◆ Umber	SX14
◆ Zest	SX41

SYNTAX **SMOMSYN**

◆ Asphalt	SMOMSYN51
◆ Camel	SMOMSYN62
◆ Carmine	SMOMSYN73
◆ Cocoa	SMOMSYN83
◆ Flare	SMOMSYN94
◆ Hudson	SMOMSYN84
◆ Mahogany	SMOMSYN95
◆ Nectar	SMOMSYN06
◆ Pewter	SMOMSYN05
◆ Plant	SMOMSYN17
◆ Shale	SMOMSYN28
◆ Steel	SMOMSYN39
◆ Tiger Eye	SMOMSYN50
◆ Turquoise	SMOMSYN61
◆ Violet	SMOMSYN72

GRADE 3 *continued*

TRADITION	SMOMTRA
◆ Ash	SMOMTRA05
◆ Branch	SMOMTRA18
◆ Class	SMOMTRA57
◆ Distant	SMOMTRA62
◆ Flirt	SMOMTRA32
◆ Frond	SMOMTRA87
◆ Grain	SMOMTRA17
◆ Hedge	SMOMTRA56
◆ Hidden	SMOMTRA67
◆ Isle	SMOMTRA39
◆ Jazz	SMOMTRA50
◆ Kelly	SMOMTRA25
◆ Latte	SMOMTRA15
◆ Malbec	SMOMTRA48
◆ Miller	SMOMTRA84
◆ Mist	SMOMTRA92
◆ Peel	SMOMTRA94
◆ Plated	SMOMTRA95
◆ Regal	SMOMTRA74
◆ Sly	SMOMTRA27
◆ Soar	SMOMTRA53
◆ Soy	SMOMTRA02
◆ Spiced	SMOMTRA60
◆ Sprout	SMOMTRA83
◆ Sterling	SMOMTRA71
◆ Sun	SMOMTRA82
◆ Tango	SMOMTRA34
◆ Theater	SMOMTRA93
◆ Wash	SMOMTRA55
◆ Weld	SMOMTRA16

VIA **SMOMVIA**

◆ Cayenne	SMOMVIA69
◆ Cornsilk	SMOMVIA80
◆ Feldspar	SMOMVIA91
◆ Galaxy	SMOMVIA02
◆ Khaki	SMOMVIA13
◆ Pristine	SMOMVIA24
◆ Slate	SMOMVIA35

FABRIC PATTERNS & CODES

GRADE 4

BAR	SMHMBAR
Alert	SMHMBAR06
Hop	SMHMBAR01
Median	SMHMBAR05
Path	SMHMBAR03
Shift	SMHMBAR02
Track	SMHMBAR04
Transition	SMHMBAR07

BEELINE	SMOMBEE
Canvas	SMOMBEE10
Cork	SMOMBEE21
Eclipse	SMOMBEE32
Eucalyptus	SMOMBEE43
Forge	SMOMBEE54
Fossil	SMOMBEE65
Geyser	SMOMBEE76
Nimbus	SMOMBEE87
Oriole	SMOMBEE98
Parade	SMOMBEE09
Portobello	SMOMBEE20
Sisal	SMOMBEE31
Sprout	SMOMBEE42
Sundance	SMOMBEE53
Tidal	SMOMBEE64
Walnut	SMOMBEE75

BLIP	SCFSBLP
Earth	SCFSBLP41
Garnet	SCFSBLP44
Gecko	SCFSBLP34
Grasshopper	SCFSBLP36
Marble	SCFSBLP33
Maui	SCFSBLP46
Mineral	SCFSBLP37
Moonstone	SCFSBLP42
Ore	SCFSBLP49
Pebble	SCFSBLP38
Pumpkin	SCFSBLP40
Quarry	SCFSBLP35
Red Hot	SCFSBLP43
Retriever	SCFSBLP39
Scuba	SCFSBLP47
Superhero	SCFSBLP48
Wisteria	SCFSBLP45

COIN	SMHMOIN
Copper	SMHMOIN03
Diner	SMHMOIN02
Exchange	SMHMOIN06
Lead	SMHMOIN07
Maroon	SMHMOIN04
Nickel	SMHMOIN01
Penny	SMHMOIN05

GRADE 4 *continued*

COVER CLOTH	SMOMCOV
Antique	SMOMCOV11
Bouquet	SMOMCOV22
Coffee	SMOMCOV33
Cyan	SMOMCOV44
Delft	SMOMCOV55
Electric	SMOMCOV66
Flame	SMOMCOV77
Fuchsia	SMOMCOV53
Graphite	SMOMCOV88
Heirloom	SMOMCOV64
Hickory	SMOMCOV99
Indigo	SMOMCOV10
Jet	SMOMCOV21
Navel	SMOMCOV32
Oat	SMOMCOV43
Platinum	SMOMCOV54
Savor	SMOMCOV65
Shire	SMOMCOV76
Sorrel	SMOMCOV87
Taiga	SMOMCOV09
Taupe	SMOMCOV98
Vesper	SMOMCOV20
Vessel	SMOMCOV31
Zest	SMOMCOV42

CURRENT	SMOMCUR
Birch	SMOMCUR93
Cadet	SMOMCUR04
Eclipse	SMOMCUR15
Espresso	SMOMCUR26
Moss	SMOMCUR37
Pecan	SMOMCUR48
Plum	SMOMCUR59

DECODE	SMOMDEC
Alloy	SMOMDEC88
Blaze	SMOMDEC10
Cherry	SMOMDEC27
Elm	SMOMDEC21
Graphite	SMOMDEC32
Grove	SMOMDEC43
Nickel	SMOMDEC54

DISC	SMHMDCS
Festive	SMHMDCS03
Khaki	SMHMDCS02
Nude	SMHMDCS01
Somber	SMHMDCS05
Steel	SMHMDCS07
Vibrant	SMHMDCS04
Warm	SMHMDCS06

GRADE 4 *continued*

DIVIDE	SMHMDVD
Café	SMHMDVD02
Cayenne	SMHMDVD09
Concrete	SMHMDVD03
Ecru	SMHMDVD01
Forest	SMHMDVD04
Lagoon	SMHMDVD06
Mocha	SMHMDVD07
Singe	SMHMDVD08
Tropic	SMHMDVD05

FREE	SMOMFRE
Cocoa	SMOMFRE89
Evening	SMOMFRE00
Graphite	SMOMFRE11
Oasis	SMOMFRE22
Orbit	SMOMFRE55
Pearl	SMOMFRE33
Platinum	SMOMFRE44

HABIT	SMOMHAB
Aspen	SMOMHAB76
Blueprint	SMOMHAB87
Dune	SMOMHAB79
Kindle	SMOMHAB98
Pier	SMOMHAB09
Salt	SMOMHAB90
Tailor	SMOMHAB20

HIVE	SCFSHVE
Aegean	SCFSHVE77
Brick	SCFSHVE81
Bumble	SCFSHVE73
Chili	SCFSHVE75
Honeycomb	SCFSHVE80
Hornet	SCFSHVE72
Slate	SCFSHVE71
Violet	SCFSHVE79
Water	SCFSHVE74

LINEUP	SMOMEUP
Baltic	SMOMEUP58
Fern	SMOMEUP25
Pewter	SMOMEUP94
Sandstone	SMOMEUP17
Shadow	SMOMEUP67
Spice	SMOMEUP35
Tranquil	SMOMEUP53

GRADE 4 *continued*

MANNER	SMHMMAN
Ablaze	SMHMMAN13
Aquatic	SMHMMAN22
Basin	SMHMMAN26
Butterscotch	SMHMMAN16
Caper	SMHMMAN19
Carob	SMHMMAN02
Cocoa	SMHMMAN08
Cola	SMHMMAN10
Cottage	SMHMMAN23
Dahlia	SMHMMAN24
Ember	SMHMMAN11
Flint	SMHMMAN04
Greenway	SMHMMAN21
Harvest	SMHMMAN17
Hush	SMHMMAN05
Lioness	SMHMMAN18
Magic	SMHMMAN01
Nuance	SMHMMAN06
Parakeet	SMHMMAN20
Pathway	SMHMMAN09
Peel	SMHMMAN14
Penny	SMHMMAN15
Porpoise	SMHMMAN03
Schooner	SMHMMAN27
Thicket	SMHMMAN07
Vivid	SMHMMAN25
Wagon	SMHMMAN12

MEDIUM	SMHMMDM
Alloy	SMHMMDM03
Bark	SMHMMDM06
Blackberry	SMHMMDM52
Cascade	SMHMMDM51
Cosmic	SMHMMDM50
Delight	SMHMMDM36
Espresso	SMHMMDM07
Flax	SMHMMDM04
Hike	SMHMMDM47
Laser	SMHMMDM14
Marina	SMHMMDM22
Nasturtium	SMHMMDM53
Nautical	SMHMMDM39
Pacific	SMHMMDM49
Pecan	SMHMMDM08
Persimmon	SMHMMDM13
Pistachio	SMHMMDM29
Pool	SMHMMDM40
Port	SMHMMDM16
Prospect	SMHMMDM32
Pumpkin	SMHMMDM12
Raven	SMHMMDM01
Sculpture	SMHMMDM45
Smoke	SMHMMDM02
Tangle	SMHMMDM48
Thatched	SMHMMDM46
Washed	SMHMMDM44
Wooded	SMHMMDM54

FABRIC PATTERNS & CODES

GRADE 4 <i>continued</i>		GRADE 4 <i>continued</i>		GRADE 4 <i>continued</i>		GRADE 5	
MESSENGER	SMHMGRM	METRIC	SMHMMET	SPRINT	SCFSSPT	AMUSE	SMOMAMU
◆ Ash	SMHMGRM77	◆ Admiral	SMHMMET26	◆ Abyss	SCFSSPT38	◆ Admiral	SMOMAMU56
◆ Aster	SMHMGRM67	◆ Alligator	SMHMMET20	◆ Blackberry	SCFSSPT36	◆ Alloy	SMOMAMU93
◆ Azure	SMHMGRM41	◆ Anchor	SMHMMET24	◆ Blaze	SCFSSPT29	◆ Mocha	SMOMAMU18
◆ Balsa	SMHMGRM01	◆ Arabica	SMHMMET09	◆ Breeze	SCFSSPT28	◆ Poppy	SMOMAMU45
◆ Bayou	SMHMGRM08	◆ Bittersweet	SMHMMET08	◆ Cherry	SCFSSPT34	◆ Quartz	SMOMAMU91
◆ Beyond	SMHMGRM85	◆ Bonsai	SMHMMET22	◆ Cordovan	SCFSSPT35		
◆ Cactus	SMHMGRM45	◆ Brick	SMHMMET11	◆ Driftwood	SCFSSPT33	AVENUE	SMOMAVE
◆ Capri	SMHMGRM61	◆ Caramel	SMHMMET17	◆ Fern	SCFSSPT27	◆ Carbon	SMOMAVE66
◆ Cassis	SMHMGRM66	◆ Cardinal	SMHMMET12	◆ Gold	SCFSSPT24	◆ Garden	SMOMAVE25
◆ Cherry	SMHMGRM69	◆ Cedar	SMHMMET15	◆ Graphite	SCFSSPT26	◆ Java	SMOMAVE46
◆ Chestnut	SMHMGRM52	◆ Cerise	SMHMMET10	◆ Ivory	SCFSSPT21	◆ Pacific	SMOMAVE55
◆ Chili	SMHMGRM83	◆ Driftwood	SMHMMET06	◆ Mist	SCFSSPT20	◆ Salsa	SMOMAVE45
◆ Cloud	SMHMGRM31	◆ Envy	SMHMMET21	◆ Nocturne	SCFSSPT31		
◆ Depth	SMHMGRM38	◆ Fleece	SMHMMET03	◆ Peat	SCFSSPT37	LARIAT	SMHMLRT
◆ Electric	SMHMGRM88	◆ Fog	SMHMMET02	◆ Quarry	SCFSSPT22	◆ Alabaster	SMHMLRT25
◆ Everglade	SMHMGRM87	◆ Lava	SMHMMET13	◆ Rust	SCFSSPT30	◆ Auburn	SMHMLRT31
◆ Fennel	SMHMGRM59	◆ Mineral	SMHMMET07	◆ Storm	SCFSSPT32	◆ Black	SMHMLRT06
◆ Fireside	SMHMGRM82	◆ Oriole	SMHMMET14	◆ Turquoise	SCFSSPT23	◆ Brick Red	SMHMLRT03
◆ Fossil	SMHMGRM76	◆ Phantom	SMHMMET01	◆ Twig	SCFSSPT25	◆ Camel	SMHMLRT01
◆ Husk	SMHMGRM81	◆ Pollen	SMHMMET18			◆ Celadon	SMHMLRT35
◆ Hydrangea	SMHMGRM50	◆ Scuba	SMHMMET28	TECHNIC	SMHMTEC	◆ Chocolate	SMHMLRT11
◆ Ice	SMHMGRM46	◆ Seaport	SMHMMET27	◆ Bear	SMHMTEC04	◆ Cornflower	SMHMLRT33
◆ Lilac	SMHMGRM51	◆ Sorrel	SMHMMET16	◆ Cobalt	SMHMTEC03	◆ Cucumber	SMHMLRT36
◆ Lumine	SMHMGRM54	◆ Sourdough	SMHMMET04	◆ Cumin	SMHMTEC01	◆ Cumin	SMHMLRT23
◆ Maize	SMHMGRM72	◆ Tar	SMHMMET23	◆ Evergreen	SMHMTEC02	◆ Fatigue	SMHMLRT18
◆ Mao	SMHMGRM25	◆ Toffee	SMHMMET05	◆ Squirrel	SMHMTEC05	◆ Fern	SMHMLRT08
◆ Neon	SMHMGRM48	◆ Tupelo	SMHMMET19			◆ Indigo	SMHMLRT04
◆ Nile	SMHMGRM40	◆ Twilight	SMHMMET25			◆ Ivory	SMHMLRT13
◆ Onyx	SMHMGRM29					◆ Lake	SMHMLRT20
◆ Oyster	SMHMGRM79	OBLIQUE	SMHMOBQ			◆ Macaw	SMHMLRT34
◆ Pensive	SMHMGRM80	◆ Bone	SMHMOBQ01			◆ Mahogany	SMHMLRT15
◆ Peridot	SMHMGRM60	◆ Chocolate	SMHMOBQ06			◆ Navy	SMHMLRT21
◆ Poppy	SMHMGRM24	◆ Diner	SMHMOBQ02			◆ Oxblood	SMHMLRT12
◆ Robust	SMHMGRM84	◆ Ember	SMHMOBQ05			◆ Oyster	SMHMLRT07
◆ Satsuma	SMHMGRM71	◆ Mink	SMHMOBQ04			◆ Pebble	SMHMLRT16
◆ Shadow	SMHMGRM07	◆ Natural	SMHMOBQ03			◆ Pepper	SMHMLRT30
◆ Snow	SMHMGRM58	◆ Steel	SMHMOBQ07			◆ Peridot	SMHMLRT37
◆ Spice	SMHMGRM68					◆ Plum	SMHMLRT32
◆ Squall	SMHMGRM63	PICK	SMHMPIC			◆ Putty	SMHMLRT17
◆ Tangelo	SMHMGRM53	◆ Cool	SMHMPIC08			◆ Reptile	SMHMLRT38
◆ Tobacco	SMHMGRM06	◆ Espresso	SMHMPIC04			◆ Russet	SMHMLRT02
◆ Turf	SMHMGRM47	◆ Fresh	SMHMPIC07			◆ Sand	SMHMLRT14
◆ Tusk	SMHMGRM78	◆ Ink	SMHMPIC09			◆ Snow	SMHMLRT26
◆ Ultramarine	SMHMGRM62	◆ Jet	SMHMPIC10			◆ Straw	SMHMLRT27
◆ Vibrant	SMHMGRM70	◆ Masala	SMHMPIC06			◆ Tamarind	SMHMLRT28
◆ Voyage	SMHMGRM86	◆ Olive	SMHMPIC02			◆ Taupe	SMHMLRT10
◆ Zinc	SMHMGRM10	◆ Pepper	SMHMPIC05			◆ Yam	SMHMLRT29
		◆ Ratton	SMHMPIC01			◆ Zinc	SMHMLRT24
		◆ Slate	SMHMPIC03				

FABRIC PATTERNS & CODES

GRADE 5 <i>continued</i>		GRADE 5 <i>continued</i>		GRADE 5 <i>continued</i>		GRADE 6	
OUTLANDER	SCFSOUT	SENTRY-HC	SCFSSEN	SOLACE	SMOMSOL	INTERMIX II	SMOMINT
◆ Acorn	SCFSOUT22	◆ Armada	SCFSSEN49	◆ Almond	SMOMSOL84	◆ Café	SMOMINT91
◆ Amber	SCFSOUT12	◆ Armor	SCFSSEN32	◆ Azul	SMOMSOL95	◆ Coast	SMOMINT02
◆ Aquamarine	SCFSOUT15	◆ Aura	SCFSSEN37	◆ Blaze	SMOMSOL06	◆ Cosmic	SMOMINT13
◆ Blaze	SCFSOUT17	◆ Ballista	SCFSSEN51	◆ Carmine	SMOMSOL17	◆ Herbal	SMOMINT24
◆ Cabernet	SCFSOUT23	◆ Battalion	SCFSSEN33	◆ Celadon	SMOMSOL28	◆ Jam	SMOMINT35
◆ Camel	SCFSOUT10	◆ Castle	SCFSSEN50	◆ Cinder	SMOMSOL39	◆ Malbec	SMOMINT46
◆ Cashmere	SCFSOUT07	◆ Celestial	SCFSSEN34	◆ Earth	SMOMSOL50	◆ Midnight	SMOMINT57
◆ Charcoal	SCFSOUT09	◆ Channel	SCFSSEN42	◆ Ebony	SMOMSOL61	◆ Natural	SMOMINT68
◆ Cloud	SCFSOUT05	◆ Claymore	SCFSSEN40	◆ Fossil	SMOMSOL72	◆ Pewter	SMOMINT79
◆ Dark Blue	SCFSOUT25	◆ Field	SCFSSEN45	◆ Gilded	SMOMSOL83	◆ Salsa	SMOMINT90
◆ Electric	SCFSOUT20	◆ Fleet	SCFSSEN47	◆ Indigo	SMOMSOL94	◆ Smoke	SMOMINT01
◆ Emerald	SCFSOUT26	◆ Fortress	SCFSSEN38	◆ Ivory	SMOMSOL05	◆ Storm	SMOMINT12
◆ Fairway	SCFSOUT21	◆ Garrison	SCFSSEN43	◆ Lapis	SMOMSOL16		
◆ Fern	SCFSOUT16	◆ Guardian	SCFSSEN30	◆ Maui	SMOMSOL27	KEYNOTE	SMOMKEY
◆ Flannel	SCFSOUT19	◆ Hawk	SCFSSEN41	◆ Mineral	SMOMSOL38	◆ Aquarian	SMOMKEY92
◆ Fog	SCFSOUT14	◆ Knight	SCFSSEN36	◆ Nickel	SMOMSOL49	◆ Chai	SMOMKEY03
◆ French Roast	SCFSOUT27	◆ Midnight	SCFSSEN35	◆ Paprika	SMOMSOL60	◆ Chicory	SMOMKEY14
◆ Lemur	SCFSOUT08	◆ Mission	SCFSSEN48	◆ Pear	SMOMSOL04	◆ Curry	SMOMKEY25
◆ Limestone	SCFSOUT06	◆ Patrol	SCFSSEN46	◆ Peony	SMOMSOL71	◆ Granite	SMOMKEY36
◆ Majesty	SCFSOUT28	◆ Sand	SCFSSEN31	◆ Pewter	SMOMSOL82	◆ Linen	SMOMKEY47
◆ Mars	SCFSOUT18	◆ Signal	SCFSSEN44	◆ Roasted	SMOMSOL93	◆ Menthe	SMOMKEY58
◆ Otter	SCFSOUT24	◆ Watchtower	SCFSSEN39			◆ Mesa	SMOMKEY69
◆ Raven	SCFSOUT29			TRIBECA	SCFSTRB	◆ Palmetto	SMOMKEY80
◆ Saffron	SCFSOUT11	SEQUENCE	SCFSSEQ	◆ Amber	SCFSTRB44	◆ Reflect	SMOMKEY91
◆ Tart	SCFSOUT13	◆ Abyss	SCFSSEQ84	◆ Burnt Orange	SCFSTRB47	◆ Sangria	SMOMKEY20
		◆ Alabaster	SCFSSEQ72	◆ Cassis	SCFSTRB50	◆ Simmer	SMOMKEY13
POLKA	SCFSPLK	◆ Burgundy	SCFSSEQ82	◆ Caviar	SCFSTRB58	◆ Wicker	SMOMKEY24
◆ Blue Moon	SCFSPLK63	◆ Cadet	SCFSSEQ81	◆ Cayenne	SCFSTRB48		
◆ Champagne	SCFSPLK62	◆ Carbon	SCFSSEQ73	◆ Clover	SCFSTRB52	RAFFIA VINYL	SCFSRAF
◆ Fuse	SCFSPLK65	◆ Crimson	SCFSSEQ78	◆ Dove	SCFSTRB41	◆ Academy	SCFSRAF27
◆ Limelight	SCFSPLK61	◆ Crisp	SCFSSEQ76	◆ Gemstone	SCFSTRB55	◆ Cinema	SCFSRAF23
◆ Sable	SCFSPLK66	◆ Navy	SCFSSEQ80	◆ Jute	SCFSTRB42	◆ Director	SCFSRAF17
◆ Silhouette	SCFSPLK67	◆ Orange	SCFSSEQ79	◆ Kiss	SCFSTRB49	◆ Flick	SCFSRAF13
◆ Very Berry	SCFSPLK64	◆ Peat	SCFSSEQ83	◆ Regatta	SCFSTRB54	◆ Grip	SCFSRAF25
		◆ Putty	SCFSSEQ74	◆ Shadow	SCFSTRB57	◆ Oscar	SCFSRAF11
RIDDLE	SCFSRID	◆ Silver Lining	SCFSSEQ75	◆ Silver	SCFSTRB45	◆ Premier	SCFSRAF19
◆ Black Coffee	SCFSRID26	◆ Sky	SCFSSEQ77	◆ Slate	SCFSTRB46	◆ Producer	SCFSRAF31
◆ Chalkboard	SCFSRID25			◆ Sunflower	SCFSTRB43	◆ Red Carpet	SCFSRAF29
◆ Citron	SCFSRID22			◆ Teal	SCFSTRB53	◆ Show	SCFSRAF15
◆ Frost	SCFSRID21			◆ Truffle	SCFSTRB56	◆ Silver Screen	SCFSRAF21
◆ Iris	SCFSRID20			◆ Wasabi	SCFSTRB51		
◆ Malt	SCFSRID19						
◆ Peppercorn	SCFSRID23						
◆ Siren	SCFSRID18						
◆ Surf	SCFSRID24						

FABRIC PATTERNS & CODES

GRADE 6 <i>continued</i>		GRADE 7		GRADE 7 <i>continued</i>		GRADE 8	
VELOCITY	SMOMVEL	ASCEND	SMOMASC	DOMAIN	SMOMAIN	BRISA® POLYURETHANE	RS
◆ Aloe	SMOMVEL01	◆ Bark	SMOMASC01	◆ Bay	SMOMAIN01	◆ Abyss	RS78
◆ Azure	SMOMVEL02	◆ Calm	SMOMASC02	◆ Chestnut	SMOMAIN02	◆ Apple Green	RS25
◆ Charcoal	SMOMVEL03	◆ Coast	SMOMASC03	◆ Fossil	SMOMAIN03	◆ Ash	RS05
◆ Coffee	SMOMVEL04	◆ Constant	SMOMASC04	◆ Mineral	SMOMAIN04	◆ Aztec	RS16
◆ Garnet	SMOMVEL05	◆ Cypress	SMOMASC05	◆ Natural	SMOMAIN05	◆ Bark	RS18
◆ Hosta	SMOMVEL06	◆ Dune	SMOMASC06	◆ Pristine	SMOMAIN06	◆ Beet Root	RS361
◆ Malt	SMOMVEL07	◆ Dusk	SMOMASC07	◆ Sienna	SMOMAIN07	◆ Birch	RS64
◆ Nutmeg	SMOMVEL08	◆ Evening	SMOMASC08	◆ Willow	SMOMAIN08	◆ Black Onyx	RS01
◆ Olive	SMOMVEL09	◆ Flannel	SMOMASC09			◆ Blossom	RS74
◆ Pond	SMOMVEL10	◆ Geode	SMOMASC10	SYNERGY	SMOMERG	◆ Blue Sea	RS621
◆ River	SMOMVEL11	◆ Grain	SMOMASC11	◆ Aegean	SMOMERG01	◆ Bone	RS31
◆ Sandstone	SMOMVEL12	◆ Grow	SMOMASC12	◆ Balsamic	SMOMERG02	◆ Cabernet	RS99
◆ Snow	SMOMVEL13	◆ Harvest	SMOMASC13	◆ Barley	SMOMERG03	◆ Cambridge	RS17
◆ Steel	SMOMVEL14	◆ Maize	SMOMASC14	◆ Bedrock	SMOMERG04	◆ Canyon	RS07
◆ Sycamore	SMOMVEL15	◆ Mood	SMOMASC15	◆ Carbon	SMOMERG05	◆ Caramel	RS91
◆ Tulip	SMOMVEL16	◆ Saffron	SMOMASC16	◆ Denim	SMOMERG06	◆ Celery	RS87
				◆ Lichen	SMOMERG07	◆ Cinnabar	RS36
WOOLY	WOL	CENTRAL	SMOMNTR	◆ Meadow	SMOMERG08	◆ Coffee Bean	RS33
◆ Bamboo	WOL008	◆ Autumn	SMOMNTR01	◆ Otter	SMOMERG09	◆ Cookie Dough	RS234
◆ Black	WOL005	◆ Glow	SMOMNTR02	◆ Pecan	SMOMERG10	◆ Cream	RS63
◆ Chaps	WOL014	◆ Lyrical	SMOMNTR03	◆ Sandstone	SMOMERG11	◆ Desert Clay	RS19
◆ Charcoal Flannel	WOL004	◆ Moonrise	SMOMNTR04	◆ Seaglass	SMOMERG12	◆ Esmeralda	RS302
◆ Framboise	WOL012	◆ Regal	SMOMNTR05	◆ Tango	SMOMERG13	◆ Evening Blue	RS620
◆ Geranium	WOL011	◆ Rustic	SMOMNTR06			◆ Flamingo	RS203
◆ Grey Flannel	WOL003	◆ Spirit	SMOMNTR07	WAVER	SMOMWAV	◆ French Vanilla	RS66
◆ Lawn	WOL009			◆ Bisque	SMOMWAV01	◆ Ginger	RS51
◆ Light Grey Mix	WOL002	CHANNEL	SMOMCHA	◆ Festive	SMOMWAV02	◆ Golden	RS67
◆ Marine	WOL007	◆ Horizon	SMOMCHA01	◆ Flax	SMOMWAV03	◆ Gravel	RS275
◆ Natural Heather	WOL001	◆ Quartz	SMOMCHA02	◆ Moment	SMOMWAV04	◆ Hazy Lilac	RS310
◆ Squash	WOL010	◆ Stream	SMOMCHA03	◆ Riverside	SMOMWAV05	◆ Honeycomb	RS233
◆ Turquoise	WOL006	◆ Tide	SMOMCHA04	◆ Root	SMOMWAV06	◆ Iceberg	RS272
◆ Violet	WOL013	◆ Tuscan	SMOMCHA05	◆ Terrain	SMOMWAV07	◆ Indigo	RS14
◆ Walnut	WOL015			◆ Tranquil	SMOMWAV08	◆ Koi	RS202
				◆ Zest	SMOMWAV09	◆ Mineral	RS97
						◆ Moon	RS277
						◆ New Sand	RS20
						◆ Night Navy	RS94
						◆ Olive	RS02
						◆ Peat	RS00
						◆ Pompeian Red	RS83
						◆ Putty	RS08
						◆ Quicksilver	RS30
						◆ Rose Red	RS43
						◆ Sage	RS10
						◆ Salsa	RS15
						◆ Seaweed	RS303
						◆ Shiitake	RS22
						◆ Skyway	RS96
						◆ Sterling Blue	RS98
						◆ Strawberry	RS359
						◆ Truffle	RS12
						◆ Turq	RS23
						◆ White	RS47
						◆ Wishbone	RS276
						◆ Wrought Iron	RS27

FABRIC PATTERNS & CODES

GRADE 8 *continued*

KINDRED	SMOMKIN
◆ Chai	SMOMKIN45
◆ Coal	SMOMKIN56
◆ Earth	SMOMKIN67
◆ Flint	SMOMKIN78
◆ Fossil	SMOMKIN89
◆ Glacial	SMOMKIN00
◆ Grain	SMOMKIN11
◆ Macaw	SMOMKIN22
◆ Mist	SMOMKIN33
◆ Orangery	SMOMKIN44
◆ Rosso	SMOMKIN55
◆ Sand	SMOMKIN66
◆ Smoke	SMOMKIN77
◆ Spice	SMOMKIN88
◆ Stream	SMOMKIN99
◆ Union	SMOMKIN10

GRADE 9

ELI VINYL	SCFSEOL
◆ Bamboo	SCFSEOL17
◆ Black Oxide	SCFSEOL19
◆ Chestnut	SCFSEOL13
◆ Chocolate	SCFSEOL04
◆ Clove	SCFSEOL18
◆ Cranberry	SCFSEOL21
◆ Dove	SCFSEOL01
◆ Hazelnut	SCFSEOL09
◆ Lime	SCFSEOL10
◆ Lipstick	SCFSEOL24
◆ Mango	SCFSEOL22
◆ Marlin	SCFSEOL25
◆ Ocean Floor	SCFSEOL03
◆ Plum	SCFSEOL23
◆ Poppy	SCFSEOL27
◆ River Rock	SCFSEOL16
◆ Sapphire	SCFSEOL20
◆ Steel	SCFSEOL14
◆ Sunlit Sea	SCFSEOL15
◆ Teal	SCFSEOL26

MARTINI VINYL SCFSMIT

◆ Carob	SCFSMIT06
◆ Cayman	SCFSMIT03
◆ Citrus	SCFSMIT02
◆ Cliff	SCFSMIT05
◆ Gull	SCFSMIT08
◆ Haze	SCFSMIT10
◆ Kiwi	SCFSMIT11
◆ Marine	SCFSMIT07
◆ Shipp	SCFSMIT01
◆ Shore	SCFSMIT12
◆ Sicily	SCFSMIT04
◆ Turmeric	SCFSMIT09

OLYMPUS VINYL SCFSOLM

◆ Admiral	SCFSOLM10
◆ Beluga	SCFSOLM14
◆ Coriander	SCFSOLM02
◆ Dune	SCFSOLM04
◆ Fern	SCFSOLM09
◆ Gold Coin	SCFSOLM06
◆ Laurel	SCFSOLM13
◆ Manuka	SCFSOLM12
◆ Melon	SCFSOLM01
◆ Pewter	SCFSOLM11
◆ Santiria	SCFSOLM03
◆ Savannah	SCFSOLM07
◆ Shoya	SCFSOLM08

GRADE 9 *continued*

SILICA	SMOMSIL
◆ Afresco	SMOMSIL39
◆ Alloy	SMOMSIL86
◆ Appletini	SMOMSIL97
◆ Aqua	SMOMSIL78
◆ Bistro	SMOMSIL08
◆ Breakwater	SMOMSIL89
◆ Bright Night	SMOMSIL00
◆ Brownstone	SMOMSIL19
◆ Burnished	SMOMSIL30
◆ Canyon	SMOMSIL13
◆ Chrome	SMOMSIL35
◆ Cloak	SMOMSIL22
◆ Coppercrest	SMOMSIL11
◆ Cumulus	SMOMSIL52
◆ Dare	SMOMSIL33
◆ Dewpoint	SMOMSIL63
◆ Eclipse	SMOMSIL38
◆ Firelight	SMOMSIL31
◆ Flax	SMOMSIL37
◆ Gallant	SMOMSIL74
◆ Garnet	SMOMSIL85
◆ Ginger	SMOMSIL96
◆ Glade	SMOMSIL07
◆ Go	SMOMSIL44
◆ Haze	SMOMSIL18
◆ Herbal	SMOMSIL29
◆ Jewel	SMOMSIL42
◆ Lemon	SMOMSIL34
◆ Lotus	SMOMSIL46
◆ Mane	SMOMSIL55
◆ Manor	SMOMSIL66
◆ Marigold	SMOMSIL40
◆ Medal	SMOMSIL51
◆ Moss	SMOMSIL77
◆ Myth	SMOMSIL88
◆ Nero	SMOMSIL62
◆ Oasis	SMOMSIL43
◆ Petunia	SMOMSIL36
◆ Quartz	SMOMSIL73
◆ Regatta	SMOMSIL93
◆ Sands	SMOMSIL99
◆ Sea Coast	SMOMSIL10
◆ Shale	SMOMSIL45
◆ Sketch	SMOMSIL21
◆ Skyward	SMOMSIL84
◆ Surf	SMOMSIL32
◆ Terra	SMOMSIL95
◆ Tropic	SMOMSIL06

GRADE 9 *continued*

SILICA LEATHER	SMOMSLE
◆ Almond	SMOMSLE02
◆ Aloe	SMOMSLE23
◆ Barley	SMOMSLE12
◆ Chambray	SMOMSLE53
◆ Denim	SMOMSLE56
◆ Dove	SMOMSLE91
◆ Driftwood	SMOMSLE17
◆ Dune	SMOMSLE08
◆ Earthen	SMOMSLE18
◆ Eclipse	SMOMSLE68
◆ Eucalyptus	SMOMSLE28
◆ Hyacinth	SMOMSLE54
◆ Ink	SMOMSLE67
◆ Juniper	SMOMSLE24
◆ Lichen	SMOMSLE26
◆ Madder	SMOMSLE43
◆ Marigold	SMOMSLE87
◆ Mink	SMOMSLE65
◆ Pewter	SMOMSLE95
◆ Raisin	SMOMSLE78
◆ Rustic	SMOMSLE35
◆ Saddle	SMOMSLE33
◆ Shadow	SMOMSLE94
◆ Umber	SMOMSLE19

SILICA TECH SMOMSIT

◆ Ash	SMOMSIT50
◆ Calm	SMOMSIT75
◆ Charge	SMOMSIT61
◆ Fog	SMOMSIT86
◆ Gleam	SMOMSIT97
◆ Kohl	SMOMSIT08
◆ Limelight	SMOMSIT72
◆ Macademia	SMOMSIT19
◆ Magellan	SMOMSIT83
◆ Mineralize	SMOMSIT30
◆ Nightfall	SMOMSIT94
◆ Paloma	SMOMSIT41
◆ Sablewood	SMOMSIT52
◆ Sandstone	SMOMSIT63
◆ Tangelo	SMOMSIT05
◆ Tanzanite	SMOMSIT16
◆ Urbanite	SMOMSIT74
◆ Verdigris	SMOMSIT85
◆ Vintage	SMOMSIT96
◆ Willow	SMOMSIT07

FABRIC PATTERNS & CODES

GRADE 10

AFFINITY SCFSAFF

◆ Bermuda	SCFSAFF09
◆ Capri	SCFSAFF04
◆ Charleston	SCFSAFF10
◆ Chiffon	SCFSAFF07
◆ Concord	SCFSAFF06
◆ Egyptian	SCFSAFF05
◆ Kendall	SCFSAFF11
◆ Manchester	SCFSAFF03
◆ Rhubarb	SCFSAFF01
◆ Salem	SCFSAFF02
◆ Stardust	SCFSAFF08
◆ Twilight	SCFSAFF12

CONCENTRIC SCFSCNC

◆ Corona	SCFSCNC47
◆ Curve	SCFSCNC40
◆ Diameter	SCFSCNC41
◆ Full Circle	SCFSCNC49
◆ Halo	SCFSCNC46
◆ Outline	SCFSCNC50
◆ Radius	SCFSCNC44
◆ Ring	SCFSCNC43
◆ Roundabout	SCFSCNC42
◆ Sphere	SCFSCNC45
◆ Spiral	SCFSCNC48

JUXY SCFSJXY

◆ Ariel	SCFSJXY07
◆ Basalt	SCFSJXY09
◆ Burst	SCFSJXY11
◆ Crystalline	SCFSJXY01
◆ Parallax	SCFSJXY10
◆ Photon	SCFSJXY05
◆ Pulsar	SCFSJXY04
◆ Radius	SCFSJXY02
◆ Rhyolite	SCFSJXY03
◆ Spectra	SCFSJXY13
◆ Sunspot	SCFSJXY06
◆ Ultra-Violet	SCFSJXY12
◆ Vela	SCFSJXY08

GRADE 11

ACROBAT SCFSACT

◆ Bend	SCFSACT93
◆ Pivot	SCFSACT92
◆ Revolution	SCFSACT85
◆ Salto	SCFSACT90
◆ Soar	SCFSACT91
◆ Spin	SCFSACT88
◆ Spiral	SCFSACT89
◆ Tumble	SCFSACT86
◆ Turn	SCFSACT87

NATURAL WORLD SCFSNAT

◆ Bittersweet	SCFSNAT25
◆ Boysenberry	SCFSNAT27
◆ Driftwood	SCFSNAT20
◆ Juniper	SCFSNAT22
◆ Marigold	SCFSNAT23
◆ Nightshade	SCFSNAT26
◆ Sapphire	SCFSNAT24
◆ Timber	SCFSNAT21
◆ Walnut	SCFSNAT28

WHIRL SCFSWHL

◆ Azure	SCFSWHL95
◆ Blue Yonder	SCFSWHL96
◆ Good as Gold	SCFSWHL97
◆ Lemon Twist	SCFSWHL98
◆ Lights Out	SCFSWHL99
◆ Razzle Dazzle	SCFSWHL00
◆ Zing	SCFSWHL01

GRADE 12

FENESTRA SCFSFNT

◆ Arizona	SCFSFNT02
◆ Brazil	SCFSFNT01
◆ Fiesta	SCFSFNT07
◆ Hazel	SCFSFNT03
◆ Patriot	SCFSFNT06
◆ Pimento	SCFSFNT05
◆ Potpourri	SCFSFNT08
◆ Quail	SCFSFNT04

HELIX SCFSHLX

◆ Aubergine	SCFSHLX62
◆ Fog	SCFSHLX58
◆ Haze	SCFSHLX56
◆ Noir	SCFSHLX57
◆ Spice	SCFSHLX63
◆ Stream	SCFSHLX61
◆ Twig	SCFSHLX59
◆ Vanilla Bean	SCFSHLX55

LAVA SCFSLAV

◆ Aurora	SCFSLAV11
◆ Bedrock	SCFSLAV06
◆ Geode	SCFSLAV01
◆ Lagoon	SCFSLAV03
◆ Marsh	SCFSLAV09
◆ Obsidian	SCFSLAV04
◆ Pool	SCFSLAV08
◆ Ridge	SCFSLAV10
◆ Stratum	SCFSLAV12
◆ Stream	SCFSLAV13
◆ Sunfire	SCFSLAV05
◆ Terra	SCFSLAV07
◆ Volcano	SCFSLAV14
◆ Woodland	SCFSLAV02

RIPPLE SCFSRIP

◆ Blue Arrow	SCFSRIP15
◆ Informal Gray	SCFSRIP13
◆ Old Cider	SCFSRIP12
◆ Palisade Brown	SCFSRIP14
◆ Silent	SCFSRIP11
◆ Sunset	SCFSRIP10

GRADE L

DENVER LEATHER SS (Matches EE Vinyl)

◆ Black	SS11
◆ Brick	SS62
◆ Chocolate	SS49

LEATHER SR

◆ Black	SR11
◆ Burgundy	SR69

ORDERING INFORMATION

Steel Seating		Standard Fabric Selections by Series with Price Code and Fabric Material																																																								
Model/Series	RO *	Price Code and Fabric Material																																																								
		AI	EB	VA	GA	MM	EA	CU	BK	COMP	COMF	AB	UR	DAPR	NR	OP	EE	RI	NT	PNS	NMBAN	CLYD	DOT	PE	SMOMEKP	SMOFEUS	GO	MOG	SMOMORG	SED	HOP	SPNN	WP	SMOMCNT	SMOMEPC	SMOMFIN	SMOMKNC	SMOMMAR	SMOMMIL	SMOMODY	SX	SMOHSYN	SMOWTRA	SMOWVIA														
Accommodate™																																																										
Adjustable Task/Lab Stool																																																										
Boda™																																																										
Ceres® Series																																																										
ComforTask® 5900 Series																																																										
Endorse™ Lounge																																																										
Endorse™ Task																																																										
Flock®																																																										
Flock® Round Lounge HFLRCL/DF and Stool HFSS7																																																										
Gambut® 2070 Series																																																										
Grove™																																																										
Ignition® Series																																																										
Invitation® Lounge Series																																																										
Lota® H2281 / H2283 / H2285																																																										
Lota® H2282 / H2284																																																										
Motivate®																																																										
Nucleus® Series																																																										
Pagoda® 4070/4090 Series**																																																										
Park Avenue Collection® 5020 Series																																																										
Perpetual® Nesting																																																										
Pillow-Soft® 2090 Series																																																										
Purpose®																																																										
Quotient™																																																										
Solutions Seating® 4000 Series																																																										
Solve™																																																										
Soothe™																																																										
Soothe™ High Back & Recliner																																																										
Volt® 5700/5710 Series																																																										
Volt® 5720/5730 Series																																																										
7700 Series / 24 Hr Chairs																																																										
7800 Series																																																										
Credenza/Pedestal Cushions																																																										

*Flock® chair model HFLRCL has fabric limitations, please see the Flock® seating pages 86-91 for details.
 **Pagoda® wood back models available in Harvest (C), Natural Maple (D), Shaker Cherry (F), Bourbon Cherry (H) and Mahogany (N) only.
 Note: Gathers and creases may be more visible with AI and OP fabrics due to the inherent design and construction of these fabrics.
 * Fabric is de-emphasized.

ORDERING INFORMATION

- SPECIFY: Model Number
Finish
Fabric/Color Code.
EXAMPLE: H5001.N.AB10
- Seating pages are now arranged in alpha, then numeric, order.
- **All specifications in this publication are based on the latest product information available at the time of print.**
- COM Ordering Information and pricing on page 10.
- Remember to add an FC to the base model number when fire code fabric is selected. New Models with FC Fire Code suffix meet CA Technical Bulletin 133. See pages 34-39 for available models/fabrics.
- Wood components are well-seasoned select hardwoods, chosen for their strength, their ability to machine well and their superior uniformity of stain and finish.
- Chairs with leather feature matching vinyl backs and vinyl seat bottom when applicable (Non-contact areas are vinyl).

HOW TO ORDER — WOOD SEATING

Ordering codes are composed of:
model number + finish + fabric/color code.

Illustration of ordering codes.

Model Number 4-5 Digits					Finish 1 Digit	Fabric 2 Digits		Fabric Color 2 Digits	
H	5	0	0	1	N.	A	B	1	0

This above ordering code specifies a Model H5001 with Mahogany finish and Confetti fabric in Burgundy.

CASTERS/GLIDES

Dual-wheel hooded casters are standard on all models.

Special field-installable black soft-tread casters and glides can be ordered from HON Parts Department at 1-800-336-8398.

OPTIONS

CODES

Models H6551, H6552: Nail Trim around the Seat
Add \$25.00 upcharge.

B

FIRE CODE (CAL133)

Refer to CAL133 Compliant Seating matrices on pages 34-39 for a list of compliant models and fabrics. Add FC to the base model number.

Examples:

STANDARD: H2111.J.AB10

FIRE CODE: H2111FC.J.AB10

Wood Seating	Finish Codes							Standard Fabric Selections by Series with Price Code and Fabric Material																																																
	Bourbon Cherry	Cognac	Harvest	Mahogany	Mocha	Natural Maple	Pinnacle	Shaker Cherry	RO *	AI	EB	CU	BK	COMP	COMF	AB	UR	DAPR	NR	OP	EE	RI	NT	PNS	SHOMBAN	CLYD	DOT	PE *	SHOMEXP	SHOMFUS	GO *	EJ	MOG	SHOMORG	SED	HOP	SPNN	WP	SHOMCNT	SHOMEPIC	SHOMFIN	SHOMKNC	SHOMMAR	SHOMMIL	SHOMODY	SX	SHOMSYN	SHOMTRA	SHOMVA							
Cambia™ 2160 Series	H	COGN	C	N	MOCH	D	PINC	F						
Convera™	H	COGN	C	N	MOCH	D	PINC	F				
Invitation® 2110 Series	H	COGN	C	N	MOCH	D	PINC	F			
Laurus™ 2170 Series	H	COGN	C	N	MOCH	D	PINC	F		
Park Avenue Collection® 5000 Series	H	COGN	C	N	MOCH	D	PINC	F		
Pillow-Soft® 2190 Series	H	COGN	C	N	MOCH	D	PINC	F		
Riley™ Series	H	COGN	C	N	MOCH	D	PINC	F	
Versant™ Tandem Wood	H	COGN	C	N	MOCH	D	PINC	F	
2400 Series	H	COGN	C	N	MOCH		PINC	F		
6540 Series	H	COGN	C	N	MOCH		PINC	F	
6550 Series	H	COGN	C	N	MOCH		PINC	F

Note: Gathers and creases may be more visible with AI and OP fabrics due to the inherent design and construction of these fabrics.

* Fabric is de-emphasized.

ORDERING INFORMATION

VENEERS FOR 2110 SERIES — INVITATION® TABLES AND TABLE CONNECTORS

	CODES
Bourbon Cherry	H
Cognac	COGN
Harvest	C
Mahogany	N
Mocha	MOCH
Natural Maple	D
Pinnacle	PINC
Shaker Cherry	F

LAMINATES FOR VERSANT® TANDEM FREESTANDING TABLES

	CODES
Bourbon Cherry	H
Cognac	COGN
Harvest	C
Mahogany	N
Mocha	MOCH
Natural Maple	D
Pinnacle	PINC
Shaker Cherry	F

VENEERS FOR WGN SERIES — RILEY™ GANGING TABLES

	CODES
Bourbon Cherry	H
Cognac	COGN
Mahogany	N
Mocha	MOCH
Natural Maple	D
Pinnacle	PINC
Shaker Cherry	F

Standard Fabric Selections by Series with Price Code and Fabric Material		Model/Series	Wood Seating	
			Model/Series	Leather
4	SMHMBAR	Bar		
4	SMOBEE	Beeline		
4	SCFSBLP	Blip		
4	SMHMOIN	Coin		
4	SMOICOV	Cover Cloth		
4	SMOMCUR	Current		
4	SMOIDEC	Decode		
4	SMHMDCS	Disc		
4	SMHMDVD	Divide		
4	SMOPRE	Free		
4	SMOHAB	Habit		
4	SCFSHVE	Hive		
4	SMOMELP	Lineup		
4	SMHMAN	Hammer		
4	SMHMDM	Medium		
4	SMHGRM	Messenger		
4	SMHMET	Metric		
4	SMHOBQ	Oblique		
4	SMHPIC	Pick		
4	SCFSSPT	Sprint		
4	SMHTEC	Technic		
4	SMOMAMU	Amuse		
5	SMOMAVE	Avenue		
5	SMHMLRT	Lariat		
5	SCFSOUT	Outlander		
5	SCFSPK	Polka		
5	SCFSRID	Riddle		
5	SCFSSEN	Sentry-HC		
5	SCFSSEQ	Sequence		
5	SMOSOL	Solace		
5	SCFSTRB	Tribeca		
5	SMOMINT	Intermix II		
5	SMOMKEY	Keynote		
6	SCFSRAF	Raffia Vinyl		
6	SMOHVEL	Velocity		
6	WOL	Wooly		
7	SMOMASC	Ascend		
7	SMOMNTR	Central		
7	SMOMCHA	Channel		
7	SMOMAIN	Domain		
7	SMOMERG	Synergy		
7	SMOMWAV	Waver		
8	RS	Brisa® Polyurethane		
8	SMOMKIN	Kindred		
8	SCFSEOL	Eli Vinyl		
9	SCFSMT	Martin Vinyl		
9	SCFSOLM	Olympus Vinyl		
9	SMOMSL	Silica		
9	SMOMSLE	Silica Leather		
9	SMOMST	Silica Tech		
10	SCFSALF	Affinity		
10	SCFSCNC	Concentric		
10	SCFSJXY	Juxy		
11	SCFSACT	Acrobat		
11	SCFSNAT	Natural World		
11	SCFSWHL	Whirl		
12	SCFSFNT	Fenestra		
12	SCFSHLX	Helix		
12	SCFSLAV	Lava		
12	SCFSRIP	Ripple		
12	SS	Denver Leather		
L	SR	Leather		
				Cambia™ 2160 Series
				Convera™
				Invitation® 2110 Series
				Laurus™ 2170 Series
				Park Avenue Collection® 5000 Series
				Pillow-Soft® 2190 Series
				Riley™ Series
				Versant® Tandem Wood
				2400 Series
				6540 Series
				6550 Series

Note: Gathers and creases may be more visible with AI and OP fabrics due to the inherent design and construction of these fabrics.

FIRE CODE/COMPLIANT SEATING

FIRE SAFETY WITHOUT COMPROMISE

Elevate Fire Safety to a Higher Standard

- You asked for more seating choices that meet the CAL 133 standard. Here they are. Many of The HON Company's most popular chair models are now available in an array of fabrics that include an advanced barrier of fire protection. This barrier helps HON chairs comply with CAL 133 (California Technical Bulletin 133), the industry's most stringent test for fire-retardant furniture.

Definitive Protection

- The resilient filling materials used in upholstered seating manufactured by The HON Company meet or exceed the flame retardant requirements of the State of California, Department of Consumer Affairs, Bureau of Electronic and Home Appliance Repair, Home Furnishings and Thermal Insulation Technical Bulletin 117-2013. The label attached to the seat bottom indicates compliance with these requirements.
- For public buildings with at least 10 chairs in use, CAL 133 sets the bar as the accepted standard of fire safety. The CAL-TB 117-2013 standard referenced above evaluates the fire resistance of fabric, but only CAL 133 tests the entire assembled chair. Result: Greater assurance that your seating will not accelerate an actual fire.

How to Order

- To ensure that the chairs you order comply with CAL 133, specify one of the fabrics listed here on any of the seating models from the pages that follow. Then simply add "FC" to the model number when ordering.

SPECIFYING EXAMPLE: H7808FC.NR62.T.

A standard upcharge of \$90 will be applied per seat model for all single seat chairs.

For Lounge Seating, the following upcharges will apply: (Please note, the lounge upcharges do not apply to the Ignition® or Versant® seating lines. For these models, the \$90 per seat applies.)

Single Seat/Club Lounge: \$250 list

2-Seat/Love Seat Lounge: \$325 list

3-Seat/Sofa: \$400 list

MOISTURE BARRIER

- This extra layer of protection prevents moisture from penetrating the foam to improve cleanability and extend product longevity. Moisture barrier is available as an option for the seat only. The recliner gets moisture barrier on seat and footrest.
- Moisture barrier is not available for the fire code models.**

How to Order

- Fire Code:** To ensure that the chairs you order comply with CAL 133, specify one of the fabrics listed here on any of the seating models from the pages that follow. Then simply add "FC" to the model number when ordering.

SPECIFYING EXAMPLE: HHCG11FC.S.AI90.P6N.

- Moisture Barrier:** When specifying Moisture Barrier simply add "MB" to the model number when ordering.

SPECIFYING EXAMPLE: HHCG11MB.S.AI90.P6N.

Upcharges for Fire Code and Moisture Barrier on Soothe™ models

Model	Fire Code	Moisture Barrier
HHCG11	\$90	\$80
HHCG50	\$90	\$120
HHCG21	\$180	\$160
HHCGB21	\$180	\$160
HHCGB31	\$270	\$240
HHCP1	\$90	\$80
HHCR1	\$225	\$200

FIRE CODE/COMPLIANT SEATING

CAL 133 COMPLIANT FABRIC

GRADE 1

AB Confetti
AI Attire
BK Classic
COMP Compass
CU Centurion
EE Sierra Vinyl
NR Inertia
NT Tectonic
OP Optic
RI Stitchery
RO Arrondi *

GRADE 2

DOT Dotty
GO Gio *
HOP Sockhop
MOG Moguls
PE Esplanade *
PNS Appoint Seating
WP Whisper Vinyl

GRADE 3

SMOMKNC Knack
SX Silvertex™ Vinyl

GRADE 4

SMHMGRM Messenger
SMHMMAN Manner
SMHMMDM Medium
SMHMMET Metric

GRADE 8

RS Brisa®

GRADE L

SR Leather
SS Leather

Motivate®, Olson® and GuestStacker® shell chairs available in CAL 133 compliant color options as of June 2014. Please see matrix below.

SHELL COLOR	MOTIVATE®	OLSON® H4041	GUESTSTACKER® H4031
Onyx (ON)	X	X	X
Lava (LA)	X	X	X
Regatta (RE)	X	X	X
Mulberry (MB)	X	X	X
Shadow (SD)	X	X	
Platinum (PT)	X	X	
Lime (LM)	X	X	
Tangelo (RG)	X	X	
Surf (BU)	X	X	
Calypso (CP)	X	X	
Loft (LO)	X	X	
Cherry (CR)	X	X	
White (WT)	X	X	

Creases and gathers may be visible with CAL 133 Fire Code seating due to the construction of the fire barrier material used.

* Fabric is de-emphasized.

FIRE CODE/COMPLIANT SEATING

To ensure that the chairs you order comply with CAL 133, choose one of these seating fabrics with the seating models listed here. Then simply add "FC" to the model number when ordering as shown here: **HIWM2FC.A.H.M.CU10.T.SB. A standard upcharge of \$90 will be applied per seat. Example, HILTL has 3 seats @ \$90 per seat, \$270 upcharge.**

CAL 133 Compliant Seating

ALL MODELS INCLUDED IN THIS PROGRAM ARE LISTED BELOW.

Fabric Grade	1	1	1	1	1	1	1	1	1	1	1	2	2	2	2
Series/Model Numbers	Arrondi	Attire	Centurion	Classic	Compass	Confetti	Inertia	Optic	Sierra Vinyl	Stitchery	Tectonic	Appoint	Dotty	Esplanade	Gio
	RO *	AI	CU	BK	COMP	AB	NR	OP	EE	RI	NT	PNS	DOT	PE *	GO *
Accommodate™															
HSGS6FC, HSGS6DFFC, HSCS1FC	*	*	*	*	*	*	*	*	*	*	*	*	*	*	*
HSCS1DFFC, HSCS2FC, HSCS2DFFC	*	*	*	*	*	*	*	*	*	*	*	*	*	*	*
HSB50FC, HSB50DFFC	*	*	*	*	*	*	*	*	*	*	*	*	*	*	*
Cambia™															
H2153FC @ H2155FC @ H2163FC @	*	*	*	*	*	*	*	*	*	*	*	*	*	*	*
H2164FC, H2165FC, H2166FC @	*	*	*	*	*	*	*	*	*	*	*	*	*	*	*
Ceres®															
HCW1FC, HCG6FC	*	*	*	*	*	*	*	*	*	*	*	*	*	*	*
ComfortTask®															
H5901FC, H5902FC, H5903FC	*	*	*	*	*	*	*	*	*	*	*	*	*	*	*
H5905FC	*	*	*	*	*	*	*	*	*	*	*	*	*	*	*
Convera™ Lounge															
HDAC01FC, HDAA01FC, HDAL02FC	*	*	*	*	*	*	*	*	*	*	*	*	*	*	*
HDAC11FC @, HDAA11FC @, HDAL12FC @	*	*	*	*	*	*	*	*	*	*	*	*	*	*	*
Endorse™															
HLEUFC, HLWMFC, HLTMFC	*	*	*	*	*	*	*	*	*	*	*	*	*	*	*
HLWMBTFC, HLTMFC	*	*	*	*	*	*	*	*	*	*	*	*	*	*	*
HL1SLFC, HL2SLFC, HL3SLFC	*	*	*	*	*	*	*	*	*	*	*	*	*	*	*
HLWUFC, HLTUFC, HLTUFC	*	*	*	*	*	*	*	*	*	*	*	*	*	*	*
HLWUBTFC, HLEUBTFC, HLTSUFC	*	*	*	*	*	*	*	*	*	*	*	*	*	*	*
HLTSPFC	*	*	*	*	*	*	*	*	*	*	*	*	*	*	*
Flock® Seating															
HFLSC1FC, HFLMC1FC, HFLML1FC	*	*	*	*	*	*	*	*	*	*	*	*	*	*	*
HFLMR1FC, HFLS01FC	*	*	*	*	*	*	*	*	*	*	*	*	*	*	*
Gamut®															
H2071FC, H2072FC	*	*	*	*	*	*	*	*	*	*	*	*	*	*	*
H2073FC	*	*	*	*	*	*	*	*	*	*	*	*	*	*	*
Grove™															
HML1SFC, HML1SDFFC, HML2SFC	*	*	*	*	*	*	*	*	*	*	*	*	*	*	*
HML2SDFFC, HML3SFC, HML3SDFFC	*	*	*	*	*	*	*	*	*	*	*	*	*	*	*
HML2STFC, HML2STDFFC	*	*	*	*	*	*	*	*	*	*	*	*	*	*	*
Ignition® Seating															
HIEH1FC, HIEH2FC, HIEH3FC	*	*	*	*	*	*	*	*	*	*	*	*	*	*	*
HIEH4FC, HIWM1FC, HIWM2FC	*	*	*	*	*	*	*	*	*	*	*	*	*	*	*
HIWM3FC, HIWM4FC, HIWM8FC	*	*	*	*	*	*	*	*	*	*	*	*	*	*	*
HITL1FC, HITL2FC, HITL3FC	*	*	*	*	*	*	*	*	*	*	*	*	*	*	*
HITL4FC, HITS5FC, HIGCLFC	*	*	*	*	*	*	*	*	*	*	*	*	*	*	*
HIGS6FC, HISB6FC, HICS7FC	*	*	*	*	*	*	*	*	*	*	*	*	*	*	*
HIL2LFC, HIB50FC, HIHCF	*	*	*	*	*	*	*	*	*	*	*	*	*	*	*
HILTFC	*	*	*	*	*	*	*	*	*	*	*	*	*	*	*
HITLMFC, HIWMMFC, HITSMFC	*	*	*	*	*	*	*	*	*	*	*	*	*	*	*
Invitation®															
H211FC, H2112FC	*	*	*	*	*	*	*	*	*	*	*	*	*	*	*
Invitation® Lounge															
HFAA01FC, HFAL02FC, HFAS03FC	*	*	*	*	*	*	*	*	*	*	*	*	*	*	*
Laurus™															
H217FC, H2172FC	*	*	*	*	*	*	*	*	*	*	*	*	*	*	*
Motivate®															
HMG2FC, HMG7FC, HMG2FC	*	*	*	*	*	*	*	*	*	*	*	*	*	*	*
HMN2FC, HMNT2FC, HMS2FC	*	*	*	*	*	*	*	*	*	*	*	*	*	*	*
HMT1FC, HMT5FC	*	*	*	*	*	*	*	*	*	*	*	*	*	*	*
HMN1FC (Fire Code Lava shell only)															
HMNT1FC (Fire Code Lava shell only)															

* Fabric is de-emphasized.

Ⓢ Product scheduled for discontinuation.

FIRE CODE/COMPLIANT SEATING

To ensure that the chairs you order comply with CAL 133, choose one of these seating fabrics with the seating models listed here. Then simply add "FC" to the model number when ordering as shown here: **HIWM2FC.A.H.M.CU10.T.SB. A standard upcharge of \$90 will be applied per seat. Example, HILTL has 3 seats @ \$90 per seat, \$270 upcharge.**
CAL 133 Compliant Seating **ALL MODELS INCLUDED IN THIS PROGRAM ARE LISTED BELOW.**

2	2	2	3	3	L	L	4	4	4	4	8	Fabric Grade
Moguls	Sockhop	Whisper Vinyl	Knack	Silvertex Vinyl	Leather	Leather	Manner	Medium	Messenger	Metric	Brisa	Series/Model Numbers
MOG	HOP	WP	SMOMKNC	SX	SR	SS	SMHMMAN	SMHMMDM	SMHMGRM	SMHMMET	RS	
												Accommodate™
*	*	*	*	*		*	*	*	*	*	*	HSGS6FC, HSGS6DFFC, HSCS1FC
*	*	*	*	*		*	*	*	*	*	*	HSCS1DFFC, HSCS2FC, HSCS2DFFC
*	*	*	*	*		*	*	*	*	*	*	HSB50FC, HSB50DFFC
												Cambia™
*	*	*	*	*		*	*	*	*	*	*	H2153FC @ H2155FC @ H2163FC @
*	*	*	*	*		*	*	*	*	*	*	H2164FC, H2165FC, H2166FC @
												Ceres®
*	*	*	*	*		*	*	*	*	*	*	HCW1FC, HCG6FC
												ComforTask®
*	*	*	*	*		*	*	*	*	*	*	H5901FC, H5902FC, H5903FC
*	*	*	*	*		*	*	*	*	*	*	H5905FC
												Convera™ Lounge
*	*	*	*	*		*	*	*	*	*	*	HDAC01FC, HDAA01FC, HDAL02FC
*	*	*	*	*		*	*	*	*	*	*	HDAC11FC @ HDAAT1FC @ HDAL12FC @
												Endorse™
*	*	*	*	*		*	*	*	*	*	*	HLEUFC, HLWMFC, HLTMFC
*	*	*	*	*		*	*	*	*	*	*	HLWMBTFC, HLTMFC
*	*	*	*	*		*	*	*	*	*	*	HL1SLFC, HL2SLFC, HL3SLFC
*	*	*	*	*		*	*	*	*	*	*	HLWUFC, HLTUFC, HLTDFC
*	*	*	*	*		*	*	*	*	*	*	HLWUBTFC, HLEUBTFC, HLTSUFC
*	*	*	*	*		*	*	*	*	*	*	HLTSPFC
												Flock® Seating
*	*	*	*	*		*	*	*	*	*	*	HFLSC1FC, HFLMC1FC, HFLML1FC
*	*	*	*	*		*	*	*	*	*	*	HFLMR1FC, HFLSO1FC
												Gamut®
*	*	*	*	*		*	*	*	*	*	*	H2071FC, H2072FC
*	*	*	*	*		*	*	*	*	*	*	H2073FC
												Grove™
*	*	*	*	*		*	*	*	*	*	*	HML1SFC, HML1SDFFC, HML2SFC
*	*	*	*	*		*	*	*	*	*	*	HML2SDFFC, HML3SFC, HML3SDFFC
*	*	*	*	*		*	*	*	*	*	*	HML2STFC, HML2STDFFC
												Ignition® Seating
*	*	*	*	*		*	*	*	*	*	*	HIEH1FC, HIEH2FC, HIEH3FC
*	*	*	*	*		*	*	*	*	*	*	HIEH4FC, HIWM1FC, HIWM2FC
*	*	*	*	*		*	*	*	*	*	*	HIWM3FC, HIWM4FC, HIWM8FC
*	*	*	*	*		*	*	*	*	*	*	HITL1FC, HITL2FC, HITL3FC
*	*	*	*	*		*	*	*	*	*	*	HITL4FC, HITS5FC, HIGCLFC
*	*	*	*	*		*	*	*	*	*	*	HIGS6FC, HIBS6FC, HICS7FC
*	*	*	*	*		*	*	*	*	*	*	HIL2LFC, HIBS0FC, HHCFC
*	*	*	*	*		*	*	*	*	*	*	HILTFC
*	*	*	*	*		*	*	*	*	*	*	HITLMFC, HIWMMFC, HITSMFC
												Invitation®
*	*	*	*	*		*	*	*	*	*	*	H2111FC, H2112FC
												Invitation® Lounge
*	*	*	*	*		*	*	*	*	*	*	HFAA01FC, HFAL02FC, HFAS03FC
												Laurus™
*	*	*	*	*		*	*	*	*	*	*	H2171FC, H2172FC
												Motivate®
*	*	*	*	*		*	*	*	*	*	*	HMG2FC, HMG7FC, HMG2FC
*	*	*	*	*		*	*	*	*	*	*	HMN2FC, HMNT2FC, HMS2FC
*	*	*	*	*		*	*	*	*	*	*	HMT1FC, HMT5FC
												HMN1FC (Fire Code Lava shell only)
												HMNT1FC (Fire Code Lava shell only)

FIRE CODE/COMPLIANT SEATING

To ensure that the chairs you order comply with CAL 133, choose one of these seating fabrics with the seating models listed here. Then simply add "FC" to the model number when ordering as shown here: **HIWM2FC.A.H.M.CU10.T.SB. A standard upcharge of \$90 will be applied per seat. Example, HILTL has 3 seats @ \$90 per seat, \$270 upcharge.**

CAL 133 Compliant Seating

ALL MODELS INCLUDED IN THIS PROGRAM ARE LISTED BELOW.

Fabric Grade	1	1	1	1	1	1	1	1	1	1	1	2	2	2	2
Series/Model Numbers	Arrondi	Attire	Centurion	Classic	Compass	Confetti	Inertia	Optic	Sierra Vinyl	Stitchery	Tectonic	Appoint	Dotty	Esplanade	Gio
	RO *	AI	CU	BK	COMP	AB	NR	OP	EE	RI	NT	PNS	DOT	PE *	GO *
Nucleus® Seating															
HN1FC, HN6FC, HN7FC	*	*	*	*	*	*	*	*	*	*	*	*	*	*	*
Pagoda®															
H4071FC, H4073FC, H4075FC	*	*	*	*	*	*	*	*	*	*	*	*	*	*	*
H4077FC, H4079FC, H4091FC	*	*	*	*	*	*	*	*	*	*	*	*	*	*	*
H4093FC, H4095FC, H4097FC	*	*	*	*	*	*	*	*	*	*	*	*	*	*	*
H4099FC	*	*	*	*	*	*	*	*	*	*	*	*	*	*	*
Park Avenue Collection®															
H5001FC, H5002FC			*	*	*	*	*	*	*	*	*	*	*	*	*
H5021FC, H5022FC			*	*	*	*	*	*	*	*	*	*	*	*	*
H5003FC, H5023FC			*	*	*	*	*	*	*	*	*	*	*	*	*
Perpetual® Nesting Chairs															
HPN1FC, HPN2FC	*	*	*	*	*	*	*	*	*	*	*	*	*	*	*
Pillow-Soft®															
H2091FC, H2092FC, H2191FC	*	*	*	*	*	*	*	*	*	*	*	*	*	*	*
H2192FC	*	*	*	*	*	*	*	*	*	*	*	*	*	*	*
H2093FC, H2194FC	*	*	*	*	*	*	*	*	*	*	*	*	*	*	*
Purpose®															
HRI1FC, HRISFC, HRIWFC			*	*	*	*	*	*	*	*	*	*	*	*	*
HR5PFC, HR5SFC, HR5WFC			*	*	*	*	*	*	*	*	*	*	*	*	*
Quotient™															
HQTM1FC, HQTM2FC	*	*	*	*	*	*	*	*	*	*	*	*	*	*	*
Riley™															
HWGN1FC, HWGN2FC, HWGN3FC	*	*	*	*	*	*	*	*	*	*	*	*	*	*	*
HWGN4FC, HWGN5FC, HWGN1BFC	*	*	*	*	*	*	*	*	*	*	*	*	*	*	*
HWGN2BFC, HWGN3BFC	*	*	*	*	*	*	*	*	*	*	*	*	*	*	*
HWGN4BFC, HWGN5BFC	*	*	*	*	*	*	*	*	*	*	*	*	*	*	*
Solutions Seating®															
H4001FC, H4002FC	*	*	*	*	*	*	*	*	*	*	*	*	*	*	*
H4003FC, H4008FC	*	*	*	*	*	*	*	*	*	*	*	*	*	*	*
Solve™															
HSLVTMMFC, HSLVSMFC	*	*	*	*	*	*	*	*	*	*	*	*	*	*	*
Soothe™															
HHCG1FC, HHCG50FC, HHCG21FC	*	*	*	*	*	*	*	*	*	*	*	*	*	*	*
HHGB21FC, HHGB31FC	*	*	*	*	*	*	*	*	*	*	*	*	*	*	*
HHCP1FC, HHCR1FC, HHCR1CLFC															
Versant®															
HHCT01FC, HHCT12FC, HHCT02FC	*	*	*	*	*	*	*	*	*	*	*	*	*	*	*
HHCB50FC, HHB02FC, HHB03FC	*	*	*	*	*	*	*	*	*	*	*	*	*	*	*
2400 Series															
H2403FC	*	*	*	*	*	*	*	*	*	*	*	*	*	*	*
7800 Series Seating															
H7803FC, H7808FC, H7823FC	*	*	*	*	*	*	*	*	*	*	*	*	*	*	*
H7828FC	*	*	*	*	*	*	*	*	*	*	*	*	*	*	*

* Fabric is de-emphasized.

FIRE CODE/COMPLIANT SEATING

To ensure that the chairs you order comply with CAL 133, choose one of these seating fabrics with the seating models listed here. Then simply add "FC" to the model number when ordering as shown here: **HIWM2FC.A.H.M.CU10.T.SB. A standard upcharge of \$90 will be applied per seat. Example, HILTL has 3 seats @ \$90 per seat, \$270 upcharge.**
CAL 133 Compliant Seating **ALL MODELS INCLUDED IN THIS PROGRAM ARE LISTED BELOW.**

2	2	2	3	3	L	L	4	4	4	4	8	Fabric Grade
Moguls	Sockhop	Whisper Vinyl	Knack	Silvertex Vinyl	Leather	Leather	Manner	Medium	Messenger	Metric	Brisa	Series/Model Numbers
MOG	HOP	WP	SMOMKNC	SX	SR	SS	SMHMMAN	SMHMDM	SMHMGRM	SMHMMET	RS	
												Nucleus® Seating
*	*	*	*	*		*	*	*	*	*	*	HN1FC, HN6FC, HN7FC
												Pagoda®
*	*	*	*	*			*	*	*	*	*	H4071FC, H4073FC, H4075FC
*	*	*	*	*			*	*	*	*	*	H4077FC, H4079FC, H4091FC
*	*	*	*	*			*	*	*	*	*	H4093FC, H4095FC, H4097FC
*	*	*	*	*			*	*	*	*	*	H4099FC
												Park Avenue Collection®
*	*		*			*						H5001FC, H5002FC
*	*		*			*						H5021FC, H5022FC
*	*	*	*	*		*	*	*	*	*	*	H5003FC, H5023FC
												Perpetual® Nesting Chairs
*	*	*	*	*			*	*	*	*	*	HPN1FC, HPN2FC
												Pillow-Soft®
*	*		*			*						H2091FC, H2092FC, H2191FC
*	*		*			*						H2192FC
*	*	*	*	*	*	*	*	*	*	*	*	H2093FC, H2194FC
												Purpose®
				*								HR1PFC, HR1SFC, HR1WFC
				*								HR5PFC, HR5SFC, HR5WFC
												Quotient™
*	*	*	*	*		*	*	*	*	*	*	HQTMMFC, HQTSMFC
												Riley™
*	*	*	*	*		*	*	*	*	*	*	HWGN1FC, HWGN2FC, HWGN3FC
*	*	*	*	*		*	*	*	*	*	*	HWGN4FC, HWGN5FC, HWGN1BFC
*	*	*	*	*		*	*	*	*	*	*	HWGN2BFC, HWGN3BFC
*	*	*	*	*		*	*	*	*	*	*	HWGN4BFC, HWGN5BFC
												Solutions Seating®
*	*		*				*	*	*	*	*	H4001FC, H4002FC
*	*	*	*	*			*	*	*	*	*	H4003FC, H4008FC
												Solve™
*	*	*	*	*		*	*	*	*	*	*	HSLVTMMFC, HSLVSMFC
												Soothe™
*	*	*	*	*		*	*	*	*	*	*	HHCG11FC, HHCG50FC, HHCG21FC
*	*	*	*	*		*	*	*	*	*	*	HHCB21FC, HHCB31FC
				*								HHCP1FC, HHCR1FC, HHCR1CLFC
												Versant®
*	*	*	*	*		*	*	*	*	*	*	HHCT01FC, HHCT12FC, HHCT02FC
*	*	*	*	*		*	*	*	*	*	*	HHCB50FC, HHB02FC, HHB03FC
												2400 Series
*	*	*	*	*		*	*	*	*	*	*	H2403FC
												7800 Series Seating
*	*	*	*	*		*	*	*	*	*	*	H7803FC, H7808FC, H7823FC
*	*	*	*	*		*	*	*	*	*	*	H7828FC

ACCOMMODATE™



Accommodate Guest Chairs shown with Arrange™ Table.

ACCOMMODATE™

The key to designing a collaborative environment is to support productivity throughout the space. From waiting areas and cafés to meeting spaces and offices, Accommodate creates opportunities for people to get work done in a comfortable, casual setting. Cluster together. Form neat rows. Stack four high. With guest and bariatric chairs, as well as café and counter-height stools, Accommodate brings greater comfort, versatility and continuity throughout your space with a seating collection that adapts to your environment, people and budget.



FEATURES

- Thin profile seat cushion conforms to your body.
- Contoured back ergonomically supports the spine.
- Chairs can stack up to four high.
- Chairs can gang together to form neat rows.
- Waterfall seat edge enhances leg circulation.
- Lightweight frame is easy to move.
- Nylon glides slide effortlessly on hard surfaces.
- Tube rolled steel frame adds durability.
- Wall-saver design protects walls and cabinets.
- Warranted for users up to 300 lbs. (Models HSB50 and HSB50DF are warranted for users up to 500 lbs.)

ACCOMMODATE™ Options

MODEL OPTIONS

HSGS6
HSGS6DF - Dual Fabric



Guest Chair

HSCS1
HSCS1DF - Dual Fabric



Counter-Height Stool

HSCS2
HSCS2DF - Dual Fabric



Café-Height Stool

HSB50
HSB50DF - Dual Fabric

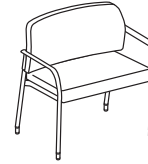

Bariatric Chair

ARM STYLE

CODE	DESCRIPTION	PRICE
N	Armless	+\$0
F	Fixed Arms	+\$30



FRAME

CODE	DESCRIPTION	PRICE
P6N	Textured Satin Chrome	+\$0
BLCK	Textured Black	+\$0



CASTERS/ GLIDES

CODE	DESCRIPTION	PRICE
E	Standard Nylon Glide	+\$0
H	Hard Caster	+\$0
S	Soft Caster	+\$20
B	Both Hard Casters and Standard Nylon Glides	+\$20



**Options H, S & B available for HSGS6 and HSGS6DF models only*

ACCOMMODATE™

Fabric Options

AVAILABLE FABRICS

GRADE 1	GRADE 2	GRADE 3	GRADE 4	GRADE 5	GRADE 6	GRADE 7	GRADE 8	GRADE 9	GRADE 10	GRADE 11	GRADE 12	GRADE L
Arrondi *	Appoint	Canter	Bar	Amuse	Intermix II	Ascend	Brisa®	Eli Vinyl	Affinity	Acrobat	Fenestra	Denver
Attire	Seating	Polyurethane	Beeline	Avenue	Keynote	Central	Polyurethane	Martini Vinyl	Concentric	Natural	Helix	Leather
Centurion	Bangle	Epic	Blip	Lariat	Raffia Vinyl	Channel	Kindred	Olympus	Juxy	World	Lava	(Matches
Classic	Clyde	Infinity	Coin	Outlander	Velocity	Domain		Vinyl		Whirl	Ripple	EE Vinyl)
Compass	Dotty	Knack	Cover Cloth	Polka	Wooly	Synergy		Silica				
Confetti	Esplanade *	Marathon	Current	Riddle		Waver		Silica Leather				
Contourette	Expo	Millennium	Decode	Sentry-HC				Silica Tech				
Polyurethane	Fuse	Odyssey	Disc	Sequence								
Dapper	Gio *	Silvertext™	Divide	Solace								
Inertia	Moguls	Vinyl	Free	Tribeca								
Optic	Origin	Syntax	Habit									
Stitchery	Seed	Tradition	Hive									
Tectonic	Sockhop	Via	Lineup									
	Spin Seating		Manner									
	Whisper		Medium									
	Vinyl		Messenger									
			Metric									
			Oblique									
			Pick									
			Sprint									
			Technic									

Reference Fabric Color Combinations on pages 18-29 for color codes and legend on page 19 for lead times. Visit hon.com for additional partnership fabrics.

NOTES: Gathers and creases may be more visible with Attire (AI) and Optic (OP) fabrics due to the inherent design and construction of these fabrics.

🔥 For Fire Code model, availability and ordering method, refer to pages 34-39. Available on select models, contact HON Customer Support for availability.

* Fabric is de-emphasized.



ACCOMMODATE™

HSGS6

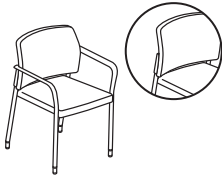

GUEST CHAIR

Set of Two Guest Chairs

DIMENSIONS

Depth:	22¼	Seat to Floor Height:	18¼
Height:	31½	Usable Seat Depth:	17
Seat Depth:	20¾	Ship Weight (with arms):	50
Seat Width:	17½	Ship Weight (armless):	48
Back Width:	19¾	Cube (with arms):	15.8
Back Height:	16¼	Cube (armless):	15.8
Width (with arms):	23½	COM (with arms):	2.0
Width (armless):	19¾	COM (armless):	2.0
Arm Width:	20¼	Weight Rating:	300 lbs.

FABRIC PRICE CODES

1	\$690	8	\$1104
2	\$762	9	\$1158
3	\$834	10	\$1212
4	\$888	11	\$1266
5	\$942	12	\$1320
6	\$996	L	—
7	\$1050		

NOTES: For Ganging Brackets see page 46. Accommodate™ Guest Chairs stack 4-high.

HSCS1

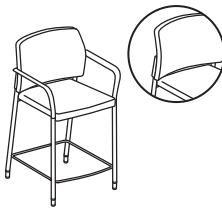

COUNTER-HEIGHT STOOL

DIMENSIONS

Depth:	23½	Seat to Floor Height:	25½
Height:	38¾	Usable Seat Depth:	17
Seat Depth:	20¾	Ship Weight (with arms):	36
Seat Width:	17½	Ship Weight (armless):	35
Back Width:	19¾	Cube (with arms):	15.8
Back Height:	16¼	Cube (armless):	15.8
Width (with arms):	23½	COM (with arms):	2.0
Width (armless):	19¾	COM (armless):	2.0
Arm Width:	20¼	Weight Rating:	300 lbs.

FABRIC PRICE CODES

1	\$410	8	\$617
2	\$446	9	\$644
3	\$482	10	\$671
4	\$509	11	\$698
5	\$536	12	\$725
6	\$563	L	—
7	\$590		

HON Recommendation: HSGS6.N.E.CU__P6N - List Price \$690

HOW TO SPECIFY

Select Model Number	Select Arm Type	Select Caster/Glide	Select Fabric	Select Frame
	N Armless F Fixed Arms (+ \$30 per chair)	E Standard Nylon Glide H Hard Caster S Soft Caster (+ \$20 per chair) B Both Hard Casters and Standard Nylon Glides (+ \$20 per chair) <i>Options H, S & B available for HSGS6 model only</i>	See page 42	P6N Textured Satin Chrome BLCK Textured Black
H S G S 6 .	N .	E .	C U 1 0 .	P 6 N

ACCOMMODATE™



Icon Legend on page 14

HSCS2

CAFÉ-HEIGHT STOOL

DIMENSIONS

Depth:	24½	Seat to Floor Height:	31½
Height:	44¾	Usable Seat Depth:	17
Seat Depth:	20¾	Ship Weight (with arms):	38
Seat Width:	17½	Ship Weight (armless):	37
Back Width:	19¾	Cube (with arms):	19.1
Back Height:	16¼	Cube (armless):	19.1
Width (with arms):	23½	COM (with arms):	2.0
Width (armless):	19¾	COM (armless):	2.0
Arm Width:	20¼	Weight Rating:	300 lbs.

FABRIC PRICE CODES

1	\$450	8	\$657
2	\$486	9	\$684
3	\$522	10	\$711
4	\$549	11	\$738
5	\$576	12	\$765
6	\$603	L	—
7	\$630		



HSB50

BARIATRIC CHAIR

DIMENSIONS

Depth:	21½	Seat to Floor Height:	19
Height:	32½	Usable Seat Depth:	16¾
Seat Depth:	20¼	Ship Weight (with arms):	50
Seat Width:	28	Ship Weight (armless):	49
Back Width:	29	Cube (with arms):	27.2
Back Height:	16½	Cube (armless):	27.2
Width (with arms):	33½	COM (with arms):	2.0
Width (armless):	30	COM (armless):	2.0
Arm Width:	30	Weight Rating:	500 lbs.

FABRIC PRICE CODES

1	\$725	8	\$1001
2	\$773	9	\$1037
3	\$821	10	\$1073
4	\$857	11	\$1109
5	\$893	12	\$1145
6	\$929	L	—
7	\$965		

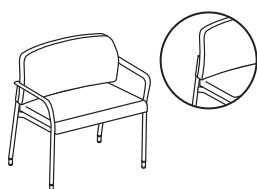

HON Recommendation: HSCS2.N.E.CU__P6N - List Price \$450

HOW TO SPECIFY

Select Model Number

H S C S 2 .

Select Arm Type

- N** Armless
- F** Fixed Arms (+ \$30 per chair)

N .

Select Caster/Glide

- E** Standard Nylon Glide
- H** Hard Caster
- S** Soft Caster (+ \$20 per chair)
- B** Both Hard Casters and Standard Nylon Glides (+ \$20 per chair)

E .

Select Fabric

See page 42

C U 1 0 .

Select Frame

- P6N** Textured Satin Chrome
- BLCK** Textured Black

P 6 N



Icon Legend on page 14

ACCOMMODATE™

HSGS6DF

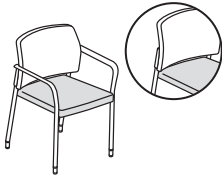

GUEST CHAIR

Dual Fabric
Set of Two Guest Chairs

DIMENSIONS

Depth:	22¼	Seat to Floor Height:	18¾
Height:	31½	Usable Seat Depth:	17
Seat Depth:	20¾	Ship Weight (with arms):	50
Seat Width:	17½	Ship Weight (armless):	48
Back Width:	19¾	Cube (with arms):	15.8
Back Height:	16¼	Cube (armless):	15.8
Width (with arms):	23½	COM (with arms):	2.0
Width (armless):	19¾	COM (armless):	2.0
Arm Width:	20¼	Weight Rating:	300 lbs.

FABRIC PRICE CODES

1	\$840	
<i>Add to Base Price Above</i>		
	Back	Seat
2	\$36	\$36
3	\$72	\$72
4	\$99	\$99
5	\$126	\$126
6	\$153	\$153
7	\$180	\$180
8	\$207	\$207
9	\$234	\$234
10	\$261	\$261
11	\$288	\$288
12	\$315	\$315

NOTES: For Ganging Brackets see page 46. Accommodate™ Guest Chairs stack 4-high.

HSCS1DF

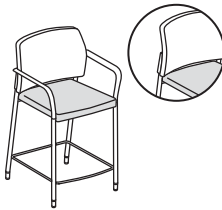

COUNTER-HEIGHT STOOL

Dual Fabric

DIMENSIONS

Depth:	23½	Seat to Floor Height:	25½
Height:	38¾	Usable Seat Depth:	17
Seat Depth:	20¾	Ship Weight (with arms):	36
Seat Width:	17½	Ship Weight (armless):	35
Back Width:	19¾	Cube (with arms):	15.8
Back Height:	16¼	Cube (armless):	15.8
Width (with arms):	23½	COM (with arms):	2.0
Width (armless):	19¾	COM (armless):	2.0
Arm Width:	20¼	Weight Rating:	300 lbs.

FABRIC PRICE CODES

1	\$485	
<i>Add to Base Price Above</i>		
	Back	Seat
2	\$18	\$18
3	\$36	\$36
4	\$50	\$50
5	\$63	\$63
6	\$77	\$77
7	\$90	\$90
8	\$104	\$104
9	\$117	\$117
10	\$131	\$131
11	\$144	\$144
12	\$158	\$158

HON Recommendation: HSGS6DF.N.E.CU__CU__P6N - List Price \$840

HOW TO SPECIFY

Select Model Number	Select Arm Type	Select Caster/Glide	Select Back Fabric	Select Seat Fabric	Select Frame
	N Armless F Fixed Arms (+ \$30 per chair)	E Standard Nylon Glide H Hard Caster S Soft Caster (+ \$20 per chair) B Both Hard Casters and Standard Nylon Glides (+ \$20 per chair) <i>Options H, S & B available for HSGS6DF model only</i>	See page 42	See page 42	P6N Textured Satin Chrome BLCK Textured Black
H S G S 6 D F .	N .	E .	C U 2 2 .	C U 1 0 .	P 6 N

ACCOMMODATE™



Icon Legend on page 14

HSCS2DF

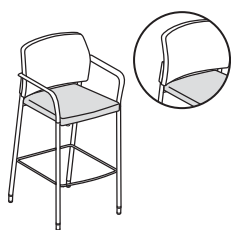

CAFÉ-HEIGHT STOOL

Dual Fabric

DIMENSIONS

Depth:	24½	Seat to Floor Height:	31½
Height:	44¾	Usable Seat Depth:	17
Seat Depth:	20¾	Ship Weight (with arms):	38
Seat Width:	17½	Ship Weight (armless):	37
Back Width:	19¾	Cube (with arms):	19.1
Back Height:	16¼	Cube (armless):	19.1
Width (with arms):	23½	COM (with arms):	2.0
Width (armless):	19¾	COM (armless):	2.0
Arm Width:	20¼	Weight Rating:	300 lbs.

FABRIC PRICE CODES

1 \$525

Add to Base Price Above

	Back	Seat
2	\$18	\$18
3	\$36	\$36
4	\$50	\$50
5	\$63	\$63
6	\$77	\$77
7	\$90	\$90
8	\$104	\$104
9	\$117	\$117
10	\$131	\$131
11	\$144	\$144
12	\$158	\$158

HSB50DF

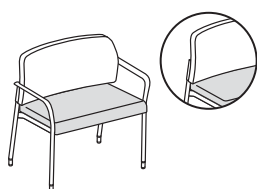

BIARIATRIC CHAIR

Dual Fabric

DIMENSIONS

Depth:	21½	Seat to Floor Height:	19
Height:	32½	Usable Seat Depth:	16¾
Seat Depth:	20¼	Ship Weight (with arms):	50
Seat Width:	28	Ship Weight (armless):	49
Back Width:	29	Cube (with arms):	27.2
Back Height:	16½	Cube (armless):	27.2
Width (with arms):	33½	COM (with arms):	2.0
Width (armless):	30	COM (armless):	2.0
Arm Width:	30	Weight Rating:	500 lbs.

FABRIC PRICE CODES

1 \$800

Add to Base Price Above

	Back	Seat
2	\$24	\$24
3	\$48	\$48
4	\$66	\$66
5	\$84	\$84
6	\$102	\$102
7	\$120	\$120
8	\$138	\$138
9	\$156	\$156
10	\$174	\$174
11	\$192	\$192
12	\$210	\$210

HSGANG

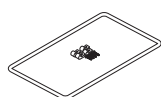

GANGING BRACKET

(hardware included)

DIMENSIONS

Ship Weight: 5 Ⓞ

LIST PRICE

\$30

NOTES: For use on models HSGS6 and HSGS6DF.

i No specification required for bracket. The ganging bracket is only available in black. The ganging bracket does not work on the bariatric unit.

HON Recommendation: HSCS2DF.N.E.CU__CU__P6N - List Price \$525

HOW TO SPECIFY

Select Model Number	Select Arm Type	Select Caster/Glide	Select Back Fabric	Select Seat Fabric	Select Frame
HSCS2DF.	N Armless F Fixed Arms (+ \$30)	E Standard Nylon Glide	See page 42	See page 42	P6N Textured Satin Chrome BLCK Textured Black
HSCS2DF.	N.	E.	CU22.	CU10.	P6N



Icon Legend on page 14

ADJUSTABLE TASK/LAB Stools

HMTS01



TASK/LAB STOOL

without Back
 Pneumatic
 Swivel
 Functions: **A, E**
 (Function Key on pages 16-17)

DIMENSIONS

Depth:	27¼	Seat to Floor Height:	17¾-22
Width:	24⅞	Usable Seat Depth:	16
Height:	17¾-22	Ship Weight:	22 Ⓢ
Seat:	16" Dia.	Cube:	2.5
		Weight Rating:	250 lbs.

FABRIC PRICE CODE

1 \$278

NOTES: EA vinyl is a healthcare covering that meets AATCC Test Method 147-2004.
 ⓘ Available in polished base ONLY. Available in Grade 1, Black, EA11 fabric ONLY.

HMTS11

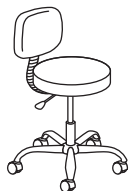

TASK/LAB STOOL

with Back
 Pneumatic
 Back Height
 Seat Depth
 Swivel
 Functions: **A, B, C, E**
 (Function Key on pages 16-17)

DIMENSIONS

Depth:	27¼	Seat to Floor Height:	17¾-22
Width:	24⅞	Usable Seat Depth:	14¾-16
Height:	31½-38	Ship Weight:	29 Ⓢ
Seat:	16" Dia.	Cube:	2.7
Back Width:	15½	Weight Rating:	250 lbs.
Back Height:	8¾-16		

FABRIC PRICE CODE

1 \$371

NOTES: EA vinyl is a healthcare covering that meets AATCC Test Method 147-2004.
 ⓘ Available in polished base ONLY. Available in Grade 1, Black, EA11 fabric ONLY.

HOW TO SPECIFY

Select Model Number	Select Fabric
	EA11 Black, Grade 1 (only)
HMTS01.	EA11

BODA™



Shown with 10500 Series™ desks.

BODA™

Look cool. Stay cool. Boda task chairs rely on breathable mesh that increases airflow to prevent hot spots and maximize comfort. Each high-back task chair features a mesh back with a choice of mesh seat or upholstered seat for maximum comfort. To take the comfort to an even higher level, the 2-to-1 synchro-tilt recline control provides a stable, comfortable ride, making it perfect for executive offices and meeting spaces.



FEATURES

- Breathable mesh back delivers all-day comfort.
- Mesh seat option is breathable and offers all-day support.
- Upholstered seat option includes ample foam cushioning.
- Responsive synchro-tilt control provides a smooth, natural recline.
- Arms move up or down for shoulder and upper body support.
- Tilt tension controls the rate and ease of recline.
- Tilt lock allows the user to lock out the tilt function.
- One-touch seat height adjustment easily moves the seat up and down.
- 360-degree swivel provides freedom of movement in any direction.
- Warranted for users up to 250 lbs.



HMH01



TASK CHAIR

High-back
 Pneumatic
 Synchro-tilt
 Tilt Tension
 Tilt Lock
 Height-adjustable Arms
 Mesh Sandwich Fabric Seat and Mesh Back

DIMENSIONS

Depth:	35½	Arm Width:	19¼
Width:	27¾	Seat to Floor Height:	18¼-22½
Height:	44	Usable Seat Depth:	17⅞
Seat Depth:	17⅞	Ship Weight:	43 Ⓢ
Seat Width:	20¾	Cube:	5.1
Back Width:	19¾	Weight Rating:	250 lbs.
Back Height:	24¼		

LIST PRICE

\$701

Functions: **A, E, J, K, L, Q**
 (Function Key on pages 16-17)

NOTES: Model HMH01 available with Black Mesh back and Black Sandwich Mesh fabric seat.
 ⓘ Titanium frame only available on both models.

HMH02



TASK CHAIR

High-back
 Pneumatic
 Synchro-tilt
 Tilt Tension
 Tilt Lock
 Height-adjustable Arms
 Mesh Seat and Back

DIMENSIONS

Depth:	35½	Arm Width:	17½
Width:	27	Seat to Floor Height:	18½-22¾
Height:	44¼	Usable Seat Depth:	18¼
Seat Depth:	18¼	Ship Weight:	44 Ⓢ
Seat Width:	20	Cube:	5.1
Back Width:	19¾	Weight Rating:	250 lbs.
Back Height:	24¾		

LIST PRICE

\$809

Functions: **A, E, J, K, L, Q**
 (Function Key on pages 16-17)

NOTES: HMH02 available with Black Mesh seat and back.
 ⓘ Titanium frame only available on both models.

HON Recommendation: HMH01.MM10.C - List Price \$701

HOW TO SPECIFY

<p>Select Model Number</p> <p>HMH01</p>	<p>Select Seat</p> <p>MM10 Black Sandwich Mesh — (HMH01 ONLY) MST1 Black Mesh — (HMH02 ONLY)</p> <p>MM10</p>	<p>Select Frame</p> <p>C Titanium</p> <p>C</p>
--	--	--

CAMBIA™ 2160 SERIES



Cambia Upholstered Back Guest Chairs shown with Preside® table.

CAMBIA™ 2160 SERIES

Cambia's comfort and style is a warm invitation for any guest or coworker. With two back variations and arm options, this is a guest chair collection designed to adapt. Each back option offers a choice of a wood slat design or upholstered panel to suit any space or personal taste. Choose from eight rich hardwood finishes and hundreds of quality HON fabrics to express your style and reflect your brand.



FEATURES

- Wood slat back panel complements a variety of surroundings.
- Upholstered seat and back features cushioning for additional comfort and support.
- Personalize your space with a choice of back styles.
- Fixed arms enhance take pressure off the upper body and shoulders.
- Solid hardwood in one of eight attractive finishes.
- Available in hundreds of quality HON fabrics.
- Warranted for users up to 250 lbs.

CAMBIA™

2160 Series Options

MODEL OPTIONS

H2164



Guest Chair

Upholstered Back, Leg Base, Arch Arms

H2165



Guest Chair

Wood Slat Back, Leg Base, Arch Arms

AVAILABLE FINISHES

Cambia™ 2160 Series Seating is available in 8 wood finishes.

WOOD FINISHES

Bourbon Cherry (H)

Cognac (COGN)

Harvest (C)

Mahogany (N)

Mocha (MOCH)

Natural Maple (D)

Pinnacle (PINC)

Shaker Cherry (F)

AVAILABLE FABRICS

GRADE 1	GRADE 2	GRADE 3	GRADE 4	GRADE 5	GRADE 6	GRADE 7	GRADE 8	GRADE 9	GRADE 10	GRADE 11	GRADE 12	GRADE L
Arrondi *	Appoint	Canter	Bar	Amuse	Intermix II	Ascend	Brisa®	Eli Vinyl	Affinity	Acrobat	Fenestra	Denver
Attire	Seating	Polyurethane	Beeline	Avenue	Keynote	Central	Polyurethane	Martini Vinyl	Concentric	Natural	Helix	Leather
Centurion	Bangle	Epic	Blip	Lariat	Raffia Vinyl	Channel	Kindred	Olympus	Juxy	World	Lava	(Matches
Classic	Clyde	Infinity	Coin	Outlander	Velocity	Domain		Vinyl		Whirl	Ripple	EE Vinyl)
Compass	Dotty	Knack	Cover Cloth	Polka	Wooly	Synergy		Silica				
Confetti	Esplanade *	Marathon	Current	Riddle		Waver		Silica Leather				
Contourette	Expo	Millennium	Decode	Sentry-HC				Silica Tech				
Polyurethane	Fuse	Odyssey	Disc	Sequence								
Dapper	Gio *	Silvertext™	Divide	Solace								
Inertia	Moguls	Vinyl	Free	Tribeca								
Optic	Origin	Syntax	Habit									
Sierra Vinyl	Seed	Tradition	Hive									
Stitchery	Sockhop	Via	Lineup									
Tectonic	Spin Seating		Manner									
	Whisper		Medium									
	Vinyl		Messenger									
			Metric									
			Oblique									
			Pick									
			Sprint									
			Technic									

Reference Fabric Color Combinations on pages 18-29 for color codes and legend on page 19 for lead times. Visit hon.com for additional partnership fabrics.

NOTES: Gathers and creases may be more visible with Attire (AI) and Optic (OP) fabrics due to the inherent design and construction of these fabrics. For additional HON to Supply COM fabric grade pricing, go to honready.hon.com and click on the HON to Supply COM link.

🔥 For Fire Code model, availability and ordering method, refer to pages 34-39. Available on select models, contact HON Customer Support for availability.

* Fabric is de-emphasized.

CAMBIA™ 2160 Series

GSA SIN 711-18



Icon Legend on page 14

H2164



GUEST CHAIR

Upholstered Back
Leg Base
Arch Arms

DIMENSIONS

Depth:	24¼	Arm Width:	19
Width:	21¾	Seat to Floor Height:	19
Height:	31¾	Usable Seat Depth:	21
Seat Depth:	21	Ship Weight:	30
Seat Width:	21¾	Cube:	22.6
Back Width:	21¾	COM:	2.5
Back Height:	13¾	Weight Rating:	250 lbs.

FABRIC PRICE CODES

1	\$566	8	\$911
2	\$626	9	\$956
3	\$686	10	\$1001
4	\$731	11	\$1046
5	\$776	12	\$1091
6	\$821	L	\$1066
7	\$866		

H2165



GUEST CHAIR

Wood Slat Back
Leg Base
Arch Arms

DIMENSIONS

Depth:	24¼	Arm Width:	19
Width:	21¾	Seat to Floor Height:	19
Height:	31¾	Usable Seat Depth:	21
Seat Depth:	21	Ship Weight:	30
Seat Width:	21¾	Cube:	22.6
Back Width:	21¾	COM:	1.5
Back Height:	13¾	Weight Rating:	250 lbs.

FABRIC PRICE CODES

1	\$597	8	\$804
2	\$633	9	\$831
3	\$669	10	\$858
4	\$696	11	\$885
5	\$723	12	\$912
6	\$750	L	\$897
7	\$777		

HON Recommendation: H2164.MOCH.CU__ - List Price \$566

HOW TO SPECIFY

Select
Model Number

H 2 1 6 4 .

Select
Finish

See page 51

M O C H .

Select
Fabric

See page 51

C U 1 0



Task and Guest Chair shown with Announce® desks.

CERES®

Seating is personal. At the same time, it's also universal. Ceres is designed to bridge that gap by creating a holistic seating family that allows everyone to stay in control of their own comfort. As the result of exhaustive ergonomic research, the stunning Ceres collection of task and guest chairs feature total support for anyone and any space. The comfort contours cradle you throughout the workday, while projecting the right personality for your brand.



GUEST FEATURES

- ilira®-stretch mesh back is available in six colors.
- Model HCG6 is a four-leg multipurpose chair with a pivoting back for added comfort.
- Model HCG6 stacks up to four high on the floor.
- Guest chairs are available with or without arms.
- Warranted for users up to 300 lbs.

TASK CHAIR FEATURES

- Height- and width-adjustable arms provide a custom fit.
- Seat depth adjustment adapts to users of various heights.
- One-touch seat height adjustment easily moves the seat up and down.
- Tilt tension controls the rate and ease of recline.
- Tilt lock allows the user to lock out the tilt function.
- Warranted for users up to 300 lbs.

CERES® Task Chair Options



MODEL OPTION

HCW1







Task Chair

Pneumatic, Swivel, Synchro-tilt,
Seat Glide Tilt Tension, Height,
Width and Depth Adjustable Arms

ARM STYLE	CODE	DESCRIPTION	PRICE
	ABLCK	Textured Black	+\$0
	APLAT	Textured Platinum Metallic	+\$0
	APA	Polished Aluminum	+\$50

BACK STYLE	CODE	DESCRIPTION	PRICE
	PB	Upholstered in-back	+\$0
	<i>ilira®-stretch M4 options:</i>		
	IM	Black	+\$0
	IF	Fog	+\$0
	IV	Vanilla	+\$0
	IC	Charcoal	+\$0
	IH	Chai	+\$0
	IY	Navy	+\$0

CASTERS	CODE	DESCRIPTION	PRICE
	H	Hard Caster	+\$0
	S	Soft Caster	+\$30

BASE	CODE	DESCRIPTION	PRICE
	SB	Standard Base	+\$0
	PA	Polished Aluminum	+\$110

FRAME	CODE	DESCRIPTION	PRICE
	T	Black	+\$0

CERES® Multi-Purpose Chair Options







MODEL OPTION

HCG6



Multi-purpose

Four-leg stacking frame with pivoting back

ARM STYLE				BACK STYLE			
	CODE	DESCRIPTION	PRICE		CODE	DESCRIPTION	PRICE
	N	Armless	+\$0		PB	Upholstered in-back	+\$0
	F	Fixed Arms	+\$55		<i>ilira®-stretch M4 options:</i>		
				IM	Black		+\$0
				IF	Fog		+\$0
				IV	Vanilla		+\$0
				IC	Charcoal		+\$0
				IH	Chai		+\$0
				IY	Navy		+\$0
CASTERS/ GLIDE				FRAME			
	CODE	DESCRIPTION	PRICE		CODE	DESCRIPTION	PRICE
	H	Hard Caster	+\$0	BLCK	Textured Black		+\$0
	S	Soft Caster	+\$20	PLAT	Textured Platinum Metallic		+\$0
	E	Glide	+\$0				

CERES® Fabric Options

AVAILABLE FABRICS

GRADE 1	GRADE 2	GRADE 3	GRADE 4	GRADE 5	GRADE 6	GRADE 7	GRADE 8	GRADE 9	GRADE 10	GRADE 11	GRADE 12	GRADE L
Arrondi *	Appoint	Canter	Bar	Amuse	Intermix II	Ascend	Brisa®	Eli Vinyl	Affinity	Acrobat	Fenestra	Denver
Attire	Seating	Polyurethane	Beeline	Avenue	Keynote	Central	Polyurethane	Martini Vinyl	Concentric	Natural	Helix	Leather
Centurion	Bangle	Epic	Blip	Lariat	Raffia Vinyl	Channel	Kindred	Olympus Vinyl	Juxy	World	Lava	(Matches
Compass	Clyde	Infinity	Coin	Outlander	Velocity	Domain		Silica		Whirl	Ripple	EE Vinyl)
Confetti	Dotty	Knack	Cover Cloth	Polka	Wooly	Synergy		Silica Leather				
Contourette	Esplanade *	Marathon	Current	Riddle		Waver		Silica Tech				
Polyurethane	Expo	Millennium	Decode	Sentry-HC								
Dapper	Fuse	Odyssey	Disc	Sequence								
Inertia	Gio *	Silvertex™	Divide	Solace								
Optic	Moguls	Vinyl	Free	Tribeca								
Stitchery	Origin	Syntax	Habit									
Tectonic	Seed	Tradition	Hive									
	Sockhop	Via	Lineup									
	Spin Seating		Manner									
	Whisper		Medium									
	Vinyl		Messenger									
			Metric									
			Oblique									
			Pick									
			Sprint									
			Technic									

Reference Fabric Color Combinations on pages 18-29 for color codes and legend on page 19 for lead times. Visit hon.com for additional partnership fabrics.

NOTES: Gathers and creases may be more visible with Attire (AI) and Optic (OP) fabrics due to the inherent design and construction of these fabrics. For additional HON to Supply COM fabric grade pricing, go to honready.hon.com and click on the HON to Supply COM link.

🔥 For Fire Code model, availability and ordering method, refer to pages 34-39. Available on select models, contact HON Customer Support for availability.

* Fabric is de-emphasized.



HCW1



TASK CHAIR

Pneumatic
Swivel
Synchro-tilt
Seat Glide Tilt Tension
Height, Width and Depth
Adjustable Arms
Functions:
A, D, E, A-C, A-D, B-A
(Function Key on pages 16-17)

DIMENSIONS

Depth:	27¾	Seat to Floor Height:	17-21½
Width:	27½	Usable Seat Depth:	17-19½
Height:	43⅞	Ship Weight (upholstered back):	39
Seat Depth:	19	Ship Weight (mesh back):	39
Seat Width:	20	Cube (upholstered back):	11.3
Back Width:	16½	Cube (mesh back):	11.3
Back Height:	22½	COM (upholstered back):	1.0
Arm Width:	17½-21	COM (mesh back):	1.0
		Weight Rating:	300 lbs.

FABRIC PRICE CODES

1	\$1120	8	\$1258
2	\$1144	9	\$1276
3	\$1168	10	\$1294
4	\$1186	11	\$1312
5	\$1204	12	\$1330
6	\$1222	L	\$1320
7	\$1240		

HON Recommendation: HCW1.ABLCK.H.IM.CU__SB.T - List Price \$1120

HOW TO SPECIFY

Select Model Number	Select Arm Option	Select Caster/Glide	Select Back Option	Select Fabric	Select Base	Select Frame
	Adjustable Arms Finishes ABLCK Textured Black APLAT Textured Platinum Metallic APA Polished Aluminum (+ \$50)	H Hard Caster S Soft Caster (+ \$30)	PB Upholstered in-back ilira®-stretch M4 options IM Black IF Fog IV Vanilla IC Charcoal IH Chai IY Navy	See page 56	SB Standard Base PA Polished Aluminum (+ \$110)	T Black
HCW1	ABLCK	H	IM	CU10	SB	T



HCG6

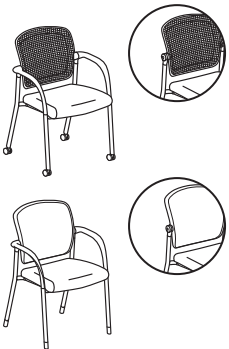

MULTI-PURPOSE

Four-leg stacking frame with pivoting back

DIMENSIONS

Depth:	25	Seat to Floor Height:	18¾
Width:	24½	Usable Seat Depth:	17¼
Height:	35	Ship Weight (upholstered back):	22
Seat Depth:	19½	Ship Weight (mesh back):	22
Seat Width:	20	Cube (upholstered back):	15.2
Back Width:	17½	Cube (mesh back):	15.2
Back Height:	17	COM (upholstered back):	1.0
Arm Width:	20¼	COM (mesh back):	1.0
		Weight Rating:	300 lbs.

FABRIC PRICE CODES

1	\$496	8	\$634
2	\$520	9	\$652
3	\$544	10	\$670
4	\$562	11	\$688
5	\$580	12	\$706
6	\$598	L	\$696
7	\$616		

NOTES: Multi-purpose model HCG6, with or without arms, stacks up to 4-high.

HON Recommendation: HCG6.F.H.IM.CU__BLCK - List Price \$551

HOW TO SPECIFY

Select Model Number	Select Arm Option	Select Caster/Glide	Select Back Option	Select Fabric	Select Frame
	F Fixed Arms (+ \$55) N Armless	E Glide H Hard Caster S Soft Caster (+ \$20)	PB Upholstered in-back ilira®-stretch M4 options IM Black IF Fog IV Vanilla IC Charcoal IH Chai IY Navy	See page 56	BLCK Textured Black PLAT Textured Platinum Metallic
HCG6	F	H	IM	CU10	BLCK

COMFORTASK® 5900 SERIES



ComforTask Chair shown
with Metro Classic desks.

COMFORTASK® 5900 SERIES

What's in a name? If it's ComforTask, is the support you need to get the job done. ComforTask seating is a proven office performer, with cushioning in all the right places, a waterfall seat edge and the customizable comfort that allows everyone to create a personal fit. Advanced controls such as back height and seat depth adjustments take the personalization to an even higher level, earning fans throughout the office.



FEATURES

- Back height adjustment moves the back up or down to provide a custom fit.
- Seat depth adjustment on Model H5901 adapts to users of various heights.
- Contoured seat and back provide targeted support.
- Waterfall seat edge encourages leg circulation.
- One-touch seat height adjustment easily moves the seat up and down.
- 360-degree swivel provides freedom of movement in any direction.
- Molded polymer outer back.
- Model H5905 is available with optional bell glides.
- Available in hundreds of quality HON fabrics.
- Warranted for users up to 300 lbs.

COMFORTASK® 5900 Series Options

MODEL OPTIONS

H5901



Task Chair

Pneumatic, Back Height, Seat Depth, Swivel

H5902



Task Chair

Pneumatic, Back Height, Swivel, Tilt, Tilt Tension, Tilt Lock

H5903



Task Chair

Pneumatic, Back Height, Swivel, Multi-task

H5905



Task Stool

Pneumatic, Back Height, Swivel, Adjustable Height Footring

CASTERS/ GLIDE



CODE	DESCRIPTION	PRICE
H	Hard Caster	+\$0



S	Soft Caster	+\$30
----------	-------------	--------------



G	Bell Glide	+\$25
----------	------------	--------------

*G only available on model H5905

FRAME

CODE	DESCRIPTION	PRICE
T	Black	+\$0

COMFORTASK®

5900 Series Fabric Options

AVAILABLE FABRICS

GRADE 1	GRADE 2	GRADE 3	GRADE 4	GRADE 5	GRADE 6	GRADE 7	GRADE 8	GRADE 9	GRADE 10	GRADE 11	GRADE 12	GRADE L
Arrondi *	Appoint	Canter	Bar	Amuse	Intermix II	Ascend	Brisa®	Martini Vinyl	Affinity	Acrobat	Fenestra	
Attire *	Seating	Polyurethane	Beeline	Avenue	Keynote	Central	Polyurethane	Olympus Vinyl	Concentric	Natural	Helix	
Centurion	Bangle	Epic	Blip	Lariat	Velocity	Channel	Kindred	Silica	Juxy	World	Lava	
Classic	Clyde	Infinity	Coin	Outlander	Wooly	Domain		Silica Leather		Whirl	Ripple	
Compass	Dotty	Knack	Cover Cloth	Polka		Synergy		Silica Tech				
Confetti	Esplanade *	Marathon	Current	Riddle		Waver						
Contourette	Expo	Millennium	Decode	Sentry-HC								
Polyurethane	Fuse	Odyssey	Disc	Sequence								
Dapper	Gio *	Silvertex™	Divide	Solace								
Inertia	Moguls	Vinyl	Free	Tribeca								
Optic	Origin	Syntax	Habit									
Stitchery	Seed	Tradition	Hive									
Tectonic	Sockhop	Via	Lineup									
	Spin Seating		Manner									
	Whisper Vinyl		Medium									
			Messenger									
			Metric									
			Oblique									
			Pick									
			Sprint									
			Technic									

Reference Fabric Color Combinations on pages 18-29 for color codes and legend on page 19 for lead times. Visit hon.com for additional partnership fabrics.

NOTES: Gathers and creases may be more visible with Attire (AI) and Optic (OP) fabrics due to the inherent design and construction of these fabrics. COM yardage shown is for Pattern Cut only. Contact Customer Service for Railroaded yardage requirements. For additional HON to Supply COM fabric grade pricing, go to honready.hon.com and click on the HON to Supply COM link.

🔥 For Fire Code model, availability and ordering method, refer to pages 34-39. Available on select models, contact HON Customer Support for availability.

* Fabric is de-emphasized.

COMFORTASK® 5900 Series

GSA SIN 711-18



Icon Legend on page 14

H5901



TASK

Pneumatic
Back Height
Seat Depth
Swivel
Functions: **A, B, C, E**
(Function Key on pages 16-17)

NOTES: Seat depth adjustment.

DIMENSIONS

Depth:	28¾	Seat to Floor Height:	14⅞-19¾
Width:	23	Usable Seat Depth:	16⅝-18⅞
Height:	38¼	Ship Weight:	30 Ⓢ
Seat Depth:	18	Cube:	7.8
Seat Width:	20	COM:	1.0
Back Width:	16¼	Weight Rating:	300 lbs.
Back Height:	17¾		

FABRIC PRICE CODES

1	\$258	8	\$396
2	\$282	9	\$414
3	\$306	10	\$432
4	\$324	11	\$450
5	\$342	12	\$468
6	\$360	L	—
7	\$378		

H5902



TASK

Pneumatic
Back Height
Swivel
Tilt
Tilt Tension
Tilt Lock
Functions: **A, B, E, F, K, L**
(Function Key on pages 16-17)

DIMENSIONS

Depth:	27¾	Seat to Floor Height:	17-22
Width:	23	Usable Seat Depth:	16¾
Height:	39¾	Ship Weight:	30 Ⓢ
Seat Depth:	18	Cube:	7.8
Seat Width:	20	COM:	1.0
Back Width:	16¼	Weight Rating:	300 lbs.
Back Height:	21		

FABRIC PRICE CODES

1	\$276	8	\$414
2	\$300	9	\$432
3	\$324	10	\$450
4	\$342	11	\$468
5	\$360	12	\$486
6	\$378	L	—
7	\$396		

H5903



TASK

Pneumatic
Back Height
Swivel
Multi-task
Functions: **A, B, E, N**
(Function Key on pages 16-17)

DIMENSIONS

Depth:	34¼	Seat to Floor Height:	16¼-20⅞
Width:	24	Usable Seat Depth:	13¾-17
Height:	40½	Ship Weight:	32 Ⓢ
Seat Depth:	18	Cube:	7.8
Seat Width:	20	COM:	1.0
Back Width:	16¼	Weight Rating:	300 lbs.
Back Height:	20¼		

FABRIC PRICE CODES

1	\$390	8	\$528
2	\$414	9	\$546
3	\$438	10	\$564
4	\$456	11	\$582
5	\$474	12	\$600
6	\$492	L	—
7	\$510		

HON Recommendation: H5901.H.CU__T with optional H5995 - List Price \$357

HOW TO SPECIFY

Select Model Number <div style="border: 1px solid black; padding: 2px; display: flex; gap: 5px;"> H5901 </div>	Select Caster/Glide H Hard Caster S Soft Caster (+ \$30) <div style="border: 1px solid black; padding: 2px; display: flex; gap: 5px;"> H </div>	Select Fabric See page 61 <div style="border: 1px solid black; padding: 2px; display: flex; gap: 5px;"> CU10 </div>	Select Frame T Black <div style="border: 1px solid black; padding: 2px; display: flex; gap: 5px;"> T </div>
---	--	--	--



COMFORTASK® 5900 Series

H5905



TASK STOOL

Pneumatic
Back Height
Swivel
Adjustable Height Footring
Functions: **A, B, E**
(Function Key on pages 16-17)

DIMENSIONS

Depth:	30	Seat to Floor Height:	21 ³ / ₄ -31 ¹ / ₈
Width:	26 ³ / ₄	Footring Width:	20
Height:	49 ³ / ₄	Footring Height:	7 ¹ / ₈ -12 ³ / ₄
Seat Depth:	18	Usable Seat Depth:	17
Seat Width:	20	Ship Weight:	34 Ⓢ
Back Width:	16 ¹ / ₄	Cube:	10.4
Back Height:	17 ³ / ₄	COM:	1.0
		Weight Rating:	300 lbs.

FABRIC PRICE CODES

1	\$377	8	\$515
2	\$401	9	\$533
3	\$425	10	\$551
4	\$443	11	\$569
5	\$461	12	\$587
6	\$479	L	—
7	\$497		

NOTES: Available with optional Bell Glides.

H5991



T-ARMS

Fixed Position
Functions: **P**
(Function Key on pages 16-17)

DIMENSIONS

Arm Width:	18 ³ / ₄
Height from Seat:	8 ¹ / ₂
Ship Weight:	6 Ⓢ
Cube:	1.0

LIST PRICE

\$70

H5995



ADJUSTABLE HEIGHT ARMS

Functions: **Q**
(Function Key on pages 16-17)

DIMENSIONS

Arm Width:	18 ³ / ₄
Height from Seat:	6 ¹ / ₂ -8 ³ / ₄
Ship Weight:	8 Ⓢ
Cube:	0.6

LIST PRICE

\$99

HOW TO SPECIFY

<p>Select Model Number</p> <p>H 5 9 0 5 .</p>	<p>Select Caster/Glide</p> <p>H Hard Caster S Soft Caster (+ \$30) <i>Specify for model H5905 only</i> G Bell Glide (+ \$25)</p> <p>H .</p>	<p>Select Fabric</p> <p>See page 61</p> <p>C U 1 0 .</p>	<p>Select Frame</p> <p>T Black</p> <p>T</p>
--	---	---	---

COMFORTSELECT™ COLLECTION



A9 Task Chair, K3 Task Chair and B6 Task Chair.

COMFORTSELECT™ COLLECTION

Every self-starter needs a comfortable task chair to stay productive. Say hello to ComfortSelect, the collection designed to give everyone a great chair at an attainable price. Every ComfortSelect chair delivers the comfort, durability and affordability every small business owner wants, while the HON Full Lifetime Warranty gives everyone the confidence they need.



FEATURES

- Choose one of two naturally comfortable recline controls.
- One-touch seat height adjustment easily moves the seat up and down.
- 360-degree swivel provides freedom of movement in any direction.
- Casters roll effortlessly and silently.
- Customize the fit of each chair with adjustable arms.
- Lumbar support provides comfort users demand.
- Warranted for users up to 250 lbs.



Icon Legend on page 14

COMFORTSELECT™ A9 Task Chair

HACC1TMM



TASK CHAIR

- High-back**
- Pneumatic
- Swivel
- Synchro-tilt
- Tilt Tension
- Tilt Lock
- Mesh Back

Functions: **A, E, F, K, L, Q, W**
(Function Key on pages 16-17)

NOTES: 4" thick plush seat cushion. Height- and width-adjustable arms. Height-adjustable lumbar for customized support. Breathable mesh back design. Advanced synchro-tilt recline control with seat slide.

DIMENSIONS

Depth:	19¼	Arm Width:	19
Width:	19	Seat to Floor Height:	17½-20
Height:	44½	Usable Seat Depth:	18½
Seat Depth:	18½	Ship Weight:	44
Seat Width:	22¾	Cube:	5.6
Back Width:	19	COM:	7.6
Back Height:	19¾	Weight Rating:	250 lbs.

LIST PRICE

\$440

HOW TO SPECIFY

Select Model Number	Select Control Type	Select Arm Type	Select Caster	Select Mesh Back	Select Seat Fabric	Select Base	Select Frame
	Y1 Synchro-Tilt w/ Seat Slide Control	A Height and Width Adjustable Arms	H Hard Caster	ACCM10 Black Mesh	ACCF10 Black Fabric	SB Standard Base	T Black
H A C C 1 T M M .	Y 1 .	A .	H .	A C C M 1 0 .	A C C F 1 0 .	S B .	T .

COMFORTSELECT™ B6 Task Chair

NOT ON GSA CONTRACT



Icon Legend on page 14

HSUR2TMM



TASK CHAIR

High-back
Pneumatic
Swivel-tilt
Tilt Tension
Tilt Lock
Mesh Back

Functions: **A, E, F, K, L, Q, W**
(Function Key on pages 16-17)

DIMENSIONS

Depth:	19¼	Arm Width:	19
Width:	19	Seat to Floor Height:	17½-20
Height:	43¾	Usable Seat Depth:	17¾
Seat Depth:	17¾	Ship Weight:	39
Seat Width:	22⅝	Cube:	5.6
Back Width:	18	COM:	7.6
Back Height:	17¾	Weight Rating:	250 lbs.

LIST PRICE

\$345

NOTES: 3" thick contoured seat cushion. Height-adjustable arms. Integrated lumbar band for enhanced comfort. Breathable mesh back design. Intuitive swivel-tilt control with upright lock.

HOW TO SPECIFY

Select Model Number	Select Control Type	Select Arm Type	Select Caster	Select Mesh Back	Select Seat Fabric	Select Base	Select Frame
HSUR2TMM	S1 Swivel-Tilt Control	H Height Adjustable Arms	H Hard Caster	ACCM10 Black Mesh	ACCF10 Black Fabric	SB Standard Base	T Black
HSUR2TMM	S1	H	H	ACCM10	ACCF10	SB	T



Icon Legend on page 14

COMFORTSELECT™ K3 Task Chair

HXCL2TMM



TASK CHAIR

Mid-back

- Pneumatic
- Swivel-tilt
- Tilt Tension
- Tilt Lock
- Mesh Back

Functions: **A, E, F, K, L, Q, W**
(Function Key on pages 16-17)

DIMENSIONS

Depth:	19¼	Arm Width:	19
Width:	19	Seat to Floor Height:	17½-20
Height:	41¾	Usable Seat Depth:	17¾
Seat Depth:	17¾	Ship Weight:	35
Seat Width:	22⅝	Cube:	4.3
Back Width:	18	COM:	7.6
Back Height:	17¾	Weight Rating:	250 lbs.

LIST PRICE

\$310

NOTES: 2½" thick contoured seat cushion. Height-adjustable arms. Contoured lumbar support for built-in comfort. Breathable mesh back design. Intuitive swivel-tilt control with upright lock.

HOW TO SPECIFY

Select Model Number	Select Control Type	Select Arm Type	Select Caster	Select Mesh Back	Select Seat Fabric	Select Base	Select Frame
	S1 Swivel-Tilt Control	H Height Adjustable Arms	H Hard Caster	ACCM10 Black Mesh	ACCF10 Black Fabric	SB Standard Base	T Black
H X C L 2 T M M .	S 1 .	H .	H .	A C C M 1 0 .	A C C F 1 0 .	S B .	T .

CONVERA™ LOUNGE



Convera Club Chairs and Love Seat shown with Endorse Tables.

CONVERA™ LOUNGE

Make a strong impression in any reception area, lounge, or private office with Convera lounge seating. Enjoy a tailored fit. Graceful lines. Inspired design. The fully-upholstered seat and back features accent piping and solid hardwood legs to make a stylish statement. Choose from a wide selection of fabrics to create a look that reflects your unique tastes. Convera is the lounge chair family that guests at ease, while putting you in total control of the look of your work environment.



FEATURES

- Contoured seat, back and arms create a softer feel.
- Solid hardwood legs in one of eight attractive finishes.
- Nylon glides slide effortlessly on all surfaces.
- Available in hundreds of quality HON fabrics.
- Warranted for users up to 250 lbs.

CONVERA™ Lounge Options

MODEL OPTIONS

HDAC01



Club Chair

Fully-Upholstered

HDAA01

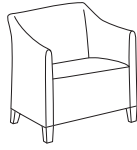

Lounge Chair

Fully-Upholstered

HDAL02

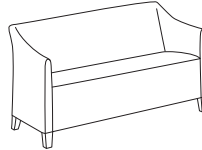

Love Seat

Fully-Upholstered

AVAILABLE FINISHES

Convera™ Lounge Seating is available in 8 wood finishes.

WOOD FINISHES

Bourbon Cherry (H)

Cognac (COGN)

Harvest (C)

Mahogany (N)

Mocha (MOCH)

Natural Maple (D)

Pinnacle (PINC)

Shaker Cherry (F)

AVAILABLE FABRICS

GRADE 1	GRADE 2	GRADE 3	GRADE 4	GRADE 5	GRADE 6	GRADE 7	GRADE 8	GRADE 9	GRADE 10	GRADE 11	GRADE 12	GRADE L
Arrondi *	Appoint Seating	Canter Polyurethane	Bar	Amuse	Intermix II		Brisa® Polyurethane	Eli Vinyl	Affinity	Acrobat	Fenestra	Denver Leather (Matches EE Vinyl)
Centurion	Bangle	Epic	Blip	Avenue	Raffia Vinyl			Martini Vinyl	Concentric	Whirl	Helix	
Classic	Clyde	Infinity	Coin	Lariat	Wooly			Olympus Vinyl	Juxy			
Compass	Esplanade *	Knack	Current	Outlander								
Confetti	Expo	Marathon	Decode	Polka								
Contourette Polyurethane	Fuse	Millennium	Disc	Riddle								
Dapper	Gio *	Odyssey	Divide	Sequence								
Inertia	Moguls	Silvertex™ Vinyl	Free	Solace								
Optic	Origin	Syntax	Habit	Tribeca								
Sierra Vinyl	Seed	Tradition	Hive									
Stitchery	Sockhop	Via	Lineup									
Tectonic	Spin Seating		Manner									
	Whisper Vinyl		Medium									
			Messenger									
			Metric									
			Oblique									
			Pick									
			Sprint									
			Technic									

Reference Fabric Color Combinations on pages 18-29 for color codes and legend on page 19 for lead times. Visit hon.com for additional partnership fabrics.

NOTES: Gathers and creases may be more visible with Attire (AI) and Optic (OP) fabrics due to the inherent design and construction of these fabrics. For additional HON to Supply COM fabric grade pricing, go to honready.hon.com and click on the HON to Supply COM link.

🔥 For Fire Code model, availability and ordering method, refer to pages 34-39. Available on select models, contact HON Customer Support for availability.

* Fabric is de-emphasized.

CONVERA™ Lounge

GSA SIN 711-16



Icon Legend on page 14

HDAC01



CLUB CHAIR

Fully-Upholstered

DIMENSIONS

Depth:	27 ³ / ₈	Arm Width:	18 ³ / ₄
Width:	24	Seat to Floor Height:	18 ³ / ₄
Height:	32 ³ / ₄	Usable Seat Depth:	17 ³ / ₄
Seat Depth:	17 ³ / ₄	Ship Weight:	43
Seat Width:	17 ³ / ₄	Cube:	15.1
Back Width:	17 ³ / ₄	COM:	3.5
Back Height:	15 ¹ / ₂	Weight Rating:	250 lbs.

FABRIC PRICE CODES

1	\$1587	8	\$2070
2	\$1671	9	\$2133
3	\$1755	10	\$2196
4	\$1818	11	\$2259
5	\$1881	12	\$2322
6	\$1944	L	\$2287
7	\$2007		

HDAA01

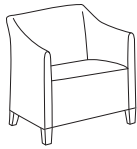

LOUNGE CHAIR

Fully-Upholstered

DIMENSIONS

Depth:	30 ¹ / ₄	Arm Width:	22 ¹ / ₂
Width:	29	Seat to Floor Height:	17
Height:	30 ³ / ₄	Usable Seat Depth:	19 ³ / ₄
Seat Depth:	19 ³ / ₄	Ship Weight:	56
Seat Width:	21 ¹ / ₂	Cube:	20.7
Back Width:	21 ¹ / ₄	COM:	4.5
Back Height:	17 ¹ / ₂	Weight Rating:	250 lbs.

FABRIC PRICE CODES

1	\$1722	8	\$2343
2	\$1830	9	\$2424
3	\$1938	10	\$2505
4	\$2019	11	\$2586
5	\$2100	12	\$2667
6	\$2181	L	\$2622
7	\$2262		

HDAL02

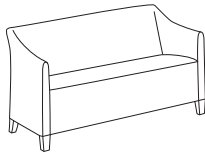

LOVE SEAT

Fully-Upholstered

DIMENSIONS

Depth:	30 ¹ / ₄	Arm Width:	46 ³ / ₄
Width:	53 ³ / ₄	Seat to Floor Height:	17
Height:	30 ¹ / ₂	Usable Seat Depth:	19 ³ / ₄
Seat Depth:	19 ³ / ₄	Ship Weight:	85
Seat Width:	45 ³ / ₄	Cube:	58.4
Back Width:	45 ¹ / ₂	COM:	6.0
Back Height:	17 ¹ / ₂	Weight Rating:	250 lbs.

FABRIC PRICE CODES

1	\$2327	8	\$3155
2	\$2471	9	\$3263
3	\$2615	10	\$3371
4	\$2723	11	\$3479
5	\$2831	12	\$3587
6	\$2939	L	\$3527
7	\$3047		

HON Recommendation: HDAC01.MOCH.PNS__ - List Price \$1671

HOW TO SPECIFY

Select
Model Number

HDAC01

Select
Leg Finish

See page 69

MOCH

Select
Fabric

See page 69

PNS007

ENDORSE™ COLLECTION



Endorse Executive Mid-Back Chair
shown with Preside® Conference Table.

ENDORSE™ COLLECTION

You need inviting, comfy seats up front, and task chairs that support productivity in workstations. Achieve harmony throughout your space with a multi-functional collection of Endorse task and lounge seating. Endorse supports the diversity of applications throughout your workplace with sophisticated design. Varied options. Diverse materials. Simply pick the model that suits your space and people. Add the options or coordinating occasional tables that fit your needs. Then get ready to Endorse a higher level of productivity.



TASK CHAIR FEATURES

- Available in high-, mid- and low-back options.
- Available in three different back materials — upholstered, mesh and plastic outer back.
- Comfort options include adjustable lumbar support, adjustable arms, seat glide, multi-position tilt and synchro-tilt.
- Optional seat depth adjustment adapts to users of various heights.
- Control options include synchro-tilt, limited synchro-tilt, synchro-tilt with independent back angle and weight-activated control.
- Arm options include fixed, armless, height- and width-adjustable and all-adjustable.
- Roll-control casters resist rolling when chair is not in use.
- Available in hundreds of quality HON fabrics.
- Warranted for users up to 300 lbs.
(450 lbs. for Big and Tall chairs)



LOUNGE SEATING

- Choose from Single Seat, Two-Seat or Three-Seat options.
- Durable steel frame construction.
- Available in hundreds of quality HON fabrics.
- Warranted for users up to 300 lbs.



OCCASIONAL TABLES

- Available in Square or Rectangular tops.
- Available in eight top laminate finishes.
- Available in ten edgeband laminate finishes.
- Optional integrated power grommets.

ENDORSE™ Options

BACK OPTIONS

HLEU
HLEUBT - Big & Tall



High-back

Upholstered with Adjustable Lumbar Support

HLWU
HLWUBT - Big & Tall



Mid-back

Upholstered with Adjustable Lumbar Support

HLWM
HLWMBT - Big & Tall

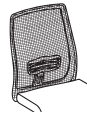

Mid-back

Mesh with Adjustable Lumbar Support

HLTU
HLTSU - Stool



Low-back

Upholstered with Adjustable Lumbar Support

HLTM
HLTSM - Stool



Low-back

Mesh with Adjustable Lumbar Support

HLTP
HLTSP - Stool



Low-back

Upholstered with Plastic Outer Back and Adjustable Lumbar Support

MESH BACK COLOR CODES for ilira®-stretch (no upcharge): Black - **IM** Fog - **IF** Vanilla - **IV** Charcoal - **IC** Chai - **IH** Navy - **IY**

MECHANISM

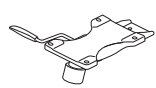

S1 Limited Synchro-Tilt
A, E, J, K, L, W

+ \$0

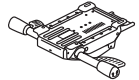

Y2 Synchro-Tilt
A, D, E, J, L, W, A-D

+ \$65



Y3 Synchro-Tilt with Independent Back Angle
A, D, E, J, L, W, A-E

+ \$105

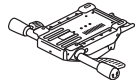

Y4 Synchro-Tilt
A, D, E, J, L, W, A-D
(Big and Tall models only)

+ \$0



W5 Weight-Activated
A, D, E, L, W, A-D

+ \$150

(See pages 16-17 for Seating Functions.)

BASE



SB Standard Base

+ \$0

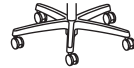

PA Polished Aluminum

+ \$110

CASTERS



A All-Surface Caster
(High-back and Big and Tall models only)

+ \$0



H Hard Caster

+ \$0



S Soft Caster

+ \$30



R Roll Control Caster

+ \$50

ARM STYLE

CODE DESCRIPTION

PRICE

N Armless

+ \$0

F Fixed - Black

+ \$65



A Height and Width Adjustable Arms

+ \$75



V All-Adjustable Arms - includes pivot

+ \$115



P Fixed - Polished Alum.

+ \$150



TASK DIMENSIONS

MODEL		HLEU	HLWU	HLWM	HLTU	HLTM	HLTP
Overall Width Armless		28½	28½	28½	28½	28½	28½
Overall Width with Arms	A/V	28½	28½	28½	28½	28½	28½
	F/P	28½	28½	28½	28½	28½	28½
Overall Depth		28½	28½	28½	28½	28½	28½
Overall Height	S1	47¾	44½	44½	41¼	40¼	41¼
	Y2/Y3	49½	46	46	42½	42½	42½
	W5	49	48⅝	48⅝	43	43	43
Seat Width		20	20	20	19	19	19
Seat Depth	S1	15¾	15¾	15¾	18⅞	18⅞	18⅞
	Y2/Y3	15¼-18¼	15¼-18¼	15¼-18¼	15¼-18¼	15¼-18¼	15¼-18¼
	W5	15½-17¾	15½-17¾	15½-17¾	15½-17¾	15½-17¾	15½-17¾
Usable Seat Depth	S1	15¾	15¾	15¾	15⅞	15⅞	15⅞
	Y2/Y3	15¼-18¼	15¼-18¼	15¼-18¼	15¼-18¼	15¼-18¼	15¼-18¼
	W5	15½-17¾	15½-17¾	15½-17¾	15½-17¾	15½-17¾	15½-17¾
Seat Height (mechanism)	S1	16⅝-22	16⅝-22	16⅝-22	16⅝-22	16⅝-22	16⅝-22
	Y2/Y3	17½-22	17½-22	17½-22	17½-22	17½-22	17½-22
	W5	17¼-21¾	17¼-21¾	17¼-21¾	17¼-21¾	17¼-21¾	17¼-21¾
Back Width		21⅝	21¼	19¼	19¼	18	19¾
Back Height		29¾	25	25	22¾	21¾	22¾
Ship Weight Armless	S1	40	51	48	51	32	40
	Y2	57	48	45	54	46	56
	Y3	60	52	48	58	50	59
	W5	56	47	44	54	45	55
Weight with Arms	S1	-	-	-	-	-	-
	Y2	65	56	53	62	54	64
	Y3	68	60	56	66	58	67
	W5	64	55	52	62	53	63
Between Arms	A/V	17½-20	17½-20	17½-20	16¾-19¼	16¾-19¼	16¾-19¼
	F/P	20½	20½	20½	20½	20½	20½
COM		2.0	2.0	1.0	2.0	1.0	2.0
Weight Capacity		300 lbs	300 lbs	300 lbs	300 lbs	300 lbs	300 lbs

BIG & TALL & STOOL DIMENSIONS

MODEL		HLWUBT	HLWMBT	HLEUBT	HLTSU	HLTSM	HLTSP
Overall Width Armless		28½	28½	28½	28½	28½	28½
Overall Width with Arms	A/V	28½	28½	28½	28½	28½	28½
	F/P	28½	28½	28½	28½	28½	28½
Overall Depth		28½	28½	28½	28½	28½	28½
Overall Height	S1	-	-	-	42½	42½	42½
	Y4	49½	49½	49½	-	-	-
Seat Width		20	20	20	19	19	19
Seat Depth	S1	-	-	-	15¼-18¼	15¼-18¼	15¼-18¼
	Y4	15¼-18¼	15¼-18¼	15¼-18¼	15¼-18¼	15¼-18¼	15¼-18¼
Usable Seat Depth	S1	-	-	-	15¼-18¼	15¼-18¼	15¼-18¼
	Y4	15¼-18¼	15¼-18¼	15¼-18¼	-	-	-
Seat Height (mechanism)	S1	-	-	-	17½-22	17½-22	17½-22
	Y4	17½-22	17½-22	17½-22	-	-	-
Back Width		21⅝	21⅝	21⅝	19¾	19¾	19¾
Back Height		29¾	29¾	29¾	22¾	22¾	22¾
Ship Weight Armless	S1	-	-	-	54	54	54
	Y4	57	57	57	-	-	-
Weight with Arms	S1	-	-	-	62	62	62
	Y4	65	65	65	-	-	-
Between Arms	A/V	17½-20	17½-20	17½-20	16¾-19¼	16¾-19¼	16¾-19¼
	F/P	20½	20½	20½	20½	20½	20½
COM		2.0	2.0	2.0	2.0	2.0	2.0
Weight Capacity		300 lbs	300 lbs	300 lbs	300 lbs	300 lbs	300 lbs

ENDORSE™ Fabric Options

AVAILABLE FABRICS (For Seating)

GRADE 1	GRADE 2	GRADE 3	GRADE 4	GRADE 5	GRADE 6	GRADE 7	GRADE 8	GRADE 9	GRADE 10	GRADE 11	GRADE 12	GRADE L
Arrondi *	Appoint Seating	Canter Polyurethane	Bar	Amuse	Intermix II	Ascend	Brisa® Polyurethane	Eli Vinyl	Affinity	Acrobat	Fenestra	Denver Leather (Matches EE Vinyl)
Attire	Bangle	Epic	Beeline	Avenue	Keynote	Central	Kindred	Martini Vinyl	Concentric	Natural World	Helix	
Centurion	Clyde	Infinity	Blip	Lariat	Raffia Vinyl	Channel		Olympus Vinyl	Juxy	Whirl	Lava	
Classic	Dotty	Knack	Coin	Outlander	Velocity	Domain		Silica			Ripple	
Compass	Esplanade *	Marathon	Cover Cloth	Poika	Wooly	Synergy		Silica Leather				
Confetti	Expo	Millennium	Current	Riddle		Waver		Silica Tech				
Contourette	Fuse	Odyssey	Decode	Sentry-HC								
Polyurethane	Gio *	Silvertext™ Vinyl	Disc	Sequence								
Dapper	Moguls	Syntax	Divide	Solace								
Inertia	Origin	Tradition	Free	Tribeca								
Optic	Seed	Via	Habit									
Stitchery	Sockhop		Hive									
Tectonic	Spin Seating		Lineup									
	Whisper Vinyl		Manner									
			Medium									
			Messenger									
			Metric									
			Oblique									
			Pick									
			Sprint									
			Technic									

Reference Fabric Color Combinations on pages 18-29 for color codes and legend on page 19 for lead times. Visit hon.com for additional partnership fabrics.

NOTES: Gathers and creases may be more visible with Attire (AI) and Optic (OP) fabrics due to the inherent design and construction of these fabrics. For additional HON to Supply COM fabric grade pricing, go to honready.hon.com and click on the HON to Supply COM link.

🔥 For Fire Code model, availability and ordering method, refer to pages 34-39. Available on select models, contact HON Customer Support for availability.

* Fabric is de-emphasized.

ENDORSE™ Finish Options

AVAILABLE FINISHES (For Occasional Tables)

Endorse™ Occasional Tables are available in 15 laminate colors. Each laminate has a specific selection of edges available.

L1 LAMINATE TOP COLORS	EDGEBAND COLORS
Mahogany (N)	Mahogany (N), Loft (LOFT), Shadow (SHDW)
Shaker Cherry (F)	Shaker Cherry (F), Muslin (T), White (WHIT), Loft (LOFT), Shadow (SHDW)
Bourbon Cherry (H)	Bourbon Cherry (H), Muslin (T), White (WHIT)
Natural Maple (D)	Natural Maple (D), Muslin (T), White (WHIT), Loft (LOFT)
Brilliant White (WHIT)	Brilliant White (WHIT)
Charcoal (S)	Charcoal (S)
Silver Mesh (B9)	Loft (LOFT)
Cognac (COGN)	Cognac (COGN), Muslin (T), White (WHIT)
Mocha (MOCH)	Mocha (MOCH), Muslin (T), White (WHIT), Loft (LOFT), Shadow (SHDW)
Pinnacle (PINC)	Pinnacle (PINC), Muslin (T), White (WHIT), Loft (LOFT), Shadow (SHDW)

L2 LAMINATE TOP COLORS	EDGEBAND COLORS
Lowell Ash (LLA1)	Lowell Ash (DL), Muslin (T), White (WHIT), Loft (LOFT), Shadow (SHDW)
Natural Recon (LNR1)	Natural Recon (NR), Muslin (T), White (WHIT), Loft (LOFT), Shadow (SHDW)
Phantom Ecru (LPE1)	Phantom Ecru (PE), Muslin (T), White (WHIT), Loft (LOFT), Shadow (SHDW), Charcoal (S)
Portico Teak (LPT1)	Portico Teak (DP), Muslin (T), White (WHIT), Loft (LOFT), Shadow (SHDW), Charcoal (S)
Skyline Walnut (LSW1)	Skyline Walnut (SW), Muslin (T), White (WHIT), Loft (LOFT), Shadow (SHDW), Charcoal (S)



Icon Legend on page 14

HLEU

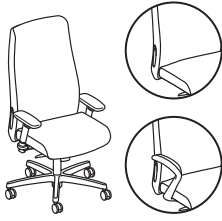

EXECUTIVE HIGH-BACK

Upholstered Back

- Pneumatic
- Swivel
- Synchro-tilt
- Tilt Tension
- Tilt Lock
- Integral Lumbar Support

Functions: **A, E, J, K, L, W**
 (Function Key on pages 16-17)

i Dimensions, weights and cubes shown above are for models using the S1 Endorse™ control only. See page 72 for all other control specifications.

DIMENSIONS

Depth:	31½	Arm Width:	17½-20½
Width:	31½	Seat to Floor Height:	16⅝-22
Height:	47¾	Usable Seat Depth:	15¾
Seat Depth:	15¾	Ship Weight:	40
Seat Width:	19¾	Cube:	16.0
Back Width:	21⅝	COM:	2.0
Back Height:	29¾	Weight Rating:	300 lbs.

FABRIC PRICE CODES

1	\$679	8	\$955
2	\$727	9	\$991
3	\$775	10	\$1027
4	\$811	11	\$1063
5	\$847	12	\$1099
6	\$883	L	—
7	\$919		

HON Recommendation: HLEU.Y2.A.A.CU___.SB - List Price \$819

HOW TO SPECIFY

Select Model Number	Select Control Type	Select Arm Type	Select Caster/Glide	Select Fabric	Select Base
	S1 Limited Synchro-Tilt Y2 Synchro-Tilt (+ \$65) Y3 Synchro-Tilt with Independent Back Angle (+ \$105) W5 Weight-Activated (+ \$150)	N Armless F Fixed Arms - Black (+ \$65) A Height and Width Adjustable Arms (+ \$75) V All-Adjustable Arms (includes pivot) (+ \$115) P Fixed Arms - Polished (+ \$150)	A All-Surface Caster	See page 74	SB Standard Base PA Polished Aluminum (+ \$110)
HLEU	Y2	A	A	CU10	SB

ENDORSE™



Icon Legend on page 14

HLWU

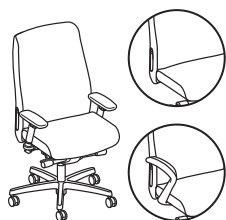

TASK MID-BACK

Upholstered Back

Pneumatic
Swivel
Synchro-tilt
Tilt Tension
Tilt Lock
Integral Lumbar Support

Functions: **A, E, J, K, L, W**
(Function Key on pages 16-17)

DIMENSIONS

Depth:	28½	Adjustable Arms Width:	17½-20½
Width:	28½	Fixed Arms Width:	20½
Height:	44½	Seat to Floor Height:	16¾-22
Seat Depth:	15¾	Usable Seat Depth:	15¾
Seat Width:	19¾	Ship Weight:	51
Back Width:	21¼	Cube:	11.1
Back Height:	25	COM:	2.0
		Weight Rating:	300 lbs.

FABRIC PRICE CODES

1	\$653	8	\$929
2	\$701	9	\$965
3	\$749	10	\$1001
4	\$785	11	\$1037
5	\$821	12	\$1073
6	\$857	L	—
7	\$893		

❗ Do not need to specify back option for Upholstered Back models. Dimensions, weights and cubes shown above are for models using the S1 Endorse™ control only. See page 73 for all other control specifications.

HLWM

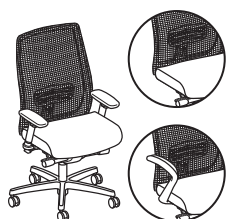

TASK MID-BACK

ilira®-Stretch Back

Pneumatic
Swivel
Synchro-tilt
Tilt Tension
Tilt Lock
Integral Lumbar Support

Functions: **A, E, J, K, L, W**
(Function Key on pages 16-17)

DIMENSIONS

Depth:	28½	Adjustable Arms Width:	17½-20½
Width:	28½	Fixed Arms Width:	20½
Height:	44½	Seat to Floor Height:	16¾-22
Seat Depth:	15¾	Usable Seat Depth:	15¾
Seat Width:	19¾	Ship Weight:	48
Back Width:	19	Cube:	11.1
Back Height:	25	COM:	1.0
		Weight Rating:	300 lbs.

FABRIC PRICE CODES

1	\$653	8	\$791
2	\$677	9	\$809
3	\$701	10	\$827
4	\$719	11	\$845
5	\$737	12	\$863
6	\$755	L	\$853
7	\$773		

NOTES: For Mesh Back models, specify the ilira®-stretch back option below. Headrest available on Mid-back ilira®-stretch models only – Black only.

❗ Dimensions, weights and cubes shown above are for models using the S1 Endorse™ control only. See page 73 for all other control specifications.

HON Recommendation: HLWM.Y2.A.H.IM.CU__SB.N - List Price \$793

HOW TO SPECIFY

Select Model Number	Select Control Type	Select Arm Type	Select Caster/Glide	Select Mesh Back	Select Fabric	Select Base	Select Head Rest
S1 Limited Synchro-Tilt Y2 Synchro-Tilt (+ \$65) Y3 Synchro-Tilt with Independent Back Angle (+ \$105) W5 Weight-Activated (+ \$150)	N Armless F Fixed Arms - Black (+ \$65) A Height and Width Adjustable Arms (+ \$75) V All-Adjustable Arms (includes pivot) (+ \$115) P Fixed Arms - Polished (+ \$150)	H Hard Caster S Soft Caster (+ \$30) R Roll Control Caster (+ \$50)	ilira®-stretch options IM Black IF Fog IV Vanilla IC Charcoal IH Chai IY Navy <i>Specify the back for Mesh Back models only</i>	See page 74	SB Standard Base PA Polished Aluminum (+ \$110)	N No Headrest HR Headrest (+ \$80) <i>Black only. Specify for model HLWM only</i>	
H L W M .	Y 2 .	A .	H .	I M .	C U 1 0 .	S B .	N .



HLTU

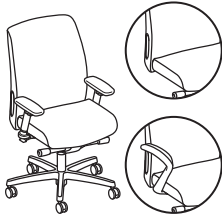

TASK LOW-BACK

Upholstered Back

- Pneumatic
- Swivel
- Synchro-tilt
- Tilt Tension
- Tilt Lock
- Integral Lumbar Support

Functions: **A, E, J, K, L, W**
(Function Key on pages 16-17)

! Do not need to specify back option for Upholstered Back models. Dimensions, weights and cubes shown above are for models using the S1 Endorse™ control only. See page 73 for all other control specifications.

DIMENSIONS

Depth:	28½	Adjustable Arms Width:	16¾-19¼
Width:	28½	Fixed Arms Width:	19½
Height:	41¼	Seat to Floor Height:	16⅞-22
Seat Depth:	15⅞	Usable Seat Depth:	15⅞
Seat Width:	18⅞	Ship Weight:	51
Back Width:	19¾	Cube:	11.1
Back Height:	22¾	COM:	2.0
		Weight Rating:	300 lbs.

FABRIC PRICE CODES

1	\$607	8	\$883
2	\$655	9	\$919
3	\$703	10	\$955
4	\$739	11	\$991
5	\$775	12	\$1027
6	\$811	L	—
7	\$847		

HLTM

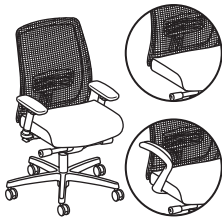

TASK LOW-BACK

ilira®-Stretch Back

- Pneumatic
- Swivel
- Synchro-tilt
- Tilt Tension
- Tilt Lock
- Integral Lumbar Support

Functions: **A, E, J, K, L, W**
(Function Key on pages 16-17)

NOTES: For Mesh Back models, specify the ilira®-stretch back option below.

! Dimensions, weights and cubes shown above are for models using the S1 Endorse™ control only. See page 73 for all other control specifications.

DIMENSIONS

Depth:	28½	Adjustable Arms Width:	16¾-19¼
Width:	28½	Fixed Arms Width:	19½
Height:	40¼	Seat to Floor Height:	16⅞-22
Seat Depth:	15⅞	Usable Seat Depth:	15⅞
Seat Width:	18⅞	Ship Weight:	32
Back Width:	17¾	Cube:	11.1
Back Height:	21¾	COM:	1.0
		Weight Rating:	300 lbs.

FABRIC PRICE CODES

1	\$607	8	\$745
2	\$631	9	\$763
3	\$655	10	\$781
4	\$673	11	\$799
5	\$691	12	\$817
6	\$709	L	\$807
7	\$727		

HLTP

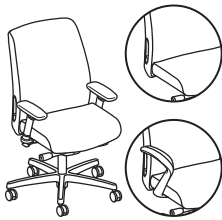

TASK LOW-BACK

Plastic Outer Back

- Pneumatic
- Swivel
- Synchro-tilt
- Tilt Tension
- Tilt Lock
- Integral Lumbar Support

Functions: **A, E, J, K, L, W**
(Function Key on pages 16-17)

! Do not need to specify back option for Plastic Outer Back models. Dimensions, weights and cubes shown above are for models using the S1 Endorse™ control only. See page 73 for all other control specifications.

DIMENSIONS

Depth:	28½	Adjustable Arms Width:	16¾-19¼
Width:	28½	Fixed Arms Width:	19½
Height:	41¼	Seat to Floor Height:	16⅞-22
Seat Depth:	15⅞	Usable Seat Depth:	15⅞
Seat Width:	18⅞	Ship Weight:	40
Back Width:	19¾	Cube:	11.1
Back Height:	22¾	COM:	2.0
		Weight Rating:	300 lbs.

FABRIC PRICE CODES

1	\$658	8	\$934
2	\$706	9	\$970
3	\$754	10	\$1006
4	\$790	11	\$1042
5	\$826	12	\$1078
6	\$862	L	—
7	\$898		

HON Recommendation: HLTM.Y2.A.H.IM.CU__SB - List Price \$747

HOW TO SPECIFY

Select Model Number	Select Control Type	Select Arm Type	Select Caster/Glide	Select Mesh Back	Select Fabric	Select Base
S1 Limited Synchro-Tilt Y2 Synchro-Tilt (+ \$65) Y3 Synchro-Tilt with Independent Back Angle (+ \$105) W5 Weight-Activated (+ \$150)	N Armless F Fixed Arms - Black (+ \$65) A Height and Width Adjustable Arms (+ \$75) V All-Adjustable Arms (includes pivot) (+ \$115) P Fixed Arms - Polished (+ \$150)	H Hard Caster S Soft Caster (+ \$30) R Roll Control Caster (+ \$50)	ilira®-stretch options IM Black IF Fog IV Vanilla IC Charcoal IH Chai IY Navy <i>Specify the back for Mesh Back models only</i>	See page 74	SB Standard Base PA Polished Aluminum (+ \$110)	
HLTM	Y2	A	H	IM	CU10	SB

ENDORSE™



Icon Legend on page 14

HLWUBT

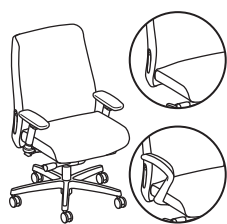

TASK MID-BACK

Big and Tall Upholstered Back

Pneumatic
Seat-glide
Swivel
Synchro-tilt
Tilt Lock
Side Tilt Tension
Integral Lumbar Support

Functions: **A, D, E, A-D, J, L, W**
(Function Key on pages 16-17)

! Do not need to specify back option for Upholstered Back models.

DIMENSIONS

Depth:	31½	Adjustable Arms Width:	21½-23¾
Width:	31½	Fixed Arms Width:	24
Height:	44⅝	Seat to Floor Height:	18-22¼
Seat Depth:	21	Usable Seat Depth:	17¾-19¼
Seat Width:	23	Ship Weight:	65
Back Width:	23½	Cube:	15.3
Back Height:	25	COM:	2.0
		Weight Rating:	450 lbs.

FABRIC PRICE CODES

1	\$1087	8	\$1363
2	\$1135	9	\$1399
3	\$1183	10	\$1435
4	\$1219	11	\$1471
5	\$1255	12	\$1507
6	\$1291	L	—
7	\$1327		

HLWMBT



TASK MID-BACK

Big and Tall ilira®-Stretch Back

Pneumatic
Seat-glide
Swivel
Synchro-tilt
Tilt Lock
Side Tilt Tension
Integral Lumbar Support

Functions: **A, D, E, A-D, J, L, W**
(Function Key on pages 16-17)

NOTES: For Mesh Back models, specify the ilira®-stretch back option below. Headrest available on Mid-back ilira®-stretch models only - Black only.

DIMENSIONS

Depth:	31½	Adjustable Arms Width:	21½-23¾
Width:	31½	Fixed Arms Width:	24
Height:	44⅝	Seat to Floor Height:	18-22¼
Seat Depth:	21	Usable Seat Depth:	17¼-18¾
Seat Width:	23	Ship Weight:	75
Back Width:	22½	Cube:	15.3
Back Height:	25¼	COM:	1.5
		Weight Rating:	450 lbs.

FABRIC PRICE CODES

1	\$1087	8	\$1294
2	\$1123	9	\$1321
3	\$1159	10	\$1348
4	\$1186	11	\$1375
5	\$1213	12	\$1402
6	\$1240	L	\$1387
7	\$1267		

HLEUBT

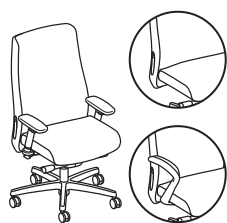

EXECUTIVE HIGH-BACK

Big and Tall Upholstered Back

Pneumatic
Seat-glide
Swivel
Synchro-tilt
Tilt Lock
Side Tilt Tension
Integral Lumbar Support

Functions: **A, D, E, A-D, J, L, W**
(Function Key on pages 16-17)

! Executive High-back Big and Tall models are available with an upholstered back only.

DIMENSIONS

Depth:	31½	Adjustable Arms Width:	21½-23¾
Width:	31½	Fixed Arms Width:	24
Height:	46⅜	Seat to Floor Height:	18-22¼
Seat Depth:	21	Usable Seat Depth:	17¾-19¼
Seat Width:	23	Ship Weight:	74
Back Width:	23¼	Cube:	16.0
Back Height:	28¼	COM:	2.0
		Weight Rating:	450 lbs.

FABRIC PRICE CODES

1	\$1112	8	\$1388
2	\$1160	9	\$1424
3	\$1208	10	\$1460
4	\$1244	11	\$1496
5	\$1280	12	\$1532
6	\$1316	L	—
7	\$1352		

HON Recommendation: HLWMBT.Y4.A.A.IM.CU__SB.N - List Price \$1162

HOW TO SPECIFY

Select Model Number	Select Control Type	Select Arm Type	Select Caster/Glide	Select Mesh Back	Select Fabric	Select Base	Select Head Rest
HLWMBT	Y4 Synchro-Tilt <i>Y4 is the only control option for the Big and Tall models</i>	N Armless F Fixed Arms - Black (+ \$65) A Height and Width Adjustable Arms (+ \$75) V All-Adjustable Arms (includes pivot) (+ \$115) P Fixed Arms - Polished (+ \$150)	A All-surface Caster <i>All-surface caster available on Big and Tall models only</i>	IM ilira®-stretch option <i>Black only</i> IM Black <i>Specify the back for Mesh Back models only</i>	See page 74	SB Standard Base PA Polished Aluminum (+ \$110)	N No Head Rest HR Head Rest (+ \$80) <i>Black only. Specify for model HLWMBT only</i>



HLTSU



STOOL

Upholstered Back

- Pneumatic
- Swivel
- Synchro-tilt
- Tilt Tension
- Tilt Lock
- Integral Lumbar Support

Functions: **A, E, J, K, L, W**
(Function Key on pages 16-17)

! Do not need to specify back option for Upholstered Back models.

DIMENSIONS

Depth:	28½	Adjustable Arms Width:	16¾-19¼
Width:	28½	Fixed Arms Width:	19½
Height:	53½	Seat to Floor Height:	23¼-33¼
Seat Depth:	15⅝	Usable Seat Depth:	15⅝
Seat Width:	18⅞	Ship Weight:	60
Back Width:	19¾	Cube:	11.1
Back Height:	22¾	COM:	2.0
		Weight Rating:	300 lbs.

FABRIC PRICE CODES

1	\$725	8	\$1001
2	\$773	9	\$1037
3	\$821	10	\$1073
4	\$857	11	\$1109
5	\$893	12	\$1145
6	\$929	L	—
7	\$965		

HLTSM



STOOL

ilira®-Stretch Back

- Pneumatic
- Swivel
- Synchro-tilt
- Tilt Tension
- Tilt Lock
- Integral Lumbar Support

Functions: **A, E, J, K, L, W**
(Function Key on pages 16-17)

NOTES: For Mesh Back models, specify the ilira®-stretch back option below.

DIMENSIONS

Depth:	28½	Adjustable Arms Width:	16¾-19¼
Width:	28½	Fixed Arms Width:	19½
Height:	52½	Seat to Floor Height:	23¼-33¼
Seat Depth:	15⅝	Usable Seat Depth:	15⅝
Seat Width:	18⅞	Ship Weight:	54
Back Width:	17¾	Cube:	11.1
Back Height:	21¾	COM:	1.0
		Weight Rating:	300 lbs.

FABRIC PRICE CODES

1	\$725	8	\$863
2	\$749	9	\$881
3	\$773	10	\$899
4	\$791	11	\$917
5	\$809	12	\$935
6	\$827	L	\$925
7	\$845		

HLTSP



STOOL

Plastic Outer Back

- Pneumatic
- Swivel
- Synchro-tilt
- Tilt Tension
- Tilt Lock
- Integral Lumbar Support

Functions: **A, E, J, K, L, W**
(Function Key on pages 16-17)

! Do not need to specify back option for Outer Back models.

DIMENSIONS

Depth:	28½	Adjustable Arms Width:	16¾-19¼
Width:	28½	Fixed Arms Width:	19½
Height:	52½	Seat to Floor Height:	23¼-33¼
Seat Depth:	15⅝	Usable Seat Depth:	15⅝
Seat Width:	18⅞	Ship Weight:	65
Back Width:	19¾	Cube:	11.1
Back Height:	22¾	COM:	2.0
		Weight Rating:	300 lbs.

FABRIC PRICE CODES

1	\$776	8	\$1052
2	\$824	9	\$1088
3	\$872	10	\$1124
4	\$908	11	\$1160
5	\$944	12	\$1196
6	\$980	L	—
7	\$1016		

HON Recommendation: HLTSM.S1.A.H.IM.CU__SB - List Price \$800

HOW TO SPECIFY

Select Model Number	Select Control Type	Select Arm Type	Select Caster/Glide	Select Mesh Back	Select Fabric	Select Base
HLTSM	S1 Limited Synchro-Tilt <i>S1 is the only control option for the Stool models</i>	N Armless F Fixed Arms - Black (+ \$65) A Height and Width Adjustable Arms (+ \$75) V All-Adjustable Arms (includes pivot) (+ \$115) P Fixed Arms - Polished (+ \$150)	H Hard Caster S Soft Caster (+ \$30) R Roll Control Caster (+ \$50)	ilira®-stretch options IM Black IF Fog IV Vanilla IC Charcoal IH Chai IY Navy <i>Specify the back for Mesh Back models only</i>	See page 74	SB Standard Base PA Polished Aluminum (+ \$110)
HLTSM	S1	A	H	IM	CU10	SB



HL2DARM



ADJUSTABLE T-ARMS

Height and Width
Functions: **S**
(Function Key on pages 16-17)

DIMENSIONS

Adjustable Arms Width: 16¾-19¼
Height from Seat: 7¼-11
Ship Weight: 8 **S**
Cube: 1.0

LIST PRICE

\$114

! Available in Black only. No need to specify.

HL4DARM



ALL ADJUSTABLE ARMS

Height, Width, Depth and Pivot

DIMENSIONS

Adjustable Arms Width: 16¾-19¼
Height from Seat: 7¼-11
Ship Weight: 8 **S**
Cube: 1.0

LIST PRICE

\$154

! Available in Black only. No need to specify.

HIFHA



FIXED HEIGHT ARMS

DIMENSIONS

Arm Width: 20
Height from Seat: 9½
Ship Weight: 7 **S**
Cube: 1.0

LIST PRICE

\$104

HIPAA



POLISHED ALUMINUM ARMS

Fixed Height

DIMENSIONS

Arm Width: 20
Height from Seat: 9½
Ship Weight: 10 **S**
Cube: 1.0

LIST PRICE

\$180

HLMSHHR



MESH HEADREST

DIMENSIONS

Mesh Width: 12
Mesh Height: 6
Ship Weight: 3 **S**
Cube: 1.0

QA DIMENSIONS

(Attachment Mechanism)

Width: 12
Depth: 6
Height: 12

LIST PRICE

\$119

! Available in Black Mesh (IM) only. For use with Mesh Mid-back models only.



HL1SL



LOUNGE

Single Seat

DIMENSIONS

Depth:	33½	Arm Width:	24
Width:	30½	Seat to Floor Height:	18¼
Height:	26¼	Usable Seat Depth:	20½
Seat Depth:	22	Ship Weight:	75
Seat Width:	23½	Cube:	19.0
Back Width:	23½	COM:	4.5
Back Height:	19½	Weight Rating:	300 lbs.

FABRIC PRICE CODES

1	\$1487	8	\$2108
2	\$1595	9	\$2189
3	\$1703	10	\$2270
4	\$1784	11	\$2351
5	\$1865	12	\$2432
6	\$1946	L	\$2387
7	\$2027		

HL2SL

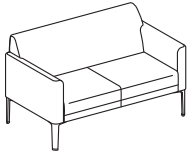

LOUNGE

Two-Seat

DIMENSIONS

Depth:	33½	Arm Width:	48
Width:	54½	Seat to Floor Height:	18¼
Height:	26¼	Usable Seat Depth:	20½
Seat Depth:	22	Ship Weight:	100
Seat Width:	47½	Cube:	33.4
Back Width:	47½	COM:	6.0
Back Height:	19½	Weight Rating:	300 lbs.

FABRIC PRICE CODES

1	\$2007	8	\$2835
2	\$2151	9	\$2943
3	\$2295	10	\$3051
4	\$2403	11	\$3159
5	\$2511	12	\$3267
6	\$2619	L	\$3207
7	\$2727		

HL3SL

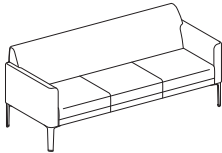

LOUNGE

Three-Seat

DIMENSIONS

Depth:	33½	Arm Width:	72
Width:	78½	Seat to Floor Height:	18¼
Height:	26¼	Usable Seat Depth:	20½
Seat Depth:	22	Ship Weight:	115
Seat Width:	71½	Cube:	45.7
Back Width:	71½	COM:	7.5
Back Height:	19½	Weight Rating:	300 lbs.

FABRIC PRICE CODES

1	\$2676	8	\$3711
2	\$2856	9	\$3846
3	\$3036	10	\$3981
4	\$3171	11	\$4116
5	\$3306	12	\$4251
6	\$3441	L	\$4176
7	\$3576		

HON Recommendation: HL1SL.RL.PNS__P6N - List Price \$1595

HOW TO SPECIFY

<p>Select Model Number</p> <p>HL1SL</p>	<p>Select Leg Type</p> <p>RL Rounded Leg</p> <p>RL</p>	<p>Select Fabric</p> <p>See page 74</p> <p>PNS007</p>	<p>Select Frame</p> <p>BLCK Textured Black P6N Textured Satin Chrome</p> <p>P6N</p>
--	---	--	--

ENDORSE™ Tables

GSA SIN 711-11



HLOCC1



Model shown without
grommet option



SQUARE

Open All Sides

DIMENSIONS

Depth:	24	Ship Weight:	45
Width:	24	Cube:	2.6
Height:	19		

LIST PRICE

Laminate 1	\$791
Laminate 2	\$806

NOTES: Ships in two boxes. For additional grommet options, see page 112.

HLOCC2



Model shown with
Round grommet option



SQUARE

Open Front and Back

DIMENSIONS

Depth:	24	Ship Weight:	55
Width:	24	Cube:	2.6
Height:	19		

LIST PRICE

Laminate 1	\$853
Laminate 2	\$868

NOTES: Enclosed on sides. Ships in three boxes. For additional grommet options, see page 112.

HLOCC3

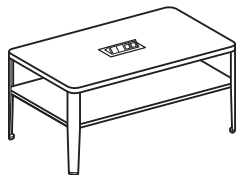

Model shown with Flip-top
Port grommet option



RECTANGULAR

Open All Sides

DIMENSIONS

Depth:	24	Ship Weight:	65
Width:	40	Cube:	3.1
Height:	19		

LIST PRICE

Laminate 1	\$918
Laminate 2	\$938

NOTES: Ships in two boxes. For additional grommet options, see page 112.

HWPWRGROM1

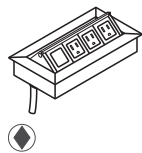

POP-UP PORT

- Fits into 4" x 8" cutout.
- Specify G1 cutout in table top.
- Pop-up Port provides three power ports and one blank data receptacle.
- Sits flush with worksurface when closed.
- Finish is anodized aluminum.
- Includes 6' cord with three-prong plug.

DIMENSIONS

Ship Weight:	5
Cube:	0.3

LIST PRICE

\$343

HON Recommendation: HLOCC3.N.PINCPINC.P6N - List Price \$918

HOW TO SPECIFY

<p>Select Model Number</p> <p>HLOCC3</p>	<p>Select Grommet Option</p> <p>N No Grommet G Round Grommet (+ \$15) G1 Pop-up Port Grommet Cut-out only (+ \$40)</p> <p>N</p>	<p>Select Laminate and Edge</p> <p>See page 74</p> <p>PINCPINC</p>	<p>Select Frame</p> <p>BLCK Textured Black P6N Textured Satin Chrome</p> <p>P6N</p>
--	---	--	---

FLOCK®



Flock Seating and Tables.

FLOCK®

Break away. Come together. Wherever people migrate within a space, Flock is designed to support their needs. With a full collection of mobile, flexible and comfortable seating elements and coordinating collaborative tables that work seamlessly together, you can make the most of every square inch of your space. Modular lounge chairs and ottomans stand alone or combine to create large arrangements. Multipurpose stools and chairs add comfort to open spaces. Collaborative tables that bring the whole group together. Flock helps people interact with each other, challenge one another, and receive the support they need.



CHAIR FEATURES

- Round and square lounge chairs are fully-upholstered.
- The contemporary aesthetic easily matches a variety of surroundings.
- Support everything from one-on-one conversations to large meetings.
- Choose from four leg options — standard, tapered round, tapered square or hard casters.
- Standard legs can be adjusted ½" for leveling.
- Available in hundreds of quality HON fabrics.
- Warranted for users up to 300 lbs.

COLLABORATIVE TABLES

- Choose from round, square, rectangle or racetrack shaped table tops.
- Optional grommets neatly route cords.
- Bases available in disc, T-leg and X-leg styles.
- Choose bases with or without footings.
- Each base includes leveling glides that adjust in 1" increments.
- Tops are available in eight laminate finishes.
- Bases are available in either Textured Satin Chrome or Textured Charcoal finish.

FLOCK® Options

MODEL OPTIONS

HFLSC1
HFLSC1DF - Dual Fabric

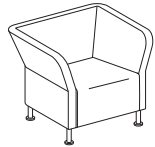

Lounge Chair
Square

HFLRC1
HFLRC1DF - Dual Fabric



Lounge Chair
Round

HFLMC1
HFLMC1 - Dual Fabric



Modular Chair

HFLML1
HFLML1DF - Dual Fabric

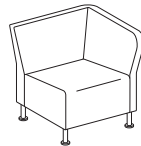

Modular
Left End

HFLMR1
HFLMR1DF - Dual Fabric

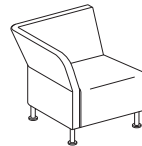

Modular
Right End

LEG STYLE



L Standard Leg **+\$0**



TS Tapered Square **+\$0**



TR Tapered Round **+\$0**



H Hard Casters **+\$0**

LEG COLOR

CODE DESCRIPTION PRICE

P6N Textured Satin Chrome **+\$0**

P7N Textured Charcoal **+\$0**

**Specify P6N and P7A for Standard, Tapered Round and Tapered Square legs only*

T Black Hard Caster **+\$0**

**Specify for Hard Caster option only*

FLOCK® Fabric Options

AVAILABLE FABRICS

GRADE 1	GRADE 2	GRADE 3	GRADE 4	GRADE 5	GRADE 6	GRADE 7	GRADE 8	GRADE 9	GRADE 10	GRADE 11	GRADE 12	GRADE L
Arrondi * Attire Centurion Compass Confetti Contourette Polyurethane Dapper Inertia Optic Stitchery Tectonic	Appoint Seating Bangle Clyde Dotty Esplanade * Expo Fuse Gio * Moguls Origin Seed Sockhop Spin Seating Whisper Vinyl	Canter Polyurethane Epic Infinity Knack Marathon Millennium Odyssey Silvertex™ Vinyl Syntax Tradition Via	Bar Beeline Blip Coin Cover Cloth Current Decode Disc Divide Free Habit Hive Lineup Manner Medium Messenger Metric Oblique Pick Sprint Technic	Amuse Avenue Lariat Outlander Polka Riddle Sentry-HC Sequence Solace Tribeca	Intermix II Keynote Raffia Vinyl Velocity Wooly	Ascend Central Channel Domain Synergy Waver	Brisa® Polyurethane Kindred	Eli Vinyl Martini Vinyl Olympus Vinyl Silica Silica Leather Silica Tech	Affinity Concentric Juxy	Acrobat Natural World Whirl	Fenestra Helix Lava Ripple	Denver Leather (Matches EE Vinyl)

Flock® chair model HFLRC1 has fabric limitations, please see the Flock® seating pages 86-91 for details.

Reference Fabric Color Combinations on pages 18-29 for color codes and legend on page 19 for lead times. Visit hon.com for additional partnership fabrics.

NOTES: Gathers and creases may be more visible with Attire (AI) and Optic (OP) fabrics due to the inherent design and construction of these fabrics.

🔥 For Fire Code model, availability and ordering method, refer to pages 34-39. Available on select models, contact HON Customer Support for availability.

* Fabric is de-emphasized.

FLOCK® ROUND LOUNGE HFLRC1/DF AND STOOL HFSS7 AVAILABLE FABRICS

GRADE 1	GRADE 2	GRADE 3	GRADE 4	GRADE 5	GRADE 6	GRADE 7	GRADE 8	GRADE 9	GRADE 10	GRADE 11	GRADE 12	GRADE L
Arrondi * Centurion Compass Confetti Contourette Polyurethane Dapper Inertia Optic Tectonic	Appoint Seating Bangle Clyde Expo Fuse Gio * Moguls Origin Seed Spin Seating Whisper Vinyl	Canter Polyurethane Epic Infinity Marathon Millennium Odyssey Silvertex™ Vinyl Tradition Via	Beeline Cover Cloth Current Blip Manner Medium Messenger Metric Sprint	Lariat Outlander Sentry-HC Sequence Solace Tribeca	Keynote Velocity Wooly		Kindred	Silica Silica Leather Silica Tech				Denver Leather (Matches EE Vinyl)

Reference Fabric Color Combinations on pages 18-29 for color codes and legend on page 19 for lead times. Visit hon.com for additional partnership fabrics.

NOTES: Gathers and creases may be more visible with Optic (OP) fabric due to the inherent design and construction of these fabrics.

🔥 For Fire Code model, availability and ordering method, refer to pages 34-39. Available on select models, contact HON Customer Support for availability.

* Fabric is de-emphasized.

HFLSC1

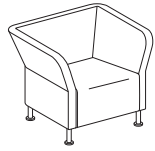

LOUNGE CHAIR

Square

DIMENSIONS

Depth:	28½	Arm Width:	27½
Width:	34¼	Seat to Floor Height:	17
Height:	28	Usable Seat Depth:	20½
Seat Depth:	20½	Ship Weight:	48
Seat Width:	21½	Cube:	27.0
Back Width:	21½	COM:	5.0
Back Height:	18½	Weight Rating:	300 lbs.

FABRIC PRICE CODES

1	\$1621	8	\$2242
2	\$1729	9	\$2323
3	\$1837	10	\$2404
4	\$1918	11	\$2485
5	\$1999	12	\$2566
6	\$2080	L	\$2521
7	\$2161		

NOTES: Standard legs (L) can be adjusted ½" for leveling. Tapered Round and Square legs do not adjust. Tapered support leg molded from high-impact nylon. Both Round and Square Lounge chairs are fully-upholstered.

! Leg options – Standard Leg (L), Tapered Square (TS) and Tapered Round (TR) are available in Textured Satin Chrome (P6N) and Textured Charcoal (P7A) only. Hard Casters (H) are available on Black (T) only.

HFLRC1

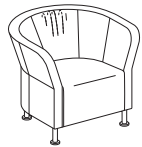
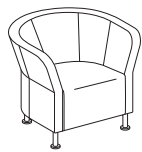

LOUNGE CHAIR

Round

DIMENSIONS

Depth:	29	Arm Width:	27½
Width:	33½	Seat to Floor Height:	17
Height:	28	Usable Seat Depth:	20½
Seat Depth:	20½	Ship Weight:	39
Seat Width:	20½	Cube:	27.0
Back Width:	20½	Weight Rating:	300 lbs.
Back Height:	18½		

FABRIC PRICE CODES

1	\$1694	8	\$2246
2	\$1790	9	\$2318
3	\$1886	10	\$2390
4	\$1958	11	\$2462
5	\$2030	12	\$2534
6	\$2102	L	\$2494
7	\$2174		

NOTES: Standard legs (L) can be adjusted ½" for leveling. Tapered Round and Square legs do not adjust. Tapered support leg molded from high-impact nylon. Both Round and Square Lounge chairs are fully-upholstered. Due to the inherent design of the Round Lounge chair, material gathers will be present in the back.

! Round Lounge models HFLRC1 / HFLRCIDF are offered in select fabrics; for availability, please see the Fabric Matrix on page 85. Also approved in limited Partnership Fabrics. Leg options – Standard Leg (L), Tapered Square (TS) and Tapered Round (TR) are available in Textured Satin Chrome (P6N) and Textured Charcoal (P7A) only. Hard Casters (H) are available on Black (T) only. Customer's Own Material (COM) is not available on Flock® models HFLRC1 or HFSS7.

The following fabric pattern will be railroaded on Flock® Seating (does not apply to stool model HFSS7 and HFLRC1):

RI Stitchery

HON Recommendation: HFLSC1.TS.PNS__P7A - List Price \$1729

HOW TO SPECIFY

<p>Select Model Number</p>	<p>Select Leg Option</p> <p>L Standard Leg TS Tapered Square TR Tapered Round H Hard Casters</p>	<p>Select Fabric</p> <p>See page 85</p>	<p>Select Leg Color</p> <p>P6N Textured Satin Chrome P7A Textured Charcoal</p> <p><i>Specify for Standard, Tapered Round and Tapered Square legs only</i></p> <p>T Black Hard Caster <i>Specify for Hard Caster option only</i></p>
<div style="border: 1px solid black; display: inline-block; padding: 2px;">H</div> <div style="border: 1px solid black; display: inline-block; padding: 2px;">F</div> <div style="border: 1px solid black; display: inline-block; padding: 2px;">L</div> <div style="border: 1px solid black; display: inline-block; padding: 2px;">S</div> <div style="border: 1px solid black; display: inline-block; padding: 2px;">C</div> <div style="border: 1px solid black; display: inline-block; padding: 2px;">1</div>	<div style="border: 1px solid black; display: inline-block; padding: 2px;">T</div> <div style="border: 1px solid black; display: inline-block; padding: 2px;">S</div>	<div style="border: 1px solid black; display: inline-block; padding: 2px;">P</div> <div style="border: 1px solid black; display: inline-block; padding: 2px;">N</div> <div style="border: 1px solid black; display: inline-block; padding: 2px;">S</div> <div style="border: 1px solid black; display: inline-block; padding: 2px;">0</div> <div style="border: 1px solid black; display: inline-block; padding: 2px;">0</div> <div style="border: 1px solid black; display: inline-block; padding: 2px;">7</div>	<div style="border: 1px solid black; display: inline-block; padding: 2px;">P</div> <div style="border: 1px solid black; display: inline-block; padding: 2px;">7</div> <div style="border: 1px solid black; display: inline-block; padding: 2px;">A</div>



HFLMC1

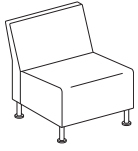

MODULAR CHAIR

DIMENSIONS

Depth:	28½	Seat to Floor Height:	17
Width:	25	Usable Seat Depth:	20½
Height:	28	Ship Weight:	52
Seat Depth:	20½	Cube:	24.0
Seat Width:	25	COM:	3.0
Back Width:	25	Weight Rating:	300 lbs.
Back Height:	18½		

FABRIC PRICE CODES

1	\$1187	8	\$1601
2	\$1259	9	\$1655
3	\$1331	10	\$1709
4	\$1385	11	\$1763
5	\$1439	12	\$1817
6	\$1493	L	\$1787
7	\$1547		

NOTES: Standard legs (L) can be adjusted ½" for leveling. Tapered Round and Square legs do not adjust. Tapered support leg molded from high-impact nylon.

ⓘ Leg options – Standard Leg (L), Tapered Square (TS) and Tapered Round (TR) are available in Textured Satin Chrome (P6N) and Textured Charcoal (P7A) only. Hard Casters (H) are available on Black (T) only.

HFLML1

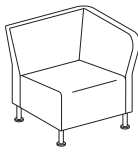

MODULAR

Left End

DIMENSIONS

Depth:	28½	Seat to Floor Height:	17
Width:	28½	Usable Seat Depth:	20½
Height:	28	Ship Weight:	72
Seat Depth:	20½	Cube:	24.0
Seat Width:	22¼	COM:	4.0
Back Width:	22¼	Weight Rating:	300 lbs.
Back Height:	18½		

FABRIC PRICE CODES

1	\$1401	8	\$1953
2	\$1497	9	\$2025
3	\$1593	10	\$2097
4	\$1665	11	\$2169
5	\$1737	12	\$2241
6	\$1809	L	\$2201
7	\$1881		

NOTES: Standard legs (L) can be adjusted ½" for leveling. Tapered Round and Square legs do not adjust. Tapered support leg molded from high-impact nylon.

ⓘ Leg options – Standard Leg (L), Tapered Square (TS) and Tapered Round (TR) are available in Textured Satin Chrome (P6N) and Textured Charcoal (P7A) only. Hard Casters (H) are available on Black (T) only.

HFLMR1

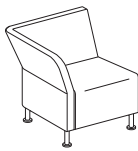

MODULAR

Right End

DIMENSIONS

Depth:	28½	Seat to Floor Height:	17
Width:	28½	Usable Seat Depth:	20½
Height:	28	Ship Weight:	72
Seat Depth:	20½	Cube:	24.0
Seat Width:	22¼	COM:	4.0
Back Width:	22¼	Weight Rating:	300 lbs.
Back Height:	18½		

FABRIC PRICE CODES

1	\$1401	8	\$1953
2	\$1497	9	\$2025
3	\$1593	10	\$2097
4	\$1665	11	\$2169
5	\$1737	12	\$2241
6	\$1809	L	\$2201
7	\$1881		

NOTES: Standard legs (L) can be adjusted ½" for leveling. Tapered Round and Square legs do not adjust. Tapered support leg molded from high-impact nylon.

ⓘ Leg options – Standard Leg (L), Tapered Square (TS) and Tapered Round (TR) are available in Textured Satin Chrome (P6N) and Textured Charcoal (P7A) only. Hard Casters (H) are available on Black (T) only.

The following fabric pattern will be railroaded on Flock® Seating (does not apply to stool model HFSS7):
RI Stitchery

HON Recommendation: HFLMC1.TS.PNS__P6N - List Price \$1259

HOW TO SPECIFY

Select Model Number	Select Leg Option	Select Fabric	Select Leg Color
HFLMC1	L Standard Leg TS Tapered Square TR Tapered Round H Hard Casters	See page 85	P6N Textured Satin Chrome P7A Textured Charcoal <i>Specify for Standard, Tapered Round and Tapered Square legs only</i> T Black Hard Caster <i>Specify for Hard Caster option only</i>
HFLMC1	TS	PNS007	P6N

HFLSO1

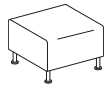

OTTOMAN

Square

DIMENSIONS

Depth:	25	Ship Weight:	30.0
Width:	25	Cube:	7.5
Height:	17	COM:	2.0
Seat Depth:	25	Weight Rating:	300 lbs.
Seat Width:	25		

FABRIC PRICE CODES

1	\$685	8	\$961
2	\$733	9	\$997
3	\$781	10	\$1033
4	\$817	11	\$1069
5	\$853	12	\$1105
6	\$889	L	\$1085
7	\$925		

NOTES: Standard legs (L) can be adjusted 1/2" for leveling. Tapered Round and Square legs do not adjust. Tapered support leg molded from high-impact nylon.

! Leg options – Standard Leg (L), Tapered Square (TS) and Tapered Round (TR) are available in Textured Satin Chrome (P6N) and Textured Charcoal (P7A) only. Hard Casters (H) are available on Black (T) only.

HFLGANG

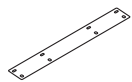

GANGING BRACKET

For Flock® Modular Seating Models

- Can be used for in-line ganging ONLY
- Use one bracket to connect two models. Do not connect more than four models (models HFLMCI, HFLML1, HFLMRI, or HFLSO1).
- No specification required for bracket

DIMENSIONS

Ship Weight:	0.5
Cube:	0.1

LIST PRICE

\$30

The following fabric pattern will be railroaded on Flock® Seating (does not apply to stool model HFSS7):

RI Stitchery

HON Recommendation: HFLSO1.TS.PNS__P6N - List Price \$733

HOW TO SPECIFY

<p>Select Model Number</p> <p>H F L S O 1 .</p>	<p>Select Leg Option</p> <p>L Standard Leg TS Tapered Square TR Tapered Round H Hard Casters</p> <p>T S .</p>	<p>Select Fabric</p> <p>See page 85</p> <p>P N S O O 7 .</p>	<p>Select Leg Color</p> <p>P6N Textured Satin Chrome P7A Textured Charcoal <i>Specify for Standard, Tapered Round and Tapered Square legs only</i></p> <p>T Black Hard Caster <i>Specify for Hard Caster option only</i></p> <p>P 6 N</p>
--	---	---	---



Icon Legend on page 14

FLOCK® Dual Fabric Collaborative

HFLSC1DF

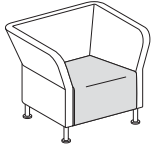

LOUNGE CHAIR

Dual Fabric
Square

DIMENSIONS

Depth:	28½	Arm Width:	27½
Width:	34¼	Seat to Floor Height:	17
Height:	28	Usable Seat Depth:	20½
Seat Depth:	20½	Ship Weight:	48
Seat Width:	21½	Cube:	27.0
Back Width:	21½	COM:	See page 98
Back Height:	18½	Weight Rating:	300 lbs.

FABRIC PRICE CODES

1	\$1696	
<i>Add to Base Price Above</i>		
	Back	Seat
2	\$80	\$28
3	\$160	\$56
4	\$220	\$77
5	\$280	\$98
6	\$340	\$119
7	\$400	\$140
8	\$460	\$161
9	\$519	\$183
10	\$579	\$204
11	\$639	\$225
12	\$699	\$246
L	\$666	\$234

The following fabric pattern will be railroaded on Flock® Seating (does not apply to HFLRC1DF):
RI Stitchery

For dual fabric models, start with the base price, then add the additional amount for the back and seat from the corresponding matrix to determine the final list price. Choose any combination of fabric grades for the back and seat.

Example: HFLSC1DF base price (\$1696) + Grade 2 back fabric (add \$80) + Grade 4 seat fabric (add \$77) = Total \$1853 List
HFLSC1DF base price (\$1696) + Grade 5 back fabric (add \$280) + Grade 3 seat fabric (add \$56) = Total \$2032 List

HFLRC1DF

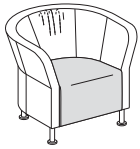

LOUNGE CHAIR

Dual Fabric
Round

DIMENSIONS

Depth:	29	Arm Width:	27½
Width:	33½	Seat to Floor Height:	17
Height:	28	Usable Seat Depth:	20½
Seat Depth:	20½	Ship Weight:	39
Seat Width:	20½	Cube:	27.0
Back Width:	20½	Weight Rating:	300 lbs.
Back Height:	18½		

FABRIC PRICE CODES

1	\$1769	
<i>Add to Base Price Above</i>		
	Back	Seat
2	\$71	\$25
3	\$142	\$50
4	\$195	\$69
5	\$249	\$87
6	\$302	\$106
7	\$355	\$125
8	\$408	\$144
9	\$462	\$162
10	\$515	\$181
11	\$568	\$200
12	\$622	\$218
L	\$592	\$208

NOTES: Due to the inherent design of the Round Lounge chair, material gathers will be present in the back.
! Round Lounge models HFLRC1 / HFLRC1DF are offered in select fabrics; for availability, please see the Fabric Matrix on page 85. Also approved in limited Partnership Fabrics.

The following fabric pattern will be railroaded on Flock® Seating (does not apply to HFLRC1DF):
RI Stitchery

For dual fabric models, start with the base price, then add the additional amount for the back and seat from the corresponding matrix to determine the final list price. Choose any combination of fabric grades for the back and seat.

Example: HFLRC1DF base price (\$1769) + Grade 2 back fabric (add \$71) + Grade 4 seat fabric (add \$69) = Total \$1909 List
HFLRC1DF base price (\$1769) + Grade 5 back fabric (add \$249) + Grade 3 seat fabric (add \$50) = Total \$2068 List

HON Recommendation: HFLSC1DF.TS.PNS___PNS___P6N - List Price \$1804

HOW TO SPECIFY

<p>Select Model Number</p> <p>HFLSC1DF</p>	<p>Select Leg Option</p> <p>L Standard Leg TS Tapered Square TR Tapered Round H Hard Casters</p> <p>TS</p>	<p>Select Back Fabric</p> <p>See page 85</p> <p>PNS004</p>	<p>Select Seat Fabric</p> <p>See page 85</p> <p>PNS007</p>	<p>Select Leg Color</p> <p>P6N Textured Satin Chrome P7A Textured Charcoal</p> <p><i>Specify for Standard, Tapered Round and Tapered Square legs only</i></p> <p>T Black Hard Caster <i>Specify for Hard Caster option only</i></p> <p>P6N</p>
---	---	---	---	---

FLOCK® Dual Fabric Collaborative

GSA SIN 711-17



Icon Legend on page 14

HFLMC1DF

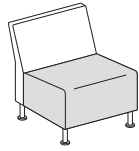

MODULAR CHAIR

Dual Fabric

DIMENSIONS

Depth:	28½	Seat to Floor Height:	17
Width:	25	Usable Seat Depth:	20½
Height:	28	Ship Weight:	52
Seat Depth:	20½	Cube:	24.0
Seat Width:	25	COM:	See page 98
Back Width:	25	Weight Rating:	300 lbs.
Back Height:	18½		

FABRIC PRICE CODES

1	\$1262	
<i>Add to Base Price Above</i>		
	Back	Seat
2	\$36	\$36
3	\$72	\$72
4	\$99	\$99
5	\$126	\$126
6	\$153	\$153
7	\$180	\$180
8	\$207	\$207
9	\$234	\$234
10	\$261	\$261
11	\$288	\$288
12	\$315	\$315
L	\$300	\$300

HFLML1DF

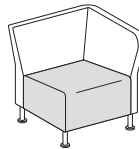

MODULAR LEFT END

Dual Fabric

DIMENSIONS

Depth:	28½	Seat to Floor Height:	17
Width:	28½	Usable Seat Depth:	20½
Height:	28	Ship Weight:	72
Seat Depth:	20½	Cube:	24.0
Seat Width:	22¼	COM:	See page 98
Back Width:	22¼	Weight Rating:	300 lbs.
Back Height:	18½		

FABRIC PRICE CODES

1	\$1476	
<i>Add to Base Price Above</i>		
	Back	Seat
2	\$71	\$25
3	\$142	\$50
4	\$195	\$69
5	\$249	\$87
6	\$302	\$106
7	\$355	\$125
8	\$408	\$144
9	\$462	\$162
10	\$515	\$181
11	\$568	\$200
12	\$622	\$218
L	\$592	\$208

The following fabric pattern will be railroaded on Flock® Seating (does not apply to stool model HFSS7):
RI Stitchery

HON Recommendation: HFLMC1DF.TS.PNS__PNS__P6N - List Price \$1334

HOW TO SPECIFY

Select Model Number <div style="border: 1px solid black; padding: 2px; display: flex; justify-content: space-between;"> HFLMC1DF </div>	Select Leg Option L Standard Leg TS Tapered Square TR Tapered Round H Hard Casters	Select Back Fabric See page 85 <div style="border: 1px solid black; padding: 2px; display: flex; justify-content: space-between;"> PNS004 </div>	Select Seat Fabric See page 85 <div style="border: 1px solid black; padding: 2px; display: flex; justify-content: space-between;"> PNS007 </div>	Select Leg Color P6N Textured Satin Chrome P7A Textured Charcoal <i>Specify for Standard, Tapered Round and Tapered Square legs only</i> T Black Hard Caster <i>Specify for Hard Caster option only</i> <div style="border: 1px solid black; padding: 2px; display: flex; justify-content: space-between;"> P6N </div>
---	---	---	---	---



FLOCK® Dual Fabric Collaborative

HFLMR1DF

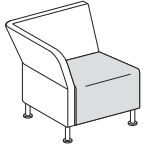

MODULAR RIGHT END

Dual Fabric

DIMENSIONS

Depth:	28½	Seat to Floor Height:	17
Width:	28½	Usable Seat Depth:	20½
Height:	28	Ship Weight:	72.0
Seat Depth:	20½	Cube:	24.0
Seat Width:	22¼	COM:	See page 98
Back Width:	22¼	Weight Rating:	300 lbs.
Back Height:	18½		

FABRIC PRICE CODES

1	\$1476	
	<i>Add to Base Price Above</i>	
	Back	Seat
2	\$71	\$25
3	\$142	\$50
4	\$195	\$69
5	\$249	\$87
6	\$302	\$106
7	\$355	\$125
8	\$408	\$144
9	\$462	\$162
10	\$515	\$181
11	\$568	\$200
12	\$622	\$218
L	\$592	\$208

HFLGANG

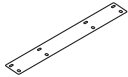

GANGING BRACKET

For Flock® Modular Seating Models

- Can be used for in-line ganging ONLY
- Use one bracket to connect two models. Do not connect more than four models (models HFLMC1DF, HFLML1DF or HFLMR1DF).
- No specification required for bracket

DIMENSIONS

Ship Weight:	0.5
Cube:	0.1

LIST PRICE

\$30

The following fabric pattern will be railroaded on Flock® Seating (does not apply to stool model HFSS7):

RI Stitchery

HON Recommendation: HFLMR1DF.TS.PNS__PNS__P6N - List Price \$1572

HOW TO SPECIFY

<p>Select Model Number</p>	<p>Select Leg Option</p> <p>L Standard Leg TS Tapered Square TR Tapered Round H Hard Casters</p>	<p>Select Back Fabric</p> <p>See page 85</p>	<p>Select Seat Fabric</p> <p>See page 85</p>	<p>Select Leg Color</p> <p>P6N Textured Satin Chrome P7A Textured Charcoal</p> <p><i>Specify for Standard, Tapered Round and Tapered Square legs only</i></p> <p>T Black Hard Caster <i>Specify for Hard Caster option only</i></p>
<p>H F L M R 1 D F .</p>	<p>T S .</p>	<p>P N S 0 0 4 .</p>	<p>P N S 0 0 7 .</p>	<p>P 6 N</p>

FLOCK® Options

MODEL OPTIONS

HFSS7



Stool

HFCG6
HFCG6DF - Dual Fabric



Guest Chair
Casual

HFCL1
HFCL1DF - Dual Fabric



Lounge Chair
Casual

HFSS74L
HFSS74LDF - Dual Fabric



Stool
4-Leg

SHELL COLOR

CODE	DESCRIPTION	PRICE
LA	Lava	+\$0
ON	Onyx	+\$0
PT	Platinum	+\$0
SD	Shadow	+\$0

**Available for model HFSS7 only*

FRAME

CODE	DESCRIPTION	PRICE
P6N	Textured Satin Chrome	+\$0
P7N	Textured Charcoal	+\$0

**P7A available for model HFSS7 only*

FLOCK® Fabric Options

AVAILABLE FABRICS

GRADE 1	GRADE 2	GRADE 3	GRADE 4	GRADE 5	GRADE 6	GRADE 7	GRADE 8	GRADE 9	GRADE 10	GRADE 11	GRADE 12	GRADE L
Arrondi * Attire Centurion Compass Confetti Contourette Polyurethane Dapper Inertia Optic Stitchery Tectonic	Appoint Seating Bangle Clyde Dotty Esplanade * Expo Fuse Gio * Moguls Origin Seed Sockhop Spin Seating Whisper Vinyl	Canter Polyurethane Epic Infinity Knack Marathon Millennium Odyssey Silvertex™ Vinyl Syntax Tradition Via	Bar Beeline Blip Coin Cover Cloth Current Decode Disc Divide Free Habit Hive Lineup Manner Medium Messenger Metric Oblique Pick Sprint Technic	Amuse Avenue Lariat Outlander Polka Riddle Sentry-HC Sequence Solace Tribeca	Intermix II Keynote Raffia Vinyl Velocity Wooly	Ascend Central Channel Domain Synergy Waver	Brisa® Polyurethane Kindred	Eli Vinyl Martini Vinyl Olympus Vinyl Silica Silica Leather Silica Tech	Affinity Concentric Juxy	Acrobat Natural World Whirl	Fenestra Helix Lava Ripple	Denver Leather (Matches EE Vinyl)

Flock® chair models HFLRC1 and HFSS7 have fabric limitations, please see the Flock® seating pages 86-91 and 94 for details.

Reference Fabric Color Combinations on pages 18-29 for color codes and legend on page 19 for lead times. Visit hon.com for additional partnership fabrics.

NOTES: Gathers and creases may be more visible with Attire (AI) and Optic (OP) fabrics due to the inherent design and construction of these fabrics.

🔥 For Fire Code model, availability and ordering method, refer to pages 34-39. Available on select models, contact HON Customer Support for availability.

* Fabric is de-emphasized.

FLOCK® ROUND LOUNGE HFLRC1/DF AND STOOL HFSS7 AVAILABLE FABRICS

GRADE 1	GRADE 2	GRADE 3	GRADE 4	GRADE 5	GRADE 6	GRADE 7	GRADE 8	GRADE 9	GRADE 10	GRADE 11	GRADE 12	GRADE L
Arrondi * Centurion Compass Confetti Contourette Polyurethane Dapper Inertia Optic Tectonic	Appoint Seating Bangle Clyde Expo Fuse Gio * Moguls Origin Seed Spin Seating Whisper Vinyl	Canter Polyurethane Epic Infinity Marathon Millennium Odyssey Silvertex™ Vinyl Tradition Via	Beeline Cover Cloth Current Blip Manner Medium Messenger Metric Sprint	Lariat Outlander Sentry-HC Sequence Solace Tribeca	Keynote Velocity Wooly		Kindred	Silica Silica Leather Silica Tech				Denver Leather (Matches EE Vinyl)

Flock® chair model HFLRC1 has fabric limitations, please see the Flock® seating pages 86-91 for details.

Reference Fabric Color Combinations on pages 18-29 for color codes and legend on page 19 for lead times. Visit hon.com for additional partnership fabrics.

NOTES: Gathers and creases may be more visible with Optic (OP) fabric due to the inherent design and construction of these fabrics.

🔥 For Fire Code model, availability and ordering method, refer to pages 34-39. Available on select models, contact HON Customer Support for availability.

* Fabric is de-emphasized.



HFSS7



SIN 711-18

STOOL

DIMENSIONS

Depth:	18	Seat to Floor Height:	31
Width:	18	Usable Seat Depth:	15¾
Height:	39¼	Ship Weight:	57
Seat Depth:	15¾	Cube:	11.0
Seat Width:	15¾	COM:	1.5
Back Width:	15¾	Weight Rating:	300 lbs.
Back Height:	8		

FABRIC PRICE CODES

1	\$717	8	\$924
2	\$753	9	\$951
3	\$789	10	\$978
4	\$816	11	\$1005
5	\$843	12	\$1032
6	\$870	L	\$1017
7	\$897		

! Customer's Own Material (COM) is not available on Flock® models HFLRC1 or HFSS7.

HON Recommendation: HFSS7.PT.PNS__P6N - List Price \$753

HOW TO SPECIFY

<p>Select Model Number</p> <p>HFSS7 .</p>	<p>Select Shell Color</p> <p>LA Lava ON Onyx PT Platinum SD Shadow</p> <p>PT .</p>	<p>Select Fabric</p> <p>See page 93</p> <p>PNS007 .</p>	<p>Select Frame</p> <p>P6N Textured Satin Chrome P7A Textured Charcoal</p> <p>P6N</p>
--	---	--	--



HF CG6



SIN 711-17

GUEST CHAIR

Casual

DIMENSIONS

Depth:	23 ⁵ / ₁₆	Seat to Floor Height:	18 ¹ / ₄
Width:	19	Usable Seat Depth:	16 ⁷ / ₈
Height:	32 ¹ / ₂	Ship Weight:	24
Seat Depth:	16 ⁷ / ₈	Cube:	10.4
Seat Width:	19	COM:	1.8
Back Width:	19	Weight Rating:	300 lbs.
Back Height:	14 ¹ / ₄		

FABRIC PRICE CODES

1	\$536	8	\$812
2	\$584	9	\$848
3	\$632	10	\$884
4	\$668	11	\$920
5	\$704	12	\$956
6	\$740	L	\$936
7	\$776		

HF CL1



SIN 711-17

LOUNGE CHAIR

Casual

DIMENSIONS

Depth:	25	Seat to Floor Height:	18 ¹ / ₄
Width:	22	Usable Seat Depth:	17 ¹ / ₂
Height:	32 ¹ / ₁₆	Ship Weight:	28
Seat Depth:	17 ¹ / ₂	Cube:	12.6
Seat Width:	22	COM:	2.0
Back Width:	22	Weight Rating:	300 lbs.
Back Height:	14 ¹ / ₈		

FABRIC PRICE CODES

1	\$618	8	\$894
2	\$666	9	\$930
3	\$714	10	\$966
4	\$750	11	\$1002
5	\$786	12	\$1038
6	\$822	L	\$1018
7	\$858		

HF SS74L



SIN 711-18

STOOL

4-Leg

DIMENSIONS

Depth:	21 ¹ / ₈	Seat to Floor Height:	30
Width:	18	Usable Seat Depth:	15 ¹ / ₈
Height:	40 ⁷ / ₈	Ship Weight:	35
Seat Depth:	15 ¹ / ₈	Cube:	21.8
Seat Width:	18	COM:	1.9
Back Width:	18	Weight Rating:	300 lbs.
Back Height:	10 ⁷ / ₈		

FABRIC PRICE CODES

1	\$670	8	\$946
2	\$718	9	\$982
3	\$766	10	\$1018
4	\$802	11	\$1054
5	\$838	12	\$1090
6	\$874	L	\$1070
7	\$910		

HON Recommendation: HFSS74L.PNS__P6N - List Price \$718

HOW TO SPECIFY

Select Model Number

HFSS74L .

Select Fabric

See page 93

PNS007 .

Select Frame

P6N Textured Satin Chrome (only)

P6N

HFSG6DF



CASUAL GUEST CHAIR

Dual Fabric

DIMENSIONS

Depth:	23 ⁵ / ₁₆	Seat to Floor Height:	18 ¹ / ₄
Width:	19	Usable Seat Depth:	16 ⁷ / ₈
Height:	32 ¹ / ₂	Ship Weight:	24
Seat Depth:	16 ⁷ / ₈	Cube:	10.4
Seat Width:	19	COM:	See page 98
Back Width:	19	Weight Rating:	300 lbs.
Back Height:	14 ¹ / ₄		

FABRIC PRICE CODES

1	\$611		
<i>Add to Base Price Above</i>			
		Back	Seat
2	\$24	\$24	\$24
3	\$48	\$48	\$48
4	\$66	\$66	\$66
5	\$84	\$84	\$84
6	\$102	\$102	\$102
7	\$120	\$120	\$120
8	\$138	\$138	\$138
9	\$156	\$156	\$156
10	\$174	\$174	\$174
11	\$192	\$192	\$192
12	\$210	\$210	\$210
L	\$200	\$200	\$200

HFCL1DF



CASUAL LOUNGE CHAIR

Dual Fabric

DIMENSIONS

Depth:	25	Seat to Floor Height:	18 ¹ / ₄
Width:	22	Usable Seat Depth:	17 ¹ / ₂
Height:	32 ¹ / ₁₆	Ship Weight:	28
Seat Depth:	17 ¹ / ₂	Cube:	12.6
Seat Width:	22	COM:	See page 98
Back Width:	22	Weight Rating:	300 lbs.
Back Height:	14 ¹ / ₈		

FABRIC PRICE CODES

1	\$693		
<i>Add to Base Price Above</i>			
		Back	Seat
2	\$24	\$24	\$24
3	\$48	\$48	\$48
4	\$66	\$66	\$66
5	\$84	\$84	\$84
6	\$102	\$102	\$102
7	\$120	\$120	\$120
8	\$138	\$138	\$138
9	\$156	\$156	\$156
10	\$174	\$174	\$174
11	\$192	\$192	\$192
12	\$210	\$210	\$210
L	\$200	\$200	\$200

HFSS74LDF



4-LEG STOOL

Dual Fabric

DIMENSIONS

Depth:	21 ⁷ / ₈	Seat to Floor Height:	30
Width:	18	Usable Seat Depth:	15 ¹ / ₈
Height:	40 ⁷ / ₈	Ship Weight:	35
Seat Depth:	15 ¹ / ₈	Cube:	21.8
Seat Width:	18	COM:	See page 98
Back Width:	18	Weight Rating:	300 lbs.
Back Height:	10 ⁷ / ₈		

FABRIC PRICE CODES

1	\$745		
<i>Add to Base Price Above</i>			
		Back	Seat
2	\$24	\$24	\$24
3	\$48	\$48	\$48
4	\$66	\$66	\$66
5	\$84	\$84	\$84
6	\$102	\$102	\$102
7	\$120	\$120	\$120
8	\$138	\$138	\$138
9	\$156	\$156	\$156
10	\$174	\$174	\$174
11	\$192	\$192	\$192
12	\$210	\$210	\$210
L	\$200	\$200	\$200

HON Recommendation: HFSS74LDF.PNS___.PNS___.P6N - List Price \$718

HOW TO SPECIFY

<p>Select Model Number</p> <p>HFSS74LDF</p>	<p>Select Back Fabric</p> <p>See page 93</p> <p>PNS004</p>	<p>Select Seat Fabric</p> <p>See page 93</p> <p>PNS007</p>	<p>Select Frame</p> <p>P6N Textured Satin Chrome (only)</p> <p>P6N</p>
--	---	---	---

MODEL OPTIONS

HFLCO1
HFLCO1DF - Dual Fabric

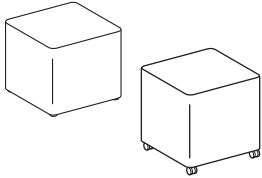

Mini Cube

HFLYO1
HFLYO1DF - Dual Fabric

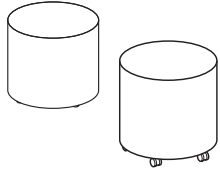

Mini Cylinder

HFLCO1T
HFLCO1TDF - Dual Fabric

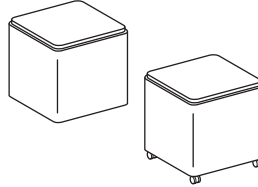

Square Mini with Laminate
Topper

HFLYO1T
HFLYO1TDF - Dual Fabric

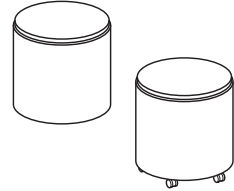

Round Mini with Laminate
Topper

FLOCK® Options

CASTER/ GLIDES

CODE	DESCRIPTION	PRICE
H	Hard Caster	+\$0
HG	Hidden Glide	+\$0
LP6N	Textured Satin Chrome Disc Glide	+\$45
LP7A	Textured Charcoal Disc Glide	+\$45

DUAL FABRIC COM YARDAGE

Due to fabric pattern nesting and potential reduction of fabric yield, some dual fabric models may require more total yardage than standard models.

	BACK	SEAT
HFLSC1DF	3.5 yd	1.5 yd
HFLMC1DF	1.5 yd	1.5 yd
HFLML1DF	2.5 yd	1.5 yd
HFLMR1DF	2.5 yd	1.5 yd
HFSG6DF	1.75 yd	2.0 yd
HFCL1DF	1.75 yd	2.0 yd
HFSS74LDF	1.75 yd	2.0 yd
	TOP	SIDE
HFLCO1DF	.75 yd	1.25 yd
HFLYO1DF	.75 yd	1.25 yd

Due to fabric pattern nesting and potential reduction of fabric yield, some dual fabric models may require more total yardage than standard models.

AVAILABLE FABRICS

GRADE 1	GRADE 2	GRADE 3	GRADE 4	GRADE 5	GRADE 6	GRADE 7	GRADE 8	GRADE 9	GRADE 10	GRADE 11	GRADE 12	GRADE L
Arrondi *	Appoint Seating	Canter Polyurethane	Bar Beeline	Amuse Avenue	Intermix II Keynote	Ascend Central	Brisa® Polyurethane Kindred	Eli Vinyl Martini Vinyl	Affinity Concentric	Acrobat Natural World	Fenestra Helix	Denver Leather (Matches EE Vinyl)
Attire	Bangle	Epic	Blip	Lariat	Raffia Vinyl	Channel		Olympus Vinyl	Juxy	Whirl	Lava	
Centurion	Clyde	Infinity	Coin	Outlander	Velocity	Domain		Silica			Ripple	
Compass	Dotty	Knack	Cover Cloth	Polka	Wooly	Synergy		Silica Leather				
Confetti	Esplanade *	Marathon	Current	Riddle		Waver		Silica Tech				
Contourette Polyurethane	Expo	Millennium	Decode	Sentry-HC								
Dapper	Fuse	Odyssey	Disc	Sequence								
Inertia	Gio *	Silvertext™ Vinyl	Divide	Solace								
Optic	Moguls	Syntax	Free	Tribeca								
Stitchery	Origin	Tradition	Habit									
Tectonic	Seed	Via	Hive									
	Sockhop		Lineup									
	Spin Seating		Manner									
	Whisper Vinyl		Medium									
			Messenger									
			Metric									
			Oblique									
			Pick									
			Sprint									
			Technic									

Flock® chair model HFLRC1 has fabric limitations, please see the Flock® seating pages 86-91 for details.

Reference Fabric Color Combinations on pages 18-29 for color codes and legend on page 19 for lead times. Visit hon.com for additional partnership fabrics.

NOTES: Gathers and creases may be more visible with Attire (AI) and Optic (OP) fabrics due to the inherent design and construction of these fabrics.

▲ For Fire Code model, availability and ordering method, refer to pages 34-39. Available on select models, contact HON Customer Support for availability.

* Fabric is de-emphasized.



FLOCK® Mini Cube and Cylinders

HFLCO1

MINI CUBE

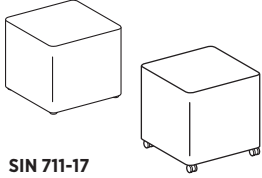

SIN 711-17

DIMENSIONS

Depth:	18½	Seat to Floor Height:	17
Width:	18½	Usable Seat Depth:	18½
Height:	17	Ship Weight:	15 Ⓢ
Seat Depth:	18½	Cube:	5.0
Seat Width:	18½	COM:	1.8
		Weight Rating:	300 lbs.

FABRIC PRICE CODES

1	\$414	8	\$621
2	\$450	9	\$648
3	\$486	10	\$675
4	\$513	11	\$702
5	\$540	12	\$729
6	\$567	L	\$714
7	\$594		

HFLYO1

MINI CYLINDER

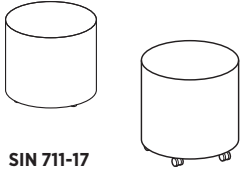

SIN 711-17

DIMENSIONS

Depth:	18½	Seat to Floor Height:	17
Width:	18½	Usable Seat Depth:	18½
Height:	17	Ship Weight:	13 Ⓢ
Seat Depth:	18½	Cube:	5.0
Seat Width:	18½	COM:	1.2
		Weight Rating:	300 lbs.

FABRIC PRICE CODES

1	\$414	8	\$621
2	\$450	9	\$648
3	\$486	10	\$675
4	\$513	11	\$702
5	\$540	12	\$729
6	\$567	L	\$714
7	\$594		

HFLCO1T

SQUARE MINI WITH LAMINATE TOPPER

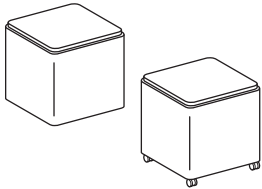

Not on GSA Contract

DIMENSIONS

Depth:	18½	Seat to Floor Height:	17¾
Width:	18½	Usable Seat Depth:	18½
Height:	17¾	Ship Weight:	24
Seat Depth:	18½	Cube:	5.4
Seat Width:	18½	COM:	1.8
		Weight Rating:	300 lbs.

FABRIC PRICE CODES

1	\$524	8	\$731
2	\$560	9	\$758
3	\$596	10	\$785
4	\$623	11	\$812
5	\$650	12	\$839
6	\$677	L	\$824
7	\$704		

HFLYO1T

ROUND MINI WITH LAMINATE TOPPER

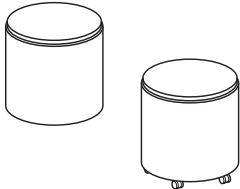

Not on GSA Contract

DIMENSIONS

Depth:	18½	Seat to Floor Height:	17¾
Width:	18½	Usable Seat Depth:	18½
Height:	17¾	Ship Weight:	24
Seat Depth:	18½	Cube:	5.4
Seat Width:	18½	COM:	1.8
		Weight Rating:	300 lbs.

FABRIC PRICE CODES

1	\$524	8	\$731
2	\$560	9	\$758
3	\$596	10	\$785
4	\$623	11	\$812
5	\$650	12	\$839
6	\$677	L	\$824
7	\$704		

HON Recommendation: HFLYO1.HG.PNS__ - List Price \$450

HOW TO SPECIFY

Select Model Number	Select Glide	Select Fabric	Select Laminate and Edgeband Color
	H Caster HG Hidden Glide LP6N Textured Satin Chrome Disc Glide (+ \$45) LP7A Textured Charcoal Disc Glide (+ \$45)	See page 98	See page 102 L2 (+ \$10)
HFLYO1	HG	PNS007	
HFLYO1T	HG	PNS007	NN

FLOCK® Dual Fabric Mini Cube and Cylinder

GSA SIN 711-17



HFLCO1DF

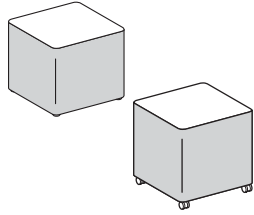

MINI CUBE

Dual Fabric

DIMENSIONS

Depth:	18½	Seat to Floor Height:	17
Width:	18½	Usable Seat Depth:	18½
Height:	17	Ship Weight:	15 Ⓢ
Seat Depth:	18½	Cube:	5.0
Seat Width:	18½	COM:	See page 98
		Weight Rating:	300 lbs.

LIST PRICE

\$489

HFLYO1DF

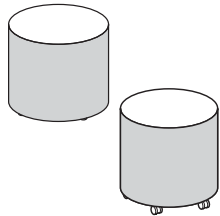

MINI CYLINDER

Dual Fabric

DIMENSIONS

Depth:	18½	Seat to Floor Height:	17
Width:	18½	Usable Seat Depth:	18½
Height:	17	Ship Weight:	13 Ⓢ
Seat Depth:	18½	Cube:	5.0
Seat Width:	18½	COM:	See page 98
		Weight Rating:	300 lbs.

LIST PRICE

\$489

HON Recommendation: HFLCO1DF.HG.PNS__PNS__ - List Price \$525

HOW TO SPECIFY

Select Model Number	Select Glide	Select Top Fabric	Select Side Fabric	Select Laminate and Edgeband Color
	H Caster HG Hidden Glide LP6N Textured Satin Chrome Disc Glide (+ \$45) LP7A Textured Charcoal Disc Glide (+ \$45)	See page 98	See page 98	See page 102 L2 (+ \$10)
HFLCO1DF.	HG.	PNS007.	PNS004	



Dual Fabric Mini Cube and Cylinder

HFLCO1TDF

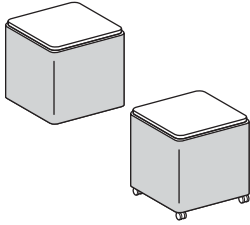

SQUARE MINI WITH LAMINATE TOPPER

Dual Fabric

DIMENSIONS

Depth:	18½	Seat to Floor Height:	17¾
Width:	18½	Usable Seat Depth:	18½
Height:	17¾	Ship Weight:	24
Seat Depth:	18½	Cube:	5.4
Seat Width:	18½	COM:	See page 98
		Weight Rating:	300 lbs.

LIST PRICE

\$599

Not on GSA Contract

HFLYO1TDF

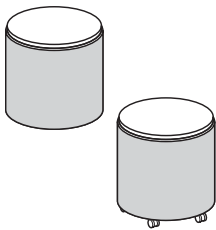

ROUND MINI WITH LAMINATE TOPPER

Dual Fabric

DIMENSIONS

Depth:	18½	Seat to Floor Height:	17¾
Width:	18½	Usable Seat Depth:	18½
Height:	17¾	Ship Weight:	24
Seat Depth:	18½	Cube:	5.4
Seat Width:	18½	COM:	See page 98
		Weight Rating:	300 lbs.

FABRIC PRICE CODES

1	\$599	
<i>Add to Base Price Above</i>		
	Top	Sides
2	\$11	\$25
3	\$22	\$50
4	\$30	\$69
5	\$38	\$88
6	\$46	\$107
7	\$54	\$126
8	\$62	\$145
9	\$70	\$164
10	\$78	\$183
11	\$86	\$202
12	\$95	\$221
L	\$90	\$210

Not on GSA Contract

HON Recommendation: HFLCO1TDF.HG.PNS__PNS__ - List Price \$635

HOW TO SPECIFY

<p>Select Model Number</p> <p>HFLCO1TDF</p>	<p>Select Glide</p> <p>H Caster HG Hidden Glide LP6N Textured Satin Chrome Disc Glide (+ \$45) LP7A Textured Charcoal Disc Glide (+ \$45)</p> <p>HG</p>	<p>Select Top Fabric</p> <p>See page 98</p> <p>PNS007</p>	<p>Select Side Fabric</p> <p>See page 98</p> <p>PNS004</p>	<p>Select Laminate and Edgeband Color</p> <p>See page 102 L2 (+ \$10)</p> <p>NN</p>
--	---	--	---	--

FLOCK® Table Options

COLLABORATIVE TABLES ORDERING INFORMATION

			Table Tops	Table Bases	Tablets	Legs/Lamps
TOPS	L1 LAMINATES	CODES				
Woodgrain	Bourbon Cherry	H	•		•	
	Cognac	COGN	•		•	
	Harvest	C	•		•	
	Mahogany	N	•		•	
	Mocha	MOCH	•		•	
	Natural Maple	D	•		•	
	Pinnacle	PINC	•		•	
	Shaker Cherry	F	•		•	
Solid	Black	P	•		•	
	Brilliant White	WHIT	•		•	
	Charcoal	S	•		•	
	Loft	LOFT	•		•	
	Whitestone	K4	•		•	
Patterned	Sheer Mesh	A5	•		•	
	Silver Mesh	B9	•		•	
	Steel Mesh	A9	•		•	
	Taupe Mesh	A8	•		•	
	Canyon Zephyr	K9	•		•	
	Desert Zephyr	K8	•		•	
	Shadow Zephyr	K1	•		•	
TOPS	L2 LAMINATES	CODES				
Woodgrain	Lowell Ash <i>NEW! 1/30/2017</i>	LLA1	•		•	
	Natural Recon <i>NEW! 1/30/2017</i>	LNRI	•		•	
	Phantom Ecru <i>NEW! 1/30/2017</i>	LPE1	•		•	
	Portico Teak <i>NEW! 1/30/2017</i>	LPT1	•		•	
	Skyline Walnut <i>NEW! 1/30/2017</i>	LSW1	•		•	
	EDGEBAND*	CODES				
	Black	P	•		•	
	Bourbon Cherry	H	•		•	
	Brilliant White	WHIT	•		•	
	Charcoal	S	•		•	
	Cognac	COGN	•		•	
	Greige	R	•		•	
	Harvest	C	•		•	
	Light Gray	Q	•		•	
	Loft	LOFT	•		•	
	Lowell Ash <i>NEW! 1/30/2017</i>	DL	•		•	
	Mahogany	N	•		•	
	Mocha	MOCH	•		•	
	Muslin	T	•		•	
	Natural Maple	D	•		•	
	Natural Recon <i>NEW! 1/30/2017</i>	NR	•		•	
	Phantom Ecru <i>NEW! 1/30/2017</i>	PE	•		•	
	Pinnacle	PINC	•		•	
	Platinum	K	•		•	
	Portico Teak <i>NEW! 1/30/2017</i>	DP	•		•	
	Shadow	SHDW	•		•	
	Shaker Cherry	F	•		•	
	Skyline Walnut <i>NEW! 1/30/2017</i>	SW	•		•	
		PAINTS**	CODES			
Textured	Textured Satin Chrome	P6N		•		•
	Textured Charcoal	P7A		•		•

Recommended Edgeband Color Selection:

LAMINATE		EDGEBAND	
Bourbon Cherry	H	Bourbon Cherry	H
Cognac	COGN	Cognac	COGN
Harvest	C	Harvest	C
Mahogany	N	Mahogany	N
Mocha	MOCH	Mocha	MOCH
Natural Maple	D	Natural Maple	D
Pinnacle	PINC	Pinnacle	PINC
Shaker Cherry	F	Shaker Cherry	F
Black	P	Black	P
Brilliant White	WHIT	Brilliant White	WHIT
Charcoal	S	Charcoal	S
Whitestone	K4	Muslin	T
Sheer Mesh	A5	Muslin	T
Silver Mesh	B9	Loft	LOFT
Steel Mesh	A9	Charcoal	S
Taupe Mesh	A8	Greige	R
Canyon Zephyr	K9	Greige	R
Desert Zephyr	K8	Greige	R
Shadow Zephyr	K1	Loft	LOFT
Lowell Ash	LLA1	Lowell Ash	DL
Natural Recon	LNRI	Natural Recon	NR
Phantom Ecru	LPE1	Phantom Ecru	PE
Portico Teak	LPT1	Portico Teak	DP
Skyline Walnut	LSW1	Skyline Walnut	SW
Loft	LOFT	Loft	LOFT

* Edge detail color can be different from top color on laminate tops and tablets.

** Applies to all models — includes bases, legs, and lamps.

TOP SHAPES

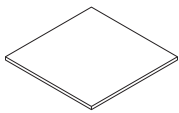

Square



Round

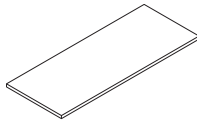

Rectangle



Racetrack

TABLE BASES

For 18½" Tables

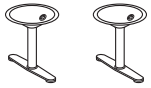

T-Leg Style

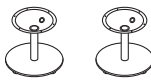

Disc Style

For 29½" Tables



X-Style



Disc Style

For 41½" Standing Height Tables



X-Style

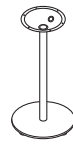

Disc Style

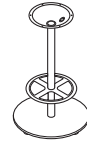

Disc Style
with Footring

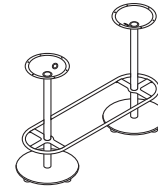

Disc Style
with Footring

TABLES AND ACCESSORIES

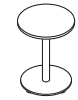

Personal
Table



Tablet
Accessory

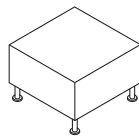

Cube
Table



Cylinder
Table



Lamp Accessory for
Cube/Cylinder Tables



Floor
Lamp



Lamp
Shade

FLOCK® Table Features

GROMMET MATRIX — ALL TABLES/TOPS

TOP WIDTH	NO GROMMET	1-3" ROUND GROMMET CENTERED	2-3" ROUND GROMMET LEFT & RIGHT
SIF OPTION CODE	N	G	G
24" Cube	YES	YES	N/A
26" Cylinder	YES	YES	N/A
18" Personal	N/A	N/A	N/A
30" Square/Round	YES	YES	N/A
36" Square/Round	YES	YES	N/A
60" Rectangle/Racetrack	YES	N/A	YES
72" Rectangle/Racetrack	YES	N/A <td YES	
84" Rectangle/Racetrack	YES	N/A	YES
96" Rectangle/Racetrack	YES	N/A	YES

3" ROUND GROMMET LOCATIONS

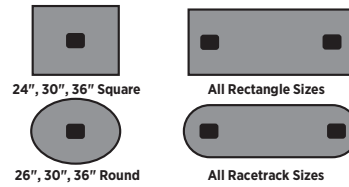

NOTES: 3" round grommet color will need to be specified for tops. Grommet will coordinate with paint color specified for cube/cylinder tables. Charcoal grommets will be used with Textured Charcoal paint and Platinum Metallic grommets will be used with Textured Satin Chrome paint.

Grommet options can be used in conjunction with accessory ports on cube/cylinder tables.

Grommet models HGRMTAC, HGRMTDATA and HGRMTUSB2 on page 112 can also be used with Flock® tables.

ACCESSORY PORT LOCATIONS

Only applies to models HFTLS24 and HFTLD26.

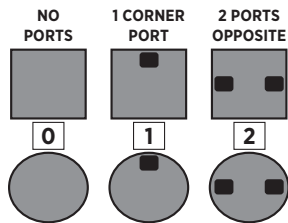

NOTES:

Port location 1 allows for either one tablet or one lamp accessory — see models on pages 110-111.

Port location 2 allows for either one tablet and one lamp accessory or two tablet accessories (two lamps cannot be used) — see models on pages 110-111.



FLOCK® Collaborative Laminate Table Tops

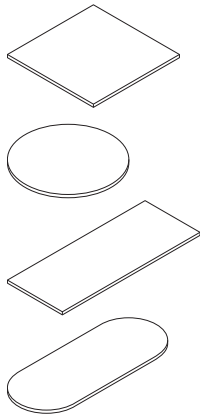

DESCRIPTION	MODEL	SHIP WEIGHT	CUBE	LIST PRICE BY LAMINATE GRADE	
				L1	L2
Laminate Table Tops					
36" Square Top	HFTLS36	45	1.2	\$386	\$406
30" Square Top	HFTLS30	32	1.0	\$342	\$362
36" Round Top	HFTLD36	35	1.2	\$386	\$406
30" Round Top	HFTLD30	25	1.0	\$342	\$362
96"W x 33"D Rectangle Top	HFTLC3396	105	2.9	\$683	\$718
84"W x 33"D Rectangle Top	HFTLC3384	90	2.5	\$585	\$615
72"W x 33"D Rectangle Top	HFTLC3372	78	2.2	\$488	\$513
60"W x 24"D Rectangle Top	HFTLC2460	47	1.3	\$357	\$372
96"W x 33"D Racetrack Top	HFTLA3396	101	2.9	\$683	\$718
84"W x 33"D Racetrack Top	HFTLA3384	83	2.5	\$585	\$615
72"W x 33"D Racetrack Top	HFTLA3372	70	2.2	\$488	\$513
60"W x 24"D Racetrack Top	HFTLA2460	43	1.3	\$357	\$372

NOTES: Choose from Square, Round, Rectangle or Racetrack shaped table tops. Grommet models HGRMTAC, HGRMTDATA and HGRMTUSB2 on page 112 can also be used with Flock® tables. Specify table tops with or without grommets. See page 104. Specify bases separately, see pages 106-107. Rectangle and Racetrack tops come with 2 grommet cutouts if specified with Round grommet. For a complete line of compatible Flock® collaborative seating solutions, please see pages 86-101 of the seating section.

HON Recommendation: HFTLS36.G.N.C - List Price \$386

HOW TO SPECIFY



<p>Select Model Number</p> <p>HFTLS36.</p>	<p>Select Edge Detail</p> <p>G 2MM Edge</p> <p>Select Edge Color</p> <p>See page 102</p> <p>G.</p>	<p>Select Grommet Option</p> <p>N No Grommet G Round Grommet (+ \$15 per grommet cutout) See page 104 for Grommet placement</p> <p>Select Grommet Color</p> <p>S Charcoal TI Platinum Metallic</p> <p>N.</p>	<p>Select Laminate Color</p> <p>See page 102</p> <p>C.</p>
---	--	--	---

FLOCK® Collaborative Table Bases

GSA SIN 711-11

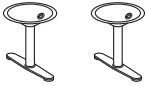
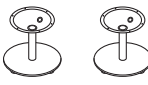
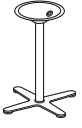

Icon Legend on page 14

	DESCRIPTION	MODEL	SHIP WEIGHT	CUBE	LIST PRICE
	Base T-Leg Style — For 18”H Tables For 60”W x 24”D Rectangle or Racetrack Table Tops • Two bases shipped in separate cartons.	HFTB17N	40	6.0	\$860
	Base Disc Style — For 18”H Tables • Use with 60”W x 24”D Racetrack or Rectangle table tops only. • Two bases shipped in separate cartons.	HFDB17N	74	6.0	\$944
	Base Disc Style — For 18”H Tables For 30” and 36” Round or Square Table Tops	HFDB17B	37	3.0	\$462
	Base X-Style — For 29½”H Tables For 30” Round or Square Table Tops For 36” Round or Square Table Tops Use with 33”D x 72”W x 84”W and 96”W Rectangle or Racetrack Table Tops • Two bases shipped in separate cartons	HFXB29A HFXB29B HFXB29AN	40 53 80	16.1 16.1 32.2	\$537 \$569 \$1052
	Base X-Style — For 18”H Tables For 30” and 36” Round or Square Table Tops	HFXB17B	37	3.0	\$462
	Base Disc Style — For 29½”H Tables For 30” Round or Square Table Tops For 36” Round or Square Table Tops Use with 33”D x 72”W x 84”W and 96”W Rectangle or Racetrack Table Tops • Two bases shipped in separate cartons	HFDB29A HFDB29B HFDB29AN	40 56 80	16.1 16.1 32.2	\$537 \$569 \$1052

NOTES: Flock® Bases available in Disc, T-Leg and X styles. Specify bases for collaborative tables at 18”H, 29½”H or 41”H standing height. Choose from bases with or without footrings. Each base includes adjustable leveling glides. Leveling glides adjust approximately 1”.

HON Recommendation: HFXB29AN.P7A - List Price \$1052

HOW TO SPECIFY

Select Model Number

Select Paint Color

P6N Textured Satin Chrome
P7A Textured Charcoal

H F X B 2 9 A N .

P 7 A

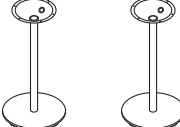
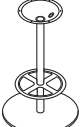
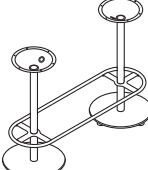

FLOCK® Collaborative Table Bases

	DESCRIPTION	MODEL	SHIP WEIGHT	CUBE	LIST PRICE
	Base X-Style — For 41”H Standing Height Tables • Use with 33”D x 72”W, 84”W and 96”W Rectangle or Racetrack Table Tops • Two bases shipped in separate cartons	HFXB42AN	84	36.4	\$1128
	Base X-Style — For 41”H Standing Height Tables For 30” Round or Square Table Tops For 36” Round or Square Table Tops	HFXB42A HFXB42B	42 55	18.2 16.1	\$564 \$596
	Base Disc Style — For 41”H Standing Height Tables • Use with 33”D x 72”W, 84”W and 96”W Rectangle or Racetrack table tops, when a Footring is not desired. • Two bases shipped in separate cartons.	HFDB42AN	92	19.0	\$1094
	Base Disc Style — For 41”H Standing Height Tables For 30” Round or Square Table Tops For 36” Round or Square Table Tops	HFDB42A HFDB42B	46 62	9.5 13.5	\$547 \$581
	Base Disc Style with Footring — For 41”H Standing Height Tables For 30” Round or Square Table Tops For 36” Round or Square Table Tops Use with 33”D x 72”W x 84”W and 96”W Rectangle or Racetrack Table Tops • Two bases shipped in separate cartons	HFDB42AF HFDB42BF HFDB42AFN	56 68 112	9.5 13.5 32.2	\$710 \$744 \$1392
	Base Disc Style with Footring — For 41”H Standing Height Tables For 33”D x 96”W Rectangle or Racetrack Table Tops For 33”D x 84”W Rectangle or Racetrack Table Tops For 33”D x 72”W Rectangle or Racetrack Table Tops NOTES: Includes two bases and a single oval footring that spans both tables. Two bases and footring shipped in three separate cartons.	HFDB42AF96 HFDB42AF84 HFDB42AF72	121 123 125	19.7 19.8 19.9	\$1639 \$1585 \$1557

HON Recommendation: HFXB42B.P7A - List Price \$596

HOW TO SPECIFY

<p>Select Model Number</p>	<p>Select Paint Color</p> <p>P6N Textured Satin Chrome P7A Textured Charcoal</p>
<div style="display: flex; justify-content: space-around; border: 1px solid black; padding: 2px;"> HFXB42B </div>	<div style="display: flex; justify-content: space-around; border: 1px solid black; padding: 2px;"> P7A </div>

FLOCK® Collaborative Tables

GSA SIN 711-11



Icon Legend on page 14

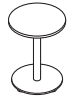

DESCRIPTION	MODEL	SHIP WEIGHT	CUBE	L1 LIST	L2 UPCHARGE
Laminate Personal Table 18" Dia. x 25"H NOTES: Accessory Port options on the Collaborative Cube and Cylinder tables allow for different accessories to be added to the tables such as tablet arms or lamps. Use the Tablet Accessory with the Collaborative Cube and Cylinder tables for additional workspace. Attaches to tables through ports, which can be located in different location options. See page 104 for port location information. For grommet and port information, see page 104. HGRMTAC, HGRMTDATA and HGRMTUSB2 on page 112 can also be used with Flock® tables. Legs can be adjusted for leveling. Standard Leg (L) can be adjusted for leveling. For a complete line of compatible Flock® collaborative seating solutions, please see pages 86-101 of the seating section.	HFTPTL18	36	4.5	\$559	\$12

HON Recommendation: HFTPTL18.C.C.P7A - List Price \$559

HOW TO SPECIFY

Select Model Number H F T P T L 1 8 .	Select Edge Detail/Color C .	Select Laminate Top Color See page 102 C .	Select Base Paint Color P6N Textured Satin Chrome P7A Textured Charcoal P 7 A
---	--	---	---



FLOCK® Collaborative Tables

	DESCRIPTION	MODEL	SHIP WEIGHT	CUBE	L1 LIST	L2 UPCHARGE
	Laminate Collaborative Cube and Cylinder Tables					
	24" Laminate Cube Table — 24"W x 24"D x 17½"H	HFTLS24	44	5.0	\$671	\$30
	26" Laminate Cylinder Table — 26" Dia. x 17½"H	HFTLD26	39	5.0	\$615	\$30
	NOTES: Accessory port quantity and configuration on tables should correspond to the accessories planned for the table. For grommet and port information, see page 104.					

HON Recommendation: HFTLS24.N.O.N.TS.P7A - List Price \$671

HOW TO SPECIFY

<p>Select Model Number</p> <p>HFTLS24.</p>	<p>Select Grommet Option</p> <p>See page 104 for Grommet placement</p> <p>N No Grommet G Round Grommet — centered (+ \$15)</p> <p>N.</p>	<p>Select Accessory Port Option</p> <p>See page 104 for Port placement</p> <p>0 No Port 1 One Corner Port 2 Two Ports — Opposite (+ \$10 per port)</p> <p>0.</p>	<p>Select Laminate Top Color</p> <p>See page 102</p> <p>N.</p>	<p>Select Leg Option</p> <p>L Standard Leg Leg Options TR Tapered Round Leg TS Tapered Square Leg</p> <p>TS.</p>	<p>Select Paint Color</p> <p>P6N Textured Satin Chrome P7A Textured Charcoal</p> <p>P7A</p>
---	---	--	---	---	--

FLOCK® Collaborative Tables

GSA SIN 711-11



Icon Legend on page 14



DESCRIPTION	MODEL	SHIP WEIGHT	CUBE	L1 LIST	L2 UPCHARGE
Laminate Tablet Accessory 14" Dia. x 10"H from table top Use with Collaborative Cube and Cylinder tables for additional workspace. Attaches to tables through ports. Multiple port location options are available. Tablet pivots/swivels toward the user.	HFTTAL14	6	2.5	\$332	\$15

HON Recommendation: HFTTAL14.C.C.P7A - List Price \$332

HOW TO SPECIFY

<p>Select Model Number</p> <p>H F T T A L 1 4 .</p>	<p>Select Edge Detail/Color</p> <p>C .</p>	<p>Select Laminate Top Color</p> <p>See page 102</p> <p>C .</p>	<p>Select Paint Color</p> <p>P6N Textured Satin Chrome P7A Textured Charcoal</p> <p>P 7 A</p>
--	---	--	---



FLOCK® Collaborative Accessories



DESCRIPTION

Flock Floor Lamp
Flock Lamp Accessory for Cube/Cylinder Table

NOTES: Flock® Floor Lamp Accessory fits into the Cube or Cylinder table via a port, to add a lamp option to the table. Accessory port quantity and configuration on tables should correspond to the accessories planned for the table. For grommet and port information, see page 104. Both models use the Lamp Shade model HFASH1 below or accept shades that use the Nord style connector. Flock® Floor Lamp model HFAFL1 paired with Lamp Shade model HFASH1 to complete the Flock® collaborative space. Use the Lamp Accessory model HFALA1 with lamp shade model HFASH1 to add a coordinated lamp to any Cube or Cylinder table. Electrical components are ETL listed. For a complete line of compatible Flock® collaborative seating solutions, please see pages 86-101 of the seating section.

MODEL

HFAFL1
HFALA1

SHIP WEIGHT **CUBE**

35 0.04
 11 0.8

LIST PRICE

\$497
\$272

HOW TO SPECIFY

Select Model Number

Select Paint Color

- P6N** Textured Satin Chrome
- P7A** Textured Charcoal

H F A F L 1 .

P 7 A



DESCRIPTION

Flock Lamp Shade

- Drum-style (straight sides)
- Fine linen fabric, with matching trim
- Diffusers on top and bottom to provide even lighting

MODEL

HFASH1

SHIP WEIGHT **CUBE**

4 3.3

LIST PRICE

\$302

HON Recommendation: HFAFL1.P7A - List Price \$497 + HFASH1.WL - List Price \$302 = Total Price \$799

HOW TO SPECIFY

Select Model Number

Select Color

- WL** White Linen

H F A S H 1 .

W L

FLOCK® Collaborative Accessories

GSA CONTRACT AS NOTED



Icon Legend on page 14

HGRMTAC

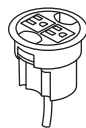

SIN 71-302

POWER HUB

3" Grommet Mount

DIMENSIONS

Ship Weight: 1.3
Cube: 0.2

LIST PRICE

\$100

NOTES: Fits in 3" round grommet holes. Field installed with Plug-and-play ease. Two grounded AC power outlets. Includes 6' cord with three-prong plug.

ⓘ Available in black only (no color designation so use .X)

HGRMTUSB2



OM

POWER/USB HUB

3" Grommet Mount

DIMENSIONS

Ship Weight: 1.3 ⓘ
Cube: 0.2

LIST PRICE

\$198

NOTES: One grounded AC power outlet with 2 USB ports. UL Listed.

ⓘ Available in black only (no color designation so use .X)

HGRMTDATA



SIN 711-11

DATA GROMMET

DIMENSIONS

Ship Weight: 0.2
Cube: 0.2

LIST PRICE

\$15

NOTES: Blank grommet kit that includes adapters for a variety of manufacturers jacks and couplers. Fits in 3" round grommet holes.

ⓘ Available in black only (no color designation so use .P)

HON Recommendation: HGRMTUSB2.X - List Price \$198

HOW TO SPECIFY

Select Model Number

HGRMTAC



FOLDING CHAIRS

HFC01



FOLDING CHAIR

Steel (without Padded Seat)

DIMENSIONS

Depth:	19 ⁵ / ₈	Seat to Floor Height:	17
Width:	18 ¹ / ₂	Ship Weight:	38
Height:	29 ¹ / ₄	Cube:	3.4
		Weight Rating:	250 lbs.

LIST PRICE PER CARTON

\$201
Reference Single Unit @
\$50.25

NOTES: Double-reinforced steel at all four pivot points instead of two. Cross braces are welded at four points, front and back. All leg tubes have slip-resistant, color-matched polyethylene end caps.

Model HFC01 is ordered and shipped four (4) chairs per carton. Pricing shown is per carton. Ordering 2 of Model HFC01 will result in 2 cartons being shipped, giving you 8 chairs.

Frame color available in Light Beige (LBG) only.

HFC02



FOLDING CHAIR

Steel (with Light Beige Vinyl Padded Seat)

DIMENSIONS

Depth:	19 ⁵ / ₈	Seat to Floor Height:	17 ¹ / ₂
Width:	18 ¹ / ₂	Ship Weight:	43
Height:	29 ¹ / ₄	Cube:	3.4
		Weight Rating:	250 lbs.

LIST PRICE PER CARTON

\$248
Reference Single Unit @
\$62.00

NOTES: Double-reinforced steel at all four pivot points instead of two. Cross braces are welded at four points, front and back. All leg tubes have slip-resistant, color-matched polyethylene end caps.

Model HFC02 is ordered and shipped four (4) chairs per carton. Pricing shown is per carton. Ordering 2 of Model HFC02 will result in 2 cartons being shipped, giving you 8 chairs.

Frame color available in Light Beige (LBG) only.

HFC32

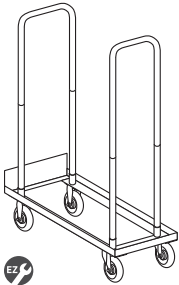

CART

For Folding Chair Models HFC01 and HFC02

DIMENSIONS

Depth:	38 ¹ / ₂	Ship Weight:	54
Width:	19 ¹ / ₂	Cube:	4.7
Height:	69 ³ / ₈		

LIST PRICE

\$481

NOTES: Holds 32 of Model HFC01 and 24 of Model HFC02. Cart is shipped . Customer or dealer must assemble vertical uprights to the base.

Available in Light Beige (LBG) only.

HON Recommendation: HFC01.LBG - List Price \$201

HOW TO SPECIFY

Select Model Number	Select Frame
	LBG Beige (only)
HFC01.	LBG

GAMUT® 2070 SERIES



Gamut High-Back Chair shown with 10500 Series™ desks.

GAMUT® 2070 SERIES

When you can fill every space with a consistent seating solution that unifies your organization, you've covered the Gamut. This collection of executive and conference seating features generous proportions, straightforward style and intuitive design elements. High-back and mid-back task chairs feature tilt tension, tilt lock and pneumatic seat height adjustment for a personal fit. Matching guest chairs create aesthetic consistency throughout your space, and provide outstanding comfort to your guests.



FEATURES

- Seat depth adjustment adapts to users of various heights.
- Fixed arms increase upper body support.
- Fully-upholstered outer back.
- One-touch seat height adjustment easily moves the seat up and down.
- Tilt tension controls the rate and ease of recline.
- Tilt lock allows the user to lock out the tilt function.
- 360-degree swivel provides freedom of movement in any direction.
- Matching guest chair creates a coordinated workspace.
- Warranted for users up to 250 lbs.

GAMUT®

2070 Series Options

MODEL OPTIONS

H2071



Executive High-Back

Pneumatic, Swivel, Tilt, Tilt Tension, Tilt Lock, Loop Arms

H2072



Managerial Mid-Back

Pneumatic, Swivel, Tilt, Tilt Tension, Tilt Lock, Loop Arms

H2073



Guest Chair

Sled Base with Fixed Arms

CASTERS



CODE	DESCRIPTION	PRICE
H	Hard Caster	+\$0



S	Soft Caster	+\$30
----------	-------------	--------------

*Only available on models H2071 and H2072

FRAME

CODE	DESCRIPTION	PRICE
T	Black	+\$0

AVAILABLE FABRICS

GRADE 1	GRADE 2	GRADE 3	GRADE 4	GRADE 5	GRADE 6	GRADE 7	GRADE 8	GRADE 9	GRADE 10	GRADE 11	GRADE 12	GRADE L
Arrondi *	Appoint Seating	Epic	Bar	Amuse	Intermix II		Brisa® Polyurethane	Eli Vinyl	Affinity	Acrobat	Fenestra	
Centurion	Bangle	Infinity	Blip	Avenue	Raffia Vinyl			Martini Vinyl	Concentric	Whirl	Helix	
Classic	Clyde	Knack	Coin	Lariat	Wooly			Olympus Vinyl	Juxy			
Compass	Doty	Marathon	Current	Outlander								
Confetti	Esplanade *	Millennium	Decode	Polka								
Contourette	Expo	Odyssey	Disc	Riddle								
Polyurethane	Fuse	Silvertext™ Vinyl	Divide	Sequence								
Dapper	Gio *	Syntax	Habit	Free								
Inertia	Moguls	Tradition	Hive	Solace								
Optic	Origin	Via	Lineup	Tribeca								
Stitchery	Seed		Manner									
Tectonic	Sockhop		Medium									
	Spin Seating		Messenger									
	Whisper Vinyl		Metric									
			Oblique									
			Pick									
			Sprint									
			Technic									

Reference Fabric Color Combinations on pages 18-29 for color codes and legend on page 19 for lead times. Visit hon.com for additional partnership fabrics.

NOTES: Gathers and creases may be more visible with Attire (AI) and Optic (OP) fabrics due to the inherent design and construction of these fabrics. COM yardage shown is for Pattern Cut only. Contact Customer Service for Railroaded yardage requirements. For additional HON to Supply COM fabric grade pricing, go to honready.hon.com and click on the HON to Supply COM link.

🔥 For Fire Code model, availability and ordering method, refer to pages 34-39. Available on select models, contact HON Customer Support for availability.

* Fabric is de-emphasized.

GAMUT® 2070 Series

GSA SIN 711-18



Icon Legend on page 14

H2071



EXECUTIVE HIGH-BACK

Pneumatic
Swivel
Tilt
Tilt Tension
Tilt Lock
Loop Arms

Functions: **A, E, F, K, L**
(Function Key on pages 16-17)

DIMENSIONS

Depth:	36¼	Arm Width:	20¾
Width:	27½	Seat to Floor Height:	18½-23½
Height:	46⅝	Usable Seat Depth:	16⅝
Seat Depth:	16⅝	Ship Weight:	44
Seat Width:	20¼	Cube:	11.3
Back Width:	20¾	COM:	2.5
Back Height:	28	Weight Rating:	250 lbs.

FABRIC PRICE CODES

1	\$529	8	\$874
2	\$589	9	\$919
3	\$649	10	\$964
4	\$694	11	\$1009
5	\$739	12	\$1054
6	\$784		
7	\$829		

H2072



MANAGERIAL MID-BACK

Pneumatic
Swivel
Tilt
Tilt Tension
Tilt Lock
Loop Arms

Functions: **A, E, F, K, L**
(Function Key on pages 16-17)

DIMENSIONS

Depth:	36¼	Arm Width:	20¾
Width:	27½	Seat to Floor Height:	18½-23½
Height:	43⅝	Usable Seat Depth:	16⅝
Seat Depth:	16⅝	Ship Weight:	43
Seat Width:	20¼	Cube:	10.3
Back Width:	20¾	COM:	2.5
Back Height:	25¼	Weight Rating:	250 lbs.

FABRIC PRICE CODES

1	\$503	8	\$848
2	\$563	9	\$893
3	\$623	10	\$938
4	\$668	11	\$983
5	\$713	12	\$1028
6	\$758		
7	\$803		

H2073



GUEST CHAIR

Sled Base with Fixed Arms

DIMENSIONS

Depth:	28¼	Arm Width:	20⅝
Width:	27	Seat to Floor Height:	19½
Height:	35⅝	Usable Seat Depth:	18
Seat Depth:	19	Ship Weight:	41
Seat Width:	20½	Cube:	19.8
Back Width:	20¼	COM:	2.0
Back Height:	17¾	Weight Rating:	250 lbs.

FABRIC PRICE CODES

1	\$399	8	\$675
2	\$447	9	\$711
3	\$495	10	\$747
4	\$531	11	\$783
5	\$567	12	\$819
6	\$603		
7	\$639		

HON Recommendation: H2071.H.CU__T - List Price \$529

HOW TO SPECIFY

Select
Model Number

H 2 0 7 1 .

Select
Caster

H Hard Caster
S Soft Caster (+ \$30)
Does not apply to model H2073

H .

Select
Fabric

See page 115

C U 1 0 .

Select
Frame

T Black

T

GROVE™



Grove Lounge shown with Flock® Guest Chairs and Arrange™ Tables.

GROVE™

Find a comfy place to put your feet up, huddle up and power up. Grove is the versatile lounge seating designed to help you greet, meet, focus, relax and accomplish more. This change-of-pace collection delivers the comfort people crave, while encouraging focus and interaction throughout the workplace. Grove's attractive design is rivaled only by its flexibility. Models include a single seat, two-seat, three-seat, and two-seat with table — all with three arm style and two leg style options, as well as accessories that support connectivity and collaboration. Grove has the look you're going for, and the comfort and versatility people have been waiting for.



FEATURES

- Each model can be combined to create arrangements suitable for any space.
- Optional integrated worksurfaces create more personal space and provide a convenient worksurface.
- Design complements Flock ottomans and tables.
- Integrated power grommets keep laptops and phone powered up anywhere.
- The dual fabric option coordinates two high-quality HON fabrics for a contemporary look.
- Choose from Single Seat, Two-Seat, Three-Seat Lounge, or Two-Seat with Table options.
- Choose from 3 arm options — Armless (N), Straight Arms (A), or Tapered Arm (B).
- Table available with two grommets and an accessory port option.
- Offers a table between the seats that provides separation and a usable worksurface.
- Warranted for users up to 300 lbs.

MODEL OPTIONS

HML1S
HML1SDF - Dual Fabric

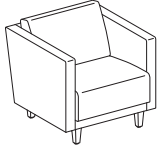

Lounge
Single Seat

HML2S
HML2SDF - Dual Fabric

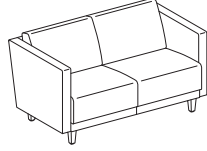

Lounge
Two-Seat

HML3S
HML3SDF - Dual Fabric

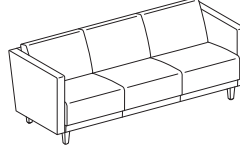

Lounge
Three-Seat

HML2ST
HML2STDF - Dual Fabric

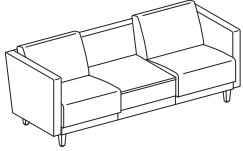

Lounge
Two-Seat with Table

ARM STYLE

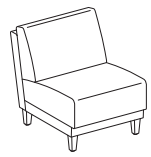

CODE	DESCRIPTION	PRICE
N	Armless	+\$0

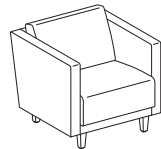

A	Straight Arms	+\$300
----------	---------------	---------------

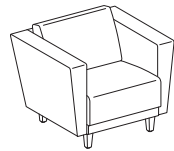

B	Tapered Arms	+\$350
----------	--------------	---------------

L1 LAMINATE	COLOR CODE
Black	P
Bourbon Cherry	H
Brilliant White	WHIT
Charcoal	S
Cognac	COGN
Harvest	C
Loft	LOFT
Mahogany	N
Mocha	MOCH
Natural Maple	D
Pinnacle	PINC
Shaker Cherry	F

L2 LAMINATE	COLOR CODE
Lowell Ash NEW! 1/30/2017	LLA1
Natural Recon NEW! 1/30/2017	LNR1
Phantom Ecru NEW! 1/30/2017	LPE1
Portico Teak NEW! 1/30/2017	LPT1
Skyline Walnut NEW! 1/30/2017	LSW1

*Specify for models HML2ST and HML2STDF only

LEG STYLE



CODE	DESCRIPTION	PRICE
TS	Tapered Square	+\$0



TR	Tapered Round	+\$0
-----------	---------------	-------------

LEG COLOR

CODE	DESCRIPTION	PRICE
P6N	Textured Satin Chrome	+\$0
P7A	Textured Charcoal	+\$0
H	Bourbon Cherry	+\$100
F	Shaker Cherry	+\$100
N	Mahogany	+\$100
C	Harvest	+\$100
D	Natural Maple	+\$100
MOCH	Mocha	+\$100
PINC	Pinnacle	+\$100
COGN	Cognac	+\$100
New! 1/30/2017 LLA1	Lowell Ash	+\$100
New! 1/30/2017 LNR1	Natural Recon	+\$100
New! 1/30/2017 LPE1	Phantom Ecru	+\$100
New! 1/30/2017 LPT1	Portico Teak	+\$100
New! 1/30/2017 LSW1	Skyline Walnut	+\$100

CUT OUT

CODE	DESCRIPTION	PRICE
N	No Cutout	+\$0
G	Round Grommet Cutout	+\$30
G1	Pop-Up Port Cutout	+\$40

*Specify for models HML2ST and HML2STDF only

ACCESSORY PORT LOCATION

CODE	DESCRIPTION	PRICE
0	No Port	+\$0
2	Two Tablet Ports Opposite	+\$20

*Specify for models HML2ST and HML2STDF only

GROVE™ Fabric Options

AVAILABLE FABRICS

GRADE 1	GRADE 2	GRADE 3	GRADE 4	GRADE 5	GRADE 6	GRADE 7	GRADE 8	GRADE 9	GRADE 10	GRADE 11	GRADE 12	GRADE L
Centurion	Appoint Seating	Canter Polyurethane	Bar	Amuse	Intermix II	Ascend	Brisa® Polyurethane	Eli Vinyl	Affinity	Acrobat	Fenestra	Denver Leather (Matches EE Vinyl)
Compass	Bangle	Epic	Beeline	Avenue	Keynote	Central	Kindred	Martini Vinyl	Concentric	Natural World	Helix	
Confetti	Clyde	Infinity	Blip	Lariat	Raffia Vinyl	Channel		Olympus Vinyl	Juxy	Whirl	Lava	
Contourette	Dotty	Knack	Coin	Outlander	Velocity	Domain		Silica			Ripple	
Polyurethane	Dotto	Marathon	Cover Cloth	Polka	Wooly	Synergy		Silica Leather				
Dapper	Expo	Millennium	Current	Riddle		Waver		Silica Tech				
Inertia	Fuse	Odyssey	Decode	Sentry-HC								
Optic	Moguls	Silvertext™ Vinyl	Disc	Sequence								
Stitchery	Origin	Syntax	Divide	Solace								
Tectonic	Seed	Tradition	Free	Tribeca								
	Sockhop	Via	Habit									
	Spin Seating		Hive									
	Whisper Vinyl		Lineup									
			Manner									
			Medium									
			Messenger									
			Metric									
			Oblique									
			Pick									
			Sprint									
			Technic									

Reference Fabric Color Combinations on pages 18-29 for color codes and legend on page 19 for lead times. Visit hon.com for additional partnership fabrics.

NOTES: Gathers and creases may be more visible with Attire (AI) and Optic (OP) fabrics due to the inherent design and construction of these fabrics. For additional HON to Supply COM fabric grade pricing, go to honready.hon.com and click on the HON to Supply COM link.

⚠ For Fire Code model, availability and ordering method, refer to pages 34-39. Available on select models, contact HON Customer Support for availability.

DUAL FABRIC COM YARDAGE

Due to fabric pattern nesting and potential reduction of fabric yield, some dual fabric models may require more total yardage than standard models.

	FRAME/ARMS	BACK/SEAT CUSHION
HML1SDF.N	1.5 yd	2.0 yd
HML1SDF.A	4.0 yd	2.0 yd
HML1SDF.B	4.0 yd	2.0 yd
HML2SDF.N	2.2 yd	3.5 yd
HML2SDF.A	4.0 yd	3.5 yd
HML2SDF.B	4.0 yd	3.5 yd
HML3SDF.N	2.8 yd	5.2 yd
HML3SDF.A	5.4 yd	5.2 yd
HML3SDF.B	5.4 yd	5.2 yd
HML2STDF.N	2.8 yd	3.5 yd
HML2STDF.A	5.4 yd	3.5 yd
HML2STDF.B	5.4 yd	3.5 yd



HML1S

LOUNGE

Single Seat

DIMENSIONS

FABRIC PRICE CODES



Armless

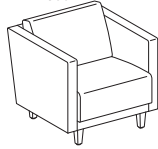

Straight Arms

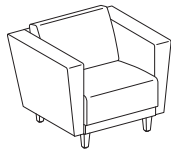

Tapered Arms

Depth:	31½	Ship Weight (armless):	61
Height:	29¼	Ship Weight (with straight arms):	77
Seat Width:	23½	Ship Weight (with tapered arms):	85
Back Width:	23½	Cube (armless):	19.8
Back Height:	19	Cube (with straight arms):	19.8
Width (armless):	23½	Cube (with tapered arms):	19.8
Width (with straight arms):	29¾	COM (armless):	3.0
Width (with tapered arms):	35	COM (with straight arms):	5.1
Arm Width:	23½	COM (with tapered arms):	5.1
Seat to Floor Height:	16	Weight Rating:	300lbs.
Usable Seat Depth:	18¾		(per seat)

1	\$1125	8	\$1539
2	\$1197	9	\$1593
3	\$1269	10	\$1647
4	\$1323	11	\$1701
5	\$1377	12	\$1755
6	\$1431	L	\$1725
7	\$1485		

HML2S

LOUNGE

Two-Seat

DIMENSIONS

FABRIC PRICE CODES

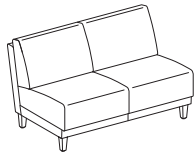

Armless

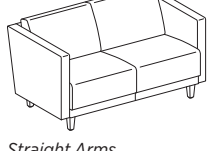

Straight Arms

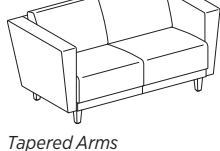

Tapered Arms

Depth:	31½	Ship Weight (armless):	100
Height:	29¼	Ship Weight (with straight arms):	116
Seat Width:	48	Ship Weight (with tapered arms):	124
Back Width:	48	Cube (armless):	35.6
Back Height:	19	Cube (with straight arms):	35.6
Width (armless):	48	Cube (with tapered arms):	35.6
Width (with straight arms):	54¼	COM (armless):	5.0
Width (with tapered arms):	59½	COM (with straight arms):	7.6
Arm Width:	48	COM (with tapered arms):	7.6
Seat to Floor Height:	16	Weight Rating:	300lbs.
Usable Seat Depth:	18¾		(per seat)

1	\$1700	8	\$2390
2	\$1820	9	\$2480
3	\$1940	10	\$2570
4	\$2030	11	\$2660
5	\$2120	12	\$2750
6	\$2210	L	\$2700
7	\$2300		

HON Recommendation: HML1S.A.PNS__TS.P7A - List Price \$1497

HOW TO SPECIFY

<p>Select Model Number</p> <p>HML1S</p>	<p>Select Arm Type</p> <p>N Armless A Straight Arms (+ \$300) B Tapered Arms (+ \$350)</p> <p>A</p>	<p>Select Fabric</p> <p>See page 120</p> <p>PNS007</p>	<p>Select Leg Type</p> <p>TS Tapered Square TR Tapered Round</p> <p>TS</p>	<p>Select Leg Color</p> <p>P6N Textured Satin Chrome P7A Textured Charcoal H Bourbon Cherry (+ \$100) F Shaker Cherry (+ \$100) N Mahogany (+ \$100) C Harvest (+ \$100) D Natural Maple (+ \$100) MOCH Mocha (+ \$100) PINC Pinnacle (+ \$100) COGN Cognac (+ \$100) LLA1 Lowell Ash (+ \$100) LNRI Natural Recon (+ \$100) LPE1 Phantom Ecru (+ \$100) LPT1 Portico Teak (+ \$100) LSW1 Skyline Walnut (+ \$100)</p> <p>P7A</p>
--	--	---	---	--

! Leg options - Tapered Square (TS) and Tapered Round (TR) are available in 2 poly and 13 woodgrain options.



HML3S

LOUNGE

Three-Seat

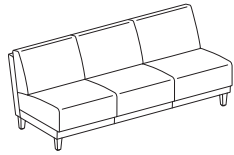

Armless

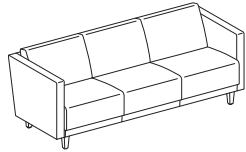

Straight Arms

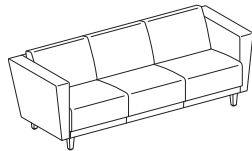

Tapered Arms

DIMENSIONS

Depth:	31½	Ship Weight (armless):	141
Height:	29¼	Ship Weight (with straight arms):	157
Seat Width:	71⅓	Ship Weight (with tapered arms):	165
Back Width:	71⅓	Cube (armless):	48.9
Back Height:	19	Cube (with straight arms):	48.9
Width (armless):	71⅓	Cube (with tapered arms):	48.9
Width (with straight arms):	77⅓	COM (armless):	7.2
Width (with tapered arms):	82⅓	COM (with straight arms):	8.9
Arm Width:	71⅓	COM (with tapered arms):	9.4
Seat to Floor Height:	16	Weight Rating:	300lbs.
Usable Seat Depth:	18¾		(per seat)

FABRIC PRICE CODES

1	\$2300	8	\$3335
2	\$2480	9	\$3470
3	\$2660	10	\$3605
4	\$2795	11	\$3740
5	\$2930	12	\$3875
6	\$3065	L	\$3800
7	\$3200		

HON Recommendation: HML3S.A.PNS__TS.P7A - List Price \$2780

HOW TO SPECIFY

Select Model Number	Select Arm Type	Select Fabric	Select Leg Type	Select Leg Color
	N Armless A Straight Arms (+ \$300) B Tapered Arms (+ \$350)	See page 120	TS Tapered Square TR Tapered Round	P6N Textured Satin Chrome P7A Textured Charcoal H Bourbon Cherry (+ \$100) F Shaker Cherry (+ \$100) N Mahogany (+ \$100) C Harvest (+ \$100) D Natural Maple (+ \$100) MOCH Mocha (+ \$100) PINC Pinnacle (+ \$100) COGN Cognac (+ \$100) LLA1 Lowell Ash (+ \$100) LNRI Natural Recon (+ \$100) LPE1 Phantom Ecru (+ \$100) LPT1 Portico Teak (+ \$100) LSW1 Skyline Walnut (+ \$100)
H M L 3 S .	A .	P N S 0 0 7 .	T S .	P 7 A

! Leg options - Tapered Square (TS) and Tapered Round (TR) are available in 2 poly and 13 woodgrain options.



HML2ST

LOUNGE

Two-Seat with Table

DIMENSIONS

FABRIC PRICE CODES

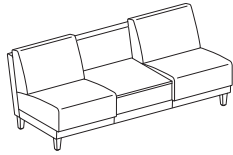

Armless

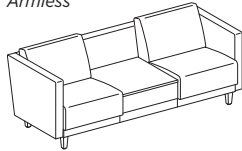

Straight Arms

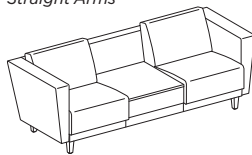

Tapered Arms

Depth:	31½	Ship Weight (armless):	146
Height:	29¼	Ship Weight (with straight arms):	162
Seat Width:	71½	Ship Weight (with tapered arms):	170
Back Width:	71½	Cube (armless):	48.9
Back Height:	19	Cube (with straight arms):	48.9
Width (armless):	71½	Cube (with tapered arms):	48.9
Width (with straight arms):	77½	COM (armless):	5.8
Width (with tapered arms):	82½	COM (with straight arms):	7.6
Arm Width:	71½	COM (with tapered arms):	7.7
Seat to Floor Height:	16	Weight Rating:	300lbs.
Usable Seat Depth:	18¾		(per seat)

1	\$2500	8	\$3328
2	\$2644	9	\$3436
3	\$2788	10	\$3544
4	\$2896	11	\$3652
5	\$3004	12	\$3760
6	\$3112	L	\$3700
7	\$3220		

NOTES: Offers a table between the seats that provides separation and a usable worksurface. Table available with two grommet and an accessory port option.

HON Recommendation: HML2ST.A.PNS___.TS.P7A.N.G1.0 - List Price \$2984

HOW TO SPECIFY

Select Model Number	Select Arm Type	Select Fabric	Select Leg Type	Select Leg Color	Select Laminate	Select Cut Out	Accessory Port Location
	N Armless A Straight Arms (+ \$300) B Tapered Arms (+ \$350)	See page 120	TS Tapered Square TR Tapered Round	P6N Textured Satin Chrome P7A Textured Charcoal H Bourbon Cherry (+ \$100) F Shaker Cherry (+ \$100) N Mahogany (+ \$100) C Harvest (+ \$100) D Natural Maple (+ \$100) MOCH Mocha (+ \$100) PINC Pinnacle (+ \$100) COGN Cognac (+ \$100) LLA1 Lowell Ash (+ \$100) LNRI Natural Recon (+ \$100) LPE1 Phantom Ecru (+ \$100) LPT1 Portico Teak (+ \$100) LSW1 Skyline Walnut (+ \$100)	See Chart on page 119 L2 (+ \$125)	N No Cutout G Round Grommet Cutout (+ \$30) G1 Pop-Up Port Cutout (+ \$40)	0 No Port 2 Two Tablet Ports Opposite (+ \$20)
H M L 2 S T .	A .	P N S 0 0 7 .	T S .	P 7 A .	N .	G 1 .	0

! Leg options - Tapered Square (TS) and Tapered Round (TR) are available in 2 poly and 8 woodgrain options.



HGRMTAC

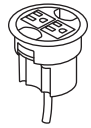

SIN 71-302

POWER HUB

3" Grommet Mount

DIMENSIONS

Ship Weight: 1.3
Cube: 0.2

LIST PRICE

\$100

NOTES: Fits in 3" round grommet holes. Field installed with Plug-and-play ease. Two grounded AC power outlets. Includes 6' cord with three-prong plug.

! Available in black only (no color designation so use .X)

HGRMTUSB2



OM

POWER/USB HUB

3" Grommet Mount

DIMENSIONS

Ship Weight: 1.3 Ⓢ
Cube: 0.2

LIST PRICE

\$198

NOTES: One grounded AC power outlet with 2 USB ports. UL Listed.

! Available in black only (no color designation so use .X)

HFTTAL14



SIN 711-11

TABLET ACCESSORY

Laminate

DIMENSIONS

Diameter: 14 Ship Weight: 6.0
Height from Table Top: 10 Cube: 2.5

LIST PRICE

\$332

NOTES: Use with Collaborative Cube and Cylinder tables for additional workspace. Attaches to tables through ports. Multiple port location options are available. Tablet pivots/swivels toward the user.

HTPWRGROM1

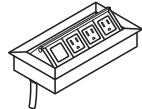

SIN 711-11

POP-UP PORT

DIMENSIONS

Ship Weight: 5.0
Cube: 0.3

LIST PRICE

\$343

NOTES: Fits into 4" x 8" cutout. Specify G1 cutout in table top. Pop-up Port provides three power ports and one blank data receptacle. Sits flush with worksurface when closed. Finish is anodized aluminum. Includes 6' cord with three-prong plug.

HON Recommendation: HTPWRGROM1 - List Price \$343

HOW TO SPECIFY

Select
Model Number

H G R M T A C



HML1SDF

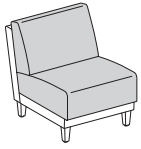

Armless

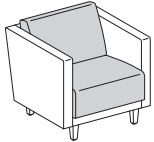

Straight Arms

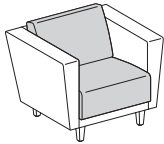

Tapered Arms

SINGLE SEAT LOUNGE

Dual Fabric

DIMENSIONS

Depth:	31½	Ship Weight (armless):	61
Height:	29¾	Ship Weight (with straight arms):	77
Seat Width:	23½	Ship Weight (with tapered arms):	85
Back Width:	23½	Cube (armless):	19.8
Back Height:	19	Cube (with straight arms):	19.8
Width (armless):	23½	Cube (with tapered arms):	19.8
Width (with straight arms):	29¾	COM (armless):	3.0
Width (with tapered arms):	35	COM (with straight arms):	5.1
Arm Width:	23½	COM (with tapered arms):	5.1
Seat to Floor Height:	16	Weight Rating:	300lbs.
Usable Seat Depth:	18¾		(per seat)

FABRIC PRICE CODES

1	\$1200		
<i>Add to Base Price Above</i>			
		Frame/ Arms	Back/Seat Cushions
2	\$36		\$48
3	\$72		\$96
4	\$99		\$132
5	\$126		\$168
6	\$153		\$204
7	\$180		\$240
8	\$207		\$276
9	\$234		\$312
10	\$261		\$348
11	\$288		\$384
12	\$315		\$420
L	\$300		\$400

For dual fabric models, start with the base price, then add the additional amount for the back and seat from the corresponding matrix to determine the final list price. Choose any combination of fabric grades for the back and seat.

Example: HML1SDF base price (\$1200) + Grade 2 frame/arms fabric (add \$36) + Grade 4 back/seat fabric (add \$132) = Total \$1368 List
 HML1SDF base price (\$1200) + Grade 5 frame/arms fabric (add \$126) + Grade 3 back/seat fabric (add \$96) = Total \$1422 List

HON Recommendation: HML1SDF.A.PNS__PNS__.TS.P7A - List Price \$1584

HOW TO SPECIFY

Select Model Number	Select Arm Type	Select Frame/Arms Fabric	Select Back/Seat Cushions Fabric	Select Leg Type	Select Leg Color
	N Armless A Straight Arms (+ \$300) B Tapered Arms (+ \$350)	See page 120	See page 120	TS Tapered Square TR Tapered Round	P6N Textured Satin Chrome P7A Textured Charcoal H Bourbon Cherry (+ \$100) F Shaker Cherry (+ \$100) N Mahogany (+ \$100) C Harvest (+ \$100) D Natural Maple (+ \$100) MOCH Mocha (+ \$100) PINC Pinnacle (+ \$100) COGN Cognac (+ \$100) LLA1 Lowell Ash (+ \$100) LNRI Natural Recon (+ \$100) LPE1 Phantom Ecru (+ \$100) LPT1 Portico Teak (+ \$100) LSW1 Skyline Walnut (+ \$100)
HML1SDF.	A.	PNS004.	PNS007.	TS.	P7A

! Leg options - Tapered Square (TS) and Tapered Round (TR) are available in 2 poly and 8 woodgrain options.

GROVE™ Dual Fabric

NOT ON GSA CONTRACT



Icon Legend on page 14

HML2SDF

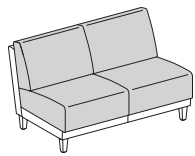

Armless

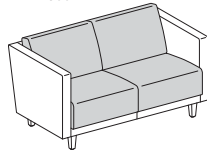

Straight Arms

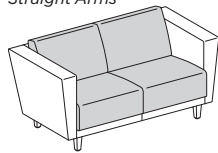

Tapered Arms

TWO-SEAT LOUNGE

Dual Fabric

DIMENSIONS

Depth:	31½	Ship Weight (armless):	100
Height:	29¼	Ship Weight (with straight arms):	116
Seat Width:	48	Ship Weight (with tapered arms):	124
Back Width:	48	Cube (armless):	35.6
Back Height:	19	Cube (with straight arms):	35.6
Width (armless):	48	Cube (with tapered arms):	35.6
Width (with straight arms):	54¼	COM (armless):	5.0
Width (with tapered arms):	59½	COM (with straight arms):	7.6
Arm Width:	48	COM (with tapered arms):	7.6
Seat to Floor Height:	16	Weight Rating:	300lbs.
Usable Seat Depth:	18¾		(per seat)

FABRIC PRICE CODES

1 \$1775

Add to Base Price Above

	Frame/ Arms	Back/Seat Cushions
2	\$60	\$84
3	\$120	\$168
4	\$165	\$231
5	\$210	\$294
6	\$255	\$357
7	\$300	\$420
8	\$345	\$483
9	\$390	\$546
10	\$435	\$609
11	\$480	\$672
12	\$525	\$735
L	\$500	\$700

For dual fabric models, start with the base price, then add the additional amount for the back and seat from the corresponding matrix to determine the final list price. Choose any combination of fabric grades for the back and seat.

Example: HML2SDF base price (\$1775) + Grade 2 frame/arms fabric (add \$60) + Grade 4 back/seat fabric (add \$231) = Total \$2066 List
 HML2SDF base price (\$1775) + Grade 5 frame/arms fabric (add \$210) + Grade 3 back/seat fabric (add \$168) = Total \$2153 List

HON Recommendation: HML2SDF.A.PNS__PNS__TS.P7A - List Price \$2219

HOW TO SPECIFY

Select Model Number H M L 2 S D F .	Select Arm Type N Armless A Straight Arms (+ \$300) B Tapered Arms (+ \$350)	Select Frame/Arms Fabric See page 120 P N S 0 0 4 .	Select Back/Seat Cushions Fabric See page 120 P N S 0 0 7 .	Select Leg Type TS Tapered Square TR Tapered Round T S .	Select Leg Color P6N Textured Satin Chrome P7A Textured Charcoal H Bourbon Cherry (+ \$100) F Shaker Cherry (+ \$100) N Mahogany (+ \$100) C Harvest (+ \$100) D Natural Maple (+ \$100) MOCH Mocha (+ \$100) PINC Pinnacle (+ \$100) COGN Cognac (+ \$100) LLA1 Lowell Ash (+ \$100) LNRI Natural Recon (+ \$100) LPE1 Phantom Ecru (+ \$100) LPT1 Portico Teak (+ \$100) LSW1 Skyline Walnut (+ \$100)
---	--	--	--	--	--

! Leg options - Tapered Square (TS) and Tapered Round (TR) are available in 2 poly and 8 woodgrain options.



HML3SDF

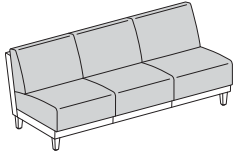

Armless

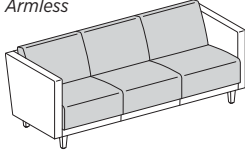

Straight Arms

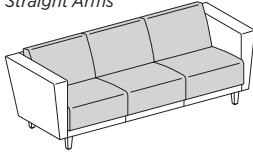

Tapered Arms

THREE-SEAT LOUNGE

Dual Fabric

DIMENSIONS

Depth:	31½	Ship Weight (armless):	141
Height:	29¾	Ship Weight (with straight arms):	157
Seat Width:	71½	Ship Weight (with tapered arms):	165
Back Width:	71½	Cube (armless):	48.9
Back Height:	19	Cube (with straight arms):	48.9
Width (armless):	71½	Cube (with tapered arms):	48.9
Width (with straight arms):	77½	COM (armless):	7.2
Width (with tapered arms):	82½	COM (with straight arms):	8.9
Arm Width:	71½	COM (with tapered arms):	9.4
Seat to Floor Height:	16	Weight Rating:	300 lbs.
Usable Seat Depth:	18¾		(per seat)

FABRIC PRICE CODES

1	\$2375		
<i>Add to Base Price Above</i>			
	Frame/ Arms	Back/Seat Cushions	
2	\$72	\$132	
3	\$144	\$264	
4	\$198	\$363	
5	\$252	\$462	
6	\$306	\$561	
7	\$360	\$660	
8	\$414	\$759	
9	\$468	\$858	
10	\$522	\$957	
11	\$576	\$1056	
12	\$630	\$1155	
L	\$600	\$1100	

For dual fabric models, start with the base price, then add the additional amount for the back and seat from the corresponding matrix to determine the final list price. Choose any combination of fabric grades for the back and seat.

Example: HML3SDF base price (\$2375) + Grade 2 frame/arms fabric (add \$72) + Grade 4 back/seat fabric (add \$363) = Total \$2810 List
 HML3SDF base price (\$2375) + Grade 5 frame/arms fabric (add \$252) + Grade 3 back/seat fabric (add \$264) = Total \$2891 List

HON Recommendation: HML3SDF.A.PNS__PNS__.TS.P7A - List Price \$2879

HOW TO SPECIFY

Select Model Number	Select Arm Type	Select Frame/Arms Fabric	Select Back/Seat Cushions Fabric	Select Leg Type	Select Leg Color
	N Armless A Straight Arms (+ \$300) B Tapered Arms (+ \$350)	See page 120	See page 120	TS Tapered Square TR Tapered Round	P6N Textured Satin Chrome P7A Textured Charcoal H Bourbon Cherry (+ \$100) F Shaker Cherry (+ \$100) N Mahogany (+ \$100) C Harvest (+ \$100) D Natural Maple (+ \$100) MOCH Mocha (+ \$100) PINC Pinnacle (+ \$100) COGN Cognac (+ \$100) LLA1 Lowell Ash (+ \$100) LNRI Natural Recon (+ \$100) LPE1 Phantom Ecru (+ \$100) LPT1 Portico Teak (+ \$100) LSW1 Skyline Walnut (+ \$100)
HML3SDF.	A.	PNS004.	PNS007.	TS.	P7A

! Leg options - Tapered Square (TS) and Tapered Round (TR) are available in 2 poly and 8 woodgrain options.

GROVE™ Dual Fabric

NOT ON GSA CONTRACT



Icon Legend on page 14

HML2STDF

TWO-SEAT WITH TABLE

Dual Fabric

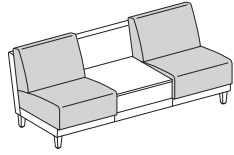

Armless

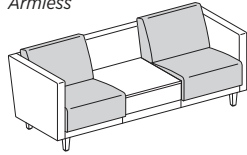

Straight Arms

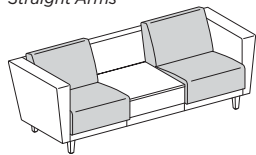

Tapered Arms

DIMENSIONS

Depth:	31½	Ship Weight (armless):	146
Height:	29¼	Ship Weight (with straight arms):	162
Seat Width:	71⅓	Ship Weight (with tapered arms):	170
Back Width:	71⅓	Cube (armless):	48.9
Back Height:	19	Cube (with straight arms):	48.9
Width (armless):	71⅓	Cube (with tapered arms):	48.9
Width (with straight arms):	77⅝	COM (armless):	5.8
Width (with tapered arms):	82⅝	COM (with straight arms):	7.6
Arm Width:	71⅓	COM (with tapered arms):	7.7
Seat to Floor Height:	16	Weight Rating:	300lbs.
Usable Seat Depth:	18¾		(per seat)

FABRIC PRICE CODES

1 \$2575

Add to Base Price Above

	Frame/ Arms	Back/Seat Cushions
2	\$72	\$84
3	\$144	\$168
4	\$198	\$231
5	\$252	\$294
6	\$306	\$357
7	\$360	\$420
8	\$414	\$483
9	\$468	\$546
10	\$522	\$609
11	\$576	\$672
12	\$630	\$735
L	\$600	\$700

NOTES: Offers a table between the seats that provides separation and a usable worksurface. Table available with two grommet and an accessory port option.

HON Recommendation: HML2STDF.A.PNS___.PNS___.TS.P7A.N.G1.0 - List Price \$3071

HOW TO SPECIFY

Select Model Number	Select Arm Type	Select Frame/Arms Fabric	Select Back/Seat Cushions Fabric	Select Leg Type	Select Leg Color	Select Laminate	Select Cut Out	Accessory Port Location
	N Armless A Straight Arms (+ \$300) B Tapered Arms (+ \$350)	See page 120	See page 120	TS Tapered Square TR Tapered Round	P6N Textured Satin Chrome P7A Textured Charcoal H Bourbon Cherry (+ \$100) F Shaker Cherry (+ \$100) N Mahogany (+ \$100) C Harvest (+ \$100) D Natural Maple (+ \$100) MOCH Mocha (+ \$100) PINC Pinnacle (+ \$100) COGN Cognac (+ \$100) LLA1 Lowell Ash (+ \$100) LNRI Natural Recon (+ \$100) LPE1 Phantom Ecru (+ \$100) LPT1 Portico Teak (+ \$100) LSW1 Skyline Walnut (+ \$100)	See Chart on page 119 L2 (+ \$125)	N No Cutout G Round Grommet Cutout (+ \$30) G1 Pop-Up Port Cutout (+ \$40)	0 No Port 2 Two Tablet Ports Opposite (+ \$20)
HML2STDF	A	PNS004	PNS007	TS	P7A	N	G1	0

! Leg options – Tapered Square (TS) and Tapered Round (TR) are available in 2 poly and 8 woodgrain options.



Icon Legend on page 14

HGRMTAC

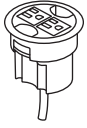

SIN 71-302

POWER HUB

3" Grommet Mount

DIMENSIONS

Ship Weight: 1.3
Cube: 0.2

LIST PRICE

\$100

NOTES: Fits in 3" round grommet holes. Field installed with Plug-and-play ease. Two grounded AC power outlets. Includes 6' cord with three-prong plug.

ⓘ Available in black only (no color designation so use .X)

HGRMTUSB2



OM

POWER/USB HUB

3" Grommet Mount

DIMENSIONS

Ship Weight: 1.3 ⓘ
Cube: 0.2

LIST PRICE

\$198

NOTES: One grounded AC power outlet with 2 USB ports. UL Listed.

ⓘ Available in black only (no color designation so use .X)

HFTTAL14



SIN 711-11

TABLET ACCESSORY

Laminate

DIMENSIONS

Diameter: 14 Ship Weight: 6.0
Height from Table Top: 10 Cube: 2.5

LIST PRICE

\$332

NOTES: Use with Collaborative Cube and Cylinder tables for additional workspace. Attaches to tables through ports. Multiple port location options are available. Tablet pivots/swivels toward the user.

HTPWGROM1

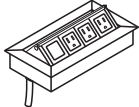

SIN 711-11

POP-UP PORT

DIMENSIONS

Ship Weight: 5.0
Cube: 0.3

LIST PRICE

\$343

NOTES: Fits into 4" x 8" cutout. Specify G1 cutout in table top. Pop-up Port provides three power ports and one blank data receptacle. Sits flush with worksurface when closed. Finish is anodized aluminum. Includes 6' cord with three-prong plug. HON Recommendation: HTPWRGROM1 - List Price \$343

HON Recommendation: HTPWRGROM1 - List Price \$343

HOW TO SPECIFY

Select
Model Number

H G R M T A C

GUESTSTACKER® 4030 Series



GuestStacker Stacking Chair shown in Regatta.

GUESTSTACKER® 4030 SERIES

Support your people with a comfortable chair whenever needed, then quickly clear the room. GuestStacker helps you make the most of valuable floor space by stacking six high on the floor or 28 high on a cart. Each set of four chairs provides ergonomic support to users with a contoured seat and back that are molded to fit the natural curves of your body. When you need to put guests at ease for any length of time, you need GuestStacker chairs.



FEATURES

- Ships four chairs per carton.
- Chairs stack six high on the floor.
- Copolymer resin seat and back shell.
- Integrated lumbar support delivers long-lasting comfort.
- Wall-saver design protects walls and cabinets.
- Tubular steel frame adds durability.
- Optional ganging glides create straight rows.
- Stacks up to 28 high on HON Model 4033 Cart.
- Ships fully assembled.
- Warranted for users up to 300 lbs.



GUESTSTACKER® 4030 Series

H4031



STACKING CHAIRS

Textured Copolymer Seat & Back
Painted Legs — Black (T) ONLY

DIMENSIONS

Depth:	21½	Seat to Floor Height:	17½
Width:	21	Usable Seat Depth:	17½
Height:	31	Ship Weight:	51
Seat Depth:	19	Cube:	12.9
Seat Width:	18	Weight Rating:	300 lbs.
Back Width:	20		
Back Height:	11		

LIST PRICE PER CARTON

\$549
(reference single unit @ \$137.25)

- ⓘ 4030 Series is ordered and shipped four (4) chairs per carton. Pricing shown is per carton. Each set of four (one carton), must have the same shell/frame color combination. Ordering 2 of Model H4031 will result in 2 cartons being shipped, giving you 8 chairs.
- ⚠ Shipped fully assembled — 4 chairs per carton. All GuestStacker® shell colors are CA Technical Bulletin 133 compliant (no upcharge).

H4033

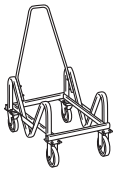

CART FOR STACKING CHAIRS

DIMENSIONS

Depth:	35½	Ship Weight:	40 Ⓢ
Width:	21¾	Cube:	8.9
Height:	37¾		

LIST PRICE

\$460

- NOTES: Holds 28 stack chairs (6'-8"), some assembly required. (Chairs stack 6 high without cart.)
- ⚠ Specify Black paint (T) ONLY.

H4039

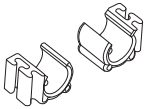

GANGING CHAIR GLIDES

Box of 48

DIMENSIONS

Ship Weight:	1 Ⓢ
Cube:	0.04

LIST PRICE

\$88

HON Recommendation: H4031.LA.T - List Price \$549

HOW TO SPECIFY

<p>Select Model Number</p> <p>H 4 0 3 1 .</p>	<p>Select Shell Color</p> <p>LA Lava MB Mulberry ON Onyx RE Regatta</p> <p>LA .</p>	<p>Select Frame</p> <p>T Black</p> <p>T</p>
---	---	---

IGNITION®



Ignition Seating shown with 10500 Series™ desks.

IGNITION®

People come in all shapes and sizes, which is why Ignition does as well. From guest and lounge chairs to executive seating, Ignition allows you to mix and match adjustment features, back height, lumbar, and other options to fit your chair to your needs. It's the easy, affordable way to furnish an entire workplace in style and comfort. Ignition fits who you are, where you work and how you work.



FEATURES

IGNITION®

- Ignition Series seating addresses the needs of the total office with Executive, Work, Task, Stool, Guest and Lounge Seating Solutions.
- Three different back sizes, three different functions and three arm options to fit you and how you work.
- Back height adjustment moves the back up or down to fit various body sizes (Task chairs & stools).
- Sturdy big and tall design is proportioned to blend in with all other Endorse high-, mid-, and low-back models.
- Contoured back on multi-purpose seating offers greater comfort than typical stack chairs or stools.
- Lounge seating available in two- and three-seat options.
- Warranted for users up to 300 lbs.
(450 lbs. for Big and Tall and 600 lbs. for Three-Seat Lounge)



IGNITION® 2.0

- Adjustable lumbar allows users to tailor their support.
- Passive movement back adjusts with you.
- Three different arm options to accommodate different requirements.
- Available in 5 colors of ilira®-stretch mesh.
- Molded foam seat for better support and added comfort.
- Seat made from molded foam.
- Available in Black and Titanium frame.
- Warranted for users up to 300 lbs.

MODEL OPTIONS

HIEH1



Executive High-Back

Pneumatic, Back Height Adjustment, Swivel, Tilt, Tilt Tension, Tilt Lock

HIEH2



Executive High-Back

Pneumatic, Back Height Adjustment, Synchro-tilt, Tilt Tension, Seat Glide

HIEH3



Executive High-Back

Pneumatic, Back Height Adjustment, Synchro-tilt, Back Angle Adjustment, Tilt Tension, Seat Glide

HIWM8



Work/Task Mid-Back

Big and Tall, Pneumatic, Swivel-tilt, Tilt Tension

HIWM1



Work Mid-Back

Pneumatic, Back Height Adjustment, Swivel, Tilt, Tilt Tension, Tilt Lock

HIWM2



Work Mid-Back

Pneumatic, Back Height Adjustment, Synchro-tilt, Tilt Tension, Tilt Lock, Seat Glide

HIWM3



Work Mid-Back

Pneumatic, Back Height Adjustment, Synchro-tilt, Back Angle Adjustment, Tilt Tension, Tilt Lock, Seat Glide

HITL1



Task Low-Back

Pneumatic, Back Height Adjustment, Swivel, Tilt, Tilt Tension, Tilt Lock

HITL2



Task Low-Back

Pneumatic, Back Height Adjustment, Synchro-tilt, Tilt Tension, Tilt Lock, Seat Glide

HITL3



Task Low-Back

Pneumatic, Back Height Adjustment, Synchro-tilt, Back Angle Adjustment, Tilt Tension, Tilt Lock, Seat Glide

HITS5



Task Stool

Pneumatic, Swivel Back Height Adjustment, Adjustable Footrest

HITLM



Task Low-Back

ilira®-Stretch Mesh Back, Pneumatic, Swivel, Synchro-tilt, Tilt Tension, Tilt Lock, Optional Lumbar Support

HIWMM



Task Mid-Back

ilira®-Stretch Mesh Back, Pneumatic, Swivel, Synchro-tilt, Tilt Tension, Tilt Lock, Optional Lumbar Support

HITSM

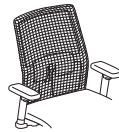

Task Low-Back Stool

ilira®-Stretch Mesh Back, Pneumatic, Swivel, Synchro-tilt, Tilt Tension, Tilt Lock, Optional Lumbar Support

IGNITION® Options

MODEL OPTIONS

HIGCL



Guest Chair

Fixed Arms, Glides

HIL2L

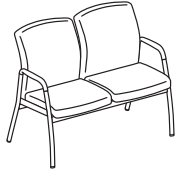

Two-Seat Lounge

Fixed Arms, Glides

HILTl

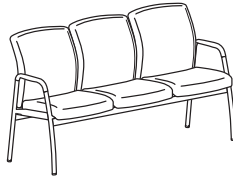

Three-Seat Lounge

Fixed Arms, Glides

HIB50

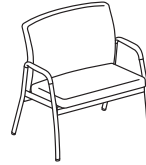

Bariatric Lounge

Fixed Arms, Glides

HIHC



Hip Chair

Fixed Arms, Glides

HIGS6

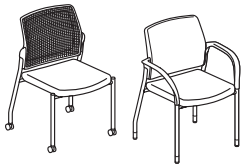

Multi-Purpose

Four Legs

HISB6

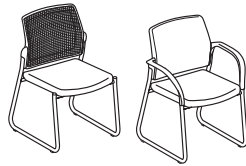

Multi-Purpose

Sled Base

HICS7

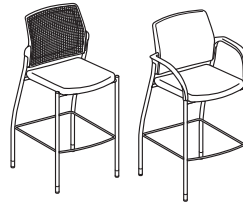





Café-Height Stool



Four Legs

IGNITION® Task Chair Options

ARM STYLE	CODE	DESCRIPTION	PRICE
	N	Armless	+\$0
	F	Fixed Arms	+\$65
	A	Height and Width Adjustable Arms	+\$75
	V	All-Adjustable Arms (includes Pivot)	+\$115
	P	Fixed Polished Aluminum Arms	+\$150

CASTERS	CODE	DESCRIPTION	PRICE
	A	All Surface Caster <i>*Must specify for model HIWM8 only</i>	+\$0
	H	Hard Caster	+\$0
	S	Soft Caster	+\$30

BACK STYLE	CODE	DESCRIPTION	PRICE
	U	Upholstered	+\$0
	M	Mesh	+\$0

BASE	CODE	DESCRIPTION	PRICE
	SB	Standard Base	+\$0
	PA	Polished Aluminum	+\$110

**Only specify base for task chairs*

IGNITION® Fabric Options

AVAILABLE FABRICS

GRADE 1	GRADE 2	GRADE 3	GRADE 4	GRADE 5	GRADE 6	GRADE 7	GRADE 8	GRADE 9	GRADE 10	GRADE 11	GRADE 12	GRADE L
Arrondi *	Appoint	Canter	Bar	Amuse	Intermix II	Ascend	Brisa®	Eli Vinyl	Affinity	Acrobat	Fenestra	Denver
Attire	Seating	Polyurethane	Beeline	Avenue	Keynote	Central	Polyurethane	Martini Vinyl	Concentric	Natural	Helix	Leather
Centurion	Bangle	Epic	Blip	Lariat	Raffia Vinyl	Channel	Kindred	Olympus Vinyl	Juxy	World	Lava	(Matches
Compass	Clyde	Infinity	Coin	Outlander	Velocity	Domain		Silica		Whirl	Ripple	EE Vinyl)
Confetti	Dotty	Knack	Cover Cloth	Polka	Wooly	Synergy		Silica Leather				
Contourette	Esplanade *	Marathon	Current	Riddle		Waver		Silica Tech				
Polyurethane	Expo	Millennium	Decode	Sentry-HC								
Dapper	Fuse	Odyssey	Disc	Sequence								
Inertia	Gio *	Silvertex™	Divide	Solace								
Optic	Moguls	Vinyl	Free	Tribeca								
Stitchery	Origin	Syntax	Habit									
Tectonic	Seed	Tradition	Hive									
	Sockhop	Via	Lineup									
	Spin Seating		Manner									
	Whisper		Medium									
	Vinyl		Messenger									
			Metric									
			Oblique									
			Pick									
			Sprint									
			Technic									

Reference Fabric Color Combinations on pages 18-29 for color codes and legend on page 19 for lead times. Visit hon.com for additional partnership fabrics.

NOTES: Gathers and creases may be more visible with Attire (AI) and Optic (OP) fabrics due to the inherent design and construction of these fabrics. For additional HON to Supply COM fabric grade pricing, go to honready.hon.com and click on the HON to Supply COM link.

🔥 For Fire Code model, availability and ordering method, refer to pages 34-39. Available on select models, contact HON Customer Support for availability.

* Fabric is de-emphasized.



Icon Legend on page 14

HIEH1

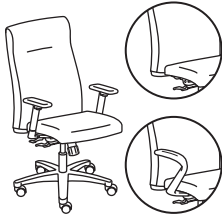

EXECUTIVE HIGH-BACK

- Pneumatic
- Back Height Adjustment
- Swivel
- Tilt
- Tilt Tension
- Tilt Lock

Functions: **A, B, E, F, K, L**
(Function Key on pages 16-17)

NOTES: See page 141 for arm packs.

DIMENSIONS

Depth:	38½	Arm Width:	20
Width:	27	Seat to Floor Height:	16¾-21¼
Height:	47½	Usable Seat Depth:	17⅞
Seat Depth:	18	Ship Weight:	56
Seat Width:	20	Cube:	16.0
Back Width:	20	COM:	2.0
Back Height:	24¾-27¾	Weight Rating:	300 lbs.

FABRIC PRICE CODES

1	\$591	8	\$867
2	\$639	9	\$903
3	\$687	10	\$939
4	\$723	11	\$975
5	\$759	12	\$1011
6	\$795	L	\$891
7	\$831		

HIEH2



EXECUTIVE HIGH-BACK

- Pneumatic
- Back Height Adjustment
- Synchro-tilt
- Tilt Tension
- Seat Glide

Functions: **A, B, D, E, J, A-D, L**
(Function Key on pages 16-17)

NOTES: See page 141 for arm packs.

DIMENSIONS

Depth:	41	Arm Width:	20
Width:	27	Seat to Floor Height:	17-21½
Height:	49	Usable Seat Depth:	16½-18
Seat Depth:	17-19	Ship Weight:	61
Seat Width:	20	Cube:	16.0
Back Width:	19½	COM:	2.0
Back Height:	24¾-27¾	Weight Rating:	300 lbs.

FABRIC PRICE CODES

1	\$656	8	\$932
2	\$704	9	\$968
3	\$752	10	\$1004
4	\$788	11	\$1040
5	\$824	12	\$1076
6	\$860	L	\$956
7	\$896		

HIEH3



EXECUTIVE HIGH-BACK

- Pneumatic
- Back Height Adjustment
- Synchro-tilt
- Back Angle Adjustment
- Tilt Tension
- Seat Glide

Functions: **A, B, D, E, A-D, A-E, L**
(Function Key on pages 16-17)

NOTES: See page 141 for arm packs.

DIMENSIONS

Depth:	45½	Arm Width:	20
Width:	27	Seat to Floor Height:	17-21½
Height:	49	Usable Seat Depth:	15¼-17¼
Seat Depth:	17-19	Ship Weight:	65
Seat Width:	20	Cube:	16.0
Back Width:	19½	COM:	2.0
Back Height:	24¾-27¾	Weight Rating:	300 lbs.

FABRIC PRICE CODES

1	\$696	8	\$972
2	\$744	9	\$1008
3	\$792	10	\$1044
4	\$828	11	\$1080
5	\$864	12	\$1116
6	\$900	L	\$996
7	\$936		

HON Recommendation: HIEH1.F.H.U.CU__T.SB - List Price \$656

HOW TO SPECIFY

Select Model Number	Select Arm Type	Select Caster/Glide	Select Back Type	Select Fabric	Select Frame	Select Base
	<ul style="list-style-type: none"> N Armless F Fixed Arms - Black (+ \$65) A Height and Width Adjustable Arms (+ \$75) V All-Adjustable Arms (includes Pivot) (+ \$115) P Fixed Arms - Polished (+ \$150) 	<ul style="list-style-type: none"> H Hard Caster S Soft Caster (+ \$30) 	<ul style="list-style-type: none"> U Upholstered 	See page 136	<ul style="list-style-type: none"> T Black 	<ul style="list-style-type: none"> SB Standard Base PA Polished Aluminum (+ \$110)
H I E H 1	F	H	U	C U 1 0	T	S B

IGNITION®

Icon Legend on page 14

HIWM1**WORK MID-BACK**

Pneumatic
Back Height Adjustment
Swivel
Tilt
Tilt Tension
Tilt Lock

Functions: **A, B, E, F, K, L**
(Function Key on pages 16-17)

DIMENSIONS

Upholstered Back Width:	18½	Seat to Floor Height:	17-21½
Upholstered Back Height:	21-24	Usable Seat Depth:	17½
Mesh Back Width:	19	Ship Weight (upholstered back):	54 Ⓢ
Mesh Back Height:	21½-24	Ship Weight (mesh back):	48 Ⓢ
Depth:	35½	Cube (upholstered back):	11.3
Width:	27	Cube (mesh back):	11.3
Height:	44	COM (upholstered back):	2.0
Seat Depth:	18	COM (mesh back):	1.0
Seat Width:	20	Weight Rating:	300 lbs.
Adjustable Arms Width:	17-19½		
Fixed Arms Width:	20		

FABRIC PRICE CODES

1	\$568	8	\$844
2	\$616	9	\$880
3	\$664	10	\$916
4	\$700	11	\$952
5	\$736	12	\$988
6	\$772	L	\$868
7	\$808		

NOTES: See page 141 for arm packs.

HIWM2**WORK MID-BACK**

Pneumatic
Back Height Adjustment
Synchro-tilt
Tilt Tension
Tilt Lock
Seat Glide

Functions:
A, B, D, E, J, A-D, L
(Function Key on pages 16-17)

DIMENSIONS

Upholstered Back Width:	18½	Seat to Floor Height:	17¼-21¾
Upholstered Back Height:	21-24	Usable Seat Depth:	16¼-18¼
Mesh Back Width:	19	Ship Weight (upholstered back):	58 Ⓢ
Mesh Back Height:	21½-24	Ship Weight (mesh back):	52 Ⓢ
Depth:	38	Cube (upholstered back):	11.3
Width:	27	Cube (mesh back):	11.3
Height:	46½	COM (upholstered back):	2.0
Seat Depth:	17-19	COM (mesh back):	1.0
Seat Width:	20	Weight Rating:	300 lbs.
Adjustable Arms Width:	17-19½		
Fixed Arms Width:	20		

FABRIC PRICE CODES

1	\$633	8	\$909
2	\$681	9	\$945
3	\$729	10	\$981
4	\$765	11	\$1017
5	\$801	12	\$1053
6	\$837	L	\$933
7	\$873		

NOTES: See page 141 for arm packs.

HIWM3**WORK MID-BACK**

Pneumatic
Back Height Adjustment
Synchro-tilt
Back Angle Adjustment
Tilt Tension
Tilt Lock
Seat Glide

Functions:
A, B, D, E, A-D, A-E, L
(Function Key on pages 16-17)

DIMENSIONS

Upholstered Back Width:	18½	Seat to Floor Height:	17¼-21¾
Upholstered Back Height:	21-24	Usable Seat Depth:	15¼-17¼
Mesh Back Width:	19	Ship Weight (upholstered back):	63 Ⓢ
Mesh Back Height:	21½-24	Ship Weight (mesh back):	58 Ⓢ
Depth:	39	Cube (upholstered back):	11.3
Width:	27	Cube (mesh back):	11.3
Height:	44	COM (upholstered back):	2.0
Seat Depth:	17-19	COM (mesh back):	1.0
Seat Width:	20	Weight Rating:	300 lbs.
Adjustable Arms Width:	17-19½		
Fixed Arms Width:	20		

FABRIC PRICE CODES

1	\$673	8	\$949
2	\$721	9	\$985
3	\$769	10	\$1021
4	\$805	11	\$1057
5	\$841	12	\$1093
6	\$877	L	\$973
7	\$913		

NOTES: See page 141 for arm packs.

HON Recommendation: HIWM2.A.H.M.CU__T.SB - List Price \$708**HOW TO SPECIFY**

Select Model Number	Select Arm Type	Select Caster/Glide	Select Back Type	Select Fabric	Select Frame	Select Base
N Armless F Fixed Arms - Black (+ \$65) A Height and Width Adjustable Arms (+ \$75) V All-Adjustable Arms (includes Pivot) (+ \$115) P Fixed Arms - Polished (+ \$150)	H Hard Caster S Soft Caster (+ \$30)	U Upholstered M Mesh	See page 136	T Black	SB Standard Base PA Polished Aluminum (+ \$110)	
HIWM1	A	H	M	CU10	T	SB



HITL1



TASK LOW-BACK

- Pneumatic
- Back Height Adjustment
- Swivel
- Tilt
- Tilt Tension
- Tilt Lock

Functions: **A, B, E, F, K, L**
(Function Key on pages 16-17)

DIMENSIONS

- Upholstered Back
- Width: 17½
- Upholstered Back
- Height: 18¾-21¾
- Mesh Back Width: 17½
- Mesh Back Height: 20¾-23¼
- Depth: 36
- Width: 27½
- Height: 41
- Seat Depth: 17
- Seat Width: 19

- Adjustable Arms Width: 17-19½
- Fixed Arms Width: 20
- Seat to Floor Height: 17-21½
- Usable Seat Depth: 15¾
- Ship Weight (upholstered back): 50 **Ⓢ**
- Ship Weight (mesh back): 45 **Ⓢ**
- Cube (upholstered back): 11.1
- Cube (mesh back): 11.1
- COM (upholstered back): 2.0
- COM (mesh back): 1.0
- Weight Rating: 300 lbs.

FABRIC PRICE CODES

1	\$520	8	\$796
2	\$568	9	\$832
3	\$616	10	\$868
4	\$652	11	\$904
5	\$688	12	\$940
6	\$724	L	\$820
7	\$760		

NOTES: See page 141 for arm packs.

HITL2



TASK LOW-BACK

- Pneumatic
- Back Height Adjustment
- Synchro-tilt
- Tilt Tension
- Tilt Lock
- Seat Glide

Functions: **A, B, D, E, J, A-D, L**
(Function Key on pages 16-17)

DIMENSIONS

- Upholstered Back
- Width: 17½
- Upholstered Back
- Height: 19½-22½
- Mesh Back Width: 17½
- Mesh Back Height: 20¾-23¼
- Depth: 38½
- Width: 27½
- Height: 43
- Seat Depth: 16-18
- Seat Width: 19

- Adjustable Arms Width: 17-19½
- Fixed Arms Width: 20
- Seat to Floor Height: 17-21½
- Usable Seat Depth: 15½-17½
- Ship Weight (upholstered back): 54 **Ⓢ**
- Ship Weight (mesh back): 49 **Ⓢ**
- Cube (upholstered back): 11.1
- Cube (mesh back): 11.1
- COM (upholstered back): 2.0
- COM (mesh back): 1.0
- Weight Rating: 300 lbs.

FABRIC PRICE CODES

1	\$585	8	\$861
2	\$633	9	\$897
3	\$681	10	\$933
4	\$717	11	\$969
5	\$753	12	\$1005
6	\$789	L	\$885
7	\$825		

NOTES: See page 141 for arm packs.

HITL3



TASK LOW-BACK

- Pneumatic
- Back Height Adjustment
- Synchro-tilt
- Back Angle Adjustment
- Tilt Tension
- Tilt Lock
- Seat Glide

Functions: **A, B, D, E, A-D, A-E, L**
(Function Key on pages 16-17)

DIMENSIONS

- Upholstered Back
- Width: 17½
- Upholstered Back
- Height: 20¾-23¾
- Mesh Back Width: 17½
- Mesh Back Height: 20¾-23¼
- Depth: 39
- Width: 27
- Height: 44
- Seat Depth: 16-18
- Seat Width: 19

- Adjustable Arms Width: 17-19½
- Fixed Arms Width: 20
- Seat to Floor Height: 17-21½
- Usable Seat Depth: 14½-16½
- Ship Weight (upholstered back): 58 **Ⓢ**
- Ship Weight (mesh back): 53 **Ⓢ**
- Cube (upholstered back): 11.1
- Cube (mesh back): 11.1
- COM (upholstered back): 2.0
- COM (mesh back): 1.0
- Weight Rating: 300 lbs.

FABRIC PRICE CODES

1	\$625	8	\$901
2	\$673	9	\$937
3	\$721	10	\$973
4	\$757	11	\$1009
5	\$793	12	\$1045
6	\$829	L	\$925
7	\$865		

NOTES: See page 141 for arm packs.

HON Recommendation: HITL1.A.H.M.CU__T.SB - List Price \$595

HOW TO SPECIFY

<p>Select Model Number</p> <p>HITL1</p>	<p>Select Arm Type</p> <p>N Armless F Fixed Arms - Black (+ \$65) A Height and Width Adjustable Arms (+ \$75) V All-Adjustable Arms (includes Pivot) (+ \$115) P Fixed Arms - Polished (+ \$150)</p> <p>A</p>	<p>Select Caster/Glide</p> <p>H Hard Caster S Soft Caster (+ \$30)</p> <p>H</p>	<p>Select Back Type</p> <p>U Upholstered M Mesh</p> <p>M</p>	<p>Select Fabric</p> <p>See page 136</p> <p>CU10</p>	<p>Select Frame</p> <p>T Black</p> <p>T</p>	<p>Select Base</p> <p>SB Standard Base PA Polished Aluminum (+ \$110)</p> <p>SB</p>
--	---	--	---	---	---	--

IGNITION®

Icon Legend on page 14

HITS5**TASK STOOL**

Pneumatic
Swivel Back Height
Adjustment
Adjustable Footrest
Functions: **A, B, E**
(Function Key on pages
16-17)

DIMENSIONS

Upholstered Back
Width: 17½
Upholstered Back
Height: 18¾-21¾
Mesh Back Width: 17½
Mesh Back Height: 20¾-23¾
Depth: 27½
Width: 27
Height: 44
Seat Depth: 17
Seat Width: 19

Adjustable Arms Width: 17-19½
Fixed Arms Width: 20
Seat to Floor Height: 23⅝-33⅝
Usable Seat Depth: 15¾
Ship Weight (upholstered back): 56 **Ⓞ**
Ship Weight (mesh back): 51 **Ⓞ**
Cube (upholstered back): 11.3
Cube (mesh back): 11.3
COM (upholstered back): 2.0
COM (mesh back): 1.0
Weight Rating: 300 lbs.

FABRIC PRICE CODES

1	\$613	8	\$889
2	\$661	9	\$925
3	\$709	10	\$961
4	\$745	11	\$997
5	\$781	12	\$1033
6	\$817	L	\$913
7	\$853		

NOTES: See page 141 for arm packs.

HIWM8**WORK/TASK MID-BACK**

Big and Tall
Pneumatic
Swivel-tilt
Tilt Tension
Functions: **A, E, F, K, L**
(Function Key on pages
16-17)

DIMENSIONS

Depth: 28
Width: 32¼
Height: 43⅞
Seat Depth: 19½
Seat Width: 23½
Back Width: 23½
Back Height: 23

Arm Width: 23-25½
Seat to Floor Height: 17½-20⅝
Usable Seat Depth: 19½
Ship Weight: 60
Cube: 16.0
COM: 3.0
Weight Rating: 450 lbs.

FABRIC PRICE CODES

1	\$1131	8	\$1545
2	\$1203	9	\$1599
3	\$1275	10	\$1653
4	\$1329	11	\$1707
5	\$1383	12	\$1761
6	\$1437	L	\$1731
7	\$1491		

NOTES: See page 141 for arm packs.

HON Recommendation: HITS5.A.H.M.CU__T.SB - List Price \$688**HOW TO SPECIFY**

Select Model Number	Select Arm Type	Select Caster/Glide	Select Back Type	Select Fabric	Select Frame	Select Base
N Armless F Fixed Arms - Black (+ \$65) A Height and Width Adjustable Arms (+ \$75) V All-Adjustable Arms (includes Pivot) (+ \$115) P Fixed Arms - Polished (+ \$150)	H Hard Caster S Soft Caster (+ \$30) A All Surface Caster (available on model HIWM8 only) <i>H and S caster options not available on model HIWM8</i>	U Upholstered M Mesh	See page 136	T Black	SB Standard Base	
H I T S 5 . A .	H .	M .	C U 1 0 .	T .	S B	

HIATA

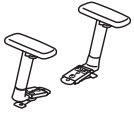

ADJUSTABLE ARMS

Height and Width
Functions: **S**
(Function Key on pages 16-17)

DIMENSIONS

Adjustable Arms Width: 17-19½
Height from Seat: 8-11
Ship Weight: 8 **Ⓢ**
Cube: 1.0

LIST PRICE

\$114

HIAAA

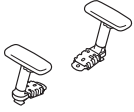

ALL ADJUSTABLE ARMS

Height, Width, Depth and Pivot

DIMENSIONS

Adjustable Arms Width: 17-20
Height from Seat: 7-11
Ship Weight: 8 **Ⓢ**
Cube: 1.0

LIST PRICE

\$154

HIFHA



FIXED HEIGHT ARMS

DIMENSIONS

Arm Width: 20
Height from Seat: 9½
Ship Weight: 7 **Ⓢ**
Cube: 1.0

LIST PRICE

\$104

HIPAA

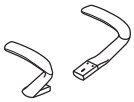

POLISHED ALUMINUM ARMS

Fixed Height

DIMENSIONS

Arm Width: 20
Height from Seat: 9½
Ship Weight: 10 **Ⓢ**
Cube: 1.0

LIST PRICE

\$180

HOW TO SPECIFY

Select Model Number

HIATA

Select Color



T Black
Color option not available on HIPAA



T

IGNITION® 2.0

Options

ARM STYLE	CODE	DESCRIPTION	PRICE
	N	Armless	+\$0
	F	Fixed Arms	+\$65
	A	Height and Width Adjustable Arms	+\$75
	V	All-Adjustable Arms (includes Pivot)	+\$115
	P	Fixed Polished Aluminum Arms	+\$150

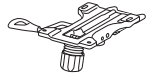
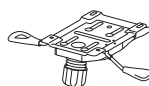
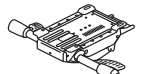
CASTERS	CODE	DESCRIPTION	PRICE
	H	Hard Caster	+\$0
	S	Soft Caster	+\$30
	R	Roll Control Caster	+\$50

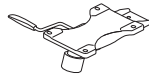
MECHANISM	CODE	DESCRIPTION	PRICE
	Y0	Synchro-Tilt	+\$0
	Y1	Synchro-Tilt w/Seat Slider	+\$20
	Y2	Advanced Synchro-Tilt	+\$65
	Y3	Synchro-Tilt with Independent Back Angle	+\$105
	S1	Limited Synchro-Tilt	+\$0

**Only available on HITSM*

LUMBAR	CODE	DESCRIPTION	PRICE
	NL	No Lumbar	+\$0
	AL	Adjustable Lumbar	+\$30

BACK STYLE	CODE	DESCRIPTION	PRICE
<i>ilira®-stretch mesh back options:</i>			
	IM	Black	+\$0
	IF	Fog	+\$0
	IC	Charcoal	+\$0
	IH	Chai	+\$0
	IY	Navy	+\$0

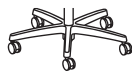
BASE	CODE	DESCRIPTION	PRICE
	SB	Standard Base	+\$0
	PA	Polished Aluminum	+\$110

**Only specify base for task chairs*

FRAME	CODE	DESCRIPTION	PRICE
	T	Black Frame	+\$0
	TI	Titanium Frame	+\$35

IGNITION® 2.0

Dimensions

TASK DIMENSIONS

MODEL		HIWMM	HITLM	HITSM	HITLMKD	HIWMMKD
Overall Width Armless		21	20	20	20	21
Overall Width with Arms	A	27	26	26	26	27
Overall Depth		24	22	22	22	24
Overall Height	S1	-	-	52½	-	-
	Y0/Y1	43¾	40½	-	40½	43¾
	Y2	44½	41¼	-	-	-
	Y3	44½	41¼	-	-	-
	W5	45¼	41½	-	-	-
Seat Width		20	18½	18½	18½	20
Seat Depth (cushion)		2½	2½	2½	2½	2½
Usable Seat Depth	S1	-	-	16	-	-
	Y0	17¾	16	-	16	17¾
	Y1	17½-19½	15½-17½	-	15½-17½	17½-19½
	Y2	16¼-19¼	15¾-18½	-	-	-
	Y3	16½-19½	16¼-18¾	-	-	-
	W5	17½-20	16⅝-18¾	-	-	-
Seat Height	S1	-	-	22⅞-31¾	-	-
	Y0/Y1	16⅝-21¼	16¾-21¼	-	16¾-21¼	16⅝-21¼
	Y2	17⅞-21½	17⅞-21½	-	-	-
	Y3	17½-21½	17¾-21¾	-	-	-
	W5	16¾-21⅞	16¾-21½	-	-	-
Back Width		19	17½	17½	17½	19
Back Height		29	25½	25½	25½	29
Ship Weight Armless	S1	-	-	44	-	-
	Y0	38	38	-	38	38
	Y1	38	38	-	38	38
	Y2	42	42	-	-	-
	Y3	46	45	-	-	-
	W5	45	44	-	-	-
Ship Weight with Arms	S1	-	-	51	-	-
	Y0	45	45	-	45	45
	Y1	45	45	-	45	45
	Y2	49	49	-	-	-
	Y3	53	52	-	-	-
	W5	52	51	-	-	-
Width Between Arms	F	20¼	19	19	19	20¼
	P	20¼	19	19	19	20¼
	A	24⅝-27¼	18½-20½	18½-20⅝	18½-20½	24⅝-27¼
	V	12½-27½	11½-26½	11½-26⅝	11½-26½	12½-27½
Cube		11.1	11.1	11.1	6.3	5.6
COM		1.0	1.0	1.0	1.0	1.0
Weight Capacity		300 lbs	300 lbs	300 lbs	300 lbs	300 lbs

IGNITION® 2.0



HITLM

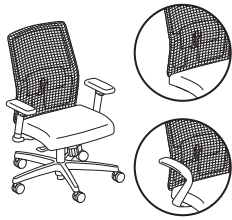

TASK LOW-BACK

- ilira®-Stretch Mesh Back**
- Pneumatic
- Swivel
- Synchro-tilt
- Tilt Tension
- Tilt Lock
- Optional Lumbar Support

DIMENSIONS

Depth:	22	Seat to Floor Height:	16¾-21¼
Height:	40½	Usable Seat Depth:	16
Seat Depth:	16	Ship Weight (with arms):	45
Seat Width:	18½	Ship Weight (armless):	38
Back Width:	17½	Cube:	11.1
Back Height:	25½	COM:	1.0
Width (with arms):	26	Weight Rating:	300 lbs.
Width (armless):	20		
Arm Width:	11½-26½		

FABRIC PRICE CODES

1	\$452	8	\$590
2	\$476	9	\$608
3	\$500	10	\$626
4	\$518	11	\$644
5	\$536	12	\$662
6	\$554	L	\$652
7	\$572		

! Dimensions, weights and cubes shown above are for models using the Ignition® Y0 control only. See page 143 for all other control specifications.

HIWMM

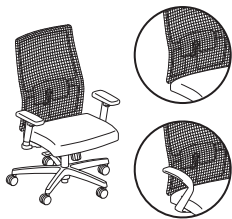

TASK MID-BACK

- ilira®-Stretch Mesh Back**
- Pneumatic
- Swivel
- Synchro-tilt
- Tilt Tension
- Tilt Lock
- Optional Lumbar Support

DIMENSIONS

Depth:	24	Seat to Floor Height:	16¾-21¼
Height:	43¾	Usable Seat Depth:	17¾
Seat Depth:	17¾	Ship Weight (with arms):	45
Seat Width:	20	Ship Weight (armless):	38
Back Width:	19	Cube:	11.1
Back Height:	29	COM:	1.0
Width (with arms):	27	Weight Rating:	300 lbs.
Width (armless):	21		
Arm Width:	12½-27½		

FABRIC PRICE CODES

1	\$494	8	\$632
2	\$518	9	\$650
3	\$542	10	\$668
4	\$560	11	\$686
5	\$578	12	\$704
6	\$596	L	\$694
7	\$614		

! Dimensions, weights and cubes shown above are for models using the Ignition® Y0 control only. See page 143 for all other control specifications.

HITSM



TASK LOW-BACK STOOL

- ilira®-Stretch Mesh Back**
- Pneumatic
- Swivel
- Synchro-tilt
- Tilt Tension
- Tilt Lock
- Optional Lumbar Support

DIMENSIONS

Depth:	22	Seat to Floor Height:	22⅞-31¾
Height:	52½	Usable Seat Depth:	16
Seat Depth:	16	Ship Weight (with arms):	51
Seat Width:	18½	Ship Weight (armless):	44
Back Width:	17½	Cube:	11.1
Back Height:	25½	COM:	1.0
Width (with arms):	26	Weight Rating:	300 lbs.
Width (armless):	20		
Arm Width:	11½-26¾		

FABRIC PRICE CODES

1	\$541	8	\$679
2	\$565	9	\$697
3	\$589	10	\$715
4	\$607	11	\$733
5	\$625	12	\$751
6	\$643	L	\$741
7	\$661		

! Dimensions, weights and cubes shown above are for models using the Ignition® S1 control only. See page 143 for all other control specifications.

HON Recommendation: HIWMM.Y2.A.H.IM.CU__AL.SB.T - List Price \$664

HOW TO SPECIFY

Select Model Number	Select Control Type	Select Arm Type	Select Caster	Select Mesh	Select Fabric	Select Lumbar	Select Base	Select Frame
Y0 Synchro-Tilt	N Armless	H Hard Caster	IM Black	See page 136	NL No Lumbar	SB Standard Base	T Black	
Y1 Synchro-Tilt w/ Seat Slider (+ \$20)	A Height and Width Adjustable Arms (+ \$75)	S Soft Caster (+ \$30)	IF Fog					AL Adjustable Lumbar (+ \$30)
Y2 Advanced Synchro-Tilt (+ \$65)	V All-Adjustable Arms (includes pivot) (+ \$115)	R Roll Control Caster (+ \$50)	IC Charcoal					
Y3 Synchro-Tilt with Independent Back Angle (+ \$105)	F Fixed Arms (+ \$65)		IH Chai					
S1 Limited Synchro-Tilt (for HITSM only)	P Fixed Arms - Polished (+ \$150)		IY Navy					
<i>Specify S1 for HITSM model ONLY</i>								
H I T L M .	Y 2 .	A .	H .	I M .	C U 1 0 .	A L .	S B .	T



Icon Legend on page 14

IGNITION® 2.0

HITLMKD

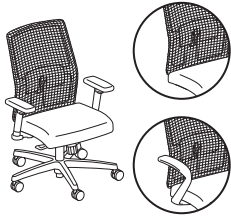

TASK LOW-BACK

- ilira®-Stretch Mesh Back
- Pneumatic
- Swivel
- Synchro-tilt
- Tilt Tension
- Tilt Lock
- Optional Lumbar Support

DIMENSIONS

Depth:	22	Seat to Floor Height:	16 ³ / ₄ -21 ¹ / ₄
Height:	40 ¹ / ₂	Usable Seat Depth:	16
Seat Depth:	16	Ship Weight (with arms):	45
Seat Width:	18 ¹ / ₂	Ship Weight (armless):	38
Back Width:	17 ¹ / ₂	Cube:	6.3
Back Height:	25 ¹ / ₂	COM:	1.0
Width (with arms):	26	Weight Rating:	300 lbs.
Width (armless):	20		
Arm Width:	11 ¹ / ₂ -26 ¹ / ₂		

FABRIC PRICE CODES

1	\$412
2	\$436
3	\$460

! Dimensions, weights and cubes shown above are for models using the Ignition® Y0 control only. See page 143 for all other control specifications.

HIWMMKD

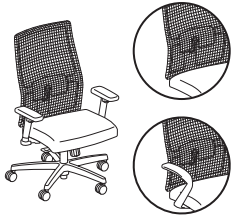

TASK MID-BACK

- ilira®-Stretch Mesh Back
- Pneumatic
- Swivel
- Synchro-tilt
- Tilt Tension
- Tilt Lock
- Optional Lumbar Support

DIMENSIONS

Depth:	24	Seat to Floor Height:	16 ³ / ₈ -21 ¹ / ₄
Height:	43 ³ / ₄	Usable Seat Depth:	17 ³ / ₄
Seat Depth:	17 ³ / ₄	Ship Weight (with arms):	45
Seat Width:	20	Ship Weight (armless):	38
Back Width:	19	Cube:	5.6
Back Height:	29	COM:	1.0
Width (with arms):	27	Weight Rating:	300 lbs.
Width (armless):	21		
Arm Width:	12 ¹ / ₂ -27 ¹ / ₂		

FABRIC PRICE CODES

1	\$454
2	\$478
3	\$502

! Dimensions, weights and cubes shown above are for models using the Ignition® Y0 control only. See page 143 for all other control specifications.

HON Recommendation: HIWMMKD.Y2.A.H.IM.CU__AL.SB.T - List Price \$624

HOW TO SPECIFY

Select Model Number	Select Control Type	Select Arm Type	Select Caster	Select Mesh	Select Fabric	Select Lumbar	Select Base	Select Frame
	Y1 Synchro-Tilt w/ Seat Slider (+ \$20) Y2 Advanced Synchro-Tilt (+ \$65)	A Height and Width Adjustable Arms (+ \$75)	H Hard Caster	IM Black IF Fog IC Charcoal	See page 136	NL No Lumbar AL Adjustable Lumbar (+ \$30)	SB Standard Base	T Black
H I W M M K D .	Y 2 .	A .	H .	I M .	C U 1 0 .	A L .	S B .	T

IGNITION® 2.0 Accessories

NOT ON GSA CONTRACT



Icon Legend on page 14

HI2ATA



ADJUSTABLE ARMS

Height and Width
Functions: **S**
(Function Key on pages 16-17)

DIMENSIONS

Adjustable Arms Width: 17-19½
Height from Seat: 8-11
Ship Weight: 8 **Ⓢ**
Cube: 1.0

LIST PRICE

\$114

HI2AAA

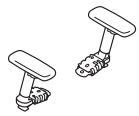

ALL ADJUSTABLE ARMS

Height, Width, Depth and Pivot

DIMENSIONS

Adjustable Arms Width: 17-20
Height from Seat: 7-11
Ship Weight: 8 **Ⓢ**
Cube: 1.0

LIST PRICE

\$154

HI2FHA



FIXED HEIGHT ARMS

DIMENSIONS

Arm Width: 20
Height from Seat: 9½
Ship Weight: 7 **Ⓢ**
Cube: 1.0

LIST PRICE

\$104

HILMBR

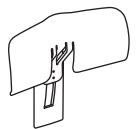

LUMBAR SUPPORT

DIMENSIONS

Ship Weight: 8 **Ⓢ**
Cube: 1

LIST PRICE

\$30

HOW TO SPECIFY

Select
Model Number





Select
Frame

T Black
TI Titanium

HI2ATA.T

IGNITION®

Guest Chair Options

ARM STYLE				BACK STYLE			
	CODE	DESCRIPTION	PRICE		CODE	DESCRIPTION	PRICE
	N	Armless	+\$0		U	Upholstered	+\$0
	F	Fixed Arms	+\$30		IM	Black	+\$0
					IF	Fog	+\$0
					IC	Charcoal	+\$0
					IH	Chai	+\$0
					IY	Navy	+\$0
CASTERS/ GLIDE				FRAME			
	CODE	DESCRIPTION	PRICE		CODE	DESCRIPTION	PRICE
	H	Hard Caster	+\$0		T	Black	+\$0
	S	Soft Caster	+\$20		BLCK	Textured Black	+\$0
	E	Glide	+\$0		PLAT	Textured Platinum Metallic	+\$0
		<i>Casters only available on HIGS6</i>			PR8T	Textured Titanium	+\$35
						<i>By selecting PR8T, unit will be produced with titanium colored arm caps, back frame & glides</i>	

**HIGCL****GUEST CHAIR**

Fixed Arms
Glides

DIMENSIONS

Depth:	24	Arm Width:	19¼
Width:	23	Seat to Floor Height:	18½
Height:	35½	Usable Seat Depth:	16¾
Seat Depth:	18	Ship Weight:	42
Seat Width:	19½	Cube:	15.2
Back Width:	19½	COM:	2.0
Back Height:	20	Weight Rating:	300 lbs.

FABRIC PRICE CODES

1	\$406	8	\$682
2	\$454	9	\$718
3	\$502	10	\$754
4	\$538	11	\$790
5	\$574	12	\$826
6	\$610	L	\$706
7	\$646		

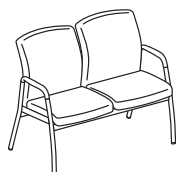
HIL2L**TWO-SEAT LOUNGE**

Fixed Arms
Glides

DIMENSIONS

Depth:	24½	Arm Width:	40
Width:	42¾	Seat to Floor Height:	18½
Height:	34½	Usable Seat Depth:	16¾
Each Seat Depth:	16¾	Ship Weight:	96
Each Seat Width:	19½	Cube:	37.1
Each Back Width:	19½	COM:	3.5
Each Back Height:	19	Weight Rating:	300 lbs. (per seat)

FABRIC PRICE CODES

1	\$1199	8	\$1682
2	\$1283	9	\$1745
3	\$1367	10	\$1808
4	\$1430	11	\$1871
5	\$1493	12	\$1934
6	\$1556	L	\$1899
7	\$1619		

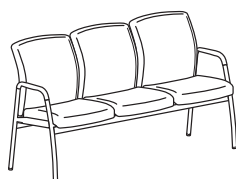
HILT**THREE-SEAT LOUNGE**

Fixed Arms
Glides

DIMENSIONS

Depth:	24½	Arm Width:	60¼
Width:	64	Seat to Floor Height:	18½
Height:	34½	Usable Seat Depth:	16¾
Each Seat Depth:	18	Ship Weight:	128
Each Seat Width:	19½	Cube:	37.1
Each Back Width:	19½	COM:	5.0
Each Back Height:	19	Weight Rating:	300 lbs. (per seat)

FABRIC PRICE CODES

1	\$1507	8	\$2197
2	\$1627	9	\$2287
3	\$1747	10	\$2377
4	\$1837	11	\$2467
5	\$1927	12	\$2557
6	\$2017	L	\$2507
7	\$2107		

HON Recommendation: HIGCL.F.E.U.CU__T - List Price \$406

HOW TO SPECIFY

Select Model Number	Select Arm Type	Select Glide	Select Back Type	Select Fabric	Select Frame
	F Fixed Arms	E Glide	U Upholstered	See page 136	T Black BLCK Textured Black PLAT Textured Platinum Metallic
HIGCL.	F.	E.	U.	CU10.	T



Icon Legend on page 14

HIB50

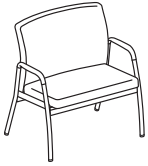

BARIATRIC LOUNGE

Fixed Arms
Glides

DIMENSIONS

Depth:	25½	Arm Width:	30
Width:	33¾	Seat to Floor Height:	20
Height:	35¾	Usable Seat Depth:	18¾
Seat Depth:	18¾	Ship Weight:	70
Seat Width:	29¾	Cube:	27.5
Back Width:	29	COM:	2.5
Back Height:	19¼	Weight Rating:	500 lbs.

FABRIC PRICE CODES

1	\$1142	8	\$1487
2	\$1202	9	\$1532
3	\$1262	10	\$1577
4	\$1307	11	\$1622
5	\$1352	12	\$1667
6	\$1397	L	\$1642
7	\$1442		

HIHC



HIP CHAIR

Fixed Arms
Glides

DIMENSIONS

Depth:	23	Arm Width:	21½
Width:	24¾	Seat to Floor Height:	24¾
Height:	41⅝	Usable Seat Depth:	16½
Seat Depth:	16½	Ship Weight:	37
Seat Width:	18¾	Cube:	19.1
Back Width:	18¼	COM:	1.5
Back Height:	17⅝	Weight Rating:	300 lbs.

FABRIC PRICE CODES

1	\$549	8	\$756
2	\$585	9	\$783
3	\$621	10	\$810
4	\$648	11	\$837
5	\$675	12	\$864
6	\$702	L	\$849
7	\$729		

HOW TO SPECIFY

Select Model Number	Select Arm Type	Select Glide	Select Back Type	Select Fabric	Select Frame
	F Fixed Arms <i>Specify for models HIB50 and HIHC only</i>	E Glide	U Upholstered	See page 136	T Black BLCK Textured Black PLAT Textured Platinum Metallic
HIB50	F	E	U	CU10	T

IGNITION®

Icon Legend on page 14

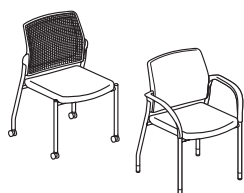
HIGS6**MULTI-PURPOSE**

Four Legs

DIMENSIONS

Depth:	21 ³ / ₄	Seat to Floor Height:	18 ³ / ₈
Width:	25	Usable Seat Depth:	17 ³ / ₈
Height:	33 ¹ / ₂	Ship Weight (upholstered back):	28
Seat Depth:	17 ³ / ₈	Ship Weight (mesh back):	28
Seat Width:	18 ³ / ₄	Cube (upholstered back):	15.1
Back Width:	18 ¹ / ₄	Cube (mesh back):	15.1
Back Height:	18 ¹ / ₈	COM (upholstered back):	1.5
Arm Width:	21 ¹ / ₂	COM (mesh back):	1.0
		Weight Rating:	300 lbs.

FABRIC PRICE CODES

1	\$392	8	\$599
2	\$428	9	\$626
3	\$464	10	\$653
4	\$491	11	\$680
5	\$518	12	\$707
6	\$545	L	\$692
7	\$572		

! Ganging brackets work with armless Guest/Multi-purpose models only.

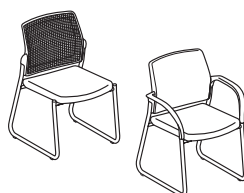
HISB6**MULTI-PURPOSE**

Sled Base

DIMENSIONS

Depth:	23 ³ / ₄	Seat to Floor Height:	18 ³ / ₈
Width:	25	Usable Seat Depth:	17 ³ / ₈
Height:	33 ¹ / ₂	Ship Weight (upholstered back):	30
Seat Depth:	17 ³ / ₈	Ship Weight (mesh back):	30
Seat Width:	18 ³ / ₄	Cube (upholstered back):	15.1
Back Width:	18 ¹ / ₄	Cube (mesh back):	15.1
Back Height:	18 ¹ / ₈	COM (upholstered back):	1.5
Arm Width:	21 ¹ / ₂	COM (mesh back):	1.0
		Weight Rating:	300 lbs.

FABRIC PRICE CODES

1	\$392	8	\$599
2	\$428	9	\$626
3	\$464	10	\$653
4	\$491	11	\$680
5	\$518	12	\$707
6	\$545	L	\$692
7	\$572		

! Ganging brackets work with armless Guest/Multi-purpose models only.

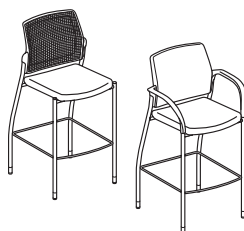
HICS7**CAFÉ-HEIGHT STOOL**

Four Legs

DIMENSIONS

Depth:	23	Seat to Floor Height:	31
Width:	25	Usable Seat Depth:	17 ³ / ₈
Height:	46 ¹ / ₂	Ship Weight (upholstered back):	37
Seat Depth:	17 ³ / ₈	Ship Weight (mesh back):	37
Seat Width:	18 ³ / ₄	Cube (upholstered back):	21.8
Back Width:	18 ¹ / ₄	Cube (mesh back):	21.8
Back Height:	18 ¹ / ₈	COM (upholstered back):	1.5
Arm Width:	21 ¹ / ₂	COM (mesh back):	1.0
		Weight Rating:	300 lbs.

FABRIC PRICE CODES

1	\$496	8	\$703
2	\$532	9	\$730
3	\$568	10	\$757
4	\$595	11	\$784
5	\$622	12	\$811
6	\$649	L	\$796
7	\$676		

! Ganging brackets work with armless Guest/Multi-purpose models only.

HIGB1**GANGING BRACKET**

- For Armless Guest Chairs
- 24 per package

DIMENSIONS

Ship Weight:	1 Ⓞ
Cube:	0.1

LIST PRICE**\$75**

HON Recommendation: HIGS6.F.H.IM.CU__T - List Price \$422

HOW TO SPECIFY

Select Model Number	Select Arm Type	Select Glide	Select Back Type	Select Fabric	Select Frame
	F Fixed Arms (+ \$30) N Armless	E Glide H Hard Caster S Soft Caster (+ \$20) <i>Casters available on HIGS6 only</i>	U Upholstered IM Black IF Fog IC Charcoal IH Chai IY Navy	See page 136	T Black BLCK Textured Black PLAT Textured Platinum Metallic PR8T Textured Titanium (+ \$35)
H I G S 6 .	F .	H .	I M .	C U 1 0 .	T

INVITATION® 2110 SERIES



Invitation Guest Chairs
and Table Connectors.

INVITATION® 2110 SERIES

Invitation brings the comforts of home into the workplace. Enjoy the simple pleasure of welcoming guests in arm chairs with integrated tables. Invitation guest chairs coordinate with Invitation lounge seating to make any space more comfortable and cohesive. Arrange in rows, groups or any configuration to suit your space or needs. The practical design and long-lasting comfort adds up to a stylish Invitation.



FEATURES

- Contoured back rest on guest chairs delivers ergonomic comfort.
- Floating back design enables easy cleaning.
- Guest chairs can be ganged together to create straight rows.
- Molded polymer seat shell increases comfort and durability.
- Solid hardwood in one of eight attractive finishes.
- Warranted for users up to 250 lbs.

INVITATION® 2110 Series Options

MODEL OPTIONS

H2111



Guest Chair

Leg Base, Arms

H2112

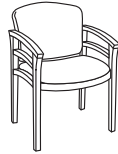

Guest Chair

Leg Base, Double Rail Arms

AVAILABLE FINISHES

Invitation® 2110 Series Seating is available in 8 wood finishes.

WOOD FINISHES

Bourbon Cherry (H)

Cognac (COGN)

Harvest (C)

Mahogany (N)

Mocha (MOCH)

Natural Maple (D)

Pinnacle (PINC)

Shaker Cherry (F)

AVAILABLE FABRICS

GRADE 1	GRADE 2	GRADE 3	GRADE 4	GRADE 5	GRADE 6	GRADE 7	GRADE 8	GRADE 9	GRADE 10	GRADE 11	GRADE 12	GRADE L
Arrondi *	Appoint Seating	Canter Polyurethane	Bar	Amuse	Intermix II	Ascend	Brisa® Polyurethane	Eli Vinyl	Affinity	Acrobat	Fenestra	
Attire	Bangle	Epic	Beeline	Avenue	Keynote	Central	Kindred	Martini Vinyl	Concentric	Natural World	Helix	
Centurion	Clyde	Infinity	Blip	Lariat	Raffia Vinyl	Channel		Olympus Vinyl	Juxy	Whirl	Lava	
Classic	Dotty	Knack	Coin	Outlander	Velocity	Domain		Silica			Ripple	
Compass	Esplanade *	Marathon	Cover Cloth	Polka	Wooly	Synergy		Silica Leather				
Confetti	Expo	Millennium	Current	Riddle		Waver		Silica Tech				
Contourette Polyurethane	Fuse	Odyssey	Decode	Sentry-HC								
Dapper	Gio *	Silvertex™ Vinyl	Disc	Sequence								
Inertia	Moguls	Syntax	Divide	Solace								
Optic	Origin	Tradition	Free	Tribeca								
Sierra Vinyl	Seed	Via	Habit									
Stitchery	Sockhop		Hive									
Tectonic	Spin Seating		Lineup									
	Whisper Vinyl		Manner									
			Medium									
			Messenger									
			Metric									
			Oblique									
			Pick									
			Sprint									
			Technic									

Reference Fabric Color Combinations on pages 18-29 for color codes and legend on page 19 for lead times. Visit hon.com for additional partnership fabrics.

NOTES: Gathers and creases may be more visible with Attire (AI) and Optic (OP) fabrics due to the inherent design and construction of these fabrics. COM yardage shown is for Pattern Cut only. Contact Customer Service for Railroaded yardage requirements. For additional HON to Supply COM fabric grade pricing, go to honready.hon.com and click on the HON to Supply COM link.

🔥 For Fire Code model, availability and ordering method, refer to pages 34-39. Available on select models, contact HON Customer Support for availability.

* Fabric is de-emphasized.



Icon Legend on page 14

INVITATION® 2110 Series

H2111



GUEST CHAIR

Leg Base
Arms

DIMENSIONS

Depth:	22	Arm Width:	18 ⁷ / ₈
Width:	23 ¹ / ₂	Seat to Floor Height:	18 ¹ / ₂
Height:	33 ³ / ₈	Usable Seat Depth:	17
Seat Depth:	17	Ship Weight:	24
Seat Width:	20	Cube:	15.0
Back Width:	21	COM:	1.5
Back Height:	16	Weight Rating:	250 lbs.

FABRIC PRICE CODES

1	\$551	8	\$758
2	\$587	9	\$785
3	\$623	10	\$812
4	\$650	11	\$839
5	\$677	12	\$866
6	\$704		
7	\$731		

H2112



GUEST CHAIR

Leg Base
Double Rail Arms

DIMENSIONS

Depth:	22	Arm Width:	18 ⁷ / ₈
Width:	23 ¹ / ₂	Seat to Floor Height:	18 ¹ / ₂
Height:	33 ³ / ₈	Usable Seat Depth:	17
Seat Depth:	17	Ship Weight:	28
Seat Width:	20	Cube:	15.0
Back Width:	21	COM:	1.5
Back Height:	16	Weight Rating:	250 lbs.

FABRIC PRICE CODES

1	\$604	8	\$811
2	\$640	9	\$838
3	\$676	10	\$865
4	\$703	11	\$892
5	\$730	12	\$919
6	\$757		
7	\$784		

HON Recommendation: H2111.MOCH.CU__ - List Price \$551

HOW TO SPECIFY

Select
Model Number

H 2 1 1 1 .

Select
Finish

See page 152

M O C H .

Select
Fabric

See page 152

C U 1 0

INVITATION® 2110 Series Connectors

GSA SIN 711-18



H2141



CONNECTORS

for Model H2111
One connector per two chairs

DIMENSIONS

Depth:	13 ¹⁵ / ₁₆	Ship Weight:	2.0 Ⓢ
Width:	4 ⁵ / ₈	Cube:	0.3
Height:	1	Weight Rating:	300 lbs.

LIST PRICE

\$51

H2142

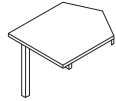

CORNER TABLE CONNECTOR

for Model H2111

DIMENSIONS

Depth:	28	Ship Weight:	25.5 Ⓢ
Width:	28	Cube:	2.6
Height:	17 ¹ / ₄	Weight Rating:	300 lbs.

LIST PRICE

\$465

! Customer or dealer must attach leg to table.

H2143

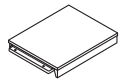

STRAIGHT TABLE CONNECTOR

for Model H2111

DIMENSIONS

Depth:	17 ¹ / ₈	Ship Weight:	16.5 Ⓢ
Width:	21	Cube:	1.5
Height:	17 ¹ / ₄	Weight Rating:	300 lbs.

LIST PRICE

\$335

H2144



CONNECTORS

for Model H2112
One connector per two chairs

DIMENSIONS

Depth:	13 ¹⁵ / ₁₆	Ship Weight:	2.0 Ⓢ
Width:	4 ¹ / ₄	Cube:	0.3
Height:	1 ⁵ / ₁₆	Weight Rating:	300 lbs.

LIST PRICE

\$51

H2145

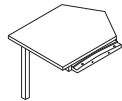

CORNER TABLE CONNECTOR

for Model H2112

DIMENSIONS

Depth:	28	Ship Weight:	25.5 Ⓢ
Width:	28	Cube:	2.6
Height:	17 ¹ / ₄	Weight Rating:	300 lbs.

LIST PRICE

\$465

! Customer or dealer must attach leg to table.

H2146

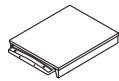

STRAIGHT TABLE CONNECTOR

for Model H2112

DIMENSIONS

Depth:	17 ¹ / ₈	Ship Weight:	16.5 Ⓢ
Width:	21	Cube:	1.5
Height:	17 ¹ / ₄	Weight Rating:	300 lbs.

LIST PRICE

\$335

HOW TO SPECIFY

<p>Select Model Number</p>	<p>Select Finish</p> <p>See page 152</p>
<div style="display: flex; gap: 5px;"> <div style="border: 1px solid black; padding: 2px 5px;">H</div> <div style="border: 1px solid black; padding: 2px 5px;">2</div> <div style="border: 1px solid black; padding: 2px 5px;">1</div> <div style="border: 1px solid black; padding: 2px 5px;">4</div> <div style="border: 1px solid black; padding: 2px 5px;">1</div> </div>	<div style="border: 1px solid black; padding: 2px 5px;">H</div>

INVITATION® LOUNGE



Invitation Lounge.

INVITATION® LOUNGE

Welcome your guests in professional style. Enjoy the simple pleasure of relaxing on a sofa with a laptop or welcoming guests in plush arm chairs. The Invitation lounge collection combines gracefully sloping arms, tapered wood legs and the deep-foam comfort of separate seat cushions. Invitation lounge seating coordinates with Invitation 2110 Series guest seating and connecting tables to make any space more comfortable and cohesive.



FEATURES

- Transitional design blends contemporary lines and traditional details.
- Clean lines and refined scale easily adapt to any private office or lobby.
- Contemporary tapered legs are offered in Platinum metallic or Black finish.
- Impressive design and fine craftsmanship in an affordably priced lounge chair.
- Removable seat cushion is deeply padded for added comfort.
- Warranted for users up to 250 lbs.

INVITATION® Lounge Options

MODEL OPTIONS

HFAA01



Arm Chair

HFAL02

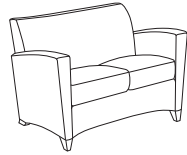

Love Seat

HFAS03

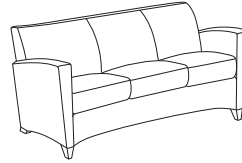

Sofa

LEG COLOR



CODE	DESCRIPTION	PRICE
T	Black	+ \$0



T1	Platinum Metallic	+ \$0
----	-------------------	-------

CARTON

CODE	DESCRIPTION	PRICE
BC	Carton	+ \$0

AVAILABLE FABRICS

GRADE 1	GRADE 2	GRADE 3	GRADE 4	GRADE 5	GRADE 6	GRADE 7	GRADE 8	GRADE 9	GRADE 10	GRADE 11	GRADE 12	GRADE L
Arrondi *	Appoint Seating	Canter Polyurethane	Bar	Amuse	Intermix II	Ascend	Brisa® Polyurethane	Eli Vinyl	Affinity	Acrobat	Fenestra	Denver Leather (Matches EE Vinyl)
Attire	Bangle	Epic	Beeline	Avenue	Keynote	Central	Kindred	Martini Vinyl	Concentric	Natural World Whirl	Helix	
Centurion	Clyde	Infinity	Blip	Lariat	Raffia Vinyl	Channel		Olympus Vinyl	Juxy		Lava	
Compass	Dotty	Knack	Coin	Outlander	Velocity	Domain		Silica			Ripple	
Confetti	Esplanade *	Marathon	Cover Cloth	Polka	Wooly	Synergy		Silica Leather				
Contourette Polyurethane	Expo	Millennium	Current	Riddle		Waver		Silica Tech				
Dapper	Fuse	Odyssey	Decode	Sentry-HC								
Inertia	Gio *	Silvertex™ Vinyl	Disc	Sequence								
Optic	Moguls	Syntax	Divide	Solace								
Stitchery	Origin	Tradition	Free	Tribeca								
Tectonic	Seed	Via	Habit									
	Sockhop		Hive									
	Spin Seating		Lineup									
	Whisper Vinyl		Manner									
			Medium									
			Messenger									
			Metric									
			Oblique									
			Pick									
			Sprint									
			Technic									

Reference Fabric Color Combinations on pages 18-29 for color codes and legend on page 19 for lead times. Visit hon.com for additional partnership fabrics.

NOTES: Gathers and creases may be more visible with Attire (AI) and Optic (OP) fabrics due to the inherent design and construction of these fabrics. For additional HON to Supply COM fabric grade pricing, go to honready.hon.com and click on the HON to Supply COM link.

⚠ For Fire Code model, availability and ordering method, refer to pages 34-39. Available on select models, contact HON Customer Support for availability.

* Fabric is de-emphasized.



Icon Legend on page 14

INVITATION® Lounge

HFAA01

ARM CHAIR



DIMENSIONS

Depth:	31½	Arm Width:	20
Width:	30	Seat to Floor Height:	18
Height:	34	Usable Seat Depth:	20
Seat Depth:	20	Ship Weight:	73
Seat Width:	20	Cube:	27.0
Back Width:	20	COM:	5.0
Back Height:	16	Weight Rating:	250 lbs.

FABRIC PRICE CODES

1	\$1577	8	\$2267
2	\$1697	9	\$2357
3	\$1817	10	\$2447
4	\$1907	11	\$2537
5	\$1997	12	\$2627
6	\$2087	L	\$2577
7	\$2177		

HFAL02

LOVE SEAT

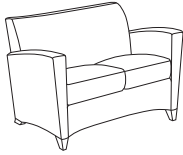

DIMENSIONS

Depth:	31¾	Arm Width:	40¼
Width:	50¼	Seat to Floor Height:	18
Height:	34¼	Usable Seat Depth:	20
Seat Depth:	20	Ship Weight:	112
Seat Width:	40¼	Cube:	55.7
Back Width:	40¼	COM:	6.5
Back Height:	16	Weight Rating:	250 lbs.

FABRIC PRICE CODES

1	\$2167	8	\$3064
2	\$2323	9	\$3181
3	\$2479	10	\$3298
4	\$2596	11	\$3415
5	\$2713	12	\$3532
6	\$2830	L	\$3467
7	\$2947		

HFAS03

SOFA

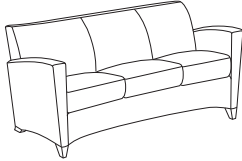

DIMENSIONS

Depth:	32	Arm Width:	60½
Width:	70½	Seat to Floor Height:	18
Height:	34½	Usable Seat Depth:	20
Seat Depth:	20	Ship Weight:	140
Seat Width:	60½	Cube:	72.0
Back Width:	60½	COM:	8.5
Back Height:	16	Weight Rating:	250 lbs.

FABRIC PRICE CODES

1	\$2758	8	\$3931
2	\$2962	9	\$4084
3	\$3166	10	\$4237
4	\$3319	11	\$4390
5	\$3472	12	\$4543
6	\$3625	L	\$4458
7	\$3778		

HON Recommendation: HFAA01.PNS__T.BC - List Price \$1697

HOW TO SPECIFY

<p>Select Model Number</p> <p>HFAA01</p>	<p>Select Fabric</p> <p>See page 156</p> <p>PNS007</p>	<p>Select Leg Color</p> <p>T Black TI Platinum Metallic</p> <p>T</p>	<p>Select Carton Option</p> <p>BC Carton</p> <p>BC</p>
---	---	---	---

LAURUS™ WOOD GUEST



Laurus Wood Slat Back Guest
Chairs shown with Valido® desks.

LAURUS™ WOOD GUEST

Go ahead, rest on your Laurus. From the gentle curve of the hardwood frame to the contoured seat cushion, Laurus guest chairs increase the comfort while elevating your brand. Each four-leg chair features a solid hardwood frame with tapered arms and a choice of wood slat back or upholstered back. They look and feel right at home in waiting and reception areas, open spaces and private offices.



FEATURES

- Contoured wood slat back adds a touch of elegance.
- Upholstered back includes padding for back comfort.
- Nylon glides slide effortlessly on all surfaces.
- Tapered arms provide added upper body support.
- Catalyzed finish enhances stain and mar resistance.
- Solid hardwood in one of eight attractive finishes.
- Warranted for users up to 250 lbs.

LAURUS™

Wood Guest Options

MODEL OPTIONS

H2171



Guest Chair

Wood Slat Back, Leg Base,
Tapered Arms

H2172



Guest Chair

Upholstered Back, Leg Base,
Tapered Arms

AVAILABLE FINISHES

Laurus™ Wood Guest Seating is available in 8 wood finishes.

WOOD FINISHES

Bourbon Cherry (H)

Cognac (COGN)

Harvest (C)

Mahogany (N)

Mocha (MOCH)

Natural Maple (D)

Pinnacle (PINC)

Shaker Cherry (F)

AVAILABLE FABRICS

GRADE 1	GRADE 2	GRADE 3	GRADE 4	GRADE 5	GRADE 6	GRADE 7	GRADE 8	GRADE 9	GRADE 10	GRADE 11	GRADE 12	GRADE L
Arrondi *	Appoint Seating	Canter Polyurethane	Bar	Amuse	Intermix II	Ascend Central	Brisa® Polyurethane Kindred	Eli Vinyl	Affinity Concentric	Acrobat Natural World Whirl	Fenestra Helix Lava Ripple	Denver Leather (Matches EE Vinyl)
Attire	Bangle	Epic	Beeline	Avenue	Keynote	Channel Domain Synergy Waver		Martini Vinyl	Juxy			
Centurion	Clyde	Infinity	Blip	Lariat	Raffia Vinyl			Olympus Vinyl				
Classic	Dotty	Knack	Coin	Outlander	Velocity			Silica				
Compass	Esplanade *	Marathon	Cover Cloth	Polka	Wooly			Silica Leather				
Confetti	Expo	Millennium	Current	Riddle				Silica Tech				
Contourette	Fuse	Odyssey	Decode	Sentry-HC								
Polyurethane	Gio *	Silvertex™ Vinyl	Disc	Sequence								
Dapper	Moguls	Syntax	Divide	Solace								
Inertia	Origin	Tradition	Free	Tribeca								
Optic	Seed	Via	Habit									
Sierra Vinyl	Sockhop		Hive									
Stitchery	Spin Seating		Lineup									
Tectonic	Whisper Vinyl		Manner									
			Medium									
			Messenger									
			Metric									
			Oblique									
			Pick									
			Sprint									
			Technic									

Reference Fabric Color Combinations on pages 18-29 for color codes and legend on page 19 for lead times. Visit hon.com for additional partnership fabrics.

NOTES: Gathers and creases may be more visible with Attire (AI) and Optic (OP) fabrics due to the inherent design and construction of these fabrics. For additional HON to Supply COM fabric grade pricing, go to honready.hon.com and click on the HON to Supply COM link.

🔥 For Fire Code model, availability and ordering method, refer to pages 34-39. Available on select models, contact HON Customer Support for availability.

* Fabric is de-emphasized.

LAURUS™ Wood Guest

GSA SIN 711-18



Icon Legend on page 14

H2171



GUEST CHAIR

Wood Slat Back
Leg Base
Tapered Arms

DIMENSIONS

Depth:	24¾	Arm Width:	21⅞
Width:	22½	Seat to Floor Height:	18¾
Height:	34	Usable Seat Depth:	20
Seat Depth:	20	Ship Weight:	30
Seat Width:	20	Cube:	15.1
Back Width:	18¼	COM:	1.0
Back Height:	16¾	Weight Rating:	250 lbs.

FABRIC PRICE CODES

1	\$740	8	\$878
2	\$764	9	\$896
3	\$788	10	\$914
4	\$806	11	\$932
5	\$824	12	\$950
6	\$842	L	\$940
7	\$860		

H2172

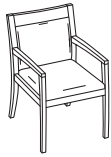

GUEST CHAIR

Upholstered Back
Leg Base
Tapered Arms

DIMENSIONS

Depth:	24¾	Arm Width:	21⅞
Width:	22½	Seat to Floor Height:	18¾
Height:	34	Usable Seat Depth:	20
Seat Depth:	20	Ship Weight:	26
Seat Width:	20	Cube:	15.1
Back Width:	18¼	COM:	1.5
Back Height:	16¾	Weight Rating:	250 lbs.

FABRIC PRICE CODES

1	\$827	8	\$1034
2	\$863	9	\$1061
3	\$899	10	\$1088
4	\$926	11	\$1115
5	\$953	12	\$1142
6	\$980	L	\$1127
7	\$1007		

HON Recommendation: H2172.MOCH.CU__ - List Price \$827

HOW TO SPECIFY

Select
Model Number

H 2 1 7 2 .

Select
Finish

See page 159

M O C H .

Select
Fabric

See page 159

C U 1 0



Lota Mesh Back Work and Side Chair with Voi® desks.

LOTA®

If you're looking for all-day comfort without breaking the bank, look no further than Lota. This mesh back family of task and guest chairs offer advanced features for customizable comfort that make it an upscale choice at an affordable price. Lota's control mechanism uses your own weight to provide perfect balance while reclining, and the pivoting arms put upper body support right where it's needed. If you sit for hours on end, put yourself in more control over your comfort.



FEATURES

- Weight-activated control responds naturally to your body's movements without any adjustments.
- 3-way arms adjust to various heights, depths and pivot positions.
- Multipurpose chairs feature black arms and base.
- One-touch seat height adjustment easily moves the seat up and down.
- Tilt tension controls the rate and ease of recline.
- Tilt lock allows the user to lock out the tilt function.
- 360-degree swivel provides freedom of movement in any direction.
- Polished Aluminum arms and base available on Model H2283.
- Fabrics are available in Black, Charcoal or Navy.
- Multipurpose chairs stack four high on the floor.
- Warranted for users up to 250 lbs.

MODEL OPTIONS

H2281



Mid-Back Work (Mesh Back)

Pneumatic, Tilt Lock, Weight Activated Control, Height, Depth, Pivot Adjustable Arms, Black Arms and Base

H2283



Mid-Back Work (Mesh Back)

Pneumatic, Tilt Lock, Weight Activated Control, Height, Depth, Pivot Adjustable Arms, Polished Aluminum Arms, Base, and Back Upright

H2285



Multi-purpose (Mesh Back)

4-Leg Stacking Frame, Fixed Arms

H2282



Mid-Back Work (Mesh Back)

Pneumatic, Tilt Lock, Weight Activated Control, Height, Depth, Pivot Adjustable Arms, Black Arms and Base

H2284



Mid-Back Work (Mesh Back)

Pneumatic, Tilt Lock, Weight Activated Control, Height, Depth, Pivot Adjustable Arms, Polished Aluminum Arms, Base, and Back Upright

LOTA® MID-BACK WORK H2281/H2283 AND MULTI-PURPOSE H2285 AVAILABLE FABRICS

GRADE 1	GRADE 2	GRADE 3	GRADE 4	GRADE 5	GRADE 6	GRADE 7	GRADE 8	GRADE 9	GRADE 10	GRADE 11	GRADE 12	GRADE L
Black Fabric Charcoal Fabric Navy Fabric												

Reference Fabric Color Combinations on pages 18-29 for color codes and legend on page 19 for lead times. Visit hon.com for additional partnership fabrics.

NOTES: Gathers and creases may be more visible with Attire (AI) and Optic (OP) fabrics due to the inherent design and construction of these fabrics.

🔥 For Fire Code model, availability and ordering method, refer to pages 34-39. Available on select models, contact HON Customer Support for availability.

LOTA® MID-BACK WORK H2282/H2284 AVAILABLE FABRICS

GRADE 1	GRADE 2	GRADE 3	GRADE 4	GRADE 5	GRADE 6	GRADE 7	GRADE 8	GRADE 9	GRADE 10	GRADE 11	GRADE 12	GRADE L
Arrondi * Attire Centurion Compass Confetti Contourette Polyurethane Dapper Inertia Optic Stitchery Tectonic	Appoint Seating Bangle Clyde Dotty Esplanade * Expo Fuse Gio * Moguls Origin Seed Sockhop Spin Seating Whisper Vinyl	Canter Polyurethane Epic Infinity Knack Marathon Millennium Odyssey Disc Divide Free Habit Hive Lineup Manner Medium Messenger Metric Oblique Pick Sprint Technic	Bar Beeline Blip Coin Cover Cloth Current Decode Disc Divide Free Habit Hive Lineup Manner Medium Messenger Metric Oblique Pick Sprint Technic	Amuse Avenue Lariat Outlander Polka Riddle Sentry-HC Sequence Solace Tribeca	Intermix II Keynote Raffia Vinyl Velocity Wooly	Ascend Central Channel Domain Synergy Waver	Brisa® Polyurethane Kindred	Eli Vinyl Martini Vinyl Olympus Vinyl Silica Silica Leather Silica Tech	Affinity Concentric Juxy	Acrobat Natural World Whirl	Fenestra Helix Lava Ripple	Denver Leather (Matches EE Vinyl)

Reference Fabric Color Combinations on pages 18-29 for color codes and legend on page 19 for lead times. Visit hon.com for additional partnership fabrics.

NOTES: Gathers and creases may be more visible with Attire (AI) and Optic (OP) fabrics due to the inherent design and construction of these fabrics. For additional HON to Supply COM fabric grade pricing, go to honready.hon.com and click on the HON to Supply COM link.

🔥 For Fire Code model, availability and ordering method, refer to pages 34-39. Available on select models, contact HON Customer Support for availability.

* Fabric is de-emphasized.



H2281



MID-BACK WORK CHAIR

Mesh Back
 Pneumatic
 Tilt Lock
 Weight Activated Control
 Height, Depth, Pivot Adjustable
 Arms
 Black Arms and Base

DIMENSIONS

Depth: 27¾
 Width: 26¾
 Height: 43½
 Seat Depth: 17¼
 Seat Width: 19½
 Back Width: 17¾
 Back Height: 23½

Arm Width: 20½
 Seat to Floor Height: 17⅞-21⅞
 Usable Seat Depth: 17¼
 Ship Weight: 50 Ⓢ
 Cube: 6.5
 Weight Rating: 250 lbs.

LIST PRICE

\$545

Functions: **A, E, F, L, Q**
 (Function Key on pages 16-17)

! Black Mesh back only.

H2283



MID-BACK WORK CHAIR

Mesh Back
 Pneumatic
 Tilt Lock
 Weight Activated Control
 Height, Depth, Pivot Adjustable
 Arms
 Polished Aluminum Arms, Base,
 and Back Upright

DIMENSIONS

Depth: 27¾
 Width: 26¾
 Height: 43⅝
 Seat Depth: 17¼
 Seat Width: 19½
 Back Width: 17¾
 Back Height: 23½

Arm Width: 20¼
 Seat to Floor Height: 17-21
 Usable Seat Depth: 17¼
 Ship Weight: 53 Ⓢ
 Cube: 6.5
 Weight Rating: 250 lbs.

LIST PRICE

\$670

Functions: **A, E, F, L, Q**
 (Function Key on pages 16-17)

! Black Mesh back only.

HON Recommendation: H2281.VA10.T - List Price \$545

HOW TO SPECIFY

Select Model Number

H 2 2 8 1 .

H 2 2 8 3 .

Select Fabric

VA10 Black Fabric
VA19 Charcoal Fabric
VA90 Navy Fabric

V A 1 0 .

V A 1 0 .

Select Frame

T Black (available on model H2281 only)
PA Polished Aluminum (available on model H2283 only)

T

P A



H2282



MID-BACK WORK CHAIR

Mesh Back
 Pneumatic
 Tilt Lock
 Weight Activated Control
 Height, Depth, Pivot Adjustable
 Arms
 Black Arms and Base

DIMENSIONS

Depth: 27¾
 Width: 26¾
 Height: 43½
 Seat Depth: 17¼
 Seat Width: 19½
 Back Width: 17¾
 Back Height: 23½

Arm Width: 20½
 Seat to Floor Height: 17½-21½
 Usable Seat Depth: 17¼
 Ship Weight: 50 **Ⓢ**
 Cube: 6.5
 Weight Rating: 250 lbs.

FABRIC PRICE CODES

1	\$615	8	\$753
2	\$639	9	\$771
3	\$663	10	\$789
4	\$681	11	\$807
5	\$699	12	\$825
6	\$717	L	—
7	\$735		

Functions: **A, E, F, L, Q**
 (Function Key on pages 16-17)

! Black Mesh back only.

H2284



MID-BACK WORK CHAIR

Mesh Back
 Pneumatic
 Tilt Lock
 Weight Activated Control
 Height, Depth, Pivot Adjustable
 Arms
 Polished Aluminum Arms, Base,
 and Back Upright

DIMENSIONS

Depth: 27¾
 Width: 26¾
 Height: 43⅝
 Seat Depth: 17¼
 Seat Width: 19½
 Back Width: 17¾
 Back Height: 23½

Arm Width: 20¼
 Seat to Floor Height: 17-21
 Usable Seat Depth: 17¼
 Ship Weight: 53 **Ⓢ**
 Cube: 6.5
 Weight Rating: 250 lbs.

FABRIC PRICE CODES

1	\$740	8	\$878
2	\$764	9	\$896
3	\$788	10	\$914
4	\$806	11	\$932
5	\$824	12	\$950
6	\$842	L	—
7	\$860		

Functions: **A, E, F, L, Q**
 (Function Key on pages 16-17)

! Black Mesh back only.

HON Recommendation: H2282.CU__T - List Price \$615

HOW TO SPECIFY

<p>Select Model Number</p> <p>H 2 2 8 2 .</p> <p>H 2 2 8 4 .</p>	<p>Select Fabric</p> <p>See page 163</p> <p>C U 1 0 .</p> <p>C U 1 0 .</p>	<p>Select Frame</p> <p>T Black (available on model H2282 only) PA Polished Aluminum (available on model H2284 only)</p> <p>T</p> <p>PA</p>
---	---	--



H2285



MULTI-PURPOSE CHAIR

Mesh Back
4-Leg Stacking Frame
Fixed Arms

DIMENSIONS

Depth:	24¾	Arm Width:	19⅞
Width:	23	Seat to Floor Height:	19⅞
Height:	34½	Usable Seat Depth:	17¾
Seat Depth:	17¾	Ship Weight:	20
Seat Width:	18⅞	Cube:	2.8
Back Width:	17⅞	Weight Rating:	250 lbs.
Back Height:	17¾		

LIST PRICE

\$296

NOTES: Casters and glides ship packaged together for customer's assembly choice. Stacks 4-high on floor.

Available in VA10 Black fabric seat and Black frame only. Black Mesh back only.

HOW TO SPECIFY

Select Model Number

H 2 2 8 5 .

Select Fabric

VA10 Black Fabric (only)

V A 1 0 .

Select Frame

T Black (only)

T

MOTIVATE® CHAIRS



Motivate 4-Leg Stacking
Chairs and Table.

MOTIVATE® CHAIRS

A presentation in the morning. A training session in the afternoon. Today's multipurpose spaces are in constant flux, and need an adaptable seating solution that delivers instant comfort for all, while easily moving around to support various activities. Motivate task chairs, stacking/nesting chairs and guest chairs create a streamlined collection of seating that intuitively responds to your body's natural movements and curves. Whether sitting for five minutes or five hours, when you Motivate your team you put everyone at ease.



FEATURES

- Choose plastic, upholstered or ilira®-stretch mesh back.
- Easily move chairs around the space for quick rearrangement.
- HMN1 nesting/stacking chairs stack four high on the floor.
- HMS1 sled base chairs stack 12 high on the floor or 40 high on a cart.
- HMS2 sled base chairs stack six high on the floor.
- Dynamic flex-zone motion in seat and back provides balance and lumbar support.
- Model HMT5 task stool features an adjustable footring.
- Plastic shell is available in 13 colors.
- Available in hundreds of quality HON fabrics.
- Warranted for users up to 300 lbs.

TASK CHAIR FEATURES

- One-touch seat height adjustment easily moves the seat up and down.
- 360-degree swivel provides freedom of movement in any direction.
- Warranted for users up to 300 lbs.

MOTIVATE® Task Chair Options

MODEL OPTIONS

HMT1



Flex-back

Upholstered Seat,
Pneumatic, Swivel

HMT5



Flex-back

Upholstered Seat,
Pneumatic, Swivel
Adjustable Footring

ARM STYLE

CODE	DESCRIPTION	PRICE
N	Armless	+\$0
A	Adjustable Arms	+\$70



CASTERS



CODE	DESCRIPTION	PRICE
H	Hard Caster	+\$0
S	Soft Caster	+\$30

BACK STYLE

CODE	DESCRIPTION	PRICE
------	-------------	-------

Plastic/Upholstered Options:



PS	Plastic Shell	+\$0
-----------	---------------	-------------



PB	Upholstered	+\$70
-----------	-------------	--------------

ilira® - stretch M4 Options:



IM	Black	+\$80
IF	Fox	+\$80
IV	Vanilla	+\$80
IC	Charcoal	+\$80
IH	Chai	+\$80
IY	Navy	+\$80

PLASTIC SHELL COLOR CODES (no upcharge):

Tangelo - **RG**
Regatta - **RE**
Lava - **LA**

Cherry - **CR**
Mulberry - **MB**
Onyx - **ON**

Lime - **LM**
Loft - **LO**
White - **WT**

Calypso - **CP**
Platinum - **PT**

Surf - **BU**
Shadow - **SD**

BASE



CODE	DESCRIPTION	PRICE
SB	Standard Base	+\$0

FRAME COLOR

CODE	DESCRIPTION	PRICE
T	Black	+\$0

MOTIVATE®

Task Chair Fabric Options

AVAILABLE FABRICS

GRADE 1	GRADE 2	GRADE 3	GRADE 4	GRADE 5	GRADE 6	GRADE 7	GRADE 8	GRADE 9	GRADE 10	GRADE 11	GRADE 12	GRADE L
Arrondi *	Appoint	Canter	Bar	Amuse	Intermix II	Ascend	Brisa®	Eli Vinyl	Affinity	Acrobat	Fenestra	Denver
Attire	Seating	Polyurethane	Beeline	Avenue	Keynote	Central	Polyurethane	Martini Vinyl	Concentric	Natural	Helix	Leather
Centurion	Bangle	Epic	Blip	Lariat	Raffia Vinyl	Channel	Kindred	Olympus	Juxy	World	Lava	(Matches
Classic	Clyde	Infinity	Coin	Outlander	Velocity	Domain		Vinyl		Whirl	Ripple	EE Vinyl)
Compass	Dotty	Knack	Cover Cloth	Polka	Wooly	Synergy		Silica				
Confetti	Esplanade *	Marathon	Current	Riddle		Waver		Silica Leather				
Contourette	Expo	Millennium	Decode	Sentry-HC				Silica Tech				
Polyurethane	Fuse	Odyssey	Disc	Sequence								
Dapper	Gio *	Silvertex™	Divide	Solace								
Inertia	Moguls	Vinyl	Free	Tribeca								
Optic	Origin	Syntax	Habit									
Stitchery	Seed	Tradition	Hive									
Tectonic	Sockhop	Via	Lineup									
	Spin Seating		Manner									
	Whisper		Medium									
	Vinyl		Messenger									
			Metric									
			Oblique									
			Pick									
			Sprint									
			Technic									

Reference Fabric Color Combinations on pages 18-29 for color codes and legend on page 19 for lead times. Visit hon.com for additional partnership fabrics.

NOTES: Gathers and creases may be more visible with Attire (AI) and Optic (OP) fabrics due to the inherent design and construction of these fabrics.

⚠ For Fire Code model, availability and ordering method, refer to pages 34-39. Available on select models, contact HON Customer Support for availability.

* Fabric is de-emphasized.

MOTIVATE® Task Chairs

GSA SIN 711-18



Icon Legend on page 14

HMT1

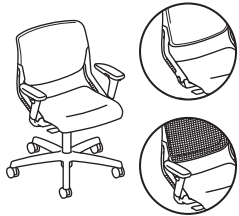

TASK CHAIR

Flex-back
Upholstered Seat
Pneumatic
Swivel

DIMENSIONS

Depth:	27½	Seat to Floor Height:	17-22⅝
Width:	27½	Usable Seat Depth:	18
Height:	37½	Ship Weight (upholstered back):	39 Ⓢ
Seat Depth:	18	Ship Weight (plastic/mesh back):	38 Ⓢ
Seat Width:	17½	Cube (upholstered back):	10.0
Back Width:	19½	Cube (plastic/mesh back):	10.0
Back Height:	17¾	COM (upholstered back):	1.5
Arm Width:	18½-20	COM (plastic/mesh back):	1.0
		Weight Rating:	300 lbs.

FABRIC PRICE CODES

1	\$400	8	\$607
2	\$436	9	\$634
3	\$472	10	\$661
4	\$499	11	\$688
5	\$526	12	\$715
6	\$553	L	\$700
7	\$580		

! When a Plastic Shell (PS) or Upholstered Back (PB) option is chosen, you must select a shell color. If the mesh back option is chosen, the shell color is not specified. CA Technical Bulletin 133 compliant shells available in LA-Lava ONLY, ordering instructions below.

HMT5

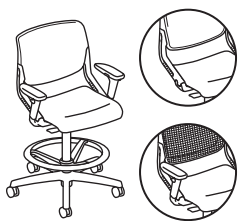

TASK STOOL

Flex-back
Upholstered Seat
Pneumatic
Swivel Adjustable Footring

DIMENSIONS

Depth:	28¼	Seat to Floor Height:	22⅞-32⅝
Width:	28¼	Usable Seat Depth:	18
Height:	50½	Ship Weight (upholstered back):	44 Ⓢ
Seat Depth:	18	Ship Weight (plastic/mesh back):	43 Ⓢ
Seat Width:	17½	Cube (upholstered back):	10.0
Back Width:	19½	Cube (plastic/mesh back):	10.0
Back Height:	17¾	COM (upholstered back):	1.5
Arm Width:	18½-20	COM (plastic/mesh back):	1.0
		Weight Rating:	300 lbs.

FABRIC PRICE CODES

1	\$455	8	\$662
2	\$491	9	\$689
3	\$527	10	\$716
4	\$554	11	\$743
5	\$581	12	\$770
6	\$608	L	\$755
7	\$635		

NOTES: Stool model has adjustable footring.

! When a Plastic Shell (PS) or Upholstered Back (PB) option is chosen, you must select a shell color. If the mesh back option is chosen, the shell color is not specified. CA Technical Bulletin 133 compliant shells available in LA-Lava ONLY, ordering instructions below.

HON Recommendation: HMT1.A.H.IM.CU__SB.T - List Price \$550

HOW TO SPECIFY

Select Model Number	Select Arm Type	Select Caster	Select Back Type/Color	Select Fabric	Select Base	Select Frame
HMT1	A Adjustable Arms (+ \$70) N Armless	H Hard Caster S Soft Caster (+ \$30)	PS Plastic Shell PB Upholstered (+ \$70) If PS or PB options are chosen, select shell color. Plastic Shell Colors RG Tangelo LO Loft CR Cherry PT Platinum LM Lime SD Shadow CP Calypso LA Lava BU Surf ON Onyx RE Regatta WT White MB Mulberry ilira®-stretch M4 options (+ \$80) IM Black IC Charcoal IF Fog IH Chai IV Vanilla IY Navy	See page 169	SB Standard Base	T Black
HMT1	A	H	IM	CU10	SB	T
HMT1	A	H	PSLA	CU10	SB	T

MOTIVATE®

High-Density Sled Base Chair Options

MODEL OPTIONS

HMS1



High-Density Stacker

Sled Leg Base

HMS2



High-Density Stacker

Upholstered Seat, Sled Leg Base

ARM STYLE

CODE	DESCRIPTION	PRICE
F	Fixed Arms	+\$30
N	Armless	+\$0



FRAME

CODE	DESCRIPTION	PRICE
Y	Chrome	+\$0
BLCK	Textured Black	+\$0
PLAT	Textured Platinum Metallic	+\$0

PLASTIC SHELL COLOR CODES (no upcharge):	Tangelo - RG	Cherry - CR	Lime - LM	Calypso - CP	Surf - BU
	Regatta - RE	Mulberry - MB	Loft - LO	Platinum - PT	Shadow - SD
	Lava - LA	Onyx - ON	White - WT		

! CA Technical Bulletin 133 compliant shells available in all 13 shell colors (no upcharge).

AVAILABLE FABRICS

GRADE 1	GRADE 2	GRADE 3	GRADE 4	GRADE 5	GRADE 6	GRADE 7	GRADE 8	GRADE 9	GRADE 10	GRADE 11	GRADE 12	GRADE L
Arrondi * Attire Centurion Classic Compass Confetti Contourette Polyurethane Dapper Inertia Optic Stitchery Tectonic	Appoint Seating Bangle Clyde Dotty Esplanade * Expo Fuse Gio * Moguls Origin Seed Sockhop Spin Seating Whisper Vinyl	Canter Polyurethane Epic Infinity Knack Marathon Millennium Odyssey Silvertex™ Vinyl Syntax Tradition Via	Bar Beeline Blip Coin Cover Cloth Current Decode Disc Divide Free Habit Hive Lineup Manner Medium Messenger Metric Oblique Pick Sprint Technic	Amuse Avenue Lariat Outlander Polka Riddle Sentry-HC Sequence Solace Tribeca	Intermix II Keynote Raffia Vinyl Velocity Wooly	Ascend Central Channel Domain Synergy Waver	Brisa® Polyurethane Kindred	Eli Vinyl Martini Vinyl Olympus Vinyl Silica Silica Leather Silica Tech	Affinity Concentric Juxy	Acrobat Natural World Whirl	Fenestra Helix Lava Ripple	Denver Leather (Matches EE Vinyl)

Reference Fabric Color Combinations on pages 18-29 for color codes and legend on page 19 for lead times. Visit hon.com for additional partnership fabrics.

NOTES: Gathers and creases may be more visible with Attire (AI) and Optic (OP) fabrics due to the inherent design and construction of these fabrics.

! For Fire Code model, availability and ordering method, refer to pages 34-39. Available on select models, contact HON Customer Support for availability.

* Fabric is de-emphasized.

MOTIVATE® High-Density Sled Base Chairs

GSA SIN 711-19



HMS1

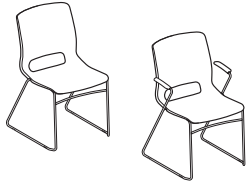

HIGH-DENSITY STACKER

Sled Leg Base

DIMENSIONS

Depth:	23	Arm Width:	18 ⁷ / ₈
Width:	21	Seat to Floor Height:	17 ³ / ₄
Height:	32 ¹ / ₄	Usable Seat Depth:	18 ¹ / ₄
Seat Depth:	18 ¹ / ₄	Ship Weight:	72
Seat Width:	17 ³ / ₄	Cube:	15.2
Back Width:	17 ¹ / ₄	Weight Rating:	300 lbs.
Back Height:	18		

LIST PRICE PER CARTON

\$741

(reference single unit @
\$185.25)

NOTES: HMS1 shells are CA Technical Bulletin 133 compliant (no upcharge). HMS1 Sled Base chairs stack 12-high on the floor, or 40-high on the chair cart model HMSCART. Field installed glides snap-on using existing locations on the sled base frames.

❗ HMS1 is not available in FC. Ganging Chair Glides are designed for use on armless models of the Motivate® High-Density Sled Base Chairs only. Not for use on models specified with arms.

HMS2

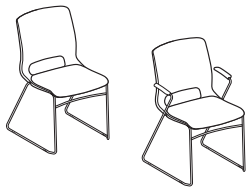

HIGH-DENSITY STACKER

Upholstered Seat
Sled Leg Base

DIMENSIONS

Depth:	23	Arm Width:	18 ⁷ / ₈
Width:	21	Seat to Floor Height:	18 ¹ / ₄
Height:	32 ¹ / ₄	Usable Seat Depth:	18 ¹ / ₄
Seat Depth:	18 ¹ / ₄	Ship Weight:	80
Seat Width:	17 ³ / ₄	Cube:	15.2
Back Width:	17 ¹ / ₄	COM:	1.0
Back Height:	17 ¹ / ₂	Weight Rating:	300 lbs.

FABRIC PRICE CODES

1	\$980	8	\$1118
2	\$1004	9	\$1136
3	\$1028	10	\$1154
4	\$1046	11	\$1172
5	\$1064	12	\$1190
6	\$1082	L	\$1180
7	\$1100		

NOTES: HMS2 Sled Base chairs stack 6-high on the floor. Field installed glides snap-on using existing locations on the sled base frames.

❗ Ganging Chair Glides are designed for use on armless models of the Motivate® High-Density Sled Base Chairs only. Not for use on models specified with arms. Upholstered seat model HMS2 is not designed to be stacked on the HMSCART.

👤 Motivate® Sled Base Chairs are ordered and shipped four (4) chairs per carton. Pricing shown is per carton. Each set of four chairs (one carton), must have the same shell/frame color combination. Ordering 2 of Model HMS1, HMS2 will result in 2 cartons being shipped, giving you 8 chairs.

HMSCART



CART FOR HMS1 STACKING CHAIRS

DIMENSIONS

Depth:	34 ¹ / ₄	Ship Weight:	40
Width:	21 ¹ / ₈	Cube:	7.8
Height:	36 ⁵ / ₈		

LIST PRICE

\$425

NOTES: Holds up to 40 Stacking Chairs.

HON Recommendation: HMS1.N.ON.Y - List Price \$741

HOW TO SPECIFY

Select Model Number	Select Arm Type	Select Shell Color	Select Fabric	Select Frame
F HMS1	F Fixed Arms (+ \$30 per chair) N Armless	RG Tangelo CR Cherry LM Lime CP Calypso BU Surf RE Regatta MB Mulberry	LO Loft PT Platinum SD Shadow LA Lava ON Onyx WT White	Y Chrome BLCK Textured Black PLAT Textured Platinum Metallic
F HMS2	N	ON	See page 171 <i>Not specified for HMS1 models</i>	BLCK
	N	ON	CU10	BLCK



MOTIVATE® High-Density Sled Base Chairs

HMSGLD



GLIDES FOR MOTIVATE® HIGH-DENSITY STACKER

- Kit includes 48 glides for 12 chairs
- Field installed
- Snap-on using existing locations on frames

DIMENSIONS

Ship Weight: 1 Ⓢ
Cube: 0.2

LIST PRICE

\$57

HMSFLTGLD



FELT GLIDES FOR MOTIVATE® HIGH-DENSITY STACKER

- Kit includes 48 glides for 12 chairs
- Field installed
- Snap-on using existing locations on frames

DIMENSIONS

Ship Weight: 1 Ⓢ
Cube: 0.2

LIST PRICE

\$150

HMSSTLGLD



STEEL GLIDES FOR MOTIVATE® HIGH-DENSITY STACKER

- Kit includes 48 glides for 12 chairs
- Field installed
- Snap-on using existing locations on frames

DIMENSIONS

Ship Weight: 1 Ⓢ
Cube: 0.2

LIST PRICE

\$150

HMSGANG

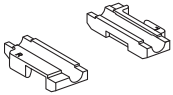

GANGING CONNECTORS FOR MOTIVATE® HIGH-DENSITY STACKER

- 48 ganging connectors
- Requires 4 connectors per ganging connection
- For use on HMS1.N and HMS2.N only (armless models)
- Field installed
- Snap-on using existing locations on frames

DIMENSIONS

Ship Weight: 1 Ⓢ
Cube: 0.2

LIST PRICE

\$109

HOW TO SPECIFY

Select Model Number

H M S G L D

MOTIVATE® 4-Leg Chair Options

MODEL OPTIONS

HMG1



Stack Chair

Four Legs, Set of 2

HMG2



Stack Chair

Four Legs, Upholstered
Seat, Set of 2

HMG5



Café-Height Stool

Four Legs

HMG7



Café-Height Stool

Four Legs, Upholstered
Seat

ARM STYLE

CODE	DESCRIPTION	PRICE
F	Fixed Arms	+\$30
N	Armless	+\$0



CASTERS/ GLIDES

CODE	DESCRIPTION	PRICE
H	Hard Caster	+\$0
S	Soft Caster	+\$20
<i>*Casters only available on HMG1 and HMG2</i>		
E	Standard Nylon Glide	+\$0
F	Felt Glide	+\$30
R	Rubber Glide	+\$30
T	Steel Glide	+\$30



FRAME

CODE	DESCRIPTION	PRICE
BLCK	Textured Black	+\$0
PLAT	Textured Platinum Metallic	+\$0

PLASTIC SHELL COLOR CODES (no upcharge):						
Tangelo - RG	Cherry - CR	Lime - LM	Calypso - CP	Surf - BU		
Regatta - RE	Mulberry - MB	Loft - LO	Platinum - PT	Shadow - SD		
Lava - LA	Onyx - ON	White - WT				

! CA Technical Bulletin 133 compliant shells available in all 13 shell colors (no upcharge).

MOTIVATE®

4-Leg Chair Fabric Options

AVAILABLE FABRICS

GRADE 1	GRADE 2	GRADE 3	GRADE 4	GRADE 5	GRADE 6	GRADE 7	GRADE 8	GRADE 9	GRADE 10	GRADE 11	GRADE 12	GRADE L
Arrondi *	Appoint Seating	Canter Polyurethane	Bar	Amuse	Intermix II	Ascend	Brisa® Polyurethane	Eli Vinyl	Affinity	Acrobat	Fenestra	Denver Leather (Matches EE Vinyl)
Attire	Bangle	Epic	Beeline	Avenue	Keynote	Central	Kindred	Martini Vinyl	Concentric	Natural World	Helix	
Centurion	Clyde	Infinity	Blip	Lariat	Raffia Vinyl	Channel		Olympus Vinyl	Juxy	Whirl	Lava	
Classic	Dotty	Knack	Coin	Outlander	Velocity	Domain		Silica			Ripple	
Compass	Esplanade *	Marathon	Cover Cloth	Polka	Wooly	Synergy		Silica Leather				
Confetti	Expo	Millennium	Current	Riddle		Waver		Silica Tech				
Contourette	Fuse	Odyssey	Decode	Sentry-HC								
Polyurethane	Gio *	Silvertex™ Vinyl	Disc	Sequence								
Dapper	Moguls	Syntax	Divide	Solace								
Inertia	Origin	Tradition	Free	Tribeca								
Optic	Seed	Via	Habit									
Stitchery	Sockhop		Hive									
Tectonic	Spin Seating		Lineup									
	Whisper Vinyl		Manner									
			Medium									
			Messenger									
			Metric									
			Oblique									
			Pick									
			Sprint									
			Technic									

Reference Fabric Color Combinations on pages 18-29 for color codes and legend on page 19 for lead times. Visit hon.com for additional partnership fabrics.

NOTES: Gathers and creases may be more visible with Attire (AI) and Optic (OP) fabrics due to the inherent design and construction of these fabrics.

⚡ For Fire Code model, availability and ordering method, refer to pages 34-39. Available on select models, contact HON Customer Support for availability.

* Fabric is de-emphasized.

MOTIVATE® 4-Leg Chairs

GSA SIN 711-19



Icon Legend on page 14

HMG1

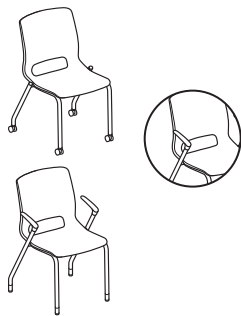

STACK CHAIR

Four Legs
Set of 2

DIMENSIONS

Depth:	23	Arm Width:	18
Width:	21	Seat to Floor Height:	17¾
Height:	32¼	Usable Seat Depth:	18¼
Seat Depth:	18¼	Ship Weight:	38
Seat Width:	17¾	Cube:	13.0
Back Width:	17¼	Weight Rating:	300 lbs.
Back Height:	18		

LIST PRICE PER CARTON

\$500
*(reference single unit @
\$250.00)*

NOTES: HMG1 shells are CA Technical Bulletin 133 compliant (no upcharge). 4-Leg chairs stack 6-high on the floor.

HMG2

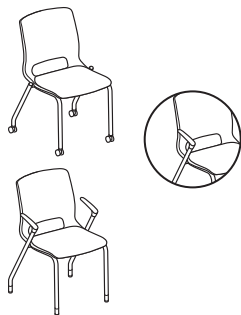

STACK CHAIR

Four Legs
Upholstered Seat
Set of 2

DIMENSIONS

Depth:	23	Arm Width:	18
Width:	21	Seat to Floor Height:	18¼
Height:	32¼	Usable Seat Depth:	18¼
Seat Depth:	18¼	Ship Weight:	44
Seat Width:	17¾	Cube:	13.0
Back Width:	17¼	COM:	1.0
Back Height:	17½	Weight Rating:	300 lbs.

FABRIC PRICE CODES

1	\$616	8	\$754
2	\$640	9	\$772
3	\$664	10	\$790
4	\$682	11	\$808
5	\$700	12	\$826
6	\$718	L	\$816
7	\$736		

NOTES: 4-Leg chairs stack 6-high on the floor.

i Motivate® 4-leg Chairs are ordered and shipped two (2) chairs per carton. Pricing shown is per carton. Each set of two chairs (one carton), must have the same shell/frame color combination. Ordering 2 of Model HMG1, HMG2 will result in 2 cartons being shipped, giving you 4 chairs. 4-Leg chairs stack 6-high on the floor.

HON Recommendation: HMG1.N.H.ON.PLAT - List Price \$500

HOW TO SPECIFY

Select Model Number	Select Arm Type	Select Caster/Glide	Select Shell Color	Select Fabric	Select Frame
	F Fixed Arms (+ \$30 per chair) N Armless	H Hard Caster S Soft Caster (+ \$20 per chair) <i>Casters only available on HMG1 and HMG2</i> E Standard Nylon Glide F Felt Glide (+ \$30 per chair) R Rubber Glide (+ \$30 per chair) T Steel Glide (+ \$30 per chair)	RG Tangelo LO Loft CR Cherry PT Platinum LM Lime SD Shadow CP Calypso LA Lava BU Surf ON Onyx RE Regatta WT White MB Mulberry	See page 175 <i>Not specified for models HMG1 and HMG5</i>	BLCK Textured Black PLAT Textured Platinum Metallic
HMG1 .	N .	H .	ON .		PLAT
HMG2 .	N .	H .	ON .	CU10 .	PLAT



MOTIVATE® 4-Leg Chairs

HMG5

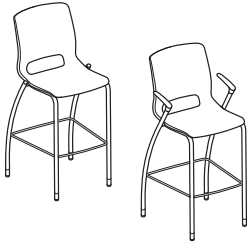

CAFÉ-HEIGHT STOOL

Four Legs

DIMENSIONS

Depth:	23	Arm Width:	18
Width:	21	Seat to Floor Height:	30
Height:	44½	Usable Seat Depth:	18½
Seat Depth:	18½	Ship Weight:	30
Seat Width:	17¾	Cube:	19.3
Back Width:	17¼	Weight Rating:	300 lbs.
Back Height:	18		

LIST PRICE

\$332

NOTES: HMG5 shells are CA Technical Bulletin 133 compliant (no upcharge).

HMG7

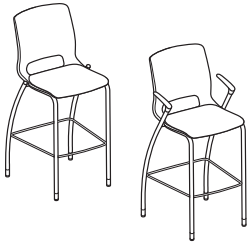

CAFÉ-HEIGHT STOOL

Four Legs
Upholstered Seat

DIMENSIONS

Depth:	23	Arm Width:	18
Width:	21	Seat to Floor Height:	30½
Height:	44½	Usable Seat Depth:	18¼
Seat Depth:	18½	Ship Weight:	34
Seat Width:	17¾	Cube:	19.3
Back Width:	17¼	COM:	1.0
Back Height:	17½	Weight Rating:	300 lbs.

FABRIC PRICE CODES

1	\$393	8	\$531
2	\$417	9	\$549
3	\$441	10	\$567
4	\$459	11	\$585
5	\$477	12	\$603
6	\$495	L	\$593
7	\$513		

NOTES: HMG7 shells are CA Technical Bulletin 133 compliant (no upcharge).

HON Recommendation: HMG5.N.E.ON.PLAT - List Price \$332

HOW TO SPECIFY

Select Model Number	Select Arm Type	Select Glide	Select Shell Color	Select Fabric	Select Frame
	F Fixed Arms (+ \$30 per chair) N Armless	E Standard Nylon Glide F Felt Glide (+ \$30 per chair) R Rubber Glide (+ \$30 per chair) T Steel Glide (+ \$30 per chair)	RG Tangelo LO Loft CR Cherry PT Platinum LM Lime SD Shadow CP Calypso LA Lava BU Surf ON Onyx RE Regatta WT White MB Mulberry	See page 175 <i>Not specified for models HMG1 and HMG5</i>	BLCK Textured Black PLAT Textured Platinum Metallic
HMG5 .	N .	E .	ON .		PLAT
HMG7 .	N .	E .	ON .	CU10 .	PLAT

MOTIVATE® Nesting/Stacking Flex-Back Chair Options

MODEL OPTIONS

HMN1



Flex-back

Nesting/Stacking,
Four Legs

HMN2



Flex-back

Nesting/Stacking, Four
Legs, Upholstered Seat

ARM STYLE

CODE	DESCRIPTION	PRICE
F	Fixed Arms	+\$50
N	Armless	+\$0



CASTERS/ GLIDE



CODE	DESCRIPTION	PRICE
H	Hard Caster	+\$0
S	Soft Caster	+\$20
E	Standard Nylon Glide	+\$0

BACK STYLE

CODE	DESCRIPTION	PRICE
------	-------------	-------

Plastic/Upholstered Options:



PS	Plastic Shell	+\$0
-----------	---------------	-------------



PB	Upholstered	+\$70
-----------	-------------	--------------

**PB only available on HMN2*

ilira® - stretch M4 Options:



IM	Black	+\$80
IF	Fox	+\$80
IV	Vanilla	+\$80
IC	Charcoal	+\$80
IH	Chai	+\$80
IY	Navy	+\$80

PLASTIC SHELL COLOR CODES (no upcharge):

Tangelo - RG	Cherry - CR	Lime - LM	Calypso - CP	Surf - BU
Regatta - RE	Mulberry - MB	Loft - LO	Platinum - PT	Shadow - SD
Lava - LA	Onyx - ON	White - WT		

Nesting/Stacking Flex-Back Chair Fabric Options

AVAILABLE FABRICS

GRADE 1	GRADE 2	GRADE 3	GRADE 4	GRADE 5	GRADE 6	GRADE 7	GRADE 8	GRADE 9	GRADE 10	GRADE 11	GRADE 12	GRADE L
Arrondi *	Appoint	Canter	Bar	Amuse	Intermix II	Ascend	Brisa®	Eli Vinyl	Affinity	Acrobat	Fenestra	Denver
Attire	Seating	Polyurethane	Beeline	Avenue	Keynote	Central	Polyurethane	Martini Vinyl	Concentric	Natural	Helix	Leather
Centurion	Bangle	Epic	Blip	Lariat	Raffia Vinyl	Channel	Kindred	Olympus	Juxy	World	Lava	(Matches
Classic	Clyde	Infinity	Coin	Outlander	Velocity	Domain		Vinyl		Whirl	Ripple	EE Vinyl)
Compass	Dotty	Knack	Cover Cloth	Polka	Wooly	Synergy		Silica				
Confetti	Esplanade *	Marathon	Current	Riddle		Waver		Silica Leather				
Contourette	Expo	Millennium	Decode	Sentry-HC				Silica Tech				
Polyurethane	Fuse	Odyssey	Disc	Sequence								
Dapper	Gio *	Silvertex™	Divide	Solace								
Inertia	Moguls	Vinyl	Free	Tribeca								
Optic	Origin	Syntax	Habit									
Stitchery	Seed	Tradition	Hive									
Tectonic	Sockhop	Via	Lineup									
	Spin Seating		Manner									
	Whisper		Medium									
	Vinyl		Messenger									
			Metric									
			Oblique									
			Pick									
			Sprint									
			Technic									

Reference Fabric Color Combinations on pages 18-29 for color codes and legend on page 19 for lead times. Visit hon.com for additional partnership fabrics.

NOTES: Gathers and creases may be more visible with Attire (AI) and Optic (OP) fabrics due to the inherent design and construction of these fabrics.

⚠ For Fire Code model, availability and ordering method, refer to pages 34-39. Available on select models, contact HON Customer Support for availability.

* Fabric is de-emphasized.

MOTIVATE® Nesting/Stacking Flex-Back Chairs

GSA SIN 711-19



HMN1

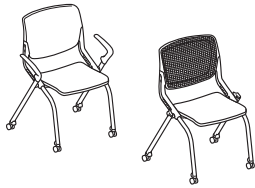

CHAIR

Flex-back
Nesting/Stacking
Four Legs

DIMENSIONS

Depth:	23 ³ / ₈	Arm Width:	24
Width:	26 ³ / ₄	Seat to Floor Height:	18 ¹ / ₄
Height:	34	Usable Seat Depth:	16 ³ / ₄
Seat Depth:	16 ³ / ₄	Ship Weight:	27
Seat Width:	17	Cube:	15.1
Back Width:	19 ¹ / ₂	Weight Rating:	300 lbs.
Back Height:	19		

LIST PRICE

\$406

NOTES: Stack 4-high on floor.

! When selecting the mesh back option, frame around mesh is always black. CA Technical Bulletin 133 compliant shells available in LA-Lava ONLY, ordering instructions below.

HMN2

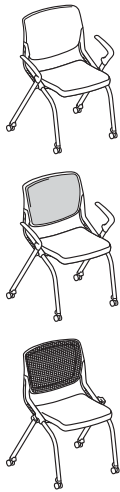

CHAIR

Flex-back
Nesting/Stacking
Four Legs
Upholstered Seat

DIMENSIONS

Depth:	23 ³ / ₈	Seat to Floor Height:	19 ¹ / ₄
Width:	26 ³ / ₄	Usable Seat Depth:	17
Height:	34	Ship Weight (upholstered back):	29
Seat Depth:	17	Ship Weight (plastic/mesh back):	28
Seat Width:	17 ³ / ₈	Cube (upholstered back):	15.1
Back Width:	19 ¹ / ₂	Cube (plastic/mesh back):	15.1
Back Height:	18 ³ / ₈	COM (upholstered back):	1.0
Arm Width:	24	COM (plastic/mesh back):	1.0
		Weight Rating:	300 lbs.

FABRIC PRICE CODES

1	\$467	8	\$605
2	\$491	9	\$623
3	\$515	10	\$641
4	\$533	11	\$659
5	\$551	12	\$677
6	\$569	L	\$667
7	\$587		

NOTES: Stack 4-high on floor.

! When selecting the mesh back option, frame around mesh is always black. CA Technical Bulletin 133 compliant shells available in LA-Lava ONLY, ordering instructions below.

HON Recommendation: HMN1.N.H.IM.ON.CU__PLAT - List Price \$486

HOW TO SPECIFY

Select Model Number	Select Arm Type	Select Caster/Glide	Select Back Type	Select Shell Color	Select Fabric	Select Frame
<p>F Fixed Arms (+ \$50)</p> <p>N Armless</p>	<p>E Standard Nylon Glide</p> <p>H Hard Caster</p> <p>S Soft Caster (+ \$20)</p>	<p>PS Plastic Shell</p> <p>PB Upholstered (+ \$70)</p> <p><i>PB option available on HMN2 only</i></p> <p>ilira®-stretch M4 options (+ \$80)</p> <p>IM Black</p> <p>IF Fog</p> <p>IV Vanilla</p> <p>IC Charcoal</p> <p>IH Chai</p> <p>IY Navy</p>	<p>RG Tangelo</p> <p>CR Cherry</p> <p>LM Lime</p> <p>CP Calypso</p> <p>BU Surf</p> <p>RE Regatta</p> <p>MB Mulberry</p>	<p>LO Loft</p> <p>PT Platinum</p> <p>SD Shadow</p> <p>LA Lava</p> <p>ON Onyx</p> <p>WT White</p>	<p>See page 179</p> <p><i>Specify for model HMN2 only</i></p>	<p>BLCK Textured Black</p> <p>PLAT Textured Platinum Metallic</p>
<p>HMN1</p> <p>HMN2</p>	<p>N</p> <p>N</p>	<p>H</p> <p>H</p>	<p>IM</p> <p>PB</p>	<p>ON</p> <p>ON</p>	<p>CU10</p>	<p>PLAT</p> <p>PLAT</p>

MOTIVATE® Chair with Tablet Arm Options

MODEL OPTIONS

HMG1



with Tablet Arm

Four Legs

HMG2



with Tablet Arm

Four Legs, Upholstered Seat

CASTERS/ GLIDES



CODE	DESCRIPTION	PRICE
H	Hard Caster	+\$0



S	Soft Caster	+\$20
----------	-------------	--------------



E	Standard Nylon Glide	+\$0
F	Felt Glide	+\$30
R	Rubber Glide	+\$30
T	Steel Glide	+\$30

TABLET SIDE



CODE	DESCRIPTION	PRICE
RT	Right Side	+\$0
LT	Left Side	+\$0



TABLET COLOR

CODE	DESCRIPTION	PRICE
T	Black	+\$0
D	Natural Maple	+\$0

FRAME

CODE	DESCRIPTION	PRICE
BLCK	Textured Black	+\$0
PLAT	Textured Platinum Metallic	+\$0

PLASTIC SHELL COLOR CODES (no upcharge):

Tangelo - RG	Cherry - CR	Lime - LM	Calypso - CP	Surf - BU
Regatta - RE	Mulberry - MB	Loft - LO	Platinum - PT	Shadow - SD
Lava - LA	Onyx - ON	White - WT		

! CA Technical Bulletin 133 compliant shells available in all 13 shell colors (no upcharge).

MOTIVATE®

Chair with Tablet Arm Fabric Options

AVAILABLE FABRICS

GRADE 1	GRADE 2	GRADE 3	GRADE 4	GRADE 5	GRADE 6	GRADE 7	GRADE 8	GRADE 9	GRADE 10	GRADE 11	GRADE 12	GRADE L
Arrondi *	Appoint	Canter	Bar	Amuse	Intermix II	Ascend	Brisa®	Eli Vinyl	Affinity	Acrobat	Fenestra	Denver
Attire	Seating	Polyurethane	Beeline	Avenue	Keynote	Central	Polyurethane	Martini Vinyl	Concentric	Natural	Helix	Leather
Centurion	Bangle	Epic	Blip	Lariat	Raffia Vinyl	Channel	Kindred	Olympus	Juxy	World	Lava	(Matches
Classic	Clyde	Infinity	Coin	Outlander	Velocity	Domain		Vinyl		Whirl	Ripple	EE Vinyl)
Compass	Dotty	Knack	Cover Cloth	Polka	Wooly	Synergy		Silica				
Confetti	Esplanade *	Marathon	Current	Riddle		Waver		Silica Leather				
Contourette	Expo	Millennium	Decode	Sentry-HC				Silica Tech				
Polyurethane	Fuse	Odyssey	Disc	Sequence								
Dapper	Gio *	Silvertext™	Divide	Solace								
Inertia	Moguls	Vinyl	Free	Tribeca								
Optic	Origin	Syntax	Habit									
Stitchery	Seed	Tradition	Hive									
Tectonic	Sockhop	Via	Lineup									
	Spin Seating		Manner									
	Whisper		Medium									
	Vinyl		Messenger									
			Metric									
			Oblique									
			Pick									
			Sprint									
			Technic									

Reference Fabric Color Combinations on pages 18-29 for color codes and legend on page 19 for lead times. Visit hon.com for additional partnership fabrics.

NOTES: Gathers and creases may be more visible with Attire (AI) and Optic (OP) fabrics due to the inherent design and construction of these fabrics.

🔥 For Fire Code model, availability and ordering method, refer to pages 34-39. Available on select models, contact HON Customer Support for availability.

* Fabric is de-emphasized.



MOTIVATE® Chair with Tablet Arm

HMG T1

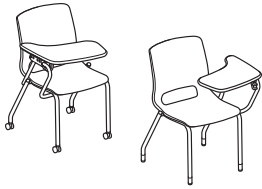

CHAIR

with Tablet Arm
Four Legs

DIMENSIONS

Depth:	30	Back Width:	17¼
Width:	21	Back Height:	18
Height:	32¼	Seat to Floor Height:	17¾
Seat Depth:	18¼	Tablet Height from Floor:	28¾
Seat Width:	17¾	Ship Weight:	41
		Cube:	18.4
		Weight Rating:	300 lbs.

LIST PRICE PER CARTON

\$420

NOTES: HMG T1 shells are CA Technical Bulletin 133 compliant (no upcharge). Tablet can be specified on right or left side.

HMG T2

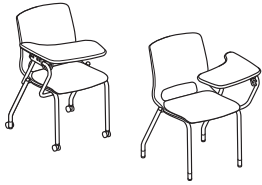

CHAIR

with Tablet Arm
Four Legs
Upholstered Seat

DIMENSIONS

Depth:	30	Back Width:	17¼
Width:	21	Back Height:	17½
Height:	32¼	Seat to Floor Height:	18¼
Seat Depth:	18¼	Tablet Height from Floor:	28¾
Seat Width:	17¾	Ship Weight:	43
		Cube:	18.4
		Weight Rating:	300 lbs.

FABRIC PRICE CODES

1	\$478	8	\$616
2	\$502	9	\$634
3	\$526	10	\$652
4	\$544	11	\$670
5	\$562	12	\$688
6	\$580	L	\$678
7	\$598		

NOTES: Tablet can be specified on right or left side.

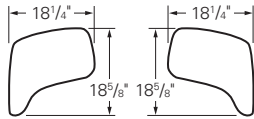

HON Recommendation: HMG T1.E.ON.RT.D.PLAT - List Price \$420

HOW TO SPECIFY

Select Model Number	Select Caster/Glide	Select Shell Color	Select Fabric	Select Tablet Side	Select Tablet Color	Select Frame
H Hard Caster S Soft Caster (+ \$20 per chair) E Standard Nylon Glide F Felt Glide (+ \$30 per chair) R Rubber Glide (+ \$30 per chair) T Steel Glide (+ \$30 per chair)	RG Tangelo CR Cherry LM Lime CP Calypso BU Surf RE Regatta MB Mulberry LO Loft PT Platinum SD Shadow LA Lava ON Onyx WT White	See page 182 <i>Not specified for HMG T1 models</i>	RT Right Side LT Left Side	T Black D Natural Maple	BLCK Textured Black PLAT Textured Platinum Metallic	
H M G T 1 .	E .	O N .		R T .	D .	P L A T
H M G T 2 .	E .	O N .	C U I 0 .	R T .	D .	P L A T

MOTIVATE®

Flex-Back Chair with Tablet Arm Options

MODEL OPTIONS

HMNT1



Flex-back with Tablet Arm

HMNT2



Flex-back with Tablet Arm
Upholstered Seat

CASTERS/ GLIDE



CODE	DESCRIPTION	PRICE
H	Hard Caster	+\$0



S	Soft Caster	+\$20
----------	-------------	--------------



E	Standard Nylon Glide	+\$0
----------	----------------------	-------------

TABLET SIDE



CODE	DESCRIPTION	PRICE
RT	Right Side	+\$0
LT	Left Side	+\$0



BACK STYLE



CODE	DESCRIPTION	PRICE
<i>Plastic/Upholstered Options:</i>		
PS	Plastic Shell	+\$0



PB	Upholstered	+\$70
-----------	-------------	--------------



ilira® - stretch M4 Options:

IM	Black	+\$80
IF	Fog	+\$80
IV	Vanilla	+\$80
IC	Charcoal	+\$80
IH	Chai	+\$80
IY	Navy	+\$80

TABLET COLOR

CODE	DESCRIPTION	PRICE
T	Black	+\$0
D	Natural Maple	+\$0

FRAME

CODE	DESCRIPTION	PRICE
BLCK	Textured Black	+\$0
PLAT	Textured Platinum Metallic	+\$0

PLASTIC SHELL COLOR CODES (no upcharge):

Tangelo - **RG**
Regatta - **RE**
Lava - **LA**

Cherry - **CR**
Mulberry - **MB**
Onyx - **ON**

Lime - **LM**
Loft - **LO**
White - **WT**

Calypso - **CP**
Platinum - **PT**

Surf - **BU**
Shadow - **SD**

MOTIVATE®

Flex-Back Chair with Tablet Arm Fabric Options

AVAILABLE FABRICS

GRADE 1	GRADE 2	GRADE 3	GRADE 4	GRADE 5	GRADE 6	GRADE 7	GRADE 8	GRADE 9	GRADE 10	GRADE 11	GRADE 12	GRADE L
Arrondi *	Appoint	Canter	Bar	Amuse	Intermix II	Ascend	Brisa®	Eli Vinyl	Affinity	Acrobat	Fenestra	Denver
Attire *	Seating	Polyurethane	Beeline	Avenue	Keynote	Central	Polyurethane	Martini Vinyl	Concentric	Natural	Helix	Leather
Centurion	Bangle	Epic	Blip	Lariat	Raffia Vinyl	Channel	Kindred	Olympus	Juxy	World	Lava	(Matches
Classic	Clyde	Infinity	Coin	Outlander	Velocity	Domain		Vinyl		Whirl	Ripple	EE Vinyl)
Compass	Dotty	Knack	Cover Cloth	Polka	Wooly	Waver		Silica				
Confetti	Esplanade *	Marathon	Current	Riddle				Silica Leather				
Contourette	Expo	Millennium	Decode	Sentry-HC				Silica Tech				
Polyurethane	Fuse	Odyssey	Disc	Sequence								
Dapper	Gio *	Silvertex™	Divide	Solace								
Inertia	Moguls	Vinyl	Free	Tribeca								
Optic	Origin	Syntax	Habit									
Stitchery	Seed	Tradition	Hive									
Tectonic	Sockhop	Via	Lineup									
	Spin Seating		Manner									
	Whisper		Medium									
	Vinyl		Messenger									
			Metric									
			Oblique									
			Pick									
			Sprint									
			Technic									

Reference Fabric Color Combinations on pages 18-29 for color codes and legend on page 19 for lead times. Visit hon.com for additional partnership fabrics.

NOTES: Gathers and creases may be more visible with Attire (AI) and Optic (OP) fabrics due to the inherent design and construction of these fabrics.

🔥 For Fire Code model, availability and ordering method, refer to pages 34-39. Available on select models, contact HON Customer Support for availability.

* Fabric is de-emphasized.

MOTIVATE® Flex-Back Chair with Tablet Arm

GSA SIN 711-18



HMNT1

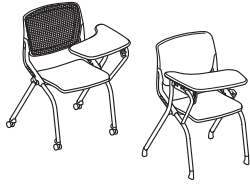

CHAIR

Flex-back with Tablet Arm

DIMENSIONS

Depth:	30 ³ / ₈	Seat to Floor Height:	18 ¹ / ₄
Width:	23 ¹ / ₂	Tablet Height from Floor:	29 ¹ / ₂
Height:	34	Ship Weight:	41
Seat Depth:	17 ¹ / ₄	Cube:	18.4
Seat Width:	17	Weight Rating:	300 lbs.
Back Width:	19 ¹ / ₂		
Back Height:	19		

LIST PRICE

\$576

NOTES: Add **"FC"** suffix to Model Number for CA Technical Bulletin 133 compliance. Shell available in Lava (LA) only. See pages 34-39. Add upcharge of \$40 per carton to graded price. Tablet can be specified on right or left side.

! Model HMNT1 is not available with an upholstered back. CA Technical Bulletin 133 compliant shells available in LA-Lava ONLY, ordering instructions below.

HMNT2

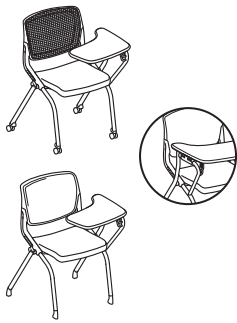

CHAIR

Flex-back with Tablet Arm
Upholstered Seat

DIMENSIONS

Depth:	30 ³ / ₈	Seat to Floor Height:	19 ¹ / ₄
Width:	23 ¹ / ₂	Tablet Height from Floor:	29 ¹ / ₂
Height:	34	Ship Weight:	42
Seat Depth:	17 ⁵ / ₈	Cube:	18.4
Seat Width:	17 ³ / ₈	Weight Rating:	300 lbs.
Back Width:	19 ¹ / ₂		
Back Height:	18 ³ / ₈		

FABRIC PRICE CODES

1	\$637	8	\$775
2	\$661	9	\$793
3	\$685	10	\$811
4	\$703	11	\$829
5	\$721	12	\$847
6	\$739	L	\$837
7	\$757		

NOTES: Tablet can be specified on right or left side.

! CA Technical Bulletin 133 compliant shells available in LA-Lava ONLY, ordering instructions below.

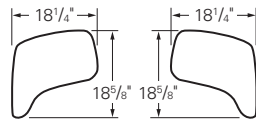

HON Recommendation: HMNT1.E.IM.ON.RT.D.PLAT - List Price \$656

HOW TO SPECIFY

Select Model Number	Select Caster/Glide	Select Back Type	Select Shell Color	Select Fabric	Select Tablet Side	Select Tablet Color	Select Frame
E Standard Nylon Guide H Hard Caster S Soft Caster (+ \$20)	PS Plastic Shell PB Upholstered (+ \$70) <i>PB option not available on HMNT1</i> ilira®-stretch M4 options (+ \$80) IM Black IF Fog IV Vanilla IC Charcoal IH Chai IY Navy	RG Tangelo CR Cherry LM Lime CP Calypso BU Surf RE Regatta MB Mulberry LO Loft PT Platinum SD Shadow LA Lava ON Onyx WT White	See page 185 <i>Specify for model HMNT2 only</i>	RT Right Side LT Left Side	T Black D Natural Maple	BLCK Textured Black PLAT Textured Platinum Metallic	
HMNT1	E	IM	ON		RT	D	PLAT
HMNT2	E	PB	ON	CU10	RT	D	PLAT

NUCLEUS®



Nucleus Work Chairs shown with Preside® Conference Table.

NUCLEUS®

Enjoy seating that delivers comfort from the inside out. Nucleus task and guest chairs adapt to everyone's unique body types to create a custom fit and targeted support. The back flexes with the spine. The seat cradles you like a hammock. The sophisticated aesthetic makes a stylish statement. Nucleus is the powerhouse seating family that brings cool and comfortable together.



TASK CHAIR FEATURES

- Advanced suspension material in the seat combines with memory foam to create unparalleled support.
- Choose between the ilira®-stretch M4 mesh back or an upholstered suspension back.
- ilira®-stretch mesh back is available in three colors.
- Choose between armless, fixed arms or height- and width-adjustable arms.
- Responsive synchro-tilt control provides a smooth, natural recline.
- Available in Black or Polished Aluminum base.
- Tilt tension controls the rate and ease of recline.
- Tilt lock allows the user to lock out the tilt function.
- 360-degree swivel provides freedom of movement in any direction.
- Available in hundreds of quality HON fabrics.
- Warranted for users up to 300 lbs.

GUEST CHAIR FEATURES

- Stacking chairs stack up to six high on the floor.
- Choose between glides, soft casters or hard casters.
- All surface caster available on Model HN6.
- Available in hundreds of quality HON fabrics.
- Warranted for users up to 300 lbs.

NUCLEUS® Task Chair Options

MODEL OPTIONS

HN1



Task Chair (ilira®-stretch M4 Back)

Pneumatic, Swivel, Seat Glide, Synchro-tilt, Tilt Tension, Tilt Lock, Armless

HN1U



Task Chair (Upholstered Back)

Pneumatic, Swivel, Seat Glide, Synchro-tilt, Tilt Tension, Tilt Lock, Armless

ARM STYLE

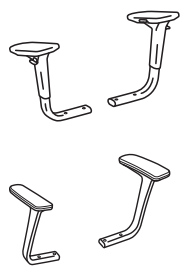

CODE	DESCRIPTION	PRICE
N	Armless	+\$0
A	Height and Width Adjustable Arms	+\$75
P	Fixed Arms - Polished	+\$150

CASTERS



CODE	DESCRIPTION	PRICE
H	Hard Caster	+\$0
S	Soft Caster	+\$30

BACK STYLE

CODE	DESCRIPTION	PRICE
<i>ilira®-stretch mesh back options:</i>		
IM	Black	+\$0
IF	Fog	+\$0
IV	Vanilla	+\$0
IC	Charcoal	+\$0
IH	Chai	+\$0
IY	Navy	+\$0

BASE

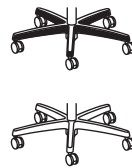

CODE	DESCRIPTION	PRICE
SB	Standard Base	+\$0
PA	Polished Aluminum	+\$110

FRAME

CODE	DESCRIPTION	PRICE
T	Black	+\$0

NUCLEUS® Multi-Purpose and Café Chair Options

MODEL OPTIONS

HN6



**Multi-purpose Stack Chair
(ilira®-stretch M4 Back)**

Four Legs

HN7



**Café-Height Stool (ilira®-stretch
M4 Back)**

Four Legs

ARM STYLE



CODE	DESCRIPTION	PRICE
N	Armless	+\$0
F	Fixed Arms	+\$30

CASTERS/ GLIDE



CODE	DESCRIPTION	PRICE
H	Hard Caster <i>*Not available on HN7</i>	+\$0



S	Soft Caster <i>*Not available on HN7</i>	+\$20
----------	---	--------------



E	Glide	+\$0
----------	-------	-------------

BACK STYLE

CODE	DESCRIPTION	PRICE
<i>ilira®-stretch mesh back options:</i>		
IM	Black	+\$0
IF	Fog	+\$0
IV	Vanilla	+\$0
IC	Charcoal	+\$0
IH	Chai	+\$0
IY	Navy	+\$0

FRAME

CODE	DESCRIPTION	PRICE
T	Black	+\$0
T1	Platinum Metallic	+\$0

NUCLEUS® Fabric Options

AVAILABLE FABRICS

GRADE 1	GRADE 2	GRADE 3	GRADE 4	GRADE 5	GRADE 6	GRADE 7	GRADE 8	GRADE 9	GRADE 10	GRADE 11	GRADE 12	GRADE L
Arrondi *	Appoint	Canter	Bar	Amuse	Intermix II	Ascend	Brisa®	Eli Vinyl	Affinity	Acrobat	Fenestra	Denver
Attire *	Seating	Polyurethane	Beeline	Avenue	Keynote	Central	Polyurethane	Martini Vinyl	Concentric	Natural	Helix	Leather
Centurion	Bangle	Epic	Blip	Lariat	Raffia Vinyl	Channel	Kindred	Olympus	Juxy	World	Lava	(Matches
Compass	Clyde	Infinity	Coin	Outlander	Velocity	Domain		Vinyl		Whirl	Ripple	EE Vinyl)
Confetti	Dotty	Knack	Cover Cloth	Polka	Wooly	Synergy		Silica				
Contourette	Esplanade *	Marathon	Current	Riddle		Waver		Silica Leather				
Polyurethane	Expo	Millennium	Decode	Sentry-HC				Silica Tech				
Dapper	Fuse	Odyssey	Disc	Sequence								
Inertia	Gio *	Silvertext™	Divide	Solace								
Optic	Moguls *	Vinyl	Free	Tribeca								
Stitchery	Origin	Syntax	Habit									
Tectonic	Seed	Tradition	Hive									
	Sockhop	Via	Lineup									
	Spin Seating		Manner									
	Whisper		Medium									
	Vinyl		Messenger									
			Metric									
			Oblique									
			Pick									
			Sprint									
			Technic									

Reference Fabric Color Combinations on pages 18-29 for color codes and legend on page 19 for lead times. Visit hon.com for additional partnership fabrics.

NOTES: Gathers and creases may be more visible with Attire (AI) and Optic (OP) fabrics due to the inherent design and construction of these fabrics. For additional HON to Supply COM fabric grade pricing, go to honready.hon.com and click on the HON to Supply COM link.

🔥 For Fire Code model, availability and ordering method, refer to pages 34-39. Available on select models, contact HON Customer Support for availability.

* Fabric is de-emphasized.



HN1



TASK CHAIR

ilira®-stretch M4 Back

- Pneumatic
- Swivel
- Seat Glide
- Synchro-tilt
- Tilt Tension
- Tilt Lock
- Armless

Functions:

A, D, E, A-C, A-D, J, L

(Function Key on pages 16-17)

HON Recommendation: HN1.A.H.IM.CU__SB.T - List Price \$863

DIMENSIONS

Depth:	25¾	Arm Width:	17-20
Width:	28¾	Seat to Floor Height:	17-22
Height:	45¼	Usable Seat Depth:	16½-19
Seat Depth:	20	Ship Weight:	52 Ⓢ
Seat Width:	20	Cube:	11.3
Back Width:	19¼	COM:	1.0
Back Height:	25¼	Weight Rating:	300 lbs.

FABRIC PRICE CODES

1	\$788	8	\$926
2	\$812	9	\$944
3	\$836	10	\$962
4	\$854	11	\$980
5	\$872	12	\$998
6	\$890	L	\$988
7	\$908		

HOW TO SPECIFY

Select Model Number	Select Arm Type	Select Caster/Glide	Select Back Type	Select Fabric	Select Base	Select Frame
	N Armless A Height and Width Adjustable Arms (+ \$75) P Fixed Arms - Polished (+ \$150)	H Hard Caster S Soft Caster (+ \$30)	ilira®-stretch options IM Black IF Fog IV Vanilla IC Charcoal IH Chai IY Navy	See page 190	SB Standard Base PA Polished Aluminum (+ \$110)	See page 188 T Black
HN1	A	H	IM	CU10	SB	T

HN1U



TASK CHAIR

Upholstered Back

- Pneumatic
- Swivel
- Seat Glide
- Synchro-tilt
- Tilt Tension
- Tilt Lock
- Armless

Functions:

A, D, E, A-C, A-D, J, L

(Function Key on pages 16-17)

HON Recommendation: HN1U.A.H.CU__SB.T - List Price \$863

DIMENSIONS

Depth:	26	Arm Width:	19½
Width:	28¾	Seat to Floor Height:	17-22
Height:	44¼	Usable Seat Depth:	16-18½
Seat Depth:	20	Ship Weight:	49
Seat Width:	20	Cube:	12.6
Back Width:	18¼	COM:	2.0
Back Height:	25½	Weight Rating:	300 lbs.

FABRIC PRICE CODES

1	\$788	8	\$1064
2	\$836	9	\$1100
3	\$884	10	\$1136
4	\$920	11	\$1172
5	\$956	12	\$1208
6	\$992	L	\$1188
7	\$1028		

HOW TO SPECIFY

Select Model Number	Select Arm Type	Select Caster/Glide	Select Fabric	Select Base	Select Frame
	N Armless A Height and Width Adjustable Arms (+ \$75) P Fixed Arms - Polished (+ \$150)	H Hard Caster S Soft Caster (+ \$30)	See page 190	SB Standard Base PA Polished Aluminum (+ \$110)	See page 188 T Black
HN1U	A	H	CU10	SB	T

NUCLEUS®



HN6

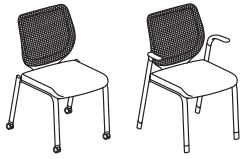

SIN 711-19

MULTI-PURPOSE STACK CHAIR

ilira®-stretch M4 Back
Four Legs



DIMENSIONS

Depth:	26¼	Arm Width:	21½
Width:	27	Seat to Floor Height:	18½
Height:	37⅞	Usable Seat Depth:	18½
Seat Depth:	19	Ship Weight:	31
Seat Width:	19	Cube:	15.2
Back Width:	18	COM:	1.0
Back Height:	18½	Weight Rating:	300 lbs.

FABRIC PRICE CODES

1	\$492	8	\$630
2	\$516	9	\$648
3	\$540	10	\$666
4	\$558	11	\$684
5	\$576	12	\$702
6	\$594	L	\$692
7	\$612		

HN7

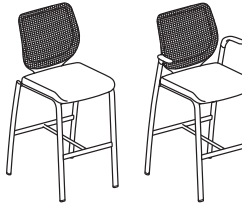

SIN 711-18

CAFÉ-HEIGHT STOOL

ilira®-stretch M4 Back
Four Legs



DIMENSIONS

Depth:	24½	Arm Width:	21½
Width:	25	Seat to Floor Height:	30
Height:	46½	Usable Seat Depth:	18½
Seat Depth:	19	Ship Weight:	40
Seat Width:	19	Cube:	21.4
Back Width:	18	COM:	1.0
Back Height:	18½	Weight Rating:	300 lbs.

FABRIC PRICE CODES

1	\$536	8	\$674
2	\$560	9	\$692
3	\$584	10	\$710
4	\$602	11	\$728
5	\$620	12	\$746
6	\$638	L	\$736
7	\$656		

HON Recommendation: HN6.F.H.IM.CU__T - List Price \$522

HOW TO SPECIFY

Select Model Number 	Select Arm Type F Fixed Arms (+ \$30) N Armless	Select Caster/Glide E Glide H Hard Caster S Soft Caster (+ \$20) <i>Casters available on HN6 only</i>	Select Back Type ilira®-stretch options IM Black IF Fog IV Vanilla IC Charcoal IH Chai IY Navy	Select Fabric See page 190	Select Frame T Black T1 Platinum Metallic
------------------------------------	--	---	--	--------------------------------------	--

HNATA

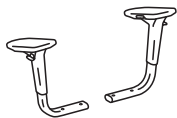

SIN 711-18

ADJUSTABLE ARM PACK

Height and Width
Functions: **S**
(Function Key on pages 16-17)

DIMENSIONS

Arm Width:	17-20
Height from Seat:	6⅞-10⅞
Ship Weight:	7.5 Ⓢ
Cube:	1.0

LIST PRICE

\$114

HNFPA



OM

POLISHED ALUMINUM ARM PACK

Fixed Height

DIMENSIONS

Arm Width:	19⅞
Height from Seat:	7¼
Ship Weight:	7.5 Ⓢ
Cube:	1.0

LIST PRICE

\$180

HOW TO SPECIFY

Select Model Number

HIGH-DENSITY OLSON STACKER® 4040 SERIES



Olson Stacker.

HIGH-DENSITY OLSON STACKER® 4040 SERIES

Adaptable spaces such as multipurpose and training areas demand a chair equally flexible. Olson stacking chairs fit that bill with a lightweight frame that is easy to move throughout a space. Chairs stack up to 12 high on the floor or up to 40 high on their specially designed cart to maximize floor space when not in use. A convenient cutout in the back makes it easy to pick up and move, while the molded seat shells deliver surprising comfort. Olson stacking chairs ship in sets of four to accommodate large groups. With Olson, the benefits really stack up.



FEATURES

- Chairs ship four per carton.
- Contoured seat and back shell provide targeted support.
- Integrated lumbar support delivers long-lasting comfort.
- Integrated handle makes chair easy to carry.
- Optional ganging brackets connect chairs to form neat rows.
- Stacks up to 12 high without cart.
- Stacks up to 40 high on cart.
- Shell colors are CA Technical Bulletin 133 compliant.
- Warranted for users up to 300 lbs.

HIGH-DENSITY OLSON STACKER® 4040 Series

GSA SIN 711-19



Icon Legend on page 14

H4041



POLYMER SEAT AND BACK DIMENSIONS

7/16" Steel Rod Frame
Chrome Legs

Depth:	21 5/8	Seat to Floor Height:	17 3/4
Width:	19 1/8	Usable Seat Depth:	17
Height:	30 3/8	Ship Weight:	57 Ⓢ
Seat Depth:	18 1/4	Cube:	10.6
Seat Width:	17 3/4	Weight Rating:	300 lbs.
Back Width:	17 1/2		
Back Height:	16 1/4		

LIST PRICE PER CARTON

\$652
(reference single unit @ \$163.00)

- 📦 4040 Series is ordered and shipped four (4) chairs per carton. Pricing shown is per carton. Each set of four (one carton), must have the same shell color. Ordering 2 of Model H4041 will result in 2 cartons being shipped, giving you 8 chairs.
- ⚠ Shipped fully assembled — 4 chairs per carton. All High Density Olson Stacker® shell colors are CA Technical Bulletin 133 compliant (no upcharge).
- 🔥 For Fire Code model, availability and ordering method, refer to pages 34-39.

H4043



CART FOR STACKING CHAIRS

DIMENSIONS

Depth:	35 1/2	Ship Weight:	34 Ⓢ
Width:	21 3/8	Cube:	7.8
Height:	37		

LIST PRICE

\$454

- NOTES: Holds 40 stack chairs (6'-8"), some assembly required. (Chairs stack 12 high without cart.)
⚠ Specify Black paint (T) ONLY.

H4048

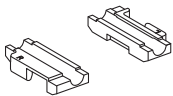

GANGING CHAIR GLIDES

DIMENSIONS

Box of 48	Ship Weight:	1 Ⓢ
For use on models H4041, HG51 and HG52	Cube:	0.04

LIST PRICE

\$112

H4049

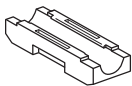

NON-GANGING CHAIR GLIDES

DIMENSIONS

Box of 48	Ship Weight:	1 Ⓢ
For use on models H4041, HFLEX01, HG51 and HG52	Cube:	0.04

LIST PRICE

\$88

HOW TO SPECIFY

<p>Select Model Number</p> <div style="border: 1px solid #ccc; padding: 5px; margin-top: 10px;"> H 4 0 4 1 </div>	<p>Select Shell Color</p> <table border="0" style="width: 100%;"> <tr> <td>RG Tangelo</td> <td>LO Loft</td> </tr> <tr> <td>CR Cherry</td> <td>PT Platinum</td> </tr> <tr> <td>LM Lime</td> <td>SD Shadow</td> </tr> <tr> <td>CP Calypso</td> <td>LA Lava</td> </tr> <tr> <td>BU Surf</td> <td>ON Onyx</td> </tr> <tr> <td>RE Regatta</td> <td>WT White</td> </tr> <tr> <td>MB Mulberry</td> <td></td> </tr> </table> <div style="border: 1px solid #ccc; padding: 5px; margin-top: 10px;"> O N </div>	RG Tangelo	LO Loft	CR Cherry	PT Platinum	LM Lime	SD Shadow	CP Calypso	LA Lava	BU Surf	ON Onyx	RE Regatta	WT White	MB Mulberry		<p>Select Frame</p> <p>Y Chrome</p> <div style="border: 1px solid #ccc; padding: 5px; margin-top: 10px;"> Y </div>
RG Tangelo	LO Loft															
CR Cherry	PT Platinum															
LM Lime	SD Shadow															
CP Calypso	LA Lava															
BU Surf	ON Onyx															
RE Regatta	WT White															
MB Mulberry																

PAGODA®



Pagoda Guest Chairs
and Café Stools.

PAGODA®

Roll out the welcome mat with Pagoda guest chairs. Reception areas. Private offices. Anywhere in between. Pagoda is a coordinated, versatile collection of stacking chairs and stools that easily match any environment and offer comfort for any type of activity. Standard-height chairs stack up to five high to clear valuable floor space whenever needed. Counter-height stools are great for cafés or common areas. Wherever comfort and style are equally important, Pagoda will create the look and feel you need.



FEATURES

- Guest chairs stack up to five high on the floor.
- Fully-upholstered outer back.
- Molded seat underpan protects seat fabric and creates a finished appearance when stacked.
- Optional fixed arms are gently sloped for maximum comfort.
- Tube rolled steel frame adds durability.
- Create a contemporary mixed material aesthetic.
- Optional wood veneer back is available in five attractive finishes.
- Available in hundreds of quality HON fabrics.
- Warranted for users up to 250 lbs.

PAGODA® Options

MODEL OPTIONS

H4071



Stacking Arm Guest Chairs

Set of Two

H4073



Stacking Armless Guest Chairs

Set of Two

H4075



Stacking Arm Guest Chairs

Set of Two

H4077



Mobile Stacking Armless Guest Chairs

Set of Two

H4091



**Stacking Arm Guest Chairs
(Wood Back)**

Set of Two

H4093



**Stacking Armless Guest Chairs
(Wood Back)**

Set of Two

H4095



**Stacking Arm Guest Chairs
(Wood Back)**

Set of Two

H4097



**Mobile Stacking Armless Guest
Chairs (Wood Back)**

Set of Two

H4099



**Café-Height Stool
(Wood Back)**

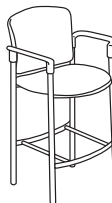

Footrest, Arms

H4079



**Café-Height Stool
(Upholstered Back)**

Footrest, Arms

CASTERS				FINISH			
	CODE	DESCRIPTION	PRICE		CODE	DESCRIPTION	PRICE
	H	Hard Caster	+\$0		C	Harvest	+\$0
	S	Soft Caster	+\$20		D	Natural Maple	+\$0
					F	Shaker Cherry	+\$0
					H	Bourbon Cherry	+\$0
					N	Mahogany	+\$0

**Specify for models H4075 and H4077 only*

**Specify for models H4091, H4093, H4095, H4097 and H4099 only*

FRAME			
	CODE	DESCRIPTION	PRICE
	T	Black	+\$0
	T1	Platinum Metallic	+\$0

AVAILABLE FABRICS

GRADE 1	GRADE 2	GRADE 3	GRADE 4	GRADE 5	GRADE 6	GRADE 7	GRADE 8	GRADE 9	GRADE 10	GRADE 11	GRADE 12	GRADE L
Arrondi *	Appoint Seating	Canter Polyurethane	Bar	Amuse	Intermix II	Ascend	Brisa® Polyurethane	Eli Vinyl	Affinity	Acrobat	Fenestra	
Attire	Bangle	Epic	Beeline	Avenue	Keynote	Central	Kindred	Martini Vinyl	Concentric	Natural World	Helix	
Centurion	Clyde	Infinity	Blip	Lariat	Raffia Vinyl	Channel		Olympus Vinyl	Juxy	Whirl	Lava	
Classic	Dotty	Knack	Coin	Outlander	Velocity	Domain		Silica			Ripple	
Compass	Esplanade *	Marathon	Cover Cloth	Polka	Wooly	Synergy		Silica Leather				
Confetti	Expo	Millennium	Current	Riddle		Waver		Silica Tech				
Contourette	Fuse	Odyssey	Decode	Sentry-HC								
Polyurethane	Gio *	Silvertex™ Vinyl	Disc	Sequence								
Dapper	Moguls	Syntax	Divide	Solace								
Inertia	Origin	Tradition	Habit	Tribeca								
Optic	Seed	Via	Hive									
Sierra Vinyl	Sockhop		Lineup									
Stitchery	Spin Seating		Manner									
Tectonic	Whisper Vinyl		Medium									
			Messenger									
			Metric									
			Oblique									
			Pick									
			Sprint									
			Technic									

**Pagoda® wood back models available in Harvest (C), Natural Maple (D), Shaker Cherry (F), Bourbon Cherry (H) and Mahogany (N) only.

Reference Fabric Color Combinations on pages 18-29 for color codes and legend on page 19 for lead times. Visit hon.com for additional partnership fabrics.

NOTES: Gathers and creases may be more visible with Attire (AI) and Optic (OP) fabrics due to the inherent design and construction of these fabrics. For additional HON to Supply COM fabric grade pricing, go to honready.hon.com and click on the HON to Supply COM link.

 For Fire Code model, availability and ordering method, refer to pages 34-39. Available on select models, contact HON Customer Support for availability.

 Fabric is de-emphasized.

PAGODA® 4070 Series

GSA SIN 711-19



Icon Legend on page 14

H4071



STACKING ARM GUEST CHAIRS

Set of Two

DIMENSIONS

Depth:	22½	Arm Width:	23¾
Width:	27¼	Seat to Floor Height:	18
Height:	33	Usable Seat Depth:	16¾
Seat Depth:	19¾	Ship Weight:	56
Seat Width:	20¼	Cube:	19.6
Back Width:	21¼	COM:	2.0
Back Height:	16¼	Weight Rating:	250 lbs.

FABRIC PRICE CODES

	Per Carton List Price	Single Unit List Price
1	\$741	\$370.50
2	\$789	\$394.50
3	\$837	\$418.50
4	\$873	\$436.50
5	\$909	\$454.50
6	\$945	\$472.50
7	\$981	\$490.50
8	\$1017	\$508.50
9	\$1053	\$526.50
10	\$1089	\$544.50
11	\$1125	\$562.50
12	\$1161	\$580.50
L	—	—

NOTES: Use Model H4069 Ganging Connectors on page 202. Ships two to a container. See shipping notes on page 199.

H4073



STACKING ARMLESS GUEST CHAIRS

Set of Two

DIMENSIONS

Depth:	22½	Seat to Floor Height:	18
Width:	21¼	Usable Seat Depth:	16¾
Height:	33	Ship Weight:	52
Seat Depth:	19¾	Cube:	18.9
Seat Width:	20¼	COM:	2.0
Back Width:	21¼	Weight Rating:	250 lbs.
Back Height:	16¼		

FABRIC PRICE CODES

	Per Carton List Price	Single Unit List Price
1	\$691	\$345.50
2	\$739	\$369.50
3	\$787	\$393.50
4	\$823	\$411.50
5	\$859	\$429.50
6	\$895	\$447.50
7	\$931	\$465.50
8	\$967	\$483.50
9	\$1003	\$501.50
10	\$1039	\$519.50
11	\$1075	\$537.50
12	\$1111	\$555.50
L	—	—

NOTES: Use Model H4069 Ganging Connectors on page 202. Ships two to a container. See shipping notes on page 199.

HOW TO SPECIFY

Select
Model Number

H 4 0 7 1 .

Select
Fabric

See page 197

C U 1 0 .

Select
Frame

T Black
T1 Platinum Metallic

T



PAGODA® 4070 Series

H4075



STACKING ARM GUEST CHAIRS

Set of Two

DIMENSIONS

Depth:	22½	Arm Width:	23¾
Width:	27¼	Seat to Floor Height:	18
Height:	33	Usable Seat Depth:	16¾
Seat Depth:	19¾	Ship Weight:	56
Seat Width:	20¼	Cube:	19.6
Back Width:	21¼	COM:	2.0
Back Height:	16¼	Weight Rating:	250 lbs.

FABRIC PRICE CODES

	Per Carton List Price	Single Unit List Price
1	\$831	\$415.50
2	\$879	\$439.50
3	\$927	\$463.50
4	\$963	\$481.50
5	\$999	\$499.50
6	\$1035	\$517.50
7	\$1071	\$535.50
8	\$1107	\$553.50
9	\$1143	\$571.50
10	\$1179	\$589.50
11	\$1215	\$607.50
12	\$1251	\$625.50
L	—	—

H4077



MOBILE STACKING ARMLESS GUEST CHAIRS

Set of Two

DIMENSIONS

Depth:	22½	Seat to Floor Height:	18
Width:	21¼	Usable Seat Depth:	16¾
Height:	33	Ship Weight:	56
Seat Depth:	19¾	Cube:	19.5
Seat Width:	20¼	COM:	2.0
Back Width:	21¼	Weight Rating:	250 lbs.
Back Height:	16¼		

FABRIC PRICE CODES

	Per Carton List Price	Single Unit List Price
1	\$781	\$390.50
2	\$829	\$414.50
3	\$877	\$438.50
4	\$913	\$456.50
5	\$949	\$474.50
6	\$985	\$492.50
7	\$1021	\$510.50
8	\$1057	\$528.50
9	\$1093	\$546.50
10	\$1129	\$564.50
11	\$1165	\$582.50
12	\$1201	\$600.50
L	—	—

i 4070 Series is ordered and shipped two (2) chairs per carton. Pricing shown is per carton. Each set of two (one carton), must have the same fabric/frame color. (COM yardage shown is for two chairs.) Ordering 2 of any model will result in 2 cartons being shipped, giving you 4 chairs.

HOW TO SPECIFY

Select Model Number	Select Caster	Select Fabric	Select Frame
	H Hard Caster S Soft Caster (+ \$20) <i>Specify for models H4075 and H4077 only</i>	See page 197	T Black T1 Platinum Metallic
H 4 0 7 5 .	H .	C U 1 0 .	T

PAGODA® 4090 Series

GSA SIN 711-19



Icon Legend on page 14

H4091



STACKING ARM GUEST CHAIRS

Wood Back
Set of Two

DIMENSIONS

Depth:	22½	Arm Width:	23¾
Width:	27¼	Seat to Floor Height:	18
Height:	32½	Usable Seat Depth:	16¾
Seat Depth:	19¾	Ship Weight:	51
Seat Width:	20¼	Cube:	19.6
Back Width:	21¼	COM:	1.0
Back Height:	16¼	Weight Rating:	250 lbs.

FABRIC PRICE CODES

	Per Carton	Single Unit
	List Price	List Price
1	\$862	\$431.00
2	\$886	\$443.00
3	\$910	\$455.00
4	\$928	\$464.00
5	\$946	\$473.00
6	\$964	\$482.00
7	\$982	\$491.00
8	\$1000	\$500.00
9	\$1018	\$509.00
10	\$1036	\$518.00
11	\$1054	\$527.00
12	\$1072	\$536.00
L	—	—

NOTES: Use Model H4069 Ganging Connectors on page 202.
 ⓘ Ships two per carton. See note on page 201 for ordering.

H4093



STACKING ARMLESS GUEST CHAIRS

Wood Back
Set of Two

DIMENSIONS

Depth:	22½	Seat to Floor Height:	18
Width:	21¼	Usable Seat Depth:	16¾
Height:	32½	Ship Weight:	49
Seat Depth:	19¾	Cube:	18.9
Seat Width:	20¼	COM:	1.0
Back Width:	20½	Weight Rating:	250 lbs.
Back Height:	16¼		

FABRIC PRICE CODES

	Per Carton	Single Unit
	List Price	List Price
1	\$812	\$406.00
2	\$836	\$418.00
3	\$860	\$430.00
4	\$878	\$439.00
5	\$896	\$448.00
6	\$914	\$457.00
7	\$932	\$466.00
8	\$950	\$475.00
9	\$968	\$484.00
10	\$986	\$493.00
11	\$1004	\$502.00
12	\$1022	\$511.00
L	—	—

NOTES: Use Model H4069 Ganging Connectors on page 202.
 ⓘ Ships two per carton. See note on page 201 for ordering.

ⓘ Pagoda® wood back models available in Harvest (C), Natural Maple (D), Shaker Cherry (F), Bourbon Cherry (H) and Mahogany (N) only.

HOW TO SPECIFY

<p>Select Model Number</p> <p style="text-align: center;">H 4 0 9 1 .</p>	<p>Select Finish Color</p> <p style="text-align: center;">See page 197</p> <p style="text-align: center;">H .</p>	<p>Select Fabric</p> <p style="text-align: center;">See page 197</p> <p style="text-align: center;">C U 1 0 .</p>	<p>Select Frame</p> <p>T Black T1 Platinum Metallic</p> <p style="text-align: center;">T</p>
--	--	--	---



H4095



STACKING ARM GUEST CHAIRS

Wood Back
Set of Two

DIMENSIONS

Depth:	22½	Arm Width:	23¾
Width:	27¼	Seat to Floor Height:	18
Height:	32½	Usable Seat Depth:	16¾
Seat Depth:	19¾	Ship Weight:	53
Seat Width:	20¼	Cube:	19.6
Back Width:	20½	COM:	1.0
Back Height:	16¼	Weight Rating:	250 lbs.

FABRIC PRICE CODES

	Per Carton List Price	Single Unit List Price
1	\$952	\$476.00
2	\$976	\$488.00
3	\$1000	\$500.00
4	\$1018	\$509.00
5	\$1036	\$518.00
6	\$1054	\$527.00
7	\$1072	\$536.00
8	\$1090	\$545.00
9	\$1108	\$554.00
10	\$1126	\$563.00
11	\$1144	\$572.00
12	\$1162	\$581.00
L	—	—

! Ships two per carton. See note below for ordering.

H4097



MOBILE STACKING ARMLESS GUEST CHAIRS

Wood Back
Set of Two

DIMENSIONS

Depth:	22½	Seat to Floor Height:	18
Width:	21¼	Usable Seat Depth:	16¾
Height:	32½	Ship Weight:	51
Seat Depth:	19¾	Cube:	19.6
Seat Width:	20¼	COM:	1.0
Back Width:	20½	Weight Rating:	250 lbs.
Back Height:	16¼		

FABRIC PRICE CODES

	Per Carton List Price	Single Unit List Price
1	\$902	\$451.00
2	\$926	\$463.00
3	\$950	\$475.00
4	\$968	\$484.00
5	\$986	\$493.00
6	\$1004	\$502.00
7	\$1022	\$511.00
8	\$1040	\$520.00
9	\$1058	\$529.00
10	\$1076	\$538.00
11	\$1094	\$547.00
12	\$1112	\$556.00
L	—	—

! Ships two per carton. See note below for ordering.

- ! 4090 Series is ordered and shipped two (2) chairs per carton. Pricing shown is per carton. Each set of two (one carton), must have the same fabric/frame color. (COM yardage shown is for two chairs.) Ordering 2 of any model will result in 2 cartons being shipped, giving you 4 chairs.
- ! Pagoda® wood back models available in Harvest (C), Natural Maple (D), Shaker Cherry (F), Bourbon Cherry (H) and Mahogany (N) only.

HOW TO SPECIFY

<p>Select Model Number</p> <p>H 4 0 9 5 .</p>	<p>Select Finish Color</p> <p>See page 197</p> <p>H .</p>	<p>Select Fabric</p> <p>See page 197</p> <p>C U 1 0 .</p>	<p>Select Frame</p> <p>T Black T1 Platinum Metallic</p> <p>T</p>
--	--	--	---

PAGODA® 4070/4090 Series

GSA SIN 711-19



Icon Legend on page 14

H4099

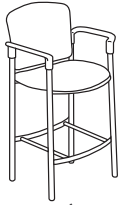

CAFÉ-HEIGHT STOOL

Wood Back
Footrest
Arms

DIMENSIONS

Depth:	22½	Arm Width:	23¾
Width:	27¼	Seat to Floor Height:	29¾
Height:	44⅝	Usable Seat Depth:	16¾
Seat Depth:	19¾	Ship Weight:	34
Seat Width:	20¼	Cube:	19.3
Back Width:	20½	COM:	1.0
Back Height:	16¼	Weight Rating:	250 lbs.

FABRIC PRICE CODES

Single Unit List Price

1	\$555.00
2	\$579.00
3	\$603.00
4	\$621.00
5	\$639.00
6	\$657.00
7	\$675.00
8	\$693.00
9	\$711.00
10	\$729.00
11	\$747.00
12	\$765.00
L	—

NOTES: Model H4099 is ordered and shipped one (1) per carton.

H4079

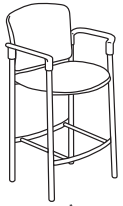

CAFÉ-HEIGHT STOOL

Upholstered Back
Footrest
Arms

DIMENSIONS

Depth:	22½	Arm Width:	23¾
Width:	27¼	Seat to Floor Height:	29¾
Height:	44⅝	Usable Seat Depth:	16¾
Seat Depth:	19¾	Ship Weight:	39
Seat Width:	20¼	Cube:	19.3
Back Width:	21¼	COM:	2.0
Back Height:	16¼	Weight Rating:	250 lbs.

FABRIC PRICE CODES

Single Unit List Price

1	\$483.00
2	\$531.00
3	\$579.00
4	\$615.00
5	\$651.00
6	\$687.00
7	\$723.00
8	\$759.00
9	\$795.00
10	\$831.00
11	\$867.00
12	\$903.00
L	—

NOTES: Upholstered back. Model H4079 is ordered and shipped one (1) per carton.

H4069



GANGING CONNECTORS

(hardware included)

DIMENSIONS

Ship Weight:	2 Ⓢ
Cube:	0.05

LIST PRICE

\$55.00

NOTES: Specify Chairs frame color: Black (T)
 ⓘ For use on models H4071, H4073, H4091 and H4093.

HUCART

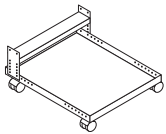

UNIVERSAL 4-LEG CHAIR CART

DIMENSIONS

Depth:	22	Ship Weight:	24 Ⓢ
Width:	22	Cube:	2.0
Height:	8		

LIST PRICE

\$357.00

NOTES: Steel frame construction. 4 casters — 2 locking, 2 non-locking.
 ⓘ For use with models H4071, H4073, H4075, H4077. Black only.

HOW TO SPECIFY

<p>Select Model Number</p> <p>See page 197</p> <p><i>Specify for model H4099 only</i></p> <p>H 4 0 7 9 .</p> <p>H 4 0 9 9 .</p>	<p>Select Finish Color</p> <p>See page 197</p> <p><i>Specify for model H4099 only</i></p> <p>H .</p>	<p>Select Fabric</p> <p>See page 197</p> <p>CU10 .</p> <p>CU10 .</p>	<p>Select Frame</p> <p>T Black</p> <p>T1 Platinum Metallic</p> <p>T</p> <p>T</p>
--	---	---	---

PARK AVENUE COLLECTION® 5000 SERIES



Park Avenue Collection Executive High-Back Chair shown with Park Avenue Collection Laminate desks.

PARK AVENUE COLLECTION® 5000 SERIES

Park Avenue seating is your address for elegance. This family of task and guest seating features all-day comfort with upscale accents. Task chairs feature a choice of Polished Aluminum or Black frame with inlaid wood accents, as well as an elegant tuxedo back design that creates a sophisticated look. Guest seating welcomes visitors in style and leaves a lasting impression. If you're looking to put yourself, your coworkers and your visitors at ease, make a move to Park Avenue.



GUEST CHAIR FEATURES

- Fully-upholstered outer back.
- Backs feature sewn seams for a tailored look.
- Solid hardwood in one of eight attractive finishes.
- Warranted for users up to 250 lbs.

TASK CHAIR FEATURES

- Mid-range knee-tilt mechanism allows for a natural, comfortable recline.
- Pneumatic seat height adjustment moves the seat up and down to adapt to various body heights.
- Tilt tension controls the rate and ease of recline.
- Tilt lock allows the user to lock out the tilt function.
- Arms feature a urethane top pad.
- Base features a steel substrate with hardwood base caps.
- Dual-wheel, hooded casters roll effortlessly and silently.
- Warranted for users up to 250 lbs.

PARK AVENUE COLLECTION®

5000 Series Options

MODEL OPTIONS

H5001



Executive High-Back

Pneumatic, Swivel, Mid-range Knee Tilt, Tilt Tension, Tilt Lock, Open Loop Arms

H5002



Managerial Mid-Back

Pneumatic, Swivel, Mid-range Knee Tilt, Tilt Tension, Tilt Lock, Open Loop Arms

H5003

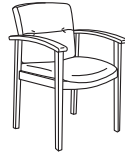

Guest Chair

Leg Base, Wood Arms

AVAILABLE FINISHES

Park Avenue Collection® 5000 Series Seating is available in 8 wood finishes.

WOOD FINISHES

Bourbon Cherry (H)

Cognac (COGN)

Harvest (C)

Mahogany (N)

Mocha (MOCH)

Natural Maple (D)

Pinnacle (PINC)

Shaker Cherry (F)

AVAILABLE FABRICS

GRADE 1	GRADE 2	GRADE 3	GRADE 4	GRADE 5	GRADE 6	GRADE 7	GRADE 8	GRADE 9	GRADE 10	GRADE 11	GRADE 12	GRADE L
Centurion	Appoint	Epic	Bar	Amuse	Intermix II		Brisa®	Martini Vinyl	Affinity	Acrobat	Fenestra	Denver
Classic	Seating	Infinity	Blip	Avenue	Raffia Vinyl		Polyurethane	Olympus Vinyl	Concentric	Whirl	Helix	Leather
Compass	Bangle	Knack	Coin	Lariat	Wooly				Juxy			(Matches
Confetti	Clyde	Marathon	Current	Outlander								EE Vinyl)
Contourette	Dotty	Millennium	Disc	Polka								
Polyurethane	Esplanade *	Odyssey	Divide	Riddle								
Dapper	Expo	Silvertex™	Free	Sequence								
Inertia	Fuse	Vinyl	Habit	Solace								
Optic	Gio *	Syntax	Hive	Tribeca								
Sierra Vinyl	Moguls	Tradition	Lineup									
Stitchery	Origin	Via	Manner									
Tectonic	Seed		Medium									
	Sockhop		Messenger									
	Spin Seating		Metric									
	Whisper Vinyl		Oblique									
			Pick									
			Sprint									
			Technic									

Reference Fabric Color Combinations on pages 18-29 for color codes and legend on page 19 for lead times. Visit hon.com for additional partnership fabrics.

NOTES: Gathers and creases may be more visible with Attire (AI) and Optic (OP) fabrics due to the inherent design and construction of these fabrics. For additional HON to Supply COM fabric grade pricing, go to honready.hon.com and click on the HON to Supply COM link.

🔥 For Fire Code model, availability and ordering method, refer to pages 34-39. Available on select models, contact HON Customer Support for availability.

* Fabric is de-emphasized.



Icon Legend on page 14

PARK AVENUE COLLECTION®

5000 Series

H5001



EXECUTIVE HIGH-BACK

Pneumatic
Swivel
Mid-range Knee Tilt
Tilt Tension
Tilt Lock
Open Loop Arms
Functions: **A, E, G, K, L**
(Function Key on pages 16-17)

DIMENSIONS

Depth: 29
Width: 26
Height: 44½
Seat Depth: 19½
Seat Width: 20
Back Width: 20
Back Height: 26¼
Arm Width: 20
Seat to Floor Height: 17¾-22½
Usable Seat Depth: 17⅝
Ship Weight: 61
Cube: 23.7
COM: 3.0
Weight Rating: 250 lbs.

FABRIC PRICE CODES

1	\$934	8	\$1348
2	\$1006	9	\$1402
3	\$1078	10	\$1456
4	\$1132	11	\$1510
5	\$1186	12	\$1564
6	\$1240	L	\$1534
7	\$1294		

NOTES: Arms are selected hardwood with urethane top pads.

H5002



MANAGERIAL MID-BACK

Pneumatic
Swivel
Mid-range Knee Tilt
Tilt Tension
Tilt Lock
Open Loop Arms
Functions: **A, E, G, K, L**
(Function Key on pages 16-17)

DIMENSIONS

Depth: 29
Width: 26
Height: 39½
Seat Depth: 19½
Seat Width: 20
Back Width: 20
Back Height: 19¼
Arm Width: 20
Seat to Floor Height: 17¾-22½
Usable Seat Depth: 17⅝
Ship Weight: 57
Cube: 18.5
COM: 2.5
Weight Rating: 250 lbs.

FABRIC PRICE CODES

1	\$910	8	\$1255
2	\$970	9	\$1300
3	\$1030	10	\$1345
4	\$1075	11	\$1390
5	\$1120	12	\$1435
6	\$1165	L	\$1410
7	\$1210		

NOTES: Arms are selected hardwood with urethane top pads.

H5003



GUEST CHAIR

Leg Base
Wood Arms

DIMENSIONS

Depth: 22
Width: 23½
Height: 33⅝
Seat Depth: 17
Seat Width: 20
Back Width: 21
Back Height: 17
Arm Width: 19
Seat to Floor Height: 18½
Usable Seat Depth: 17
Ship Weight: 27
Cube: 15.0
COM: 1.5
Weight Rating: 250 lbs.

FABRIC PRICE CODES

1	\$652	8	\$859
2	\$688	9	\$886
3	\$724	10	\$913
4	\$751	11	\$940
5	\$778	12	\$967
6	\$805	L	\$952
7	\$832		

NOTES: Arms are selected hardwood with no urethane top pad.

HON Recommendation: H5001.MOCH.CU__ - List Price \$934

HOW TO SPECIFY

<p>Select Model Number</p> <p>H 5 0 0 1 .</p>	<p>Select Finish</p> <p>See page 204</p> <p>M O C H .</p>	<p>Select Fabric</p> <p>See page 204</p> <p>C U 1 0</p>
---	---	---

CENTERPIECE™ Occasional Tables

NOT ON GSA CONTRACT



Icon Legend on page 14

HVPTO2448L16 COFFEE TABLE

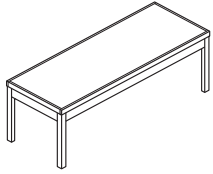

DIMENSIONS

Length:	48	Ship Weight:	51
Width:	24	Cube:	15.1
Height:	16		

LIST PRICE

\$1480

NOTES: Selection features a coffee table and two side tables. Legs are constructed of solid hardwood. Legs are attached to table with steel corner brackets and lag bolts. Metal tack glides are standard. Legs require customer attachment.

HVPTO2424L16 IN-LINE TABLE

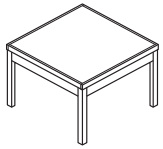

DIMENSIONS

Length:	24	Ship Weight:	30
Width:	24	Cube:	8.0
Height:	16		

LIST PRICE

\$1199

NOTES: Selection features a coffee table and two side tables. Legs are constructed of solid hardwood. Legs are attached to table with steel corner brackets and lag bolts. Metal tack glides are standard. Legs require customer attachment.

HVPTO2424L21 END TABLE

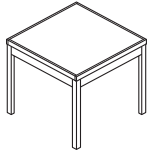

DIMENSIONS

Length:	24	Ship Weight:	41
Width:	24	Cube:	10.1
Height:	21		

LIST PRICE

\$1268

NOTES: Selection features a coffee table and two side tables. Legs are constructed of solid hardwood. Legs are attached to table with steel corner brackets and lag bolts. Metal tack glides are standard. Legs require customer attachment.

HON Recommendation: HVPTO2424L16.N - List Price \$1199

HOW TO SPECIFY

Select
Model Number

Select
Finish

See page 204

H V P T O 2 4 2 4 L 1 6 . N

PARK AVENUE COLLECTION® 5020 SERIES



Park Avenue Mid-Back Chairs shown with Preside® Conference Table.

PARK AVENUE COLLECTION® 5020 SERIES

Park Avenue seating is your address for elegance. This family of task and guest seating features all-day comfort with upscale accents. Task chairs feature a Polished Aluminum base, as well as an elegant tuxedo back design that creates a sophisticated look. Guest seating welcomes visitors in style and leaves a lasting impression. If you're looking to put yourself, your coworkers and your visitors at ease, make a move to Park Avenue.



GUEST CHAIR FEATURES

- Fully-upholstered outer back.
- Backs feature sewn seams for a tailored look.
- Black powder coated frame.
- Warranted for users up to 250 lbs.

TASK CHAIR FEATURES

- Mid-range knee-tilt mechanism allows for a natural, comfortable recline.
- Pneumatic seat height adjustment moves the seat up and down to adapt to various body heights.
- Tilt tension controls the rate and ease of recline.
- Tilt lock allows the user to lock out the tilt function.
- Arms feature a urethane top pad.
- Polished Aluminum base.
- Dual-wheel, hooded casters roll effortlessly and silently.
- Warranted for users up to 250 lbs.

PARK AVENUE COLLECTION®

5020 Series Options

MODEL OPTIONS

H5021



Executive High-Back

Pneumatic, Swivel, Mid-range Knee Tilt, Tilt Tension, Tilt Lock, Open Loop Arms

H5022



Managerial Mid-Back

Pneumatic, Swivel, Mid-range Knee Tilt, Tilt Tension, Tilt Lock, Open Loop Arms

H5023



Guest Chair

Sled Base, Arms

CASTERS



CODE	DESCRIPTION	PRICE
H	Hard Caster	+ \$0



S	Soft Caster	+ \$30
----------	-------------	---------------

*Specify for models H5021 and H5022 only

AVAILABLE FABRICS

GRADE 1	GRADE 2	GRADE 3	GRADE 4	GRADE 5	GRADE 6	GRADE 7	GRADE 8	GRADE 9	GRADE 10	GRADE 11	GRADE 12	GRADE L
Arrondi *	Appoint Seating	Epic	Bar	Amuse	Intermix II		Brisa® Polyurethane	Martini Vinyl	Affinity	Acrobat	Fenestra	Denver Leather (Matches EE Vinyl)
Attire	Bangle	Infinity	Blip	Avenue	Raffia Vinyl			Olympus Vinyl	Concentric	Natural World Whirl	Helix	
Centurion	Clyde	Knack	Coin	Lariat	Wooly				Juxy		Lava	
Classic	Dotty	Marathon	Current	Outlander							Ripple	
Compass	Esplanade *	Millennium	Decode	Polka								
Confetti	Expo	Odyssey	Disc	Riddle								
Contourette Polyurethane	Fuse	Silvertex™ Vinyl	Divide	Sentry-HC								
Dapper	Gio *	Syntax	Free	Sequence								
Inertia	Moguls	Tradition	Habit	Solace								
Optic	Origin	Via	Hive	Tribeca								
Sierra Vinyl	Seed		Lineup									
Stitchery	Sockhop		Manner									
Tectonic	Spin Seating		Medium									
	Whisper Vinyl		Messenger									
			Metric									
			Oblique									
			Pick									
			Sprint									
			Technic									

Reference Fabric Color Combinations on pages 18-29 for color codes and legend on page 19 for lead times. Visit hon.com for additional partnership fabrics.

NOTES: Gathers and creases may be more visible with Attire (AI) and Optic (OP) fabrics due to the inherent design and construction of these fabrics. For additional HON to Supply COM fabric grade pricing, go to honready.hon.com and click on the HON to Supply COM link.

🔥 For Fire Code model, availability and ordering method, refer to pages 34-39. Available on select models, contact HON Customer Support for availability.

* Fabric is de-emphasized.



PARK AVENUE COLLECTION®

5020 Series

H5021



EXECUTIVE HIGH-BACK

Pneumatic
Swivel
Mid-range Knee Tilt
Tilt Tension
Tilt Lock
Open Loop Arms
Functions: **A, E, G, K, L**
(Function Key on pages 16-17)

DIMENSIONS

Depth:	29	Arm Width:	20
Width:	26	Seat to Floor Height:	17 ³ / ₄ -22 ¹ / ₂
Height:	44 ¹ / ₂	Usable Seat Depth:	17 ⁵ / ₈
Seat Depth:	17 ⁵ / ₈	Ship Weight:	57
Seat Width:	20	Cube:	16.0
Back Width:	20	COM:	3.0
Back Height:	26 ¹ / ₄	Weight Rating:	250 lbs.

FABRIC PRICE CODES

1	\$1002	8	\$1416
2	\$1074	9	\$1470
3	\$1146	10	\$1524
4	\$1200	11	\$1578
5	\$1254	12	\$1632
6	\$1308	L	\$1602
7	\$1362		

Polished aluminum base

H5022



MANAGERIAL MID-BACK

Pneumatic
Swivel
Mid-range Knee Tilt
Tilt Tension
Tilt Lock
Open Loop Arms
Functions: **A, E, G, K, L**
(Function Key on pages 16-17)

DIMENSIONS

Depth:	29	Arm Width:	20
Width:	26	Seat to Floor Height:	17 ³ / ₄ -22 ¹ / ₂
Height:	38 ¹ / ₂	Usable Seat Depth:	17 ⁵ / ₈
Seat Depth:	17 ⁵ / ₈	Ship Weight:	54
Seat Width:	20	Cube:	16.0
Back Width:	20	COM:	2.5
Back Height:	19 ¹ / ₄	Weight Rating:	250 lbs.

FABRIC PRICE CODES

1	\$979	8	\$1324
2	\$1039	9	\$1369
3	\$1099	10	\$1414
4	\$1144	11	\$1459
5	\$1189	12	\$1504
6	\$1234	L	\$1479
7	\$1279		

Polished aluminum base

H5023



GUEST CHAIR

Sled Base
Arms

DIMENSIONS

Depth:	27	Arm Width:	20
Width:	25	Seat to Floor Height:	18 ¹ / ₂
Height:	35 ¹ / ₂	Usable Seat Depth:	17 ⁵ / ₈
Seat Depth:	17 ⁵ / ₈	Ship Weight:	45
Seat Width:	20	Cube:	18.4
Back Width:	20	COM:	2.5
Back Height:	19 ¹ / ₄	Weight Rating:	250 lbs.

FABRIC PRICE CODES

1	\$772	8	\$1117
2	\$832	9	\$1162
3	\$892	10	\$1207
4	\$937	11	\$1252
5	\$982	12	\$1297
6	\$1027	L	\$1272
7	\$1072		

Black powder coated frame



HON Recommendation: H5021.H.CU__ - List Price \$1002

HOW TO SPECIFY

<p>Select Model Number</p> <p>H 5 0 2 1 .</p>	<p>Select Caster</p> <p>H Hard Caster S Soft Caster (+ \$30) <i>Specify for models H5021 and H5022 only</i></p> <p>H .</p>	<p>Select Fabric</p> <p>See page 208</p> <p>C U 1 0</p>
--	---	--

PERPETUAL® NESTING CHAIRS



PERPETUAL® NESTING CHAIRS

Always attractive, always supportive — that's Perpetual. Provide full-time comfort to even part-time workers with the Perpetual line of multipurpose seating. The flip-up seat design maximizes space by allowing Perpetual to be easily nested. The passive back design moves with the user to deliver added comfort for all day meetings. Save space without sacrificing comfort with Perpetual.



FEATURES

- Flip-up seat allows chairs to nest and save floor space.
- Optional resilience knit back is breathable and supportive.
- Backrest reclines for added comfort.
- Tube rolled steel frame adds durability.
- Underside of seat is fully-upholstered for a clean appearance when nested.
- All-surface casters roll effortlessly and silently.
- Available in hundreds of quality HON fabrics.
- Warranted for users up to 300 lbs.

PERPETUAL® Nesting Chairs Options

MODEL OPTIONS

HPN1



Nesting Chair (Flex-back)

Armless, Four Legs

HPN2



Nesting Chair (Flex-back)

Fixed Arms, Four Legs

CASTER/ GLIDE



CODE	DESCRIPTION	PRICE
A	All-surface	+\$0
G	Bell Glide	+\$25

FRAME

CODE	DESCRIPTION	PRICE
T	Black	+\$0
T1	Platinum Metallic	+\$0

BACK STYLE



CODE	DESCRIPTION	PRICE
UU	Upholstered Back	+\$0
RB	Resilience Back/Black	+\$0
RG	Resilience Back/Gray	+\$0

AVAILABLE FABRICS

GRADE 1	GRADE 2	GRADE 3	GRADE 4	GRADE 5	GRADE 6	GRADE 7	GRADE 8	GRADE 9	GRADE 10	GRADE 11	GRADE 12	GRADE L
Arrondi * Attire Centurion Classic Compass Confetti Contourette Polyurethane Dapper Inertia Optic Sierra Vinyl Stitchery Tectonic	Appoint Seating Bangle Clyde Dotty Esplanade * Expo Fuse Gio * Moguls Origin Seed Sockhop Spin Seating Whisper Vinyl	Canter Polyurethane Epic Infinity Knack Marathon Millennium Odyssey Silvertext™ Vinyl Syntax Tradition Via	Bar Blip Coin Current Decode Disc Divide Free Habit Hive Lineup Manner Medium Messenger Metric Oblique Pick Sprint Technic	Amuse Avenue Lariat Outlander Polka Riddle Sequence Solace Tribeca	Intermix II Raffia Vinyl Wooly		Brisa® Polyurethane	Eli Vinyl Martini Vinyl Olympus Vinyl	Affinity Concentric Juxy	Acrobat Whirl	Fenestra Helix	

Reference Fabric Color Combinations on pages 18-29 for color codes and legend on page 19 for lead times. Visit hon.com for additional partnership fabrics.

NOTES: Gathers and creases may be more visible with Attire (AI) and Optic (OP) fabrics due to the inherent design and construction of these fabrics. For additional HON to Supply COM fabric grade pricing, go to honready.hon.com and click on the HON to Supply COM link.

For Fire Code model, availability and ordering method, refer to pages 34-39. Available on select models, contact HON Customer Support for availability.

Fabric is de-emphasized.

PERPETUAL® Nesting Chairs

GSA SIN 711-18



Icon Legend on page 14

HPN1



Model HPN1AUU shown

NESTING CHAIR

Flex-back
Armless
Four Legs

DIMENSIONS

Depth:	26	Seat to Floor Height:	19 $\frac{1}{8}$
Width:	26	Usable Seat Depth:	16 $\frac{1}{2}$
Height:	36	Ship Weight:	38
Seat Depth:	17 $\frac{3}{4}$	Cube:	15.2
Seat Width:	17	COM:	1.5
Back Width:	17 $\frac{1}{2}$	Weight Rating:	300 lbs.
Back Height:	15 $\frac{3}{4}$		

FABRIC PRICE CODES

1	\$578	8	\$785
2	\$614	9	\$812
3	\$650	10	\$839
4	\$677	11	\$866
5	\$704	12	\$893
6	\$731	L	—
7	\$758		

HPN1



Model HPN1ARB shown

NESTING CHAIR

Flex-back
Armless
Four Legs

DIMENSIONS

Depth:	25 $\frac{3}{4}$	Seat to Floor Height:	19 $\frac{1}{8}$
Width:	26	Usable Seat Depth:	16 $\frac{1}{2}$
Height:	35 $\frac{1}{4}$	Ship Weight:	36
Seat Depth:	17 $\frac{3}{4}$	Cube:	15.2
Seat Width:	17	COM:	1.0
Back Width:	19 $\frac{1}{4}$	Weight Rating:	300 lbs.
Back Height:	16 $\frac{1}{2}$		

FABRIC PRICE CODES

1	\$578	8	\$785
2	\$614	9	\$812
3	\$650	10	\$839
4	\$677	11	\$866
5	\$704	12	\$893
6	\$731	L	—
7	\$758		

HPN2



Model HPN2AUU shown

NESTING CHAIR

Flex-back
Fixed Arms
Four Legs

DIMENSIONS

Depth:	26	Arm Width:	20 $\frac{3}{4}$
Width:	26	Seat to Floor Height:	19 $\frac{1}{8}$
Height:	36	Usable Seat Depth:	16 $\frac{1}{2}$
Seat Depth:	17 $\frac{3}{4}$	Ship Weight:	41
Seat Width:	17	Cube:	15.2
Back Width:	17 $\frac{1}{2}$	COM:	1.5
Back Height:	15 $\frac{3}{4}$	Weight Rating:	300 lbs.

FABRIC PRICE CODES

1	\$640	8	\$847
2	\$676	9	\$874
3	\$712	10	\$901
4	\$739	11	\$928
5	\$766	12	\$955
6	\$793	L	—
7	\$820		

HPN2



Model HPN2ARB shown

NESTING CHAIR

Flex-back
Fixed Arms
Four Legs

DIMENSIONS

Depth:	25 $\frac{3}{4}$	Arm Width:	20 $\frac{3}{4}$
Width:	26	Seat to Floor Height:	19 $\frac{1}{8}$
Height:	35 $\frac{1}{4}$	Usable Seat Depth:	16 $\frac{1}{2}$
Seat Depth:	17 $\frac{3}{4}$	Ship Weight:	38
Seat Width:	17	Cube:	15.2
Back Width:	19 $\frac{1}{4}$	COM:	1.0
Back Height:	16 $\frac{1}{2}$	Weight Rating:	300 lbs.

FABRIC PRICE CODES

1	\$640	8	\$847
2	\$676	9	\$874
3	\$712	10	\$901
4	\$739	11	\$928
5	\$766	12	\$955
6	\$793	L	—
7	\$820		

HOW TO SPECIFY

Select Model Number <div style="border: 1px solid black; padding: 2px; display: flex; gap: 5px;"> HPN1 </div>	Select Caster/Glide A All-surface G Bell Glide (+ \$25) <div style="border: 1px solid black; padding: 2px; display: flex; gap: 5px;"> A </div>	Select Back Type UU Upholstered Back RB Resilience Back/Black RG Resilience Back/Gray <div style="border: 1px solid black; padding: 2px; display: flex; gap: 5px;"> UU </div>	Select Fabric Note: For models with upholstered back, seat and back are always matching fabric See page 211 <div style="border: 1px solid black; padding: 2px; display: flex; gap: 5px;"> CU10 </div>	Select Frame T Black T1 Platinum Metallic <div style="border: 1px solid black; padding: 2px; display: flex; gap: 5px;"> T </div>
---	---	---	---	---

PILLOW-SOFT® 2090 SERIES



Pillow-Soft High-Back Executive and Sled Base Guest Chairs shown with 10700 Series™ desks.

PILLOW-SOFT® 2090 SERIES

Pillow-Soft chairs combine comfort, style and selection to deliver the ultimate seating experience. Each executive chair in the collection combines thick memory foam cushioning with built-in lumbar support to reduce fatigue and increase comfort. Besides the full body support, it adds an authoritative presence to the office. The plush tufted leather or fabric will add a touch of sophistication to your office.



FEATURES

- Responsive memory foam eliminates pressure points and provides lasting comfort.
- Loop arms relieve stress on the shoulder and neck.
- Fully-upholstered outer back.
- Memory foam seat cushion reduces pressure points and responds to contours of the body for lasting comfort.
- Task chairs come standard with pneumatic seat height adjustment, tilt, tilt tension and tilt lock.
- Dual-wheel, hooded casters roll effortlessly and silently.
- Warranted for users up to 300 lbs.

PILLOW-SOFT®

2090 Series Options

MODEL OPTIONS

H2091



Executive High-Back

Pneumatic, Swivel, Tilt, Tilt Tension, Tilt Lock, Arms

H2092



Managerial Mid-Back

Pneumatic, Swivel, Tilt, Tilt Tension, Tilt Lock, Arms

H2093



Guest Chair

Sled Base, Arms

CASTERS



CODE	DESCRIPTION	PRICE
H	Hard Caster	+ \$0



S	Soft Caster	+ \$30
---	-------------	--------

AVAILABLE FABRICS

GRADE 1	GRADE 2	GRADE 3	GRADE 4	GRADE 5	GRADE 6	GRADE 7	GRADE 8	GRADE 9	GRADE 10	GRADE 11	GRADE 12	GRADE L
Arrondi *	Appoint	Canter	Bar	Amuse	Intermix II		Brisa®	Eli Vinyl	Affinity	Acrobat	Fenestra	Leather
Black Vinyl	Seating	Polyurethane	Blip	Avenue	Raffia Vinyl		Polyurethane	Martini Vinyl	Concentric	Whirl	Helix	
Burgundy Vinyl	Bangle	Epic	Coin	Lariat	Wooly			Olympus Vinyl	Juxy			
Centurion	Clyde	Infinity	Current	Outlander								
Classic	Dotty	Knack	Decode	Polka								
Compass	Esplanade *	Marathon	Disc	Riddle								
Confetti	Expo	Millennium	Divide	Sequence								
Contourette	Fuse	Odyssey	Free	Solace								
Polyurethane	Gio *	Silvertex™ Vinyl	Habit	Tribeca								
Dapper	Moguls		Hive									
Inertia	Origin	Syntax	Lineup									
Optic	Seed	Tradition	Manner									
Stitchery	Sockhop	Via	Medium									
Tectonic	Spin Seating		Messenger									
	Whisper Vinyl		Metric									
			Oblique									
			Pick									
			Sprint									
			Technic									

Reference Fabric Color Combinations on pages 18-29 for color codes and legend on page 19 for lead times. Visit hon.com for additional partnership fabrics.

NOTES: Gathers and creases may be more visible with Attire (AI) and Optic (OP) fabrics due to the inherent design and construction of these fabrics. For additional HON to Supply COM fabric grade pricing, go to honready.hon.com and click on the HON to Supply COM link.

🔥 For Fire Code model, availability and ordering method, refer to pages 34-39. Available on select models, contact HON Customer Support for availability.

* Fabric is de-emphasized.



PILLOW-SOFT® 2090 Series

H2091



EXECUTIVE HIGH-BACK

Pneumatic
Swivel
Tilt
Tilt Tension
Tilt Lock
Arms

Functions: **A, E, F, K, L**
(Function Key on pages 16-17)

DIMENSIONS

Depth: 29¾
Width: 26¼
Height: 46½
Seat Depth: 21
Seat Width: 22
Back Width: 22
Back Height: 25

Arm Width: 20¼
Seat to Floor Height: 16¾-21¼
Usable Seat Depth: 18½
Ship Weight: 57
Cube: 16.0
COM: 3.0
Weight Rating: 300 lbs.

FABRIC PRICE CODES

1	\$555	8	\$969
2	\$627	9	\$1023
3	\$699	10	\$1077
4	\$753	11	\$1131
5	\$807	12	\$1185
6	\$861	L	\$705
7	\$915		

NOTES: When selecting leather, the 2090 Series uses SR Leather only. All models are also available in Grade 1 EB vinyl (which matches SR Leather).

H2092



MANAGERIAL MID-BACK

Pneumatic
Swivel
Tilt
Tilt Tension
Tilt Lock
Arms

Functions: **A, E, F, K, L**
(Function Key on pages 16-17)

DIMENSIONS

Depth: 28¾
Width: 26¼
Height: 41¼
Seat Depth: 21
Seat Width: 22
Back Width: 22
Back Height: 19¾

Arm Width: 20¼
Seat to Floor Height: 16¾-21¼
Usable Seat Depth: 18½
Ship Weight: 54
Cube: 16.0
COM: 3.0
Weight Rating: 300 lbs.

FABRIC PRICE CODES

1	\$530	8	\$944
2	\$602	9	\$998
3	\$674	10	\$1052
4	\$728	11	\$1106
5	\$782	12	\$1160
6	\$836	L	\$680
7	\$890		

NOTES: When selecting leather, the 2090 Series uses SR Leather only. All models are also available in Grade 1 EB vinyl (which matches SR Leather).

H2093



GUEST CHAIR

Sled Base
Arms

DIMENSIONS

Depth: 27¾
Width: 23¼
Height: 36
Seat Depth: 21½
Seat Width: 20¾
Back Width: 21½
Back Height: 19¼

Arm Width: 19¾
Seat to Floor Height: 19½
Usable Seat Depth: 19
Ship Weight: 38
Cube: 16.1
COM: 2.5
Weight Rating: 300 lbs.

FABRIC PRICE CODES

1	\$431	8	\$776
2	\$491	9	\$821
3	\$551	10	\$866
4	\$596	11	\$911
5	\$641	12	\$956
6	\$686	L	\$581
7	\$731		

NOTES: When selecting leather, the 2090 Series uses SR Leather only. All models are also available in Grade 1 EB vinyl (which matches SR Leather).

HON Recommendation: H2091.H.SR11.T - List Price \$705

HOW TO SPECIFY

<p>Select Model Number</p> <p>H 2 0 9 1 .</p>	<p>Select Caster</p> <p>H Hard Caster S Soft Caster (+ \$30) <i>Does not apply to model H2093</i></p> <p>H .</p>	<p>Select Fabric</p> <p>See page 214</p> <p>S R 1 1 .</p>	<p>Select Frame</p> <p>T Black</p> <p>T</p>
--	---	--	--

PILLOW-SOFT® 2190 SERIES



Pillow-Soft Executive High-Back and Guest Chairs shown with Park Avenue Collection® Laminate desks.

PILLOW-SOFT® 2190 SERIES

Pillow-Soft chairs combine comfort, style and selection to deliver the ultimate seating experience. Each executive chair in the collection combines thick memory foam cushioning with built-in lumbar support to reduce fatigue and increase comfort. Besides the full body support, it adds an authoritative presence to the office. The plush tufted leather or fabric and optional hardwood accents will add a touch of sophistication to your office.



FEATURES

- Responsive memory foam eliminates pressure points and provides lasting comfort.
- Loop arms relieve stress on the shoulder and neck.
- Fully-upholstered outer back.
- Base features a steel substrate with hardwood base caps.
- Memory foam seat cushion reduces pressure points and responds to contours of the body for lasting comfort.
- Dual-wheel, hooded casters roll effortlessly and silently.
- Solid hardwood in one of eight attractive finishes.
- Warranted for users up to 250 lbs.

PILLOW-SOFT® 2190 Series Options

MODEL OPTIONS

H2191



Executive High-Back

Pneumatic, Swivel, Tilt, Tilt Tension, Tilt Lock, Open Padded Loop Arms

H2192



Managerial Mid-Back

Pneumatic, Swivel, Tilt, Tilt Tension, Tilt Lock, Open Padded Loop Arms

H2194



Guest Chair

4-Leg Base, Open Loop Arms

AVAILABLE FINISHES

Pillow-Soft® 2190 Series Seating is available in 8 wood finishes.

WOOD FINISHES

Bourbon Cherry (H)

Cognac (COGN)

Harvest (C)

Mahogany (N)

Mocha (MOCH)

Natural Maple (D)

Pinnacle (PINC)

Shaker Cherry (F)

AVAILABLE FABRICS

GRADE 1	GRADE 2	GRADE 3	GRADE 4	GRADE 5	GRADE 6	GRADE 7	GRADE 8	GRADE 9	GRADE 10	GRADE 11	GRADE 12	GRADE L
Arrondi *	Appoint Seating	Epic	Bar	Amuse	Intermix II		Brisa® Polyurethane	Eli Vinyl	Affinity	Acrobat	Fenestra	SR Leather
Black Vinyl	Bangle	Infinity	Blip	Avenue	Raffia Vinyl			Martini Vinyl	Concentric	Whirl	Helix	
Burgundy Vinyl	Clyde	Knack	Coin	Lariat	Wooly			Olympus Vinyl	Juxy			
Centurion	Dotty	Marathon	Current	Outlander								
Classic	Esplanade *	Millennium	Decode	Polka								
Compass	Expo	Odyssey	Disc	Riddle								
Confetti	Fuse	Silvertext™ Vinyl	Divide	Sequence								
Contourette	Gio *	Syntax	Free	Solace								
Polyurethane	Moguls	Tradition	Habit	Tribeca								
Dapper	Origin	Via	Hive									
Inertia	Seed		Lineup									
Optic	Sockhop		Manner									
Stitchery	Spin Seating		Medium									
Tectonic	Whisper Vinyl		Messenger									
			Metric									
			Oblique									
			Pick									
			Sprint									
			Technic									

Reference Fabric Color Combinations on pages 18-29 for color codes and legend on page 19 for lead times. Visit hon.com for additional partnership fabrics.

NOTES: Gathers and creases may be more visible with Attire (AI) and Optic (OP) fabrics due to the inherent design and construction of these fabrics. For additional HON to Supply COM fabric grade pricing, go to honready.hon.com and click on the HON to Supply COM link.

🔥 For Fire Code model, availability and ordering method, refer to pages 34-39. Available on select models, contact HON Customer Support for availability.

* Fabric is de-emphasized.

PILLOW-SOFT® 2190 Series

GSA SIN 711-18



Icon Legend on page 14

H2191



EXECUTIVE HIGH-BACK

Pneumatic
Swivel
Tilt
Tilt Tension
Tilt Lock
Open Padded Loop Arms
Functions: **A, E, F, K, L**
(Function Key on pages 16-17)

DIMENSIONS

Depth:	29¾	Arm Width:	22¼
Width:	26¼	Seat to Floor Height:	16¾-21¼
Height:	46½	Usable Seat Depth:	18½
Seat Depth:	21	Ship Weight:	60
Seat Width:	22	Cube:	16.0
Back Width:	22	COM:	3.0
Back Height:	25	Weight Rating:	250 lbs.

FABRIC PRICE CODES

1	\$887	8	\$1301
2	\$959	9	\$1355
3	\$1031	10	\$1409
4	\$1085	11	\$1463
5	\$1139	12	\$1517
6	\$1193	L	\$1037
7	\$1247		

NOTES: Arms are laminated hardwood with urethane top pads. Also available in Grade 1 vinyl EB11 and EB69. (EB matching vinyl used with SR Leather).

H2192



MANAGERIAL MID-BACK

Pneumatic
Swivel
Tilt
Tilt Tension
Tilt Lock
Open Padded Loop Arms
Functions: **A, E, F, K, L**
(Function Key on pages 16-17)

DIMENSIONS

Depth:	28¾	Arm Width:	22¼
Width:	26¼	Seat to Floor Height:	16¾-21¼
Height:	41¾	Usable Seat Depth:	18½
Seat Depth:	21	Ship Weight:	57
Seat Width:	22	Cube:	16.0
Back Width:	22	COM:	2.5
Back Height:	19¾	Weight Rating:	250 lbs.

FABRIC PRICE CODES

1	\$862	8	\$1207
2	\$922	9	\$1252
3	\$982	10	\$1297
4	\$1027	11	\$1342
5	\$1072	12	\$1387
6	\$1117	L	\$1012
7	\$1162		

NOTES: Arms are laminated hardwood with urethane top pads. Also available in Grade 1 vinyl EB11 and EB69. (EB matching vinyl used with SR Leather).

H2194



GUEST CHAIR

4-Leg Base
Open Loop Arms

DIMENSIONS

Depth:	27½	Arm Width:	19¾
Width:	23¼	Seat to Floor Height:	19½
Height:	35½	Usable Seat Depth:	19
Seat Depth:	21½	Ship Weight:	49
Seat Width:	20¾	Cube:	17.3
Back Width:	21½	COM:	2.5
Back Height:	19¼	Weight Rating:	250 lbs.

FABRIC PRICE CODES

1	\$670	8	\$1015
2	\$730	9	\$1060
3	\$790	10	\$1105
4	\$835	11	\$1150
5	\$880	12	\$1195
6	\$925	L	\$820
7	\$970		

NOTES: Guest Chairs available in 4-Leg Base. Also available in Grade 1 vinyl EB11 and EB69. (EB matching vinyl used with SR Leather).

HON Recommendation: H2191.MOCH.CU__ - List Price \$887

HOW TO SPECIFY

<p>Select Model Number</p> <p>H 2 1 9 1</p>	<p>Select Finish</p> <p>See page 217</p> <p>M O C H</p>	<p>Select Fabric</p> <p>See page 217</p> <p>C U 1 0</p>
--	--	--

PURPOSE®



Purpose Task Chairs shown with Voi® Desks.

PURPOSE®

Purpose is designed to flex and adjust to you. Your posture. Your weight. Your movements. Whether in a task chair or stool, the seat and back move independently to constantly respond changes in weight distribution and motion. The innovative YouFit™ technology provides a tailored fit with three distinct flex zones to support a range of postures, including sitting, reclining or perching. Designed to intuitively respond to each user's body, there are no complex manual adjustments to master. With Purpose, sitting is believing.



FEATURES

- YouFit™ technology intuitively responds to your body's movements.
- The seat and back to move independently for a more comfortable recline.
- Optional arms increase upper body support.
- One-touch seat height adjustment easily moves the seat up and down.
- Shell is available in either Onyx or Platinum.
- Available in hundreds of quality HON fabrics.
- Warranted for users up to 300 lbs.

PURPOSE[®] Options

MODEL OPTIONS

HR1P



Task Chair (YouFit™ Technology)

Plastic Seat and Back, Pneumatic, Swivel

HR1S



Task Chair (YouFit™ Technology)

Upholstered Seat, Plastic Back, Pneumatic, Swivel

HR1W



Task Chair (YouFit™ Technology)

Upholstered Seat and Back, Pneumatic, Swivel

HR5P



Task Stool (YouFit™ Technology)

Plastic Seat and Back, Pneumatic, Swivel, Adjustable Footring

HR5S



Task Stool (YouFit™ Technology)

Upholstered Seat, Plastic Back, Pneumatic, Swivel, Adjustable Footring

HR5W



Task Stool (YouFit™ Technology)

Upholstered Seat and Back, Pneumatic, Swivel, Adjustable Footring

ARM STYLE

CODE	DESCRIPTION	PRICE
N	Armless	+\$0
FBLK	Fixed Black Arms	+\$65
FBLT	Fixed Platinum Arms	+\$65
ABLK	Adjustable Black Arms	+\$75
APLT	Adjustable Platinum Arms	+\$75



CASTERS

CODE	DESCRIPTION	PRICE
H	Hard Caster	+\$0
S	Soft Caster	+\$30



SHELL COLOR

CODE	DESCRIPTION	PRICE
ON	Onyx	+\$0
PT	Platinum	+\$0

BASE

CODE	DESCRIPTION	PRICE
T	Black	+\$0
PLAT	Platinum	+\$0

PURPOSE[®] Fabric Options

AVAILABLE FABRICS

GRADE 1	GRADE 2	GRADE 3	GRADE 4	GRADE 5	GRADE 6	GRADE 7	GRADE 8	GRADE 9	GRADE 10	GRADE 11	GRADE 12	GRADE L
Centurion		Silvertext™ Vinyl										

Reference Fabric Color Combinations on pages 18-29 for color codes and legend on page 19 for lead times. Visit hon.com for additional partnership fabrics.

NOTES: Gathers and creases may be more visible with Attire (AI) and Optic (OP) fabrics due to the inherent design and construction of these fabrics.

ⓘ For Fire Code model, availability and ordering method, refer to pages 34-39. Available on select models, contact HON Customer Support for availability.

PURPOSE[®] Dimensions

DIMENSIONS

MODEL	HR1P	HR1S	HR1W	HR5P	HR5S	HR5W
Depth Armless	26"	26"	26"	26"	26"	26"
Depth with Fixed Arms	26"	26"	26"	26"	26"	26"
Depth with Adjustable Arms	26"	26"	26"	26"	26"	26"
Width Armless	26"	26"	26"	26"	26"	26"
Width with Fixed Arms	26"	26"	26"	26"	26"	26"
Width with Adjustable Arms	27½"	27½"	27½"	27½"	27½"	27½"
Height Armless	37½"	37½"	37½"	50¾"	50¾"	50¾"
Height with Fixed Arms	37½"	37½"	37½"	50¾"	50¾"	50¾"
Height with Adjustable Arms	37½"	37½"	37½"	50¾"	50¾"	50¾"
Seat Depth	15¾"	16½"	16"	15¾"	16½"	16"
Seat Width	19"	19½"	19½"	19"	19½"	19½"
Back Width	18"	18"	18"	18"	18"	18"
Back Height	19¾"	19¼"	19¼"	19¾"	19¾"	19¼"
Adjustable Arms Width	20"	20"	20"	20"	20"	20"
Fixed Arms Width	21"	21"	21"	21"	21"	21"
Seat to Floor Height	16¼"-20¼"	16½"-20½"	16½"-20½"	23¾"-33¾"	24"-34"	24"-34"
Usable Seat Depth	15¾"	16½"	16"	16½"	16½"	16"
Ship Weight Armless	28 ⓘ	30 ⓘ	31 ⓘ	34 ⓘ	36 ⓘ	37 ⓘ
Ship Weight with Fixed Arms	32 ⓘ	34 ⓘ	35 ⓘ	38 ⓘ	39 ⓘ	41 ⓘ
Ship Weight with Adjustable Arms	33 ⓘ	35 ⓘ	36 ⓘ	39 ⓘ	40 ⓘ	41 ⓘ
Cube Armless	11.1	11.1	11.1	11.1	11.1	11.1
Cube with Fixed Arms	11.1	11.1	11.1	11.1	11.1	11.1
Cube with Adjustable Arms	11.1	11.1	11.1	11.1	11.1	11.1
Weight Capacity	300 lbs	300 lbs	300 lbs	300 lbs	300 lbs	300 lbs

PURPOSE®



HR1P



TASK CHAIR

YouFit™ Technology
 Plastic Seat and Back
 Pneumatic
 Swivel
 Functions: **A, Q, E**
 (Function Key on pages 16-17)

DIMENSIONS

Depth:	26	Seat to Floor Height:	16¼-20¼
Width:	26	Usable Seat Depth:	15¾
Height:	37½	Ship Weight:	28 Ⓢ
Seat Depth:	15¾	Cube:	11.1
Seat Width:	19	Weight Rating:	300 lbs.
Back Width:	18		
Back Height:	19¾		

LIST PRICE

\$371

NOTES: Add **"FC"** suffix to Model Number for CA Technical Bulletin 133 compliance. Add upcharge of \$40. See page 224 for Fixed or Adjustable Arm packs.

! Dimensions, weights and cubes shown above are for the armless model only. See page 221 for all other arm type specifications.

HR1S

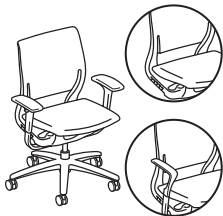

TASK CHAIR

YouFit™ Technology
 Upholstered Seat
 Plastic Back
 Pneumatic
 Swivel
 Functions: **A, Q, E**
 (Function Key on pages 16-17)

DIMENSIONS

Depth:	26	Seat to Floor Height:	16½-20½
Width:	26	Usable Seat Depth:	16½
Height:	37½	Ship Weight:	30 Ⓢ
Seat Depth:	16½	Cube:	11.1
Seat Width:	19½	Weight Rating:	300 lbs.
Back Width:	18		
Back Height:	19¼		

FABRIC PRICE CODES

1 \$451
3 \$499

NOTES: Add **"FC"** suffix to Model Number for CA Technical Bulletin 133 compliance. Add upcharge of \$90. See page 224 for Fixed or Adjustable Arm packs.

! Dimensions, weights and cubes shown above are for the armless model only. See page 221 for all other arm type specifications.

HR1W

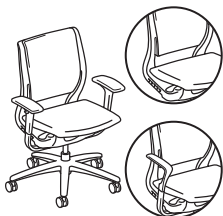

TASK CHAIR

YouFit™ Technology
 Upholstered Seat and Back
 Pneumatic
 Swivel
 Functions: **A, Q, E**
 (Function Key on pages 16-17)

DIMENSIONS

Depth:	26	Seat to Floor Height:	16½-20½
Width:	26	Usable Seat Depth:	16
Height:	37½	Ship Weight:	31 Ⓢ
Seat Depth:	16	Cube:	11.1
Seat Width:	19½	Weight Rating:	300 lbs.
Back Width:	18		
Back Height:	19¼		

FABRIC PRICE CODES

1 \$504
3 \$552

NOTES: Add **"FC"** suffix to Model Number for CA Technical Bulletin 133 compliance. Add upcharge of \$90. See page 224 for Fixed or Adjustable Arm packs.

! Dimensions, weights and cubes shown above are for the armless model only. See page 221 for all other arm type specifications.

HON Recommendation: HR1W.APLT.H.PT.CU__PLAT - List Price \$579

HOW TO SPECIFY

Select Model Number	Select Arm Type	Select Caster/Glide	Select Shell Color	Select Fabric	Select Base
	ABLK Adjustable Black Arms (+ \$75) APLT Adjustable Platinum Arms (+ \$75) FBLK Fixed Black Arms (+ \$65) FPLT Fixed Platinum Arms (+ \$65) N Armless	H Hard Caster S Soft Caster (+ \$30)	ON Onyx PT Platinum	CU Centurion (Grade 1) SX Silvertex™ (Grade 3) <i>Not specified for model HR1P</i> See pages 20 and 23 for Centurion and Silvertex™ color options	T Black PLAT Platinum
HR1W .	APLT .	H .	PT .	CU10 .	PLAT
HR1WFC .	APLT .	H .	PT .	CU10 .	PLAT

! Fire Code Option: For CA Technical Bulletin 133 compliant shells and fabric. Available shell colors are ON Onyx and PT Platinum; Fabric available in CU Centurion only. **Add Suffix: FC** to model number as shown above. **Note \$40 upcharge per plastic seat and \$90 upcharge per upholstered seat.**



Icon Legend on page 14

HR5P

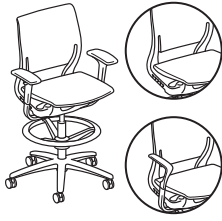

TASK STOOL

YouFit™ Technology
 Plastic Seat and Back
 Pneumatic
 Swivel
 Adjustable Footring

Functions: **A, Q, E**
 (Function Key on pages 16-17)

DIMENSIONS

Depth:	26	Seat to Floor Height:	23 ³ / ₄ -33 ³ / ₄
Width:	26	Usable Seat Depth:	16 ¹ / ₂
Height:	50 ³ / ₄	Ship Weight:	34 Ⓔ
Seat Depth:	15 ³ / ₄	Cube:	11.1
Seat Width:	19	Weight Rating:	300 lbs.
Back Width:	18		
Back Height:	19 ³ / ₄		

LIST PRICE

\$421

NOTES: Add **"FC"** suffix to Model Number for CA Technical Bulletin 133 compliance. Add upcharge of \$40. See page 224 for Fixed or Adjustable Arm packs.

! Dimensions, weights and cubes shown above are for the armless model only. See page 221 for all other arm type specifications.

HR5S



TASK STOOL

YouFit™ Technology
 Upholstered Seat
 Plastic Back
 Pneumatic
 Swivel
 Adjustable Footring

Functions: **A, Q, E**
 (Function Key on pages 16-17)

DIMENSIONS

Depth:	26	Seat to Floor Height:	24-34
Width:	26	Usable Seat Depth:	16 ¹ / ₂
Height:	50 ³ / ₄	Ship Weight:	36 Ⓔ
Seat Depth:	16 ¹ / ₂	Cube:	11.1
Seat Width:	19 ¹ / ₂	Weight Rating:	300 lbs.
Back Width:	18		
Back Height:	19 ³ / ₄		

FABRIC PRICE CODES

1 \$501
3 \$549

NOTES: Add **"FC"** suffix to Model Number for CA Technical Bulletin 133 compliance. Add upcharge of \$90. See page 224 for Fixed or Adjustable Arm packs.

! Dimensions, weights and cubes shown above are for the armless model only. See page 221 for all other arm type specifications.

HR5W



TASK STOOL

YouFit™ Technology
 Upholstered Seat and Back
 Pneumatic
 Swivel
 Adjustable Footring

Functions: **A, Q, E**
 (Function Key on pages 16-17)

DIMENSIONS

Depth:	26	Seat to Floor Height:	24-34
Width:	26	Usable Seat Depth:	16
Height:	50 ³ / ₄	Ship Weight:	37 Ⓔ
Seat Depth:	16	Cube:	11.1
Seat Width:	19 ¹ / ₂	Weight Rating:	300 lbs.
Back Width:	18		
Back Height:	19 ¹ / ₄		

FABRIC PRICE CODES

1 \$554
3 \$602

NOTES: Add **"FC"** suffix to Model Number for CA Technical Bulletin 133 compliance. Add upcharge of \$90. See page 224 for Fixed or Adjustable Arm packs.

! Dimensions, weights and cubes shown above are for the armless model only. See page 221 for all other arm type specifications.

HOW TO SPECIFY

Select Model Number	Select Arm Type	Select Caster/Glide	Select Shell Color	Select Fabric	Select Base
ABLK Adjustable Black Arms (+ \$75) APLT Adjustable Platinum Arms (+ \$75) FBLK Fixed Black Arms (+ \$65) FPLT Fixed Platinum Arms (+ \$65) N Armless	H Hard Caster S Soft Caster (+ \$30)	ON Onyx PT Platinum	CU Centurion (Grade 1) SX Silvertex™ (Grade 3) <i>Not specified for model HR5P</i> See pages 20 and 23 for Centurion and Silvertex™ color options	T Black PLAT Platinum	
HR5P .	APLT .	H .	PT .	CU10 .	PLAT
HR5PFC .	APLT .	H .	PT .	CU10 .	PLAT

! Fire Code Option: For CA Technical Bulletin 133 compliant shells and fabric. Available shell colors are ON Onyx and PT Platinum; Fabric available in CU Centurion only. **Add Suffix: FC** to model number as shown above. **Note \$40 upcharge per plastic seat and \$90 upcharge per upholstered seat.**

PURPOSE[®]



HRAAP

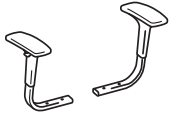

ADJUSTABLE ARM PACK

Available in Black (T) or Platinum (PLAT)

DIMENSIONS

Adjustable Arms Width: 20
 Height from Seat: 6¾-10¾
 Ship Weight: 5 **Ⓢ**
 Cube: 1.0

LIST PRICE

\$109

HRFAP



FIXED ARM PACK

Available in Black (T) or Platinum (PLAT)

DIMENSIONS

Arm Width: 21
 Height from Seat: 9
 Ship Weight: 5 **Ⓢ**
 Cube: 1.0

LIST PRICE

\$99

HOW TO SPECIFY

Select Model Number

Select Arm Color

T Black
 PLAT Platinum

HRAAP.

T

QUOTIENT™



Quotient Task Chairs shown with Voi® Desks.

QUOTIENT™

Finding a universal seating solution to satisfy a variety of needs and users can be challenging, especially with something as personal as a chair. With a mesh back for comfort, an advanced seat cushion that follows the body's contours, and a stool option for standing-height worksurfaces, Quotient is much more than the sum of its parts. Height- and width-adjustable arms help anyone find the upper body support they need. The perfect blend of comfort and style, Quotient is where form and function are perfectly divided.



FEATURES

- Contoured seat cushion reduces pressure points.
- Responsive synchro-tilt control provides a smooth, natural recline.
- ilira®-stretch M4 material cradles the spine.
- One-touch seat height adjustment easily moves the seat up and down.
- Tilt tension controls the rate and ease of recline.
- Tilt lock allows the user to lock out the tilt function.
- 360-degree swivel provides freedom of movement in any direction.
- Height- and width-adjustable arms provide a custom fit.
- Available in hundreds of quality HON fabrics.
- Warranted for users up to 300 lbs.

QUOTIENT™ Options

MODEL OPTIONS

HQTMM



Task Chair

Pneumatic, Swivel, Synchro-tilt, Tilt Tension, Tilt Lock

HQTSM



Task Stool

Pneumatic, Swivel, Synchro-tilt, Tilt Tension, Tilt Lock

MECHANISM

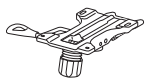

CODE	DESCRIPTION	PRICE
YO	Synchro-Tilt	+\$0

ARM STYLE



CODE	DESCRIPTION	PRICE
N	Armless	+\$0
A	Height and Width Adjustable Arms	+\$75

CASTERS/ GLIDE



CODE	DESCRIPTION	PRICE
H	Hard Caster	+\$0



S	Soft Caster	+\$30
----------	-------------	--------------



G	Bell Glide	+\$25
----------	------------	--------------

BACK



CODE	DESCRIPTION	PRICE
<i>ilira®-stretch mesh back options:</i>		
IM	Black	+\$0

BASE



CODE	DESCRIPTION	PRICE
SB	Standard Base	+\$0

QUOTIENT™ Fabric Options

AVAILABLE FABRICS

GRADE 1	GRADE 2	GRADE 3	GRADE 4	GRADE 5	GRADE 6	GRADE 7	GRADE 8	GRADE 9	GRADE 10	GRADE 11	GRADE 12	GRADE L
Arrondi *	Appoint	Canter	Bar	Amuse	Intermix II	Ascend	Brisa®	Eli Vinyl	Affinity	Acrobat	Fenestra	Denver
Attire	Seating	Polyurethane	Beeline	Avenue	Keynote	Central	Polyurethane	Martini Vinyl	Concentric	Natural	Helix	Leather
Centurion	Bangle	Epic	Blip	Lariat	Raffia Vinyl	Channel	Kindred	Olympus	Juxy	World	Lava	(Matches
Classic	Clyde	Infinity	Coin	Outlander	Velocity	Domain		Vinyl		Whirl	Ripple	EE Vinyl)
Compass	Dotty	Knack	Cover Cloth	Polka	Wooly	Synergy		Silica				(Seat
Confetti	Esplanade *	Marathon	Current	Riddle		Waver		Silica Leather				Only)
Contourette	Expo	Millennium	Decode	Sentry-HC				Silica Tech				
Polyurethane	Fuse	Odyssey	Disc	Sequence								
Dapper	Gio *	Silvertex™	Divide	Solace								
Inertia	Moguls	Vinyl	Free	Tribeca								
Optic	Origin	Syntax	Habit									
Stitchery	Seed	Tradition	Hive									
Tectonic	Sockhop	Via	Lineup									
	Spin Seating		Manner									
	Whisper		Medium									
	Vinyl		Messenger									
			Metric									
			Oblique									
			Pick									
			Sprint									
			Technic									

Reference Fabric Color Combinations on pages 18-29 for color codes and legend on page 19 for lead times. Visit hon.com for additional partnership fabrics.

NOTES: Gathers and creases may be more visible with Attire (AI) and Optic (OP) fabrics due to the inherent design and construction of these fabrics.

🔥 For Fire Code model, availability and ordering method, refer to pages 34-39. Available on select models, contact HON Customer Support for availability.

* Fabric is de-emphasized.

QUOTIENT™



Icon Legend on page 14

HQTMM

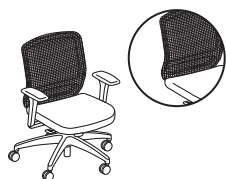

TASK CHAIR

Pneumatic
Swivel
Synchro-tilt
Tilt Tension
Tilt Lock
Functions: **A, E, J, K, L**
(Function Key on pages 16-17)

DIMENSIONS

Depth:	29½	Arm Width:	17½-20
Width:	29½	Seat to Floor Height:	16-22
Height:	38½	Usable Seat Depth:	17
Seat Depth:	19¼	Ship Weight (with arms):	36.5 Ⓢ
Seat Width:	19	Ship Weight (armless):	33.0 Ⓢ
Back Width:	18	Cube (with arms):	7.6
Back Height:	19	Cube (armless):	7.6
		Weight Rating:	300 lbs.

FABRIC PRICE CODES

1	\$394	8	\$463
2	\$406	9	\$472
3	\$418	10	\$481
4	\$427	11	\$490
5	\$436	12	\$499
6	\$445	L	\$494
7	\$454		

HQTSM



TASK STOOL

Pneumatic
Swivel
Synchro-tilt
Tilt Tension
Tilt Lock
Functions: **A, E, J, K, L**
(Function Key on pages 16-17)

DIMENSIONS

Depth:	29½	Arm Width:	17½-20
Width:	29½	Seat to Floor Height:	23-33
Height:	49¼	Usable Seat Depth:	17
Seat Depth:	19¼	Ship Weight (with arms):	42.0 Ⓢ
Seat Width:	19	Ship Weight (armless):	38.5 Ⓢ
Back Width:	18	Cube (with arms):	7.6
Back Height:	19	Cube (armless):	7.6
		Weight Rating:	300 lbs.

FABRIC PRICE CODES

1	\$444	8	\$513
2	\$456	9	\$522
3	\$468	10	\$531
4	\$477	11	\$540
5	\$486	12	\$549
6	\$495	L	\$544
7	\$504		

HON Recommendation: HQTMM.YO.A.H.IM.CU__SB - List Price \$469

HOW TO SPECIFY

Select Model Number HQTMM	Select Control Type YO Synchro-Tilt	Select Arm Type N Armless A Height and Width Adjustable Arms (+ \$75)	Select Caster/Glide H Hard Caster S Soft Caster (+ \$30) G Bell Glide (+ \$25)	Select Mesh Back ilira®-stretch options IM Black	Select Fabric See page 227	Select Base SB Standard Base
HQTMM	YO	A	H	IM	CU10	SB



Riley Ganging Chairs and Tables.

RILEY™

Create a welcoming area that perfectly fits your space and supports your guests with Riley. The linear, streamlined design of this guest chair collection puts you in control over your environment. Chairs can be ganged to create straight rows. Wrap around corner units. Even stand alone. Riley even feels at home in the corner office, with elegant lines, high-quality fabrics and rich hardwood finishes. Riley is a chameleon that is truly a welcome addition to any space.



FEATURES

- Nylon glides slide effortlessly on all surfaces.
- Graceful double-arched arms add style and comfort.
- Chairs can be connected in-line with a table between them, or arranged in an L-configuration by connecting to a corner table (bariatric chair cannot be ganged).
- Catalyzed finish enhances stain and mar resistance.
- HWGN1 is a stand-alone guest chair that can be used with tables on either side.
- Start with model HWGN2 for an in-line ganging layout, add HWGN3 for middle seats and HWGN4 to complete the grouping.
- Solid hardwood in one of eight attractive finishes.
- Available in hundreds of quality HON fabrics.
- Warranted for users up to 250 lbs. (Bariatric chair warranted for users up to 500 lbs.)

AVAILABLE FINISHES

Riley™ Series Seating is available in 8 wood finishes.

WOOD FINISHES

Bourbon Cherry (H)

Cognac (COGN)

Harvest (C)

Mahogany (N)

Mocha (MOCH)

Natural Maple (D)

Pinnacle (PINC)

Shaker Cherry (F)

AVAILABLE FABRICS

GRADE 1	GRADE 2	GRADE 3	GRADE 4	GRADE 5	GRADE 6	GRADE 7	GRADE 8	GRADE 9	GRADE 10	GRADE 11	GRADE 12	GRADE L
Arrondi *	Appoint Seating	Canter Polyurethane	Bar	Amuse	Intermix II	Ascend	Brisa® Polyurethane	Eli Vinyl	Affinity	Acrobat	Fenestra	Denver Leather (Matches EE Vinyl)
Attire	Bangle	Epic	Beeline	Avenue	Keynote	Central	Kindred	Martini Vinyl	Concentric	Natural World	Helix	
Centurion	Clyde	Infinity	Blip	Lariat	Raffia Vinyl	Channel		Olympus Vinyl	Juxy	Whirl	Lava	
Classic	Dotty	Knack	Coin	Outlander	Velocity	Domain		Silica			Ripple	
Compass	Esplanade *	Marathon	Cover Cloth	Polka	Wooly	Synergy		Silica Leather				
Confetti	Expo	Millennium	Current	Riddle		Waver		Silica Tech				
Contourette Polyurethane	Fuse	Odyssey	Decode	Sentry-HC								
Dapper	Gio *	Silvertex™ Vinyl	Disc	Sequence								
Inertia	Moguls	Syntax	Divide	Solace								
Optic	Origin	Tradition	Free	Tribeca								
Sierra Vinyl	Seed	Via	Habit									
Stitchery	Sockhop		Hive									
Tectonic	Spin Seating		Lineup									
	Whisper Vinyl		Manner									
			Medium									
			Messenger									
			Metric									
			Oblique									
			Pick									
			Sprint									
			Technic									

Reference Fabric Color Combinations on pages 18-29 for color codes and legend on page 19 for lead times. Visit hon.com for additional partnership fabrics.

NOTES: Gathers and creases may be more visible with Attire (AI) and Optic (OP) fabrics due to the inherent design and construction of these fabrics. For additional HON to Supply COM fabric grade pricing, go to honready.hon.com and click on the HON to Supply COM link.

🔥 For Fire Code model, availability and ordering method, refer to pages 34-39. Available on select models, contact HON Customer Support for availability.

* Fabric is de-emphasized.

SPECIFYING INFORMATION

Riley models can be ganged to create seating areas in Office, Education or Health care settings. Using Four different seating models as well as two table styles, the possibilities are limitless. Shown below are the Riley models and examples of ganged seating applications. *NOTE THAT ALL REFERENCES TO SIDE ARE FROM THE SEATED PERSPECTIVE.*

HWGN1



Guest Chair

- May be used as a standalone model or for use with table models HWGNC or HWGNT on either side.
- Not for use in ganging with other seating models. No chair connection on either side.

HWGN2



Starter Gang Chair

- May always be part of a ganged seating solution.
- May be used with HWGN3 or tables HWGNC or HWGNT on the left side.
- Left side no connection, right side holes.

HWGN3



In-Line Gang Chair

- Used for in-line positions only. Not for use in a starting or end position due to exposed connection points.
- Left side dowels & bracket, Right side holes.

HWGN4



End Gang Chair

- Connects only to HWGN2 or HWGN3.
- Must be used in the end position.
- Tables may be connected to the Right side.

HWGN5



Bariatric Single Seat

- Standalone model only.
- May not be ganged with other seating or table models.

HWGNC

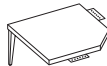

Corner Ganging Table

- For use with models
HWGN1 — Either side
HWGN2 — Left side
HWGN4 — Right side.

HWGNT

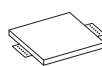

In-Line Ganging Table

- For use with models
HWGN1 — Either side
HWGN2 — Left side
HWGN4 — Right side.

See below for Typical layouts using the models listed above.

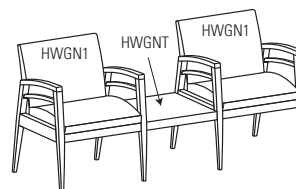
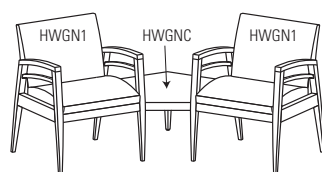
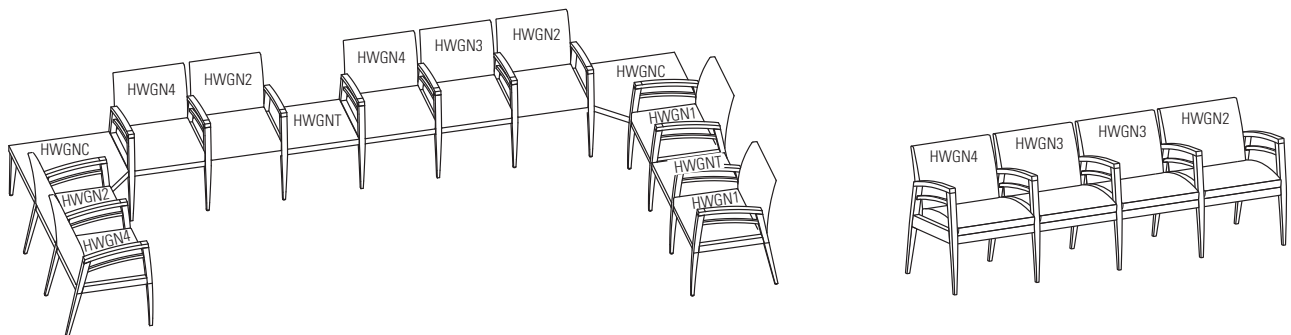

HWGN1



GUEST CHAIR

Leg Base
Arms

DIMENSIONS

Depth:	24¼	Arm Width:	19⅝
Width:	23	Seat to Floor Height:	19
Height:	33¼	Usable Seat Depth:	17½
Seat Depth:	17½	Ship Weight:	35
Seat Width:	19⅝	Cube:	15.1
Back Width:	19¾	COM:	1.5
Back Height:	15½	Weight Rating:	250 lbs.

FABRIC PRICE CODES

1	\$778	8	\$985
2	\$814	9	\$1012
3	\$850	10	\$1039
4	\$877	11	\$1066
5	\$904	12	\$1093
6	\$931	L	\$1078
7	\$958		

NOTES: HWGN1 is a stand alone guest chair that can be used with tables on either side. Coordinating ganging tables available for use with Riley series seating. See page 236.

HWGN2



STARTER GANG CHAIR

Ganging Access on Right Side

DIMENSIONS

Depth:	24¼	Arm Width:	19⅝
Width:	23	Seat to Floor Height:	19
Height:	33¼	Usable Seat Depth:	17½
Seat Depth:	17½	Ship Weight:	35
Seat Width:	19⅝	Cube:	15.1
Back Width:	19¾	COM:	1.5
Back Height:	15½	Weight Rating:	250 lbs.

FABRIC PRICE CODES

1	\$778	8	\$985
2	\$814	9	\$1012
3	\$850	10	\$1039
4	\$877	11	\$1066
5	\$904	12	\$1093
6	\$931	L	\$1078
7	\$958		

NOTES: Start with model HWGN2 for an in-line ganging layout. Add model HWGN3 in between and end with HWGN4 to complete the grouping. Coordinating ganging tables available for use with Riley series seating. See page 236.

HWGN3



IN-LINE GANG LEG CHAIR

Ganging Access on Both Sides

DIMENSIONS

Depth:	24¼	Arm Width:	19⅝
Width:	21½	Seat to Floor Height:	19
Height:	33¼	Usable Seat Depth:	17½
Seat Depth:	17½	Ship Weight:	30
Seat Width:	19⅝	Cube:	15.1
Back Width:	19¾	COM:	1.5
Back Height:	15½	Weight Rating:	250 lbs.

FABRIC PRICE CODES

1	\$660	8	\$867
2	\$696	9	\$894
3	\$732	10	\$921
4	\$759	11	\$948
5	\$786	12	\$975
6	\$813	L	\$960
7	\$840		

NOTES: Start with model HWGN2 for an in-line ganging layout. Add model HWGN3 in between and end with HWGN4 to complete the grouping. Coordinating ganging tables available for use with Riley series seating. See page 236.

HON Recommendation: HWGN1.MOCH.CU__ - List Price \$778

HOW TO SPECIFY

<p>Select Model Number</p> <p style="border: 1px solid black; padding: 2px;">H W G N 1</p>	<p>Select Finish</p> <p>See page 230</p> <p style="border: 1px solid black; padding: 2px;">M O C H</p>	<p>Select Fabric</p> <p>See page 230</p> <p style="border: 1px solid black; padding: 2px;">C U 1 0</p>
--	--	--



HWGN4



END GANG LEG CHAIR

Ganging Access on Left Side

DIMENSIONS

Depth:	24¼	Arm Width:	19⅝
Width:	21½	Seat to Floor Height:	19
Height:	33¼	Usable Seat Depth:	17½
Seat Depth:	17½	Ship Weight:	30
Seat Width:	19⅝	Cube:	15.1
Back Width:	19¾	COM:	1.5
Back Height:	15½	Weight Rating:	250 lbs.

FABRIC PRICE CODES

1	\$660	8	\$867
2	\$696	9	\$894
3	\$732	10	\$921
4	\$759	11	\$948
5	\$786	12	\$975
6	\$813	L	\$960
7	\$840		

NOTES: Start with model HWGN2 for an in-line ganging layout. Add model HWGN3 in between and end with HWGN4 to complete the grouping. Coordinating ganging tables available for use with Riley series seating. See page 236.

HWGN5

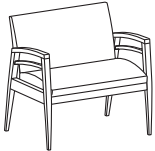

BARIATRIC SINGLE SEAT

Leg Base
Arms

DIMENSIONS

Depth:	26½	Arm Width:	30¼
Width:	34	Seat to Floor Height:	18½
Height:	33½	Usable Seat Depth:	18
Seat Depth:	18	Ship Weight:	80
Seat Width:	30¼	Cube:	40.6
Back Width:	30¼	COM:	2.5
Back Height:	18	Weight Rating:	500 lbs.

FABRIC PRICE CODES

1	\$1297	8	\$1642
2	\$1357	9	\$1687
3	\$1417	10	\$1732
4	\$1462	11	\$1777
5	\$1507	12	\$1822
6	\$1552	L	\$1797
7	\$1597		

NOTES: Coordinating ganging tables available for use with Riley series seating. See page 236.

❗ HWGN5 is a Single Seat Bariatric chair warranted to 500 lbs. Not designed to be used for ganging.

HON Recommendation: HWGN5.MOCH.CU__ - List Price \$1297

HOW TO SPECIFY

<p>Select Model Number</p> <p>HWGN5</p>	<p>Select Finish</p> <p>See page 230</p> <p>MOCH</p>	<p>Select Fabric</p> <p>See page 230</p> <p>CU10</p>
--	---	---



HWGN1B



GUEST CHAIR

Wipe-out Back
Leg Base
Arms

DIMENSIONS

Depth:	24¼	Arm Width:	19⅝
Width:	23	Seat to Floor Height:	19
Height:	33¼	Usable Seat Depth:	17½
Seat Depth:	17½	Ship Weight:	35
Seat Width:	19⅝	Cube:	15.1
Back Width:	19¾	COM:	2.0
Back Height:	15½	Weight Rating:	250 lbs.

FABRIC PRICE CODES

1	\$853	8	\$1060
2	\$889	9	\$1087
3	\$925	10	\$1114
4	\$952	11	\$1141
5	\$979	12	\$1168
6	\$1006	L	\$1153
7	\$1033		

NOTES: HWGN1B is a stand alone guest chair that can be used with tables on either side.

HWGN2B



STARTER GANG CHAIR

Wipe-out Back
Ganging Access on
Right Side

DIMENSIONS

Depth:	24¼	Arm Width:	19⅝
Width:	23	Seat to Floor Height:	19
Height:	33¼	Usable Seat Depth:	17½
Seat Depth:	17½	Ship Weight:	35
Seat Width:	19⅝	Cube:	15.1
Back Width:	19¾	COM:	2.0
Back Height:	15½	Weight Rating:	250 lbs.

FABRIC PRICE CODES

1	\$853	8	\$1060
2	\$889	9	\$1087
3	\$925	10	\$1114
4	\$952	11	\$1141
5	\$979	12	\$1168
6	\$1006	L	\$1153
7	\$1033		

NOTES: Start with model HWGN2B for an in-line ganging layout. Add model HWGN3B in between and end with HWGN4B to complete the grouping.

HWGN3B



IN-LINE GANG LEG CHAIR

Wipe-out Back
Ganging Access on
Both Sides

DIMENSIONS

Depth:	24¼	Arm Width:	19⅝
Width:	21½	Seat to Floor Height:	19
Height:	33¼	Usable Seat Depth:	17½
Seat Depth:	17½	Ship Weight:	30
Seat Width:	19⅝	Cube:	15.1
Back Width:	19¾	COM:	2.0
Back Height:	15½	Weight Rating:	250 lbs.

FABRIC PRICE CODES

1	\$735	8	\$942
2	\$771	9	\$969
3	\$807	10	\$996
4	\$834	11	\$1023
5	\$861	12	\$1050
6	\$888	L	\$1035
7	\$915		

NOTES: Start with model HWGN2B for an in-line ganging layout. Add model HWGN3B in between and end with HWGN4B to complete the grouping.

HON Recommendation: HWGN1B.MOCH.CU__ - List Price \$853

HOW TO SPECIFY

<p>Select Model Number</p> <p>HWGN1B.</p>	<p>Select Finish</p> <p>See page 230</p> <p>MOCH.</p>	<p>Select Fabric</p> <p>See page 230</p> <p>CU10</p>
---	---	--



HWGN4B



END GANG LEG CHAIR

Wipe-out Back
Gangling Access on
Left Side

DIMENSIONS

Depth:	24½	Arm Width:	19½
Width:	21½	Seat to Floor Height:	19
Height:	33¼	Usable Seat Depth:	17½
Seat Depth:	17½	Ship Weight:	30
Seat Width:	19¾	Cube:	15.1
Back Width:	19¾	COM:	2.0
Back Height:	15½	Weight Rating:	250 lbs.

FABRIC PRICE CODES

1	\$735	8	\$942
2	\$771	9	\$969
3	\$807	10	\$996
4	\$834	11	\$1023
5	\$861	12	\$1050
6	\$888	L	\$1035
7	\$915		

NOTES: Start with model HWGN2B for an in-line gangling layout. Add model HWGN3B in between and end with HWGN4B to complete the grouping.

HWGN5B



BARIATRIC SINGLE SEAT

Wipe-out Back
Leg Base
Arms

DIMENSIONS

Depth:	26½	Arm Width:	30¼
Width:	34	Seat to Floor Height:	18½
Height:	33½	Usable Seat Depth:	18
Seat Depth:	18	Ship Weight:	80
Seat Width:	30¼	Cube:	40.6
Back Width:	30¼	COM:	2.5
Back Height:	18	Weight Rating:	500 lbs.

FABRIC PRICE CODES

1	\$1372	8	\$1717
2	\$1432	9	\$1762
3	\$1492	10	\$1807
4	\$1537	11	\$1852
5	\$1582	12	\$1897
6	\$1627	L	\$1872
7	\$1672		

! HWGN5B is a Single Seat Bariatric chair warranted to 500 lbs. Not designed to be used for gangling.

HON Recommendation: HWGN5B.MOCH.CU__ - List Price \$1372

HOW TO SPECIFY

<p>Select Model Number</p> <p style="text-align: center; border: 1px solid black; margin-top: 10px;">H W G N 5 B .</p>	<p>Select Finish</p> <p style="text-align: center;">See page 230</p> <p style="text-align: center; border: 1px solid black; margin-top: 10px;">M O C H .</p>	<p>Select Fabric</p> <p style="text-align: center;">See page 230</p> <p style="text-align: center; border: 1px solid black; margin-top: 10px;">C U 1 0</p>
---	---	---



HWGNC

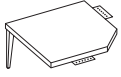

CORNER GANGING TABLE

DIMENSIONS

- Includes leg and two brackets.
- Mounting height — 16”.
- For use with Riley seating models HWGN1, HWGN2 and HWGN4.
- Attaches to Riley seating models for an in-line or corner ganging application.
- Specify wood finish.
- Made from select hardwoods.

Depth: 28
Width: 28
Height: 16

Ship Weight: 48 Ⓢ
Cube: 3.3

LIST PRICE

\$635

HWGNT

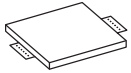

CENTER GANGING TABLE

DIMENSIONS

- Includes two brackets.
- Mounting height — 16”.
- For use with Riley seating models HWGN1, HWGN2 and HWGN4.
- Attaches to Riley seating models for an in-line or corner ganging application.
- Specify wood finish.
- Made from select hardwoods.

Depth: 20¼
Width: 20¼
Height: 16

Ship Weight: 28 Ⓢ
Cube: 1.7

LIST PRICE

\$444

HON Recommendation: HWGNC.MOCH - List Price \$635

HOW TO SPECIFY

Select Model Number	Select Finish
	See page 230
HWGNC	MOCH

SOLUTIONS SEATING® 4000 SERIES



Solutions Managerial Mid-Back Chair shown with 34000 Series Desk and Brigade® 700 Series Lateral Files.

SOLUTIONS SEATING® 4000 SERIES

Looking for the perfect answer for your task and guest chair needs? HON has four Solutions for everything from workstations to open areas. The Solutions series includes a high-back and mid-back task chair, as well as matching four-leg and sled base guest chairs. The floating backrest provides ergonomic support for your spine. The tilt mechanism delivers a natural recline. Solutions are the chairs that really live up to their name.



TASK CHAIR FEATURES

- One-touch seat height adjustment easily moves the seat up and down.
- Tilt tension controls the rate and ease of recline.
- Tilt lock allows the user to lock out the tilt function.
- 360-degree swivel provides freedom of movement in any direction.
- Model H4001 has a fully-upholstered outer back.
- Model H4002 has a molded polymer outer back shell color to match the base.
- Back cushion enhances lumbar support and minimizes fatigue.
- Dual-wheeled, hooded casters roll effortlessly and quietly.
- Available in hundreds of quality HON fabrics.
- Warranted for users up to 300 lbs.

GUEST CHAIR FEATURES

- Molded polymer outer back shell color matches the base.
- Back cushion enhances lumbar support and minimizes fatigue.
- Available in hundreds of quality HON fabrics.
- Warranted for users up to 300 lbs.

SOLUTIONS SEATING®

4000 Series Options

MODEL OPTIONS

H4001



Executive High-Back

Pneumatic, Swivel, Tilt, Tilt Tension, Tilt Lock, Loop Arms

H4002

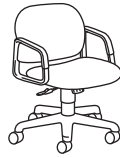

Managerial Mid-Back

Pneumatic, Swivel, Tilt, Tilt Tension, Tilt Lock, Loop Arms

H4003



Guest Chair

Leg Base, Arms

H4008



Guest Chair

Sled Base, Arms

CASTERS



CODE	DESCRIPTION	PRICE
H	Hard Caster	+ \$0



S	Soft Caster	+ \$30
----------	-------------	---------------

*Specify for models H4001 and H4002 only

FRAME

CODE	DESCRIPTION	PRICE
T	Black	+ \$0

AVAILABLE FABRICS

GRADE 1	GRADE 2	GRADE 3	GRADE 4	GRADE 5	GRADE 6	GRADE 7	GRADE 8	GRADE 9	GRADE 10	GRADE 11	GRADE 12	GRADE L
Arrondi *	Appoint Seating	Canter Polyurethane	Bar	Amuse	Intermix II	Ascend	Brisa® Polyurethane Kindred	Eli Vinyl	Affinity	Acrobat	Fenestra	
Attire	Bangle	Epic	Beeline	Avenue	Keynote	Central		Martini Vinyl	Concentric	Natural World	Helix	
Centurion	Clyde	Infinity	Blip	Lariat	Raffia Vinyl	Channel		Olympus Vinyl	Juxy	Whirl	Lava	
Classic	Dotty	Knack	Coin	Outlander	Velocity	Domain		Silica			Ripple	
Compass	Esplanade *	Marathon	Cover Cloth	Polka	Wooly	Synergy		Silica Leather				
Confetti	Expo	Millennium	Current	Riddle		Waver		Silica Tech				
Contourette	Fuse	Odyssey	Decode	Sentry-HC								
Polyurethane	Gio *	Silvertex™ Vinyl	Disc	Sequence								
Dapper	Moguls	Vinyl	Divide	Solace								
Inertia	Origin	Syntax	Free	Tribeca								
Optic	Seed	Tradition	Habit									
Stitchery	Sockhop	Via	Hive									
Tectonic	Spin Seating		Lineup									
	Whisper Vinyl		Manner									
			Medium									
			Messenger									
			Metric									
			Oblique									
			Pick									
			Sprint									
			Technic									

Reference Fabric Color Combinations on pages 18-29 for color codes and legend on page 19 for lead times. Visit hon.com for additional partnership fabrics.

NOTES: Gathers and creases may be more visible with Attire (AI) and Optic (OP) fabrics due to the inherent design and construction of these fabrics. COM yardage shown is for Pattern Cut only. Contact Customer Service for Railroaded yardage requirements. For additional HON to Supply COM fabric grade pricing, go to honready.hon.com and click on the HON to Supply COM link.

🔥 For Fire Code model, availability and ordering method, refer to pages 34-39. Available on select models, contact HON Customer Support for availability.

* Fabric is de-emphasized.



SOLUTIONS SEATING®

4000 Series

H4001



EXECUTIVE HIGH-BACK

Pneumatic
Swivel
Tilt
Tilt Tension
Tilt Lock
Loop Arms
Functions: **A, E, F, K, L**
(Function Key on pages 16-17)

DIMENSIONS

Depth: 27
Width: 26
Height: 39¾
Seat Depth: 18
Seat Width: 20
Back Width: 20½
Back Height: 20¾
Arm Width: 20¼
Seat to Floor Height: 16¾-21¾
Usable Seat Depth: 17¾
Ship Weight: 45
Cube: 10.3
COM: 1.5
Weight Rating: 250 lbs.

FABRIC PRICE CODES

1	\$409	8	\$616
2	\$445	9	\$643
3	\$481	10	\$670
4	\$508	11	\$697
5	\$535	12	\$724
6	\$562	L	—
7	\$589		

H4002



MANAGERIAL MID-BACK

Pneumatic
Swivel
Tilt
Tilt Tension
Tilt Lock
Loop Arms
Functions: **A, E, F, K, L**
(Function Key on pages 16-17)

DIMENSIONS

Depth: 26¼
Width: 26
Height: 35½
Seat Depth: 18
Seat Width: 20
Back Width: 21
Back Height: 15
Arm Width: 18¾
Seat to Floor Height: 16¾-21¾
Usable Seat Depth: 17¾
Ship Weight: 38
Cube: 8.6
COM: 1.0
Weight Rating: 250 lbs.

FABRIC PRICE CODES

1	\$370	8	\$508
2	\$394	9	\$526
3	\$418	10	\$544
4	\$436	11	\$562
5	\$454	12	\$580
6	\$472	L	—
7	\$490		

H4003



GUEST CHAIR

Leg Base
Arms

DIMENSIONS

Depth: 24½
Width: 23½
Height: 32
Seat Depth: 18
Seat Width: 20
Back Width: 21
Back Height: 15
Arm Width: 18¾
Seat to Floor Height: 19¼
Usable Seat Depth: 18¼
Ship Weight: 29
Cube: 12.6
COM: 1.0
Weight Rating: 250 lbs.

FABRIC PRICE CODES

1	\$280	8	\$418
2	\$304	9	\$436
3	\$328	10	\$454
4	\$346	11	\$472
5	\$364	12	\$490
6	\$382	L	—
7	\$400		

H4008

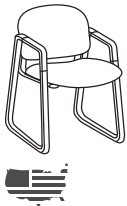

GUEST CHAIR

Sled Base
Arms

DIMENSIONS

Depth: 25½
Width: 23½
Height: 32½
Seat Depth: 18
Seat Width: 20
Back Width: 21
Back Height: 15
Arm Width: 19
Seat to Floor Height: 19¼
Usable Seat Depth: 18¼
Ship Weight: 33
Cube: 12.6
COM: 1.0
Weight Rating: 250 lbs.

FABRIC PRICE CODES

1	\$311	8	\$449
2	\$335	9	\$467
3	\$359	10	\$485
4	\$377	11	\$503
5	\$395	12	\$521
6	\$413	L	—
7	\$431		

HON Recommendation: H4001.H.CU__T - List Price \$409
H4008.CU__T - List Price \$311

HOW TO SPECIFY

Select Model Number	Select Caster	Select Fabric	Select Frame
	H Hard Caster S Soft Caster (+ \$30) <i>Specify for models H4001 and H4002 only</i>	See page 238	T Black
H 4 0 0 8 .	H .	C U 1 0 .	T

SOLVE™



Solve Task Chairs and Stools.

SOLVE™

If you want to make a powerful statement, simply have a seat. With three back materials and an optional adjustable lumbar support, Solve answers the need for a higher level of personalization. Solve task chairs feature a geometric ReActiv™ back to create a contemporary look, while the ilira®-stretch mesh back offers a softer, more relaxed feel. The synchronized seat and back move in harmony with the user to provide continuous comfort that can be customized. Helping anyone achieve optimal balance, proper alignment and lumbar support, Solve is an ideal solution for everywhere and everybody.



FEATURES

- Synchronized seat and back create continuous comfort.
- ilira®-stretch mesh back is available in three colors.
- Waterfall seat edge encourages leg circulation.
- Seat depth adjustment adapts to users of various heights.
- ReActiv™ back design moves with your body to provide continuous support and airflow for lasting comfort.
- Choose one of three control types — synchro-tilt, synchro-tilt with seat slider and advanced synchro-tilt.
- Choose armless or height- and width-adjustable arms.
- Available with bell glides, hard casters or soft casters.
- Upholstered ReActiv™ back offers all the benefits of the ReActiv™ back with a fabric cover for additional comfort.
- Back upholstery available in one of six attractive fabrics.
- Mesh available in one of five colors.
- Integrated lumbar support delivers long-lasting comfort.
- Warranted for users up to 300 lbs.

MODEL OPTIONS

HSLVTMM



Mid-Back Task (ilira®-Stretch Back)

Pneumatic, Swivel, Synchro-tilt,
Tilt Tension, Tilt Lock

HSLVSMM



Stool (ilira®-Stretch Back)

Pneumatic, Swivel, Synchro-tilt,
Tilt Tension, Tilt Lock

HSLVTMR



Mid-Back Task (ReActiv™ Back)

Pneumatic, Swivel, Synchro-tilt,
Tilt Tension, Tilt Lock

HSLVSMR



Stool (ReActiv™ Back)

Pneumatic, Swivel, Synchro-tilt,
Tilt Tension, Tilt Lock

HSLVTMU



Mid-Back Task (Upholstered Back)

Pneumatic, Swivel, Synchro-tilt,
Tilt Tension, Tilt Lock

HSLVSMU





Stool (Upholstered Back)



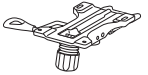
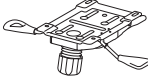
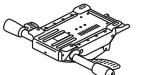

Pneumatic, Swivel, Synchro-tilt,
Tilt Tension, Tilt Lock





SOLVE™ Options

MECHANISM	CODE	DESCRIPTION	PRICE
	Y0	Synchro-Tilt A, E, J, K, L	+\$0
	Y1	Synchro-Tilt w/Seat Slider A, D, E, J, K, L	+\$20
	Y2	Advanced Synchro-Tilt A, D, E, J, L, A-D	+\$65

*Y2 control not available on stool models

ARM STYLE	CODE	DESCRIPTION	PRICE
	N	Armless	+\$0
	F	Fixed Arms	+\$65
	A	Height and Width Adjustable Arms	+\$75
	V	All-Adjustable Arms (includes Pivot)	+\$115

CASTERS/ GLIDE	CODE	DESCRIPTION	PRICE
	H	Hard Caster	+\$0
	S	Soft Caster	+\$30
	R	Roll Control Caster	+\$50
	G	Bell Glide	+\$25

BACK STYLE	CODE	DESCRIPTION	PRICE
<i>ilira®-stretch mesh back options:</i>			
	IM	Black	+\$0
	IF	Fog	+\$0
	IC	Charcoal	+\$0
	IH	Chai	+\$0
	IY	Navy	+\$0
<i>ReActive™ back options:</i>			
	OS	Charcoal	+\$0
	TI	Titanium	+\$0
<i>Fabric options:</i>			
	COMF46	Bittersweet	+\$0
	COMF10	Ink	+\$0
	COMF82	Meadow	+\$0
	COMF90	Midnight	+\$0
	COMF22	Putty	+\$0
	COMF19	Sterling	+\$0

LUMBAR	CODE	DESCRIPTION	PRICE
	NL	No Lumbar	+\$0
	BL	Black Adjustable Lumbar	+\$30
	TL	Titanium Adjustable Lumbar	+\$30

BASE	CODE	DESCRIPTION	PRICE
	SB	Standard Base	+\$0

FRAME	CODE	DESCRIPTION	PRICE
	T	Black	+\$0
	TI	Titanium	+\$35

AVAILABLE FABRICS

GRADE 1	GRADE 2	GRADE 3	GRADE 4	GRADE 5	GRADE 6	GRADE 7	GRADE 8	GRADE 9	GRADE 10	GRADE 11	GRADE 12	GRADE L
Arrondi *	Appoint	Canter	Bar	Amuse	Intermix II	Ascend	Brisa®	Eli Vinyl	Affinity	Acrobat	Fenestra	Denver
Attire *	Seating	Polyurethane	Beeline	Avenue	Keynote	Central	Polyurethane	Martini Vinyl	Concentric	Natural	Helix	Leather
Centurion	Bangle	Epic	Blip	Lariat	Raffia Vinyl	Channel	Kindred	Olympus	Juxy	World	Lava	(Matches
Classic	Clyde	Infinity	Coin	Outlander	Velocity	Domain		Vinyl		Whirl	Ripple	EE Vinyl)
Compass	Dotty	Knack	Cover Cloth	Polka	Wooly	Synergy		Silica				(Seat
Compass	Esplanade *	Marathon	Current	Riddle		Waver		Silica Leather				Only)
Foam	Expo	Millennium	Decode	Sentry-HC				Silica Tech				
Confetti	Fuse	Odyssey	Disc	Sequence								
Contourette	Gio *	Silvertex™	Divide	Solace								
Polyurethane	Moguls	Vinyl	Free	Tribeca								
Dapper	Origin	Syntax	Habit									
Inertia	Seed	Tradition	Hive									
Optic	Sockhop	Via	Lineup									
Stitchery	Spin Seating		Manner									
Tectonic	Whisper		Medium									
	Vinyl		Messenger									
			Metric									
			Oblique									
			Pick									
			Sprint									
			Technic									

Reference Fabric Color Combinations on pages 18-29 for color codes and legend on page 19 for lead times. Visit hon.com for additional partnership fabrics.

NOTES: Gathers and creases may be more visible with Attire (AI) and Optic (OP) fabrics due to the inherent design and construction of these fabrics.

🔥 For Fire Code model, availability and ordering method, refer to pages 34-39. Available on select models, contact HON Customer Support for availability.

* Fabric is de-emphasized.

DIMENSIONS

NOTE: When selecting the .TI Titanium frame option, the chair's back frame, arms, and base will come as titanium. ilira®, ReActiv™, and/or lumbar color must be selected separately.

When selecting the .F fixed arm option, the arms will ship unattached.

MODEL		HSLVTMM	HSLVSM	HSLVTMR	HSLVSMR	HSLVTMU	HSLVSMU
Overall Width Armless		29½"	29½"	29½"	29½"	29½"	29½"
Overall Width with Arms	(A)	29½"	29½"	29½"	29½"	29½"	29½"
Overall Depth		29½"	29½"	29½"	29½"	29½"	29½"
Overall Height - Max	(Y0/Y1) (Y2)	41¾" 42½"	52¾" —	41¾" 42½"	52¾" —	41¾" 42½"	52¾" —
Seat Width		19"	19"	19"	19"	19"	19"
Seat Depth (Cushion)		19¼"	19¼"	19¼"	19¼"	19¼"	19¼"
Usable Seat Depth	(Y0) (Y1) (Y2)	17⅝" 16¼"-18½" 16¼"-19¼"	17⅝" 16¼"-18½" —	17⅝" 16¼"-18½" 16¼"-19¼"	17⅝" 16¼"-18½" —	17⅝" 16¼"-18½" 16¼"-19¼"	17⅝" 16¼"-18½" —
Seat Height	(Y0/Y1) (Y2)	16¾"-21¾" 17½"-22½"	22¾"-32¾" —	16¾"-21¾" 17½"-22½"	22¾"-32¾" —	16¾"-21¾" 17½"-22½"	22¾"-32¾" —
Back Width		18¼"	18¼"	18¼"	18¼"	18¼"	18¼"
Back Height		22⅝"	22⅝"	22⅝"	22⅝"	22⅝"	22⅝"
Ship Weight Armless	(Y0) (Y1) (Y2)	40 Ⓢ 42 Ⓢ 45 Ⓢ	45 Ⓢ 47 Ⓢ —	41 Ⓢ 43 Ⓢ 46 Ⓢ	46 Ⓢ 48 Ⓢ —	41 Ⓢ 43 Ⓢ 46 Ⓢ	46 Ⓢ 48 Ⓢ —
Ship Weight with Arms	(Y0) (Y1) (Y2)	44 Ⓢ 46 Ⓢ 49 Ⓢ	49 Ⓢ 51 Ⓢ —	45 Ⓢ 47 Ⓢ 50 Ⓢ	50 Ⓢ 52 Ⓢ —	45 Ⓢ 47 Ⓢ 50 Ⓢ	50 Ⓢ 52 Ⓢ —
Width Between Arms		17½"-20"	17½"-20"	17½"-20"	17½"-20"	17½"-20"	17½"-20"
COM		1.0	1.0	1.0	1.0	1.0	1.0
Weight Capacity		300 lbs	300 lbs	300 lbs	300 lbs	300 lbs	300 lbs

SOLVE™

Icon Legend on page 14

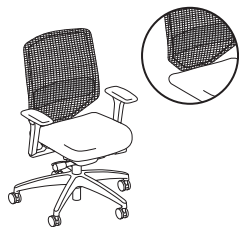
HSLVTMM**MID-BACK TASK****ilira®-Stretch Back**

Pneumatic
Swivel
Synchro-tilt
Tilt Tension
Tilt Lock

DIMENSIONS

Seat Depth: 19¼ Arm Width: 17½-20
Seat Width: 19 Cube: 7.6
Back Width: 18¼ Weight Rating: 300 lbs.
Back Height: 22¾

FABRIC PRICE CODES

1	\$419	8	\$488
2	\$431	9	\$497
3	\$443	10	\$506
4	\$452	11	\$515
5	\$461	12	\$524
6	\$470	L	\$519
7	\$479		

NOTES: Please reference pages 242-243 for additional specifications and mechanism information.

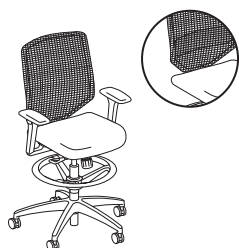
HSLVSMM**STOOL****ilira®-Stretch Back**

Pneumatic
Swivel
Synchro-tilt
Tilt Tension
Tilt Lock

DIMENSIONS

Seat Depth: 19¼ Arm Width: 17½-20
Seat Width: 19 Cube: 7.6
Back Width: 18¼ Weight Rating: 300 lbs.
Back Height: 22¾

FABRIC PRICE CODES

1	\$469	8	\$538
2	\$481	9	\$547
3	\$493	10	\$556
4	\$502	11	\$565
5	\$511	12	\$574
6	\$520	L	\$569
7	\$529		

NOTES: Please reference pages 242-243 for additional specifications and mechanism information.

HON Recommendation: HSLVTMM.Y1.A.S.IM.CU__BL.SB.T - List Price \$574**HOW TO SPECIFY**

Select Model Number	Select Control Type	Select Arm Type	Select Caster/Glide	Select Mesh Back	Select Fabric	Select Lumbar	Select Base	Select Frame
Y0 Synchro-Tilt Y1 Synchro-Tilt w/ Seat Slider (+ \$20) Y2 Advanced Synchro-Tilt (+ \$65) <i>Y2 not available on stool</i>	N Armless F Fixed Arms (+ \$65) A Height and Width Adjustable Arms (+ \$75) V All-Adjustable Arms (includes pivot) (+ \$115)	H Hard Caster S Soft Caster (+ \$30) G Bell Glide (+ \$25) R Roll Control Caster (+ \$50)	ilira®-stretch options IM Black IF Fog IC Charcoal IH Chai IY Navy	See page 243	NL No Lumbar BL Black Adjustable Lumbar (+ \$30) TL Titanium Adjustable Lumbar (+ \$30)	SB Standard Base	T Black TI Titanium (+ \$35)	
H S L V T M M .	Y 1 .	A .	S .	I M .	C U 1 0 .	B L .	S B .	T



HSLVTMR

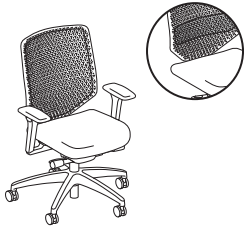

MID-BACK TASK

- ReActiv™ Back**
- Pneumatic
- Swivel
- Synchro-tilt
- Tilt Tension
- Tilt Lock

DIMENSIONS

Seat Depth:	19¼	Arm Width:	17½-20
Seat Width:	19	Cube:	7.6
Back Width:	18¼	Weight Rating:	300 lbs.
Back Height:	22¾		

FABRIC PRICE CODES

1	\$444	8	\$513
2	\$456	9	\$522
3	\$468	10	\$531
4	\$477	11	\$540
5	\$486	12	\$549
6	\$495	L	\$544
7	\$504		

NOTES: Please reference pages 242-243 for additional specifications and mechanism information.

HSLVSMR



STOOL

- ReActiv™ Back**
- Pneumatic
- Swivel
- Synchro-tilt
- Tilt Tension
- Tilt Lock

DIMENSIONS

Seat Depth:	19¼	Arm Width:	17½-20
Seat Width:	19	Cube:	7.6
Back Width:	18¼	Weight Rating:	300 lbs.
Back Height:	22¾		

FABRIC PRICE CODES

1	\$494	8	\$563
2	\$506	9	\$572
3	\$518	10	\$581
4	\$527	11	\$590
5	\$536	12	\$599
6	\$545	L	\$594
7	\$554		

NOTES: Please reference pages 242-243 for additional specifications and mechanism information.

HON Recommendation: HSLVTMR.Y1.A.H.OS.CU__NL.SB.T - List Price \$539

HOW TO SPECIFY

Select Model Number	Select Control Type	Select Arm Type	Select Caster/Glide	Select Back	Select Fabric	Select Lumbar	Select Base	Select Frame
Y0 Synchro-Tilt Y1 Synchro-Tilt w/ Seat Slider (+ \$20) Y2 Advanced Synchro-Tilt (+ \$65) <i>Y2 not available on stool</i>	N Armless F Fixed Arms (+ \$65) A Height and Width Adjustable Arms (+ \$75) V All-Adjustable Arms (includes pivot) (+ \$115)	H Hard Caster S Soft Caster (+ \$30) G Bell Glide (+ \$25) R Roll Control Caster (+ \$50)	OS Charcoal TI Titanium	See page 243	NL No Lumbar BL Black Adjustable Lumbar (+ \$30) TL Titanium Adjustable Lumbar (+ \$30)	SB Standard Base	T Black TI Titanium (+ \$35)	
H S L V T M R .	Y 1 .	A .	H .	O S .	C U 1 0 .	N L .	S B .	T

SOLVE™

Icon Legend on page 14

HSLVTMU**MID-BACK TASK****Upholstered Back**

Pneumatic
Swivel
Synchro-tilt
Tilt Tension
Tilt Lock

DIMENSIONS

Seat Depth: 19¼ Arm Width: 17½-20
Seat Width: 19 Cube: 7.6
Back Width: 18¼ Weight Rating: 300 lbs.
Back Height: 22¾

FABRIC PRICE CODES

1	\$459	8	\$528
2	\$471	9	\$537
3	\$483	10	\$546
4	\$492	11	\$555
5	\$501	12	\$564
6	\$510	L	\$559
7	\$519		

NOTES: Please reference pages 242-243 for additional specifications and mechanism information.

HSLVSMU**STOOL****Upholstered Back**

Pneumatic
Swivel
Synchro-tilt
Tilt Tension
Tilt Lock

DIMENSIONS

Seat Depth: 19¼ Arm Width: 17½-20
Seat Width: 19 Cube: 7.6
Back Width: 18¼ Weight Rating: 300 lbs.
Back Height: 22¾

FABRIC PRICE CODES

1	\$509	8	\$578
2	\$521	9	\$587
3	\$533	10	\$596
4	\$542	11	\$605
5	\$551	12	\$614
6	\$560	L	\$609
7	\$569		

NOTES: Please reference pages 242-243 for additional specifications and mechanism information.

HON Recommendation: HSLVTMU.Y1.A.H.OS.COMF10.COMP10.NL.SB.T - List Price \$554**HOW TO SPECIFY**

Select Model Number	Select Control Type	Select Arm Type	Select Caster/Glide	Select Back Color	Select Back Fabric	Select Seat Fabric	Select Lumbar	Select Base	Select Frame
Y0 Synchro-Tilt Y1 Synchro-Tilt w/ Seat Slider (+ \$20) Y2 Advanced Synchro-Tilt (+ \$65) <i>Y2 not available on stool</i>	N Armless F Fixed Arms (+ \$65) A Height and Width Adjustable Arms (+ \$75) V All-Adjustable Arms (includes pivot) (+ \$115)	H Hard Caster S Soft Caster (+ \$30) G Bell Glide (+ \$25) R Roll Control Caster (+ \$50)	OS Charcoal TI Titanium	COMF46 Bittersweet COMF10 Ink COMF82 Meadow COMF90 Midnight COMF22 Putty COMF19 Sterling	See page 243	NL No Lumbar BL Black Adjustable Lumbar (+ \$30) TL Titanium Adjustable Lumbar (+ \$30)	SB Standard Base	T Black TI Titanium (+ \$35)	
H S L V T M U .	Y 1 .	A .	H .	O S .	C O M F 1 0 .	C O M P 1 0 .	N L .	S B .	T



HSLVTMMKD

MID-BACK TASK

DIMENSIONS

FABRIC PRICE CODES

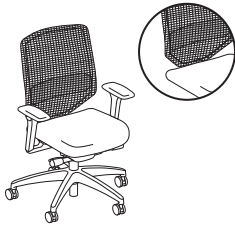

ilira®-Stretch Back
 Pneumatic
 Swivel
 Synchro-tilt
 Tilt Tension
 Tilt Lock

Seat Depth: 19¼ Arm Width: 17½-20
 Seat Width: 19 Cube: 7.6
 Back Width: 18¼ Weight Rating: 300 lbs.
 Back Height: 22¾

1 \$379
2 \$391
3 \$403

NOTES: Please reference pages 242-243 for additional specifications and mechanism information.

HSLVTMRKD

MID-BACK TASK

DIMENSIONS

FABRIC PRICE CODES

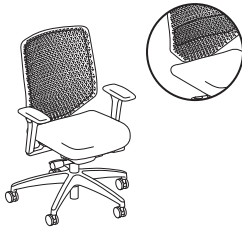

ReActiv™ Back
 Pneumatic
 Swivel
 Synchro-tilt
 Tilt Tension
 Tilt Lock

Seat Depth: 19¼ Arm Width: 17½-20
 Seat Width: 19 Cube: 7.6
 Back Width: 18¼ Weight Rating: 300 lbs.
 Back Height: 22¾

1 \$404
2 \$416
3 \$428

NOTES: Please reference pages 242-243 for additional specifications and mechanism information.

HSLVTMUKD

MID-BACK TASK

DIMENSIONS

FABRIC PRICE CODES

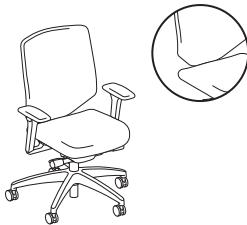

Upholstered Back
 Pneumatic
 Swivel
 Synchro-tilt
 Tilt Tension
 Tilt Lock

Seat Depth: 19¼ Arm Width: 17½-20
 Seat Width: 19 Cube: 7.6
 Back Width: 18¼ Weight Rating: 300 lbs.
 Back Height: 22¾

1 \$419
2 \$431
3 \$443

NOTES: Please reference pages 242-243 for additional specifications and mechanism information.

HON Recommendation: HSLVTMMKD.Y1.A.H.IM.CU__BL.SB.T - List Price \$504

HOW TO SPECIFY

Select Model Number	Select Control Type	Select Arm Type	Select Caster	Select Mesh Back	Select Back Color	Select Back Fabric	Select Seat Fabric	Select Lumbar	Select Base	Select Frame
	Y1 Synchro-Tilt w/ Seat Slider (+ \$20)	A Height and Width Adjustable Arms (+ \$75)	H Hard Caster	ilira® -stretch options IM Black <i>Specify for model HSLVTMMKD only</i>	OS Charcoal TI Titanium <i>Specify for models HSLVTMRKD and HSLVTMUKD only</i>	COMF46 Bittersweet COMF10 Ink COMF82 Meadow COMF90 Midnight COMF22 Putty COMF19 Sterling <i>Specify for model HSLVTMUKD only</i>	See page 243	NL No Lumbar BL Black Adjustable Lumbar (+ \$30)	SB Standard Base	T Black
HSLVTMMKD	Y1	A	H	IM			CU10	BL	SB	T
HSLVTMRKD	Y1	A	H		OS		CU10	BL	SB	T
HSLVTMUKD	Y1	A	H		OS	COMF46	CU10	BL	SB	T

SOLVE™ Accessories

NOT ON GSA CONTRACT



Icon Legend on page 14

HSLVLMBR

LUMBAR PACK

DIMENSIONS

LIST PRICE

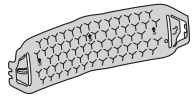

Ship Weight: 1 Ⓢ
Cube: 0.2

\$30

HSLVFAP

FIXED ARM PACK

DIMENSIONS

LIST PRICE



Ship Weight: 6 Ⓢ
Cube: 1.0

\$104

HSLV2DAP

ADJUSTABLE ARM PACK

DIMENSIONS

LIST PRICE



Height and Width

Adjustable Arms Width: 17½-20
Height from Seat: 7¼-11¼
Ship Weight: 6 Ⓢ
Cube: 1.0

\$114

HSLV4DAP

ALL-ADJUSTABLE ARM PACK

DIMENSIONS

LIST PRICE



Including Pivot

Ship Weight: 6 Ⓢ
Cube: 1.0

\$154

HOW TO SPECIFY

Select
Model Number

Select
Color

T Black
TI Titanium

H S L V 2 D A P . T

SOOTHE™



Soothe Guest
Chairs and Tables.

SOOTHE™

Soothe offers the comfort and versatility to support a variety of healthcare and waiting environments. This family of patient and guest seats are constructed from durable materials and thoughtfully designed to be easily cleaned. The entire collection maximizes comfort along the patient's journey to recovery, enhances functionality for the caregiver, and creates the versatility required to deliver a higher level of care. Soothe simply helps create happier patients and better caregivers.



FEATURES

- Select Charcoal Urethane or solid hardwood arms in one of eight finishes.
- Wipeout space at the back of the seat allows for easy maintenance.
- Model HHCP1 has a responsive design back that moves with the patient for added comfort.
- Bench seating is available in two-seat or three-seat options.
- Choose Textured Charcoal or Textured Satin Chrome frame.
- Dual fabric option offers endless color combinations.
- Chairs can be ganged together to create straight rows.
- Warranted for users up to 350 lbs. (Model HHCG50 bariatric chair warranted for 500 lbs.)

RECLINER FEATURES

- Allows users to achieve an infinite number of positions, from fully reclined to upright.
- Pivoting arm moves out of the way during patient transfers.
- Optional central locking casters immediately lock the chair in place.
- Optional foot platform elevates the patient's feet to accommodate users of all sizes.
- Optional push handle reduces back strain and supports the caregiver as they reposition the chair.
- Optional foley hook holds tubes, medical bags and other equipment.
- Optional IV pole mount limits patient transfers and saves valuable floor space.
- Warranted for users up to 350 lbs.

SOOTHE™ Options

MODEL OPTIONS

HHCG11
HHCG11DF - Dual Fabric



Guest Chair

HHCG21
HHCG21DF - Dual Fabric

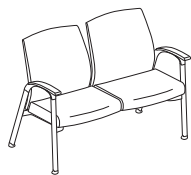

Two-Seat Chair

HHCG50
HHCG50DF - Dual Fabric



Bariatric Chair

HHCP1
HHCP1DF - Dual Fabric



High-Back Patient Chair

HHCGB21

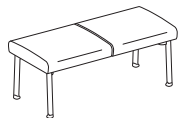

Two-Seat Bench

HHCGB31

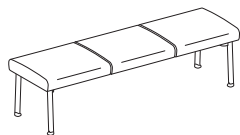

Three-Seat Bench

FINISH	CODE	DESCRIPTION	PRICE	FRAME	CODE	DESCRIPTION	PRICE
	S	Charcoal Urethane	+\$0		P6N	Textured Satin Chrome	+\$0
	H	Bourbon Cherry	+\$100		P7A	Textured Charcoal	+\$0
	F	Shaker Cherry	+\$100				
	C	Harvest	+\$100				
	D	Natural Maple	+\$100				
	N	Mahogany	+\$100				
	MOCH	Mocha	+\$100				
	COGN	Cognac	+\$100				
	PINC	Pinnacle	+\$100				

AVAILABLE FABRICS

GRADE 1	GRADE 2	GRADE 3	GRADE 4	GRADE 5	GRADE 6	GRADE 7	GRADE 8	GRADE 9	GRADE 10	GRADE 11	GRADE 12	GRADE L
Arrondi *	Appoint Seating	Canter Polyurethane	Bar	Amuse	Intermix II	Ascend	Brisa* Polyurethane Kindred	Eli Vinyl	Affinity	Acrobat	Fenestra	
Attire	Bangle	Epic	Beeline	Avenue	Keynote	Central		Martini Vinyl	Concentric	Natural World Whirl	Helix	
Centurion	Clyde	Infinity	Blip	Lariat	Raffia Vinyl	Channel		Olympus Vinyl	Juxy		Lava	
Compass	Dotty	Knack	Coin	Outlander	Velocity	Domain		Silica				
Confetti	Esplanade *	Marathon	Cover Cloth	Polka	Wooly	Synergy		Silica Leather				
Contourette	Expo	Millennium	Current	Riddle		Waver		Silica Tech				
Polyurethane	Fuse	Odyssey	Decode	Sentry-HC								
Dapper	Gio *	Silvertext™ Vinyl	Disc	Sequence								
Inertia	Moguls	Syntax	Divide	Solace								
Optic	Origin	Tradition	Free	Tribeca								
Stitchery	Seed	Via	Habit									
Tectonic	Sockhop		Hive									
	Spin Seating		Lineup									
	Whisper Vinyl		Manner									
			Medium									
			Messenger									
			Metric									
			Oblique									
			Pick									
			Sprint									
			Technic									

Reference Fabric Color Combinations on pages 18-29 for color codes and legend on page 19 for lead times. Visit hon.com for additional partnership fabrics.

NOTES: Gathers and creases may be more visible with Attire (AI) and Optic (OP) fabrics due to the inherent design and construction of these fabrics. For Fire Code and Moisture Barrier model availability and ordering method, refer to pages 34-39. For additional HON to Supply COM fabric grade pricing, go to honready.hon.com and click on the HON to Supply COM link.

⚠ For Fire Code model, availability and ordering method, refer to pages 34-39. Available on select models, contact HON Customer Support for availability.

* Fabric is de-emphasized.

DUAL FABRIC COM YARDAGE

Due to fabric pattern nesting and potential reduction of fabric yield, some dual fabric models may require more total yardage than standard models.

	SEAT	BACK
HHCG11DF	1.4 yd	1.5 yd
HHCG21DF	1.7 yd	2.3 yd
HHCG50DF	1.4 yd	2.3 yd
HHCP1DF	1.4 yd	1.9 yd

SOOTHE™

Table Finish Options

AVAILABLE FINISHES

Soothe™ Tables are available in 11 laminate colors. Each laminate has a specific selection of edges available.

LAMINATE TOP COLORS	EDGE BAND COLORS
Brilliant White (WHIT)	Brilliant White (WHIT)
Charcoal (S)	Charcoal (S)
Silver Mesh (B9)	Loft (LOFT)
Bourbon Cherry (H)	Bourbon Cherry (H), Muslin (T), White (WHIT)
Mahogany (N)	Mahogany (N), Loft (LOFT), Shadow (SHDW)
Natural Maple (D)	Natural Maple (D), Muslin (T), White (WHIT), Loft (LOFT)
Shaker Cherry (F)	Shaker Cherry (F), Muslin (T), White (WHIT), Loft (LOFT), Shadow (SHDW)
Harvest (C)	Harvest (C), Muslin (T), White (WHIT), Loft (LOFT)
Cognac (COGN)	Cognac (COGN), Muslin (T), White (WHIT)
Mocha (MOCH)	Mocha (MOCH), Muslin (T), White (WHIT), Loft (LOFT), Shadow (SHDW)
Pinnacle (PINC)	Pinnacle (PINC), Muslin (T), White (WHIT), Loft (LOFT), Shadow (SHDW)



Icon Legend on page 14

HHCG11

GUEST CHAIR



DIMENSIONS

Depth:	27	Arm Width:	20½
Width:	25½	Seat to Floor Height:	18⅝
Height:	35	Usable Seat Depth:	18
Seat Depth:	18	Ship Weight:	55
Seat Width:	21½	Cube:	14.9
Back Width:	21	COM:	2.0
Back Height:	20½	Weight Rating:	350 lbs.

FABRIC PRICE CODES

1	\$912	8	\$1188
2	\$912	9	\$1224
3	\$1008	10	\$1260
4	\$1044	11	\$1296
5	\$1080	12	\$1332
6	\$1116	L	—
7	\$1152		

HHCG21

TWO-SEAT CHAIR

Outside Arms

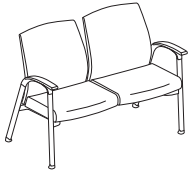

DIMENSIONS

Depth:	27	Arm Width:	42¾
Width:	48	Seat to Floor Height:	18⅝
Height:	35	Usable Seat Depth:	18
Each Seat Depth:	18	Ship Weight:	109
Each Seat Width:	21½	Cube:	33.8
Each Back Width:	21	COM:	3.4
Each Back Height:	20¼	Weight Rating:	350 lbs.

FABRIC PRICE CODES

1	\$1509	8	\$1992
2	\$1593	9	\$2055
3	\$1677	10	\$2118
4	\$1740	11	\$2181
5	\$1803	12	\$2244
6	\$1866	L	—
7	\$1929		

HHCG50

BARIATRIC CHAIR



DIMENSIONS

Depth:	26	Arm Width:	29½
Width:	34½	Seat to Floor Height:	18⅝
Height:	35	Usable Seat Depth:	18
Seat Depth:	18	Ship Weight:	80
Seat Width:	30½	Cube:	25.1
Back Width:	30	COM:	3.0
Back Height:	20½	Weight Rating:	750 lbs.

FABRIC PRICE CODES

1	\$1145	8	\$1628
2	\$1229	9	\$1691
3	\$1313	10	\$1754
4	\$1376	11	\$1817
5	\$1439	12	\$1880
6	\$1502	L	—
7	\$1565		

! HHCG50 is a Single Seat Bariatric chair warranted to 750 lbs.

HHCP1

HIGH-BACK PATIENT CHAIR

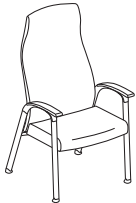

OM

DIMENSIONS

Depth:	27	Arm Width:	20½
Width:	25½	Seat to Floor Height:	18⅝
Height:	46½	Usable Seat Depth:	18
Seat Depth:	18	Ship Weight:	61
Seat Width:	21½	Cube:	19.1
Back Width:	21	COM:	2.4
Back Height:	32	Weight Rating:	350 lbs.

FABRIC PRICE CODES

1	\$1015	8	\$1498
2	\$1099	9	\$1561
3	\$1183	10	\$1624
4	\$1246	11	\$1687
5	\$1309	12	\$1750
6	\$1372	L	—
7	\$1435		

HOW TO SPECIFY

Select Model Number

HHCG11

Select Finish

- S** Charcoal Urethane
- H** Bourbon Cherry (+ \$100)
- F** Shaker Cherry (+ \$100)
- C** Harvest (+ \$100)
- D** Natural Maple (+ \$100)
- N** Mahogany (+ \$100)
- MOCH** Mocha (+ \$100)
- COGN** Cognac (+ \$100)
- PINC** Pinnacle (+ \$100)

S

Select Fabric

See page 251

A190

Select Frame

- P6N** Textured Satin Chrome
- P7A** Textured Charcoal

P6N

SOOTHE™ Dual Fabric

GSA SIN 711-17



Icon Legend on page 14

HHCG11DF



GUEST CHAIR

Dual Fabric

DIMENSIONS

Depth:	27	Arm Width:	20½
Width:	25½	Seat to Floor Height:	18⅞
Height:	35	Usable Seat Depth:	18
Seat Depth:	18	Ship Weight:	55
Seat Width:	21½	Cube:	14.9
Back Width:	21	COM:	See page 251
Back Height:	20½	Weight Rating:	350 lbs.

FABRIC PRICE CODES

1	\$989	
<i>Add to Base Price Above</i>		
		Back Seat
2	\$24	\$24
3	\$48	\$48
4	\$66	\$66
5	\$84	\$84
6	\$102	\$102
7	\$120	\$120
8	\$138	\$138
9	\$156	\$156
10	\$174	\$174
11	\$192	\$192
12	\$210	\$210

NOTES: For dual fabric models, start with the base price, then add the additional amount for the back and seat from the corresponding matrix to determine final price. Choose any combination of fabric grades for back and seat. See examples below:
HHCG11DF base price (\$989) + Grade 2 back fabric (add \$24) + Grade 4 seat fabric (add \$66) = Total \$1079 List

HHCG21DF

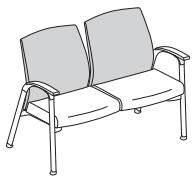

TWO-SEAT CHAIR

Dual Fabric
Outside Arms

DIMENSIONS

Depth:	27	Arm Width:	42¾
Width:	48	Seat to Floor Height:	18⅞
Height:	35	Usable Seat Depth:	18
Each Seat Depth:	18	Ship Weight:	109
Each Seat Width:	21½	Cube:	33.8
Each Back Width:	21	COM:	See page 251
Each Back Height:	20¼	Weight Rating:	350 lbs.

FABRIC PRICE CODES

1	\$1586	
<i>Add to Base Price Above</i>		
		Back Seat
2	\$48	\$36
3	\$96	\$72
4	\$132	\$99
5	\$168	\$126
6	\$203	\$154
7	\$239	\$181
8	\$275	\$208
9	\$311	\$235
10	\$347	\$262
11	\$383	\$289
12	\$419	\$316

NOTES: For dual fabric models, start with the base price, then add the additional amount for the back and seat from the corresponding matrix to determine final price. Choose any combination of fabric grades for back and seat. See examples below:
HHCG21DF base price (\$1586) + Grade 2 back fabric (add \$48) + Grade 4 seat fabric (add \$99) = Total \$1733 List

HOW TO SPECIFY

Select Model Number HHCG11DF	Select Finish S Charcoal Urethane H Bourbon Cherry (+ \$100) F Shaker Cherry (+ \$100) C Harvest (+ \$100) D Natural Maple (+ \$100) N Mahogany (+ \$100) MOCH Mocha (+ \$100) COGN Cognac (+ \$100) PINC Pinnacle (+ \$100)	Select Back Fabric See page 251 AI90	Select Seat Fabric See page 251 RS14	Select Frame P6N Textured Satin Chrome P7A Textured Charcoal
--	--	---	---	---



Icon Legend on page 14

SOOTHE™ Dual Fabric

HHCG50DF

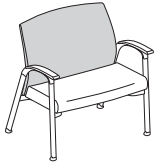

SIN 711-17

BARIATRIC CHAIR

Dual Fabric

DIMENSIONS

Depth:	26	Arm Width:	29½
Width:	34½	Seat to Floor Height:	18⅝
Height:	35	Usable Seat Depth:	18
Seat Depth:	18	Ship Weight:	80
Seat Width:	30½	Cube:	25.1
Back Width:	30	COM:	See page 251
Back Height:	20½	Weight Rating:	750 lbs.

FABRIC PRICE CODES

1	\$1222		
<i>Add to Base Price Above</i>			
		Back	Seat
2	\$48	\$36	
3	\$96	\$72	
4	\$132	\$99	
5	\$168	\$126	
6	\$203	\$154	
7	\$239	\$181	
8	\$275	\$208	
9	\$311	\$235	
10	\$347	\$262	
11	\$383	\$289	
12	\$419	\$316	

NOTES: For dual fabric models, start with the base price, then add the additional amount for the back and seat from the corresponding matrix to determine final price. Choose any combination of fabric grades for back and seat. See examples below:
 HHCG50DF base price (\$1222) + Grade 2 back fabric (add \$48) + Grade 4 seat fabric (add \$99) = Total \$1369 List
! HHCG50DF is a Single Seat Bariatric chair warranted to 750 lbs.

HHCP1DF

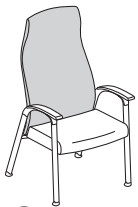

OM

HIGH-BACK PATIENT CHAIR

Dual Fabric

DIMENSIONS

Depth:	27	Arm Width:	20½
Width:	25½	Seat to Floor Height:	18⅝
Height:	46½	Usable Seat Depth:	18
Seat Depth:	18	Ship Weight:	61
Seat Width:	21½	Cube:	19.1
Back Width:	21	COM:	See page 251
Back Height:	32	Weight Rating:	350 lbs.

FABRIC PRICE CODES

1	\$1092		
<i>Add to Base Price Above</i>			
		Back	Seat
2	\$60	\$24	
3	\$119	\$49	
4	\$164	\$67	
5	\$209	\$85	
6	\$253	\$104	
7	\$298	\$122	
8	\$343	\$140	
9	\$388	\$158	
10	\$432	\$177	
11	\$477	\$195	
12	\$522	\$213	

NOTES: For dual fabric models, start with the base price, then add the additional amount for the back and seat from the corresponding matrix to determine final price. Choose any combination of fabric grades for back and seat. See examples below:
 HHCP1DF base price (\$1092) + Grade 2 back fabric (add \$60) + Grade 4 seat fabric (add \$67) = Total \$1219 List

HOW TO SPECIFY

Select Model Number HHCG50DF	Select Finish S Charcoal Urethane H Bourbon Cherry (+ \$100) F Shaker Cherry (+ \$100) C Harvest (+ \$100) D Natural Maple (+ \$100) N Mahogany (+ \$100) MOCH Mocha (+ \$100) COGN Cognac (+ \$100) PINC Pinnacle (+ \$100)	Select Back Fabric See page 251 A190	Select Seat Fabric See page 251 RS14	Select Frame P6N Textured Satin Chrome P7A Textured Charcoal
--	--	---	---	---

SOOTHE™ Benches

GSA SIN 711-17



Icon Legend on page 14

HHCGB21

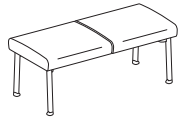

TWO-SEAT BENCH

DIMENSIONS

Depth:	20½	Seat to Floor Height:	17¾
Width:	44	Usable Seat Depth:	17¼
Height:	18¾	Ship Weight:	55
Seat Width:	22	Cube:	18.4
		COM:	1.9
		Weight Rating:	350 lbs.

FABRIC PRICE CODES

1	\$1093	8	\$1300
2	\$1129	9	\$1327
3	\$1165	10	\$1354
4	\$1192	11	\$1381
5	\$1219	12	\$1408
6	\$1246	L	—
7	\$1273		

! Benches cannot be ganged.

HHCGB31

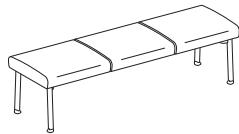

THREE-SEAT BENCH

DIMENSIONS

Depth:	20½	Seat to Floor Height:	17¾
Width:	66	Usable Seat Depth:	17¼
Height:	18¾	Ship Weight:	69
Seat Width:	22	Cube:	25.7
		COM:	2.6
		Weight Rating:	350 lbs.

FABRIC PRICE CODES

1	\$1406	8	\$1613
2	\$1442	9	\$1640
3	\$1478	10	\$1667
4	\$1505	11	\$1694
5	\$1532	12	\$1721
6	\$1559	L	—
7	\$1586		

! Benches cannot be ganged.

HOW TO SPECIFY

Select
Model Number

H H C G B 2 1 .

Select
Fabric

See page 251

R S 1 4 .

Select
Frame

P6N Textured Satin Chrome
P7A Textured Charcoal

P 6 N



HHCTS



IN-LINE TABLE TOP

DIMENSIONS

Depth:	22	Ship Weight:	8
Width:	16	Cube:	1.7
Height:	1½		

LIST PRICE

\$307

NOTES: Can be ganged between two chairs or freestanding.

HHCTC



90-DEGREE RADIUS CORNER TABLE TOP

DIMENSIONS

Depth:	29	Ship Weight:	15
Width:	29	Cube:	2.4
Height:	1½		

LIST PRICE

\$384

! Freestanding only.

HHCTRT



RECTANGLE TABLE TOP

DIMENSIONS

Depth:	22	Ship Weight:	20
Width:	40	Cube:	2.7
Height:	1½		

LIST PRICE

\$512

! Freestanding only.

HHCTL4

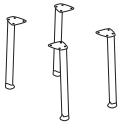

TABLE LEGS

Set of 4

DIMENSIONS

Ship Weight:	8
Cube:	0.4

LIST PRICE

\$205

NOTES: Can be attached to any of the table tops above to create a freestanding table.

HOW TO SPECIFY

<p>Select Model Number</p> <p>HHCTS .</p>	<p>Select Laminate and Edge</p> <p>See page 252</p> <p>DWHIT</p>
--	---

HOW TO SPECIFY

<p>Select Model Number</p> <p>HHCTL4 .</p>	<p>Select Paint Color</p> <p>P6N Textured Satin Chrome P7A Textured Charcoal</p> <p>P6N</p>
---	--



HHCGRCH

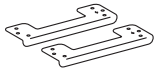

GANGING BRACKET

DIMENSIONS

Ship Weight: 2
Cube: 0.2

LIST PRICE

\$67

NOTES: For chair to chair connection. Does not connect a bench to other type of seating. Ganging brackets can be used with the seating models on pages 253-255. Bench models do not gang. Brackets are Charcoal only.

HHCGBR

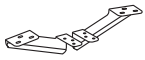

GANGING BRACKET

DIMENSIONS

Ship Weight: 5
Cube: 0.2

LIST PRICE

\$93

NOTES: For chair to table connection. Ganging brackets can be used with the seating models on pages 253-255. Bench models do not gang. Brackets are Charcoal only.

HOW TO SPECIFY

Select
Model Number

H H C G B R C H

Patient Recliner Specifying Information

PATIENT RECLINER STANDARD FEATURES

1. PIVOT ARM

The pivoting transfer arm can be easily activated to move the arms up and out of the way during patient transfers or examinations.

2. INDIVIDUALLY LOCKING CASTERS

Casters lock independently to keep the recliner stationary during treatment.

3. CHAIR TRANSFERS

The seat height and pivot arm enable convenient caregiver assisted patient transfers.

4. INFINITE RECLINE

The chair back and footrest are designed to allow the patient or caregiver to select from an infinite number of configurations.

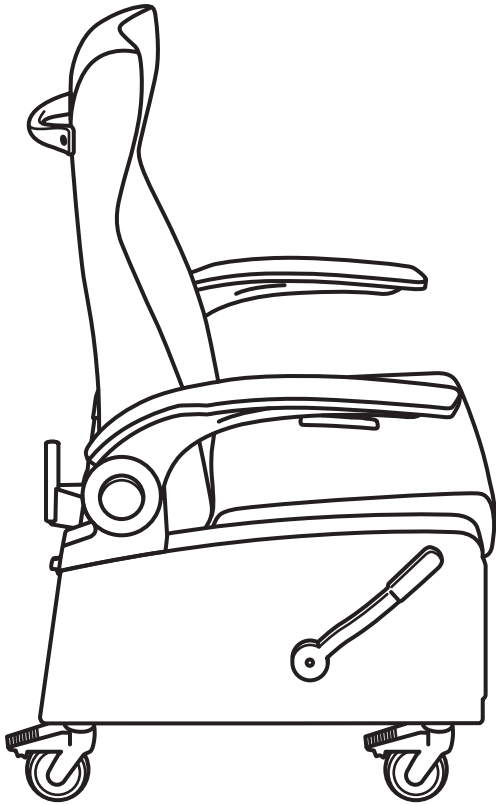

PATIENT RECLINER OPTIONS

Customize the functionality of your Soothe™ recliner with the following optional features.

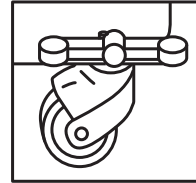

CENTRAL LOCK

Foot activated pedal immediately locks the recliner in place.

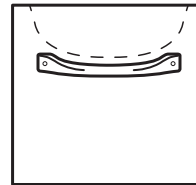

PUSH HANDLE

Ergonomically designed to reduce back strain and support the caregiver as they reposition the chair.

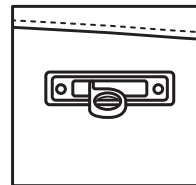

FOLEY HOOK

A foley hook holds tubes, medical bags, and other equipment vital to treatment.

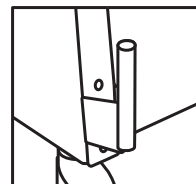

IV POLE MOUNT

Customize with an IV pole mount to limit patient transfers and save valuable floor space.

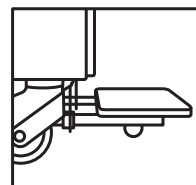

FOOT PLATFORM

Foot platform elevates patient's feet to accommodate users of all sizes.

MOISTURE BARRIER

This extra layer of protection prevents moisture from penetrating the foam to improve cleanability and extend product longevity.

SOOTHE™ Patient Recliner Options

MODEL OPTIONS

HHCRI



Patient Recliner

HHCRICL



Patient Recliner

Central Locking Casters

ARM CAP

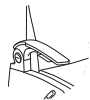

CODE	DESCRIPTION	PRICE
S	Charcoal Urethane	+\$0

FOLEY BAG HOOK



CODE	DESCRIPTION	PRICE
DH	Drainage Hook	+\$70
N	No Drainage Hook	+\$0

PUSH BAR



CODE	DESCRIPTION	PRICE
PB	Push Bar	+\$120
N	No Push Bar	+\$0

FRAME

CODE	DESCRIPTION	PRICE
P7A	Textured Charcoal	+\$0

IV POLE MOUNT

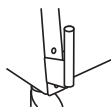

CODE	DESCRIPTION	PRICE
IV	IV Pole Mount	+\$90
N	No IV Pole Mount	+\$0

AVAILABLE FABRICS

GRADE 1	GRADE 2	GRADE 3	GRADE 4	GRADE 5	GRADE 6	GRADE 7	GRADE 8	GRADE 9	GRADE 10	GRADE 11	GRADE 12	GRADE L
Contourette Polyurethane		Canter Polyurethane Silvertex™ Vinyl	Beeline Cover Cloth	Lariat	Keynote Raffia Vinyl Velocity	Ascend Central Channel Domain Synergy Waver	Kindred	Eli Vinyl Martini Vinyl Olympus Vinyl Silica Silica Leather Silica Tech	Affinity Juxy	Acrobat Whirl	Fenestra	

Reference Fabric Color Combinations on pages 18-29 for color codes and legend on page 19 for lead times. Visit hon.com for additional partnership fabrics.

NOTES: Gathers and creases may be more visible with Attire (AI) and Optic (OP) fabrics due to the inherent design and construction of these fabrics. For Fire Code and Moisture Barrier model availability and ordering method, refer to pages 34-39.

For Fire Code model, availability and ordering method, refer to pages 34-39. Available on select models, contact HON Customer Support for availability.



HHCR1

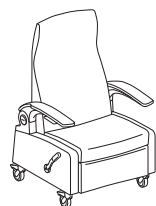

PATIENT RECLINER

DIMENSIONS

Upright Depth:	30½	Seat Depth:	18¾
Upright Width:	32	Seat Width:	22½
Upright Height:	48¼	Seat Height:	20
With IV Mount Depth:	33	Back Width:	22¾
With Push Bar Depth:	32½	Back Height:	33¾
Wall Offset to Recliner Width (for recline):	23	Arm Width:	23
Wall Offset to IV Mount Width (for recline):	20½	Seat to Floor Height:	20
Unit Width Full Recline Depth:	71	Usable Seat Depth:	17½
Unit Width Full Recline Width:	32	Arm Height:	9
Unit Width Full Recline Height:	29¼	Ship Weight:	195
Arm Rest Height from Floor:	27½	Cube:	30.0
		Weight Rating:	350 lbs.

FABRIC PRICE CODES

1	\$3414	8	\$4242
2	\$3558	9	\$4350
3	\$3702	10	\$4458
4	\$3810	11	\$4566
5	\$3918	12	\$4674
6	\$4026	L	—
7	\$4134		

HHCR1CL

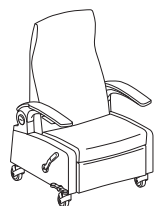

PATIENT RECLINER

Central Locking Casters

DIMENSIONS

Upright Depth:	30½	Seat Depth:	18¾
Upright Width:	32	Seat Width:	22½
Upright Height:	48¼	Seat Height:	20
With IV Mount Depth:	33	Back Width:	22¾
With Push Bar Depth:	32½	Back Height:	33¾
Wall Offset to Recliner Width (for recline):	23	Arm Width:	23
Wall Offset to IV Mount Width (for recline):	20½	Seat to Floor Height:	20
Unit Width Full Recline Depth:	71	Usable Seat Depth:	17½
Unit Width Full Recline Width:	32	Arm Height:	9
Unit Width Full Recline Height:	29¼	Ship Weight:	200
Arm Rest Height from Floor:	27½	Cube:	30.0
		Weight Rating:	350 lbs.

FABRIC PRICE CODES

1	\$4080	8	\$4908
2	\$4224	9	\$5016
3	\$4368	10	\$5124
4	\$4476	11	\$5232
5	\$4584	12	\$5340
6	\$4692	L	—
7	\$4800		

HHCRFP

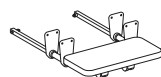

FOOT PLATFORM

DIMENSIONS

Depth:	8	Ship Weight:	15
Width:	16¼	Cube:	2.2
Height:	5/8		

LIST PRICE

\$205

NOTES: Foot platform elevates patient's feet to accommodate users of all sizes.

i Must select UR10 fabric.

HOW TO SPECIFY

Select Model Number	Select Arm Cap Option	Select Fabric	Select Push Bar	Select IV Pole Mount	Select Foley Bag Hook	Select Frame
	S Charcoal Urethane	See page 260	PB Push Bar (+ \$120) N No Push Bar	IV IV Pole Mount (+ \$90) N No IV Pole Mount	DH Drainage Hook (+ \$70) N No Drainage Hook	P7A Textured Charcoal
HHCR1	S	A190	PB	IV	DH	P7A

VERSANT® TANDEM



Versant Tandem Seating and Tables.

VERSANT® TANDEM

Everyone deserves a break from time to time, and a comfy seat in which to enjoy one. Bring stylish support to your welcome areas, public spaces and break rooms with Versant. With a combination of tandem seats, bariatric chairs and a high-back patient chair, it's ideal for both healthcare environments and offices. Arched arms support the upper body and padded seats put people at ease for longer periods of time. Versant brings versatility to every corner of your space.



FEATURES

- Hardwood side frames are integrated with a steel structural frame.
- Stylish arched arm offers greater upper body support.
- Seats are removable for easy cleaning and replacement.
- Contrasting covers are available as special order (please contact customer service).
- Solid hardwood in one of eight attractive finishes.
- Available in hundreds of quality HON fabrics.
- Warranted for users up to 350 lbs. (Model HHCB50 is warranted for users up to 500 lbs.)

VERSANT® Tandem Options

MODEL OPTIONS

HHB02

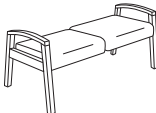

Two-Seat Bench

HHB03

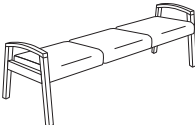

Three-Seat Bench

HHCT01

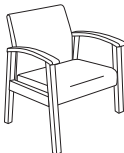

Single Seat
Leg Base, Arms

HHCT02

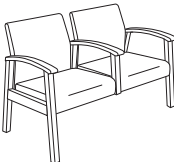

Two-Seat
Leg Base, Center Arm, Arms

HHCT12

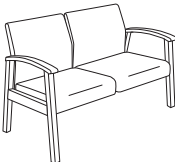

Two-Seat
Leg Base, Arms

HHCB50

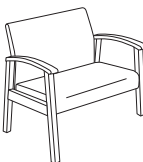

Bariatric Chair
Leg Base, Arms

VERSANT® Tandem Options

AVAILABLE FINISHES

Versant® Tandem Seating is available in 8 wood finishes.

WOOD FINISHES

Bourbon Cherry (H)

Cognac (COGN)

Harvest (C)

Mahogany (N)

Mocha (MOCH)

Natural Maple (D)

Pinnacle (PINC)

Shaker Cherry (F)

AVAILABLE FABRICS

GRADE 1	GRADE 2	GRADE 3	GRADE 4	GRADE 5	GRADE 6	GRADE 7	GRADE 8	GRADE 9	GRADE 10	GRADE 11	GRADE 12	GRADE L
Arrondi *	Appoint Seating	Canter Polyurethane	Bar	Amuse	Intermix II	Ascend	Brisa® Polyurethane	Eli Vinyl	Affinity	Acrobat	Fenestra	Denver Leather (Matches EE Vinyl)
Attire	Bangle	Epic	Beeline	Avenue	Keynote	Central	Kindred	Martini Vinyl	Concentric	Natural World	Helix	
Centurion	Clyde	Infinity	Blip	Lariat	Raffia Vinyl	Channel		Olympus Vinyl	Juxy	Whirl	Lava	
Compass	Dotty	Knack	Coin	Outlander	Velocity	Domain		Silica			Ripple	
Confetti	Esplanade *	Marathon	Cover Cloth	Polka	Wooly	Synergy		Silica Leather				
Contourette Polyurethane	Expo	Millennium	Current	Riddle		Waver		Silica Tech				
Dapper	Fuse	Odyssey	Decode	Sentry-HC								
Inertia	Gio *	Silvertex™ Vinyl	Disc	Sequence								
Optic	Moguls	Syntax	Divide	Solace								
Stitchery	Origin	Tradition	Free	Tribeca								
Tectonic	Seed	Via	Habit									
	Sockhop		Hive									
	Spin Seating		Lineup									
	Whisper Vinyl		Manner									
			Medium									
			Messenger									
			Metric									
			Oblique									
			Pick									
			Sprint									
			Technic									

Reference Fabric Color Combinations on pages 18-29 for color codes and legend on page 19 for lead times. Visit hon.com for additional partnership fabrics.

NOTES: Gathers and creases may be more visible with Attire (AI) and Optic (OP) fabrics due to the inherent design and construction of these fabrics. Contrasting covers on seat and back are available as special order. Please contact Customer Service. For additional HON to Supply COM fabric grade pricing, go to honready.hon.com and click on the HON to Supply COM link.

🔥 For Fire Code model, availability and ordering method, refer to pages 34-39. Available on select models, contact HON Customer Support for availability.

* Fabric is de-emphasized.

Tandem Laminate Occasional Finish Options

AVAILABLE LAMINATES

Versant® Tandem Laminate Occasional Tables are available in 8 laminates.

LAMINATES

Bourbon Cherry (H)

Cognac (COGN)

Harvest (C)

Mahogany (N)

Mocha (MOCH)

Natural Maple (D)

Pinnacle (PINC)

Shaker Cherry (F)

VERSANT® TANDEM



HHB02



TWO-SEAT BENCH

DIMENSIONS

Depth:	20 ³ / ₈	Seat to Floor Height:	19 ¹ / ₂
Width:	45 ¹ / ₂	Usable Seat Depth:	19 ³ / ₄
Height:	23	Ship Weight:	62
Each Seat Depth:	20 ³ / ₈	Cube:	16.2
Each Seat Width:	21 ¹ / ₂	COM:	2.0
Arm Width:	42 ¹ / ₂	Weight Rating:	350 lbs. (per seat)

FABRIC PRICE CODES

1	\$1396	8	\$1672
2	\$1444	9	\$1708
3	\$1492	10	\$1744
4	\$1528	11	\$1780
5	\$1564	12	\$1816
6	\$1600	L	\$1796
7	\$1636		

HHB03

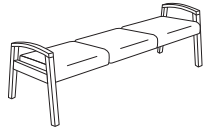

THREE-SEAT BENCH

DIMENSIONS

Depth:	20 ³ / ₈	Seat to Floor Height:	19 ¹ / ₂
Width:	66 ¹ / ₂	Usable Seat Depth:	19 ³ / ₄
Height:	23	Ship Weight:	80
Each Seat Depth:	20 ³ / ₈	Cube:	24.5
Each Seat Width:	21 ¹ / ₂	COM:	2.5
Arm Width:	63 ¹ / ₂	Weight Rating:	350 lbs. (per seat)

FABRIC PRICE CODES

1	\$1795	8	\$2140
2	\$1855	9	\$2185
3	\$1915	10	\$2230
4	\$1960	11	\$2275
5	\$2005	12	\$2320
6	\$2050	L	\$2295
7	\$2095		

HON Recommendation: HHB02.MOCH.SX__ - List Price \$1492

HOW TO SPECIFY

<p>Select Model Number</p> <p>HHB02</p>	<p>Select Finish</p> <p>See page 264</p> <p>MOCH</p>	<p>Select Seat Fabric</p> <p>See page 264</p> <p>SX05</p>
--	---	--



VERSANT® TANDEM

Laminate Occasional Tables

HHCT048

COFFEE TABLE

DIMENSIONS

Length: 48 Ship Weight: 44 Ⓢ
 Width: 20 Cube: 3.0
 Height: 17

LIST PRICE

\$559

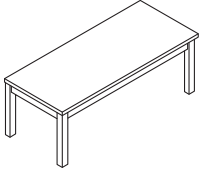

HHCT024

CORNER TABLE

DIMENSIONS

Length: 24 Ship Weight: 20 Ⓢ
 Width: 24 Cube: 1.4
 Height: 17

LIST PRICE

\$467

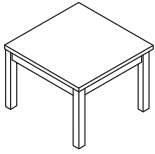

HHCT020

END TABLE

DIMENSIONS

Length: 24 Ship Weight: 22 Ⓢ
 Width: 20 Cube: 1.4
 Height: 17

LIST PRICE

\$439

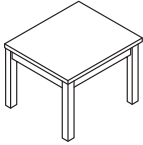

HON Recommendation: HHCT024.MOCH - List Price \$467

HOW TO SPECIFY

<p>Select Model Number</p>	<p>Select Laminate See page 265</p>
<p>HHCT048.</p>	<p>MOCH</p>

VERSANT® TANDEM



HHCT01

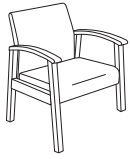

SINGLE SEAT

Leg Base
Arms

DIMENSIONS

Depth:	27	Arm Width:	20½
Width:	25	Seat to Floor Height:	18
Height:	34	Usable Seat Depth:	19¼
Seat Depth:	20¼	Ship Weight:	57
Seat Width:	21	Cube:	20.1
Back Width:	21	COM:	2.0
Back Height:	17	Weight Rating:	350 lbs.

FABRIC PRICE CODES

1	\$1064	8	\$1340
2	\$1112	9	\$1376
3	\$1160	10	\$1412
4	\$1196	11	\$1448
5	\$1232	12	\$1484
6	\$1268	L	\$1464
7	\$1304		

HHCT02

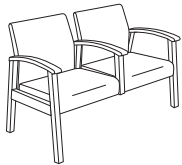

TWO-SEAT

Leg Base
Center Arm
Arms

DIMENSIONS

Depth:	27	Seat to Floor Height:	18
Width:	47½	Usable Seat Depth:	19¼
Height:	34	Ship Weight:	87
Each Seat Depth:	20¼	Cube:	33.7
Each Seat Width:	21	COM:	3.5
Each Back Width:	21	Weight Rating:	350 lbs.
Each Back Height:	17		(per seat)

FABRIC PRICE CODES

1	\$1859	8	\$2342
2	\$1943	9	\$2405
3	\$2027	10	\$2468
4	\$2090	11	\$2531
5	\$2153	12	\$2594
6	\$2216	L	\$2559
7	\$2279		

HHCT12

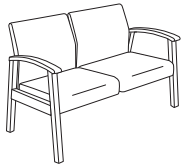

TWO-SEAT

Leg Base
Arms

DIMENSIONS

Depth:	27	Arm Width:	41½
Width:	46	Seat to Floor Height:	18
Height:	34	Usable Seat Depth:	19¼
Each Seat Depth:	20¼	Ship Weight:	87
Each Seat Width:	21	Cube:	33.0
Each Back Width:	21	COM:	3.5
Each Back Height:	17	Weight Rating:	350 lbs.
			(per seat)

FABRIC PRICE CODES

1	\$1779	8	\$2262
2	\$1863	9	\$2325
3	\$1947	10	\$2388
4	\$2010	11	\$2451
5	\$2073	12	\$2514
6	\$2136	L	\$2479
7	\$2199		

HHCB50

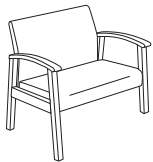

BARIATRIC SINGLE SEAT

Leg Base
Arms

DIMENSIONS

Depth:	27	Arm Width:	29
Width:	33½	Seat to Floor Height:	18
Height:	34	Usable Seat Depth:	19¼
Each Seat Depth:	20¼	Ship Weight:	80
Each Seat Width:	30	Cube:	29.0
Each Back Width:	30	COM:	3.0
Each Back Height:	17	Weight Rating:	500 lbs.

FABRIC PRICE CODES

1	\$1594	8	\$2008
2	\$1666	9	\$2062
3	\$1738	10	\$2116
4	\$1792	11	\$2170
5	\$1846	12	\$2224
6	\$1900	L	\$2194
7	\$1954		

HON Recommendation: HHCT01.MOCH.SX__ - List Price \$1160

HOW TO SPECIFY

Select
Model Number

HHCT01

Select
Finish

See page 264

MOCH

Select
Seat Fabric

See page 264

SX05

VOLT®



Volt Task Chairs and Stools shown with Voi® Desks.

VOLT®

Customizable comfort, distinctive styling and an affordable price point make Volt the family of task seating that supports your body and your budget. The stylish V-shaped back design can be specified in fabric, leather or breathable mesh, giving you more control over your look and feel. The personalized controls and generously proportioned seat and back deliver greater comfort, and are designed support to a wider variety of users. Volt delivers the look you desire, the comfort you demand, and the quality you expect. That's the power of practicality.



FEATURES

- Optional synchro-tilt control provides a smooth, natural recline.
- Optional height-adjustable arms provide a custom fit.
- Optional mesh back offers breathable support.
- Task stools feature an adjustable footring for additional lower body support.
- One-touch seat height adjustment easily moves the seat up and down.
- Tilt tension controls the rate and ease of recline.
- Tilt lock allows the user to lock out the tilt function.
- 360-degree swivel provides freedom of movement in any direction.
- Available in hundreds of quality HON fabrics.
- Warranted for users up to 300 lbs.

VOLT® 5700/5710 Series Options

MODEL OPTIONS

H5701



Task Chair

Pneumatic, Swivel, Tilt, Tilt Tension, Tilt Lock

H5703



Task Chair

Pneumatic, Swivel, Synchro-tilt, Tilt Tension, Tilt Lock

H5705



Task Stool

Pneumatic, Swivel, Adjustable Footring

H5711



Task Chair (Mesh Back)

Pneumatic, Swivel, Tilt, Tilt Tension, Tilt Lock

H5713



Task Chair (Mesh Back)

Pneumatic, Swivel, Synchro-tilt, Tilt Tension, Tilt Lock

H5715



Task Stool (Mesh Back)

Pneumatic, Swivel, Adjustable Footring

AVAILABLE FABRICS

GRADE 1	GRADE 2	GRADE 3	GRADE 4	GRADE 5	GRADE 6	GRADE 7	GRADE 8	GRADE 9	GRADE 10	GRADE 11	GRADE 12	GRADE L
Black Fabric Crimson Fabric Navy Fabric												Black Leather

Reference Fabric Color Combinations on pages 18-29 for color codes and legend on page 19 for lead times. Visit hon.com for additional partnership fabrics.

NOTES: Gathers and creases may be more visible with Attire (AI) and Optic (OP) fabrics due to the inherent design and construction of these fabrics.

⚠ For Fire Code model, availability and ordering method, refer to pages 34-39. Available on select models, contact HON Customer Support for availability.



H5701



TASK CHAIR

Pneumatic
Swivel
Tilt
Tilt Tension
Tilt Lock
Functions: **A, E, F, K, L**
(Function Key on pages 16-17)

DIMENSIONS

Depth:	25¾	Seat to Floor Height:	18-22¼
Width:	26	Usable Seat Depth:	18¾
Height:	40	Ship Weight:	29 Ⓢ
Seat Depth:	18¾	Cube:	5.1
Seat Width:	18½	Weight Rating:	250 lbs.
Back Width:	17¼		
Back Height:	18¾		

FABRIC PRICE CODES

1 \$226 L \$256

H5703



TASK CHAIR

Pneumatic
Swivel
Synchro-tilt
Tilt Tension
Tilt Lock
Functions: **A, E, J, K, L**
(Function Key on pages 16-17)

DIMENSIONS

Depth:	25¾	Seat to Floor Height:	18-22¼
Width:	26	Usable Seat Depth:	18¾
Height:	40	Ship Weight:	29 Ⓢ
Seat Depth:	18¾	Cube:	5.1
Seat Width:	18½	Weight Rating:	250 lbs.
Back Width:	17¼		
Back Height:	18¾		

FABRIC PRICE CODES

1 \$264 L \$294

H5705

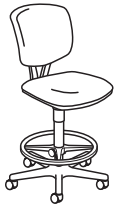

TASK STOOL

Pneumatic
Swivel
Adjustable Footring
Functions: **A, E**
(Function Key on pages 16-17)

DIMENSIONS

Depth:	29½	Seat to Floor Height:	22⅞-32⅜
Width:	27	Usable Seat Depth:	18
Height:	49⅞	Ship Weight:	36 Ⓢ
Seat Depth:	20	Cube:	6.0
Seat Width:	19	Weight Rating:	250 lbs.
Back Width:	16½		
Back Height:	20		

FABRIC PRICE CODES

1 \$373 L \$403

H5795

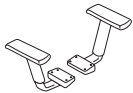

HEIGHT-ADJUSTABLE ARMS

Non-upholstered
Functions: **Q**
(Function Key on pages 16-17)

DIMENSIONS

Adjustable Arms Width:	17⅞
Height from Seat:	7⅞-10⅝
Ship Weight:	5 Ⓢ
Cube:	0.6

LIST PRICE

\$70

HON Recommendation: H5703.GA10.T with H5795 Arm Pack - List Price \$334

HOW TO SPECIFY

<p>Select Model Number</p> <p>H 5 7 0 3 .</p>	<p>Select Fabric</p> <p>SB11 Black Leather GA10 Black GA42 Crimson GA90 Navy</p> <p>G A 1 0 .</p>	<p>Select Frame</p> <p>T Black</p> <p>T</p>
---	---	---

VOLT® 5710 Series

NOT ON GSA CONTRACT



Icon Legend on page 14

H5711



TASK CHAIR

Mesh Back
Pneumatic
Swivel
Tilt
Tilt Tension
Tilt Lock
Functions: **A, E, F, K, L**
(Function Key on pages 16-17)

DIMENSIONS

Depth:	25¾	Seat to Floor Height:	18¼-22¾
Width:	26	Usable Seat Depth:	18
Height:	38¾	Ship Weight:	29 Ⓢ
Seat Depth:	18¾	Cube:	4.8
Seat Width:	19¼	COM:	1.5
Back Width:	18	Weight Rating:	250 lbs.
Back Height:	18¾		

FABRIC PRICE CODES

1 \$305 L \$335

H5713



TASK CHAIR

Mesh Back
Pneumatic
Swivel
Synchro-tilt
Tilt Tension
Tilt Lock
Functions: **A, E, J, K, L**
(Function Key on pages 16-17)

DIMENSIONS

Depth:	25¾	Seat to Floor Height:	17¾-21¾
Width:	26	Usable Seat Depth:	17¾
Height:	38½	Ship Weight:	32 Ⓢ
Seat Depth:	18¾	Cube:	4.8
Seat Width:	19¼	COM:	1.5
Back Width:	18	Weight Rating:	250 lbs.
Back Height:	18¾		

FABRIC PRICE CODES

1 \$343 L \$373

H5715



TASK STOOL

Mesh Back
Pneumatic
Swivel
Adjustable Footring
Functions: **A, E**
(Function Key on pages 16-17)

DIMENSIONS

Depth:	28	Seat to Floor Height:	22⅞-32¾
Width:	26	Usable Seat Depth:	18
Height:	49⅞	Ship Weight:	36 Ⓢ
Seat Depth:	20	Cube:	5.6
Seat Width:	19	COM:	1.5
Back Width:	18	Weight Rating:	250 lbs.
Back Height:	18½		

FABRIC PRICE CODES

1 \$451 L \$481

H5795

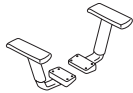

HEIGHT-ADJUSTABLE ARMS

Non-upholstered
Functions: **Q**
(Function Key on pages 16-17)

DIMENSIONS

Adjustable Arms Width:	17¾
Height from Seat:	7⅞-10⅞
Ship Weight:	5 Ⓢ
Cube:	0.6

LIST PRICE

\$70

HON Recommendation: H5713.GA10.T with H5795 Arm Pack - List Price \$413

HOW TO SPECIFY

<p>Select Model Number</p> <p>H 5 7 1 3 .</p>	<p>Select Fabric</p> <p>SB11 Black Leather GA10 Black GA42 Crimson GA90 Navy</p> <p>G A 1 0 .</p>	<p>Select Frame</p> <p>T Black</p> <p>T</p>
---	---	---

VOLT® 5720/5730 Series Options

MODEL OPTIONS

H5721



Task Chair

Pneumatic, Swivel, Tilt, Tilt Tension, Tilt Lock

H5723



Task Chair

Pneumatic, Swivel, Synchro-tilt, Tilt Tension, Tilt Lock

H5725



Task Stool

Pneumatic, Swivel, Adjustable Footring

H5731



Task Chair (Mesh Back)

Pneumatic, Swivel, Tilt, Tilt Tension, Tilt Lock

H5733



Task Chair (Mesh Back)

Pneumatic, Swivel, Synchro-tilt, Tilt Tension, Tilt Lock

H5735



Task Stool (Mesh Back)

Pneumatic, Swivel, Adjustable Footring

CASTERS



CODE	DESCRIPTION	PRICE
H	Hard Caster	+\$0



S	Soft Caster	+\$30
----------	-------------	--------------

FRAME

CODE	DESCRIPTION	PRICE
T	Black	+\$0

VOLT®

5720/5730 Series Fabric Options

AVAILABLE FABRICS

GRADE 1	GRADE 2	GRADE 3	GRADE 4	GRADE 5	GRADE 6	GRADE 7	GRADE 8	GRADE 9	GRADE 10	GRADE 11	GRADE 12	GRADE L
Arrondi *	Appoint	Canter	Bar	Amuse	Intermix II	Ascend	Brisa®	Eli Vinyl	Affinity	Acrobat	Fenestra	
Attire	Seating	Polyurethane	Beeline	Avenue	Keynote	Central	Polyurethane	Martini Vinyl	Concentric	Whirl	Helix	
Centurion	Bangle	Epic	Blip	Lariat	Raffia Vinyl	Channel	Kindred	Olympus	Juxy			
Classic	Clyde	Infinity	Coin	Outlander	Velocity	Domain		Vinyl				
Compass	Dotty	Knack	Cover Cloth	Polka	Wooly	Synergy		Silica				
Confetti	Esplanade *	Marathon	Current	Riddle		Waver		Silica Leather				
Contourette	Expo	Millennium	Decode	Sequence				Silica Tech				
Polyurethane	Fuse	Odyssey	Disc	Solace								
Dapper	Gio *	Silververtex™	Divide	Tribeca								
Inertia	Moguls	Vinyl	Free									
Optic	Origin	Syntax	Habit									
Stitchery	Seed	Tradition	Hive									
Tectonic	Sockhop	Via	Lineup									
	Spin Seating		Manner									
	Whisper		Medium									
	Vinyl		Messenger									
			Metric									
			Oblique									
			Pick									
			Sprint									
			Technic									

Reference Fabric Color Combinations on pages 18-29 for color codes and legend on page 19 for lead times. Visit hon.com for additional partnership fabrics.

NOTES: Gathers and creases may be more visible with Attire (AI) and Optic (OP) fabrics due to the inherent design and construction of these fabrics. For additional HON to Supply COM fabric grade pricing, go to honready.hon.com and click on the HON to Supply COM link.

⚠ For Fire Code model, availability and ordering method, refer to pages 34-39. Available on select models, contact HON Customer Support for availability.

* Fabric is de-emphasized.



H5721



TASK CHAIR

Pneumatic
Swivel
Tilt
Tilt Tension
Tilt Lock
Functions: **A, E, F, K, L**
(Function Key on pages 16-17)

DIMENSIONS

Depth:	25 ³ / ₄	Seat to Floor Height:	17 ¹ / ₄ -22 ¹ / ₄
Width:	25 ³ / ₄	Usable Seat Depth:	18 ³ / ₄
Height:	40	Ship Weight:	36
Seat Depth:	18 ³ / ₄	Cube:	11.3
Seat Width:	18 ¹ / ₂	Weight Rating:	250 lbs.
Back Width:	17 ¹ / ₄		
Back Height:	18 ³ / ₄		

FABRIC PRICE CODES

1	\$298	8	\$436
2	\$322	9	\$454
3	\$346	10	\$472
4	\$364	11	\$490
5	\$382	12	\$508
6	\$400		
7	\$418		

H5723



TASK CHAIR

Pneumatic
Swivel
Synchro-tilt
Tilt Tension
Tilt Lock
Functions: **A, E, J, K, L**
(Function Key on pages 16-17)

DIMENSIONS

Depth:	25 ³ / ₄	Seat to Floor Height:	17 ¹ / ₄ -22 ¹ / ₄
Width:	25 ³ / ₄	Usable Seat Depth:	18 ³ / ₄
Height:	40	Ship Weight:	38
Seat Depth:	18 ³ / ₄	Cube:	11.3
Seat Width:	18 ¹ / ₂	Weight Rating:	250 lbs.
Back Width:	17 ¹ / ₄		
Back Height:	18 ³ / ₄		

FABRIC PRICE CODES

1	\$333	8	\$471
2	\$357	9	\$489
3	\$381	10	\$507
4	\$399	11	\$525
5	\$417	12	\$543
6	\$435		
7	\$453		

H5725



TASK STOOL

Pneumatic
Swivel
Adjustable Footring
Functions: **A, E**
(Function Key on pages 16-17)

DIMENSIONS

Depth:	29 ¹ / ₂	Seat to Floor Height:	22 ¹ / ₈ -32 ³ / ₈
Width:	27	Usable Seat Depth:	18 ³ / ₄
Height:	49 ⁷ / ₈	Ship Weight:	39
Seat Depth:	20	Cube:	11.3
Seat Width:	19	Weight Rating:	250 lbs.
Back Width:	17 ¹ / ₄		
Back Height:	18 ³ / ₄		

FABRIC PRICE CODES

1	\$435	8	\$573
2	\$459	9	\$591
3	\$483	10	\$609
4	\$501	11	\$627
5	\$519	12	\$645
6	\$537		
7	\$555		

H5795

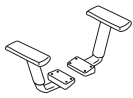

HEIGHT-ADJUSTABLE ARMS

Non-upholstered
Functions: **Q**
(Function Key on pages 16-17)

DIMENSIONS

Adjustable Arms Width:	17 ³ / ₈
Height from Seat:	7 ⁵ / ₈ -10 ⁵ / ₈
Ship Weight:	5
Cube:	0.6

LIST PRICE

\$70

HON Recommendation: H5723.H.CU__T with H5795 Arm Pack - List Price \$403

HOW TO SPECIFY

<p>Select Model Number</p> <p>H 5 7 2 3 .</p>	<p>Select Caster</p> <p>H Hard Caster S Soft Caster (+ \$30)</p> <p>H .</p>	<p>Select Fabric</p> <p>See page 274</p> <p>C U 1 0 .</p>	<p>Select Frame</p> <p>T Black</p> <p>T</p>
--	--	--	--

VOLT® 5730 Series

NOT ON GSA CONTRACT



Icon Legend on page 14

H5731



TASK CHAIR

Mesh Back
Pneumatic
Swivel
Tilt
Tilt Tension
Tilt Lock
Functions: **A, E, F, K, L**
(Function Key on pages 16-17)

DIMENSIONS

Depth:	25¾	Seat to Floor Height:	18¼-22¾
Width:	26	Usable Seat Depth:	18
Height:	38¾	Ship Weight:	29 Ⓢ
Seat Depth:	18¾	Cube:	4.8
Seat Width:	19¼	COM:	1.5
Back Width:	18	Weight Rating:	250 lbs.
Back Height:	18¾		

FABRIC PRICE CODES

1	\$377	8	\$446
2	\$389	9	\$455
3	\$401	10	\$464
4	\$410	11	\$473
5	\$419	12	\$482
6	\$428		
7	\$437		

H5733



TASK CHAIR

Mesh Back
Pneumatic
Swivel
Synchro-tilt
Tilt Tension
Tilt Lock
Functions: **A, E, J, K, L**
(Function Key on pages 16-17)

DIMENSIONS

Depth:	25¾	Seat to Floor Height:	17¾-21¾
Width:	26	Usable Seat Depth:	17¾
Height:	38½	Ship Weight:	32 Ⓢ
Seat Depth:	18¾	Cube:	4.8
Seat Width:	19¼	COM:	1.5
Back Width:	18	Weight Rating:	250 lbs.
Back Height:	18¾		

FABRIC PRICE CODES

1	\$412	8	\$481
2	\$424	9	\$490
3	\$436	10	\$499
4	\$445	11	\$508
5	\$454	12	\$517
6	\$463		
7	\$472		

H5735



TASK STOOL

Mesh Back
Pneumatic
Swivel
Adjustable Footring
Functions: **A, E**
(Function Key on pages 16-17)

DIMENSIONS

Depth:	28	Seat to Floor Height:	22⅞-32¾
Width:	26	Usable Seat Depth:	18
Height:	49⅞	Ship Weight:	36 Ⓢ
Seat Depth:	20	Cube:	5.6
Seat Width:	19	COM:	1.5
Back Width:	18	Weight Rating:	250 lbs.
Back Height:	18½		

FABRIC PRICE CODES

1	\$513	8	\$582
2	\$525	9	\$591
3	\$537	10	\$609
4	\$546	11	\$618
5	\$555	12	\$618
6	\$564		
7	\$573		

H5795

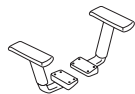

HEIGHT-ADJUSTABLE ARMS

Non-upholstered
Functions: **Q**
(Function Key on pages 16-17)

DIMENSIONS

Adjustable Arms Width:	17¾
Height from Seat:	7⅝-10⅝
Ship Weight:	5 Ⓢ
Cube:	0.6

LIST PRICE

\$70

HON Recommendation: H5733.H.CU__T with H5795 Arm Pack - List Price \$482

HOW TO SPECIFY

<p>Select Model Number</p> <p>H 5 7 3 3 .</p>	<p>Select Caster</p> <p>H Hard Caster S Soft Caster (+ \$30)</p> <p>H .</p>	<p>Select Fabric</p> <p>See page 274</p> <p>C U 1 0 .</p>	<p>Select Frame</p> <p>T Black</p> <p>T</p>
--	--	--	--

2400 SERIES



2400 Guest Chair shown with Park Avenue
5000 Executive Chair and Concinnity Series Desk.

2400 SERIES

Comfort that lasts all day. A sturdy foundation that lasts for years. 2400 Series guest seating combines both to provide an attractive solution for any welcoming or waiting area. The contoured back cushion is designed to offer additional lumbar support and targeted comfort. The solid hardwood frame is available in a variety of rich woodgrain finishes, and the fixed arms provide valuable upper body support. For any number of applications or spaces, your magic number is 2400.



FEATURES

- Contoured back design enhances lumbar support.
- Fully-upholstered outer back.
- Solid hardwood frame is available in one of eight attractive finishes.
- Thick seat and back cushioning deliver exceptional comfort.
- Fixed arms increase upper body support.
- Available in hundreds of quality HON fabrics.
- Warranted for users up to 250 lbs.

2400 SERIES

Options

MODEL OPTIONS

H2403



Guest Chair

Sled Base, Wood Arms

AVAILABLE FINISHES

2400 Series Seating is available in 7 wood finishes.

WOOD FINISHES

Bourbon Cherry (H)

Cognac (COGN)

Harvest (C)

Mahogany (N)

Mocha (MOCH)

Pinnacle (PINC)

Shaker Cherry (F)

AVAILABLE FABRICS

GRADE 1	GRADE 2	GRADE 3	GRADE 4	GRADE 5	GRADE 6	GRADE 7	GRADE 8	GRADE 9	GRADE 10	GRADE 11	GRADE 12	GRADE L
Arrondi *	Appoint Seating	Epic	Bar	Amuse	Intermix II		Brisa® Polyurethane	Eli Vinyl	Affinity	Acrobat	Fenestra	Denver Leather (Matches EE Vinyl)
Attire	Bangle	Infinity	Blip	Avenue	Raffia Vinyl			Martini Vinyl	Concentric	Whirl	Helix	
Centurion	Clyde	Knack	Coin	Lariat	Wooly			Olympus Vinyl	Juxy			
Classic	Dotty	Marathon	Current	Outlander								
Compass	Esplanade *	Millennium	Decode	Polka								
Confetti	Expo	Odyssey	Disc	Riddle								
Contourette	Fuse	Silvertex™ Vinyl	Divide	Sequence								
Polyurethane	Gio *	Syntax	Free	Solace								
Dapper	Moguls	Tradition	Habit	Tribeca								
Inertia	Origin	Via	Hive									
Optic	Seed		Lineup									
Sierra Vinyl	Sockhop		Manner									
Stitchery	Spin Seating		Medium									
Tectonic	Whisper Vinyl		Messenger									
			Metric									
			Oblique									
			Pick									
			Sprint									
			Technic									

Reference Fabric Color Combinations on pages 18-29 for color codes and legend on page 19 for lead times. Visit hon.com for additional partnership fabrics.

NOTES: Gathers and creases may be more visible with Attire (AI) and Optic (OP) fabrics due to the inherent design and construction of these fabrics. COM yardage shown is for Pattern Cut only. Contact Customer Service for Railroaded yardage requirements. For additional HON to Supply COM fabric grade pricing, go to honready.hon.com and click on the HON to Supply COM link.

⚠ For Fire Code model, availability and ordering method, refer to pages 34-39. Available on select models, contact HON Customer Support for availability.

* Fabric is de-emphasized.



Icon Legend on page 14

2400 SERIES

H2403



GUEST CHAIR

Sled Base
Wood Arms

DIMENSIONS

Depth:	25½	Arm Width:	19½
Width:	22¾	Seat to Floor Height:	18½
Height:	32½	Usable Seat Depth:	19
Seat Depth:	20	Ship Weight:	37
Seat Width:	20	Cube:	18.4
Back Width:	19¾	COM:	2.0
Back Height:	16	Weight Rating:	250 lbs.

FABRIC PRICE CODES

1	\$552	8	\$828
2	\$600	9	\$864
3	\$648	10	\$900
4	\$684	11	\$936
5	\$720	12	\$972
6	\$756	L	\$952
7	\$792		

HON Recommendation: H2403.MOCH.CU__ - List Price \$552

HOW TO SPECIFY

<p>Select Model Number</p> <p>H 2 4 0 3 .</p>	<p>Select Finish</p> <p>See page 278</p> <p>M O C H .</p>	<p>Select Fabric</p> <p>See page 278</p> <p>C U 1 0</p>
--	--	--

6540 SERIES



6540 Series Executive High-Back and Guest Chair with 94000 Series™ desks.

6540 SERIES

18th century style meets 21st century engineering in the 6540 Series. Classic details create a dignified aesthetic, while modern control mechanisms deliver advanced support and comfort. The high-back executive chair and matching guest chair also feature a crested-back design, scalloped seat front with buttons on the seat back, brass nailhead trim and scrolled wood accents. Go back in time, without sacrificing the comforts of today.



FEATURES

- Executive chair features mid-range knee-tilt mechanism to allow for a natural, comfortable recline.
- Fully-upholstered outer back.
- Crested-back design features scalloped seat front, buttons on the seat back, brass nailhead trim and scrolled wood accents.
- Contoured back design enhances lumbar support.
- Model 6545 guest chair matches executive task chairs.
- Brass, dual-wheeled, hooded casters roll effortlessly and quietly.
- Solid hardwood in one of eight attractive finishes.
- Warranted for users up to 250 lbs.

6540 SERIES Options

MODEL OPTIONS

H6541



Executive High-Back

Pneumatic, Swivel, Mid-range Knee Tilt, Tilt Tension, Tilt Lock, Upholstered Arms

H6545



Guest Chair

Leg Base, Upholstered Arms

AVAILABLE FINISHES

6540 Series Seating is available in 7 wood finishes.

WOOD FINISHES

Bourbon Cherry (H)

Cognac (COGN)

Harvest (C)

Mahogany (N)

Mocha (MOCH)

Pinnacle (PINC)

Shaker Cherry (F)

AVAILABLE FABRICS

GRADE 1	GRADE 2	GRADE 3	GRADE 4	GRADE 5	GRADE 6	GRADE 7	GRADE 8	GRADE 9	GRADE 10	GRADE 11	GRADE 12	GRADE L
Centurion Confetti Contourette Polyurethane Optic Sierra Vinyl Stitchery	Appoint Seating Bangle Dotty Esplanade * Expo Fuse Gio * Jamestown Vinyl Moguls Origin Sockhop Whisper Vinyl	Infinity Knack Marathon Millennium Odyssey Silvertex™ Vinyl Syntax Tradition Via	Bar Blip Coin Current Decode Divide Free Habit Hive Lineup Manner Medium Messenger Metric Oblique Pick Sprint Technic	Amuse Avenue Lariat Outlander Polka Riddle Sequence Solace Tribeca	Intermix II Raffia Vinyl Wooly		Brisa® Polyurethane	Martini Vinyl Olympus Vinyl	Affinity Concentric Juxy	Acrobat Whirl	Fenestra Helix	Denver Leather (Matches EE Vinyl)

Reference Fabric Color Combinations on pages 18-29 for color codes and legend on page 19 for lead times. Visit hon.com for additional partnership fabrics.

NOTES: Gathers and creases may be more visible with Attire (AI) and Optic (OP) fabrics due to the inherent design and construction of these fabrics. COM yardage shown is for Pattern Cut only. Contact Customer Service for Railroaded yardage requirements. For additional HON to Supply COM fabric grade pricing, go to honready.hon.com and click on the HON to Supply COM link.

For Fire Code model, availability and ordering method, refer to pages 34-39. Available on select models, contact HON Customer Support for availability.

Fabric is de-emphasized.



6540 SERIES

H6541



EXECUTIVE HIGH-BACK

Pneumatic
Swivel
Mid-range Knee Tilt
Tilt Tension
Tilt Lock
Upholstered Arms
Functions: **A, E, G, K, L**
(Function Key on pages 16-17)

DIMENSIONS

Depth:	29½	Arm Width:	19
Width:	25¾	Seat to Floor Height:	16⅞-22⅞
Height:	44¾	Usable Seat Depth:	19
Seat Depth:	19¾	Ship Weight:	68
Seat Width:	21½	Cube:	23.7
Back Width:	21	COM:	2.5
Back Height:	25½	Weight Rating:	250 lbs.

FABRIC PRICE CODES

1	\$1044	8	\$1389
2	\$1104	9	\$1434
3	\$1164	10	\$1479
4	\$1209	11	\$1524
5	\$1254	12	\$1569
6	\$1299	L	\$1544
7	\$1344		

H6545



GUEST CHAIR

Leg Base
Upholstered Arms

DIMENSIONS

Depth:	27½	Arm Width:	18½
Width:	25	Seat to Floor Height:	19
Height:	35¾	Usable Seat Depth:	18½
Seat Depth:	18½	Ship Weight:	40
Seat Width:	20	Cube:	17.3
Back Width:	22½	COM:	2.5
Back Height:	16¾	Weight Rating:	250 lbs.

FABRIC PRICE CODES

1	\$783	8	\$1128
2	\$843	9	\$1173
3	\$903	10	\$1218
4	\$948	11	\$1263
5	\$993	12	\$1308
6	\$1038	L	\$1283
7	\$1083		

HON Recommendation: H6541.MOCH.CU__ - List Price \$1044

HOW TO SPECIFY

Select
Model Number

H 6 5 4 1 .

Select
Finish

See page 281

M O C H .

Select
Fabric

See page 281

C U 1 0

6550 SERIES



6550 Guest Chairs shown with 6540 Executive Chair and 10700 Series Desk.

6550 SERIES

Classic styling. Contemporary comfort. 6550 Series guest chairs bring the best of both to your visitors and coworkers. Whether on casters or glides, these guest chairs feature select hardwood in one of eight attractive finishes and a full upholstered back. The optional nail trim is hand-applied for an old-world look and feel. Bring a little 18th century style into your 21st century meeting and welcoming spaces with the 6550 Series.



FEATURES

- Optional hand-applied nail trim.
- All exposed wood is select hardwood.
- Solid hardwood in one of eight attractive finishes.
- Fully-upholstered outer back.
- Brass, dual-wheel, hooded casters roll effortlessly and silently.
- Warranted for users up to 300 lbs.

6550 SERIES Options

MODEL OPTIONS

H6551



Guest Chair

Open-back, Leg Base,
Upholstered Arms

H6552



Guest Chair

Open-back, Leg Base with Casters,
Upholstered Arms

NAIL TRIM



CODE	DESCRIPTION	PRICE
N	No Nail Trim	+ \$0

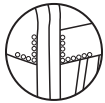

B	Nail Trim	+ \$25
----------	-----------	---------------

NOTES: Optional nail trim is standard around the arm facings and on the sides of the back.

AVAILABLE FINISHES

6550 Series Seating is available in 7 wood finishes.

WOOD FINISHES

Bourbon Cherry (H)

Cognac (COGN)

Harvest (C)

Mahogany (N)

Mocha (MOCH)

Pinnacle (PINC)

Shaker Cherry (F)

AVAILABLE FABRICS

GRADE 1	GRADE 2	GRADE 3	GRADE 4	GRADE 5	GRADE 6	GRADE 7	GRADE 8	GRADE 9	GRADE 10	GRADE 11	GRADE 12	GRADE L
Centurion Confetti Contourette Polyurethane Sierra Vinyl Stitchery	Appoint Seating Bangle Dotty Esplanade * Expo Fuse Gio * Jamestown Vinyl Moguls Origin Sockhop Whisper Vinyl	Infinity Knack Marathon Millennium Odyssey Silvertex™ Vinyl Syntax Tradition Via	Bar Blip Coin Current Decode Divide Free Habit Hive Lineup Manner Medium Messenger Metric Oblique Pick Sprint Technic	Amuse Avenue Lariat Outlander Polka Riddle Sequence Solace Tribeca	Intermix II Raffia Vinyl Wooly		Brisa® Polyurethane	Eli Vinyl Martini Vinyl Olympus Vinyl	Affinity Concentric Juxy	Acrobat Whirl	Fenestra Helix	

Reference Fabric Color Combinations on pages 18-29 for color codes and legend on page 19 for lead times. Visit hon.com for additional partnership fabrics.

NOTES: Gathers and creases may be more visible with Attire (AI) and Optic (OP) fabrics due to the inherent design and construction of these fabrics. For additional HON to Supply COM fabric grade pricing, go to honready.hon.com and click on the HON to Supply COM link.

For Fire Code model, availability and ordering method, refer to pages 34-39. Available on select models, contact HON Customer Support for availability.

Fabric is de-emphasized.



6550 SERIES

H6551



GUEST CHAIR

Open-back
Leg Base
Upholstered Arms

DIMENSIONS

Depth:	25	Arm Width:	18 ⁷ / ₈
Width:	24	Seat to Floor Height:	19 ¹ / ₈
Height:	30 ¹ / ₂	Usable Seat Depth:	20 ¹ / ₄
Seat Depth:	20 ¹ / ₄	Ship Weight:	33
Seat Width:	19 ¹ / ₂	Cube:	18.5
Back Width:	20 ¹ / ₈	COM:	2.0
Back Height:	12 ¹ / ₈	Weight Rating:	250 lbs.

FABRIC PRICE CODES

1	\$587	8	\$863
2	\$635	9	\$899
3	\$683	10	\$935
4	\$719	11	\$971
5	\$755	12	\$1007
6	\$791	L	—
7	\$827		

H6552

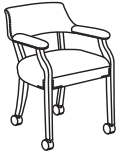

GUEST CHAIR

Open-back
Leg Base with Casters
Upholstered Arms

DIMENSIONS

Depth:	25	Arm Width:	18 ⁷ / ₈
Width:	24	Seat to Floor Height:	19 ¹ / ₈
Height:	30 ¹ / ₂	Usable Seat Depth:	20 ¹ / ₄
Seat Depth:	20	Ship Weight:	33
Seat Width:	19 ¹ / ₂	Cube:	18.5
Back Width:	22 ¹ / ₁₆	COM:	2.0
Back Height:	19 ¹ / ₈	Weight Rating:	250 lbs.

FABRIC PRICE CODES

1	\$635	8	\$911
2	\$683	9	\$947
3	\$731	10	\$983
4	\$767	11	\$1019
5	\$803	12	\$1055
6	\$839	L	—
7	\$875		

HON Recommendation: H6552.B.MOCH.CU__ - List Price \$660

HOW TO SPECIFY

<p>Select Model Number</p> <p>H 6 5 5 2 .</p>	<p>Select Nail Trim</p> <p>B Nail Trim (+ \$25) N No Nail Trim</p> <p>B .</p>	<p>Select Finish</p> <p>See page 284</p> <p>MOCH .</p>	<p>Select Fabric</p> <p>See page 284</p> <p>CU10</p>
--	--	---	---

7700 SERIES



7700 Series Task Chair
shown with StationMaster® Desk.

7700 SERIES

The 7700 Series is up to any task. This popular collection of task chairs meets the demands of today's workstation warriors. The quick release back height easily and quickly adjusts the back height to fit a variety of users. Optional adjustable arms help create a custom fit, and various control mechanisms dial in the perfect recline.



FEATURES

- Large seat and back cushions offer a solid foundation.
- Back height adjustment moves the back up or down to provide a custom fit.
- Optional height-adjustable or height- and width-adjustable arms provide a custom fit.
- One-touch seat height adjustment easily moves the seat up and down.
- Model H7705 is available with bell glides.
- Model H7705 features an adjustable footring.
- Model H7708 features an advanced asynchronous control that mimics the body's natural movements.
- Available in hundreds of quality HON fabrics.
- Warranted for users up to 300 lbs.

7700 SERIES Options

MODEL OPTIONS

H7701



Task Chair

Pneumatic, Back Height, Swivel

H7703



Task Chair

Pneumatic, Back Height, Swivel, Multi-task

H7705



Task Stool

Pneumatic, Back Height, Swivel, Height-adjustable Footring

H7708



High-Performance Task Chair

Pneumatic, Back Height, Seat Glide Mechanism, Swivel, Tilt, Tilt Tension, Asynchronous Control

CASTERS/ GLIDE



CODE	DESCRIPTION	PRICE
H	Hard Caster	+\$0



S	Soft Caster	+\$30
----------	-------------	--------------



G	Bell Glide	+\$25
----------	------------	--------------

*Specify for model H7705 only

FRAME

CODE	DESCRIPTION	PRICE
T	Black	+\$0

AVAILABLE FABRICS

GRADE 1	GRADE 2	GRADE 3	GRADE 4	GRADE 5	GRADE 6	GRADE 7	GRADE 8	GRADE 9	GRADE 10	GRADE 11	GRADE 12	GRADE L
Arrondi *	Appoint Seating	Epic	Bar	Amuse	Intermix II		Brisa® Polyurethane	Olympus Vinyl	Affinity Concentric Juxy	Acrobat Whirl	Fenestra Helix	
Attire	Bangle	Infinity	Blip	Avenue	Wooly							
Centurion	Clyde	Knack	Coin	Avenue								
Classic	Dotty	Marathon	Current	Lariat								
Compass	Esplanade *	Millennium	Decode	Outlander								
Confetti	Expo	Odyssey	Disc	Polka								
Contourette Polyurethane	Fuse	Silvertext™ Vinyl	Divide	Riddle								
Dapper	Gio *	Syntax	Free	Sequence								
Inertia	Moguls	Tradition	Habit	Solace								
Optic	Origin	Via	Hive	Tribeca								
Stitchery	Seed		Lineup									
Tectonic	Sockhop		Manner									
	Spin Seating		Medium									
	Whisper Vinyl		Messenger									
			Metric									
			Oblique									
			Pick									
			Sprint									
			Technic									

Reference Fabric Color Combinations on pages 18-29 for color codes and legend on page 19 for lead times. Visit hon.com for additional partnership fabrics.

NOTES: Gathers and creases may be more visible with Attire (AI) and Optic (OP) fabrics due to the inherent design and construction of these fabrics. COM yardage shown is for Pattern Cut only. Contact Customer Service for Railroaded yardage requirements. For additional HON to Supply COM fabric grade pricing, go to honready.hon.com and click on the HON to Supply COM link.

🔥 For Fire Code model, availability and ordering method, refer to pages 34-39. Available on select models, contact HON Customer Support for availability.

* Fabric is de-emphasized.

7700 SERIES



Icon Legend on page 14

H7701



TASK CHAIR

Pneumatic
Back Height
Swivel
Functions: **A, B, E**
(Function Key on pages 16-17)

DIMENSIONS

Depth:	26	Seat to Floor Height:	17-22½
Width:	26	Usable Seat Depth:	18
Height:	41½	Ship Weight:	36 Ⓞ
Seat Depth:	18	Cube:	11.1
Seat Width:	20	COM:	1.0
Back Width:	18	Weight Rating:	300 lbs.
Back Height:	20		

FABRIC PRICE CODES

1	\$398	8	\$536
2	\$422	9	\$554
3	\$446	10	\$572
4	\$464	11	\$590
5	\$482	12	\$608
6	\$500		
7	\$518		

H7703



TASK CHAIR

Pneumatic
Back Height
Swivel
Multi-task
Functions: **A, B, E, N**
(Function Key on pages 16-17)

DIMENSIONS

Depth:	34	Seat to Floor Height:	15½-20½
Width:	26	Usable Seat Depth:	15-18
Height:	42½	Ship Weight:	40 Ⓞ
Seat Depth:	19	Cube:	11.1
Seat Width:	20	COM:	1.0
Back Width:	19	Weight Rating:	300 lbs.
Back Height:	20		

FABRIC PRICE CODES

1	\$524	8	\$662
2	\$548	9	\$680
3	\$572	10	\$698
4	\$590	11	\$716
5	\$608	12	\$734
6	\$626		
7	\$644		

H7705



TASK STOOL

Pneumatic
Back Height
Swivel
Height-adjustable Footring
Functions: **A, B, E**
(Function Key on pages 16-17)

DIMENSIONS

Depth:	27½	Seat to Floor Height:	22½-32½
Width:	26¾	Footring Width:	20
Height:	47½	Footring Height:	7½-12¼
Seat Depth:	18	Usable Seat Depth:	18
Seat Width:	20	Ship Weight:	41
Back Width:	18	Cube:	15.4
Back Height:	20	COM:	1.0
		Weight Rating:	300 lbs.

FABRIC PRICE CODES

1	\$560	8	\$698
2	\$584	9	\$716
3	\$608	10	\$734
4	\$626	11	\$752
5	\$644	12	\$770
6	\$662		
7	\$680		

H7708



HIGH-PERFORMANCE TASK CHAIR

Pneumatic
Back Height
Seat Glide Mechanism
Swivel
Tilt
Tilt Tension
Asynchronous Control
Functions: **A, B, D, E, F, K, O**
(Function Key on pages 16-17)

DIMENSIONS

Depth:	29½	Seat to Floor Height:	16¾-21¼
Width:	26	Usable Seat Depth:	15-20
Height:	43¾	Ship Weight:	48
Seat Depth:	18	Cube:	15.4
Seat Width:	20	COM:	1.0
Back Width:	18	Weight Rating:	300 lbs.
Back Height:	19¼		

FABRIC PRICE CODES

1	\$714	8	\$852
2	\$738	9	\$870
3	\$762	10	\$888
4	\$780	11	\$906
5	\$798	12	\$924
6	\$816		
7	\$834		

HON Recommendation: H7701.H.CU__T with H7795 Arm Pack - List Price \$497

HOW TO SPECIFY

Select Model Number H7701	Select Caster/Glide H Hard Caster S Soft Caster (+ \$30) G Bell Glide (+ \$25) <i>Specify for model H7705 only</i>	Select Fabric See page 287 CU10	Select Frame T Black
--	--	---	---------------------------------------



7700 SERIES

H7795



HEIGHT-ADJUSTABLE ARMS

Functions: **Q**
(Function Key on pages 16-17)

DIMENSIONS

Adjustable Arms Width: 19½
Height from Seat: 5½-8
Ship Weight: 6 **Ⓢ**
Cube: 0.6

LIST PRICE

\$99

! Not designed to be used on fire code chair.

HHW103



HEIGHT AND WIDTH ADJUSTABLE ARMS

Functions: **S**
(Function Key on pages 16-17)

DIMENSIONS

Adjustable Arms Width: 18½-20½
Height from Seat: 7-9¼
Ship Weight: 8 **Ⓢ**
Cube: 0.6

LIST PRICE

\$114

HOW TO SPECIFY

Select Model Number

H 7 7 9 5

7800 SERIES



7800 Series Task Chair shown with Metro Classic desks.

7800 SERIES

Throw a curve at your task seating with the 7800 Series. The deeply contoured seat foam delivers ergonomic support, and the curvilinear back has integrated lumbar support for lower back. The all-adjustable arms can be moved to support a variety of positions. For anyone sitting for long periods of time, the 7800 Series has got their back.



FEATURES

- Deeply contoured foam on seat and back supports the body.
- Height- and width-adjustable arms provide a custom fit.
- Integrated lumbar support delivers long-lasting comfort.
- Model H7808 features an advanced asynchronous control that mimics the body's natural movements.
- One-touch seat height adjustment easily moves the seat up and down.
- Tilt tension controls the rate and ease of recline.
- Tilt lock allows the user to lock out the tilt function.
- 360-degree swivel provides freedom of movement in any direction.
- Control options encourage good posture.
- Fully-upholstered outer back.
- High-back models feature an integral headrest and shoulder height recess to cradle the upper spine.
- Dual-wheel hooded casters roll effortlessly and silently.
- Warranted for users up to 250 lbs.

7800 SERIES Options

MODEL OPTIONS

H7803



Task Chair (High-back)

Pneumatic, Back Height, Swivel, Tilt, Tilt Tension, Tilt Lock, Posture Mechanism, Height and Width Adjustable Arms

H7808



High-Performance Task Chair (High-back)

Pneumatic, Back Height, Seat Glide Mechanism, Swivel, Tilt, Tilt Tension, Asynchronous Control, Height and Width Adjustable Arms

H7823



Task Chair (Mid-back)

Pneumatic, Back Height, Swivel, Tilt, Tilt Tension, Tilt Lock, Posture Mechanism, Height and Width Adjustable Arms

H7828



High-Performance Task Chair (Mid-back)

Pneumatic, Back Height, Seat Glide Mechanism, Swivel, Tilt, Tilt Tension, Asynchronous Control, Height and Width Adjustable Arms

CASTERS/ GLIDE



CODE	DESCRIPTION	PRICE
H	Hard Caster	+\$0



S	Soft Caster	+\$30
----------	-------------	--------------



G	Bell Glide	+\$25
----------	------------	--------------

**G available for models H7823 and H7828 only*

FRAME

CODE	DESCRIPTION	PRICE
T	Black	+\$0

7800 SERIES

Fabric Options

AVAILABLE FABRICS

GRADE 1	GRADE 2	GRADE 3	GRADE 4	GRADE 5	GRADE 6	GRADE 7	GRADE 8	GRADE 9	GRADE 10	GRADE 11	GRADE 12	GRADE L
Arrondi *	Appoint	Epic	Bar	Amuse	Intermix II		Brisa*	Olympus	Affinity	Acrobat	Fenestra	
Attire	Seating	Infinity	Blip	Avenue	Wooly		Polyurethane	Vinyl	Concentric	Whirl	Helix	
Centurion	Bangle	Knack	Coin	Lariat					Juxy			
Classic	Clyde	Marathon	Current	Outlander								
Compass	Dotty	Millennium	Decode	Polka								
Confetti	Esplanade *	Odyssey	Disc	Riddle								
Contourette	Expo	Silververtex™	Divide	Sequence								
Polyurethane	Fuse	Vinyl	Free	Solace								
Dapper	Gio *	Syntax	Habit	Tribeca								
Inertia	Moguls	Tradition	Hive									
Optic	Origin	Via	Lineup									
Stitchery	Seed		Manner									
Tectonic	Sockhop		Medium									
	Spin Seating		Messenger									
	Whisper Vinyl		Metric									
			Oblique									
			Pick									
			Sprint									
			Technic									

Reference Fabric Color Combinations on pages 18-29 for color codes and legend on page 19 for lead times. Visit hon.com for additional partnership fabrics.

NOTES: Gathers and creases may be more visible with Attire (AI) and Optic (OP) fabrics due to the inherent design and construction of these fabrics. COM yardage shown is for Pattern Cut only. Contact Customer Service for Railroaded yardage requirements. For additional HON to Supply COM fabric grade pricing, go to honready.hon.com and click on the HON to Supply COM link.

⬆ For Fire Code model, availability and ordering method, refer to pages 34-39. Available on select models, contact HON Customer Support for availability.

* Fabric is de-emphasized.



7800 SERIES

H7803



TASK CHAIR

High-back
 Pneumatic
 Back Height
 Swivel
 Tilt
 Tilt Tension
 Tilt Lock
 Posture Mechanism
 Height and Width Adjustable
 Arms

Functions: **A, B, E, F, K, L, M, S**
 (Function Key on pages 16-17)

DIMENSIONS

Depth:	39	Arm Width:	18 ⁵ / ₈ -21 ⁵ / ₈
Width:	30 ¹ / ₂	Seat to Floor Height:	16 ³ / ₄ -20 ³ / ₄
Height:	46 ¹ / ₂	Usable Seat Depth:	18
Seat Depth:	18	Ship Weight:	62
Seat Width:	21 ¹ / ₂	Cube:	18.4
Back Width:	19 ³ / ₄	COM:	2.0
Back Height:	25 ³ / ₄	Weight Rating:	250 lbs.

FABRIC PRICE CODES

1	\$720	8	\$996
2	\$768	9	\$1032
3	\$816	10	\$1068
4	\$852	11	\$1104
5	\$888	12	\$1140
6	\$924		
7	\$960		

H7808



HIGH-PERFORMANCE TASK CHAIR

High-back
 Pneumatic
 Back Height
 Seat Glide Mechanism
 Swivel
 Tilt
 Tilt Tension
 Asynchronous Control
 Height and Width
 Adjustable Arms

Functions: **A, B, D, E, F, K, O, S**
 (Function Key on pages 16-17)

DIMENSIONS

Depth:	37	Arm Width:	18 ⁵ / ₈ -21 ⁵ / ₈
Width:	30 ¹ / ₂	Seat to Floor Height:	18 ¹ / ₄ -21 ³ / ₄
Height:	49	Usable Seat Depth:	17 ¹ / ₂ -19 ³ / ₈
Seat Depth:	18	Ship Weight:	70
Seat Width:	21 ¹ / ₂	Cube:	18.4
Back Width:	19 ³ / ₄	COM:	2.0
Back Height:	24 ³ / ₄	Weight Rating:	250 lbs.

FABRIC PRICE CODES

1	\$939	8	\$1215
2	\$987	9	\$1251
3	\$1035	10	\$1287
4	\$1071	11	\$1323
5	\$1107	12	\$1359
6	\$1143		
7	\$1179		

H7895



ADJUSTABLE ARMS

Height and Width
 Functions: **S**
 (Function Key on pages 16-17)

DIMENSIONS

Adjustable Arms Width:	18 ¹ / ₂ -22 ¹ / ₄
Height from Seat:	8-11 ³ / ₈
Ship Weight:	9
Cube:	0.7

LIST PRICE

\$114

NOTES: Must be ordered with a configurable end product. If ordered separately, not on GSA Contract.

HON Recommendation: H7803.H.CU__T - List Price \$720

HOW TO SPECIFY

<p>Select Model Number</p> <p>H 7 8 0 3 .</p>	<p>Select Caster</p> <p>H Hard Caster S Soft Caster (+ \$30)</p> <p>H .</p>	<p>Select Fabric</p> <p>See page 292</p> <p>C U 1 0 .</p>	<p>Select Frame</p> <p>T Black</p> <p>T</p>
--	---	--	--

7800 Series



Icon Legend on page 14

H7823



TASK CHAIR

Mid-back
Pneumatic
Back Height
Swivel
Tilt
Tilt Tension
Tilt Lock
Posture Mechanism
Height and Width Adjustable
Arms

Functions: **A, B, E, F, K, L, M, S**
(Function Key on pages 16-17)

DIMENSIONS

Depth:	31½	Arm Width:	18⅝-21⅝
Width:	30½	Seat to Floor Height:	16¾-20¾
Height:	42	Usable Seat Depth:	18
Seat Depth:	18	Ship Weight:	55
Seat Width:	21½	Cube:	16.1
Back Width:	19¾	COM:	1.5
Back Height:	23¼	Weight Rating:	250 lbs.

FABRIC PRICE CODES

1	\$663	8	\$870
2	\$699	9	\$897
3	\$735	10	\$924
4	\$762	11	\$951
5	\$789	12	\$978
6	\$816		
7	\$843		

H7828



HIGH-PERFORMANCE TASK CHAIR

Mid-back
Pneumatic
Back Height
Seat Glide Mechanism
Swivel
Tilt
Tilt Tension
Asynchronous Control
Height and Width
Adjustable Arms

Functions: **A, B, D, E, F, K, O, S**
(Function Key on pages 16-17)

DIMENSIONS

Depth:	35	Arm Width:	18⅝-21⅝
Width:	30½	Seat to Floor Height:	18¼-21¾
Height:	42	Usable Seat Depth:	17½-19¾
Seat Depth:	18	Ship Weight:	63
Seat Width:	21½	Cube:	16.1
Back Width:	19¾	COM:	1.5
Back Height:	21⅞-22½	Weight Rating:	250 lbs.

FABRIC PRICE CODES

1	\$886	8	\$1093
2	\$922	9	\$1120
3	\$958	10	\$1147
4	\$985	11	\$1174
5	\$1012	12	\$1201
6	\$1039		
7	\$1066		

HON Recommendation: H7823.H.CU__T - List Price \$663

HOW TO SPECIFY

Select
Model Number

H 7 8 2 3 .

Select
Caster/Glide

H Hard Caster
S Soft Caster (+ \$30)
G Bell Glide (+ \$25)

H .

Select
Fabric

See page 292

C U 1 0 .

Select
Frame

T Black

T

basyx by HON®



HVL518 Guest Chairs and HVL864 Modular Chairs with Cantilever Tables shown with BL Laminate Conference Table and basyx by HON® Storage.

basyx by HON®

basyx by HON® seating is where affordability meets style and comfort. This collection of task, guest and lounge seating is perfectly at home anywhere in your space, and is designed to fit a variety of users. Made from quality materials and rigorously tested, each chair is engineered to perform at the highest level for years. Backed by the power of the basyx by HON® Limited 5-year Warranty, you'll have the confidence to comfortably take on any task.



FEATURES

- basyx by HON® 5-year Limited Warranty.
- Warranted for users up to 250 lbs.
(Big & Tall seating warranted for users up to 450 lbs.)

basyx by HON® Mesh Chairs

NOT ON GSA CONTRACT



Icon Legend on page 14

HVL205



LOW-BACK

Pneumatic
Swivel
Tilt
Tilt Tension
Tilt Lock

DIMENSIONS

Depth:	23	Back Height:	18
Width:	23	Seat to Floor Height:	15¼-19¼
Height:	39½	Usable Seat Depth:	18
Seat Depth:	18	Ship Weight:	29 Ⓢ
Seat Width:	19	Cube:	3.2
Back Width:	18	Weight Rating:	250 lbs.

PRICE CODE

Mesh **\$180**

NOTES: Comfortable and breathable mesh back. Black sandwich mesh seat. Black frame.

HON Recommendation: HVL205.MM10.T - List Price \$180

HVL511



MID-BACK

Pneumatic
Swivel
Tilt
Tilt Tension
Tilt Lock
Fixed Arms

DIMENSIONS

Depth:	26	Arm Width:	18¾
Width:	26	Seat to Floor Height:	16⅞-20⅝
Height:	40½	Usable Seat Depth:	18¼
Seat Depth:	18¼	Ship Weight:	30 Ⓢ
Seat Width:	19½	Cube:	3.8
Back Width:	17¾	Weight Rating:	250 lbs.
Back Height:	21¾		

PRICE CODE

Fabric **\$215**

Functions: **A, E, F, K, L**
(Function Key on pages 16-17)

NOTES: Mid-back Mesh chair. Comfortable and breathable mesh back. Black fabric seat. Black frame. Fixed arms.

HON Recommendation: HVL511.LH10 - List Price \$215

HVL515

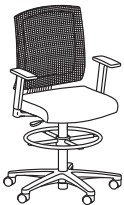

TASK STOOL

Pneumatic
Swivel
Fixed Arms

DIMENSIONS

Depth:	26	Arm Width:	18¾
Width:	26	Seat to Floor Height:	23⅞-33
Height:	52	Usable Seat Depth:	18¼
Seat Depth:	18¼	Ship Weight:	38 Ⓢ
Seat Width:	19½	Cube:	4.6
Back Width:	17¾	Weight Rating:	250 lbs.
Back Height:	21¾		

PRICE CODE

Fabric **\$300**

Functions: **A, E**
(Function Key on pages 16-17)

NOTES: Comfortable and breathable mesh back. Black fabric seat. Fixed arms.

HON Recommendation: HVL515.LH10 - List Price \$300

HOW TO SPECIFY

Select
Model Number

HVL205 .

HVL511 .

Select
Fabric

MM10 Black Sandwich Mesh Fabric
Specify for model HVL205 only
LH10 Black Fabric
Specify for models HVL511 and HVL515 only

MM10 .

LH10

Select
Frame

T Black
Only specify for HVL205

T



HVL521



MID-BACK

Pneumatic
Swivel
Tilt
Tilt Tension
Tilt Lock
Arms

Functions: **A, E, F, K, L**
(Function Key on pages 16-17)

DIMENSIONS

Depth:	35¼	Arm Width:	18½
Width:	26¼	Seat to Floor Height:	17½-22
Height:	41	Usable Seat Depth:	17¾
Seat Depth:	17¾	Ship Weight:	30 Ⓢ
Seat Width:	19½	Cube:	4.1
Back Width:	18¾	Weight Rating:	250 lbs.
Back Height:	21½		

PRICE CODE

Fabric \$259

NOTES: Comfortable and breathable mesh back. Black fabric seat. Sturdy textured black frame. Fixed-height arms.

HON Recommendation: HVL521.VA10 - List Price \$259

HVL525



HIGH-BACK

Pneumatic
Swivel
Tilt
Tilt Tension
Tilt Lock
Fixed Loop Arms

Functions: **A, E, F, K, L, T**
(Function Key on pages 16-17)

DIMENSIONS

Depth:	26	Arm Width:	20⅞
Width:	26	Seat to Floor Height:	16¾-21¼
Height:	42¾	Usable Seat Depth:	19
Seat Depth:	19	Ship Weight:	33 Ⓢ
Seat Width:	19¾	Cube:	3.8
Back Width:	19¾	Weight Rating:	250 lbs.
Back Height:	23		

PRICE CODE

Fabric \$250

NOTES: Comfortable and breathable mesh back. Black upholstered seat. Fixed, loop arms.

HON Recommendation: HVL525.ES10 - List Price \$250

HVL995



HEIGHT-ADJUSTABLE ARMS

Functions: **Q**
(Function Key on pages 16-17)

DIMENSIONS

Adjustable Arms Width:	18¾
Height from Seat:	8-11
Ship Weight:	7 Ⓢ
Cube:	0.6

LIST PRICE

\$70

NOTES: Arm color is black. Height-adjustable. Compatible with HVL205, HVL210, and HVL215.

HON Recommendation: HVL995 - List Price \$70

HOW TO SPECIFY

Select Model Number	Select Fabric
HVL521	VA10 Black Fabric Specify for model HVL521 only ES10 Black Fabric Specify for model HVL525 only
HVL525	VA10 ES10

basyx by HON® Mesh Chairs

NOT ON GSA CONTRACT



Icon Legend on page 14

HVL531



HIGH-BACK

Pneumatic
Swivel
Tilt
Tilt Tension
Tilt Lock
Height-adjustable Arms

Functions: **A, E, F, K, L, Q**
(Function Key on pages 16-17)

DIMENSIONS

Depth:	36	Arm Width:	20¼
Width:	29	Seat to Floor Height:	18-22
Height:	42½	Usable Seat Depth:	18
Seat Depth:	18	Ship Weight:	36.0 Ⓢ
Seat Width:	21½	Cube:	5.1
Back Width:	18¾	Weight Rating:	250 lbs.
Back Height:	23		

PRICE CODE

Sandwich Mesh	\$309
Leather	\$334

NOTES: Comfortable and breathable mesh back. Black sandwich mesh seat or Black SofThread™ leather. Black frame. Height-adjustable arms.

HON Recommendation: HVL531.MM10 - List Price \$309

HVL532



HIGH-BACK

Mesh Back
Pneumatic
Swivel
Asynchronous Control
Tilt
Tilt Tension
Tilt Lock
Seat Glide Mechanism
Back Height Adjustment
Height and Width Adjustable Arms

Functions: **A, B, D, E, F, L, O, S**
(Function Key on pages 16-17)

DIMENSIONS

Depth:	26	Back Height:	23¼-24½
Width:	30¾	Arm Width:	18-22½
Height:	44½	Seat to Floor Height:	17-20½
Seat Depth:	17½-20⅞	Ship Weight:	50.0 Ⓢ
Seat Width:	20½	Cube:	6.5
Back Width:	19⅞	Weight Rating:	250 lbs.

PRICE CODE

Sandwich Mesh	\$400
----------------------	--------------

NOTES: Comfortable and breathable mesh back. Black sandwich mesh seat. Black frame. Height and width adjustable arms. Seat glide mechanism. Asynchronous control with independent seat and back angle adjustment.

HON Recommendation: HVL532.MM10 - List Price \$400

HVL534



HIGH-BACK

Pneumatic
Swivel
Tilt
Tilt Tension
Tilt Lock
Height-adjustable Arms

Functions: **A, E, F, K, L, Q**
(Function Key on pages 16-17)

DIMENSIONS

Depth:	27	Arm Width:	19⅝
Width:	27	Seat to Floor Height:	17⅞-20¾
Height:	41⅞	Usable Seat Depth:	19⅞
Seat Depth:	19⅞	Ship Weight:	40.6 Ⓢ
Seat Width:	20⅞	Cube:	5.7
Back Width:	19⅞	Weight Rating:	250 lbs.
Back Height:	22¾		

PRICE CODE

Mesh	\$400
-------------	--------------

NOTES: basyx by HON® HVL534. Comfortable and breathable mesh back. Black mesh seat. Height-adjustable arms.

HON Recommendation: HVL534.MST3 - List Price \$400

HOW TO SPECIFY

Select Model Number

Select Fabric

MM10 Black Sandwich Mesh Fabric
Specify for models HVL531 and HVL532 only

SB11 SofThread™ Leather
Specify for model HVL531 only

MST3 Black Mesh
Specify for model HVL534 only

HVL531.

MM10



Icon Legend on page 14

basyx by HON® Mesh Chairs

HVL541



Not on GSA Contract

HIGH-BACK

- Pneumatic
- Swivel
- Tilt
- Tilt Tension
- Tilt Lock
- Adjustable Lumbar
- Height-adjustable Arms

Functions: **A, E, F, K, L, Q, W**
(Function Key on pages 16-17)

NOTES: Comfortable and breathable mesh back. Black fabric seat. Black frame. Height-adjustable arms.

HON Recommendation: HVL541.LH10 - List Price \$332

DIMENSIONS

Depth:	28 ³ / ₈	Arm Width:	19 ³ / ₄
Width:	28 ³ / ₈	Seat to Floor Height:	17 ³ / ₄ -22 ¹ / ₂
Height:	43 ³ / ₈	Usable Seat Depth:	19 ¹ / ₄
Seat Depth:	19 ¹ / ₄	Ship Weight:	44 Ⓢ
Seat Width:	19 ⁵ / ₈	Cube:	4.0
Back Width:	16 ³ / ₄	Weight Rating:	250 lbs.
Back Height:	22 ³ / ₄		

PRICE CODE

Fabric \$332

HVL551



SIN 711-18

MID-BACK

- Pneumatic
- Swivel
- Tilt
- Tilt Tension
- Tilt Lock
- Height-adjustable Arms

Functions: **A, E, F, K, L, Q**
(Function Key on pages 16-17)

NOTES: Comfortable and breathable mesh back. Black fabric seat. Sturdy black frame. Height-adjustable arms.

HON Recommendation: HVL551.VB10 - List Price \$363

DIMENSIONS

Depth:	29	Arm Width:	19
Width:	26	Seat to Floor Height:	18 ¹ / ₈ -22 ³ / ₈
Height:	39 ³ / ₄	Usable Seat Depth:	17 ¹ / ₄
Seat Width:	19 ³ / ₄	Ship Weight:	34 Ⓢ
Back Width:	19 ³ / ₄	Cube:	4.8
Back Height:	19 ⁵ / ₈	Weight Rating:	250 lbs.

PRICE CODE

Fabric \$363

HOW TO SPECIFY

<p>Select Model Number</p>	<p>Select Fabric</p> <p>LH10 Black Fabric Specify for model HVL541 only</p> <p>VB10 Black Fabric Specify for model HVL551 only</p>
<p>H V L 5 4 1 .</p>	<p>L H 1 0</p>

basyx by HON® Mesh Chairs

GSA CONTRACT AS NOTED



Icon Legend on page 14

HVL701



SIN 711-18

HIGH-BACK

Pneumatic
Swivel
Knee Tilt
Tilt Tension
Infinite Tilt Lock
Adjustable Lumbar
Height-adjustable Arms

Functions: **A, E, H, K, L, Q, W**
(Function Key on pages 16-17)

DIMENSIONS

Depth:	28	Arm Width:	19½
Width:	27½	Seat to Floor Height:	18½-21¼
Height:	44⅝	Usable Seat Depth:	19¼
Seat Depth:	20¾	Ship Weight:	53 Ⓢ
Seat Width:	22	Cube:	5.8
Back Width:	23	Weight Rating:	250 lbs.
Back Height:	23¾		

PRICE CODE

Leather \$626

NOTES: Comfortable and breathable mesh back. Sturdy textured black frame. HVL701 has a Black leather upholstered seat with side mesh panels. Adjustable lumbar support.

HON Recommendation: HVL701.SB11 - List Price \$626

HVL702



OM

Not on GSA Contract

HIGH-BACK

Pneumatic
Swivel
Synchro-tilt
Tilt Tension
Tilt Lock
Height-adjustable Arms

Functions: **A, E, J, K, L, Q**
(Function Key on pages 16-17)

DIMENSIONS

Depth:	26½	Arm Width:	19½
Width:	26½	Seat to Floor Height:	18½-23½
Height:	40½	Usable Seat Depth:	19¾
Seat Depth:	19¾	Ship Weight:	40 Ⓢ
Seat Width:	21	Cube:	5.0
Back Width:	19½	Weight Rating:	250 lbs.
Back Height:	24		

PRICE CODE

Sandwich Mesh \$507

NOTES: Black Sandwich Mesh seat and mesh back.

HON Recommendation: HVL702.MM10 - List Price \$507

HOW TO SPECIFY

Select Model Number	Select Fabric
	SB11 SofThread™ Leather Specify for model HVL701 only MM10 Black Sandwich Mesh Fabric Specify for model HVL702 only
HVL701.	SB11



basyx by HON® Mesh Chairs

HVL712



SIN 711-18

MID-BACK

- Pneumatic
- Swivel
- Synchro-tilt
- Tilt Tension
- Tilt Lock
- Height-adjustable Arms

Functions: **A, E, J, K, L, Q**
(Function Key on pages 16-17)

NOTES: Black Sandwich Mesh seat and mesh back.

HON Recommendation: HVL712.MM10 - List Price \$467

DIMENSIONS

Depth:	28½	Arm Width:	18⅞
Width:	29½	Seat to Floor Height:	18-22¼
Height:	41¾	Usable Seat Depth:	18
Seat Depth:	18½	Ship Weight:	39 Ⓢ
Seat Width:	19¾	Cube:	5.4
Back Width:	20½	Weight Rating:	250 lbs.
Back Height:	20¾		

PRICE CODE

Sandwich Mesh \$467

HVL721



OM

Not on GSA Contract

HIGH-BACK

- Pneumatic
- Swivel
- Synchronized Tilt
- Tilt Tension
- Tilt Lock
- Seat Glide Mechanism
- Adjustable Lumbar
- Height and Width Adjustable Arms

Functions: **A, D, E, J, K, L, S, W**
(Function Key on pages 16-17)

NOTES: Available in Black SofThread™ leather with Chrome accents. Available in Black fabric with Black accents. Comfortable and breathable mesh back. Adjustable seat glide mechanism. Height and width adjustable arms. Adjustable lumbar support.

ⓘ LH10 Fabric only available with Black Frame/Base. SB11 Fabric only available with Chrome Frame/Base.

HON Recommendation: HVL721.SB11 - List Price \$479

DIMENSIONS

Depth:	26¾	Arm Width:	16½-18¾
Width:	26½	Seat to Floor Height:	17½-22
Height:	42½	Usable Seat Depth:	17½-19½
Seat Depth:	17½-19½	Ship Weight:	40 Ⓢ
Seat Width:	19½	Cube:	5.5
Back Width:	18½	Weight Rating:	250 lbs.
Back Height:	24¼		

PRICE CODE

Fabric \$479
Leather \$529

HOW TO SPECIFY

Select Model Number

H V L 7 1 2 .

Select Fabric

- SB11** SofThread™ Leather
Specify for model HVL721 only
- MM10** Black Sandwich Mesh Fabric
Specify for model HVL712 only
- LH10** Black Fabric
Specify for model HVL721 only

M M 1 0

basyx by HON®

Executive Big and Tall Chairs

NOT ON GSA CONTRACT



Icon Legend on page 14

HVL705



EXECUTIVE BIG AND TALL

Pneumatic
Knee Tilt
Tilt Tension
Tilt Lock
Height and Width Adjustable Arms
Integrated Lumbar Support

Functions: **A, E, H, K, L, S**
(Function Key on pages 16-17)

NOTES: Large scale model HVL705 will support up to 450 lbs with normal use. Available in Black Mesh fabric VM10.

HON Recommendation: HVL705.VM10 - List Price \$748

DIMENSIONS

Depth:	25 ⁵ / ₈	Back Height:	28
Width:	30 ¹ / ₄	Seat to Floor Height:	19 ¹ / ₄ -22 ¹ / ₄
Height:	42 ⁷ / ₈	Usable Seat Depth:	18 ³ / ₄
Seat Depth:	18 ³ / ₄	Ship Weight:	59
Seat Width:	21 ⁵ / ₈	Cube:	6.1
Back Width:	22 ³ / ₄	Weight Rating:	450 lbs.

PRICE CODE

Mesh \$748

HVL685



HIGH-BACK

Pneumatic
Swivel
Tilt Tension
Tilt Lock
Fixed Padded Arms

Functions: **A, E, K, L**
(Function Key on pages 16-17)

Notes: Large scale model HVL685 will support up to 450 lbs with normal use. Available in SofThread™ Leather SB11.

HON Recommendation: HVL685.SB11 - List Price \$695

DIMENSIONS

Depth:	32	Back Height:	28 ¹ / ₂
Width:	27 ¹ / ₂	Seat to Floor Height:	20-23
Height:	45	Usable Seat Depth:	20
Seat Depth:	20	Ship Weight:	67
Seat Width:	22 ¹ / ₄	Cube:	9.5
Back Width:	21	Weight Rating:	450 lbs.

PRICE CODE

Leather \$695

HOW TO SPECIFY

Select Model Number

Select Fabric

VM10 Black Mesh Fabric
Specify for model HVL705 only
SB11 Black Leather
Specify for model HVL685 only

HVL705.

VM10



basyx by HON® Executive Chairs

HVL103



HIGH-BACK

Pneumatic
Swivel
Tilt
Tilt Tension
Tilt Lock
Fixed Padded Arms

Functions: **A, E, F, K, L**
(Function Key on pages 16-17)

DIMENSIONS

Depth:	28¾	Arm Width:	18⅞
Width:	26¾	Seat to Floor Height:	17¼-21
Height:	42½	Usable Seat Depth:	18¼
Seat Depth:	18¼	Ship Weight:	36.0 Ⓢ
Seat Width:	19½	Cube:	4.1
Back Width:	19½	Weight Rating:	250 lbs.
Back Height:	24⅞		

PRICE CODE

Leather \$345

NOTES: Black SofThread™ leather. Polished base. Fixed, padded arms.

HON Recommendation: HVL103.SB11 - List Price \$345

HVL105



HIGH-BACK

Pneumatic
Swivel
Tilt
Tilt Tension
Tilt Lock
Fixed Padded Arms

Functions: **A, E, F, K, L**
(Function Key on pages 16-17)

DIMENSIONS

Depth:	27½	Arm Width:	19
Width:	25	Seat to Floor Height:	17½-20¼
Height:	45¾	Usable Seat Depth:	20¼
Seat Depth:	20¼	Ship Weight:	46.0 Ⓢ
Seat Width:	19½	Cube:	6.6
Back Width:	20½	Weight Rating:	250 lbs.
Back Height:	28¾		

PRICE CODE

Leather \$424

NOTES: Black SofThread™ leather. Polished base. Fixed, padded arms.

HON Recommendation: HVL105.SB11 - List Price \$424

HVL108



HIGH-BACK

Pneumatic
Swivel
Synchro-tilt
Height-adjustable Arms

Functions: **A, E, J, K, Q**
(Function Key on pages 16-17)

DIMENSIONS

Depth:	29¾	Arm Width:	19½
Width:	29¾	Seat to Floor Height:	17⅞-21⅜
Height:	46⅞	Usable Seat Depth:	17½
Seat Depth:	17½	Ship Weight:	47.3 Ⓢ
Seat Width:	21	Cube:	7.2
Back Width:	20	Weight Rating:	250 lbs.
Back Height:	26½		

PRICE CODE

Leather \$440

NOTES: Available in Black and Brown SofThread™ leather. Polished chrome base. Polished arm accents. Height-adjustable arms.

HON Recommendation: HVL108.SB45 - List Price \$440

HOW TO SPECIFY

<p>Select Model Number</p>	<p>Select Fabric</p> <p>SB11 Black Leather Specify for models HVL103, HVL105 and HVL108</p> <p>SB45 Brown SofThread™ Leather Specify for model HVL108 only</p>
<p>HVL103.</p>	<p>SB11</p>

basyx by HON® Executive Chairs

NOT ON GSA CONTRACT



Icon Legend on page 14

HVL402



HIGH-BACK

Pneumatic
Swivel
Tilt
Tilt Tension
Tilt Lock
Fixed Padded Loop Arms

Functions: **A, E, F, K, L, T**
(Function Key on pages 16-17)

DIMENSIONS

Depth:	28	Arm Width:	19½
Width:	26	Seat to Floor Height:	16½-20½
Height:	45½	Usable Seat Depth:	17½
Seat Depth:	17½	Ship Weight:	44 Ⓢ
Seat Width:	19½	Cube:	6.1
Back Width:	19	Weight Rating:	250 lbs.
Back Height:	24½		

PRICE CODE

Vinyl \$330

NOTES: Available in Black and Brown vinyl with contrasting top stitch. EN11 features silver frame. EN45 features black frame. Padded loop arms.

HON Recommendation: HVL402.EN11 - List Price \$330

HVL131



HIGH-BACK

Pneumatic
Swivel
Tilt
Tilt Tension
Tilt Lock
Fixed Padded Loop Arms

Functions: **A, E, F, K, L, T**
(Function Key on pages 16-17)

DIMENSIONS

Depth:	40	Arm Width:	20½
Width:	28½	Seat to Floor Height:	18½-22
Height:	45½	Usable Seat Depth:	18¼
Seat Depth:	18¼	Ship Weight:	42 Ⓢ
Seat Width:	20¾	Cube:	6.3
Back Width:	20¾	Weight Rating:	250 lbs.
Back Height:	26⅞		

PRICE CODE

Vinyl \$369

NOTES: Black vinyl with contrasting top stitch. Black frame. Padded loop arms.

HON Recommendation: HVL131.EN11 - List Price \$369

HOW TO SPECIFY

Select
Model Number

Select
Fabric

EN11 Black Vinyl
Specify for models HVL131 and HVL402
EN45 Brown Vinyl
Specify for model HVL402 only

HVL402.

EN11



basyx by HON® Executive Chairs

HVL151



HIGH-BACK

- Pneumatic
- Swivel
- Tilt
- Tilt Tension
- Tilt Lock
- Fixed Padded Loop Arms

Functions: **A, E, F, K, L, T**
(Function Key on pages 16-17)

NOTES: Black SofThread™ leather. Black frame. Padded loop arms.

HON Recommendation: HVL151.SB11 - List Price \$300

DIMENSIONS

Depth:	37½	Arm Width:	20½
Width:	27	Seat to Floor Height:	17¾-21½
Height:	45½	Usable Seat Depth:	18¾
Seat Depth:	18¾	Ship Weight:	38 Ⓢ
Seat Width:	20½	Cube:	5.1
Back Width:	20½	Weight Rating:	250 lbs.
Back Height:	27¼		

PRICE CODE

Leather \$300

HVL641



HIGH-BACK

- Pneumatic
- Swivel
- Tilt
- Tilt Tension
- Tilt Lock
- Loop Arms

Functions: **A, E, F, K, L, T**
(Function Key on pages 16-17)

NOTES: Black SofThread™ leather with pleated stitching detail. Black frame. Fixed loop arms. Use with coordinating Guest Chair model HVL643 on page 314.

HON Recommendation: HVL641.SB11 - List Price \$318

DIMENSIONS

Depth:	28½	Arm Width:	21⅞
Width:	25¾	Seat to Floor Height:	18⅞-21¾
Height:	47	Usable Seat Depth:	20
Seat Depth:	20	Ship Weight:	43 Ⓢ
Seat Width:	20½	Cube:	5.4
Back Width:	21	Weight Rating:	250 lbs.
Back Height:	28½		

PRICE CODE

Leather \$318

HVL691



HIGH-BACK

- Pneumatic
- Swivel
- Tilt
- Tilt Tension
- Tilt Lock
- Fixed Padded Arms

Functions: **A, E, F, K, L**
(Function Key on pages 16-17)

NOTES: Black SofThread™ leather. Sturdy textured black frame. Fixed padded loop arms. Built-in lumbar support. Use with coordinating Guest Chair model HVL693 on page 314.

HON Recommendation: HVL691.SB11 - List Price \$449

DIMENSIONS

Depth:	28¾	Arm Width:	21
Width:	27	Seat to Floor Height:	18¾-21¾
Height:	47¼	Usable Seat Depth:	17¾
Seat Depth:	20¼	Ship Weight:	50 Ⓢ
Seat Width:	21½	Cube:	7.2
Back Width:	21½	Weight Rating:	250 lbs.
Back Height:	27		

PRICE CODE

Leather \$449

HOW TO SPECIFY

Select Model Number

HVL151.

Select Fabric

SB11 Black Leather
Specify for models HVL151, HVL641 and HVL691

SB11

basyx by HON® Executive Chairs

NOT ON GSA CONTRACT



Icon Legend on page 14

HVL171



MID-BACK

Pneumatic
Swivel
Tilt
Tilt Tension
Tilt Lock
Fixed Loop Arms

Functions: **A, E, F, K, L, T**
(Function Key on pages 16-17)

NOTES: Black SofThread™ leather. Black frame. Loop arms.

HON Recommendation: HVL171.SB11 - List Price \$215

DIMENSIONS

Depth:	34½	Arm Width:	19¾
Width:	25⅝	Seat to Floor Height:	16¾-20½
Height:	38¾	Usable Seat Depth:	17¾
Seat Depth:	17¾	Ship Weight:	26 Ⓢ
Seat Width:	19⅝	Cube:	3.9
Back Width:	18¾	Weight Rating:	250 lbs.
Back Height:	21¾		

PRICE CODE

Leather \$215

HVL604



HIGH-BACK

Pneumatic
Swivel
Tilt
Tilt Tension
Tilt Lock
Fixed Arms

Functions: **A, E, F, K, L, T**
(Function Key on pages 16-17)

NOTES: Available in Black Fabric ES10 and SofThread™ Leather SB11. High-back Executive Chair. Black frame. Fixed, tapered loop arms. Coordinating guest chair HVL605.

HON Recommendation: HVL604.SB11 - List Price \$215

DIMENSIONS

Depth:	26½	Arm Width:	20½
Width:	25	Seat to Floor Height:	16¼-20¾
Height:	46½	Usable Seat Depth:	18¼
Seat Depth:	18¼	Ship Weight:	40 Ⓢ
Seat Width:	19¾	Cube:	4.1
Back Width:	20	Weight Rating:	250 lbs.
Back Height:	26½		

PRICE CODE

Fabric \$215
Leather \$225

HOW TO SPECIFY

Select
Model Number

Select
Fabric

SB11 Black Leather
Specify for models HVL171 and HVL604 only
ES10 Black Fabric
Specify for model HVL604 only

HVL171.

SB11



HVL601



HIGH-BACK

- Pneumatic
- Swivel
- Tilt
- Tilt Tension
- Tilt Lock
- Loop Arms

Functions: **A, E, F, K, L, T**
(Function Key on pages 16-17)

DIMENSIONS

Depth:	27	Arm Width:	20½
Width:	26½	Seat to Floor Height:	16¾-20½
Height:	44	Usable Seat Depth:	17
Seat Depth:	17	Ship Weight:	38
Seat Width:	20½	Cube:	4.1
Back Width:	20½	Weight Rating:	250 lbs.
Back Height:	26½		

PRICE CODE

Fabric	\$216
Leather	\$246

NOTES: Tailored stitching detail in Black SofThread™ leather or Black, Charcoal, Burgundy or Navy fabric. Fixed loop arms. Black frame.

HON Recommendation: HVL601.SB11 - List Price \$216

HVL161



HIGH-BACK

- Pneumatic
- Swivel
- Tilt
- Tilt Tension
- Tilt Lock
- Fixed Padded Loop Arms

Functions: **A, E, F, K, L, T**
(Function Key on pages 16-17)

DIMENSIONS

Depth:	39¼	Arm Width:	19
Width:	25⅝	Seat to Floor Height:	18⅜-22⅝
Height:	45	Usable Seat Depth:	18¾
Seat Depth:	18¾	Ship Weight:	35
Seat Width:	19	Cube:	4.8
Back Width:	19	Weight Rating:	250 lbs.
Back Height:	26¾		

PRICE CODE

Leather	\$266
----------------	--------------

NOTES: Black SofThread™ leather. Black frame. Padded loop arms.

HON Recommendation: HVL161.SB11 - List Price \$266

HOW TO SPECIFY

<p>Select Model Number</p>	<p>Select Fabric</p> <p>SB11 Black Leather <i>Specify for model HVL601 only</i></p> <p>VA10 Black Fabric <i>Specify for model HVL601 only</i></p> <p>VA19 Charcoal Fabric <i>Specify for model HVL601 only</i></p> <p>VA62 Burgundy Fabric <i>Specify for model HVL601 only</i></p> <p>VA90 Navy Fabric <i>Specify for model HVL601 only</i></p>											
<table border="1" style="display: inline-table; border-collapse: collapse;"> <tr> <td style="padding: 2px 5px;">H</td> <td style="padding: 2px 5px;">V</td> <td style="padding: 2px 5px;">L</td> <td style="padding: 2px 5px;">6</td> <td style="padding: 2px 5px;">0</td> <td style="padding: 2px 5px;">1</td> <td style="padding: 2px 5px;">.</td> </tr> </table>	H	V	L	6	0	1	.	<table border="1" style="display: inline-table; border-collapse: collapse;"> <tr> <td style="padding: 2px 5px;">S</td> <td style="padding: 2px 5px;">B</td> <td style="padding: 2px 5px;">1</td> <td style="padding: 2px 5px;">1</td> </tr> </table>	S	B	1	1
H	V	L	6	0	1	.						
S	B	1	1									

basyx by HON® Wood Executive Chairs

NOT ON GSA CONTRACT



Icon Legend on page 14

HVL844



HIGH-BACK

Pneumatic
Swivel
Tilt
Tilt Tension
Tilt Lock
Fixed Padded Wood Arms and Base

Functions: **A, E, F, K, L**

(Function Key on pages 16-17)

NOTES: Wood accents available in Bourbon Cherry and Mahogany. High-back design. SofThread™ leather. Tailored padded back design provides strong lumbar support. Fixed padded loop arms. Use with coordinated Guest Chair models HVL852 and HVL853 on page 315.

HON Recommendation: HVL844.H.SB11 - List Price \$526

DIMENSIONS

Depth:	30	Arm Width:	20¼
Width:	28	Seat to Floor Height:	17 ¹³ / ₁₆ -21 ⁵ / ₁₆
Height:	47 ⁵ / ₁₆	Usable Seat Depth:	17½
Seat Depth:	18½	Ship Weight:	58 Ⓢ
Seat Width:	20½	Cube:	6.4
Back Width:	20½	Weight Rating:	250 lbs.
Back Height:	27½		

PRICE CODE

Leather \$526

HOW TO SPECIFY

Select
Model Number

H V L 8 4 4 .

Select
Wood Finish

H Bourbon Cherry
N Mahogany

H .

Select
Fabric

SB11 SofThread™ Leather

S B 1 1



HVL210



TASK LOW-BACK

Pneumatic
Swivel
Tilt
Tilt Tension
Tilt Lock
Functions: **A, E, F, K, L**
(Function Key on pages 16-17)

DIMENSIONS

Depth:	33½	Back Height:	20¼
Width:	24½	Seat to Floor Height:	17-20½
Height:	38¾	Usable Seat Depth:	17¾
Seat Depth:	17¾	Ship Weight:	31 Ⓢ
Seat Width:	19¾	Cube:	3.6
Back Width:	19¾	Weight Rating:	250 lbs.

PRICE CODE

Sandwich Mesh \$198

NOTES: Black sandwich mesh. Sturdy textured black frame. HVL995 optional arm pack available.

HON Recommendation: HVL210.MM10 - List Price \$198

HVL215



TASK STOOL

Pneumatic
Swivel
Functions: **A, E**
(Function Key on pages 16-17)

DIMENSIONS

Depth:	33½	Back Height:	19
Width:	24½	Seat to Floor Height:	24½-33½
Height:	51⅞	Usable Seat Depth:	17¾
Seat Depth:	17¾	Ship Weight:	37 Ⓢ
Seat Width:	19¾	Cube:	5.7
Back Width:	19¾	Weight Rating:	250 lbs.

PRICE CODE

Fabric \$250

NOTES: Black sandwich mesh. Sturdy textured black frame. HVL995 optional arm pack available.

HON Recommendation: HVL215.MM10 - List Price \$250

HVL220



TASK MID-BACK

Pneumatic
Swivel
Tilt
Tilt Tension
Tilt Lock
Height-adjustable Arms
Functions: **A, E, F, K, L, Q**
(Function Key on pages 16-17)

DIMENSIONS

Depth:	34½	Arm Width:	17¾
Width:	26⅜	Seat to Floor Height:	17½-21¼
Height:	41	Usable Seat Depth:	16¾
Seat Depth:	16¾	Ship Weight:	35 Ⓢ
Seat Width:	20	Cube:	3.7
Back Width:	20¼	Weight Rating:	250 lbs.
Back Height:	22½		

PRICE CODE

Fabric \$295

NOTES: Black fabric. Sturdy textured black frame. Height-adjustable arms.

HON Recommendation: HVL220.VA10 - List Price \$295

HVL995



HEIGHT-ADJUSTABLE ARMS

Functions: **Q**
(Function Key on pages 16-17)

DIMENSIONS

Adjustable Arms Width:	18¾
Height from Seat:	8-11
Ship Weight:	7 Ⓢ
Cube:	0.6

LIST PRICE

\$70

NOTES: Arm color is black. Height-adjustable. Compatible with HVL210, HVL215, and HVL205.

HON Recommendation: HVL995 - List Price \$70

HOW TO SPECIFY

<p>Select Model Number</p>	<p>Select Fabric</p> <p>MM10 Black Sandwich Mesh Fabric <i>Specify for models HVL210 and HVL215 only</i></p> <p>VA10 Black Fabric <i>Specify for models HVL220</i></p>
<p>H V L 2 1 0 .</p>	<p>M M 1 0</p>

basyx by HON® Active Seating

NOT ON GSA CONTRACT



Icon Legend on page 14

HVLPERCH



PERCH STOOL

Pneumatic
Swivel
Pivot Base

DIMENSIONS

Depth:	16½	Seat to Floor Height:	23¾-35
Width:	15¾	Usable Seat Depth:	14½
Seat Depth:	14½	Ship Weight:	34
Seat Width:	14½	Cube:	3.13
		Weight Rating:	250 lbs.

PRICE CODE

Fabric **\$399**

NOTES: Fabric seat in black, charcoal, red, blue, and green. Built-in handle. Active pivot base. Silver frame.

HON Recommendation: HVLPERCH.ASF10.X - List Price \$399

HOW TO SPECIFY

Select
Model Number

HVLPERCH.

Select
Fabric

ASF10 Black Fabric
ASF19 Charcoal Fabric
ASF42 Red Fabric
ASF90 Blue Fabric
ASF82 Green Fabric

ASF10.

Select
Frame

X Silver

X



basyx by HON® Mesh Nesting Chairs

HVL302

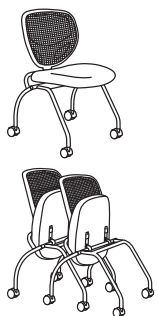

MESH BACK

Upholstered Seat
Casters
Armless

DIMENSIONS

Depth:	22	Back Height:	17
Width:	21½	Seat to Floor Height:	18¾
Height:	32½	Usable Seat Depth:	17¾
Seat Depth:	17¾	Ship Weight (armless):	43 Ⓢ
Seat Width:	19¼	Cube (armless):	7.2
Back Width:	18¾	Weight Rating:	250 lbs.

PRICE CODE

Mesh	
Per Carton	\$583
Single Unit	\$291.50

NOTES: Comfortable and breathable mesh back. Black sandwich fabric seat. Black frame. Ships two per carton.

Ⓢ basyx by HON® Mesh Nesting Chairs are ordered and shipped two (2) chairs per carton. Pricing shown is per carton. Each set of two (one carton), must have the same fabric/frame color. Ordering 2 of any model will result in 2 cartons being shipped, giving you 4 chairs.

HON Recommendation: HVL302.MM10.T - List Price \$583

HVL303



SANDWICH MESH BACK AND SEAT

Upholstered Seat and Back
Casters
Arms

DIMENSIONS

Depth:	23¾	Back Height:	16
Width:	23¾	Seat to Floor Height:	19¼
Height:	33½	Usable Seat Depth:	18½
Seat Depth:	18½	Ship Weight:	27 Ⓢ
Seat Width:	19½	Cube:	2.1
Back Width:	19½	Weight Rating:	250 lbs.

LIST PRICE

\$230.00

NOTES: Seat and back upholstered in comfortable and breathable black sandwich mesh. Specify Black (T) or Silver (X) frame. Ships one per carton.

HON Recommendation: HVL303.MM10.T - List Price \$230

HOW TO SPECIFY

<p>Select Model Number</p> <p>H V L 3 0 2 .</p>	<p>Select Fabric</p> <p>MM10 Black Sandwich Mesh Fabric (only)</p> <p>M M 1 0 .</p>	<p>Select Frame</p> <p>T Black X Silver <i>Not specified for model HVL302</i></p> <p>T</p>
--	---	---

basyx by HON® Mesh Guest Chairs

NOT ON GSA CONTRACT



Icon Legend on page 14

HVL518



GUEST CHAIR

Leg Base
Arms
Stacks up to Four High

DIMENSIONS

Depth:	22¼	Arm Width:	20¼
Width:	24	Seat to Floor Height:	17¾
Height:	35¾	Usable Seat Depth:	17½
Seat Depth:	17½	Ship Weight:	22.2 Ⓢ
Seat Width:	18½	Cube:	3.2
Back Width:	17½	Weight Rating:	250 lbs.
Back Height:	19		

PRICE CODE

Fabric **\$190**

NOTES: Mesh back. Fixed arms. Double cross bar frame increases strength and durability. Stackable up to 4-high. Black fabric seat.

HON Recommendation: HVL518.ES10 - List Price \$190

HVL508



GUEST CHAIR

Leg Base
Armless
Stacks up to Four High

DIMENSIONS

Depth:	22¼	Back Height:	19
Width:	24	Seat to Floor Height:	18¾
Height:	35¾	Usable Seat Depth:	17½
Seat Depth:	17½	Ship Weight:	18.8 Ⓢ
Seat Width:	18½	Cube:	3.1
Back Width:	17½	Weight Rating:	250 lbs.

PRICE CODE

Fabric **\$170**

NOTES: Mesh back. Black fabric seat. Double cross bar frame increases strength and durability. Stackable up to 4-high.

HON Recommendation: HVL508.ES10 - List Price \$170

HVL538



CAFÉ STOOL

Leg Base
Arms

DIMENSIONS

Depth:	23¾	Arm Width:	20¼
Width:	20½	Seat to Floor Height:	33⅝
Height:	49¾	Usable Seat Depth:	17½
Seat Depth:	17½	Ship Weight:	44.5 Ⓢ
Seat Width:	18½	Cube:	7.8
Back Width:	17½	Weight Rating:	250 lbs.
Back Height:	19		

PRICE CODE

Fabric
Per Carton **\$510**
Single Unit **\$255.00**

NOTES: Mesh back. Black fabric seat. Fixed arms. Ships two per carton.

HON Recommendation: HVL538.ES10 - List Price \$510

HVL528



CAFÉ STOOL

Leg Base
Armless

DIMENSIONS

Depth:	23¾	Back Height:	19
Width:	20½	Seat to Floor Height:	33⅝
Height:	49¾	Usable Seat Depth:	17½
Seat Depth:	17½	Ship Weight (armless):	40.0 Ⓢ
Seat Width:	18½	Cube (armless):	7.0
Back Width:	17½	Weight Rating:	250 lbs.

PRICE CODE

Fabric
Per Carton **\$470**
Single Unit **\$235.00**

NOTES: Mesh back. Black fabric seat. Ships two per carton.

ⓘ basyx by HON® HVL538 and HVL528 are ordered and shipped two (2) stools per carton. Pricing shown is per carton. Each set of two (one carton), must have the same fabric/frame color. Ordering 2 of any model will result in 2 cartons being shipped, giving you 4 stools.

HON Recommendation: HVL528.ES10 - List Price \$470

HOW TO SPECIFY

Select Model Number <div style="border: 1px solid black; padding: 2px; display: flex; gap: 5px;"> HVL518 </div>	Select Fabric ES10 Black Fabric (only)
---	---



HVL443



GUEST CHAIR

Sled Base
Padded Arms

DIMENSIONS

Depth:	25½	Arm Width:	20
Width:	23¼	Seat to Floor Height:	18½
Height:	34½	Usable Seat Depth:	18
Seat Depth:	18½	Ship Weight:	35 Ⓢ
Seat Width:	20½	Cube:	4.1
Back Width:	20	Weight Rating:	250 lbs.
Back Height:	16		

PRICE CODE

Fabric **\$267**

NOTES: Coordinates in any office environment or reception area. Sturdy, welded metal sled base frame. Sleek fabric covered back and seat cushions. Fabric covered outer back. Padded arm rests. Built-in lumbar support.

HON Recommendation: HVL443.VC10 - List Price \$267

HVL606



GUEST CHAIR

Leg Base
Armless
Stacks up to Four High

DIMENSIONS

Depth:	21	Back Height:	16
Width:	21¼	Seat to Floor Height:	19
Height:	32¾	Usable Seat Depth:	17½
Seat Depth:	17½	Ship Weight:	16 Ⓢ
Seat Width:	19	Cube:	2.1
Back Width:	18½	Weight Rating:	250 lbs.

PRICE CODE

Fabric **\$119**
Leather **\$149**

NOTES: Black SofThread™ leather. Stackable up to four high. Round tube construction. Frame available in Black.

HON Recommendation: HVL606.VA10 - List Price \$119

HVL616



GUEST CHAIR

Leg Base
Arms
Stacks up to Four High

DIMENSIONS

Depth:	21	Arm Width:	20½
Width:	23¼	Seat to Floor Height:	19
Height:	32¾	Usable Seat Depth:	17½
Seat Depth:	17½	Ship Weight:	18 Ⓢ
Seat Width:	19	Cube:	2.1
Back Width:	18½	Weight Rating:	250 lbs.
Back Height:	16		

PRICE CODE

Fabric **\$134**
Leather **\$164**

NOTES: Black SofThread™ leather. Stackable up to four high. Round tube construction. Frame available in Black.

HON Recommendation: HVL616.VA10 - List Price \$134

HOW TO SPECIFY

<p>Select Model Number</p>	<p>Select Fabric</p> <p>VC10 Black Fabric <i>Specify for model HVL443 only</i></p> <p>SB11 Black Leather VA10 Black Fabric <i>Specify for models HVL606 and HVL616 only</i></p> <p>VA19 Charcoal Fabric VA90 Navy Fabric <i>Specify for models HVL606 and HVL616 only</i></p>
<p>H V L 6 0 6 .</p>	<p>V A 1 0</p>

basyx by HON® Guest Chairs

NOT ON GSA CONTRACT



Icon Legend on page 14

HVL605



GUEST CHAIR

Leg Base
Arms
Stacks up to Four High

DIMENSIONS

Depth:	24	Arm Width:	19½
Width:	23½	Seat to Floor Height:	18½
Height:	34½	Usable Seat Depth:	17½
Seat Depth:	17½	Ship Weight:	22.2 Ⓢ
Seat Width:	18½	Cube:	3.0
Back Width:	18½	Weight Rating:	250 lbs.
Back Height:	17¾		

PRICE CODE

Leather \$225

NOTES: basyx by HON® HVL605 Guest Chair. Waterfall seat edge. Wall-saver design. Fixed arms. Stackable up to 4-high. Contemporary rectilinear steel frame in Matte Black. Use with coordinating Executive Chair model HVL604 on page 306.

HON Recommendation: HVL605.SB11 - List Price \$225

HVL643



GUEST CHAIR

Leg Base
Padded Arms

DIMENSIONS

Depth:	28¼	Arm Width:	18½
Width:	24½	Seat to Floor Height:	19½
Height:	34½	Usable Seat Depth:	19½
Seat Depth:	19½	Ship Weight:	36.0 Ⓢ
Seat Width:	19	Cube:	4.5
Back Width:	21¼	Weight Rating:	250 lbs.
Back Height:	18		

PRICE CODE

Leather \$261

NOTES: Black SofThread™ leather with pleated stitching detail. Black frame. Use with coordinating Executive Chair model HVL641 on page 305.

HON Recommendation: HVL643.SB11 - List Price \$261

HVL653



GUEST CHAIR

Sled Base
Padded Arms

DIMENSIONS

Depth:	23	Arm Width:	17¾
Width:	22¼	Seat to Floor Height:	17⅝
Height:	32	Usable Seat Depth:	16¾
Seat Depth:	17	Ship Weight:	28.0 Ⓢ
Seat Width:	20¼	Cube:	3.1
Back Width:	18½	Weight Rating:	250 lbs.
Back Height:	12		

PRICE CODE

Leather \$190

NOTES: Black SofThread™ leather with tailored stitching detail. Frame features steel tubular construction. Black frame.

HON Recommendation: HVL653.SB11 - List Price \$190

HVL693



GUEST CHAIR

Sled Base
Padded Arms

DIMENSIONS

Depth:	26	Arm Width:	18½
Width:	24¾	Seat to Floor Height:	18¼
Height:	33½	Usable Seat Depth:	18¼
Seat Depth:	18¼	Ship Weight:	38.0 Ⓢ
Seat Width:	20⅝	Cube:	5.2
Back Width:	21	Weight Rating:	250 lbs.
Back Height:	16¼		

PRICE CODE

Leather \$323

NOTES: Black SofThread™ leather with tailored stitching detail. Sturdy textured black frame. Built-in lumbar support. Use with coordinating Executive Chair model HVL691 on page 305.

HON Recommendation: HVL693.SB11 - List Price \$323

HOW TO SPECIFY

Select
Model Number

Select
Fabric

SB11 Black Leather
Specify for models HVL605, HVL643, HVL653 and HVL693

HVL605.

SB11



Icon Legend on page 14

basyx by HON® Wood Guest Chairs

HVL852



GUEST CHAIR

Leg Base
Arms
Upholstered Back
Wood Frame

DIMENSIONS

Depth:	22	Arm Width:	20
Width:	22½	Seat to Floor Height:	18½
Height:	31	Usable Seat Depth:	17
Seat Depth:	17	Ship Weight:	26 Ⓢ
Seat Width:	20	Cube:	3.4
Back Width:	20	Weight Rating:	250 lbs.
Back Height:	13		

PRICE CODE

Leather **\$365**

NOTES: Wood frames available in Bourbon Cherry and Mahogany. Black SofThread™ leather inset in back and on seat. Black SofThread™ leather. Easier assembly – seat now attached to frame. Use with coordinating Executive model HVL844 on page 308.

HON Recommendation: HVL852.H.SB11 - List Price \$365

HVL853

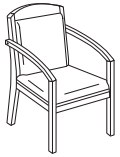

GUEST CHAIR

Leg Base
Arms
Upholstered Back
Wood Frame

DIMENSIONS

Depth:	23¾	Arm Width:	20¼
Width:	23¾	Seat to Floor Height:	19½
Height:	36¾	Usable Seat Depth:	18¼
Seat Depth:	18¼	Ship Weight:	35 Ⓢ
Seat Width:	22	Cube:	6.9
Back Width:	18½	Weight Rating:	250 lbs.
Back Height:	15¼		

PRICE CODE

Leather **\$464**

NOTES: Wood frames available in Bourbon Cherry and Mahogany. Black SofThread™ leather on fully-upholstered back panel and on seat. High-back design. Use with coordinating Executive model HVL844 on page 308.

HON Recommendation: HVL853.H.SB11 - List Price \$464

HOW TO SPECIFY

Select
Model Number

H V L 8 5 2 .

Select
Wood Finish

H Bourbon Cherry
N Mahogany

H .

Select
Fabric

SB11 Black Leather
Specify for models HVL852 and HVL853

S B 1 1

basyx by HON® Modular Lounge

NOT ON GSA CONTRACT



Icon Legend on page 14

HVL864

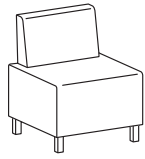

MODULAR CHAIR

DIMENSIONS

Depth:	25	Arm Width:	25
Width:	25	Seat to Floor Height:	17¼
Height:	30⅞	Usable Seat Depth:	18½
Seat Depth:	18½	Ship Weight:	33 Ⓢ
Seat Width:	25	Cube:	5.5
Back Width:	21½	Weight Rating:	250 lbs.
Back Height:	15⅝		

PRICE CODE

Leather \$550

NOTES: Thick cushioning and individually pocketed coil springs provide long-lasting comfort. Lightweight frame. Easier assembly - no tools required. SofThread™ leather.

HON Recommendation: HVL864.SB11 - List Price \$550

HVL862

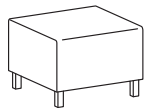

OTTOMAN

DIMENSIONS

Depth:	25	Seat to Floor Height:	17¼
Width:	25	Usable Seat Depth:	25
Height:	18¼	Ship Weight:	31 Ⓢ
Seat Depth:	25	Cube:	5.5
Seat Width:	25	Weight Rating:	250 lbs.

PRICE CODE

Leather \$400

NOTES: Thick cushioning and individually pocketed coil springs provide long-lasting comfort. Functions as footrest, seat or side table. SofThread™ leather. Easier assembly - no tools required.

HON Recommendation: HVL862.SB11 - List Price \$400

HOW TO SPECIFY

Select
Model Number

Select
Fabric

SB11 Black SofThread™ Leather (only)

H V L 8 6 4 .

S B 1 1



Icon Legend on page 14

basyx by HON® Cantilever Tables

HML8858

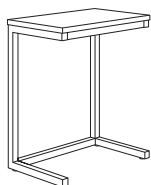

CANTILEVER TABLE

DIMENSIONS

Depth:	9 ⁷ / ₈	Ship Weight:	12.8 Ⓢ
Width:	17 ¹ / ₂	Cube:	1.1
Height:	20 ³ / ₄		

LIST PRICE

\$145

NOTES: Welded brackets increase overall strength. Single-piece, cross beam construction creates greater durability. Scratch-, spill- and stain-resistant laminate stands up to heavy use.

HON Recommendation: HML8858.P - List Price \$145

HOW TO SPECIFY

Select
Model Number

Select
Fabric

- P** Black
- C1** Chestnut
- WH** Wheat

H M L 8 8 5 8 . P

basyx by HON® Contemporary Lounge

NOT ON GSA CONTRACT



Icon Legend on page 14

HVL887

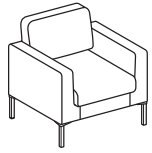

CLUB CHAIR

DIMENSIONS

Depth:	28	Arm Width:	22¼
Width:	31½	Seat to Floor Height:	17⅞
Height:	30½	Usable Seat Depth:	19¾
Seat Depth:	19¾	Ship Weight:	51 S
Seat Width:	22¼	Cube:	8.9
Back Width:	22¼	Weight Rating:	250 lbs.
Back Height:	17½		

PRICE CODE

Leather **\$764**

NOTES: Legs available in Platinum. Legs and back ship unattached.

❗ Available in SB11 SofThread™ Leather only.

HON Recommendation: HVL887.SB11 - List Price \$764

HVL888

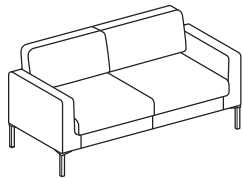

SOFA

DIMENSIONS

Depth:	28	Arm Width:	55
Width:	67	Seat to Floor Height:	17⅞
Height:	30½	Usable Seat Depth:	19¾
Seat Depth:	19¾	Ship Weight:	78
Seat Width:	55	Cube:	18.3
Back Width:	55	Weight Rating:	250 lbs.
Back Height:	17½		

PRICE CODE

Leather **\$977**

NOTES: Legs available in Platinum. Legs and back ship unattached.

❗ Available in SB11 SofThread™ Leather only.

HON Recommendation: HVL888.SB11 - List Price \$977

HOW TO SPECIFY

Select
Model Number

Select
Fabric

SB11 Black Leather (only)

H V L 8 8 7 .

S B 1 1



Icon Legend on page 14

Contemporary Occasional Tables

HML8851

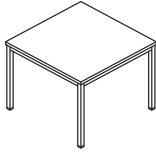

LAMINATE CORNER TABLE DIMENSIONS

Depth:	24	Ship Weight:	24 Ⓢ
Width:	24	Cube:	1.7

LIST PRICE

\$153

NOTES: Metal leg occasional tables available in Chestnut or Black laminate. Choose from Corner or Coffee Table options.

HON Recommendation: HML8851.P - List Price \$153

HML8852

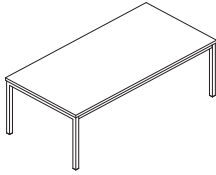

LAMINATE COFFEE TABLE DIMENSIONS

Depth:	24	Ship Weight:	38 Ⓢ
Width:	48	Cube:	3.1

LIST PRICE

\$194

NOTES: Metal leg occasional tables available in Chestnut or Black laminate. Choose from Corner or Coffee Table options.

HON Recommendation: HML8852.P - List Price \$194

HOW TO SPECIFY

<p>Select Model Number</p> <div style="border: 1px solid black; padding: 5px; display: flex; justify-content: space-between; margin-top: 10px;"> H M L 8 8 5 1 . P </div>	<p>Select Laminate</p> <p>P Black C1 Chestnut</p>
--	--



HVL871

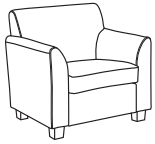

CLUB CHAIR

DIMENSIONS

Depth:	28¾	Arm Width:	21½
Width:	33	Seat to Floor Height:	18½
Height:	32	Usable Seat Depth:	21
Seat Depth:	21	Ship Weight:	51
Seat Width:	21½	Cube:	20.7
Back Width:	30	Weight Rating:	250 lbs.
Back Height:	18½		

PRICE CODE

Leather **\$983**

NOTES: Legs available in Black. Legs ship unattached. Available in SB11 SofThread™ Leather only.

HON Recommendation: HVL871.SB11 - List Price \$983

HVL872

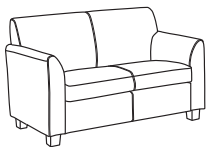

LOVE SEAT

DIMENSIONS

Depth:	28¾	Arm Width:	42
Width:	53½	Seat to Floor Height:	18½
Height:	32	Usable Seat Depth:	21
Seat Depth:	21	Ship Weight:	76
Seat Width:	42	Cube:	33.1
Back Width:	50	Weight Rating:	250 lbs.
Back Height:	18½		

PRICE CODE

Leather **\$1246**

NOTES: Legs available in Black. Legs ship unattached. Available in SB11 SofThread™ Leather only.

HON Recommendation: HVL872.SB11 - List Price \$1246

HVL873

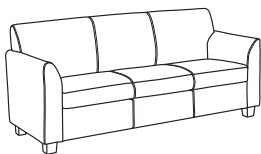

SOFA

DIMENSIONS

Depth:	28¾	Arm Width:	61½
Width:	73	Seat to Floor Height:	18½
Height:	32	Usable Seat Depth:	21
Seat Depth:	21	Ship Weight:	122
Seat Width:	61½	Cube:	45.0
Back Width:	70	Weight Rating:	250 lbs.
Back Height:	18½		

PRICE CODE

Leather **\$1557**

NOTES: Legs available in Black. Legs ship unattached. Available in SB11 SofThread™ Leather only.

HON Recommendation: HVL873.SB11 - List Price \$1557

HOW TO SPECIFY

Select
Model Number

Select
Fabric

SB11 Black SofThread™ Leather

H V L 8 7 1 .

S B 1 1

CROSS REFERENCE INDEX

MODEL	PAGE	MODEL	PAGE	MODEL	PAGE	MODEL	PAGE
H2071	116	H5735	276	HFLRC1	86	HHCTS	257
H2072	116	H5795	271, 272, 275, 276	HFLRC1DF	89	HHW103	289
H2073	116	H5901	62	HFLSC1	86	HI2AAA	146
H2091	215	H5902	62	HFLSC1DF	89	HI2ATA	146
H2092	215	H5903	62	HFLSO1	88	HI2FHA	146
H2093	215	H5905	63	HFLYO1	99	HIAAA	141
H2111	153	H5991	63	HFLYO1DF	100	HIATA	141
H2112	153	H5995	63	HFLYO1T	99	HIB50	149
H2141	154	H6541	282	HFLYO1TDF	101	HICS7	150
H2142	154	H6545	282	HFSS7	94	HIEH1	137
H2143	154	H6551	285	HFSS74L	95	HIEH2	137
H2144	154	H6552	285	HFSS74LDF	96	HIEH3	137
H2145	154	H7701	288	HFTB17N	106	HIFHA	80, 141
H2146	154	H7703	288	HFTLA2460	105	HIGB1	150
H2164	52	H7705	288	HFTLA3372	105	HIGCL	148
H2165	52	H7708	288	HFTLA3384	105	HIGS6	150
H2171	160	H7795	289	HFTLA3396	105	HIHC	149
H2172	160	H7803	293	HFTLC2460	105	HIL2L	148
H2191	218	H7808	293	HFTLC3372	105	HILMBR	146
H2192	218	H7823	294	HFTLC3384	105	HILTL	148
H2194	218	H7828	294	HFTLC3396	105	HIPAA	80, 141
H2281	164	H7895	293	HFTLD26	109	HISB6	150
H2282	165	HACC1TMM	65	HFTLD30	105	HITL1	139
H2283	164	HCG6	58	HFTLD36	105	HITL2	139
H2284	165	HCW1	57	HFTLS24	109	HITL3	139
H2285	166	HDAA01	70	HFTLS30	105	HITLM	144
H2403	279	HDAC01	70	HFTLS36	105	HITLMKD	145
H4001	239	HDAL02	70	HFTPTL18	108	HITS5	140
H4002	239	HFAA01	157	HFTTAL14	110, 124, 129	HITSM	144
H4003	239	HFAFL1	111	HFXB17B	106	HIWM1	138
H4008	239	HFAL02	157	HFXB29A	106	HIWM2	138
H4031	131	HFALA1	111	HFXB29AN	106	HIWM3	138
H4033	131	HFAS03	157	HFXB29B	106	HIWM8	140
H4039	131	HFASH1	111	HFXB42A	107	HIWMM	144
H4041	194	HFC01	113	HFXB42AN	107	HIWMMKD	145
H4043	194	HFC02	113	HFXB42B	107	HL1SL	81
H4048	194	HFC32	113	HGRMTAC	112, 124, 129	HL2DARM	80
H4049	194	HFCG6	95	HGRMTDATA	112	HL2SL	81
H4069	202	HFCG6DF	96	HGRMTUSB2	112, 124, 129	HL3SL	81
H4071	198	HFCL1	95	HHB02	266	HL4DARM	80
H4073	198	HFCL1DF	96	HHB03	266	HLEU	75
H4075	199	HFDB17B	106	HHCB50	268	HLEUBT	78
H4077	199	HFDB17N	106	HHCG11	253	HLMSSHHR	80
H4079	202	HFDB29A	106	HHCG11DF	254	HLOCC1	82
H4091	200	HFDB29AN	106	HHCG21	253	HLOCC2	82
H4093	200	HFDB29B	106	HHCG21DF	254	HLOCC3	82
H4095	201	HFDB42A	107	HHCG50	253	HLTM	77
H4097	201	HFDB42AF	107	HHCG50DF	255	HLTP	77
H4099	202	HFDB42AF72	107	HHCGB21	256	HLTSM	79
H5001	205	HFDB42AF84	107	HHCGB31	256	HLTSP	79
H5002	205	HFDB42AF96	107	HHCGBR	258	HLTSU	79
H5003	205	HFDB42AFN	107	HHCGBRCH	258	HLTU	77
H5021	209	HFDB42AN	107	HHCP1	253	HLWM	76
H5022	209	HFDB42B	107	HHCP1DF	255	HLWMBT	78
H5023	209	HFDB42BF	107	HHCR1	261	HLWU	76
H5701	271	HFLCO1	99	HHCR1CL	261	HLWUBT	78
H5703	271	HFLCO1DF	100	HHCRFP	261	HMG1	176
H5705	271	HFLCO1T	99	HHCT01	268	HMG2	176
H5711	272	HFLCO1TDF	101	HHCT02	268	HMG5	177
H5713	272	HFLGANG	88, 91	HHCT020	267	HMG7	177
H5715	272	HFLMC1	87	HHCT024	267	HMG11	183
H5721	275	HFLMC1DF	90	HHCT048	267	HMG12	183
H5723	275	HFLML1	87	HHCT12	268	HMH01	49
H5725	275	HFLML1DF	90	HHCTC	257	HMH02	49
H5731	276	HFLMR1	87	HHCTL4	257	HML1S	121
H5733	276	HFLMR1DF	91	HHCTRT	257	HML1SDF	125

CROSS REFERENCE INDEX

MODEL	PAGE	MODEL	PAGE	MODEL	PAGE	MODEL	PAGE
HML2S	121	HRIS	222	HVL131	304	HVL693	314
HML2SDF	126	HRIW	222	HVL151	305	HVL701	300
HML2ST	123	HR5P	223	HVL161	307	HVL702	300
HML2STDF	128	HR5S	223	HVL171	306	HVL705	302
HML3S	122	HR5W	223	HVL205	296	HVL712	301
HML3SDF	127	HRAAP	224	HVL210	309	HVL721	301
HML8851	319	HRFAP	224	HVL215	309	HVL844	308
HML8852	319	HSB50	44	HVL220	309	HVL852	315
HML8858	317	HSB50DF	46	HVL302	311	HVL853	315
HMN1	180	HSCS1	43	HVL303	311	HVL862	316
HMN2	180	HSCSIDF	45	HVL402	304	HVL864	316
HMNT1	186	HSCS2	44	HVL443	313	HVL871	320
HMNT2	186	HSCS2DF	46	HVL508	312	HVL872	320
HMS1	172	HSGANG	46	HVL511	296	HVL873	320
HMS2	172	HSGS6	43	HVL515	296	HVL887	318
HMSCART	172	HSGS6DF	45	HVL518	312	HVL888	318
HMSFLTGLD	173	HSLV2DAP	248	HVL521	297	HVL995	297, 309
HMSGANG	173	HSLV4DAP	248	HVL525	297	HVLPERCH	310
HMSGLD	173	HSLVFAP	248	HVL528	312	HVPTO2424L16	206
HMSSTLGLD	173	HSLVLMBR	248	HVL531	298	HVPTO2424L21	206
HMT1	170	HSLVSMM	244	HVL532	298	HVPTO2448L16	206
HMT5	170	HSLVSMR	245	HVL534	298	HWGN1	232
HMTS01	47	HSLVSMU	246	HVL538	312	HWGN1B	234
HMTS11	47	HSLVTMM	244	HVL541	299	HWGN2	232
HN1	191	HSLVTMMKD	247	HVL551	299	HWGN2B	234
HN1U	191	HSLVTMR	245	HVL601	307	HWGN3	232
HN6	192	HSLVTMRKD	247	HVL604	306	HWGN3B	234
HN7	192	HSLVTMU	246	HVL605	314	HWGN4	233
HNATA	192	HSLVTMUKD	247	HVL606	313	HWGN4B	235
HNFPA	192	HSUR2TMM	66	HVL616	313	HWGN5	233
HPN1	212	HTPWARGROM1	82, 124, 129	HVL641	305	HWGN5B	235
HPN2	212	HUCART	202	HVL643	314	HWGN6	236
HQTMM	228	HVL103	303	HVL653	314	HWGN7	236
HQTSM	228	HVL105	303	HVL685	302	HXCL2TMM	67
HRIP	222	HVL108	303	HVL691	305		

Table Finishes					
		Hospitality Tables	Huddle Multi-Purpose Tables	66000 Series/The StationMaster®	Utility Tables
TOPS	L1 LAMINATES	CODES			
Woodgrain	Bourbon Cherry	H	•	•	•
	Brilliant White	WHIT	•	•	•
	Cognac	COGN	•	•	•
	Harvest	C	•	•	•
	Mahogany	N	•	•	•
	Mocha	MOCH	•	•	•
	Natural Maple	D	•	•	•
	Pinnacle	PINC	•	•	•
Solid	Shaker Cherry	F	•	•	•
	Black	P	•	•	•
	Charcoal	S	•	•	•
	Light Gray <input type="checkbox"/>	Q			•
Patterned	Whitestone	K4	•	•	•
	Sheer Mesh	A5	•	•	•
	Silver Mesh	B9	•	•	•
	Steel Mesh	A9	•	•	•
	Taupe Mesh	A8	•	•	•
	Canyon Zephyr	K9	•	•	•
	Desert Zephyr	K8	•	•	•
	Shadow Zephyr	K1	•	•	•
	Gray	G2	•	•	•
	Grey Tigris	L6	•	•	•
White	G1	•	•	•	
TOPS	L2 LAMINATES	CODES			
Woodgrain	Lowell Ash <i>NEW! 1/30/2017</i>	LLA1		•	
	Natural Recon <i>NEW! 1/30/2017</i>	LNRI		•	
	Phantom Ecu <i>NEW! 1/30/2017</i>	LPE1		•	
	Portico Teak <i>NEW! 1/30/2017</i>	LPT1		•	
	Skyline Walnut <i>NEW! 1/30/2017</i>	LSW1		•	

Recommended Edgeband Color Selection:

Laminate	Edge
Bourbon Cherry	H
Cognac	COGN
Harvest	C
Mahogany	N
Mocha	MOCH
Natural Maple	D
Pinnacle	PINC
Shaker Cherry	F
Black	P
Brilliant White	WHIT
Charcoal	S
Loft	LOFT
Whitestone	K4
Sheer Mesh	A5
Silver Mesh	B9
Steel Mesh	A9
Taupe Mesh	A8
Canyon Zephyr	K9
Desert Zephyr	K8
Shadow Zephyr	K1
Gray	G2
Grey Tigris	L6
White	G1
Lowell Ash	LLA1
Natural Recon	LNRI
Phantom Ecu	LPE1
Portico Teak	LPT1
Skyline Walnut	LSW1

Edge Finishes					
		Hospitality Tables	Huddle Multi-Purpose Tables	66000 Series/The StationMaster®	Utility Tables
EDGES	EDGE BAND (2 MM)	CODES			
	Black	P	•	•	
	Bourbon Cherry	H	•	•	
	Brilliant White	WHIT	•	•	
	Charcoal	S	•	•	
	Cognac	COGN	•	•	
	Greige	R	•	•	
	Harvest	C	•	•	
	Light Gray	Q	•	•	
	Loft	LOFT	•	•	
	Lowell Ash <i>NEW! 1/30/2017</i>	DL		•	
	Mahogany	N	•	•	
	Mocha	MOCH	•	•	
	Muslin	T	•	•	
	Natural Maple	D	•	•	
	Natural Recon <i>NEW! 1/30/2017</i>	NR		•	
	Phantom Ecu <i>NEW! 1/30/2017</i>	PE		•	
	Pinnacle	PINC	•	•	
	Platinum	K	•	•	
	Portico Teak <i>NEW! 1/30/2017</i>	DP		•	
	Shadow	SHDW	•	•	
	Shaker Cherry	F	•	•	
	Skyline Walnut <i>NEW! 1/30/2017</i>	SW		•	
T-MOLD		CODES			
	Cognac	COGN	•		
	Mahogany	N	•		
	Mocha	MOCH	•		
	Natural Maple	D	•		
	Black	P	•	•	
	Brilliant White	WHIT	•	•	
	Charcoal	S	•	•	
	Greige	R	•	•	
	Light Gray	Q	•	•	
	Loft	LOFT	•	•	
	Muslin	T	•	•	
	Pinnacle	PINC	•	•	
Platinum	K	•	•		
Shadow	SHDW	•	•		
BASE PAINTS		CODES			
Core	Black	P	•	•	•
	Charcoal	S		•	•
	Chrome	CHR	•		
	Greige	T5		•	•
	Loft	LOFT		•	•
	Light Gray	Q		•	•
	Muslin	T3		•	•
	Putty	L		•	•
Shadow	SHDW		•	•	
Metallic & Choice	Brilliant White	WHIT		•	
	Champagne Metallic	T4		•	
	Platinum Metallic	T1		•	

Arrange™ Café Tables Ordering Information

			Table Tops	Table Bases	Shroud Accessories
TOPS	L1 LAMINATES	CODES			
Woodgrain	Bourbon Cherry	H	•	•	•
	Cognac	COGN	•	•	•
	Harvest	C	•	•	•
	Mahogany	N	•	•	•
	Mocha	MOCH	•	•	•
	Natural Maple	D	•	•	•
	Pinnacle	PINC	•	•	•
Solid	Shaker Cherry	F	•	•	•
	Black	P	•	•	•
	Brilliant White	WHIT	•	•	•
	Charcoal	S	•	•	•
	Loft	LOFT	•	•	•
Patterned	Whitestone	K4	•	•	•
	Sheer Mesh	A5	•	•	•
	Silver Mesh	B9	•	•	•
	Steel Mesh	A9	•	•	•
	Taupe Mesh	A8	•	•	•
	Canyon Zephyr	K9	•	•	•
	Desert Zephyr	K8	•	•	•
Shadow Zephyr	K1	•	•	•	
TOPS	L2 LAMINATES	CODES			
Woodgrain	Lowell Ash <i>NEW! 1/30/2017</i>	LLA1	•	•	•
	Natural Recon <i>NEW! 1/30/2017</i>	LNR1	•	•	•
	Phantom Ecu <i>NEW! 1/30/2017</i>	LPE1	•	•	•
	Portico Teak <i>NEW! 1/30/2017</i>	LPT1	•	•	•
	Skyline Walnut <i>NEW! 1/30/2017</i>	LSW1	•	•	•
EDGE BAND*		CODES			
	Black	P	•	•	•
	Bourbon Cherry	H	•	•	•
	Brilliant White	WHIT	•	•	•
	Charcoal	S	•	•	•
	Cognac	COGN	•	•	•
	Greige	R	•	•	•
	Harvest	C	•	•	•
	Light Gray	Q	•	•	•
	Loft	LOFT	•	•	•
	Lowell Ash <i>NEW! 1/30/2017</i>	DL	•	•	•
	Mahogany	N	•	•	•
	Mocha	MOCH	•	•	•
	Muslin	T	•	•	•
	Natural Maple	D	•	•	•
	Natural Recon <i>NEW! 1/30/2017</i>	NR	•	•	•
	Phantom Ecu <i>NEW! 1/30/2017</i>	PE	•	•	•
	Pinnacle	PINC	•	•	•
	Platinum	K	•	•	•
	Portico Teak <i>NEW! 1/30/2017</i>	DP	•	•	•
	Shadow	SHDW	•	•	•
Shaker Cherry	F	•	•	•	
Skyline Walnut <i>NEW! 1/30/2017</i>	SW	•	•	•	
PAINTS		CODES			
Textured	Textured Satin Chrome	P6N	•	•	•
	Textured Black	BLCK	•	•	•
	Textured Platinum Metallic	PLAT	•	•	•

* Edge detail color can be different from top color on laminate tops and tablets.

Recommended Edgeband Color Selection:

Laminate	Edgeband
Bourbon Cherry	H Bourbon Cherry
Cognac	COGN Cognac
Harvest	C Harvest
Mahogany	N Mahogany
Mocha	MOCH Mocha
Natural Maple	D Natural Maple
Pinnacle	PINC Pinnacle
Shaker Cherry	F Shaker Cherry
Black	P Black
Brilliant White	WHIT Brilliant White
Charcoal	S Charcoal
Whitestone	K4 Muslin
Sheer Mesh	A5 Muslin
Silver Mesh	B9 Loft
Steel Mesh	A9 Charcoal
Taupe Mesh	A8 Greige
Canyon Zephyr	K9 Greige
Desert Zephyr	K8 Greige
Shadow Zephyr	K1 Loft
Lowell Ash	LLA1 Lowell Ash
Natural Recon	LNR1 Natural Recon
Phantom Ecu	LPE1 Phantom Ecu
Portico Teak	LPT1 Portico Teak
Skyline Walnut	LSW1 Skyline Walnut
Loft	LOFT Loft

- ▶ Pre-drilled holes for easy attachment.
- ▶ HPL laminate.

- ▶ 2mm Edgeband.
- ▶ Optional grommet cutouts for standard 3" grommet or NEW mini grommets.

- ▶ 2 grommet cutouts on Rectangles which will be positioned over the installed bases.

⚠ **Grommet cutouts will not utilize grommet covers. The grommet accessory will need to be ordered.**



	Description	Model	Ship Weight	Cube	List Price by Laminate Grade	
					L1	L2
	Café Round Table Tops					
	24"W Round Top	HCTRND24 E♠A	19	1.9	\$ 279	\$ 294
	30"W Round Top	HCTRND30 E♠A	31	2.9	\$ 300	\$ 315
	36"W Round Top	HCTRND36 E♠A	44	4.0	\$ 327	\$ 342
	42"W Round Top	HCTRND42 E♠A	57	5.4	\$ 389	\$ 409
	48"W Round Top	HCTRND48 E♠A	71	7.2	\$ 424	\$ 444
	Square Table Tops					
	24"W Square Top	HCTSQR24 E♠A	19	2.2	\$ 266	\$ 281
	30"W Square Top	HCTSQR30 E♠A	31	2.9	\$ 286	\$ 301
	36"W Square Top	HCTSQR36 E♠A	44	4.1	\$ 312	\$ 327
	42"W Square Top	HCTSQR42 E♠A	57	5.6	\$ 371	\$ 391
	Soft Square Table Tops					
	24"W Soft Square Top	HCTSFT24 E♠A	19	1.9	\$ 279	\$ 294
	30"W Soft Square Top	HCTSFT30 E♠A	31	2.9	\$ 300	\$ 315
	36"W Soft Square Top	HCTSFT36 E♠A	44	4.0	\$ 327	\$ 342
	42"W Soft Square Top	HCTSFT42 E♠A	57	5.4	\$ 389	\$ 409
	48"W Soft Square Top	HCTSFT48 E♠A	71	7.2	\$ 424	\$ 444
	Rectangle Table Tops					
	24"W x 48"D Rectangle Top	HCTRECT2448 E♠A	36	3.6	\$ 317	\$ 332
	24"W x 60"D Rectangle Top	HCTRECT2460 E♠A	44	4.4	\$ 347	\$ 362
	24"W x 72"D Rectangle Top	HCTRECT2472 E♠A	56	4.9	\$ 368	\$ 388
	30"W x 48"D Rectangle Top	HCTRECT3048 E♠A	51	4.4	\$ 327	\$ 342
	30"W x 60"D Rectangle Top	HCTRECT3060 E♠A	63	5.4	\$ 368	\$ 383
	30"W x 72"D Rectangle Top	HCTRECT3072 E♠A	75	6.0	\$ 408	\$ 428

desks workstations storage & files seating tables education/learning accessories bundles index

How to specify	1st Option	2nd Option	3rd Option
Select Model Number from above H C T R N D 2 4 .	Select Grommet Option G Round Grommet (\$15 upcharge) M Mini Grommet (\$10 upcharge) N No Grommet Upcharge doubles for HCTRECT models G .	Select Laminate See page 634 C .	Select Edge Color See page 634 C

Arrange™ Café Table Bases

GSA SIN 711-11



- ▶ Models available for seated (30"), counter (36") and café (42") heights.
- ▶ Individual feet allow for easy reconfiguration.
- ▶ Feet and upright made from aluminum.
- ▶ Adjustable glides available on all feet.
- ▶ Wire management is standard through the upright.

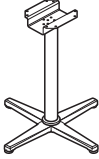
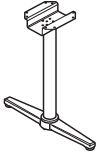

	Description	Model	Ship Weight	Cube	List	
	Café Table Bases — X-Base					
	Seated Height X-base for 24"-30"D Surfaces	HCT29SX E♦A	22	3.3	\$ 425	
	Seated Height X-base for 36"D Surfaces	HCT29MX E♦A	23	3.3	\$ 472	
	Seated Height X-base for 42"-48"D Surfaces	HCT29LX E♦A	25	3.3	\$ 519	
	Counter Height X-base for 24"-30"D Surfaces	HCT36SX E♦A	24	4.6	\$ 472	
	Counter Height X-base for 36"D Surfaces	HCT36MX E♦A	25	4.6	\$ 519	
	Counter Height X-base for 42"-48"D Surfaces	HCT36LX E♦A	27	4.6	\$ 566	
	Café Height X-base for 24"-30"D Surfaces	HCT42SX E♦A	25	4.6	\$ 519	
	Café Height X-base for 36"D Surfaces	HCT42MX E♦A	26	4.6	\$ 566	
	Café Height X-base for 42"-48"D Surfaces	HCT42LX E♦A	27	4.6	\$ 613	
		Café Table Bases — T-Leg Base				
		Seated Height T-legs for 24"D Surfaces (2 bases incl.)	HCT29ST E♦A	33	3.3	\$ 576
Seated Height T-legs for 30"D Surfaces (2 bases incl.)		HCT29MT E♦A	34	3.3	\$ 641	
Counter Height T-legs for 24"D Surfaces (2 bases incl.)		HCT36ST E♦A	36	4.6	\$ 620	
Counter Height T-legs for 30"D Surfaces (2 bases incl.)		HCT36MT E♦A	37	4.6	\$ 669	
Café Height T-legs for 24"D Surfaces (2 bases incl.)		HCT42ST E♦A	37	4.6	\$ 664	
Café Height T-legs for 30"D Surfaces (2 bases incl.)		HCT42MT E♦A	38	4.6	\$ 713	

How to specify	<p>Select Model Number from above</p> <p>HCT29SX</p>	<p>1st Option</p> <p>Select Paint Color</p> <p>BLCK Textured Black P6N Textured Satin Chrome PLAT Textured Platinum Metallic</p> <p>BLCK</p>
----------------	--	--

Icon Legend on page 10

- ▶ Shroud is used as an optional accessory to provide the aesthetic of a disc base.
- ▶ Shroud can be added to existing X-base configurations to provide a new and updated aesthetic.
- ▶ Shroud is made of 18 gauge steel.
- ▶ USB grommet is equipped with 2 USB connections.
- ▶ AC grommet is equipped with 1 AC connection.
- ▶ Power Hub includes 6' cord with three-prong plug.
- ▶ **Shroud to be used in conjunction with X-bases ONLY.**
- ▶ **Shroud cannot be used with a T-leg configuration.**
- ▶ **Shroud cannot be used as a support piece by itself.**
- ▶ **HGRMTAC available in black only.**

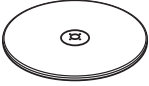
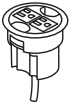

	Description	Model	Ship Weight	Cube	List
 SIN 711-11	Café Table Bases — Disc Shroud Small Disc Shroud for bases that support 24"-30" Surfaces Medium Disc Shroud for bases that support 36" Surfaces Large Disc Shroud for bases that support 42"-48" Surfaces	HCTS DS E◊A HCTM DS E◊A HCTL DS E◊A	9.0 12.0 17.0	2.0 2.4 3.4	\$ 82 \$ 95 \$ 110
	Café Electrical Mini AC Grommet 1 1/16" cutout Mini USB Grommet 1 1/16" cutout	HGRMT MINIAC E◊A HGRMT MINIUSB E◊A	1.5 0.8	0.1 0.2	\$ 85 \$ 160
	Field Installable Grommet <ul style="list-style-type: none"> Intended for use in tops and end panels to route/hide cords and in modesty panels to facilitate reaching wall electrical outlets. Black Finish Grommet is field installable. Requires a 3" diameter hole saw and drill for installation (not included). Grommet shape is round. Includes grommet cap and sleeve. Grommet outside dimensions measures 3 1/2" diameter and includes two cord access holes. Grommet sleeve measures 3" O.D. x 1" thick. Includes instructions to locate grommet position for desks, credenzas, returns and bridges. 	HFLDGRMT3	0.1 [S]	0.3	\$ 28
	Power Hub, 3" Grommet Mount <ul style="list-style-type: none"> Fits in 3" round grommet holes on the following product lines: 10500, 10700, Coordinate, Pennsylvania Avenue and Voi desks; Abound Worksurfaces; Huddle and Motivate tables and SmartLink. Two grounded AC power outlets. Includes 6' cord with three-prong plug. Field installed with Plug-and-play ease. ▲ Available in black only (no color designation so use .X – Specify: HGRMTAC.X).	HGRMTAC	1.3	0.2	\$ 100
 SIN 71-302	Power/USB Hub, 3" Grommet Mount <ul style="list-style-type: none"> One grounded AC power outlet with 2 USB ports. UL Listed. ▲ Available in black only (no color designation so use .X – Specify: HGRMTUSB2.X).	HGRMTUSB2	1.3 [S]	0.2	\$ 198

Open Market

How to specify	Select Model Number from above H C T S D S .	1st Option Select Paint Color <i>For HCTS, HCTM and HCTL models only</i> BLCK Textured Black P6N Textured Satin Chrome PLAT Textured Platinum Metallic B L C K
----------------	---	--

Build™ Ordering Information



		CODES	Table Tops	Upper Legs Only
L1 LAMINATES				
Woodgrain	Bourbon Cherry	H	•	
	Cognac	COGN	•	
	Harvest	C	•	
	Mahogany	N	•	
	Mocha	MOCH	•	
	Natural Maple	D	•	
	Pinnacle	PINC	•	
	Shaker Cherry	F	•	
Solid	Black	P	•	
	Brilliant White	WHIT	•	
	Charcoal	S	•	
Patterned	Sheer Mesh	A5	•	
	Silver Mesh	B9	•	
	Steel Mesh	A9	•	
	Taupe Mesh	A8	•	
	Canyon Zephyr	K9	•	
	Desert Zephyr	K8	•	
	Shadow Zephyr	K1	•	
	Blue Agave NEW!	LBA1	•	
	Gray	G2	•	
	Grey Tigris	L6	•	
	Kiwi NEW!	LKW1	•	
	Pomegranate NEW!	LBG1	•	
	Tangerine NEW!	LTG1	•	
	White	G1	•	
	Whitestone	K4	•	
T-MOLD				
Woodgrain	Cognac	COGN	•	
	Mahogany	N	•	
	Mocha	MOCH	•	
	Natural Maple	D	•	
	Pinnacle	PINC	•	
	Shaker Cherry	F	•	
Solid	Black	P	•	
	Brilliant White	WHIT	•	
	Charcoal	S	•	
	Greige	R	•	
	Loft	LOFT	•	
	Muslin	T	•	
	Platinum	K	•	
PAINTS				
Textured	Black	P		•
	Platinum	T1		•



2 people / 1 table

Line Item	Product Description	Qty	Model #	List Price	Price Extension
1	Kite Table with 4-Pack Adjustable Post Legs 50"W x 30"D	1	HESA-3050E-4L	\$598	\$ 598
2	Motivate® Four-Leg Stack Chair; Plastic Shell w/Arms (Set of 2)	1	HMG1	\$560	\$ 560
TOTAL:					\$1,158

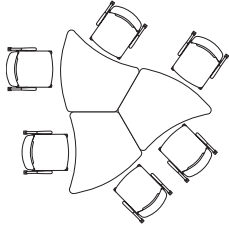

6 people / 3 tables

Line Item	Product Description	Qty	Model #	List Price	Price Extension
1	Kite Table with 4-Pack Adjustable Post Legs 50"W x 30"D	3	HESA-3050E-4L	\$598	\$1,794
2	Motivate® Nesting/Stacking Chair; Plastic Shell w/Arms	6	HMN1	\$456	\$2,736
TOTAL:					\$4,530

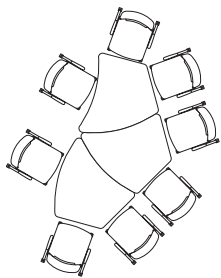

8 people / 3 tables

Line Item	Product Description	Qty	Model #	List Price	Price Extension
1	Kite Table with 4-Pack Adjustable Post Legs 50"W x 30"D	3	HESA-3050E-4L	\$598	\$1,794
2	Motivate® Nesting/Stacking Chair; Plastic Shell w/Arms	8	HMN1	\$456	\$3,648
TOTAL:					\$5,442

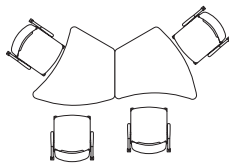

4 people / 2 tables

Line Item	Product Description	Qty	Model #	List Price	Price Extension
1	Kite Table with 4-Pack Adjustable Post Legs 50"W x 30"D	2	HESA-3050E-4L	\$598	\$1,196
2	Motivate® Nesting/Stacking Chair; Plastic Shell w/Upholstered Seat/Arms	4	HMN2	\$517	\$2,068
TOTAL:					\$3,264

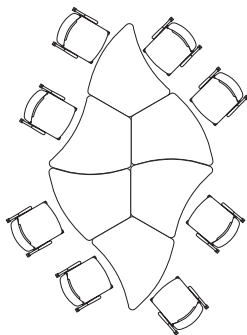

8 people / 6 tables

Line Item	Product Description	Qty	Model #	List Price	Price Extension
1	Kite Table with 4-Pack Adjustable Post Legs 50"W x 30"D	6	HESA-3050E-4L	\$598	\$3,588
2	Motivate® Nesting/Stacking Chair; Plastic Shell w/Upholstered Seat/Arms	8	HMN2	\$517	\$4,136
TOTAL:					\$7,724

Build™ Configurations

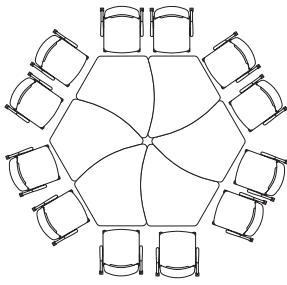

12 people / 6 tables

Line Item	Product Description	Qty	Model #	List Price	Price Extension
1	Kite Table with 4-Pack Adjustable Post Legs 50"W x 30"D	6	HESN-3050E-4L	\$598	\$3,588
2	Motivate® Four-Leg Stack Chair; Plastic Shell/Armless (Set of 2)	6	HMG1	\$500	\$3,000
TOTAL:					\$6,588

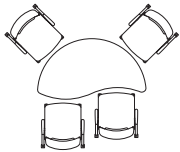

4 people / 1 table

Line Item	Product Description	Qty	Model #	List Price	Price Extension
1	Wisp Table with 4-Pack Adjustable Post Legs 54"W x 30"D	1	HESN-3054E-4L	\$583	\$ 583
2	Motivate® Nesting/Stacking Chair; Plastic Shell w/Arms	4	HMN1	\$456	\$1,824
TOTAL:					\$2,407

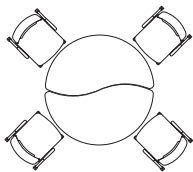

4 people / 2 tables

Line Item	Product Description	Qty	Model #	List Price	Price Extension
1	Wisp Table with 4-Pack Adjustable Post Legs 54"W x 30"D	2	HESN-3054E-4L	\$583	\$1,166
2	Motivate® Nesting/Stacking Chair; Plastic Shell w/Upholstered Seat & Back w/Arms	4	HMN2	\$587	\$2,348
TOTAL:					\$3,514

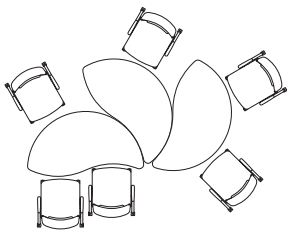

6 people / 3 tables

Line Item	Product Description	Qty	Model #	List Price	Price Extension
1	Wisp Table with 4-Pack Adjustable Post Legs 54"W x 30"D	3	HESN-3054E-4L	\$583	\$1,749
2	Motivate® Nesting/Stacking Chair; Plastic Shell w/Upholstered Seat/Arms	6	HMN2	\$517	\$3,102
TOTAL:					\$4,851

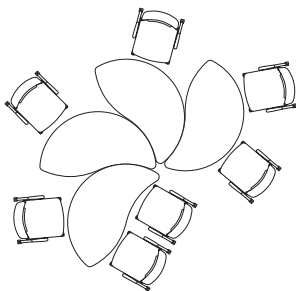

7 people / 4 tables

Line Item	Product Description	Qty	Model #	List Price	Price Extension
1	Wisp Table with 4-Pack Adjustable Post Legs 54"W x 30"D	4	HESN-3054E-4L	\$583	\$2,332
2	Motivate® Nesting/Stacking Chair; Plastic Shell w/Arms	7	HMN1	\$456	\$3,192
TOTAL:					\$5,524

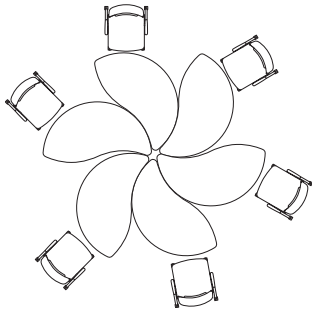

6 people / 6 tables

Line Item	Product Description	Qty	Model #	List Price	Price Extension
1	Wisp Table with 4-Pack Adjustable Post Legs 54"W x 30"D	6	HESN-3054E-4L	\$583	\$3,498
2	Motivate® Nesting/Stacking Chair; Plastic Shell w/Arms	6	HMN1	\$456	\$2,736
TOTAL:					\$6,234

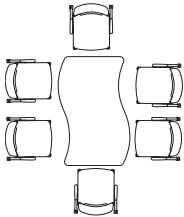

6 people / 1 table

Line Item	Product Description	Qty	Model #	List Price	Price Extension
1	Ribbon Table with 4-Pack Adjustable Post Legs 54"W x 30"D	1	HESW-3054E-4L	\$537	\$ 537
2	Motivate® Nesting/Stacking Chair; Plastic Shell w/Upholstered Seat & Back w/Arms	6	HMN2	\$587	\$3,522
TOTAL:					\$4,059

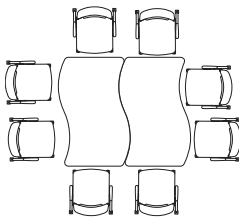

8 people / 2 tables

Line Item	Product Description	Qty	Model #	List Price	Price Extension
1	Ribbon Table with 4-Pack Adjustable Post Legs 54"W x 30"D	2	HESW-3054E-4L	\$537	\$1,074
2	Motivate® Nesting/Stacking Chair; Plastic Shell w/Arms	8	HMN1	\$456	\$3,648
TOTAL:					\$4,722

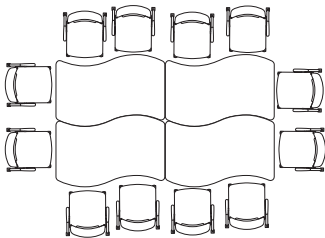

12 people / 4 tables

Line Item	Product Description	Qty	Model #	List Price	Price Extension
1	Ribbon Table with 4-Pack Adjustable Post Legs 54"W x 30"D	4	HESW-3054E-4L	\$537	\$2,148
2	Motivate® Four-Leg Stack Chair; Plastic Shell/Armless (Set of 2)	6	HMG1	\$500	\$3,000
TOTAL:					\$5,148

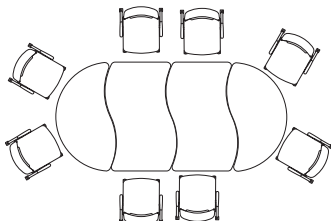

8 people / 4 tables

Line Item	Product Description	Qty	Model #	List Price	Price Extension
1	Ribbon Table with 4-Pack Adjustable Post Legs 54"W x 30"D	2	HESW-3054E-4L	\$537	\$1,074
2	Wisp Table with 4-Pack Adjustable Post Legs 54"W x 30"D	2	HESN-3054E-4L	\$583	\$1,166
3	Motivate® Nesting/Stacking Chair; Plastic Shell w/Upholstered Seat/Arms	8	HMN2	\$517	\$4,136
TOTAL:					\$6,376

Build™ Tables





Not on GSA Contract

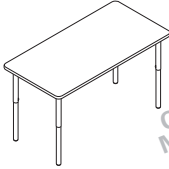
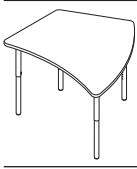

- ▶ Tops are laminate over 1 1/8" thick solid core high-performance particleboard and include a backer sheet.
- ▶ Legs adjust from 25-34" in 1" increments with a simple set screw.
- ▶ Specify paint for upper portion of leg, bottom is chrome.
- ▶ Bracket welded to leg to allow for easy installation. Three worksurface attachment screws included per leg.
- ▶ For all power modules please see page 748.
- ▶ Casters allow for tables to be easily reconfigured.
- ▶ Top and base are specified together, but shipped separately.

△ **Tops available in 3mm T-mold edge only.**
 △ **All models covered by the HON Limited Lifetime Warranty.**

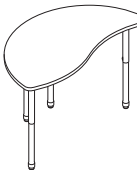
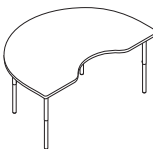

	Description	Model	Ship Weight	Cube	List	
 <p>Open Market</p>	Rectangle Table with 4 Adjustable Post Legs 48"W x 24"D 60"W x 24"D 72"W x 24"D	HETR-2448E-4L E◆A HETR-2460E-4L E◆A HETR-2472E-4L E◆A	64.0 76.0 87.0	4.9 5.7 6.2	\$ 479 \$ 513 \$ 553	
	48"W x 30"D 60"W x 30"D 72"W x 30"D	HETR-3048E-4L E◆A HETR-3060E-4L E◆A HETR-3072E-4L E◆A	80.5 90.0 104.0	5.7 6.2 6.7	\$ 493 \$ 525 \$ 578	
	Half Round Table with 4 Adjustable Post Legs 60"W x 30"D	HESH-3060E-4L E◆A	88.0	7.3	\$ 563	
	NOTES: Can be used with other Rectangle and Half Round Tables (30"D Rectangles, 60"W Rectangles, and 60"W x 30"D Half Rounds).					
	 <p>Open Market</p>	Kite Table with 4 Adjustable Post Legs 40"W x 24"D 50"W x 30"D	HESA-2440E-4L E◆A HESA-3050E-4L E◆A	49.0 69.0	5.2 7.1	\$ 579 \$ 598
		△ Can be used with other Kite Tables of same size only.				
 <p>Open Market</p>	Ribbon Table with 4 Adjustable Post Legs 54"W x 30"D	HESW-3054E-4L E◆A	84.0	5.9	\$ 537	
NOTES: Can be used with other Ribbon, Wisp, and Rectangle Tables (54"W x 30"D Ribbon, 54"W x 30"D Wisp, and 60"W Rectangle OR 30"D Rectangle).						
 <p>Open Market</p>	Wisp Table with 4 Adjustable Post Legs 54"W x 30"D	HESN-3054E-4L E◆A	82.0	5.9	\$ 583	
NOTES: Can be used with other Wisp and Ribbon Tables (54"W x 30"D Wisp and 54"W x 30"D Ribbon).						
 <p>Open Market</p>	Arc Table with 4 Adjustable Post Legs 72"W x 48"D	HESKD-7248E-4L E◆A	130.7	8.5	\$ 776	
 <p>Open Market</p>	Locking Casters, 4-Pack • Black only • 4 casters per pack • All casters lockable • Threaded attachment bolts • Can retrofit on units with glides • Can utilize glides and casters together (2 casters, 2 glides)	HHABCASTER E◆A	1.0	0.1	\$ 65	
 <p>Open Market</p>	Power & Data Center 2 Receptacles 2 Data Accessory • Standard with two receptacles and openings for two data ports. • 6' power cord with standard three-prong plug. • Fits on any worksurface with a 4" overhang. • UL Listed.	HCOMDOME2	2.5	0.2	\$ 259	
	△ Color finish coordinates with HON's Loft. Specify LOFT when ordering. Example: HCOMDOME2.LOFT.					

How to specify	1st Option	2nd Option	3rd Option	4th Option
Select Model Number from above	Select Grommet	Select Laminate Color	Select T-Mold Color	Select Upper-Leg Paint Color
H E T R - 2 4 4 8 E - 4 L .	N No Grommet N .	See page 638 H .	See page 638 P .	See page 638 P .



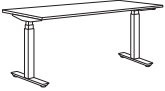
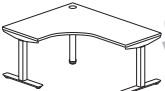

- ▶ Height Adjustable Base is a 3-stage column design.
- ▶ Base rises from 23⁵/₈" to 49¹/₄" for a sit-to-stand desk option.
- ▶ Height Adjustable Bases ship complete with a preassembled motor.
- ▶ HHAB3S24F accommodates rectangular workspaces between 24"D x 48"W and 36"D x 72"W. Systems, Voi®, 10500, and Preside® all have workspaces within this range.
- ▶ 3-Leg Base can accommodate configurations between 24"D x 48"W x 60"L and 30"D x 72"W x 72"L.
- ▶ 3-Leg Base can accommodate two workspaces to create configurations within specified dimensions.
- ▶ Base telescopes to accommodate any workspace between 48"W and 72"W.
- ▶ Standard height-adjustable control ships with base.
- ▶ Silver finish matches any neutral HON paint or finish color.

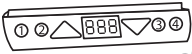

	Description	Model	Ship Weight	Cube	List
	Height Adjustable Base – 3 Stage 24"D Feet and Worksurface Brackets ▲ Available in silver finish only, no specification needed. Suggested coordinated paint, Platinum Metallic.	HHAB3S24F E♦A	80	2.8	\$1250
Base shown with worksurface attached.					
	3-Leg Height Adjustable Base – 3 Stage 24"D Feet and Worksurface Brackets ▲ Available in silver finish only, no specification needed. Suggested coordinated paint, Platinum Metallic.	HHAB3S3C24F E♦A	102	4.4	\$1700
Base shown with worksurface attached.					

- ▶ Optional Memory Control allows preset workspace heights for consistency. Ships separately.
- ▶ Dynamic load capacity when workspace is moving is 300 lbs.
- ▶ Silver finish matches any neutral HON paint or finish color.
- ▶ HON's Optional Memory Control (HHABMEM) does not work with the *basyx* by HON® Height Adjustable Base.

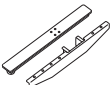

	Description	Model	Ship Weight	Cube	List
	Height Adjustable Base – Optional Memory Control ▲ Available in black finish only, no specification needed. Memory controller includes digital display and four memory presets.	HHABMEM	0.5	0.4	\$ 75
Open Market					
	Under Worksurface Power Module – 4 Outlets, 10' Cord <ul style="list-style-type: none"> • Includes 10' cord with three-prong plug. • Fits in cable management troughs. See page 668. • 4 outlets on side create easy access. NOTES: Power Modules will also work with standing-height applications for 10500 Series™ and Voi® desks. ▲ Available in black finish only, no specification needed.	HPWRMOD2 E♦A	1.5	0.2	\$ 340
Open Market					
	3" Round Power Grommet – 2 Outlets, 10' Cord <ul style="list-style-type: none"> • Includes 10' cord with three-prong plug. • Fits in 3" round grommet holes on the following product lines: Coordinate, Huddle, Motivate, all laminate and veneer casegoods series, and Systems Worksurfaces. • Two grounded AC power outlets. • Field installed with Plug-and-play ease. NOTES: Power Modules will also work with standing-height applications for 10500 Series™ and Voi® desks. ▲ Available in black finish only, no specification needed.	HGRMTAC2 E♦A	1.5	0.2	\$ 126
Open Market					
	Corner-Cove Extension Kit – For use with Right-Hand Corner-Coves Corner-Cove Extension Kit – For use with Left-Hand Corner-Coves NOTES: Use the Corner-Cove Extension Kit with the 2-leg base when a Corner-Cove is used. ▲ Available in silver finish only, no specification needed. Suggested coordinated paint, Platinum Metallic.	HHABCCEXTL E♦A 13.0 0.3 \$ 83 HHABCCEXTR E♦A 13.0 0.3 \$ 83			
Open Market					
	Caster Add-On Kit ▲ Available in black finish only, no specification needed.	HHABCASTER E♦A	1.0	0.1	\$ 65
Open Market					

How to specify

Select Model Number from above

H | H | A | B | 3 | S | 3 | C | 2 | 4 | F

Icon Legend on page 10

► Systems Rectangle Worksurfaces for Height Adjustable Bases designed for use in panel systems. Worksurface is 2" shorter in width and 3/4" shorter in depth to provide clearance between panels and other worksurfaces.

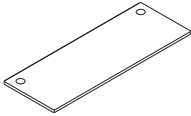

Description	Model	Ship Weight	Cube	List Price by Laminate Grade	
				L1	L2
 <p>Systems Rectangle Worksurfaces for Height Adjustable Bases 46 3/4"W x 23 1/4"D 52"W x 23 1/4"D 58"W x 23 1/4"D 64"W x 23 1/4"D 70"W x 23 1/4"D</p>	HHAW2448P	58	3.3	\$ 403	\$ 418
	HHAW2454P	64	4.0	\$ 425	\$ 445
	HHAW2460P	70	4.0	\$ 471	\$ 491
	HHAW2466P	86	4.8	\$ 504	\$ 524
	HHAW2472P	89	4.8	\$ 520	\$ 540
<p>▲ Must be used as worksurfaces on Coordinate™ Height Adjustable Bases within Panel Systems, as these are 1" shorter in width on each side to provide clearance between panels and other worksurfaces.</p> <p>▲ Available in all standard systems' laminate and edgbanding options. Only offered with grommets.</p> <p>Specify Model.LaminateColor.EdgeColor.GrommetColor SPECIFYING EXAMPLE: HHAW2448P.A5.K.T1</p>					

 <p>Systems Rectangle Worksurfaces for Height Adjustable Bases 46 3/4"W x 29 1/4"D 52"W x 29 1/4"D 58"W x 29 1/4"D 64"W x 29 1/4"D 70"W x 29 1/4"D</p>	HHAW3048P	68	4.0	\$ 432	\$ 447
	HHAW3054P	80	5.0	\$ 463	\$ 483
	HHAW3060P	101	5.0	\$ 512	\$ 532
	HHAW3066P	105	6.0	\$ 545	\$ 565
	HHAW3072P	105	6.0	\$ 581	\$ 601
<p>▲ Must be used as worksurfaces on Coordinate™ Height Adjustable Bases within Panel Systems, as these are 1" shorter in width on each side to provide clearance between panels and other worksurfaces.</p> <p>▲ Available in all standard systems' laminate and edgbanding options. Only offered with grommets.</p> <p>Specify Model.LaminateColor.EdgeColor.GrommetColor SPECIFYING EXAMPLE: HHAW3048P.A5.K.T1</p>					

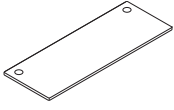
 <p>Voi® Rectangle Worksurfaces for Height Adjustable Bases</p>	48"W x 24"D	HLSLR2448	61	3.4	\$ 264	\$ 279
	54"W x 24"D	HLSLR2454	68	4.2	\$ 284	\$ 304
	60"W x 24"D	HLSLR2460	75	4.2	\$ 309	\$ 329
	66"W x 24"D	HLSLR2466	82	5.0	\$ 336	\$ 356
	72"W x 24"D	HLSLR2472	89	5.0	\$ 347	\$ 367
	48"W x 30"D	HLSLR3048	75	4.2	\$ 284	\$ 299
	54"W x 30"D	HLSLR3054	84	5.1	\$ 317	\$ 337
	60"W x 30"D	HLSLR3060	92	5.1	\$ 354	\$ 374
	66"W x 30"D	HLSLR3066	101	6.1	\$ 381	\$ 401
	72"W x 30"D	HLSLR3072	110	6.1	\$ 414	\$ 434
	60"W x 36"D	HLSLR3660	110	6.1	\$ 444	\$ 469
	66"W x 36"D	HLSLR3666	120	7.2	\$ 480	\$ 505
	72"W x 36"D	HLSLR3672	130	7.2	\$ 539	\$ 564

▲ **For use with Coordinate™ Height Adjustable Bases only in Freestanding Applications, which are applications where the tables/desks are not attached or adjacent to another unit, table/desk or systems panel. The widths are true to stated dimensions. If used with Panel Systems or other than in Freestanding Applications, worksurfaces will not provide proper clearance between panels or other worksurfaces, and may cause injury or worksurface damage (not covered by warranty).**

▲ **For 36"D rectangular worksurfaces, the height adjustable base must be centered in the middle of the worksurface.**

How to specify	1st Option	2nd Option	3rd Option	4th Option
Select Model Number from above	Select Laminate	Select Edge Color	Select Grommet Color	Select Grommet Option and Color
	See page 309	See page 309 Specify for Systems Worksurfaces only	See page 309 Specify for Systems Worksurfaces only	Specify for Voi® Worksurfaces only X No Grommet G Grommet If choosing the grommet option Select Grommet Color P Black Grommet WHIT Brilliant White Grommet T5 Greige Grommet T1 Platinum Grommet
H H A W 2 4 4 8 P .	A 5 .	K .	T 1 	G T 5
H L S L R 2 4 4 8 .	N N .			

Icon Legend on page 10

- ▶ Corner-Cove Worksurfaces for Height Adjustable Bases designed for use in panel systems. Worksurface is 1" shorter in width and 1" shorter in depth on side of corner to provide clearance between panels and other worksurfaces.
- ▶ Use the Corner-Cove Extension Kit on page 643 with the 2-leg base when a Corner-Cove Worksurface is used.

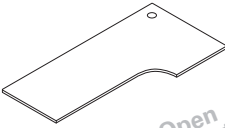

Edgeband	Description	Model	Ship Weight	Cube	List Price by Laminate Grade	
					L1	L2
 <p>Open Market</p>	Corner-Cove Worksurfaces for Height Adjustable Bases, Left Hand					
	60" A x 36" B x 24" C x 24" D	HHAWV603624LP	67	6.1	\$ 572	\$ 597
	72" A x 36" B x 24" C x 24" D	HHAWV723624LP	75	6.8	\$ 626	\$ 656
	60" A x 48" B x 24" C x 24" D	HHAWV604824LP	85	7.4	\$ 626	\$ 656
	60" A x 48" B x 30" C x 30" D	HHAWV604830LP	99	7.4	\$ 672	\$ 702
	72" A x 48" B x 24" C x 24" D	HHAWV724824LP	105	8.8	\$ 782	\$ 817
	72" A x 48" B x 30" C x 30" D	HHAWV724830LP	112	8.8	\$ 830	\$ 865

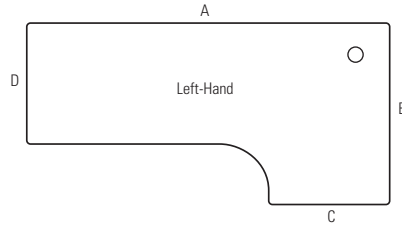

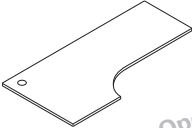
 <p>Open Market</p>	Corner-Cove Worksurfaces for Height Adjustable Bases, Right Hand					
	60" A x 36" B x 24" C x 24" D	HHAWV603624RP	67	6.1	\$ 572	\$ 597
	72" A x 36" B x 24" C x 24" D	HHAWV723624RP	75	6.8	\$ 626	\$ 656
	60" A x 48" B x 24" C x 24" D	HHAWV604824RP	85	7.4	\$ 626	\$ 656
	60" A x 48" B x 30" C x 30" D	HHAWV604830RP	99	7.4	\$ 672	\$ 702
	72" A x 48" B x 24" C x 24" D	HHAWV724824RP	105	8.8	\$ 782	\$ 817
	72" A x 48" B x 30" C x 30" D	HHAWV724830RP	112	8.8	\$ 830	\$ 865

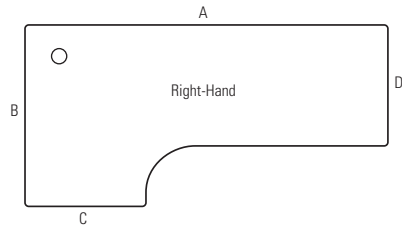

How to specify	1st Option	2nd Option	3rd Option
Select Model Number from above	Select Laminate See page 309	Select Edge Color See page 309	Select Grommet Color See page 309
H H A W V 6 0 3 6 2 4 L P .	A 5 .	K .	T 1

Icon Legend on page 10

- ▶ Laminate or mixed material floating modesty panels options are available for attachment under 10500 Series worksurfaces. The modesty panel and attachment bracket are packaged separately.
- ▶ If using a 54"W or 60"W floating modesty panel, it is not necessary to specify an external support channel under the worksurface.
- ▶ When using a floating modesty panel under the worksurface, the depth clearance for center drawers and keyboard platforms decreases by 8".

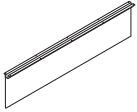

Description	Model	Ship Weight	Cube	L1 List	L2 Upcharge
 <p>Laminate Floating Modesty Panel 30"W x 14"H 36"W x 14"H 42"W x 14"H 48"W x 14"H 54"W x 14"H 60"W x 14"H</p>	HLSL3014L	10	0.8	\$ 148	\$ 10
	HLSL3614L	12	0.8	\$ 156	\$ 10
	HLSL4214L	14	0.8	\$ 169	\$ 10
	HLSL4814L	16	1.1	\$ 186	\$ 12
	HLSL5414L	18	1.1	\$ 204	\$ 12
	HLSL6014L	20	1.1	\$ 220	\$ 12
NOTES: The attachment bracket and modesty panel are packaged separately. Specify: Model.Laminate.Paint SPECIFYING EXAMPLE: HLSL3014L.N.P (Black is the only paint option for this model) ▲ When specifying the 54"W or 60"W Laminate Floating Modesty Panel, it is not necessary to specify an external channel. ▲ 30"W and 36"W screens attach with L-brackets, not the external channel.					

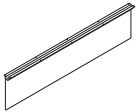





Description	Model	Ship Weight	Cube	List
 <p>Mixed Material Floating Modesty Panel 30"W x 14"H 36"W x 14"H 42"W x 14"H 48"W x 14"H 54"W x 14"H 60"W x 14"H</p>	HLSL3014MM	8	2.0	\$ 597
	HLSL3614MM	8	2.0	\$ 641
	HLSL4214MM	9	2.3	\$ 716
	HLSL4814MM	11	2.6	\$ 794
	HLSL5414MM	13	3.3	\$ 862
	HLSL6014MM	13	3.3	\$ 984
NOTES: The attachment bracket and modesty panel are packaged separately. Specify: Model.Mixed Material.Paint SPECIFYING EXAMPLE: HLSL3014MM.FT01.P (Frosted Translucent mixed material and Black paint are the only options for this model) ▲ When specifying the 54"W or 60"W Mixed Material Floating Modesty Panel, it is not necessary to specify an external channel.				

FLOATING MODESTY PANELS – MODEL SELECTION GUIDE						
Support Combination		Rectangle Worksurface Width				
Support 1	Support 2	72 in	66 in	60 in	48 in	42 in
O-Leg	O-Leg	HLSL6014	HLSL5414	HLSL4814	HLSL3614	HLSL3014
O-Leg	L-Shaped End Panel	HLSL4814	HLSL4214	HLSL3614	NA	NA
O-Leg	4½" Diameter Support Column	HLSL4814	HLSL4814	HLSL4814	HLSL3614	HLSL3014
O-Leg	2" Square Post Leg	HLSL4814	HLSL4814	HLSL4814	HLSL3614	HLSL3014
L-Shaped End Panel	L-Shaped End Panel	HLSL3614	HLSL3014	NA	NA	NA
L-Shaped End Panel	4½" Diameter Support Column	HLSL3614	HLSL3614	HLSL3614	NA	NA
L-Shaped End Panel	2" Square Post Leg	HLSL3614	HLSL3614	HLSL3614	NA	NA
T-Shaped End Panel	O-Leg	HLSL5414	HLSL4814	HLSL4214	HLSL3014	NA
T-Shaped End Panel	L-Shaped End Panel	HLSL3614	HLSL3014	NA	NA	NA
T-Shaped End Panel	4½" Diameter Support Column	HLSL3614	HLSL3014	NA	NA	NA
T-Shaped End Panel	2" Square Post Leg	HLSL3614	HLSL3014	NA	NA	NA

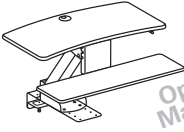
Support Combination		Bullet Worksurface Width		
Support 1	Support 2	72 in	66 in	60 in
O-Leg	4½" Diameter Support Column	HLSL4814	HLSL4814	HLSL4814
O-Leg	2" Square Post Leg	HLSL4814	HLSL4814	HLSL4814
L-Shaped End Panel	4½" Diameter Support Column	HLSL3614	HLSL3614	HLSL3614
L-Shaped End Panel	2" Square Post Leg	HLSL3614	HLSL3614	HLSL3614
T-Shaped End Panel	4½" Diameter Support Column	HLSL3614	HLSL3614	HLSL3614
T-Shaped End Panel	2" Square Post Leg	HLSL3614	HLSL3614	HLSL3614

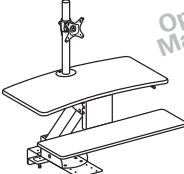
How to specify	<p>Select Model Number from above</p> <p>H L S L 3 0 1 4 M M .</p>	<p>1st Option</p> <p>Select Mixed Material</p> <p>FT01 Frosted Translucent</p> <p>F T 0 1</p>
----------------	--	---

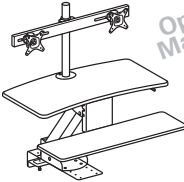
- ▶ These products are designed to allow the user to transition from seating position to standing position throughout the workday.
 - ▶ Gas-assist lever-operated mechanism with positive stop.
 - ▶ Clamp mount compatible with worksurfaces depths of 20"-30".
 - ▶ Clamp requires 3.5" of clearance along back edge of worksurface.
 - ▶ Black seamless worksurfaces.
 - ▶ Silver powder coated metal components.
 - ▶ Lowers below worksurface level on 24" and 30"D worksurfaces.
 - ▶ All models contain a large primary worksurface and a smaller keyboard / mouse surface.
 - ▶ Beveled edges for sleek appearance and comfort while typing.
 - ▶ Monitor arms include height, width, and swivel adjustment.
- ⚠ **Not recommended for use on mobile (castered) worksurfaces.**

	Description	Model	Ship Weight	Cube	List
	Directional™ Desktop Sit-to-Stand Device NOTES: Does not include a monitor arm and is suitable for laptops and/or monitors on their original stands.	HS1100	60 	3.2	\$ 525
	Directional™ Desktop Sit-to-Stand Device with Single Monitor Arm NOTES: Includes a monitor arm for a single monitor.	HS1101	62 	3.2	\$ 615
	Directional™ Desktop Sit-to-Stand Device with Dual Monitor Arm NOTES: Includes a monitor arm for dual monitors.	HS1102	63 	3.2	\$ 700

Mounting and Compatibility:

- This product is intended to be installed on commercial-grade worksurfaces in good condition.
- Compatible with freestanding worksurfaces 24"-30"D or panel-supported worksurfaces 24"-30"D.
- Not for use on mobile worksurfaces.

Clamp Mount

Use when 3.5" minimum overhang is available

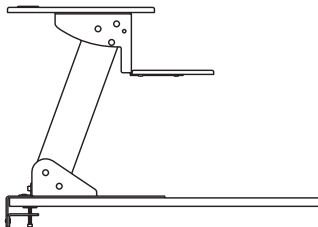

Screw Mount

Use when no overhang is available. Worksurface must be minimum 1" thick.

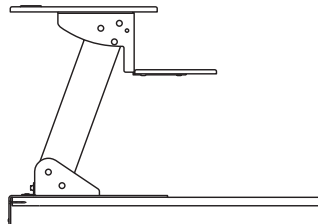

How to specify

Select Model Number from above

H | S | 1 | 1 | 0 | 0



  Icon Legend on page 10

Endorse™ Tables

GSA SIN 711-11 Except as Noted

- ▶ Tables available in Square or Rectangular table tops.
- ▶ Model HLOCC2 has enclosed sides that are paint-matched to the selected frame color.
- ▶ Table legs are available in Black (BLCK) or Textured Satin Chrome (P6N). Tables are shipped ETA.
- ▶ **Choose from two grommet cutout options — Round Grommet (G) or Pop-up Port (G1), both centered in the table top. The grommet ships with round cutout, must order Pop-up Port separately. See below.**

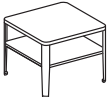

	Description	Model	Ship Weight	Cube	List Price by Laminate Grade	
					L1	L2
	Square Occasional Table, Open All Sides 24"D x 24"W x 19"H NOTES: Ships in two boxes.	HLOCC1 E♦A	45	2.6	\$ 791	\$ 806
<i>Model shown without grommet option</i>						
	Square Occasional Table, Open Front and Back 24"D x 24"W x 19"H NOTES: Enclosed on sides. Ships in three boxes.	HLOCC2 E♦A	55	2.6	\$ 853	\$ 868
<i>Model shown with Round grommet option</i>						
	Rectangular Occasional Table, Open All Sides 24"D x 40"W x 19"H NOTES: Ships in two boxes.	HLOCC3 E♦A	65	3.1	\$ 918	\$ 938
<i>Model shown with Flip-top Port grommet option</i>						

Endorse™ Occasional Tables are available in 10 laminate colors. Each laminate has a specific selection of edges available. See color options below.

L1 Laminate Top Colors

- Mahogany (N)
- Shaker Cherry (F)
- Bourbon Cherry (H)
- Natural Maple (D)
- Brilliant White (WHIT)
- Charcoal (S)
- Silver Mesh (B9)
- Cognac (COGN)
- Mocha (MOCH)
- Pinnacle (PINC)

Edgeband Colors

- Mahogany (N), Loft (LOFT), Shadow (SHDW)
- Shaker Cherry (F), Muslin (T), White (WHIT), Loft (LOFT), Shadow (SHDW)
- Bourbon Cherry (H), Muslin (T), White (WHIT)
- Natural Maple (D), Muslin (T), White (WHIT), Loft (LOFT)
- Brilliant White (WHIT)
- Charcoal (S)
- Loft (LOFT)
- Cognac (COGN), Muslin (T), White (WHIT)
- Mocha (MOCH), Muslin (T), White (WHIT), Loft (LOFT), Shadow (SHDW)
- Pinnacle (PINC), Muslin (T), White (WHIT), Loft (LOFT), Shadow (SHDW)

L2 Laminate Top Colors

- Lowell Ash (LLA1)
- Natural Recon (LNR1)
- Phantom Ecru (LPE1)
- Portico Teak (LPT1)
- Skyline Walnut (LSW1)

Edgeband Colors

- Lowell Ash (DL), Muslin (T), White (WHIT), Loft (LOFT), Shadow (SHDW)
- Natural Recon (NR), Muslin (T), White (WHIT), Loft (LOFT), Shadow (SHDW)
- Phantom Ecru (PE), Muslin (T), White (WHIT), Loft (LOFT), Shadow (SHDW), Charcoal (S)
- Portico Teak (DP), Muslin (T), White (WHIT), Loft (LOFT), Shadow (SHDW), Charcoal (S)
- Skyline Walnut (SW), Muslin (T), White (WHIT), Loft (LOFT), Shadow (SHDW), Charcoal (S)

How to specify	1st Option	2nd Option	3rd Option
Select Model Number from above H L O C C 1 .	Select Grommet Option N No Grommet G Round Grommet (\$15 upcharge) G1 Pop-up Port Grommet Cut-out only (\$40 upcharge) N .	Select Laminate and Edge See above N N .	Select Frame Color BLCK Textured Black P6N Textured Satin Chrome B L C K

	Description	Model	Ship Weight	Cube	List
	Power Hub, 3" Grommet Mount <ul style="list-style-type: none"> • Fits in 3" round grommet holes on the following product lines: 10500, 10700, Coordinate, Pennsylvania Avenue and Voi desks; Abound Worksurfaces; Huddle and Motivate tables and SmartLink. • Two grounded AC power outlets. • Includes 6' cord with three-prong plug. • Field installed with Plug-and-play ease. ▲ Available in black only (no color designation so use .X – Specify: HGRMTAC.X).	HGRMTAC	1.3	0.2	\$ 100

			Table Tops	Table Bases	Tablets	Legs/Lamps
TOPS	VENEERS	CODES				
Woodgrain	Bourbon Cherry D	H	•		•	
	Cognac D	COGN	•		•	
	Harvest D	C	•		•	
	Mahogany D	N	•		•	
	Mocha D	MOCH	•		•	
	Natural Maple D	D	•		•	
	Pinnacle D	PINC	•		•	
	Shaker Cherry D	F	•		•	
TOPS	L1 LAMINATES	CODES				
Woodgrain	Bourbon Cherry	H	•		•	
	Cognac	COGN	•		•	
	Harvest	C	•		•	
	Mahogany	N	•		•	
	Mocha	MOCH	•		•	
	Natural Maple	D	•		•	
	Pinnacle	PINC	•		•	
	Shaker Cherry	F	•		•	
Solid	Black	P	•		•	
	Brilliant White	WHIT	•		•	
	Charcoal	S	•		•	
	Loft	LOFT	•		•	
	Whitestone	K4	•		•	
Patterned	Sheer Mesh	A5	•		•	
	Silver Mesh	B9	•		•	
	Steel Mesh	A9	•		•	
	Taupe Mesh	A8	•		•	
	Canyon Zephyr	K9	•		•	
	Desert Zephyr	K8	•		•	
	Shadow Zephyr	K1	•		•	
	TOPS	L2 LAMINATES	CODES			
Woodgrain	Lowell Ash NEW! 1/30/2017	LLA1	•		•	
	Natural Recon NEW! 1/30/2017	LNR1	•		•	
	Phantom Ecu NEW! 1/30/2017	LPE1	•		•	
	Portico Teak NEW! 1/30/2017	LPT1	•		•	
	Skyline Walnut NEW! 1/30/2017	LSW1	•		•	
EDGE BAND*	CODES					
Black	P	•		•		
Bourbon Cherry	H	•		•		
Brilliant White	WHIT	•		•		
Charcoal	S	•		•		
Cognac	COGN	•		•		
Greige	R	•		•		
Harvest	C	•		•		
Light Gray	Q	•		•		
Loft	LOFT	•		•		
Lowell Ash NEW! 1/30/2017	DL	•		•		
Mahogany	N	•		•		
Mocha	MOCH	•		•		
Muslin	T	•		•		
Natural Maple	D	•		•		
Natural Recon NEW! 1/30/2017	NR	•		•		
Phantom Ecu NEW! 1/30/2017	PE	•		•		
Pinnacle	PINC	•		•		
Platinum	K	•		•		
Portico Teak NEW! 1/30/2017	DP	•		•		
Shadow	SHDW	•		•		
Shaker Cherry	F	•		•		
Skyline Walnut NEW! 1/30/2017	SW	•		•		
PAINTS**	CODES					
Textured	Textured Satin Chrome	P6N		•		•
	Textured Charcoal	P7A		•		•

Recommended Edgeband Color Selection:

Laminate		Edgeband	
Bourbon Cherry	H	Bourbon Cherry	H
Cognac	COGN	Cognac	COGN
Harvest	C	Harvest	C
Mahogany	N	Mahogany	N
Mocha	MOCH	Mocha	MOCH
Natural Maple	D	Natural Maple	D
Pinnacle	PINC	Pinnacle	PINC
Shaker Cherry	F	Shaker Cherry	F
Black	P	Black	P
Brilliant White	WHIT	Brilliant White	WHIT
Charcoal	S	Charcoal	S
Whitestone	K4	Muslin	T
Sheer Mesh	A5	Muslin	T
Silver Mesh	B9	Loft	LOFT
Steel Mesh	A9	Charcoal	S
Taupe Mesh	A8	Greige	R
Canyon Zephyr	K9	Greige	R
Desert Zephyr	K8	Greige	R
Shadow Zephyr	K1	Loft	LOFT
Lowell Ash	LLA1	Lowell Ash	DL
Natural Recon	LNR1	Natural Recon	NR
Phantom Ecu	LPE1	Phantom Ecu	PE
Portico Teak	LPT1	Portico Teak	DP
Skyline Walnut	LSW1	Skyline Walnut	SW
Loft	LOFT	Loft	LOFT

* Edge detail color can be different from top color on laminate tops and tablets.

** Applies to all models — includes bases, legs, and lamps.

TOP SHAPES

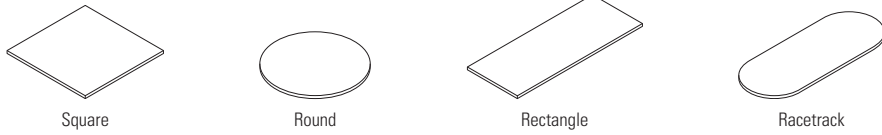
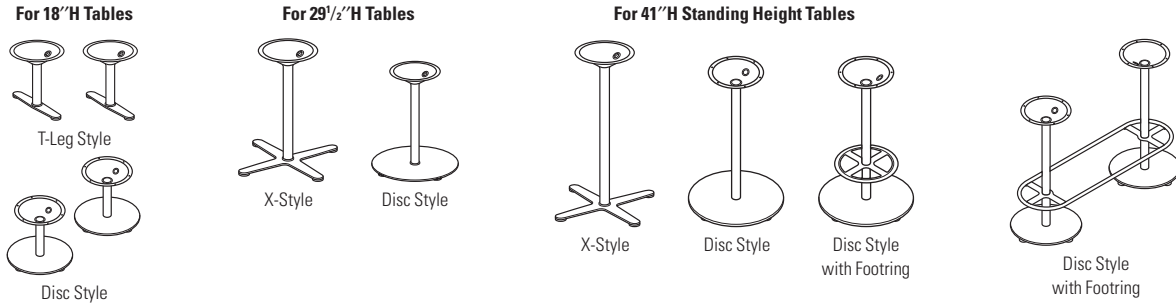
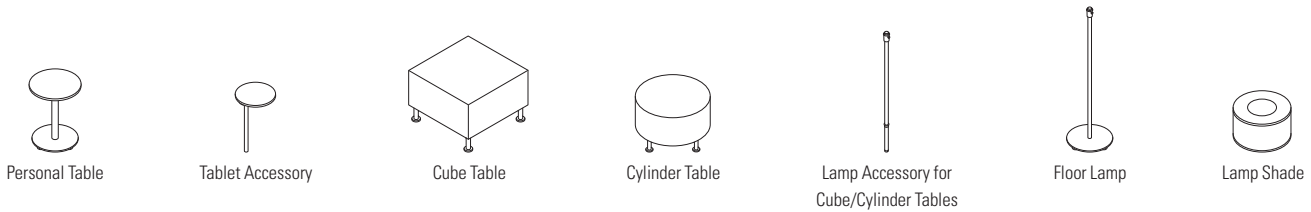

TABLE BASES



TABLES AND ACCESSORIES



GROMMET MATRIX — All tables/tops

TOP WIDTH	NO GROMMET	1-3" ROUND GROMMET CENTERED	2-3" ROUND GROMMET LEFT & RIGHT
SIF OPTION CODE	N	G	G
24" Cube	YES	YES	N/A
26" Cylinder	YES	YES	N/A
18" Personal	N/A	N/A	N/A
30" Square/Round	YES	YES	N/A
36" Square/Round	YES	YES	N/A
60" Rectangle/Racetrack	YES	N/A	YES
72" Rectangle/Racetrack	YES	N/A	YES
84" Rectangle/Racetrack	YES	N/A	YES
96" Rectangle/Racetrack	YES	N/A	YES

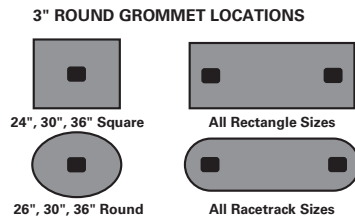

NOTE: 3" round grommet color will need to be specified for tops. Grommet will coordinate with paint color specified for cube/cylinder tables. Charcoal grommets will be used with Textured Charcoal paint and Platinum Metallic grommets will be used with Textured Satin Chrome paint. Grommet options can be used in conjunction with accessory ports on cube/cylinder tables. Grommet models HGRMTAC and HGRMTDATA on page 654 can also be used with Flock® tables.

ACCESSORY PORT LOCATIONS

Only applies to models HFTLS24, HFTLD26, HFTVS24, and HFTVD26.

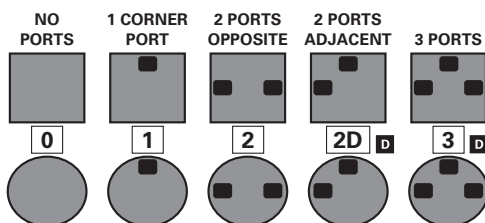

NOTE:
 Port location 1 allows for either one tablet or one lamp accessory — see models on pages 653-654.
 Port location 2 allows for either one tablet and one lamp accessory or two tablet accessories (two lamps cannot be used) — see models on pages 653-654.
 Port location 2D allows for either one tablet and one lamp accessory or two tablet accessories (two lamps cannot be used) — see models on pages 653-654.
 Port location 3 allows for two tablets accessories and one lamp accessory (two lamps cannot be used; three tablets cannot be used; three lamps cannot be used) — see models on pages 653-654.

Icon Legend on page 10 **D** Discontinued 2/28/2017.

► Choose from Square, Round, Rectangle or Racetrack shaped table tops.





► Grommet models HGRMTAC and HGRMTDATA on page 654 can also be used with Flock® tables.

► Specify table tops with or without grommets. See page 650.
 ► Specify bases separately, see page 652.



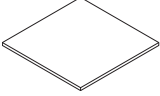

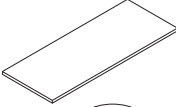
► Rectangle and Racetrack tops come with 2 grommet cutouts if specified with Round grommet.

► For a complete line of compatible Flock® collaborative seating solutions, please see pages 541-548 of the seating section.

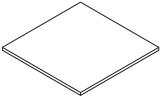

Description	Model	Ship		List
		Weight	Cube	
 Veneer Table Tops 36" Square Top 30" Square Top	HFTVS36 D	45	1.2	\$1191
	HFTVS30 D	32	1.0	\$ 965
 36" Round Top 30" Round Top	HFTVD36 D	35	1.2	\$1191
	HFTVD30 D	25	1.0	\$ 965
 96"W x 33"D Rectangle Top 84"W x 33"D Rectangle Top 72"W x 33"D Rectangle Top 60"W x 24"D Rectangle Top	HFTVC3396 D	105	2.9	\$1855
	HFTVC3384 D	90	2.5	\$1645
	HFTVC3372 D	78	2.2	\$1435
	HFTVC2460 D	47	1.3	\$1104
 96"W x 33"D Racetrack Top 84"W x 33"D Racetrack Top 72"W x 33"D Racetrack Top 60"W x 24"D Racetrack Top	HFTVA3396 D	101	2.9	\$1855
	HFTVA3384 D	83	2.5	\$1645
	HFTVA3372 D	70	2.2	\$1435
	HFTVA2460 D	43	1.3	\$1104

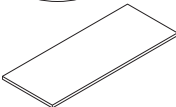
How to specify	1st Option	2nd Option	3rd Option
Select Model Number from above H F T V S 3 6 .	Select Edge Detail G Flat Edge G .	Select Grommet Option N No Grommet G Round Grommet (\$15 upcharge per grommet cutout) See page 650 for Grommet placement Select Grommet Color S Charcoal T1 Platinum Metallic N .	Select Veneer Color See page 649 H

Description	Model	Ship		List Price by Laminate Grade	
		Weight	Cube	L1	L2
 Laminate Table Tops 36" Square Top 30" Square Top	HFTLS36	45	1.2	\$ 386	\$ 406
	HFTLS30	32	1.0	\$ 342	\$ 362
 36" Round Top 30" Round Top	HFTLD36	35	1.2	\$ 386	\$ 406
	HFTLD30	25	1.0	\$ 342	\$ 362
 96"W x 33"D Rectangle Top 84"W x 33"D Rectangle Top 72"W x 33"D Rectangle Top 60"W x 24"D Rectangle Top	HFTLC3396	105	2.9	\$ 683	\$ 718
	HFTLC3384	90	2.5	\$ 585	\$ 615
	HFTLC3372	78	2.2	\$ 488	\$ 513
	HFTLC2460	47	1.3	\$ 357	\$ 372
 96"W x 33"D Racetrack Top 84"W x 33"D Racetrack Top 72"W x 33"D Racetrack Top 60"W x 24"D Racetrack Top	HFTLA3396	101	2.9	\$ 683	\$ 718
	HFTLA3384	83	2.5	\$ 585	\$ 615
	HFTLA3372	70	2.2	\$ 488	\$ 513
	HFTLA2460	43	1.3	\$ 357	\$ 372

How to specify	1st Option	2nd Option	3rd Option
Select Model Number from above H F T L S 3 6 .	Select Edge Detail G 2MM Edge Select Edge Color See page 649 G K .	Select Grommet Option N No Grommet G Round Grommet (\$15 upcharge per grommet cutout) See page 650 for Grommet placement Select Grommet Color S Charcoal T1 Platinum Metallic G T 1 .	Select Laminate Color See page 649 K 7

Icon Legend on page 10 Discontinued 2/28/2017.





Flock® Collaborative Table Bases

GSA SIN 711-11

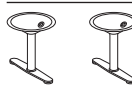
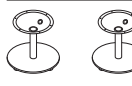

- ▶ Flock® Bases available in Disc, T-Leg and X styles.
- ▶ Specify bases for collaborative tables at 18”H, 29½”H or 41”H standing height.
- ▶ Choose from bases with or without footings.
- ▶ Each base includes adjustable leveling glides.
- ▶ Leveling glides adjust approximately 1”.

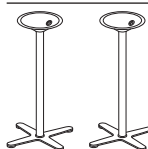
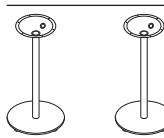
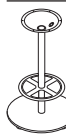
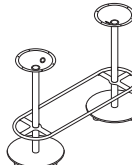

Description	Model	Ship Weight	Cube	List
 Base T-Leg Style — For 18”H Tables For 60”W x 24”D Rectangle or Racetrack Table Tops <ul style="list-style-type: none"> • Two bases shipped in separate cartons. 	HFTB17N	40	6.0	\$ 860
 Base Disc Style — For 18”H Tables <ul style="list-style-type: none"> • Use with 60”W x 24”D Racetrack or Rectangle table tops only. • Two bases shipped in separate cartons. 	HFDB17N	74	6.0	\$ 944
Base Disc Style — For 18”H Tables For 30” and 36” Round or Square Table Tops	HFDB17B	37	3.0	\$ 462
 Base X-Style — For 29½”H Tables For 30” Round or Square Table Tops For 36” Round or Square Table Tops Use with 33”D x 72”W x 84”W and 96”W Rectangle or Racetrack Table Tops <ul style="list-style-type: none"> • Two bases shipped in separate cartons 	HFxB29A	40	16.1	\$ 537
	HFxB29B	53	16.1	\$ 569
	HFxB29AN	80	32.2	\$1052
 Base X-Style — For 18”H Tables For 30” and 36” Round or Square Table Tops	HFxB17B	37	3.0	\$ 462
 Base Disc Style — For 29½”H Tables For 30” Round or Square Table Tops For 36” Round or Square Table Tops Use with 33”D x 72”W x 84”W and 96”W Rectangle or Racetrack Table Tops <ul style="list-style-type: none"> • Two bases shipped in separate cartons 	HFDB29A	40	16.1	\$ 537
	HFDB29B	56	16.1	\$ 569
	HFDB29AN	80	32.2	\$1052
 Base X-Style — For 41”H Standing Height Tables <ul style="list-style-type: none"> • Use with 33”D x 72”W, 84”W and 96”W Rectangle or Racetrack Table Tops • Two bases shipped in separate cartons 	HFxB42AN	84	36.4	\$1128
Base X-Style — For 41”H Standing Height Tables For 30” Round or Square Table Tops For 36” Round or Square Table Tops	HFxB42A	42	18.2	\$ 564
	HFxB42B	55	16.1	\$ 596
 Base Disc Style — For 41”H Standing Height Tables <ul style="list-style-type: none"> • Use with 33”D x 72”W, 84”W and 96”W Rectangle or Racetrack table tops, when a Footring is not desired. • Two bases shipped in separate cartons. 	HFDB42AN	92	19.0	\$1094
Base Disc Style — For 41”H Standing Height Tables For 30” Round or Square Table Tops For 36” Round or Square Table Tops	HFDB42A	46	9.5	\$ 547
	HFDB42B	62	13.5	\$ 581
 Base Disc Style with Footring — For 41”H Standing Height Tables For 30” Round or Square Table Tops For 36” Round or Square Table Tops Use with 33”D x 72”W x 84”W and 96”W Rectangle or Racetrack Table Tops <ul style="list-style-type: none"> • Two bases shipped in separate cartons 	HFDB42AF	56	9.5	\$ 710
	HFDB42BF	68	13.5	\$ 744
	HFDB42AFN	112	32.2	\$1392
 Base Disc Style with Footring — For 41”H Standing Height Tables For 33”D x 96”W Rectangle or Racetrack Table Tops For 33”D x 84”W Rectangle or Racetrack Table Tops For 33”D x 72”W Rectangle or Racetrack Table Tops	HFDB42AF96	121	19.7	\$1639
	HFDB42AF84	123	19.8	\$1585
	HFDB42AF72	125	19.9	\$1557

NOTES: Includes two bases and a single oval footring that spans both tables. Two bases and footring shipped in three separate cartons.

How to specify	1st Option
Select Model Number from above H F T B 1 7 N .	Select Paint Color P6N Textured Satin Chrome P7A Textured Charcoal P 6 N

Icon Legend on page 10

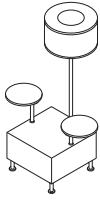

► Accessory Port options on the Collaborative Cube and Cylinder tables allow for different accessories to be added to the tables such as tablet arms or lamps.

► Use the Tablet Accessory with the Collaborative Cube and Cylinder tables for additional workspace. Attaches to tables through ports, which can be located in different location options. See page 650 for port location information.

► For grommet and port information, see page 650.
 ► HGRMTAC and HGRMTDATA on page 654 can also be used with Flock® tables.
 ► Legs can be adjusted for leveling.
 ► Standard Leg (L) can be adjusted for leveling.

► For a complete line of compatible Flock® collaborative seating solutions, please see pages 541-548 of the seating section.



Description	Model	Ship Weight	Cube	L1 List	L2 Upcharge
 Veneer Personal Table 18" Dia. x 25"H	HFTPTV18 D	36	4.5	\$ 789	N/A
Laminate Personal Table 18" Dia. x 25"H	HFTPTL18	36	4.5	\$ 559	\$ 12

How to specify	Select Model Number from above	1st Option Select Edge Detail/Color Do not specify edge color on Veneer model HFTPTV18. See page 649.	2nd Option Select Veneer or Laminate Top Color See page 649	3rd Option Select Base Paint Color P6N Textured Satin Chrome P7A Textured Charcoal
	H F T P T V 1 8 .	G .	H .	P 6 N
	H F T P T L 1 8 .	G H .	H .	P 6 N

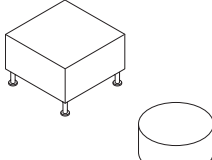
Description	Model	Ship Weight	Cube	L1 List	L2 Upcharge
 Veneer Collaborative Cube and Cylinder Tables 24" Veneer Cube Table — 24"W x 24"D x 17 1/8"H	HFTVS24 D	44	5.0	\$ 986	N/A
26" Veneer Cylinder Table — 26" Dia. x 17 1/8"H	HFTVD26 D	39	5.0	\$ 931	N/A
Laminate Collaborative Cube and Cylinder Tables 24" Laminate Cube Table — 24"W x 24"D x 17 1/8"H	HFTLS24	44	5.0	\$ 671	\$ 30
26" Laminate Cylinder Table — 26" Dia. x 17 1/8"H	HFTLD26	39	5.0	\$ 615	\$ 30

NOTES: Accessory port quantity and configuration on tables should correspond to the accessories planned for the table. For grommet and port information, see page 650.

How to specify	Select Model Number from above	1st Option Select Grommet Option See page 650 for Grommet placement N No Grommet G Round Grommet — centered (\$15 upcharge)	2nd Option Select Accessory Port Option See page 650 for Port placement 0 No Port 1 One Corner Port 2 Two Ports — Opposite 2D Two Ports — Adjacent 3 Three Ports (\$10 upcharge per port)	3rd Option Select Veneer or Laminate Top Color See page 649	4th Option Select Leg Option L Standard Leg Leg Options TR Tapered Round Leg TS Tapered Square Leg	5th Option Select Paint Color P6N Textured Satin Chrome P7A Textured Charcoal
	H F T V S 2 4 .	N .	2 D .	H .	T R .	P 6 N
	H F T L S 2 4 .	N .	2 D .	H .	T R .	P 6 N

Description	Model	Ship Weight	Cube	L1 List	L2 Upcharge
 Veneer Tablet Accessory 14" Dia. x 10"H from table top	HFTTAV14 D	6	2.5	\$ 526	N/A
Laminate Tablet Accessory 14" Dia. x 10"H from table top	HFTTAL14	6	2.5	\$ 332	\$ 15

Use with Collaborative Cube and Cylinder tables for additional workspace. Attaches to tables through ports. Multiple port location options are available. Tablet pivots/swivels toward the user.

How to specify	Select Model Number from above	1st Option Select Edge Detail/Color Do not specify edge color on Veneer model HFTTAV14. See page 649.	2nd Option Select Veneer or Laminate Top Color See page 649	3rd Option Select Paint Color P6N Textured Satin Chrome P7A Textured Charcoal
	H F T T A V 1 4 .	G .	H .	P 6 N
	H F T T A L 1 4 .	G H .	H .	P 6 N

Icon Legend on page 10 **D** Discontinued 2/28/2017.

Flock® Collaborative Accessories

GSA SIN 711-11 Except as Noted



► Flock® Floor Lamp model HFAL1 paired with Lamp Shade model HFASH1 to complete the Flock® collaborative space.

► Use the Lamp Accessory model HFALA1 with lamp shade model HFASH1 to add a coordinated lamp to any Cube or Cylinder table.

► Electrical components are ETL listed.

► For a complete line of compatible Flock® collaborative seating solutions, please see pages 541-548 of the seating section.

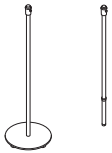

Description

Model

Ship Weight

Cube

List

Flock Floor Lamp

HFAL1

35

0.04

\$ 497

Flock Lamp Accessory for Cube/Cylinder Table

HFALA1

11

0.8

\$ 272

NOTES: Flock® Floor Lamp Accessory fits into the Cube or Cylinder table via a port, to add a lamp option to the table. Accessory port quantity and configuration on tables should correspond to the accessories planned for the table. For grommet and port information, see page 650. Both models use the Lamp Shade model HFASH1 below or accept shades that use the Nord style connector.

How to specify

Select Model Number from above

H | F | A | F | L | 1 | .

1st Option

Select Paint Color

- P6N** Textured Satin Chrome
- P7A** Textured Charcoal

P | 6 | N



Description

Model

Ship Weight

Cube

List

Flock Lamp Shade

HFASH1

4

3.3

\$ 302

- Drum-style (straight sides)
- Fine linen fabric, with matching trim
- Diffusers on top and bottom to provide even lighting

How to specify

Select Model Number from above

H | F | A | S | H | 1 | .

1st Option

Select Color

- WL** White Linen

W | L

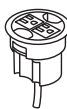

SIN 71-302

Description

Model

Ship Weight

Cube

List

Power Hub, 3" Grommet Mount

HGRMTAC

1.3

0.2

\$ 100

- Fits in 3" round grommet holes
- Field installed with Plug-and-play ease
- Two grounded AC power outlets
- Includes 6' cord with three-prong plug
- Available in Black only. *Specify X when ordering. Example: HGRMTAC.X.*

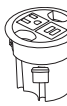

Open Market

Power/USB Hub, 3" Grommet Mount

HGRMTUSB2

1.3

0.2

\$ 198

- One grounded AC power outlet with 2 USB ports.
- UL Listed.

▲ Available in black only (no color designation so use .X – Specify: HGRMTUSB2.X).



Data Grommet

HGRMTDATA

0.2

0.2

\$ 15

Blank grommet kit that includes adapters for a variety of manufacturers jacks and couplers.

- Fits in 3" round grommet holes
- Available in Black only. *Specify P when ordering. Example: HGRMTDATA.P.*

Icon Legend on page 10

Hospitality Table/Base Specifying Information

Laminate Top Size	Base Option Model #
Square Tops	
30"L x 30"W	HBBX22, HBCR22, HXSP-26
36"L x 36"W	HBBX36, HXSP-26, HBCR28
42"L x 42"W	HBBX40, HXSP-36
Round Tops	
30" dia.	HBBX22, HBCR22, HXSP-26
36" dia.	HBBX36, HBCR22, HBCR28BH, HBCR28FR, HXSP-26
42" dia.	HBBX36, HBCR28, HBCR28BH, HBCR28FR, HXSP-36
48" dia.	HBBX40
Rectangular Shaped Tops	
48"L x 24"W	HT-20B
60"L x 24"W	HT-20B
72"L x 24"W	HT-20B
48"L x 30"W	HT-26B
60"L x 30"W	HT-26B
72"L x 30"W	HT-26B
72"L x 36"W	HT-26B

Hospitality Tables — Tops

GSA SIN 711-11

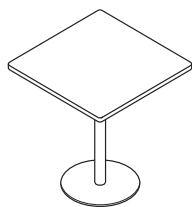

- Choice of edge – T-mold and 2MM.
- Square and rectangle tops with T-mold edge have 1”R corners.
- Square and rectangle tops with 2MM edges have 3”R corners.
- See page 655 for table/base specifying information.
- 1/8” thick laminate top.
- Minimum 45 lbs. industrial grade substrate.
- Tops and bases are ordered separately and shipped in separate cartons.
- See page 655 for top/base compatibility.
- Order bases separately see page 657.



Laminate Top Size	T-Mold Edge	List	2MM Edge	List	Ship Weight	Cube
Square Tops						
30”L x 30”W	H1110 E♦A	\$ 289	H1310 E♦A	\$ 289	36 [S]	4.5
36”L x 36”W	H1111 E♦A	\$ 318	H1311 E♦A	\$ 318	51 [S]	4.5
42”L x 42”W	H1112 E♦A	\$ 386	H1312 E♦A	\$ 386	69	8.0
Round Tops						
30” Dia.	H1120 E♦A	\$ 289	H1320 E♦A	\$ 289	28 [S]	2.3
36” Dia.	H1121 E♦A	\$ 318	H1321 E♦A	\$ 318	40 [S]	2.3
42” Dia.	H1122 E♦A	\$ 386	H1322 E♦A	\$ 386	55	3.1
48” Dia.	H1123 E♦A	\$ 407	H1323 E♦A	\$ 407	71	4.1
Rectangular Shaped Tops						
48”L x 24”W	H1133 E♦A	\$ 309	H1333 E♦A	\$ 309	45 [S]	4.0
60”L x 24”W	H1134 E♦A	\$ 374	H1334 E♦A	\$ 374	57 [S]	5.0
72”L x 24”W	H1135 E♦A	\$ 398	H1335 E♦A	\$ 398	68	6.0
48”L x 30”W	H1143 E♦A	\$ 331	H1343 E♦A	\$ 331	57 [S]	5.0
60”L x 30”W	H1144 E♦A	\$ 381	H1344 E♦A	\$ 381	71	6.3
72”L x 30”W	H1145 E♦A	\$ 474	H1345 E♦A	\$ 474	85	7.5
72”L x 36”W	H1155 E♦A	\$ 525	H1355 E♦A	\$ 525	102	7.5

How to specify	1st Option	2nd Option
Select Model Number from above H 1 1 1 0 .	Select Laminate See page 633 N .	Select Edge Color See page 633 P

ABJ Level Icon Legend on page 10

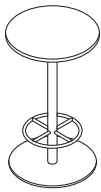

- ▶ Model HBCR28BH is 28" diameter round base, 41"H standing height base.
- ▶ Model HBCR28FR is 28" diameter round base, 41"H standing height base with footing.
- ▶ Template underside of top facilitates base attachment. Bases are attached with self drilling screws, no drilling is required.
- ▶ See pages 655-656 for top options.



Image	Description	Model	Ship		List Core
			Weight	Cube	
	3" Dia. Single Column 22" x 22" base 36" x 36" base 40" x 40" base ▲ Available in Black (P) only. Must be ordered with a configurable end product. If ordered separately, not on GSA Contract.	HBBX22 E♦A HBBX36 E♦A HBBX40 E♦A	21 [S] 36 [S] 60	2.5 3.7 3.2	\$ 151 \$ 242 \$ 420
	3" Dia. Single Column 26" x 26" base 36" x 36" base NOTES: Specify Black (P) or Chrome (CHR). Must be ordered with a configurable end product. If ordered separately, not on GSA Contract.	HXSP-26 E♦A HXSP-36 E♦A	17 [S] 26 [S]	1.2 2.3	\$ 404 \$ 540
	3" Dia. Single Column 22" Dia. round base 28" Dia. round base ▲ Available in Black (P) only. Must be ordered with a configurable end product. If ordered separately, not on GSA Contract.	HBCR22 E♦A HBCR28 E♦A	44 [S] 63 [S]	2.5 2.5	\$ 276 \$ 526
<p>HBCR28BH HBCR28FR</p>	3" Dia. Single Column – Standing Height 28" Dia. round base NOTES: Shipped in two cartons. 41"H standing height base. Accommodates 36" and 42" Dia. round tops. ▲ Available in Black (P) only. Must be ordered with a configurable end product. If ordered separately, not on GSA Contract.	HBCR28BH E♦A HBCR28FR E♦A	(column) 7 [S] (base) 71 [S]	0.3 3.3	\$ 570
	2" Dia. T-base 20"W T-base (2 per carton) NOTES: Specify Black (P) or Chrome (CHR).	HT-20B E♦A	24 [S]	0.5	\$ 440
	2" Dia. T-base 26"W T-base (2 per carton) NOTES: Specify Black (P) or Chrome (CHR).	HT-26B E♦A	26 [S]	0.5	\$ 494

NOTE: See page 655 for base applications.

How to specify	Select Model Number from above H B B X 2 2 . H T - 2 0 B .	1st Option Select Base Color P Black CHR Chrome (Available on HXSP-26, HXSP-36, HT-20B and HT-26B only) P C H R
----------------	--	---

E♦A [S] Icon Legend on page 10

Hospitality Cabinets

Not on GSA Contract



- ▶ Prep Station model is standard with two drawers/doors.
- ▶ Prep Cabinet models are available with one drawer/door or four drawers.
- ▶ Choose from Wall Cabinets with one or two doors.
- ▶ Front Load Receptacle includes a flap for ease in disposal needs.
- ▶ Shipped fully assembled.

△ Cabinets available in Mocha (MOCH) or Natural Maple (D) melamine only.



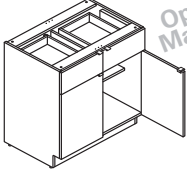
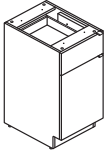
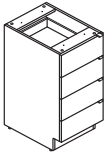
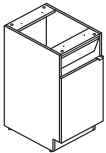
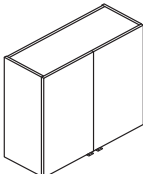
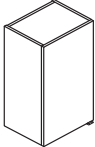





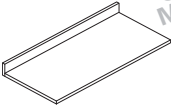

	Description	Model	Ship Weight	Cube	List
	Prep Station with 2 Drawers/2 Doors 36"W x 24"D x 36"H	HPBC2D2D36	180	22.7	\$1361
	Prep Cabinet with 1 Drawer/1 Door 18"W x 24"D x 36"H	HPBC1D1D18	92	12.1	\$ 984
	Prep Cabinet with 4 Drawers 18"W x 24"D x 36"H	HPBC4D18	125	12.1	\$1056
	Front Load Receptacle with Flap 18"W x 24"D x 36"H	HPBC1F1D18	76	12.1	\$ 821
	Hanging Wall Cabinets 2 Doors 36"W x 14"D x 30"H	HPHC2D36	101	12.0	\$ 821
	1 Door 18"W x 14"D x 30"H	HPHC1D18	71	6.4	\$ 657

How to specify	<p>Select Model Number from above</p> <p>H P B C 2 D 2 D 3 6 .</p>	<p>1st Option</p> <p>Select Laminate</p> <p>MOCH Mocha D Natural Maple</p> <p>D </p>
----------------	--	---

Icon Legend on page 10

- ▶ Hospitality Countertops available in four widths: 90"W, 72"W, 54"W and 36"W.
- ▶ Add a sliding shelf unit to any 18"W single cabinet for additional pull-out storage.
- ▶ Shipped fully assembled.

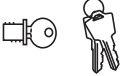

	Description	Model	Ship Weight	Cube	List
 Open Market	Hospitality Countertop with Backsplash				
	90"W x 25"D	HPCT90	92	5.9	\$ 719
	72"W x 25"D	HPCT72	76	4.8	\$ 553
	54"W x 25"D	HPCT54	56 	4.1	\$ 498
	36"W x 25"D	HPCT36	40 	2.5	\$ 332
 Open Market	Sliding Shelf Accessory				
	16 ³ / ₈ "W x 22 ³ / ₁₆ "D	HPBC1S18	21 	1.8	\$ 280
	 For installation into 18"W, single base cabinets, only. Usable width and depth dimensions: 13¹³/₁₆"W x 18⁵/₈"D.				
 Open Market	Optional Field Installable Lock Kit				
		HPLKIT	2 	0.1	\$ 41

desks workstations storage & files seating tables education/learning accessories bundles index

How to specify	<p>Select Model Number from above</p> <p>H P C T 9 0 .</p>	<p>1st Option</p> <p>Select Laminate</p> <p>LOFT Loft WHIT Brilliant White</p> <p>L O F T</p>
----------------	---	--

   Icon Legend on page 10

Huddle Multi-Purpose Tables

Huddle Multi-Purpose Tables are ready to jump into action for training, meetings, collaboration and more. Thoughtful design, flexibility and plenty of base, edge and finish options, make Huddle tables capable of meeting the needs of smart, agile businesses.

Tops – Rectangle

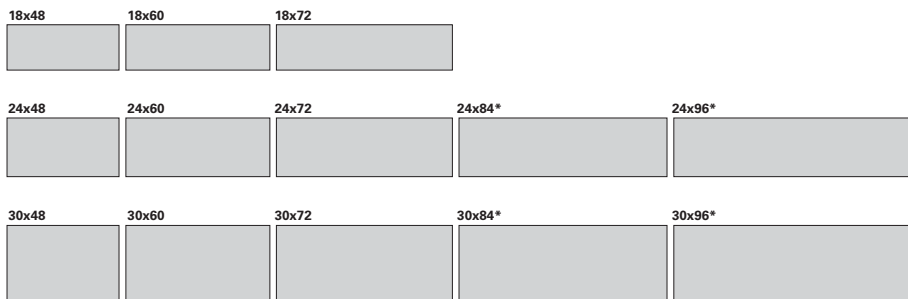

*84" and 96" Tops require flip-top bases and are available in Edgeband only

Edge Options

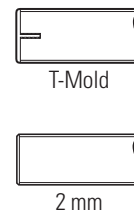

Tops – Half-Round and Extended Half-Round

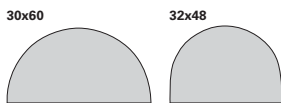

Bases

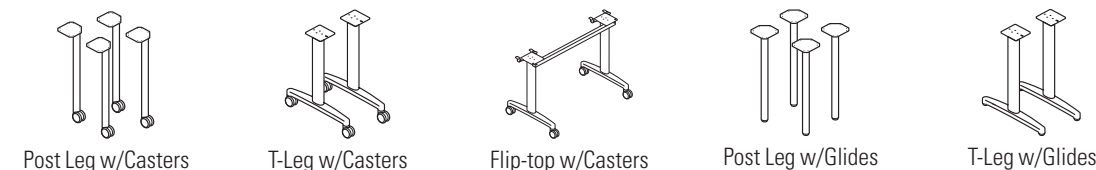

Accessories

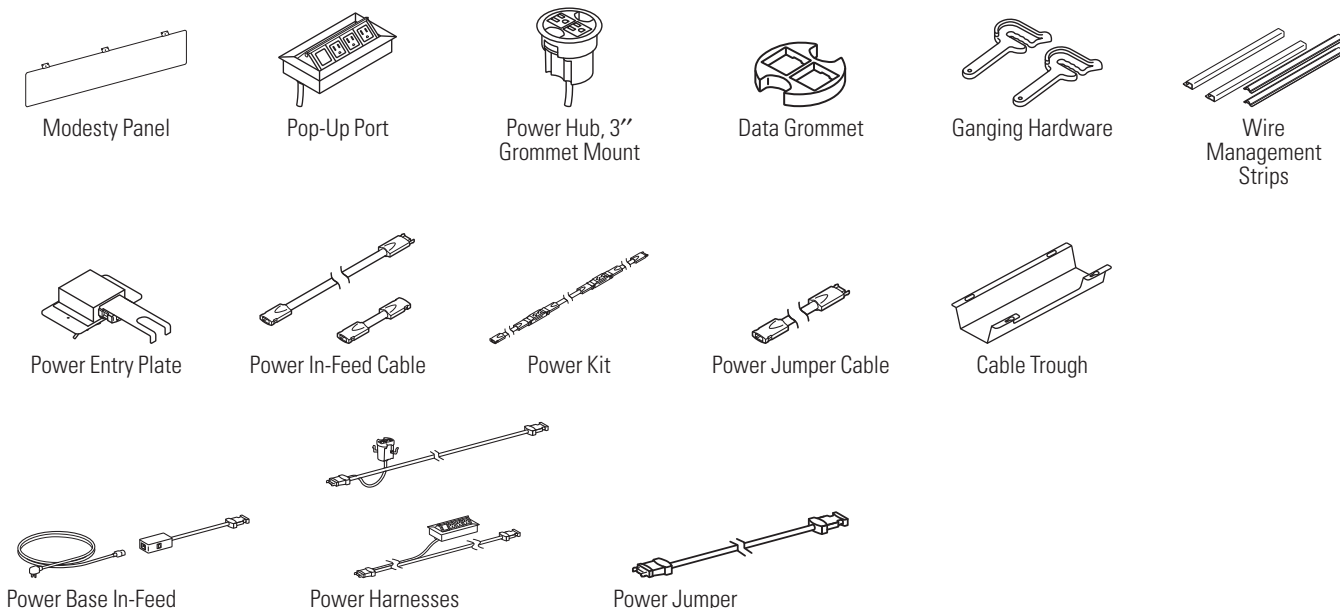

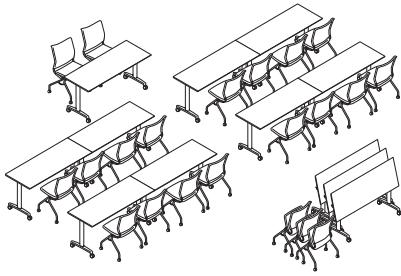

Training

Qty.	Model #	Description	List Price	Price Extension
12	HMT2460G	Rectangular Table Top 60"W x 24"D	\$351	\$ 4,212
12	HMBFLIP24L.C	Flip-top Base	\$566	\$ 6,792
21	HPN1	Perpetual™ Nesting Chair	\$578	\$12,138
TOTAL:			\$23,142	

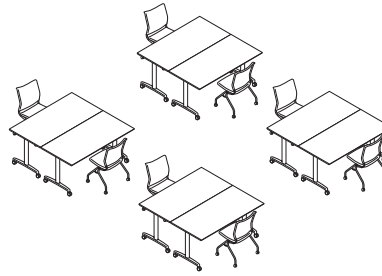

Group Breakout

Qty.	Model #	Description	List Price	Price Extension
8	HMT3060G	Rectangular Table Top 60"W x 30"D	\$362	\$ 2,896
8	HMBTLEG24.C	Fixed Height T-Leg Base with Casters	\$385	\$ 3,080
8	HPN1	Perpetual™ Nesting Chair	\$578	\$ 4,624
TOTAL:			\$10,600	

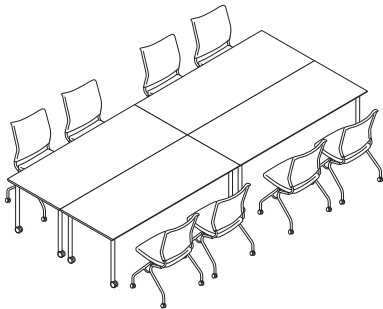

Meeting/Conference

Qty.	Model #	Description	List Price	Price Extension
4	HMT3072G	Rectangular Table Top 72"W x 30"D	\$414	\$1,656
4	HMBPOST	Post Leg Base	\$324	\$1,296
8	HPN1	Perpetual™ Nesting Chair	\$578	\$4,624
TOTAL:			\$7,576	

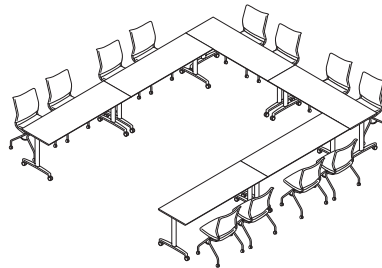

Presentation

Qty.	Model #	Description	List Price	Price Extension
6	HMT2472G	Rectangular Table Top 72"W x 24"D	\$389	\$ 2,334
6	HMBTLEG24.C	Fixed Height T-Leg Base with Casters	\$385	\$ 2,310
12	HPN1	Perpetual™ Nesting Chair	\$578	\$ 6,936
TOTAL:			\$11,580	

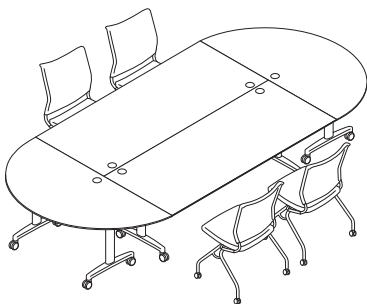

Meeting

Qty.	Model #	Description	List Price	Price Extension
2	HMT3072G	Rectangular Table Top 72"W x 30"D	\$414	\$ 828
2	HMTHR3060G	Half-round Table Top	\$399	\$ 798
2	HMBFLIP30L	Flip-top Base	\$566	\$1,132
2	HMBFLIP24S	Flip-top Base	\$566	\$1,132
4	HPN1	Perpetual™ Nesting Chair	\$578	\$2,312
TOTAL:			\$6,202	

Huddle Multi-Purpose Table Tops

GSA SIN 711-11



- ▶ Table tops are 1 1/8" thick.
- ▶ Tables available in two edge options T-mold or Edgeband.
- ▶ Tops and bases are ordered and sold separately.
- ▶ Underside of tops include pilot holes to accommodate all base types, optional ganging hardware.
- ▶ Optional wire management strips attach to underside of table. See page 665.
- ▶ External stiffener on underside of surfaces 72" and larger deters warping and bowing.
- ▶ When post legs are used with 18"W tops, post leg to be specified with glides only.

△ Grommets available in Black only.
 △ Pop-up Port option (G1). Available in Silver only.

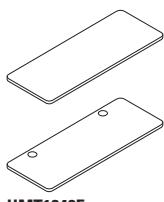
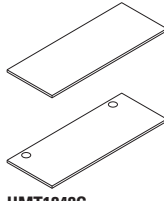

Description	Model	Ship Weight	Cube	List Price by Laminate Grade		
				L1	L2	
 <p>Rectangular T-Mold Table Tops</p> <p>48"W x 18"D 60"W x 18"D 72"W x 18"D</p> <p>48"W x 24"D 60"W x 24"D 72"W x 24"D</p> <p>HMT1848E</p> <p>48"W x 30"D 60"W x 30"D 72"W x 30"D</p>	HMT1848E	34	2.9	\$ 281	\$ 291	
	HMT1860E	42	3.5	\$ 299	\$ 314	
	HMT1872E	51	3.9	\$ 369	\$ 384	
	HMT2448E	45	3.7	\$ 317	\$ 332	
	HMT2460E	57	4.5	\$ 351	\$ 371	
	HMT2472E	68	5.0	\$ 389	\$ 409	
	HMT3048E	57	4.4	\$ 331	\$ 346	
	HMT3060E	71	5.4	\$ 362	\$ 382	
	HMT3072E	85	6.0	\$ 414	\$ 434	
	 <p>Rectangular Edgeband Table Tops</p> <p>48"W x 18"D 60"W x 18"D 72"W x 18"D</p> <p>48"W x 24"D 60"W x 24"D 72"W x 24"D</p> <p>84"W x 24"D, (requires HMBFLIP24XL base) 96"W x 24"D, (requires HMBFLIP24XL base)</p> <p>48"W x 30"D 60"W x 30"D 72"W x 30"D</p> <p>84"W x 30"D, (requires HMBFLIP30XL base) 96"W x 30"D, (requires HMBFLIP30XL base)</p> <p>HMT1848G</p>	HMT1848G	34	2.9	\$ 281	\$ 291
		HMT1860G	42	3.5	\$ 299	\$ 314
		HMT1872G	51	3.9	\$ 369	\$ 384
HMT2448G		45	3.7	\$ 317	\$ 332	
HMT2460G		57	4.5	\$ 351	\$ 371	
HMT2472G		68	5.0	\$ 389	\$ 409	
HMT2484G		83	10.6	\$ 573	\$ 598	
HMT2496G		94	10.6	\$ 600	\$ 625	
HMT3048G		57	4.4	\$ 331	\$ 346	
HMT3060G		71	5.4	\$ 362	\$ 382	
HMT3072G		85	6.0	\$ 414	\$ 434	
HMT3084G		102	10.6	\$ 646	\$ 671	
HMT3096G	114	10.6	\$ 655	\$ 680		

How to specify	1st Option	2nd Option	3rd Option
<p>Select Model Number from above</p> <p>HMT1848G</p>	<p>Select Grommet Option</p> <p>N No Grommet G 2 Grommets (Black only) (\$30 upcharge) G1 Cutout for Pop-up Port (\$40 upcharge). Order port separately.</p> <p>N</p>	<p>Select Laminate</p> <p>See page 633</p> <p>D</p>	<p>Select Edge Color</p> <p>See page 633</p> <p>D</p>

Icon Legend on page 10

▶ Table tops are 1 1/8" thick.
▶ Tables available in two edge options T-mold or Edgeband.



▶ Tops and bases are ordered and sold separately.

▶ Underside of tops include pilot holes to accommodate all base types, optional ganging hardware.

▶ Optional wire management strips attach to underside of table. See page 665.

⚠ **Grommets available in Black only.**
⚠ **Pop-up Port option (G1). Available in Silver only.**

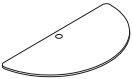

	Description	Model	Ship Weight	Cube	Core List	L2 Upcharge
 HMTHR3060E	Half-Round and Extended Half-Round T-Mold Table Tops 60"W x 30"D, Half-Round Table Tops (use bases: HMBFLIP24S or HMBTLEG24 or HMBPOST) 48"W x 32"D, Extended Half-Round Table Tops (use bases: HMBFLIP24S or HMBTLEG24)	HMTHR3060E HMTHR3248E	69 57	6.1 6.1	\$ 399 \$ 389	\$ 20 \$ 20
 HMTHR3060G	Half-Round and Extended Half-Round Edgeband Table Tops 60"W x 30"D, Half-Round Table Tops (use bases: HMBFLIP24S or HMBTLEG24 or HMBPOST) 48"W x 32"D, Extended Half-Round Table Tops (use bases: HMBFLIP24S or HMBTLEG24)	HMTHR3060G HMTHR3248G	69 57	6.1 6.1	\$ 399 \$ 389	\$ 20 \$ 20

How to specify	1st Option	2nd Option	3rd Option
Select Model Number from above	Select Grommet Option N No Grommet G 1 Grommet (Black only) (\$15 upcharge) G1 Cutout for Pop-up Port (\$40 upcharge). Order port separately.	Select Laminate See page 633	Select Edge Color See page 633
H M T H R 3 2 4 8 G .	N .	D .	D

Huddle Multi-Purpose Table Bases

GSA SIN 711-11



- ▶ Tops and bases are ordered and sold separately.
- ▶ All bases allow tops to sit at 29 1/2" from the floor with glides half-way seated.
- ▶ Both glides and casters attach to the foot easily without tools for assembly.
- ▶ Bases specified with casters include two locking and two non-locking casters.
- ▶ Bases specified with glides have four adjustable glides, which adjust 1".
- ▶ Flip-top base is standard with casters.
- ▶ When post legs are used with 18"W tops, post leg to be specified with glides only.





Description	Model	Ship		
		Weight	Cube	Core
 <p>Fixed Height T-Leg Base (Includes 2 T-legs) For 18"D Table Tops For 24"D and 30"D Table Tops (excluding 84"W and 96"W Rectangular Tops)</p>	HMBTLEG18	12	3.6	\$ 385
	HMBTLEG24	14	3.6	\$ 385
 <p>Flip-top Base (Includes 1 Complete Base) For 18"D x 48"W Rectangular Table Tops For 18"D x 60"W, 72"W Rectangular Table Tops For 24"D x 48"W and 32"D x 48"W Rectangular Tops and 30"D x 60"W Half-Round Table Tops For 24"D x 60"W, 72"W Rectangular Table Tops For 24"D x 84"W, 96"W Rectangular Table Tops For 30"D x 48"W Rectangular Table Tops For 30"D x 60"W, 72"W Rectangular Table Tops For 30"D x 84"W, 96"W Rectangular Table Tops</p>	HMBFLIP18S	23	4.1	\$ 566
	HMBFLIP18L	26	4.1	\$ 566
	HMBFLIP24S	24	4.1	\$ 566
	HMBFLIP24L	27	4.1	\$ 566
	HMBFLIP24XL	31	6.0	\$ 679
	HMBFLIP30S	24	4.1	\$ 566
	HMBFLIP30L	27	4.1	\$ 566
	HMBFLIP30XL	32	6.0	\$ 679
 <p>Post Leg Base (Includes 4 Post Legs) For all Tops (excluding 84"W and 96"W Rectangular tops and 32" x 48" Half-Round Tops)</p>	HMBPOST	18	2.3	\$ 324

Table Top to Base Compatibility Chart:

	Flip-Top	T-Leg	Post Leg
18"D x 48"W	HMBFLIP18S	HMBTLEG18	HMBPOST*
18"D x 60"W	HMBFLIP18L	HMBTLEG18	HMBPOST*
18"D x 72"W	HMBFLIP18L	HMBTLEG18	HMBPOST*
24"D x 48"W	HMBFLIP24S	HMBTLEG24	HMBPOST
32"D x 48"W HR	HMBFLIP24S	HMBTLEG24	N/A
30"D x 60"W HR	HMBFLIP24S	HMBTLEG24	HMBPOST
24"D x 60"W	HMBFLIP24L	HMBTLEG24	HMBPOST
24"D x 72"W	HMBFLIP24L	HMBTLEG24	HMBPOST
24"D x 84"W	HMBFLIP24XL	N/A	N/A
24"D x 96"W	HMBFLIP24XL	N/A	N/A
30"D x 48"W	HMBFLIP30S	HMBTLEG24	HMBPOST
30"D x 60"W	HMBFLIP30L	HMBTLEG24	HMBPOST
30"D x 72"W	HMBFLIP30L	HMBTLEG24	HMBPOST
30"D x 84"W	HMBFLIP30XL	N/A	N/A
30"D x 96"W	HMBFLIP30XL	N/A	N/A

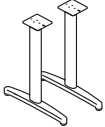

*Post legs should be specified with glides for use on 18"D worksurfaces.

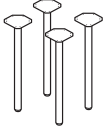
NOTE: Glides/casters are NOT interchangeable on Post Leg and T-base.

How to specify	1st Option	2nd Option
<p>Select Model Number from above</p> <p>H M B T L E G 1 8 .</p>	<p>Select Glide/Caster Option</p> <p>G Glide C Caster</p> <p>Flip-top base is available with casters only When post legs are used with 18"D tops, specify with glides only</p> <p>G .</p>	<p>Select Paint Color</p> <p>See page 633 \$20 upcharge per model, for Metallic paint</p> <p>T 1 </p>

- ▶ Modesty panels are available in three lengths.
- ▶ Modesty panels nest between legs for nesting models.
- ▶ Ganging Hardware must be ordered and installed on tables when using 4-trac electrical systems.
- ▶ Ganging hardware attaches to underside of table in pre-drilled pilot holes.
- ▶ Vertical Wire Management Strips must be trimmed when applied to legs of T-Leg and Flip-Top Bases with casters.
- ▶ Wire management strips fasten to underside of table and route cords from floor to grommet.

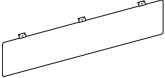

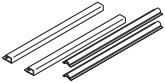
Description	Model	Ship Weight	Cube	List by Paint Grade	
				Core	Choice/Metallics
 <p>Universal Modesty Panel For 48"W Huddle Tables For 60"W & 72"W Huddle Tables For 84"W & 96"W Huddle Tables</p> <p>NOTES: Universal Modesty Panels nest between the table legs which prevents clinging.</p>	HMTUMOD32	9	1.9	\$ 190	\$ 210
	HMTUMOD44	12	2.5	\$ 208	\$ 228
	HMTUMOD56	16	3.4	\$ 226	\$ 246
 <p>Ganging Hardware</p> <ul style="list-style-type: none"> Includes two ganging links and two screws No color designator when specifying. <i>Example: HMAGANG.</i> 	HMAGANG	1	0.1	\$ 81	
 <p>Wire Management Strips Includes: 2 - 24" vertical strips 2 - 24" horizontal strips</p> <ul style="list-style-type: none"> Available in Black only. <i>Specify P when ordering. Example: HBTMS.P.</i> 	HBTMS	3	0.2	\$ 98	

How to specify

<p>Select Model Number from above</p> <p>H M T U M O D 3 2 .</p>	<p>1st Option</p> <p>Select Paint Color</p> <p>See page 633</p> <p>S </p>
--	---

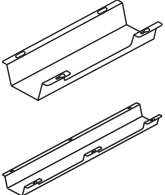
Description	Model	Ship Weight	Cube	List
 <p>Cable Management Troughs 17"W — Single 17"W — 10-Pack 36"W — Single 36"W — 10-Pack</p> <ul style="list-style-type: none"> Metal Cable Management Troughs ship flat Troughs attach to underside of worksurface with screws The 17"W models have one wire access cut out on the user side. The 36" models have two wire access cut outs. These cut outs allow user access inside the trough without having to detach it from the worksurface. Graphite only, no need to specify TAA Compliant Slim profile design 	HCTROUGH17	3	0.5	\$ 60
	HCTROUGH1710	14	0.5	\$ 568
	HCTROUGH36	5	0.9	\$ 101
	HCTROUGH3610	30	0.9	\$ 959

How to specify

<p>Select Model Number from above</p> <p>H C T R O U G H 1 7 </p>
--











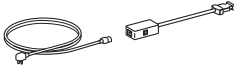

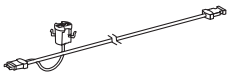

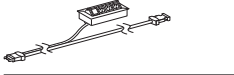

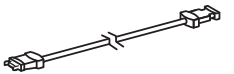
Interlink IQ Electrical

GSA SIN 711-11 Except as Noted

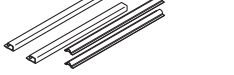

- ▶ Interlink IQ Electrical is a pluggable, single circuit electrical system.
 - ▶ All electrical models include wire management clips and hardware.
 - ▶ Interlink IQ Electrical is non-sequential/non-directional. It can be installed in any direction.
 - ▶ Interlink IQ Electrical is UL Recognized as a Powered Table System and meets the requirements of UL 962.
- △ **40' maximum run, or no more than 8 units. Maximum run is based upon electrical harness width, not table width.**

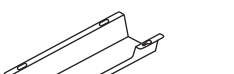

Description	Model	Ship Weight	Cube	List
 Power Base In-Feed	HQB	2.0 	0.2	\$ 457
 Power Harness – 1' Power Hub, 3'' Round Grommet Mount	HQH1-3	2.0 	0.2	\$ 147
 Power Harness – 5' Power Hub, 3'' Round Grommet Mount	HQH5-3	2.0 	0.2	\$ 166
 Power Harness – 5' with 4'' x 8'' Pop-Up Port	HQH5-P	3.0 	0.3	\$ 325
 Power Jumper – 3'	HQJ3	2.0 	0.2	\$ 91
 Ganging Hardware <ul style="list-style-type: none"> • Includes two ganging links and two screws • No color designator when specifying. <i>Example: HMAGANG.</i> 	HMAGANG	1.0 	0.1	\$ 81
 Wire Management Strips <ul style="list-style-type: none"> Includes: 2 - 24'' vertical strips 2 - 24'' horizontal strips • Available in Black only. <i>Specify P when ordering. Example: HBTMS.P.</i> 	HBTMS	3.0 	0.2	\$ 98
 Cable Management Troughs <ul style="list-style-type: none"> 17''W — Single 17''W — 10-Pack 	HCTROUGH17 HCTROUGH1710	2.7  14.0 	0.5 0.5	\$ 60 \$ 568

Open Market

SIN 711-1

Specification guide for IQ Electrical on Huddle tables

Determine table width, the type of power access being used (3'' grommet or 4x8 pop-up) and the desired number per table (Columns 1, 2 or 3). The table will then identify the type and quantity of components needed per table along with the maximum table run. Note that this is in addition to the Power base in-feed which is needed for each run. For example, a 48''W table with two 3'' power grommets per table will require (1) HQH5-3 harness and (1) HQH1-3 harness per table with a maximum run of four tables.

Top Width	POWER ONE (1) PER TABLE 3'' ROUND POWER GROMMET		POWER TWO (2) PER TABLE 3'' ROUND POWER GROMMETS		POWER ONE (1) PER TABLE 4x8 POP-UP PORT	
	Quantity	Table Run Maximum	Quantity	Table Run Maximum	Quantity	Table Run Maximum
36''	(1) HQH5-3	8	N/A	N/A	(1) HQH5-P	8
42''	(1) HQH5-3	8	N/A	N/A	(1) HQH5-P	8
48''	(1) HQH5-3	8	(1) HQH5-3 (1) HQH1-3	4	(1) HQH5-P	8
54''	(1) HQH5-3	8	(1) HQH5-3 (1) HQH1-3	4	(1) HQH5-P	8
60''	(1) HQH5-3	8	(1) HQH5-3 (1) HQH1-3	4	(1) HQH5-P	8
66''	(1) HQH5-3 (1) HQJ3	4	(1) HQH5-3 (1) HQH1-3	4	(1) HQH5-P (1) HQJ3	4
72''	(1) HQH5-3 (1) HQJ3	4	(1) HQH5-3 (1) HQH1-3	4	(1) HQH5-P (1) HQJ3	4
84''	(1) HQH5-3 (1) HQJ3	4	(2) HQH5-3	4	(1) HQH5-P (1) HQJ3	4
96''	(1) HQH5-3 (1) HQJ2	4	(2) HQH5-3	4	(1) HQH5-P (1) HQJ3	4
Half-Round (all sizes)	(1) HQH1-3	2	N/A	N/A	(1) HQH5-P	2
Trapezoid (all sizes)	(1) HQH5-3	8	N/A	N/A	(1) HQH5-P	8

How to specify

Select Model Number from above

H | Q | J | 3

   Icon Legend on page 10

4-Trac Electrical System

The 4-Trac Electrical System is a UL-recognized Manufactured Wiring System that seamlessly passes power from one worksurface to another. This low-profile non-sequential electrical system allows tables to be “daisy-chained” together in any desired order and allows users to reconfigure quickly due to simple connectable/disconnectable links.

- Meets requirements of UL 183 and National Electric Code Article 604
- 4-Wires, 2-circuits, 20 Amps each (Circuit 1 and Circuit 2 only)
- 13 Duplex Receptacles per circuit, 26, 15 Amp Duplex receptacle per power in-feed
- Electrical system attaches directly to underside of worksurface with included brackets
- Up to twelve tables can be linked together

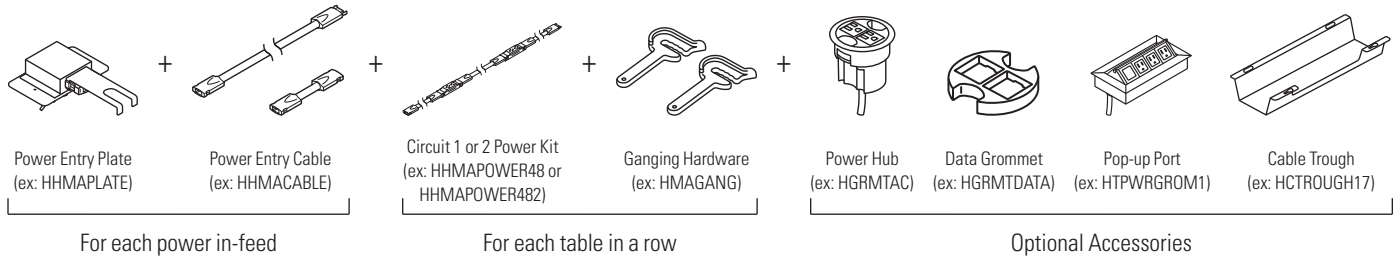

Steps for Electrical Specifications:

1. Determine how many rows of tables are needed and order the following:
 - One HHMAPLATE per row (or power in-feed)
 - One HHMACABLE per row (or power in-feed)
2. Order one power harness per table in each row
 - For 1-6 tables in a row (see illustration 1)
 - Order Circuit 1 Power Harnesses (ex. If powering six 24x60 tables order six sets of HHMAPOWER60)
 - For 7-12 tables in a row (see illustration 1)
 - Order Circuit 1 Power Harness for first six tables and Circuit 2 Power Harness for remaining tables (ex. If powering eight 24x60 tables, order six sets of HHMAPOWER60 and two sets of HHMAPOWER602)
3. Order one set of ganging hardware per table (ex. HMAGANG)
4. Determine which accessories are needed:
 - a. Power Hub model HGRMTAC — to access power at worksurface.
 - b. Data Grommet model HGRMTDATA — to access data at worksurface.
 - c. Wire Management strips model HBTMS — for vertical and horizontal wire management.

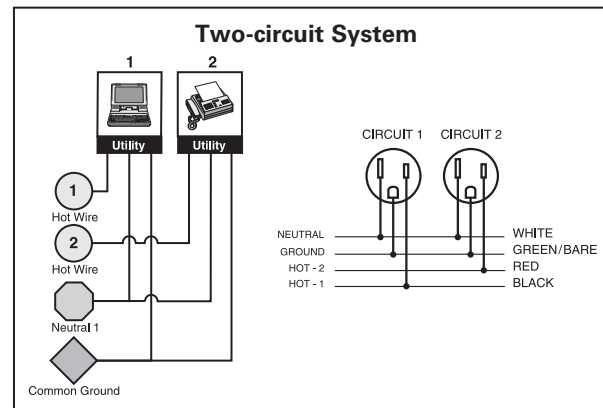
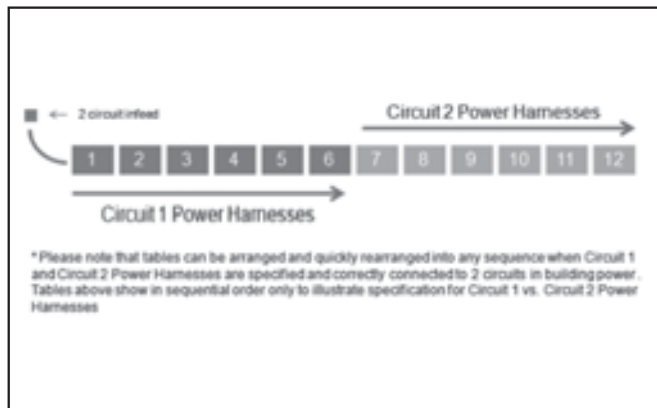











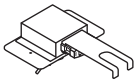
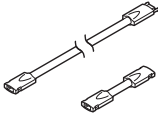

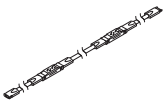
4-Trac Electrical System

GSA SIN 711-11 Except as Noted

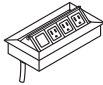
HON

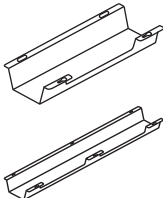
- ▶ Ganging Hardware must be ordered and installed on tables when using 4-trac electrical systems. See page 665 for Ganging Hardware.
- ▶ Each power kit includes two duplex receptacles and attaches to the underside of the worksurface with included brackets.
- ▶ Power kits are compatible with various base types including Flip-Top, T-Leg and Post-Leg.



	Description	Model	Ship		
			Weight	Cube	List
	Power Entry Plate	HMAPLATE	1.0	0.2	\$ 81
	Power Entry Cable <ul style="list-style-type: none"> • 6' power entry cable with male/female adapter • Connects table to power entry plate 	HMACABLE	1.8	0.2	\$ 127
	Power Jumper Cable To connect tables front to front	HMAJUMP	0.5	0.3	\$ 42
	Circuit 1 Power Kit for 48"W Table	HMAPOWER48	1.8	0.3	\$ 239
	Circuit 1 Power Kit for 60"W Table	HMAPOWER60	2.0	0.3	\$ 245
	Circuit 1 Power Kit for 72"W Table	HMAPOWER72	2.2	0.3	\$ 250
	Circuit 1 Power Kit for 84"W Table	HMAPOWER84	2.4	0.3	\$ 260
	Circuit 1 Power Kit for 96"W Table	HMAPOWER96	2.6	0.3	\$ 268
	Circuit 2 Power Kit for 48"W Table	HMAPOWER482	1.8	0.3	\$ 239
	Circuit 2 Power Kit for 60"W Table	HMAPOWER602	2.0	0.3	\$ 245
	Circuit 2 Power Kit for 72"W Table	HMAPOWER722	2.2	0.3	\$ 250
	Circuit 2 Power Kit for 84"W Table	HMAPOWER842	2.4	0.3	\$ 260
	Circuit 2 Power Kit for 96"W Table	HMAPOWER962	2.6	0.3	\$ 268
 SIN 71-302	Power Hub, 3" Grommet Mount <ul style="list-style-type: none"> • Fits in 3" round grommet holes • Field installed with Plug-and-play ease • Two grounded AC power outlets • Includes 6' cord with three-prong plug • Available in Black only. <i>Specify X when ordering. Example: HGRMTAC.X.</i> 	HGRMTAC	1.3	0.2	\$ 100
 Open Market	Power/USB Hub, 3" Grommet Mount <ul style="list-style-type: none"> • One grounded AC power outlet with 2 USB ports. • UL Listed. <p>▲ Available in black only (no color designation so use .X – Specify: HGRMTUSB2.X).</p>	HGRMTUSB2	1.3 	0.2	\$ 198
	Pop-up Port <ul style="list-style-type: none"> • Fits into 4" x 8" cutout. • Specify G1 cutout in table top. • Pop-up Port provides three power ports and one blank data receptacle. • Sits flush with worksurface when closed. • Finish is anodized aluminum. • Includes 6' cord with three-prong plug. 	HTPWRGROM1	5.0	0.3	\$ 343
	Data Grommet Blank grommet kit that includes adapters for a variety of manufacturers jacks and couplers. <ul style="list-style-type: none"> • Fits in 3" round grommet holes • Available in Black only. <i>Specify P when ordering. Example: HGRMTDATA.P.</i> 	HGRMTDATA	0.2	0.2	\$ 15
 SIN 711-1	Cable Management Troughs				
	17"W — Single	HCTROUGH17	2.7 	0.5	\$ 60
	17"W — 10-Pack	HCTROUGH1710	14.0 	0.5	\$ 568
	36"W — Single	HCTROUGH36	4.9 	0.9	\$ 101
	36"W — 10-Pack	HCTROUGH3610	30.0 	0.9	\$ 959
	<ul style="list-style-type: none"> • Cable management troughs ship flat packed. • The troughs attach to underneath the worksurface with screws. • The 17"W has one wire access cut out on the user side. The 36" has two wire access cut outs. These cut outs give users access to inside the trough without having to detach it from the worksurface. • Color: Graphite. • Material: Metal. • TAA Compliant. 				

How to specify

Select Model Number from above

H | M | A | P | L | A | T | E |

Icon Legend on page 10

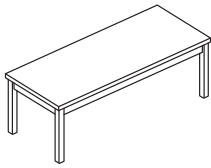

► Durable material and construction make laminate occasional tables ideal for high traffic areas such as lobbies, reception rooms and lounges. Versatile design is also well suited to private offices.

► Coffee, Corner and End Tables feature top-over-apron styling with square corner detail, which complements many interiors and furniture designs, including the 10500 Series.
► Tables accommodate lamps, magazines, telephones, plants, laptops and more.

► Tops are abrasion- and stain-resistant laminate over 1/8" thick solid core high-performance particleboard.

► Cylinder and cube tables have recessed black plinth base with tack glides. Tops and sides are covered with laminate.

Edge Detail



	Description	Model	Ship Weight	Cube	List
	Coffee Table 48"L x 20"W x 16"H	H80191 E♦A	48 [S]	3.4	\$ 431
	Corner Table 24"L x 24"W x 20"H	H80192 E♦A	35 [S]	2.1	\$ 372
	End Table 24"L x 20"W x 20"H	H80193 E♦A	29 [S]	1.8	\$ 355
	Laminate Occasional Tables (H80191, H80192 and H80193) Woodgrain: Bourbon Cherry (HH), Cognac (COGNCOGN), Harvest (CC), Mahogany (NN), Mocha (MOCHMOCH), Natural Maple (DD), Pinnacle (PINCPINC), Shaker Cherry (FF). Solid: Black (PP), Brilliant White (WHITWHIT), Charcoal (SS). Patterned: Canyon Zephyr (K9), Desert Zephyr (K8), Grey Tigris (L6*), Sheer Mesh (A5), Silver Mesh (B9). * Select edge/apron/leg color — Black (P), Bourbon Cherry (H), Brilliant White (WHIT), Charcoal (S), Harvest (C), Mahogany (N), Natural Maple (D), Shaker Cherry (F), Mocha (MOCH), Pinnacle (PINC), Cognac (COGN). Two-Tone: Black/Brilliant White (PWHIT), Black/Charcoal (PS), Bourbon Cherry/Black (HP), Bourbon Cherry/Brilliant White (HWHIT), Bourbon Cherry/Charcoal (HS), Brilliant White/Black (WHITP), Brilliant White/Bourbon Cherry (WHITH), Brilliant White/Charcoal (WHITS), Brilliant White/Harvest (WHITC), Brilliant White/Mahogany (WHITN), Brilliant White/Natural Maple (WHITD), Brilliant White/Shaker Cherry (WHITF), Charcoal/Black (SP), Charcoal/Brilliant White (SWHIT), Cognac/Black (COGNP), Cognac/Brilliant White (COGNWHIT), Cognac/Charcoal (COGNS), Harvest/Black (CP), Harvest/Brilliant White (CWHIT), Harvest/Charcoal (CS), Mahogany/Black (NP), Mahogany/Brilliant White (NWHIT), Mahogany/Charcoal (NS), Mocha/Black (MOCHP), Mocha/Brilliant White (MOCHWHIT), Mocha/Charcoal (MOCHS), Natural Maple/Black (DP), Natural Maple/Brilliant White (DWHIT), Natural Maple/Charcoal (DS), Pinnacle/Black (PINCP), Pinnacle/Brilliant White (PINCWHIT), Pinnacle/Charcoal (PINCS), Shaker Cherry/Black (FP), Shaker Cherry/Brilliant White (FWHIT), Shaker Cherry/Charcoal (FS).				
	Cylinder Table 20" Diameter x 20"H	H80170	40	6.2	\$ 582
	Cube Table 24"L x 24"D x 20"H	H80180	55	8.6	\$ 631
	Laminate Occasional Tables (H80170 and H80180) Solid: Black (P), Charcoal (S). Woodgrain: Bourbon Cherry (H), Cognac (COGN), Harvest (C), Mahogany (N), Mocha (MOCH), Natural Maple (D), Pinnacle (PINC), Shaker Cherry (F).				

How to specify

Select Model Number from above	1st Option
H 8 0 1 9 1 .	Select Laminate
	See above for Select Laminate noted with each model
	N N

 E♦A [S] Icon Legend on page 10

Motivate® Tables Specifying Information

			Table Tops	Table Bases	Presentation Carts	Lectern	Mobile Markerboard, Modesty Panels, Storage Shelves
L1 LAMINATES		CODES					
Woodgrain	Bourbon Cherry	H	•	•	•	•	
	Cognac	COGN	•	•	•	•	
	Harvest	C	•	•	•	•	
	Mahogany	N	•	•	•	•	
	Mocha	MOCH	•	•	•	•	
	Natural Maple	D	•	•	•	•	
	Pinnacle	PINC	•	•	•	•	
	Shaker Cherry	F	•	•	•	•	
Solid	Black	P	•	•	•	•	
	Brilliant White	WHIT	•	•	•	•	
	Loft	LOFT	•	•	•	•	
	Charcoal	S	•	•	•	•	
Patterned	Whitestone	K4	•	•	•	•	
	Sheer Mesh	A5	•	•	•	•	
	Silver Mesh	B9	•	•	•	•	
	Steel Mesh	A9	•	•	•	•	
	Taupe Mesh	A8	•	•	•	•	
	Canyon Zephyr	K9	•	•	•	•	
	Desert Zephyr	K8	•	•	•	•	
	Shadow Zephyr	K1	•	•	•	•	
L2 LAMINATES	Gray	G2	•	•	•	•	
	White	G1	•	•	•	•	
L2 LAMINATES		CODES					
Woodgrain	Lowell Ash <i>NEW! 1/30/2017</i>	LLA1	•	•	•	•	
	Natural Recon <i>NEW! 1/30/2017</i>	LNR1	•	•	•	•	
	Phantom Ecrú <i>NEW! 1/30/2017</i>	LPE1	•	•	•	•	
	Portico Teak <i>NEW! 1/30/2017</i>	LPT1	•	•	•	•	
	Skyline Walnut <i>NEW! 1/30/2017</i>	LSW1	•	•	•	•	
EDGE BAND 2MM		CODES					
Black	P	•	•	•	•		
Bourbon Cherry	H	•	•	•	•		
Brilliant White	WHIT	•	•	•	•		
Charcoal	S	•	•	•	•		
Cognac	COGN	•	•	•	•		
Greige	R	•	•	•	•		
Harvest	C	•	•	•	•		
Light Gray	Q	•	•	•	•		
Loft	LOFT	•	•	•	•		
Lowell Ash <i>NEW! 1/30/2017</i>	DL	•	•	•	•		
Mahogany	N	•	•	•	•		
Mocha	MOCH	•	•	•	•		
Muslin	T	•	•	•	•		
Natural Maple	D	•	•	•	•		
Natural Recon <i>NEW! 1/30/2017</i>	NR	•	•	•	•		
Phantom Ecrú <i>NEW! 1/30/2017</i>	PE	•	•	•	•		
Pinnacle	PINC	•	•	•	•		
Platinum	K	•	•	•	•		
Portico Teak <i>NEW! 1/30/2017</i>	DP	•	•	•	•		
Shadow	SHDW	•	•	•	•		
Shaker Cherry	F	•	•	•	•		
Skyline Walnut <i>NEW! 1/30/2017</i>	SW	•	•	•	•		
ERGO-EDGE		CODES					
Black	P	•	•	•	•		
Platinum	K	•	•	•	•		
PAINTS		CODES					
Core	Black	P	•	•	•	•	
	Charcoal	S	•	•	•	•	
	Greige	T5	•	•	•	•	
	Light Gray	Q	•	•	•	•	
	Muslin	T3	•	•	•	•	
Putty	L	•	•	•	•		
Metallic	Champagne Metallic	T4	•	•	•	•	
	Platinum Metallic	T1	•	•	•	•	
Textured	Black Textured	BLCK	•	•	•	•	
	Platinum Textured	PLAT	•	•	•	•	

Recommended Edgeband Color Selection:

Laminate		Edgeband	
Bourbon Cherry	H	Bourbon Cherry	H
Cognac	COGN	Cognac	COGN
Harvest	C	Harvest	C
Mahogany	N	Mahogany	N
Mocha	MOCH	Mocha	MOCH
Natural Maple	D	Natural Maple	D
Pinnacle	PINC	Pinnacle	PINC
Shaker Cherry	F	Shaker Cherry	F
Black	P	Black	P
Brilliant White	WHIT	Brilliant White	WHIT
Charcoal	S	Charcoal	S
Whitestone	K4	Muslin	T
Sheer Mesh	A5	Muslin	T
Silver Mesh	B9	Loft	LOFT
Steel Mesh	A9	Charcoal	S
Taupe Mesh	A8	Greige	R
Canyon Zephyr	K9	Greige	R
Desert Zephyr	K8	Greige	R
Shadow Zephyr	K1	Loft	LOFT
Gray	G2	Charcoal	S
White	G1	Charcoal	S
Lowell Ash	LLA1	Lowell Ash	DL
Natural Recon	LNR1	Natural Recon	NR
Phantom Ecrú	LPE1	Phantom Ecrú	PE
Portico Teak	LPT1	Portico Teak	DP
Skyline Walnut	LSW1	Skyline Walnut	SW
Loft	LOFT	Loft	LOFT

- ▶ Select from the 2mm (G) or Ergo Edge (R).
- ▶ Specification includes top and base, however, top and base are boxed separately.
- ▶ Ergo edge is a bullnose on user side and 3mm on all other sides.

- ▶ Tops are 1 1/8" thick.
- ▶ Fixed Height base is standard 29 1/2" worksurface height.
- ▶ External stiffener on underside of surfaces 60" and larger deters warping and bowing.

- ▶ Specify tops without a grommet (N) with a 3" Round Grommet (G) or an Electrical Port opening (G1).
- ▶ See grommet matrix on page 676 for grommet location/placement.

- ▶ Specify Multi-surface Casters or Glides. Casters are locking.
- ▶ 36" and 42" Rectangular tops and all Half-Round and Trapezoid tops are standard with one 3" round grommet (\$15 upcharge per top applies).

- ▶ 48"-96" Rectangular tops are standard with two 3" round grommets (\$30 upcharge per top applies).



Edge Treatments



- ▶ HOW TO ORDER
 1) Select desired model numbers.
 2) Select desired top edge treatment.
 3) Replace the (?) after each model number with the suffix representing the chosen top edge treatment.



"G" 2MM Edge

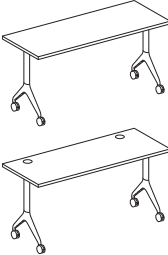

"R" Ergo Edge

Description	Model	Ship Weight	Cube	List Price by Laminate Grade				
				"G" 2MM Edge		"R" Ergo Edge		
				L1	L2	L1	L2	
 <p>Rectangular Tables, Fixed Base</p>	72"W x 18"D	HMVR-1872(?) -FX E◆A	80	6.6	\$ 855	\$ 870	\$1134	\$1149
	60"W x 18"D	HMVR-1860(?) -FX E◆A	70	6.0	\$ 786	\$ 801	\$1028	\$1043
	48"W x 18"D	HMVR-1848(?) -FX E◆A	54	5.3	\$ 778	\$ 788	\$ 996	\$1006
	96"W x 24"D	HMVR-2496(?) -FX E◆A	118	8.8	\$1096	\$1121	N/A	N/A
	84"W x 24"D	HMVR-2484(?) -FX E◆A	109	8.1	\$1051	\$1076	N/A	N/A
	72"W x 24"D	HMVR-2472(?) -FX E◆A	96	7.3	\$ 873	\$ 893	\$1167	\$1187
	66"W x 24"D	HMVR-2466(?) -FX E◆A	90	7.3	\$ 856	\$ 876	N/A	N/A
	60"W x 24"D	HMVR-2460(?) -FX E◆A	83	6.6	\$ 836	\$ 856	\$1101	\$1121
	54"W x 24"D	HMVR-2454(?) -FX E◆A	71	6.6	\$ 820	\$ 840	N/A	N/A
	48"W x 24"D	HMVR-2448(?) -FX E◆A	65	5.8	\$ 802	\$ 817	\$1040	\$1055
	42"W x 24"D	HMVR-2442(?) -FX E◆A	60	5.4	\$ 784	\$ 799	N/A	N/A
	36"W x 24"D	HMVR-2436(?) -FX E◆A	54	5.1	\$ 771	\$ 786	N/A	N/A
	96"W x 30"D	HMVR-3096(?) -FX E◆A	145	10.7	\$1187	\$1212	N/A	N/A
	84"W x 30"D	HMVR-3084(?) -FX E◆A	131	10.7	\$1177	\$1202	N/A	N/A
	72"W x 30"D	HMVR-3072(?) -FX E◆A	115	9.8	\$ 951	\$ 971	\$1264	\$1284
	66"W x 30"D	HMVR-3066(?) -FX E◆A	108	9.8	\$ 925	\$ 945	N/A	N/A
	60"W x 30"D	HMVR-3060(?) -FX E◆A	100	8.9	\$ 902	\$ 922	\$1188	\$1208
	54"W x 30"D	HMVR-3054(?) -FX E◆A	87	8.9	\$ 884	\$ 904	N/A	N/A
	48"W x 30"D	HMVR-3048(?) -FX E◆A	80	7.9	\$ 872	\$ 887	\$1123	\$1138
	42"W x 30"D	HMVR-3042(?) -FX E◆A	73	7.4	\$ 851	\$ 866	N/A	N/A
36"W x 30"D	HMVR-3036(?) -FX E◆A	65	6.9	\$ 833	\$ 848	N/A	N/A	
72"W x 36"D	HMVR-3672(?) -FX E◆A	131	10.8	\$1090	\$1115	N/A	N/A	
60"W x 36"D	HMVR-3660(?) -FX E◆A	114	9.7	\$1011	\$1036	N/A	N/A	
48"W x 36"D	HMVR-3648(?) -FX E◆A	91	9.7	\$ 944	\$ 964	N/A	N/A	
 <p>Half-Round Tables, Fixed Base</p>	72"W x 36"D	HMVH-3672(?) -FX E◆A	103	10.8	\$1136	\$1161	N/A	N/A
	60"W x 30"D	HMVH-3060(?) -FX E◆A	75	7.6	\$ 884	\$ 904	\$1187	\$1207
	48"W x 24"D	HMVH-2448(?) -FX E◆A	56	5.8	\$ 825	\$ 840	\$1082	\$1097
 <p>Trapezoid Tables, Fixed Base</p>	72"W x 36"D	HMVT-3672(?) -FX E◆A	91	10.8	\$1154	\$1179	N/A	N/A
	60"W x 30"D	HMVT-3060(?) -FX E◆A	66	7.6	\$ 892	\$ 917	\$1201	\$1226
	48"W x 24"D	HMVT-2448(?) -FX E◆A	56	5.8	\$ 841	\$ 861	\$1100	\$1120

How to specify

1st Option	2nd Option	3rd Option	4th Option	5th Option
Select Model Number from above	Select Grommet Option	Select Laminate	Select Edge Color	Select Caster/Glide Option
N No Grommet G Grommet (\$15 upcharge PER grommet) G1 Electrical Port (\$40 upcharge)	See page 670	See page 670	C Multi-Surface Caster G Glide	See page 670 \$20 upcharge per model, for metallic paint
H M V R - 1 8 7 2 G - F X .	N .	C .	C .	T .
C .				C .

Motivate® Nesting Tables

GSA SIN 711-11



- ▶ Select from the 2mm (G) or Ergo Edge (R).
- ▶ Ergo edge is a bullnose on user side and 3mm on all other sides. Tops are 1 1/8" thick.
- ▶ External stiffener on underside of surfaces 60" and larger deters warping and bowing.
- ▶ Specification includes top and base, however, top and base are boxed separately.
- ▶ Specify tops without a grommet (N) with a 3" Round Grommet (G) or an Electrical Port Grommet (G1).
- ▶ See grommet matrix on page 676 for grommet location/placement.
- ▶ Specify Multi-surface Casters or Glides. Casters are locking.
- ▶ 36" and 42" Rectangular tops and all Half-Round and Trapezoid tops are standard with one 3" round grommet (\$15 upcharge per top applies).
- ▶ 48"-96" Rectangular tops are standard with two 3" round grommets (\$30 upcharge per top applies).



Edge Treatments







- ▶ HOW TO ORDER
- 1) Select desired model numbers.
 - 2) Select desired top edge treatment.
 - 3) Replace the (?) after each model number with the suffix representing the chosen top edge treatment.



"G" 2MM Edge



"R" Ergo Edge

Description	Model	Ship Weight	Cube	List Price by Laminate Grade				
				"G" 2MM Edge		"R" Ergo Edge		
				L1	L2	L1	L2	
Rectangular Nesting Tables								
 72"W x 18"D	HMVR-1872(?) -NS E⚡	90	8.5	\$1125	\$1140	\$1404	\$1419	
60"W x 18"D	HMVR-1860(?) -NS E⚡	79	7.6	\$1052	\$1067	\$1280	\$1295	
48"W x 18"D	HMVR-1848(?) -NS E⚡	60	6.5	\$1047	\$1057	\$1260	\$1270	
 96"W x 24"D	HMVR-2496(?) -NS E⚡	134	11.4	\$1349	\$1374	N/A	N/A	
84"W x 24"D	HMVR-2484(?) -NS E⚡	122	10.4	\$1321	\$1346	N/A	N/A	
72"W x 24"D	HMVR-2472(?) -NS E⚡	106	9.2	\$1143	\$1163	\$1437	\$1457	
66"W x 24"D	HMVR-2466(?) -NS E⚡	100	9.1	\$1122	\$1142	N/A	N/A	
60"W x 24"D	HMVR-2460(?) -NS E⚡	92	8.2	\$1102	\$1122	\$1367	\$1387	
54"W x 24"D	HMVR-2454(?) -NS E⚡	80	8.2	\$1090	\$1110	N/A	N/A	
48"W x 24"D	HMVR-2448(?) -NS E⚡	73	7.2	\$1066	\$1081	\$1304	\$1319	
42"W x 24"D	HMVR-2442(?) -NS E⚡	67	6.6	\$1050	\$1065	N/A	N/A	
36"W x 24"D	HMVR-2436(?) -NS E⚡	60	6.3	\$1035	\$1050	N/A	N/A	
 96"W x 30"D	HMVR-3096(?) -NS E⚡	161	13.3	\$1475	\$1500	N/A	N/A	
84"W x 30"D	HMVR-3084(?) -NS E⚡	144	13.0	\$1465	\$1490	N/A	N/A	
72"W x 30"D	HMVR-3072(?) -NS E⚡	125	11.7	\$1239	\$1259	\$1552	\$1572	
66"W x 30"D	HMVR-3066(?) -NS E⚡	118	11.6	\$1209	\$1229	N/A	N/A	
60"W x 30"D	HMVR-3060(?) -NS E⚡	109	10.5	\$1186	\$1206	\$1460	\$1480	
54"W x 30"D	HMVR-3054(?) -NS E⚡	96	10.5	\$1172	\$1192	N/A	N/A	
48"W x 30"D	HMVR-3048(?) -NS E⚡	88	9.3	\$1154	\$1169	\$1405	\$1420	
42"W x 30"D	HMVR-3042(?) -NS E⚡	80	8.1	\$1135	\$1150	N/A	N/A	
36"W x 30"D	HMVR-3036(?) -NS E⚡	71	8.1	\$1115	\$1130	N/A	N/A	
 72"W x 36"D	HMVR-3672(?) -NS E⚡	141	12.7	\$1378	\$1403	N/A	N/A	
60"W x 36"D	HMVR-3660(?) -NS E⚡	123	11.3	\$1295	\$1320	N/A	N/A	
48"W x 36"D	HMVR-3648(?) -NS E⚡	99	11.1	\$1226	\$1246	N/A	N/A	
Half-Round Nesting Tables								
 72"W x 36"D	HMVH-3672(?) -NS E⚡	111	12.2	\$1418	\$1443	N/A	N/A	
60"W x 30"D	HMVH-3060(?) -NS E⚡	82	8.8	\$1222	\$1242	\$1525	\$1545	
48"W x 24"D	HMVH-2448(?) -NS E⚡	62	7.0	\$1089	\$1104	\$1346	\$1361	
Trapezoid Nesting Tables								
 72"W x 36"D	HMVT-3672(?) -NS E⚡	98	12.0	\$1438	\$1463	N/A	N/A	
60"W x 30"D	HMVT-3060(?) -NS E⚡	72	8.8	\$1156	\$1181	\$1452	\$1477	
48"W x 24"D	HMVT-2448(?) -NS E⚡	57	7.0	\$1113	\$1133	\$1364	\$1384	

How to specify	1st Option	2nd Option	3rd Option	4th Option	5th Option
Select Model Number from above	Select Grommet Option N No Grommet G Grommet (\$15 upcharge PER grommet) G1 Electrical Port (\$40 upcharge)	Select Laminate See page 670	Select Edge Color See page 670	Select Caster/Glide Option C Multi-Surface Caster G Glide	Select Base Paint Color See page 670 \$20 upcharge per model, for metallic paint
	H M V R - 1 8 7 2 G - N S . N .	C .	C .	C .	T 1

ABJ Icon Legend on page 10

- ▶ Select from the 2mm (G) or Ergo Edge (R).
- ▶ Ergo edge is a bullnose on user side and 3mm on all other sides.
- ▶ Tops are 1/8" thick.

- ▶ Specification includes top and base, however, top and base are boxed separately.
- ▶ Seated height adjustment from 27 1/2"-32 1/2" in 1" increments.
- ▶ External stiffener on underside of surfaces 60" and larger deters warping and bowing.

- ▶ Specify tops without a grommet (N) with a 3" Round Grommet (G) or an Electrical Port opening (G1).
- ▶ See grommet matrix on page 676 for grommet location/placement.
- ▶ Specify Multi-surface Casters or Glides. Casters are locking.

- ▶ 36" and 42" Rectangular tops are standard with one 3" round grommet (\$10 upcharge per top applies).
- ▶ 48"-96" Rectangular tops are standard with two 3" round grommets (\$30 upcharge per top applies).

⚠ **No tool required, adjustable bases have ratchet style adjustment mechanism.**



Edge Treatments



- ▶ **HOW TO ORDER**
- 1) Select desired model numbers.
- 2) Select desired top edge treatment.
- 3) Replace the (?) after each model number with the suffix representing the chosen top edge treatment.



"G" 2MM Edge



"R" Ergo Edge

Description	Model	Ship Weight	Cube	List Price by Laminate Grade			
				"G" 2MM Edge		"R" Ergo Edge	
				L1	L2	L1	L2
 Rectangular Tables, Adjustable Height Base 72"W x 18"D 60"W x 18"D 48"W x 18"D	HMVR-1872(?) -AH E ♦ A	83	6.6	\$1115	\$1130	\$1394	\$1409
	HMVR-1860(?) -AH E ♦ A	73	6.0	\$1046	\$1061	\$1288	\$1303
	HMVR-1848(?) -AH E ♦ A	57	5.3	\$1038	\$1048	\$1256	\$1266
 72"W x 24"D 66"W x 24"D 60"W x 24"D 54"W x 24"D 48"W x 24"D 42"W x 24"D 36"W x 24"D	HMVR-2472(?) -AH E ♦ A	99	7.3	\$1133	\$1153	\$1427	\$1447
	HMVR-2466(?) -AH E ♦ A	93	7.3	\$1116	\$1136	N/A	N/A
	HMVR-2460(?) -AH E ♦ A	86	6.6	\$1096	\$1116	\$1361	\$1381
	HMVR-2454(?) -AH E ♦ A	74	6.6	\$1080	\$1100	N/A	N/A
	HMVR-2448(?) -AH E ♦ A	68	5.8	\$1062	\$1077	\$1300	\$1315
	HMVR-2442(?) -AH E ♦ A	63	5.4	\$1044	\$1059	N/A	N/A
	HMVR-2436(?) -AH E ♦ A	57	5.1	\$1031	\$1046	N/A	N/A
72"W x 30"D 66"W x 30"D 60"W x 30"D 54"W x 30"D 48"W x 30"D 42"W x 30"D 36"W x 30"D	HMVR-3072(?) -AH E ♦ A	118	9.8	\$1230	\$1250	\$1543	\$1563
	HMVR-3066(?) -AH E ♦ A	111	9.8	\$1204	\$1224	N/A	N/A
	HMVR-3060(?) -AH E ♦ A	103	8.9	\$1181	\$1201	\$1467	\$1487
	HMVR-3054(?) -AH E ♦ A	90	8.9	\$1163	\$1183	N/A	N/A
	HMVR-3048(?) -AH E ♦ A	83	7.9	\$1151	\$1166	\$1402	\$1417
	HMVR-3042(?) -AH E ♦ A	76	7.4	\$1130	\$1145	N/A	N/A
72"W x 36"D 60"W x 36"D 48"W x 36"D	HMVR-3672(?) -AH E ♦ A	134	10.8	\$1369	\$1394	N/A	N/A
	HMVR-3660(?) -AH E ♦ A	117	9.7	\$1290	\$1315	N/A	N/A
	HMVR-3648(?) -AH E ♦ A	94	9.7	\$1223	\$1243	N/A	N/A

How to specify	1st Option	2nd Option	3rd Option	4th Option	5th Option
Select Model Number from above	Select Grommet Option	Select Laminate	Select Edge Color	Select Caster/Glide Option	Select Base Paint Color
	N No Grommet G Grommet (\$15 upcharge PER grommet) G1 Electrical Port (\$40 upcharge)	See page 670	See page 670	C Multi-Surface Caster G Glide	See page 670 \$20 upcharge per model, for metallic paint
H M V R - 1 8 7 2 G - A H .	N .	C .	C .	C .	P

Motivate® Folding Tables

GSA SIN 711-11



- ▶ Select from the 2mm (G) or Ergo Edge (R).
- ▶ Ergo edge is a bullnose on user side and 3mm on all other sides.
- ▶ Tops are 1 1/8" thick.
- ▶ Specification includes top and base, however, top and base are boxed separately.
- ▶ Specify tops without a grommet (N) with a 3" Round Grommet (G) or an Electrical Port Grommet (G1).
- ▶ See grommet matrix on page 676 for grommet location/placement.
- ▶ Specify Multi-surface Casters or Glides. Casters are locking.
- ▶ 48"-96" Rectangular tops are standard with two 3" round grommets (\$30 upcharge per top applies).



Edge Treatments

- ▶ HOW TO ORDER
- 1) Select desired model numbers.
 - 2) Select desired top edge treatment.
 - 3) Replace the (?) after each model number with the suffix representing the chosen top edge treatment.



"G" 2MM Edge



"R" Ergo Edge

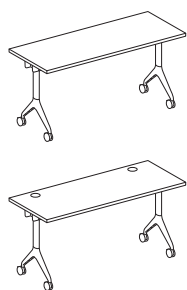

Rectangular Folding Base Tables

Description	Model	Ship Weight	Cube	List Price by Laminate Grade			
				"G" 2MM Edge		"R" Ergo Edge	
				L1	L2	L1	L2
72"W x 18"D	HMVR-1872(?) -FD E♠A	64	6.6	\$1358	\$1373	\$1631	\$1646
60"W x 18"D	HMVR-1860(?) -FD E♠A	58	6.0	\$1283	\$1298	\$1518	\$1533
48"W x 18"D	HMVR-1848(?) -FD E♠A	50	5.3	\$1273	\$1283	\$1500	\$1510
72"W x 24"D	HMVR-2472(?) -FD E♠A	73	7.3	\$1378	\$1398	\$1666	\$1686
60"W x 24"D	HMVR-2460(?) -FD E♠A	65	6.6	\$1338	\$1358	\$1611	\$1631
48"W x 24"D	HMVR-2448(?) -FD E♠A	56	5.8	\$1299	\$1314	\$1546	\$1561
72"W x 30"D	HMVR-3072(?) -FD E♠A	86	9.8	\$1489	\$1509	\$1794	\$1814
60"W x 30"D	HMVR-3060(?) -FD E♠A	76	8.9	\$1434	\$1454	\$1717	\$1737
48"W x 30"D	HMVR-3048(?) -FD E♠A	66	7.9	\$1400	\$1415	\$1646	\$1661

How to specify	1st Option	2nd Option	3rd Option	4th Option	5th Option
<p>Select Model Number from above</p> <p>HMVR-1872G-FD</p>	<p>Select Grommet Option</p> <p>N No Grommet G Grommet (\$15 upcharge PER grommet) G1 Electrical Port (\$40 upcharge)</p> <p>N</p>	<p>Select Laminate</p> <p>See page 670</p> <p>C</p>	<p>Select Edge Color</p> <p>See page 670</p> <p>C</p>	<p>Select Caster/Glide Option</p> <p>C Multi-Surface Caster G Glide</p> <p>C</p>	<p>Select Base Paint Color</p> <p>See page 670 \$20 upcharge per model, for metallic paint</p> <p>T1</p>

ABJ E♠A Icon Legend on page 10

- ▶ Table Modesty Panels are hinged for use with Nesting Table models.
- ▶ Fixed and adjustable height Rectangular tops. Not available for Folding Tables, Trapezoid and Half-Round tops.
- ▶ 2-Sided Mobile Markerboard is porcelain over steel with four locking casters.
- ▶ Mobile Markerboard includes marker tray and flip-chart paper clips.
- ▶ Presentation Carts are available with a Fixed Leg, Adjustable Height, Seated Leg or Adjustable Height, Standing Leg.
- ▶ Presentation Cart tops are 1 1/8" thick with a concave user side. Choose from a 2mm or Ergo edge.
- ▶ Presentation Cart Modesty Panel fits between legs.
- ▶ Metallic paint carries a \$20 upcharge per model.
- ▶ Storage Shelves for Presentation Carts are available in three pre-configured sizes and may be used on fixed or adjustable height models.
- ▶ Desk Top Lectern may be used on the Presentation Cart or is removable for use on table tops.
- ⚠ **Desktop Lectern only available with 2mm edge.**
- ⚠ **Use field installed Table Modesty Panels with all table widths 36"-96". Cannot be used with folding bases or Half-Round or Trapezoid tables.**

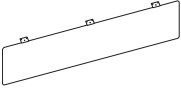

Description	Model	Ship Weight	Cube	List by Paint Grade	
				Core	Choice/Metallics
 <p>Universal Modesty Panel For 96"W Motivate® Tables For 84"W Motivate® Tables For 72"W Motivate® Tables For 66"W Motivate® Tables For 60"W Motivate® Tables For 54"W Motivate® Tables For 48"W Motivate® Tables For 42"W Motivate® Tables For 36"W Motivate® Tables</p>	HMTUMOD86	21	4.8	\$ 252	\$ 272
	HMTUMOD74	20	4.4	\$ 243	\$ 263
	HMTUMOD62	17	3.6	\$ 234	\$ 254
	HMTUMOD56	16	3.4	\$ 226	\$ 246
	HMTUMOD50	14	3.1	\$ 217	\$ 237
	HMTUMOD44	12	2.5	\$ 208	\$ 228
	HMTUMOD38	11	2.2	\$ 198	\$ 218
	HMTUMOD32	9	1.9	\$ 190	\$ 210
	HMTUMOD26	8	1.7	\$ 182	\$ 202

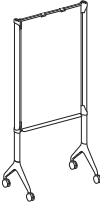
Description	Model	Ship Weight	Cube	List	
				Core	Choice/Metallics
 <p>Mobile Markerboard 36"W x 72"H 30"W x 72"H Actual Markerboard size: HMVMB-3672WW – 36 1/4"W x 42"H HMVMB-3072WW – 30 1/4"W x 42"H Specify Model.Base Paint SPECIFYING EXAMPLE: HMVMB-3072WW.C.P</p>	HMVMB-3672WW	E⚡	59	7.9	\$1330
	HMVMB-3072WW	E⚡	53	7.1	\$1306

 <p>Presentation Cart, Concave Front, Fixed Leg 18"D x 30"W x 35"H, 2mm Edge 18"D x 30"W x 35"H, Ergo Edge ⚠ \$10 list upcharge for L2 laminates. Specify Model.Caster.TopLaminate.EdgeColor.Paint SPECIFYING EXAMPLE: HMVPCF-1830G.C.D.D.T1</p>	HMVPCF-1830G	E⚡	38	3.9	\$ 816
	HMVPCF-1830R	E⚡	38	3.9	\$1106

 <p>Presentation Cart, Concave Front, Seated Height Adjustable-Leg 18"D x 30"W x 27 1/2"-34 1/2"H, 2mm Edge 18"D x 30"W x 27 1/2"-34 1/2"H, Ergo Edge</p>	HMVPCA1-1830G	E⚡	40	3.9	\$1077
	HMVPCA1-1830R	E⚡	40	3.9	\$1380

 <p>Presentation Cart, Concave Front, Standing Height Adjustable-Leg 18"D x 30"W x 31 1/2"-38 1/2"H, 2mm Edge 18"D x 30"W x 31 1/2"-38 1/2"H, Ergo Edge ⚠ \$10 list upcharge for L2 laminates. Specify Model.Caster.TopLaminate.EdgeColor.Paint SPECIFYING EXAMPLE: HMVPCA1-1830G.C.D.D.T1</p>	HMVPCA2-1830G	E⚡	42	3.9	\$1077
	HMVPCA2-1830R	E⚡	42	3.9	\$1380

 <p>Presentation Cart, Modesty Panel Specify Model.Paint SPECIFYING EXAMPLE: HMVPC-MP.P</p>	HMVPC-MP		6	1.4	\$ 164
---	----------	--	---	-----	--------

 <p>Presentation Cart, Storage Shelves Single, 4" Open Back Double, 4" Open Back / 4" Closed Back Double, 4" Open Back / 9" Closed Back Single, 4" Closed Back Double, 4" Closed Back / 4" Closed Back Double, 4" Closed Back / 9" Closed Back Specify Model.Paint SPECIFYING EXAMPLE: HMVPCSS-40.T1</p>	HMVPCSS-40		8	1.4	\$ 83
	HMVPCSS-404C		17	2.6	\$ 171
	HMVPCSS-409C		20	3.6	\$ 269
	HMVPCSS-4C		9	1.4	\$ 90
	HMVPCSS-4C4C		18	2.6	\$ 179
	HMVPCSS-4C9C		21	3.6	\$ 277

 <p>Open Market Presentation Cart Desk Top Lectern, 2mm Edge Specify Model.LaminateTop.EdgeColor.Paint SPECIFYING EXAMPLE: HMVPC-DTLG.D.D.T1</p>	HMVPC-DTLG		16	2.4	\$ 310
	⚠ \$15 list upcharge for L2 laminates.				

How to specify	1st Option
Select Model Number from above	Select Paint Color
H M T U M O D 8 6 .	See page 670
T 1	\$20 upcharge per model, for metallic paint

ABI Icon Legend on page 10

Interlink IQ Electrical

GSA SIN 711-11 Except as Noted



▶ Interlink IQ Electrical is a pluggable, single circuit electrical system.











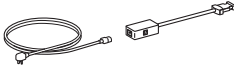

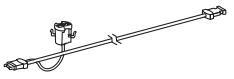

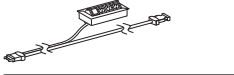

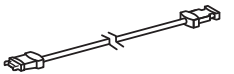
▶ All electrical models include wire management clips and hardware.

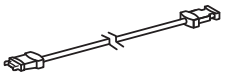
▶ Interlink IQ Electrical is non-sequential/non-directional.

▶ Interlink IQ Electrical is UL Recognized as a Powered Table System and meets the requirements of UL 962 when paired with Motivate® or Huddle tables.

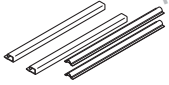
⚠ **40' maximum run, or no more than 8 units. Maximum run is based upon electrical harness width, not table width.**

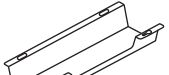

Description	Model	Ship Weight	Cube	List
 Power Base In-Feed • 12 amp circuit breaker is built in to the Power Base In-Feed	HQB	2.0 	0.2	\$ 457
 Power Harness – 1' Power Hub, 3'' Round Grommet Mount	HQH1-3	2.0 	0.2	\$ 147
 Power Harness – 5' Power Hub, 3'' Round Grommet Mount	HQH5-3	2.0 	0.2	\$ 166
 Power Harness – 5' with 4'' x 8'' Pop-Up Port	HQH5-P	3.0 	0.3	\$ 325
 Power Jumper – 3'	HQJ3	2.0 	0.2	\$ 91
 Ganging Hardware • Includes two ganging links and two screws • No color designator when specifying. <i>Example: HMAGANG.</i>	HMAGANG	1.0 	0.1	\$ 81
 Wire Management Strips Includes: 2 - 24'' vertical strips 2 - 24'' horizontal strips • Available in Black only. <i>Specify P when ordering. Example: HBTMS.P.</i>	HBTMS	3.0 	0.2	\$ 98
 Cable Management Troughs 17''W — Single 17''W — 10-Pack	HCTROUGH17 HCTROUGH1710	2.7  14.0 	0.5 0.5	\$ 60 \$ 568

SIN 711-1

Specification guide for IQ Electrical on Motivate® tables

Determine table width, the type of power access being used (3'' grommet or 4x8 pop-up) and the desired number per table (Columns 1, 2 or 3). The table will then identify the type and quantity of components needed per table along with the maximum table run. Note that this is in addition to the Power base in-feed which is needed for each run. For example, a 48''W table with two 3'' power grommets per table will require (1) HQH5-3 harness and (1) HQH1-3 harness per table with a maximum run of four tables.

Top Width	POWER ONE (1) PER TABLE 3'' ROUND POWER GROMMET		POWER TWO (2) PER TABLE 3'' ROUND POWER GROMMETS		POWER ONE (1) PER TABLE 4x8 POP-UP PORT	
	Quantity	Table Run Maximum	Quantity	Table Run Maximum	Quantity	Table Run Maximum
36''	(1) HQH5-3	8	N/A	N/A	(1) HQH5-P	8
42''	(1) HQH5-3	8	N/A	N/A	(1) HQH5-P	8
48''	(1) HQH5-3	8	(1) HQH5-3 (1) HQH1-3	4	(1) HQH5-P	8
54''	(1) HQH5-3	8	(1) HQH5-3 (1) HQH1-3	4	(1) HQH5-P	8
60''	(1) HQH5-3	8	(1) HQH5-3 (1) HQH1-3	4	(1) HQH5-P	8
66''	(1) HQH5-3 (1) HQJ3	4	(1) HQH5-3 (1) HQH1-3	4	(1) HQH5-P (1) HQJ3	4
72''	(1) HQH5-3 (1) HQJ3	4	(1) HQH5-3 (1) HQH1-3	4	(1) HQH5-P (1) HQJ3	4
84''	(1) HQH5-3 (1) HQJ3	4	(2) HQH5-3	4	(1) HQH5-P (1) HQJ3	4
96''	(1) HQH5-3 (1) HQJ2	4	(2) HQH5-3	4	(1) HQH5-P (1) HQJ3	4
Half-Round (all sizes)	(1) HQH1-3	2	N/A	N/A	(1) HQH5-P	2
Trapezoid (all sizes)	(1) HQH5-3	8	N/A	N/A	(1) HQH5-P	8

How to specify

Select Model Number from above

H | Q | J | 3



Icon Legend on page 10

4-Trac Electrical System

The 4-Trac Electrical System is a UL-recognized Manufactured Wiring System that seamlessly passes power from one worksurface to another. This low-profile non-sequential electrical system allows tables to be “daisy-chained” together in any desired order and allows users to reconfigure quickly due to simple connectable/disconnectable links.

- Meets requirements of UL 183 and National Electric Code Article 604
- 4-Wires, 2-circuits, 20 Amps each (Circuit 1 and Circuit 2 only)
- 13 Duplex Receptacles per circuit, 26, 15 Amp Duplex receptacle per power in-feed
- Electrical system attaches directly to underside of worksurface with included brackets
- Up to twelve tables can be linked together

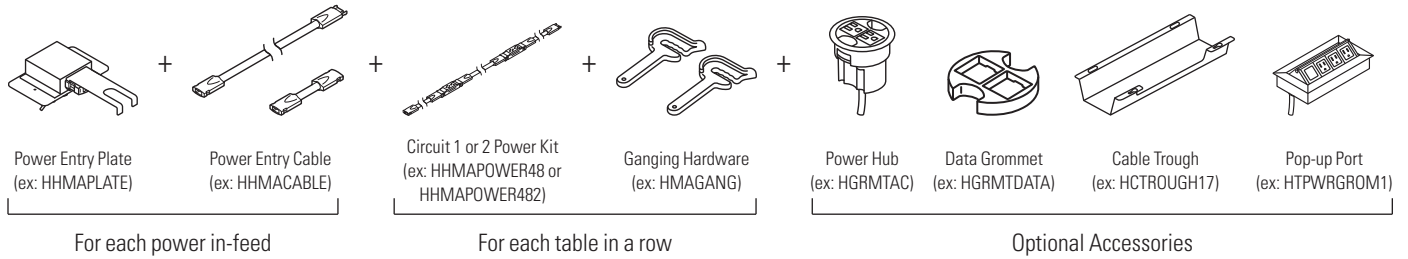

Steps for Electrical Specifications:

1. Determine how many rows of tables are needed and order the following:
 - One HHMAPLATE per row (or power in-feed)
 - One HHMACABLE per row (or power in-feed)
2. Order one power harness per table in each row
 - For 1-6 tables in a row (see illustration 1)
 - Order Circuit 1 Power Harnesses (ex. If powering six 24x60 tables order six sets of HHMAPOWER60)
 - For 7-12 tables in a row (see illustration 1)
 - Order Circuit 1 Power Harness for first six tables and Circuit 2 Power Harness for remaining tables (ex. If powering eight 24x60 tables, order six sets of HHMAPOWER60 and two sets of HHMAPOWER602)
3. Order one set of ganging hardware per table (ex. HMAGANG)
4. Determine which accessories are needed:
 - a. Power Hub model HGRMTAC — to access power at worksurface.
 - b. Data Grommet model HGRMTDATA — to access data at worksurface.
 - c. Wire Management strips model HBTMS — for vertical and horizontal wire management.

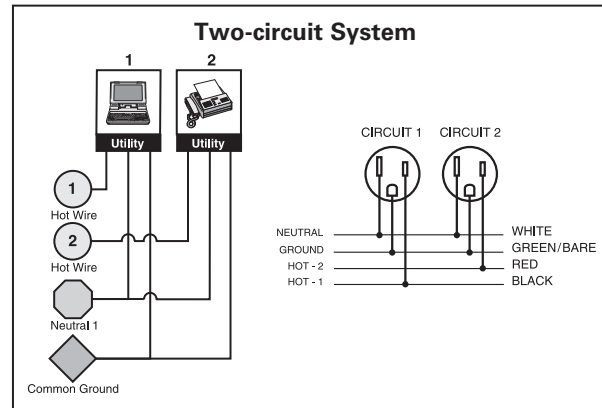
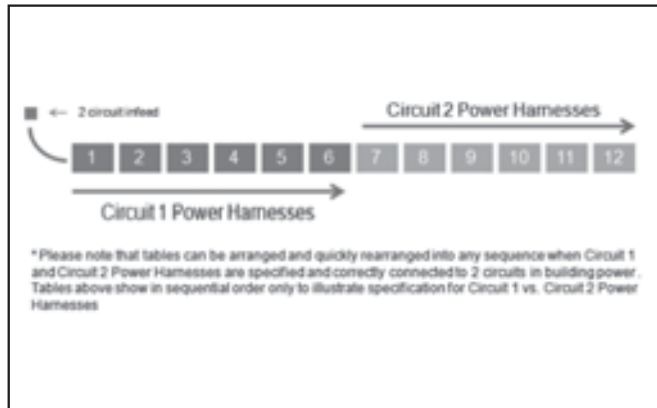





4-Trac Electrical System

GSA SIN 711-11 Except as Noted

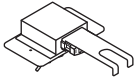
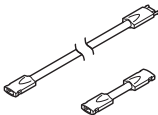
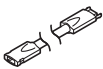

- ▶ Each power kit includes two duplex receptacles and attaches to the underside of the worksurface with included brackets.
- ▶ Power kits are compatible with various base types including Flip-Top and T-Leg.



	Description	Model	Ship Weight	Cube	List
	Power Entry Plate	HMAPLATE	1.0	0.2	\$ 81
	Power Entry Cable <ul style="list-style-type: none"> • 6' power entry cable with male/female adapter • Connects table to power entry plate 	HMACABLE	1.8	0.2	\$ 127
	Power Jumper Cable To connect tables front to front	HMAJUMP	0.5	0.3	\$ 42
	Circuit 1 Power Kit for 36"W Table	HMAPOWER36	1.5	0.3	\$ 234
	Circuit 1 Power Kit for 42"W Table	HMAPOWER42	1.8	0.3	\$ 237
	Circuit 1 Power Kit for 48"W Table	HMAPOWER48	1.8	0.3	\$ 239
	Circuit 1 Power Kit for 54"W Table	HMAPOWER54	2.0	0.3	\$ 243
	Circuit 1 Power Kit for 60"W Table	HMAPOWER60	2.0	0.3	\$ 245
	Circuit 1 Power Kit for 66"W Table	HMAPOWER66	2.2	0.3	\$ 248
	Circuit 1 Power Kit for 72"W Table	HMAPOWER72	2.2	0.3	\$ 250
	Circuit 1 Power Kit for 84"W Table	HMAPOWER84	2.4	0.3	\$ 260
	Circuit 1 Power Kit for 96"W Table	HMAPOWER96	2.6	0.3	\$ 268
	Circuit 2 Power Kit for 36"W Table	HMAPOWER362	1.5	0.3	\$ 234
	Circuit 2 Power Kit for 42"W Table	HMAPOWER422	1.8	0.3	\$ 237
	Circuit 2 Power Kit for 48"W Table	HMAPOWER482	1.8	0.3	\$ 239
	Circuit 2 Power Kit for 54"W Table	HMAPOWER542	2.0	0.3	\$ 243
	Circuit 2 Power Kit for 60"W Table	HMAPOWER602	2.0	0.3	\$ 245
Circuit 2 Power Kit for 66"W Table	HMAPOWER662	2.2	0.3	\$ 248	
Circuit 2 Power Kit for 72"W Table	HMAPOWER722	2.2	0.3	\$ 250	
Circuit 2 Power Kit for 84"W Table	HMAPOWER842	2.4	0.3	\$ 260	
Circuit 2 Power Kit for 96"W Table	HMAPOWER962	2.6	0.3	\$ 268	
	Power Hub, 3" Grommet Mount <ul style="list-style-type: none"> • Fits in 3" round grommet holes • Field installed with Plug-and-play ease • Two grounded AC power outlets • Includes 6' cord with three-prong plug • Available in Black only. <i>Specify X when ordering. Example: HGRMTAC.X.</i> 	HGRMTAC	1.3	0.2	\$ 100
	3" Round Power Grommet – 2 Outlets, 10' Cord <ul style="list-style-type: none"> • Includes 10' cord with three-prong plug. • Fits in 3" round grommet holes on the following product lines: Coordinate, Huddle, Motivate, all laminate and veneer casegoods series, and Systems Worksurfaces. • Two grounded AC power outlets. • Field installed with Plug-and-play ease. 	HGRMTAC2 EDA	1.5	0.2	\$ 126
NOTES: Power Modules will also work with standing-height applications for 10500 Series™ and Voi® desks. ▲ Available in black finish only, no specification needed.					
	Data Grommet Blank grommet kit that includes adapters for a variety of manufacturers jacks and couplers. <ul style="list-style-type: none"> • Fits in 3" round grommet holes • Available in Black only. <i>Specify P when ordering. Example: HGRMTDATA.P.</i> 	HGRMTDATA	0.2	0.2	\$ 15

How to specify

Select Model Number from above

H | M | A | P | L | A | T | E |

AB Level Icon Legend on page 10



Description

- Pop-up Port**
- Fits into 4" x 8" cutout.
 - Pop-up Port provides three power ports and one blank data receptacle.
 - Sits flush with worksurface when closed.
 - Finish is anodized aluminum.
 - Includes 6' cord with three-prong plug.

Model	Ship		List
	Weight	Cube	
HTPWRGROM1	5.0	0.3	\$ 343

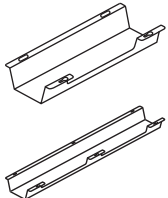

Cable Management Troughs

- 17"W — Single
- 17"W — 10-Pack
- 36"W — Single
- 36"W — 10-Pack

HCTROUGH17	2.7	0.5	\$ 60
HCTROUGH1710	14.0	0.5	\$ 568
HCTROUGH36	4.9	0.9	\$ 101
HCTROUGH3610	30.0	0.9	\$ 959

- Cable management troughs ship flat packed.
- The troughs attach to underneath the worksurface with screws.
- The 17"W has one wire access cut out on the user side. The 36" has two wire access cut outs. These cut outs give users access to inside the trough without having to detach it from the worksurface.
- Color: Graphite.
- Material: Metal.
- TAA Compliant.

SIN 711-1

How to specify

Select Model Number from above

H | T | P | W | R | G | R | O | M | 1

Icon Legend on page 10

			Table Tops*	Collaborative Table Tops	Table Bases** and Modesty	Collaborative Table Bases	Aluminum Bases	Table Base Endcap/Inlay	Credenza Top	Credenza Chassis Lectern Presentation Cabinet	Modular Credenza Chassis	Hospitality Shelf	End, Modesty, and Back Panels
L1 LAMINATES		CODES											
Woodgrain	Bourbon Cherry	H	•	•	•	•		•	•	•	•		•
	Cognac	COGN	•	•	•	•		•	•	•	•		•
	Harvest	C	•	•	•	•		•	•	•	•		•
	Mahogany	N	•	•	•	•		•	•	•	•		•
	Mocha	MOCH	•	•	•	•		•	•	•	•		•
	Natural Maple	D	•	•	•	•		•	•	•	•		•
	Pinnacle	PINC	•	•	•	•		•	•	•	•		•
	Shaker Cherry	F	•	•	•	•		•	•	•	•		•
Solid	Black	P	•	•	•	•			•	•	•		•
	Brilliant White	WHIT	•	•	•	•			•	•	•		•
	Charcoal	S	•	•	•	•			•	•	•		•
	Loft	LOFT	•	•	•	•			•	•	•		•
	Whitestone	K4	•	•					•				
Patterned	Sheer Mesh	A5	•	•					•				
	Silver Mesh	B9	•	•					•				
	Steel Mesh	A9	•	•					•				
	Taupe Mesh	A8	•	•					•				
	Canyon Zephyr	K9	•	•					•				
	Desert Zephyr	K8	•	•					•				
	Shadow Zephyr	K1	•	•					•				
	Gray	G2	•	•					•				
	Grey Tigris	L6	•	•					•				
	White	G1	•	•					•				
	L2 LAMINATES		CODES										
Woodgrain	Lowell Ash <i>NEW! 1/30/2017</i>	LLA1	•	•	•	•			•	•	•		•
	Natural Recon <i>NEW! 1/30/2017</i>	LNR1	•	•	•	•			•	•	•		•
	Phantom Ecru <i>NEW! 1/30/2017</i>	LPE1	•	•	•	•			•	•	•		•
	Portico Teak <i>NEW! 1/30/2017</i>	LPT1	•	•	•	•			•	•	•		•
	Skyline Walnut <i>NEW! 1/30/2017</i>	LSW1	•	•	•	•			•	•	•		•
VENEERS		CODES											
	Bourbon Cherry	H	•		•			•	•	•			•
	Cognac	COGN	•		•			•	•	•			•
	Harvest	C	•		•			•	•	•			•
	Mahogany	N	•		•			•	•	•			•
	Mocha	MOCH	•		•			•	•	•			•
	Natural Maple	D	•		•			•	•	•			•
	Pinnacle	PINC	•		•			•	•	•			•
	Shaker Cherry	F	•		•			•	•	•			•
PAINTS		CODES											
Core	Black	P					•	•					
	Charcoal	S					•	•					
	Light Gray	Q						•					
	Shadow	SHDW						•					
Metallic	Brilliant White	WHIT					•	•					
	Champagne Metallic	T4					•	•					
	Platinum Metallic	T1					•	•					

For edgeband options, see page 681.

* Tops with traditional edge available in Mahogany only.

** Traditional style bases available in Mahogany only.

LAMINATE EDGEBAND OPTIONS	CODES	2mm (G)	Drop (H)	Knife (J)	Tri-Oval (V)	Beaded (B)	Ribbon (K)	T-Mold (E)	Traditional (T)
Bourbon Cherry	H	•	•	•	•	•	•		
Cognac	COGN	•	•	•	•	•	•		
Harvest	C	•	•	•	•	•	•		
Mahogany	N	•	•	•	•	•	•		•
Mocha	MOCH	•	•	•	•	•	•		
Natural Maple	D	•	•	•	•	•	•		
Shaker Cherry	F	•	•	•	•	•	•		
Black	P	•	•	•				•	
Brilliant White	WHIT	•	•	•			•	•	
Charcoal	S	•	•	•				•	
Greige	R	•	•	•				•	
Loft	LOFT	•	•	•				•	
Muslin	T	•	•	•				•	
Pinnacle	PINC	•	•	•	•	•	•		
Platinum	K	•	•	•				•	
Lowell Ash <i>NEW! 1/30/2017</i>	DL	•		•					
Natural Recon <i>NEW! 1/30/2017</i>	NR	•		•					
Phantom Ecu <i>NEW! 1/30/2017</i>	PE	•		•					
Portico Teak <i>NEW! 1/30/2017</i>	DP	•		•					
Skyline Walnut <i>NEW! 1/30/2017</i>	SW	•		•					

Recommended Edgeband Color Selection:

Laminate	Edge	Laminate	Edge
Bourbon Cherry	H	Bourbon Cherry	H
Cognac	COGN	Cognac	COGN
Harvest	C	Harvest	C
Mahogany	N	Mahogany	N
Mocha	MOCH	Mocha	MOCH
Natural Maple	D	Natural Maple	D
Pinnacle	PINC	Pinnacle	PINC
Shaker Cherry	F	Shaker Cherry	F
Black	P	Black	P
Brilliant White	WHIT	Brilliant White	WHIT
Charcoal	S	Charcoal	S
Loft	LOFT	Loft	LOFT
Whitestone	K4	Muslin	T
Sheer Mesh	A5	Muslin	T
Silver Mesh	B9	Loft	LOFT
Steel Mesh	A9	Charcoal	S
Taupe Mesh	A8	Greige	R
Canyon Zephyr	K9	Greige	R
Desert Zephyr	K8	Greige	R
Shadow Zephyr	K1	Loft	LOFT
Gray	G2	Charcoal	S
Grey Tigris	L6	Greige	R
White	G1	Charcoal	S
Lowell Ash	LLA1	Lowell Ash	DL
Natural Recon	LNR1	Natural Recon	NR
Phantom Ecu	LPE1	Phantom Ecu	PE
Portico Teak	LPT1	Portico Teak	DP
Skyline Walnut	LSW1	Skyline Walnut	SW

Statement of Line

TOP SHAPES

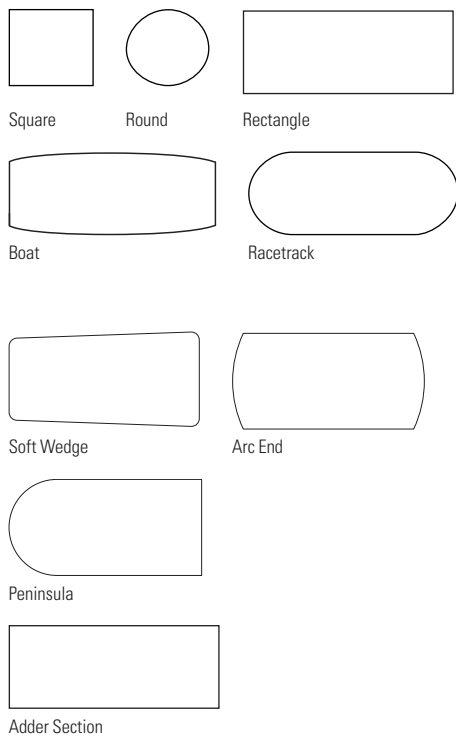

TOP EDGE PROFILES

For Laminate Tops

Square/2mm Edgeband (1 1/8")
10500, Voi®, Abound®



Thick Top (1 1/2")
10500, Voi®, Abound®



Knife Edge (1 1/8")



Tri-Oval Edge (1 1/8")
Concinnity™
Laminate Desks®



Beaded Edge (1 1/8")
Concinnity™

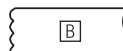

Traditional Edge (1 1/8")
94000



Ribbon Edge (1 1/2")
Valido®



T-Mold Edge (1 1/8")
Abound®, Mentor®,
SmartLink®



For Veneer Tops

Square/Flat (1 1/8")



Drop Edge (1 1/2")



Knife Edge (1 1/8")



Tri-Oval Edge (1 1/2")



Traditional (1 1/8")
Pennsylvania Avenue® Desks

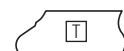

Cove Edge



BASES

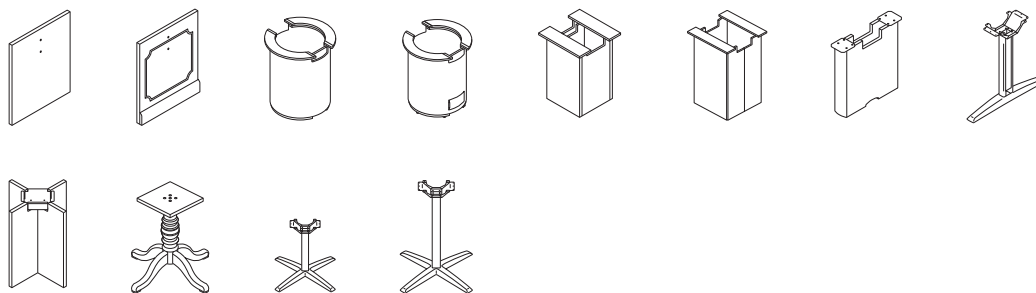



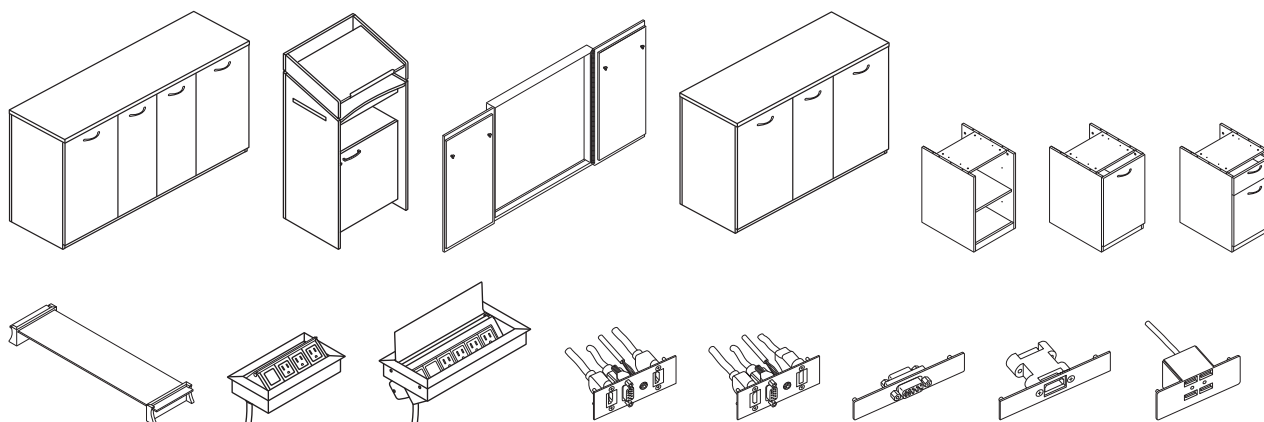







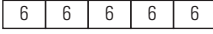
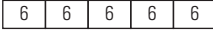

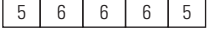
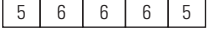

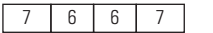
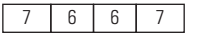
ANCILLARY COMPONENTS

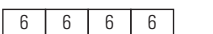
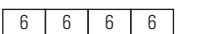
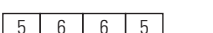
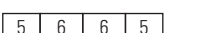
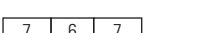
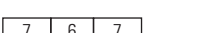
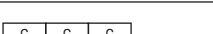
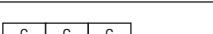
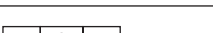
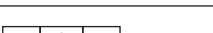
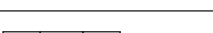
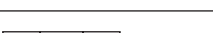









Preside conference tops come in single piece or multi-piece sections depending on specified size. See below for top sizes, sections, and suggested seating capacity.

Product Reference: Sizes, Sections, Seating Capacity









Multi-piece tops: Rectangle, Racetrack, Boat and Arc End Tops

	Feet	Inches	30"D	36"D	48"D	54"D	Suggested Capacity
	30	360"					28-30
	28	336"					26-28
	26	312"					24-26
	24	288"					22-24
	22	264"					20-22
	20	240"					18-20
	18	216"					16-18
	16	192"					14-16
	15	180"					14-16
	14	168"					12-14
	12	144"					10-12
	10	120"					8-10
	9	108"					8-10

Single-piece tops: Rectangle, Racetrack, Boat, Soft Wedge, Arc End and Peninsula Tops

	Feet	Inches	30"D	36"D	42"D	48"D	Suggested Capacity
	8	96"					6-8
	7	84"					4-6
	6	72"					4-6
	5	60"					4-6

Single-piece tops: Round and Square

		36"	42"	48"	Suggested Capacity
	Round				2-4
	Square				2-4

Notes: Single- and two-piece tops ship in one carton, three-piece tops ship in two cartons. Three-piece tops and larger will not contain grain match for all pieces.

Preside Base Compatibility

Bases compatible with 48"D and 54"D Rectangle, Boat, Racetrack, Soft Wedge, Arc End and Peninsula Tops

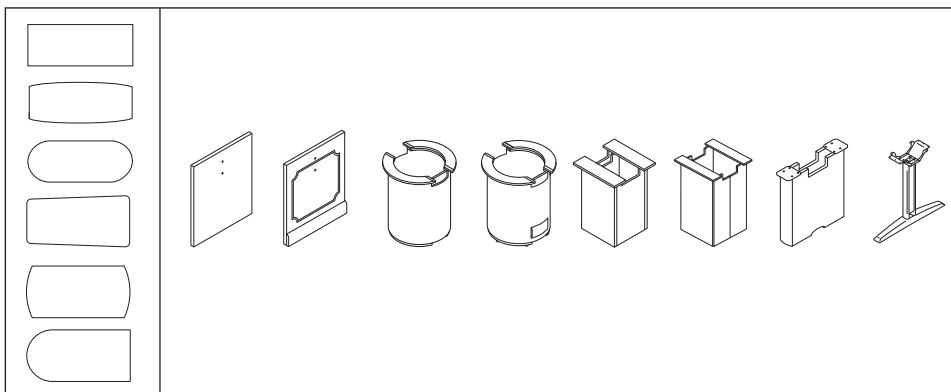

Bases compatible with 30"D and 36"D Rectangle, Boat, Racetrack, Soft Wedge, Arc End and Peninsula Tops

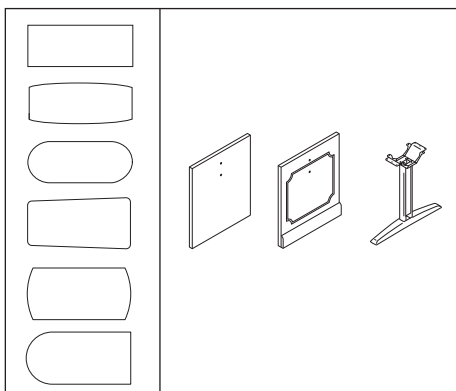

Bases compatible with Round and Square Tops

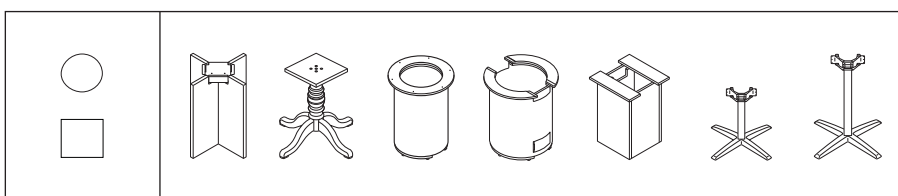

Bases that accommodate power and data

Power and data can be routed through select bases. Bases with removable doors provide easy access to concealed cabling and technology, such as wireless internet routers.

Bases with door accessibility

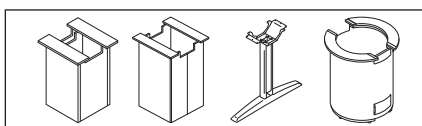

Bases with wire routing capabilities

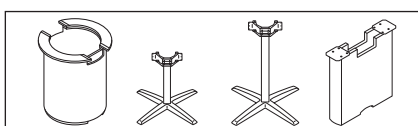

Specify Preside tables with two steps—select a top and select a base.

1. Select desired top size, shape, and edge profile.

Multi-piece Tops:

Multi-piece tops are made of 108", 120", 144" and 168" two-piece "starter-sections" in rectangle, boat, arc end, or racetrack shapes in 48" or 54" depths. For tables up to 20', models are preconfigured for you. If you need a table top longer than 20', add as many 72" adder sections as you need. The examples below illustrate preconfigured sizes as well as how starter section and adder section tops can be used to create tables in virtually any length. Please note that 2-piece tops, in woodgrain colors, will not have exact grain alignment in the center where the two halves meet, a reasonable match can be expected. For tops utilizing an adder section, there will not be a grain match for those pieces.

Preconfigured and Modular Size Examples

	Feet	Inches	Ex. Top Starter Section	Quantity	Adder Section	Quantity	Total Number of Top Sections
Preconfigured Sizes	9'	108"	HTLC48108	1	n/a	n/a	2
	10'	120"	HTLC48120	1	n/a	n/a	2
	12'	144"	HTLC48144	1	n/a	n/a	2
	14'	168"	HTLC48168	1	n/a	n/a	2
	15'	180"	HTLC48180	1	n/a	n/a	3
	16'	192"	HTLC48192	1	n/a	n/a	3
	18'	216"	HTLC48216	1	n/a	n/a	3
	20'	240"	HTLC48240	1	n/a	n/a	3
Modular Sizes	22'	264"	HTLC48120	1	HTLM4872	2	4
	24'	288"	HTLC48144	1	HTLM4872	2	4
	26'	312"	HTLC48168	1	HTLM4872	2	4
	28'	336"	HTLC48120	1	HTLM4872	3	5
	30'	360"	HTLC48144	1	HTLM4872	3	5

Note: Tables can be configured to any desired length beyond 30'.

Illustrations of Pre-configured Tops

48" x 108" Table Top (9')



Ex: HTLC48108

48" x 120" Table Top (10')



Ex: HTLC48120

48" x 144" Table Top (12')



Ex: HTLC48144

48" x 168" Table Top (14')



Ex: HTLC48168

48" x 180" Table Top (15')

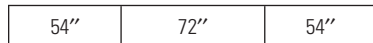

Ex: HTLC48180

48" x 192" Table Top (16')

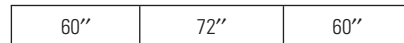

Ex: HTLC48192

48" x 216" Table Top (18')

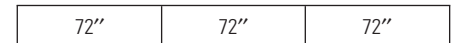

Ex: HTLC48216

48" x 240" Table Top (20')

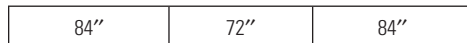

Ex: HTLC48240

Illustrations of User Configured Modular Tops

48" x 72" Adder Section

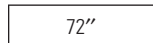

Ex: HTLM4872

48"D x 360"W Table Top (30')

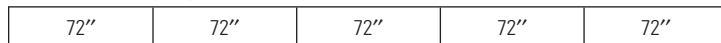

Ex: HTLC48144 + HTLM4872 + HTLM4872 + HTLM4872

2. Select desired base style and identify model that coincides with top length.**Bases for Tops in Preconfigured Sizes**

Bases include the appropriate number of supports for tables up to 20'. Simply identify the length of the table top in inches and specify the base with the same length in the model number. The example below illustrates how to select a base for a preconfigured size top.

Examples of Base for Preconfigured Top Size

Example top: HTLC48240 Top Description: 240" Rectangle Top
Example base: HTLHP240 Base Description: Hollow Panel Base for 240" Top

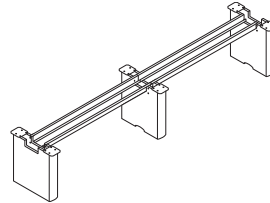

Example: HTLHP240

Bases for Tops in User Configured Modular Sizes

If you need a table top longer than 20', add as many 72" adder section bases as needed. The examples below illustrate preconfigured sizes as well as how starter section and adder section bases can be used to create tables in any desired length.

Examples of Tops and Bases for User Configured Modular Top

	Ex. Top		Ex. Top		Ex. Base		Ex. Base		Total # of Top		
	Feet	Inches	Starter Section	Quantity	Adder Section	Quantity	Starter Section	Quantity	Adder Section	Quantity	Sections
Preconfigured Sizes	9'	108"	HTLC48108	1	n/a	n/a	HTLHP108	1	n/a	n/a	2
	10'	120"	HTLC48120	1	n/a	n/a	HTLHP120	1	n/a	n/a	2
	12'	144"	HTLC48144	1	n/a	n/a	HTLHP144	1	n/a	n/a	2
	14'	168"	HTLC48168	1	n/a	n/a	HTLHP168	1	n/a	n/a	2
	15'	180"	HTLC48180	1	n/a	n/a	HTLHP180	1	n/a	n/a	3
	16'	192"	HTLC48192	1	n/a	n/a	HTLHP192	1	n/a	n/a	3
	18'	216"	HTLC48216	1	n/a	n/a	HTLHP216	1	n/a	n/a	3
	20'	240"	HTLC48240	1	n/a	n/a	HTLHP240	1	n/a	n/a	3
Modular Sizes	22'	264"	HTLC48120	1	HTLM4872	2	HTLHP120	1	HTLHPM	2	4
	24'	288"	HTLC48144	1	HTLM4872	2	HTLHP144	1	HTLHPM	2	4
	26'	312"	HTLC48168	1	HTLM4872	2	HTLHP168	1	HTLHPM	2	4
	28'	336"	HTLC48120	1	HTLM4872	3	HTLHP120	1	HTLHPM	3	5
	30'	360"	HTLC48144	1	HTLM4872	3	HTLHP144	1	HTLHPM	3	5

Note: Tables can be configured to any desired length beyond 30'.

Note: Preconfigured bases include the appropriate number of supports for tables up to 20'. Depending on base type, number of required supports varies. For information regarding total number of supports please refer to chart below.

Feet	Inches	HTLP	HTLT	HTTLEG	HTLHP	HTLCUBE	HTLCUBES	HTLR	HTLRC
9'	108"	2	2	2	2	2	2	2	2
10'	120"	2	2	2	2	2	2	2	2
12'	144"	2	2	2	2	2	2	2	2
14'	168"	3	3	3	3	2	2	2	2
15'	180"	3	n/a	3	3	3	3	3	3
16'	192"	3	n/a	3	3	3	3	3	3
18'	216"	3	n/a	3	3	3	3	3	3
20'	240"	4	n/a	4	3	3	3	3	3

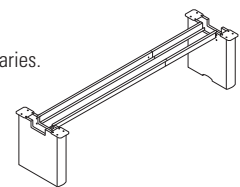

Example: HTLHP168

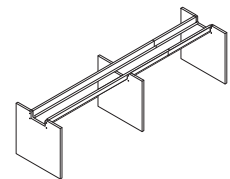

Example: HTVP168

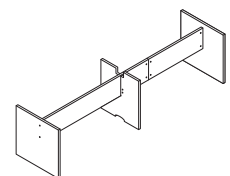

Example: HTLP168

Base Model Descriptions (L = Laminate, V = Veneer)

HT(L/V)P = Panel Base
HT(L/V)T = Traditional Panel Base
HTTLEG = Aluminum T-Leg
HT(L/V)HP = Hollow Panel Base
HT(L/V)CUBE = Cube Base
HT(L/V)CUBES = Standing Height Cube Base
HT(L/V)R = Cylinder Base
HT(L/V)RC = Wire Management Cylinder Base

Note: Veneer panel bases configured with dual aluminum beam supports.
Laminate panel bases configured with particleboard stretcher supports.

Tops specified with a grommet cutout get one cutout per section of top, centered in both directions.

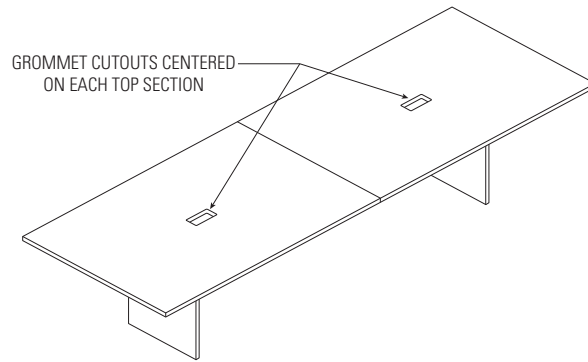

Upcharges for grommet cutouts (\$40 per G1 cutout, \$50 per G2 cutout)

Top Length	# Cutouts	Upcharge (G1/G2)	# Power Ports Required
36"	1	\$ 40/50	1
42"	1	\$ 40/50	1
48"	1	\$ 40/50	1
60"	1	\$ 40/50	1
72"	1	\$ 40/50	1
84"	1	\$ 40/50	1
96"	1	\$ 40/50	1
108"	2	\$ 80/100	2
120"	2	\$ 80/100	2
144"	2	\$ 80/100	2
168"	2	\$ 80/100	2
180"	3	\$120/150	3
192"	3	\$120/150	3
216"	3	\$120/150	3
240"	3	\$120/150	3

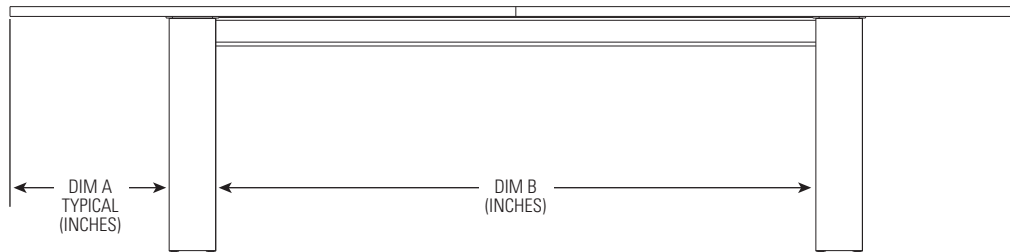

Clearance Between Bases for Tables 60''W and 72''W

Model #	Description	5' (60'')		6' (72'')	
		Dim. A	Dim. B	Dim. A	Dim. B
HTLPA	Panel Base	11	36	17	36
HTLTA	Traditional Panel Base	n/a	n/a	17	36
HTTLEG	Aluminum T-Leg	12	29	14	36
HTVPA	Panel Base	13	32	19	32
HTVTA	Traditional Panel Base	n/a	n/a	19	32

Clearance Between Bases for Tables 84''W-240''W

Model #	Description	Dim. A	Dim. B									
		All Lengths	7' (84'')	8' (96'')	9' (108'')	10' (120'')	12' (144'')	14' (168'')	15' (180'')	16' (192'')	18' (216'')	20' (240'')
HTLHPB	Hollow Panel Base	20	45	45	69	69	93	57	62	68	80	92
HTLPB	Panel Base	23	48	48	72	72	96	60	66	72	84	63
HTLRB	Cylinder Base	19	n/a	14	38	38	62	86	38	44	56	68
HTLRBC	Wire Management Cylinder	19	n/a	14	38	38	62	86	38	44	56	68
HTLSB	Cube Base	19	n/a	18	42	42	66	90	41	47	59	71
HTLSH	Standing Height Cube	19	n/a	13	37	37	61	85	36	42	54	66
HTLTB	Traditional Panel Base	23	36	48	72	72	96	60	n/a	n/a	n/a	n/a
HTTLEG	Aluminum T-Leg	20	36	48	72	72	96	59	65	71	83	62
HTVHPB	Hollow Panel Base	20	33	45	69	69	93	57	62	68	80	92
HTVPB	Panel Base	19	44	56	80	80	104	64	70	76	88	66
HTVRB	Cylinder Base	19	n/a	14	38	38	62	86	38	44	56	68
HTVRBC	Wire Management Cylinder	19	n/a	14	38	38	62	86	38	44	56	68
HTVSB	Cube Base	19	n/a	18	42	42	66	90	41	47	59	71
HTVSH	Standing Height Cube	19	n/a	13	37	37	61	85	36	42	54	66
HTVTB	Traditional Panel Base	19	44	56	80	80	104	64	n/a	n/a	n/a	n/a

Preside conference solutions can be used in a multitude of office applications.

For the Private Office



42"D Round Top, Tri-Oval Edge, Cylinder Base

Laminate Pricing:

Qty.	Model Number	List	Extended
1	HTLD42.V	\$480	\$ 480
1	HTLR42	\$630	\$ 630
		TOTAL:	\$1,110

Veneer Pricing:

Qty.	Model Number	List	Extended
1	HTVD42.V	\$1,900	\$1,900
1	HTVR42	\$1,373	\$1,373
		TOTAL:	\$3,273

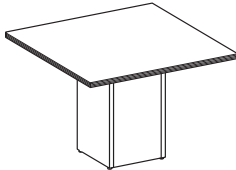

48"D x 48"W Square Top, Ribbon Edge, Cube Base

Laminate Pricing:

Qty.	Model Number	List	Extended
1	HTLS48.K	\$678	\$ 678
1	HTLCUBE48	\$907	\$ 907
		TOTAL:	\$1,585

For the Small Conference Room

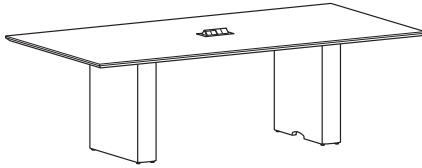

96"W x 48"D Rectangle Top, One Cutout, Knife Edge, Pop-Up Port, Hollow Panel Base

Laminate Pricing:

Qty.	Model Number	List	Extended
1	HTLC4896.J(EdgeColor).G1	\$1,314	\$1,314
1	HTPWRGROM1	\$ 343	\$ 343
1	HTLHP96	\$1,619	\$1,619
		TOTAL:	\$3,276

Veneer Pricing:

Qty.	Model Number	List	Extended
1	HTVC4896.J(EdgeColor).G1	\$2,831	\$2,831
1	HTPWRGROM1	\$ 343	\$ 343
1	HTVHP96	\$3,223	\$3,223
		TOTAL:	\$6,397

For the Boardroom

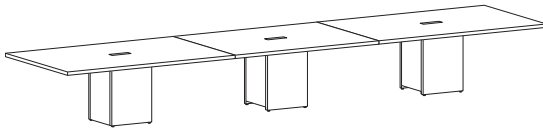

240"W x 54"D Rectangle Top, Drop Edge, 3 Cutouts, 3 Flip Top Ports, Cube Base

Laminate Pricing:

Qty.	Model Number	List	Extended
3	HTPWRGROM2	\$ 496	\$1,488
1	HTLCUBE240	\$3,302	\$3,302
		TOTAL:	\$4,790

Veneer Pricing:

Qty.	Model Number	List	Extended
1	HTVC54240.H(EdgeColor).G2	\$10,022	\$10,022
3	HTPWRGROM2	\$ 496	\$ 1,488
1	HTVCUBE240	\$ 5,663	\$ 5,663
		TOTAL:	\$17,173

For the Café



36"D Round Tops, 2mm Square Edge, Sitting and Standing Height Aluminum X-Bases

Laminate Pricing:

Qty.	Model Number	List	Extended
4	HTLD36.G	\$343	\$1,372
2	HTXLEG	\$434	\$ 868
2	HTXLEGSH	\$540	\$1,080
		TOTAL:	\$3,320

Veneer Pricing:

Qty.	Model Number	List	Extended
4	HTVD36.G	\$1,395	\$5,580
2	HTXLEG	\$ 434	\$ 868
2	HTXLEGSH	\$ 540	\$1,080
		TOTAL:	\$7,528

Preside® Veneer Table Tops

GSA SIN 711-11



- ▶ See base options on pages 692-695.
- ▶ Veneer tops are available in six different edge details. Specify G, C, J, T, H or V as the first option after the base model.
- ▶ Tops with G, C, J, T edge detail feature 1/8" edge thickness and finished MDF rim.
- ▶ Tops with H and V edge detail feature 1/2" edge thickness and feature hardwood rims.
- ▶ Tops are available in eight shapes: Racetrack (A), Boat (B), Rectangle (C), Arc End (E), Peninsula (F), Soft WEdge (G), Round (D), Square (S). Replace the (?) shown in each model with A, B, C, E, F, G, D or S to specify shape. Tops with traditional (T) edge available in rectangle, round and square shapes only.
- ▶ Table tops sit 29/32" above floor with glide half way seated.
- ▶ Tops 96" and greater, in woodgrain colors, will not have exact grain alignment in the center where the two halves meet, a reasonable match can be expected.
- ▶ Tops greater than 96" ship in multiple pieces to facilitate handling and installation. For details see page 683.
- ▶ Woodgrain pattern runs parallel to seam on multi-piece tops.
- ▶ For best veneer color match, product should be specified on same order.
- ▶ Flip-top Port options are not available on Round or Square tops; Pop-up ports only.
- ▶ Cannot specify a Port option for 48" Round or Square Table Tops with Traditional edge.
- ▶ See page 687 for number of cutouts for each table top size.
- ▶ Optional cutouts are available to accommodate power ports. One centered cutout per top section. Power ports must be ordered separately. For power port specification details see page 697.
- ▶ Single and two-piece tops ship in one carton, three piece tops ship in two cartons.
- ▶ Underside of tops feature alignment guide for base placement.
- ⚠ **Veneer color match for adder sections may vary depending on date of purchase.**
- ⚠ **Tops with traditional edge available in Mahogany only.**

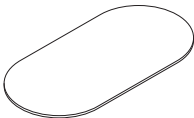
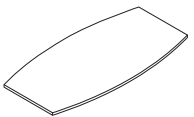
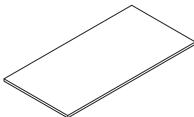
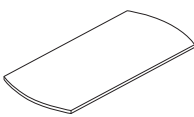
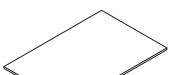

Description	Model	Ship		List by Edge Treatment							
		Weight	Cube	"G"	"C"	"J"	"T"	"H"	"V"		
Veneer Boat, Racetrack, Rectangle and Arc End Shaped Tops											
 A = Racetrack Not available in "T" edge option	240"W x 54"D	HTV(?)54240 E♦A	425	25.1	\$7912	\$8280	\$8662	N/A	\$9872	\$10798	
	216"W x 54"D	HTV(?)54216 E♦A	384	23.3	\$7240	\$7577	\$7926	N/A	\$9034	\$ 9433	
	192"W x 54"D	HTV(?)54192 E♦A	345	21.4	\$6669	\$6982	\$7303	N/A	\$8323	\$ 8709	
	180"W x 54"D	HTV(?)54180 E♦A	466	21.4	\$6669	\$6982	\$7303	N/A	\$8323	\$ 8709	
	168"W x 54"D	HTV(?)54168 E♦A	300	13.5	\$5520	\$5776	\$6044	N/A	\$6887	\$ 7533	
	144"W x 54"D	HTV(?)54144 E♦A	259	11.6	\$4848	\$5073	\$5308	N/A	\$6049	\$ 6168	
	120"W x 54"D	HTV(?)54120 E♦A	220	9.8	\$4277	\$4478	\$4685	N/A	\$5338	\$ 5444	
	108"W x 54"D	HTV(?)54108 E♦A	341	9.8	\$4277	\$4478	\$4685	N/A	\$5338	\$ 5444	
	 B = Boat Not available in "T" edge option	240"W x 48"D	HTV(?)48240 E♦A	392	21.9	\$7193	\$7528	\$7876	N/A	\$8975	\$ 9814
		216"W x 48"D	HTV(?)48216 E♦A	351	19.7	\$6574	\$6858	\$7200	N/A	\$8205	\$ 8567
192"W x 48"D		HTV(?)48192 E♦A	312	18.1	\$6060	\$6344	\$6637	N/A	\$7562	\$ 7913	
180"W x 48"D		HTV(?)48180 E♦A	314	19.7	\$6060	\$6344	\$6637	N/A	\$7562	\$ 7913	
168"W x 48"D		HTV(?)48168 E♦A	281	12.1	\$5019	\$5252	\$5496	\$5898	\$6262	\$ 6848	
144"W x 48"D		HTV(?)48144 E♦A	240	9.8	\$4400	\$4582	\$4820	\$5171	\$5492	\$ 5601	
120"W x 48"D		HTV(?)48120 E♦A	201	8.2	\$3886	\$4068	\$4257	\$4566	\$4849	\$ 4947	
108"W x 48"D		HTV(?)48108 E♦A	203	8.7	\$3886	\$4068	\$4257	N/A	\$4849	\$ 4947	
 C = Rectangle		96"W x 48"D	HTV(?)4896 E♦A	153	13.2	\$2398	\$2668	\$2791	\$2818	\$2993	\$ 3166
		84"W x 42"D	HTV(?)4284 E♦A	157	12.1	\$2398	\$2668	\$2791	N/A	\$2993	\$ 3166
 E = Arc End	72"W x 36"D	HTV(?)3672 E♦A	90	7.9	\$1776	\$1921	\$2011	\$2090	\$2216	\$ 2570	
	60"W x 30"D	HTV(?)3060 E♦A	63	5.6	\$1510	\$1581	\$1655	N/A	\$1884	\$ 2062	
Veneer Adder Section for Boat, Racetrack, Rectangle and Arc Shaped Tops											
 M = Mid-section Adder	72"W x 48"D	HTVM4872 E♦A	111	9.8	\$2174	\$2276	\$2380	N/A	\$2713	\$2966	
	72"W x 54"D	HTVM5472 E♦A	125	11.6	\$2392	\$2504	\$2618	N/A	\$2985	\$3265	

NOTES: Veneer Adder sections are meant to be purchased with initial table purchase. HON cannot guarantee veneer color match when placing an Adder section to an already existing table.

⚠ **Adder section cannot be used as standalone table. Only long edges are finished.**

How to specify	1st Option	2nd Option	3rd Option
Select Model Number from above H T V C 5 4 2 4 0 . J .	Select Edge Detail See page 682	Select Cutout Option N No Cutout G1 Cutout for Pop-up Port (\$40 upcharge per cutout) G2 Cutout for Flip-top Port (\$50 upcharge per cutout) Flip-top Port cannot be specified for Round or Square tops G 2 .	Select Veneer See page 680 D

Icon Legend on page 10

- ▶ Veneer tops are available in six different edge details. Specify G, C, J, T, H or V as the first option after the base model.
- ▶ Tops with G, C, J, T edge detail feature 1/4" edge thickness and finished MDF rim.
- ▶ Tops with H and V edge detail feature 1/2" edge thickness and feature hardwood rims.
- ▶ See base options on pages 692-695.
- ▶ Tops are available in eight shapes: Racetrack (A), Boat (B), Rectangle (C), Arc End (E), Peninsula (F), Soft Wedge (G), Round (D), Square (S). Replace the (?) shown in each model with A, B, C, E, F, G, D or S to specify shape. Tops with traditional (T) edge available in rectangle, round and square shapes only.
- ▶ Table tops sit 29 1/2" above floor with glide half way seated.
- ▶ Tops 96" and greater, in woodgrain colors, will not have exact grain alignment in the center where the two halves meet, a reasonable match can be expected.
- ▶ Tops greater than 96" ship in multiple pieces to facilitate handling and installation. For details see page 683.
- ▶ Woodgrain pattern runs parallel to seam on multi-piece tops.
- ▶ Veneer color match for adder sections may vary depending on date of purchase.
- ▶ For best veneer color match, product should be specified on same order.
- ▶ Flip-top Port options are not available on Round or Square tops; Pop-up ports only.
- ▶ Cannot specify a Port option for 48" Round or Square Table Tops with Traditional edge.
- ▶ See page 687 for number of cutouts for each table top size.
- ▶ Optional cutouts are available to accommodate power ports. One centered cutout per top section. Power ports must be ordered separately. For power port specification details see page 697.
- ▶ Single and two-piece tops ship in one carton, three piece tops ship in two cartons.
- ▶ Underside of tops feature alignment guide for base placement.
- ⚠ **Tops with traditional edge available in Mahogany only.**
- ⚠ **Soft Wedge table tops are only available in G, C and J edge options.**

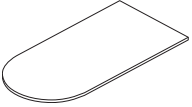

Description	Model	Ship		List by Edge Treatment					
		Weight	Cube	"G"	"C"	"J"	"T"	"H"	"V"
 Veneer Peninsula Table Tops 96"W x 48"D 84"W x 42"D 72"W x 36"D 60"W x 30"D	HTVF4896 E♦A	149	13.2	\$2398	\$2668	\$2791	N/A	\$2993	\$3166
	HTVF4284 E♦A	152	12.1	\$2398	\$2668	\$2791	N/A	\$2993	\$3166
	HTVF3672 E♦A	66	7.9	\$1776	\$1921	\$2011	N/A	\$2216	\$2570
	HTVF3060 E♦A	46	5.6	\$1510	\$1581	\$1655	N/A	\$1884	\$2062

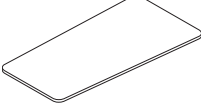
Description	Model	Ship Weight		List by Edge Treatment					
		Round	Square	Cube	"G"	"C"	"J"	"T"	"H"
 Veneer Soft Wedge Table Tops 96"W x 48"D 84"W x 42"D 72"W x 36"D 60"W x 30"D	HTVG4896 E♦A	149	13.2	\$2398	\$2668	\$2791	N/A	N/A	N/A
	HTVG4284 E♦A	139	12.1	\$2398	\$2668	\$2791	N/A	N/A	N/A
	HTVG3672 E♦A	66	7.9	\$1776	\$1921	\$2011	N/A	N/A	N/A
	HTVG3060 E♦A	46	5.6	\$1510	\$1581	\$1655	N/A	N/A	N/A

Description	Model	Ship Weight		List by Edge Treatment						
		Round	Square	Cube	"G"	"C"	"J"	"T"	"H"	"V"
 Veneer Round and Square Shaped Tops 48" Top 42" Top 36" Top	HTV(?)48	66	76	6.3	\$1807	\$1989	\$2081	\$2107	\$2128	\$2179
	HTV(?)42	51	61	4.9	\$1641	\$1722	\$1802	\$1838	\$1822	\$1900
	HTV(?)36	36	46	3.7	\$1395	\$1465	\$1532	\$1563	\$1523	\$1617

NOTES: Tops are available in two shapes: Round (D) and Square (S). Replace the (?) shown in each model with D or S to specify shape.

D = Round

S = Square

How to specify	1st Option	2nd Option	3rd Option
Select Model Number from above H T V F 4 8 9 6 .	Select Edge Detail See page 682 J .	Select Cutout Option N No Cutout G1 Cutout for Pop-up Port (\$40 upcharge per cutout) G2 Cutout for Flip-top Port (\$50 upcharge per cutout) Flip-top Port cannot be specified for Round or Square tops G 2 .	Select Veneer See page 680 D

Preside® Veneer Tables — Bases

GSA SIN 711-11



- ▶ Tops and bases are sold and shipped separately.
- ▶ For Base and Top compatibility, see base information on pages 683-686.
- ▶ All bases allow table tops to sit 29½" above floor with leveling glides half-way retracted.
- ▶ Bases ship with appropriate number of supports for table width. See page 686 for details.
- ▶ Veneer panel bases feature dual aluminum support beams with integrated wire management. Support beam ships with tops on 60" and 72" W tables and with the base on tables 96" W and greater.
- ▶ Aluminum T-legs for tops 96" W and greater feature dual aluminum support beams with integrated wire management. Aluminum T-legs for 60" and 72" tops do not include aluminum beams.
- ▶ Efficient design of Aluminum T-leg maximizes leg space. The T-leg features a removable door for wire access.
- ▶ Traditional panel base for 168" W Top includes two traditional panels and one standard panel.



Description	Panels Included Per Kit	Model	Ship		
			Weight	Cube	List
Veneer Panel Base for Tops 60" or Wider					
For 240" W Table Tops	4	HTVP240	141	9.9	\$3004
For 216" W Table Tops	3	HTVP216	111	7.0	\$2199
For 192" W Table Tops	3	HTVP192	109	6.8	\$2138
For 180" W Table Tops	3	HTVP180	147	11.6	\$2138
For 168" W Table Tops	3	HTVP168	100	6.6	\$2056
For 144" W Table Tops	2	HTVP144	70	3.7	\$1251
For 120" W Table Tops	2	HTVP120	68	3.4	\$1190
For 108" W Table Tops	2	HTVP108	86	5.8	\$1190
For 96" W Table Tops	2	HTVP96	62	3.2	\$1128
For 84" W Table Tops	2	HTVP84	75	4.9	\$1128
For 72" W Table Tops	2	HTVP72	53	4.4	\$1050
For 60" W Table Tops	2	HTVP60	53	4.4	\$1050
For 72" Adder Section	1	HTVPM	41	3.4	\$ 948
Veneer Traditional Panel Base for Tops 72" or Wider					
For 168" W Table Tops	3	HTVT168 D	113	7.9	\$2559
For 144" W Table Tops	2	HTVT144 D	78	5.6	\$1754
For 120" W Table Tops	2	HTVT120 D	76	5.4	\$1693
For 96" W Table Tops	2	HTVT96 D	70	5.2	\$1631
For 72" W Table Tops	2	HTVT72 D	59	4.4	\$1572
Aluminum T-Leg for Tops 60" or Wider					
For 240" W Table Tops	4	HTLEG240	76	8.9	\$1723
For 216" W Table Tops	3	HTLEG216	65	8.6	\$1374
For 192" W Table Tops	3	HTLEG192	63	8.4	\$1313
For 180" W Table Tops	3	HTLEG180	63	8.4	\$1313
For 168" W Table Tops	3	HTLEG168	54	8.2	\$1231
For 144" W Table Tops	2	HTLEG144	39	4.2	\$ 863
For 120" W Table Tops	2	HTLEG120	37	4.2	\$ 802
For 108" W Table Tops	2	HTLEG108	37	4.2	\$ 802
For 96" W Table Tops	2	HTLEG96	31	4.0	\$ 740
For 84" W Table Tops	2	HTLEG84	31	4.0	\$ 740
For 72" W Table Tops	2	HTLEG72	26	3.5	\$ 571
For 60" W Table Tops	2	HTLEG60	22	3.5	\$ 571
For 72" Adder Section	1	HTLEGM	26	4.2	\$ 511

How to specify	<p>Select Model Number from above</p> <p>H T V P 2 4 0 .</p> <p>H T T L E G 2 4 0 .</p>	<p>1st Option</p> <p>Select Veneer</p> <p>See page 680</p> <p>D</p> <p>Select Paint Color</p> <p>See page 680</p> <p>P Black WHIT Brilliant White (\$20 for bases with 1 or 2 supports, \$40 for bases with 3 or 4 supports)</p> <p>S Charcoal T4 Champagne (\$20 for bases with 1 or 2 supports, \$40 for bases with 3 or 4 supports)</p> <p> T1 Platinum (\$20 for bases with 1 or 2 supports, \$40 for bases with 3 or 4 supports)</p> <p>T 4</p>
----------------	---	--

Icon Legend on page 10 D Discontinued 2/28/2017.

- ▶ Tops and bases are sold and shipped separately.
- ▶ For Base and Top compatibility, see base information on pages 683-686.
- ▶ Standing-height Cube Bases are 39"H.
- ▶ Cube base requires 150 pounds of sand or other ballast in each base for stability (customer to supply).
- ▶ Veneer cube bases for tops 120"W and greater feature dual aluminum support beams with integrated wire management.
- ▶ Hollow Panel and aluminum T-legs for tops 96"W and greater feature dual aluminum support beams with integrated wire management.
- ▶ End caps for Hollow Panel bases can be matched to wood grain finishes or specified in select solid colors.
- ▶ Hollow Panel and Cube bases feature a removable door to allow access to cable and enable wire routing through bases.
- ▶ New Standing Height Bases feature a hinged door for easy access and for cable routing through the base.

▲ **Veneer Standing Height Cube bases do not require ballast.**

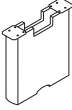
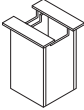
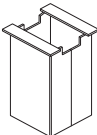

Description	Panels Included Per Kit	Model	Ship Weight		
			Cube	List	
 <p>Veneer Hollow Panel Base for Tops 84" or Wider For 240"W Table Tops For 216"W Table Tops For 192"W Table Tops For 180"W Table Tops For 168"W Table Tops For 144"W Table Tops For 120"W Table Tops For 108"W Table Tops For 96"W Table Tops For 84"W Table Tops</p>	3	HTVHP240	206	17.5	\$5162
	3	HTVHP216	204	17.3	\$5089
	3	HTVHP192	202	17.1	\$5028
	3	HTVHP180	202	17.1	\$5028
	3	HTVHP168	193	16.9	\$4946
	2	HTVHP144	133	11.4	\$3346
	2	HTVHP120	131	11.2	\$3285
	2	HTVHP108	131	11.2	\$3285
	2	HTVHP96	125	11.0	\$3223
	2	HTVHP84	125	11.0	\$3223
For 72" Adder Section	1	HTVHPM	71	5.9	\$1743
 <p>Veneer Cube Base for Tops 84" or Wider For 240"W Table Tops For 216"W Table Tops For 192"W Table Tops For 180"W Table Tops For 168"W Table Tops For 144"W Table Tops For 120"W Table Tops For 108"W Table Tops For 96"W Table Tops For 84"W Table Tops</p>	3	HTVCUBE240	278	29.2	\$5663
	3	HTVCUBE216	276	29.0	\$5590
	3	HTVCUBE192	274	28.8	\$5529
	3	HTVCUBE180	274	28.8	\$5529
	2	HTVCUBE168	183	19.4	\$3753
	2	HTVCUBE144	181	19.2	\$3680
	2	HTVCUBE120	179	19.0	\$3619
	2	HTVCUBE108	179	19.0	\$3619
	2	HTVCUBE96	164	18.2	\$3388
	2	HTVCUBE84	164	18.2	\$3388
For 72" Adder Section	1	HTVCUBEM	95	9.8	\$1910
 <p>Veneer Standing Height Cube Base for Tops 96" or Wider For 240"W Table Tops For 216"W Table Tops For 192"W Table Tops For 180"W Table Tops For 168"W Table Tops For 144"W Table Tops For 120"W Table Tops For 108"W Table Tops For 96"W Table Tops</p>	3	HTVCUBES240	302	45.7	\$6530
	3	HTVCUBES216	300	45.5	\$6457
	3	HTVCUBES192	298	45.3	\$6396
	3	HTVCUBES180	298	45.3	\$6396
	2	HTVCUBES168	199	30.4	\$4331
	2	HTVCUBES144	197	30.2	\$4258
	2	HTVCUBES120	195	30.0	\$4197
	2	HTVCUBES108	195	30.0	\$4197
	2	HTVCUBES96	180	29.2	\$3966
	For 72" Adder	1	HTVCUBESM	103	15.3

How to specify	1st Option	2nd Option																
<p>Select Model Number from above</p> <p>H T V H P 2 4 0 .</p>	<p>Select Veneer See page 680</p> <p>D .</p>	<p>Select Inlay/End Cap Finish (specified for Hollow Panel Bases only)</p> <table border="0"> <tr> <td>H Bourbon Cherry</td> <td>P Black</td> </tr> <tr> <td>COGN Cognac</td> <td>WHIT Brilliant White</td> </tr> <tr> <td>C Harvest</td> <td>S Charcoal</td> </tr> <tr> <td>N Mahogany</td> <td>LOFT Loft</td> </tr> <tr> <td>MOCH Mocha</td> <td>SHDW Shadow</td> </tr> <tr> <td>D Natural Maple</td> <td>T4 Champagne</td> </tr> <tr> <td>PINC Pinnacle</td> <td>T1 Platinum</td> </tr> <tr> <td>F Shaker Cherry</td> <td></td> </tr> </table> <p>H </p>	H Bourbon Cherry	P Black	COGN Cognac	WHIT Brilliant White	C Harvest	S Charcoal	N Mahogany	LOFT Loft	MOCH Mocha	SHDW Shadow	D Natural Maple	T4 Champagne	PINC Pinnacle	T1 Platinum	F Shaker Cherry	
H Bourbon Cherry	P Black																	
COGN Cognac	WHIT Brilliant White																	
C Harvest	S Charcoal																	
N Mahogany	LOFT Loft																	
MOCH Mocha	SHDW Shadow																	
D Natural Maple	T4 Champagne																	
PINC Pinnacle	T1 Platinum																	
F Shaker Cherry																		

Preside® Veneer Tables — Bases

GSA SIN 711-11



- ▶ Tops and bases are sold and shipped separately.
- ▶ Bases ship with appropriate number of supports for table width. See page 686 for details.
- ▶ For Base and Top compatibility, see base information on pages 683-686.
- ▶ Cylinder base requires 150 pounds of sand or other ballast in each base for stability (customer to supply).
- ▶ Cylinder bases facilitate wire management with integrated wire channel and plinth.
- ▶ Veneer cylinder bases for tops 120"W and greater feature dual aluminum support beams with integrated wire management.
- ▶ New Veneer Cylinder Bases with Wire Management include a unique design that allows cords to be routed through the base with easy access to electrical outlets.
- △ **New Veneer Cylinder Bases with Wire Management support 48" D and 54" D table tops only.**



	Description	Panels Included Per Kit	Model	Ship Weight	Cube	List
	Veneer Cylinder Base for Tops 84'' or Wider					
	For 240''W Table Tops	3	HTVR240	191	51.9	\$4808
	For 216''W Table Tops	3	HTVR216	189	51.7	\$4735
	For 192''W Table Tops	3	HTVR192	187	51.5	\$4674
	For 180''W Table Tops	3	HTVR180	187	51.4	\$4674
	For 168''W Table Tops	2	HTVR168	125	34.5	\$3183
	For 144''W Table Tops	2	HTVR144	123	34.3	\$3110
	For 120''W Table Tops	2	HTVR120	121	34.1	\$3049
	For 108''W Table Tops	2	HTVR108	121	34.1	\$3059
	For 96''W Table Tops	2	HTVR96	106	33.3	\$2818
	For 84''W Table Tops	2	HTVR84	106	33.3	\$2818
	For 72'' Adder Section	1	HTVRM	66	17.4	\$1625
	Veneer Cylinder Base with Wire Management for Tops 84'' or Wider					
	For 240''W Table Tops	3	HTVRC240	191	51.9	\$5825
	For 216''W Table Tops	3	HTVRC216	189	51.7	\$5752
	For 192''W Table Tops	3	HTVRC192	187	51.4	\$5691
	For 180''W Table Tops	3	HTVRC180	187	51.4	\$5691
	For 168''W Table Tops	2	HTVRC168	125	34.5	\$3861
	For 144''W Table Tops	2	HTVRC144	123	34.3	\$3788
	For 120''W Table Tops	2	HTVRC120	121	34.1	\$3727
	For 108''W Table Tops	2	HTVRC108	121	34.1	\$3727
	For 96''W Table Tops	2	HTVRC96	106	33.3	\$3496
	For 84''W Table Tops	2	HTVRC84	106	33.3	\$3496
	For 72'' Adder Section	1	HTVRCM	66	17.4	\$1964
 Used with 36'' and 42'' table tops	Veneer Cylinder Base for Round and Square Tops For 48'' Tops For 42'' Tops For 36'' Tops	1	HTVR48	53	16.7	\$1409
		1	HTVR42	42	11.6	\$1373
		1	HTVR36	42	11.6	\$1373



How to specify	Select Model Number from above H T V R 2 4 0 .	1st Option Select Veneer See page 680 D
----------------	---	---



► Tops and bases are sold and shipped separately.

► Bases ship complete with the number of bases required for the length of the top as well as the stretchers.

► For Base and Top compatibility, see base information on pages 683-686.

► Efficient design of the Aluminum X-Leg Base maximizes leg space and allows wires to pass through the center of the leg.

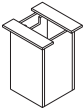
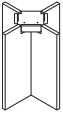

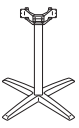
	Description	Bases Included Per Kit	Model	Ship Weight	Cube	List
	Veneer Cube Base for Round and Square Tops For 48" Tops	1	HTVCUBE48	82	9.1	\$1694
	Veneer Panel X-Base for Round and Square Tops For 48" Tops For 42" Tops For 36" Tops	1 1 1	HTVXP48 HTVXP42 HTVXP36	54 54 47	5.2 5.2 4.7	\$1083 \$1083 \$1026
	Traditional X-Base for Round and Square Tops Can be used with 36", 42" and 48" Round Tops and 36" and 42" Square Tops. Not compatible with cutouts or power ports. NOTES: Available in Mahogany (N) Veneer only.	1	H94011 E◆A	40	5.4	\$ 611
 <i>Specify paint</i>	Aluminum X-Leg Base for 36", 42" and 48" Round and Square Tops	1	HTXLEG	16	3.5	\$ 434
 <i>Specify paint</i>	Standing Height Aluminum X-Leg Base for 36" and 42" Round and Square Tops	1	HTXLEGSH	17	3.5	\$ 540

How to specify	<p>Select Model Number from above</p> <p>H T V C U B E 4 8 .</p> <p>H T X L E G .</p>	<p>1st Option</p> <p>Select Veneer See page 680 D </p> <p>Select Paint Color See page 680</p> <p>P Black WHIT Brilliant White (\$20 for bases with 1 or 2 supports, \$40 for bases with 3 or 4 supports) S Charcoal T4 Champagne (\$20 for bases with 1 or 2 supports, \$40 for bases with 3 or 4 supports) T1 Platinum (\$20 for bases with 1 or 2 supports, \$40 for bases with 3 or 4 supports)</p> <p>T 4 </p>
----------------	---	---

Preside® Veneer Shared Components

GSA SIN 711-2



► Choose from four handle options for the Credenza and Lectern models.



Loop Handle

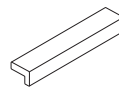

Empire Handle

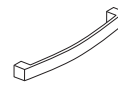

Rounded Square Handle

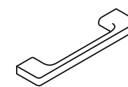

Arch Handle

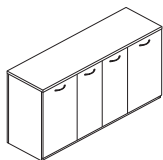

Description

Veneer Hospitality Credenza

- Overall cabinet dimensions 72"W x 20"D x 36"H.
- Features four doors and two hidden drawers.
- Supports optional veneer Hospitality Shelf.
- Can support mini fridge.
- Worksurface sits at buffet height for easy reach.
- Includes ventilation cutouts in back.
- Can accommodate optional trash bin and AV rack accessories.
- Laminate shelf for use in outer compartments of credenza models. See page 697.

Model

Ship Weight

Cube

List

HTVCREDA

301

37.0

\$4430

How to specify

Select Model Number from above

H T V C R E D A .

1st Option

Select Edge Detail

- C** Cove Edge
- G** Flat Edge
- J** Knife Edge
- V** Tri-Oval Edge

G .

2nd Option

Select Veneer Finish

See page 680

G .

3rd Option

Select Handle

- J** Loop Satin Nickel
- G** Loop Black
- 1** Empire Matte Chrome
- 2** Empire Black
- 3** Rounded Square Matte Chrome
- 4** Rounded Square Black
- 5** Arch Matte Chrome
- 6** Arch Black

J



Icon Legend on page 10

► Self-adjusting hinges on the Presentation Cabinet ensure doors are in alignment.

► Extron plates can be retrofitted to be used on HTPWRGROM4.

► 1 Double Space or 2 Single Space plates can be used in a single HTPWRGROM4 flip-top port.

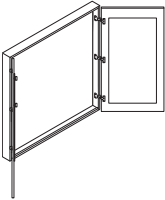
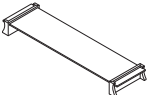
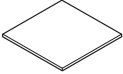
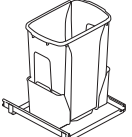
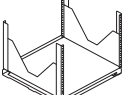
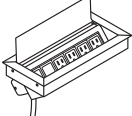
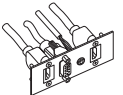
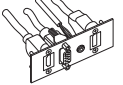
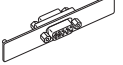
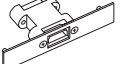
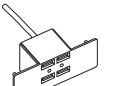

Description	Model	Ship Weight	Cube	List
 <p>Veneer Presentation Cabinet</p> <ul style="list-style-type: none"> Overall cabinet dimensions 48 1/8"W x 5"D x 49 1/2"H. Mounts to wall. Presentation cabinet features one magnetic white board and two tackboards. Attractive doors enclose cabinet to provide a professional appearance and to ensure privacy. Top quality markerboard designed with long lasting, non-ghosting surface. 	HTVPRES	169	10.9	\$3083
 <p>Hospitality Shelf 48"W x 13"D x 4 5/8"H</p> <ul style="list-style-type: none"> Hospitality shelf can be placed on hospitality credenza or table top. Provides additional serving surface. Features veneer endcaps and frosted glass shelf. 	HVSHELF	22	2.7	\$1435
 <p>Laminated Credenza Shelf</p> <ul style="list-style-type: none"> Shelf can be utilized in the outer compartments of the credenza. Shelf is available in laminate only. 3 mounting locations within outer compartment on the credenza. Finish selection available on page 680. 	HTLSHELF	10	1.5	\$ 62
			L1 List	L2 Upcharge
			\$ 62	\$ 10
 <p>Trash Bin Slide</p> <ul style="list-style-type: none"> Holds a 35 quart bin 	HTBINSLIDE	15	3.5	\$ 189
 <p>Mounted AV Rack</p>	HTRACK	15	4.8	\$1689
 <p>Power Ports</p> <p>Pop-up Port — 3 Power, 1 Data Flip-top Port — 4 Power, 2 Data Flip-top Port — 4 Power, 1 VGA and 1 HDM Flip-top Port — 3 Power, 1 Extron Plate cutout Flip-top Port — 3 Power, 1 USB and 2 Blank Data Ports</p>	HTPWRGROM1 HTPWRGROM2 HTPWRGROM3 HTPWRGROM4 HTPWRGROM5	5 5 5 5 5	0.3 0.3 0.3 0.3 0.3	\$ 343 \$ 496 \$ 777 \$ 608 \$ 721
 <p>Extron Plate (Double Space) — VGA, HDMI, HDMI, Audio</p>	HTPLATEVHAU	1	0.1	\$ 350
 <p>Extron Plate (Double Space) — DP, VGA, HDMI, Audio</p>	HTPLATEDHAU	1	0.1	\$ 350
 <p>Extron Plate (Single Space) — 1 VGA</p>	HTPLATEVGA	1	0.1	\$ 125
 <p>Extron Plate (Single Space) — 1 HDMI</p>	HTPLATEHD	1	0.1	\$ 185
 <p>Extron Plate (Double Space) — 4 USB</p>	HTPLATEUSB4	1	0.1	\$ 550

How to specify	<p>Select Model Number from above</p> <p>H T V P R E S .</p>	<p>1st Option</p> <p>Select Veneer</p> <p>See page 680</p> <p>D </p>
----------------	---	--

- ▶ Tops are available in eight shapes: Racetrack (A), Boat (B), Rectangle (C), Arc End (E), Peninsula (F), Soft Wedge (G), Round (D), Square (S). Replace the (?) shown in each model with A, B, C, E, F, G, D or S to specify shape. Tops with traditional (T) edge available in rectangle, round and square shapes only.
- ▶ See base options on pages 700-703.
- ▶ Tops 96" and greater, in woodgrain colors, will not have exact grain alignment in the center where the two halves meet, a reasonable match can be expected.
- ▶ Tops greater than 96" ship in multiple pieces to facilitate handling and installation. For details see page 683.
- ▶ Tops with E, G, V, H, K and T edge details feature durable laminate tops over solid core high-performance particleboard. Tops with J edge feature an MDF core.
- ▶ Laminate tops with traditional (T) edge feature high gloss laminate and wood edge to coordinate with 94000 Series Desks.
- ▶ Table tops sit 29 1/2" above floor with glide half way seated.
- ▶ Laminate tops are available in seven different edge details. Specify E, G, V, H, K and J as the first option after the base model. For laminate tops with traditional (T) edge, specify "T" in the base model. See specifying information below.
- ▶ E, G, V, J, T edge details feature 1 1/8" edge thickness. H, K edge details feature 1 1/2" thick top.
- ▶ Tops with E and V edge detail have 3" radius corners. All other edge details have 90 degree corners.
- ▶ Optional cutouts are available to accommodate power ports. One centered cutout per top section. Power ports must be ordered separately. For power port specification details see page 697.
- ▶ See page 687 for number of cutouts for each table top size.
- ▶ Underside of tops feature alignment guide for base placement.
- ▶ Single and two-piece tops ship in one carton, three piece tops ship in two cartons.

▲ **Tops with traditional edge available in Mahogany only.**
 ▲ **3-piece or more tops will not contain any grain match.**

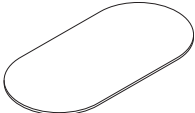

Description	Model	Ship Weight	Cube	List by Edge Treatment								L2 Upcharge	
				"E"	"G"	"V"	"B"	"H"	"K"	"J"	"T"		
Laminate Boat, Racetrack, Rectangle and Arc End Shaped Tops													
	240"W x 54"D	HTL(?)54240 E ◆	425	25.1	N/A	\$2546	\$2827	\$2827	\$3102	\$3455	\$4351	N/A	\$ 125
	216"W x 54"D	HTL(?)54216 E ◆	384	23.3	N/A	\$2221	\$2445	\$2445	\$2632	\$2920	\$3695	N/A	\$ 110
	192"W x 54"D	HTL(?)54192 E ◆	345	21.4	N/A	\$2070	\$2285	\$2285	\$2470	\$2767	\$3511	N/A	\$ 100
	180"W x 54"D	HTL(?)54180 E ◆	442	21.4	N/A	\$2070	\$2285	\$2285	\$2470	\$2767	\$3511	N/A	\$ 100
	168"W x 54"D	HTL(?)54168 E ◆	300	13.5	\$1573	\$1721	\$1916	\$1916	\$2097	\$2336	\$2840	N/A	\$ 85
	144"W x 54"D	HTL(?)54144 E ◆	259	11.6	\$1283	\$1396	\$1534	\$1534	\$1627	\$1801	\$2184	N/A	\$ 65
	120"W x 54"D	HTL(?)54120 E ◆	220	9.8	\$1140	\$1245	\$1374	\$1374	\$1465	\$1648	\$2000	N/A	\$ 60
	108"W x 54"D	HTL(?)54108 E ◆	324	9.8	\$1140	\$1245	\$1374	\$1374	\$1465	\$1648	\$2000	N/A	\$ 60
	240"W x 48"D	HTL(?)48240 E ◆	392	21.9	N/A	\$2066	\$2292	\$2292	\$2516	\$2801	\$3532	N/A	\$ 100
	216"W x 48"D	HTL(?)48216 E ◆	351	19.7	N/A	\$1805	\$1987	\$1987	\$2141	\$2374	\$3011	N/A	\$ 90
	192"W x 48"D	HTL(?)48192 E ◆	312	18.1	N/A	\$1686	\$1860	\$1860	\$2012	\$2251	\$2863	N/A	\$ 85
	180"W x 48"D	HTL(?)48180 E ◆	300	18.6	N/A	\$1686	\$1860	\$1860	\$2012	\$2251	\$2863	N/A	\$ 85
	168"W x 48"D	HTL(?)48168 E ◆	281	12.1	\$1258	\$1378	\$1533	\$1533	\$1678	\$1869	\$2271	\$3502	\$ 70
	144"W x 48"D	HTL(?)48144 E ◆	240	9.8	\$1027	\$1117	\$1228	\$1228	\$1303	\$1442	\$1750	\$3040	\$ 55
	120"W x 48"D	HTL(?)48120 E ◆	201	8.2	\$ 913	\$ 998	\$1101	\$1101	\$1174	\$1319	\$1602	\$2462	\$ 50
	108"W x 48"D	HTL(?)48108 E ◆	203	9.8	\$ 913	\$ 998	\$1101	\$1101	\$1174	\$1319	\$1602	N/A	\$ 50
	96"W x 48"D	HTL(?)4896 E ◆	153	13.2	\$ 774	\$ 805	\$ 900	\$ 900	\$ 955	\$1051	\$1274	\$1899	\$ 50
	84"W x 42"D	HTL(?)4284 E ◆	157	12.1	\$ 774	\$ 805	\$ 900	\$ 900	\$ 955	\$1051	\$1274	N/A	\$ 40
	72"W x 36"D	HTL(?)3672 E ◆	90	7.9	\$ 515	\$ 569	\$ 633	\$ 633	\$ 712	\$ 802	\$ 976	\$ 989	\$ 30
	60"W x 30"D	HTL(?)3060 E ◆	63	5.6	\$ 406	\$ 449	\$ 499	\$ 499	\$ 555	\$ 617	\$ 785	N/A	\$ 20

A = Racetrack
 Not available in "T" edge option

B = Boat
 Not available in "T" edge option

C = Rectangle

E = Arc End

M = Mid-section Adder

Laminate Adder Section for Boat, Racetrack, Rectangle and Arc Shaped Tops

72"W x 54"D	HTLM5472 E ◆	125	11.6	N/A	\$ 825	\$ 911	\$ 911	\$1005	\$1119	\$1511	N/A	\$ 40
72"W x 48"D	HTLM4872 E ◆	111	9.8	N/A	\$ 688	\$ 759	\$ 759	\$ 838	\$ 932	\$1261	N/A	\$ 35

▲ **Adder section cannot be used as standalone table. Only long edges are finished.**

How to specify	1st Option	2nd Option	3rd Option
Select Model Number with Traditional Edge	Select Edge Color See page 681	Select Cutout Option N No Cutout G1 Cutout for Pop-up Port (\$40 upcharge per cutout) G2 Cutout for Flip-top Port (\$50 upcharge per cutout) Grommet Cutouts cannot be specified for Round or Square tops	Select Laminate See page 680
H T L C 3 6 7 2 T .	N .	G 2 .	N

How to specify	1st Option	2nd Option	3rd Option
Select Model Number from above	Select Edge Detail and Edge Color See pages 681-682	Select Cutout Option N No Cutout G1 Cutout for Pop-up Port (\$40 upcharge per cutout) G2 Cutout for Flip-top Port (\$50 upcharge per cutout) Flip-top Port cannot be specified for Round or Square tops	Select Laminate See page 680
H T L C 3 0 6 0 .	J C .	G 2 .	D

- ▶ See base options on pages 700-703.
- ▶ Tops 96" and greater, in woodgrain colors, will not have exact grain alignment in the center where the two halves meet, a reasonable match can be expected.
- ▶ Tops greater than 96" ship in multiple pieces to facilitate handling and installation. For details see page 683.
- ▶ Tops with E, G, V, H, K and T edge details feature durable laminate tops over solid core high-performance particleboard. Tops with J edge feature an MDF core.
- ▶ Laminate tops with traditional (T) edge feature high gloss laminate and wood edge to coordinate with 94000 Series Desks.
- ▶ Table tops sit 29½" above floor with glide half way seated.
- ▶ Laminate tops are available in seven different edge details. Specify E, G, V, H, K and J as the first option after the base model. For laminate tops with traditional (T) edge, specify "T" in the base model. See specifying information below.
- ▶ E, G, V, J and T edge details feature 1½" edge thickness. H, K edge details feature 1½" thick top.
- ▶ Tops with E and V edge detail have 3" radius corners. All other edge details have 90 degree corners.
- ▶ Optional cutouts are available to accommodate power ports. One centered cutout per top section. Power ports must be ordered separately. For power port specification details see page 697.
- ▶ See page 687 for number of cutouts for each table top size.
- ▶ Underside of tops feature alignment guide for base placement.
- ▶ Single and two-piece tops ship in one carton, three piece tops ship in two cartons.

▲ **Tops with traditional edge available in Mahogany only.**

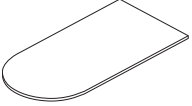

Description	Model	Ship		List by Edge Treatment									L2 Upcharge
		Weight	Cube	"E"	"G"	"V"	"B"	"H"	"K"	"J"	"T"		
Laminate Peninsula Table Tops													
	96"W x 48"D	HTLF4896 E♦A	149	13.2	\$ 774	\$ 805	\$ 900	\$ 900	\$ 955	\$1051	\$1274	N/A	\$ 40
	84"W x 42"D	HTLF4284 E♦A	152	12.1	\$ 774	\$ 805	\$ 900	\$ 900	\$ 955	\$1051	\$1274	N/A	\$ 40
	72"W x 36"D	HTLF3672 E♦A	66	7.9	\$ 515	\$ 569	\$ 633	\$ 633	\$ 712	\$ 802	\$ 976	N/A	\$ 30
	60"W x 30"D	HTLF3060 E♦A	46	5.6	\$ 406	\$ 449	\$ 499	\$ 499	\$ 555	\$ 617	\$ 785	N/A	\$ 20

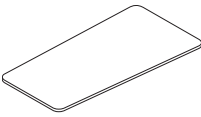
Description	Model	Ship Weight		Cube	List by Edge Treatment									L2 Upcharge
		Round	Square		"E"	"G"	"V"	"B"	"H"	"K"	"J"	"T"		
Laminate Soft Wedge Table Tops														
	96"W x 48"D	HTLG4896 E♦A	149	13.2	\$ 774	\$ 805	\$ 900	\$ 900	\$ 955	\$1051	\$1274	N/A	\$ 40	
	84"W x 42"D	HTLG4284 E♦A	139	12.1	\$ 774	\$ 805	\$ 900	\$ 900	\$ 955	\$1051	\$1274	N/A	\$ 40	
	72"W x 36"D	HTLG3672 E♦A	66	7.9	\$ 515	\$ 569	\$ 633	\$ 633	\$ 712	\$ 802	\$ 976	N/A	\$ 30	
	60"W x 30"D	HTLG3060 E♦A	46	5.6	\$ 406	\$ 449	\$ 499	\$ 499	\$ 555	\$ 617	\$ 785	N/A	\$ 20	

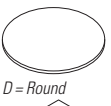
Description	Model	Ship Weight		Cube	List by Edge Treatment									L2 Upcharge
		Round	Square		"E"	"G"	"V"	"B"	"H"	"K"	"J"	"T"		
Laminate Round and Square Shaped Tops														
 D = Round S = Square	48" Top	HTL(?)48	66	76	6.3	\$ 441	\$ 481	\$ 528	\$ 528	\$ 627	\$ 678	\$ 826	\$ 899	\$ 25
	42" Top	HTL(?)42	51	61	4.9	\$ 392	\$ 435	\$ 480	\$ 480	\$ 583	\$ 633	\$ 771	\$ 786	\$ 20
	36" Top	HTL(?)36	36	46	3.7	\$ 343	\$ 402	\$ 432	\$ 432	\$ 503	\$ 541	\$ 658	\$ 709	\$ 20

NOTES: Tops are available in two shapes: Round (D) and Square (S). Replace the (?) shown in each model with D or S to specify shape.

How to specify	1st Option	2nd Option	3rd Option
Select Model Number from above	Select Edge Detail and Edge Color See pages 681-682	Select Cutout Option	Select Laminate
H T L F 4 8 9 6 .	J C .	N No Cutout G1 Cutout for Pop-up Port (\$40 upcharge per cutout) G2 Cutout for Flip-top Port (\$50 upcharge per cutout) Flip-top Port cannot be specified for Round or Square tops G 2 .	See page 680 D

Preside® Laminate Tables — Bases

GSA SIN 711-11



- ▶ Tops and bases are sold and shipped separately.
 - ▶ All bases allow table tops to sit 29 1/2" above floor with leveling glides half-way seated.
 - ▶ Bases ship with appropriate number of supports for table width. See page 686 for details.
 - ▶ Laminate panel bases feature sturdy 1 1/8" thick x 12"H particleboard support beam in matching finish. Support beam ships with tops on 60" and 72"W tables and with the base on tables 96"W and greater.
 - ▶ Traditional panel base for 168"W Top includes two traditional panels and one standard panel.
 - ▶ For Base and Top compatibility, see base information on pages 683-686.
 - ▶ Aluminum T-legs for tops 96"W and greater feature dual aluminum support beams with integrated wire management. Aluminum T-legs for 60" and 72" tops do not include aluminum beams.
 - ▶ Efficient design of Aluminum T-leg maximizes leg space. The T-leg features a removable door for wire access.
- △ Traditional style bases available in Mahogany (N) only.



Description	Panels Included Per Kit	Model	Ship Weight	Cube	List Price by Laminate Grade	
					L1	L2
Laminate Panel Base for Tops 60" or Wider						
For 240"W Table Tops	4	HTLP240	197	16.4	\$1255	\$1315
For 216"W Table Tops	3	HTLP216	158	12.4	\$ 960	\$1005
For 192"W Table Tops	3	HTLP192	147	11.6	\$ 960	\$1005
For 180"W Table Tops	3	HTLP180	147	11.6	\$ 960	\$1005
For 168"W Table Tops	3	HTLP168	136	10.6	\$ 838	\$ 878
For 144"W Table Tops	2	HTLP144	97	6.6	\$ 543	\$ 573
For 120"W Table Tops	2	HTLP120	86	5.8	\$ 543	\$ 573
For 108"W Table Tops	2	HTLP108	86	5.8	\$ 543	\$ 573
For 96"W Table Tops	2	HTLP96	75	4.9	\$ 543	\$ 573
For 84"W Table Tops	2	HTLP84	75	5.0	\$ 543	\$ 573
For 72"W Table Tops	2	HTLP72	25	2.9	\$ 510	\$ 535
For 60"W Table Tops	2	HTLP60	25	2.9	\$ 510	\$ 535
For 72" Adder Section	1	HTLPM	61	5.8	\$ 417	\$ 437
Laminate Traditional Panel Base for Tops 72" or Wider						
For 168"W Table Tops	3	HTLT168	145	12.1	\$1047	N/A
For 144"W Table Tops	2	HTLT144	106	8.2	\$ 752	N/A
For 120"W Table Tops	2	HTLT120	95	7.3	\$ 752	N/A
For 96"W Table Tops	2	HTLT96	62	4.6	\$ 752	N/A
For 72"W Table Tops	2	HTLT72	84	6.5	\$ 689	N/A
Aluminum T-Leg for Tops 60" or Wider						
For 240"W Table Tops	4	HTTLEG240 E ◆A	76	8.9	\$1723	N/A
For 216"W Table Tops	3	HTTLEG216 E ◆A	65	8.6	\$1374	N/A
For 192"W Table Tops	3	HTTLEG192 E ◆A	63	8.4	\$1313	N/A
For 180"W Table Tops	3	HTTLEG180	63	8.4	\$1313	N/A
For 168"W Table Tops	3	HTTLEG168 E ◆A	54	8.2	\$1231	N/A
For 144"W Table Tops	2	HTTLEG144 E ◆A	39	4.5	\$ 863	N/A
For 120"W Table Tops	2	HTTLEG120 E ◆A	37	4.3	\$ 802	N/A
For 108"W Table Tops	2	HTTLEG108	37	4.2	\$ 802	N/A
For 96"W Table Tops	2	HTTLEG96 E ◆A	31	4.0	\$ 740	N/A
For 84"W Table Tops	2	HTTLEG84	31	4.0	\$ 740	N/A
For 72"W Table Tops	2	HTTLEG72 E ◆A	26	3.5	\$ 571	N/A
For 60"W Table Tops	2	HTTLEG60 E ◆A	22	3.5	\$ 571	N/A
For 72" Adder Section	1	HTTLEGM E ◆A	26	4.2	\$ 511	N/A

How to specify	<p>Select Model Number from above</p> <p>H T L P 2 4 0 .</p> <p>H T T L E G 2 4 0 .</p>	1st Option	<p>Select Laminate</p> <p>See page 680</p> <p>D </p> <p>Select Paint Color</p> <p>See page 680</p> <p>P Black WHIT Brilliant White (\$20 for bases with 1 or 2 supports, \$40 for bases with 3 or 4 supports)</p> <p>S Charcoal T4 Champagne (\$20 for bases with 1 or 2 supports, \$40 for bases with 3 or 4 supports)</p> <p> T1 Platinum (\$20 for bases with 1 or 2 supports, \$40 for bases with 3 or 4 supports)</p> <p>T 4 </p>
----------------	---	------------	--

- ▶ Tops and bases are sold and shipped separately.
- ▶ Bases ship with appropriate number of supports for table width. See page 686 for details.
- ▶ Standing-height Cube Bases are 39"H.
- ▶ For Base and Top compatibility, see base information on pages 683-686.
- ▶ Cube base requires 150 pounds of sand or other ballast in each base for stability (customer to supply).
- ▶ Laminate cube bases for tops 120"W and greater feature dual aluminum support beams with integrated wire management.
- ▶ Laminate Hollow Panel and aluminum T-legs for tops 96"W and greater feature dual aluminum support beams with integrated wire management.
- ▶ End caps for Hollow Panel bases can be matched to wood grain finishes or specified in select solid colors.
- ▶ Cube bases feature removable door to allow access to cables and enable wire routing.
- ▶ Standing Height Bases feature a hinged door for easy access and for cable routing through the base.

▲ **Standing Height Cube bases do not require any additional ballast.**

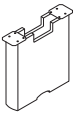
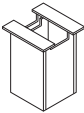
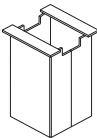

Description	Panels Included Per Kit	Model	Ship Weight	Cube	List Price by Laminate Grade	
					L1	L2
 <p>Laminate Hollow Panel Base for Tops 84" or Wider</p> <p>For 240"W Table Tops</p> <p>For 216"W Table Tops</p> <p>For 192"W Table Tops</p> <p>For 180"W Table Tops</p> <p>For 168"W Table Tops</p> <p>For 144"W Table Tops</p> <p>For 120"W Table Tops</p> <p>For 108"W Table Tops</p> <p>For 96"W Table Tops</p> <p>For 84"W Table Tops</p>	3	HTLHP240	206	17.5	\$2756	\$2911
	3	HTLHP216	204	17.3	\$2683	\$2838
	3	HTLHP192	202	17.1	\$2622	\$2747
	3	HTLHP180	202	17.1	\$2622	\$2747
	3	HTLHP168	193	16.9	\$2540	\$2665
	2	HTLHP144	133	11.4	\$1742	\$1827
	2	HTLHP120	131	11.2	\$1681	\$1761
	2	HTLHP108	131	11.2	\$1681	\$1761
	2	HTLHP96	125	11.0	\$1619	\$1699
	2	HTLHP84	125	11.0	\$1619	\$1699
	For 72" Adder Section	1	HTLHPM	71	5.9	\$ 941
 <p>Laminate Cube Base for Tops 84" or Wider</p> <p>For 240"W Table Tops</p> <p>For 216"W Table Tops</p> <p>For 192"W Table Tops</p> <p>For 180"W Table Tops</p> <p>For 168"W Table Tops</p> <p>For 144"W Table Tops</p> <p>For 120"W Table Tops</p> <p>For 108"W Table Tops</p> <p>For 96"W Table Tops</p> <p>For 84"W Table Tops</p>	3	HTLCUBE240	278	29.2	\$3302	\$3462
	3	HTLCUBE216	276	29.0	\$3229	\$3389
	3	HTLCUBE192	274	28.8	\$3168	\$3323
	3	HTLCUBE180	274	28.8	\$3168	\$3323
	2	HTLCUBE168	183	19.4	\$2179	\$2284
	2	HTLCUBE144	181	19.2	\$2106	\$2206
	2	HTLCUBE120	179	19.0	\$2045	\$2145
	2	HTLCUBE108	179	19.0	\$2045	\$2145
	2	HTLCUBE96	164	18.2	\$1814	\$1904
	2	HTLCUBE84	164	18.2	\$1814	\$1904
	For 72" Adder Section	1	HTLCUBEM	95	9.8	\$1123
 <p>Laminate Standing Height Cube Base for Tops 48" or Wider</p> <p>For 240"W Table Tops</p> <p>For 216"W Table Tops</p> <p>For 192"W Table Tops</p> <p>For 180"W Table Tops</p> <p>For 168"W Table Tops</p> <p>For 144"W Table Tops</p> <p>For 120"W Table Tops</p> <p>For 108"W Table Tops</p> <p>For 96"W Table Tops</p> <p>For 48"W Table Tops</p>	3	HTLCUBES240	302	45.7	\$3995	\$4195
	3	HTLCUBES216	300	45.5	\$3922	\$4122
	3	HTLCUBES192	298	45.3	\$3861	\$4061
	3	HTLCUBES180	298	45.3	\$3861	\$4061
	2	HTLCUBES168	199	30.4	\$2641	\$2766
	2	HTLCUBES144	197	30.2	\$2568	\$2693
	2	HTLCUBES120	195	30.0	\$2507	\$2632
	2	HTLCUBES108	195	30.0	\$2507	\$2632
	2	HTLCUBES96	180	29.2	\$2276	\$2386
	1	HTLCUBES48	90	14.6	\$1138	\$1193
	For 72" Adder	1	HTLCUBESM	103	15.3	\$1354

How to specify	1st Option	2nd Option																
<p>Select Model Number from above</p> <p>H T L H P 2 4 0 .</p>	<p>Select Laminate</p> <p>See page 680</p> <p>D .</p>	<p>Select Endcap/Inlay Option</p> <p>(specified for Hollow Panel Bases only)</p> <table border="0"> <tr> <td>H Bourbon Cherry</td> <td>P Black</td> </tr> <tr> <td>COGN Cognac</td> <td>WHIT Brilliant White</td> </tr> <tr> <td>C Harvest</td> <td>S Charcoal</td> </tr> <tr> <td>N Mahogany</td> <td>LOFT Loft</td> </tr> <tr> <td>MOCH Mocha</td> <td>T4 Champagne</td> </tr> <tr> <td>D Natural Maple</td> <td>T1 Platinum</td> </tr> <tr> <td>PINC Pinnacle</td> <td></td> </tr> <tr> <td>F Shaker Cherry</td> <td></td> </tr> </table> <p>H </p>	H Bourbon Cherry	P Black	COGN Cognac	WHIT Brilliant White	C Harvest	S Charcoal	N Mahogany	LOFT Loft	MOCH Mocha	T4 Champagne	D Natural Maple	T1 Platinum	PINC Pinnacle		F Shaker Cherry	
H Bourbon Cherry	P Black																	
COGN Cognac	WHIT Brilliant White																	
C Harvest	S Charcoal																	
N Mahogany	LOFT Loft																	
MOCH Mocha	T4 Champagne																	
D Natural Maple	T1 Platinum																	
PINC Pinnacle																		
F Shaker Cherry																		



Preside® Laminate Tables — Bases

GSA SIN 711-11



- ▶ Tops and bases are sold and shipped separately.
- ▶ Bases ship with appropriate number of supports for table width. See page 686 for details.
- ▶ For Base and Top compatibility, see base information on pages 683-686.
- ▶ Cylinder base requires 150 pounds of sand or other ballast in each base for stability (customer to supply).
- ▶ Cylinder bases facilitate wire management with integrated wire channel and plinth.
- ▶ Laminate cylinder bases for tops 120"W and greater feature dual aluminum support beams with integrated wire management.
- ▶ Laminate Cylinder Bases with Wire Management include a unique design that allows cords to be routed through the base with easy access to electrical outlets.

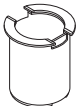

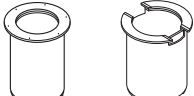
Description	Panels Included Per Kit	Model	Ship		List Price by Laminate Grade		
			Weight	Cube	L1	L2	
 Laminate Cylinder Base for Tops 84" or Wider	For 240"W Table Tops	3	HTLR240	191	51.9	\$2672	\$2797
	For 216"W Table Tops	3	HTLR216	189	51.7	\$2599	\$2754
	For 192"W Table Tops	3	HTLR192	187	51.5	\$2538	\$2663
	For 180"W Table Tops	3	HTLR180	187	51.5	\$2538	\$2663
	For 168"W Table Tops	2	HTLR168	125	34.5	\$1759	\$1844
	For 144"W Table Tops	2	HTLR144	123	34.3	\$1686	\$1766
	For 120"W Table Tops	2	HTLR120	121	34.1	\$1625	\$1705
	For 108"W Table Tops	2	HTLR108	121	34.1	\$1597	\$1677
	For 96"W Table Tops	2	HTLR96	106	33.3	\$1394	\$1459
	For 84"W Table Tops	2	HTLR84	106	33.3	\$1394	\$1459
	For 72" Adder Section	1	HTLRM	66	17.4	\$ 913	\$ 958
 Laminate Cylinder Base with Wire Management for Tops 84" or Wider	For 240"W Table Tops	3	HTLRC240	191	51.9	\$3479	\$3604
	For 216"W Table Tops	3	HTLRC216	189	51.7	\$3406	\$3531
	For 192"W Table Tops	3	HTLRC192	187	51.4	\$3345	\$3470
	For 180"W Table Tops	3	HTLRC180	187	51.4	\$3345	\$3470
	For 168"W Table Tops	2	HTLRC168	125	34.5	\$2297	\$2382
	For 144"W Table Tops	2	HTLRC144	123	34.3	\$2224	\$2304
	For 120"W Table Tops	2	HTLRC120	121	34.1	\$2163	\$2243
	For 108"W Table Tops	2	HTLRC108	121	34.1	\$2163	\$2243
	For 96"W Table Tops	2	HTLRC96	106	33.3	\$1932	\$1997
	For 84"W Table Tops	2	HTLRC84	106	33.3	\$1932	\$1997
	For 48"W Table Tops	1	HTLRC48	53	16.7	\$ 966	\$1011
For 72" Adder	1	HTLRCM	66	17.4	\$1182	\$1227	
 Laminate Cylinder Base for Round and Square Tops	For 48" Tops	1	HTLR48	53	16.7	\$ 697	\$ 732
	For 42" Tops	1	HTLR42	42	11.6	\$ 630	\$ 660
	For 36" Tops	1	HTLR36	42	11.6	\$ 630	\$ 660

Used with 36" and 42" table tops



Used with 48" table tops

How to specify	<p>Select Model Number from above</p> <p>H T L R 2 4 0 .</p>	<p>1st Option</p> <p>Select Laminate</p> <p>See page 680</p> <p>D</p>
----------------	--	---

Icon Legend on page 10

- ▶ Tops and bases are sold and shipped separately.
- ▶ For Base and Top compatibility, see base information on pages 683-686.
- ▶ All bases allow table tops to sit 29½" above floor with leveling glides half-way retracted.
- ▶ Cube base requires 150 pounds of sand or other ballast in each base for stability (customer to supply).
- ▶ Cube base features removable door for wire management.
- ▶ The X-leg allows wires to pass through the center of the leg.

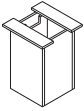
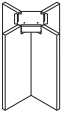

Description	Bases Included Per Kit	Model	Ship Weight	Cube	List Price by Laminate Grade	
					L1	L2
 Laminate Cube Base for Round and Square Tops For 48" Tops	1	HTLCUBE48	82	9.1	\$ 907	\$ 952
 Laminate Panel X-Base for Round and Square Tops For 48" Tops	1	HTLXP48 E♦A	54	5.2	\$ 403	\$ 423
For 42" Tops	1	HTLXP42 E♦A	54	5.2	\$ 403	\$ 423
For 36" Tops	1	HTLXP36 E♦A	47	4.7	\$ 375	\$ 395
 Traditional X-Base for Round and Square Tops Can be used with 36", 42" and 48" Round Tops and 36" and 42" Square Tops. Not compatible with cutouts or power ports. NOTES: Available in Mahogany (N) Veneer only.	1	H94011 E♦A	40	5.4	\$ 611	N/A

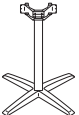
Description	Bases Included Per Kit	Model	Ship Weight	Cube	List
 Standing Height Aluminum X-Leg Base for 36" and 42" Round and Square Tops <i>Specify paint</i>	1	HTXLEGSH E♦A	17	3.5	\$ 540

How to specify	<p>Select Model Number from above</p> <p>H T L C U B E 4 8 .</p> <p>H T X L E G .</p>	<p>1st Option</p> <p>Select Laminate See page 680 D </p> <p>Select Paint Color See page 680</p> <p>P Black WHIT Brilliant White (\$20 for bases with 1 or 2 supports, \$40 for bases with 3 or 4 supports) S Charcoal T4 Champagne (\$20 for bases with 1 or 2 supports, \$40 for bases with 3 or 4 supports) T1 Platinum (\$20 for bases with 1 or 2 supports, \$40 for bases with 3 or 4 supports)</p> <p>T 4 </p>
----------------	---	---

Preside® Collaborative Tables

Not on GSA Contract



- ▶ All tops are HPL.
- ▶ Bases and modesty panels are TFL.
- ▶ 2MM edgeband on tops.
- ▶ Table with partial modesty panels include 2 modesty panels.
- ▶ Tables can be specified with multiple laminate options.
- ▶ Bases with wire management are HPL.
- ⚠ Tables with modesty panels can be powered, but wire management is not available in the base.

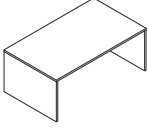
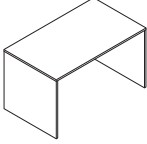
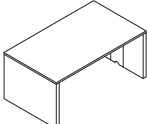
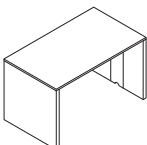

	Description	Model	Ship Weight	Cube	List
 Open Market	Seated-Height, Collaborative Table with Partial Modesty Panel 42"W x 72"L 42"W x 96"L	HTLC4272LCTP E⬢A	167	14.5	\$1250
		HTLC4296LCTP E⬢A	122	18.3	\$1542
 Open Market	Cafe-Height, Collaborative Table with Partial Modesty Panel 42"W x 72"L 42"W x 96"L	HTLC4272HCTP E⬢A	187	15.7	\$1400
		HTLC4296HCTP E⬢A	242	19.4	\$1692
 Open Market	Seated-Height, Collaborative Table with Full Modesty Panel 42"W x 72"L 42"W x 96"L	HTLC4272LCTFP E⬢A	175	14.9	\$1250
		HTLC4296LCTFP E⬢A	233	18.8	\$1542
 Open Market	Cafe-Height, Collaborative Table with Full Modesty Panel 42"W x 72"L 42"W x 96"L	HTLC4272HCTFP E⬢A	211	17.9	\$1400
		HTLC4296HCTFP E⬢A	275	22.4	\$1692
 Open Market	Seated-Height, Powered Collaborative Table with Power Management 42"W x 72"L 42"W x 96"L NOTES: Wire management available underneath top and through the base. Bases include a removable door to access cords at any time.	HTLC4272LCTHP E⬢A	196	13.6	\$1501
		HTLC4296LCTHP E⬢A	244	16.0	\$1793
 Open Market	Cafe-Height, Powered Collaborative Table with Power Management 42"W x 72"L 42"W x 96"L NOTES: Wire management available underneath top and through the base. Bases include a removable door to access cords at any time.	HTLC4272HCTHP E⬢A	236	15.8	\$1801
		HTLC4296HCTHP E⬢A	284	18.3	\$2093

How to specify	1st Option	2nd Option	3rd Option	4th Option	5th Option
Select Model Number from above H T L C 4 2 7 2 L C T P .	Select Cutout Option N No Cutout G1 Cutout for Pop-up Port (\$40 upcharge) G2 Cutout for Flip-top Port (\$50 upcharge)	Select Top Laminate Color See page 680 L2 Upcharge \$30	Select Base Laminate Color See page 680 L2 Upcharge \$30	Select Modesty Laminate Color See page 680 Do not specify for models HTLC4272LCTHP, HTLC4296LCTHP, HTLC4272HCTHP, and HTLC4296HCTHP L2 Upcharge \$30	Select 2MM Edge Color See page 681
	N .	H .	H .	W H I T .	H

E⬢A Icon Legend on page 10

- ▶ Supports optional veneer Hospitality Shelf.
- ▶ Can support mini fridges with maximum measurements of 19"W x 19"D x 32"H.
- ▶ Worksurface sits at buffet height for easy reach.
- ▶ Includes ventilation cutouts in back.
- ▶ Can accommodate optional trash bin and AV rack accessories.
- ▶ Laminate shelf can be added as an accessory to the outer credenza compartments.

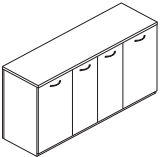

Description	Model	Ship Weight	Cube	List Price by Laminate Grade	
				L1	L2
 <p>72" Laminate Hospitality Credenza</p> <ul style="list-style-type: none"> Overall cabinet dimensions 72"W x 20"D x 36"H. Features four doors and two hidden drawers. 	HTLCREDA	301	37.0	\$2588	\$2662

SIN 711-2

 <p>57" Laminate Hospitality Credenza</p> <ul style="list-style-type: none"> 3 doors and 1 hidden drawer. 	HTLCREDB E♦A	250	29.3	\$2250	\$2350
--	---------------------	-----	------	--------	--------

Open Market

How to specify	1st Option	2nd Option	3rd Option	4th Option
Select Model Number from above H T L C R E D A .	Select Edge Detail and Color G Flat Edge K Ribbon Edge V Tri-Oval Edge G D .	Select Top Laminate See page 680 D .	Select Chassis Laminate See page 680 D .	Select Handle J Loop Satin Nickel G Loop Black 3 Rounded Square Matte Chrome 4 Rounded Square Black J

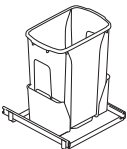
Description	Model	Ship Weight	Cube	L1 List	L2 Upcharge
 <p>Trash Bin Slide</p> <ul style="list-style-type: none"> Holds a 35 quart bin. Trash bin is included with model. Can be used in outer compartments of HTLCREDA. 	HTBINSLIDE	15	3.5	\$ 189	N/A

SIN 711-11

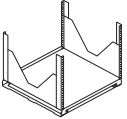
 <p>Mounted AV Rack</p> <ul style="list-style-type: none"> Can be used in outer compartments of HTLCREDA. 	HTRACK	15	4.8	\$1689	N/A
--	---------------	----	-----	--------	-----

SIN 711-11

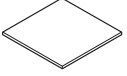
 <p>Laminate Credenza Shelf</p> <ul style="list-style-type: none"> Shelf can be utilized in the outer compartments of the credenza. Shelf is available in laminate only. 3 mounting locations within outer compartment on the credenza. Mounting locations are 8" apart. 	HTLSHELF	10 S	1.5	\$ 62	\$ 10
--	-----------------	-------------	-----	-------	-------

SIN 711-2

How to specify	1st Option	2nd Option
Select Model Number from above H T B I N S L I D E .	Select Laminate See page 680 H .	Select Handle J Loop Satin Nickel G Loop Black G

► Use Concinnity™ laminate tops and backs with Preside® modular storage for a finished look. See page 707.

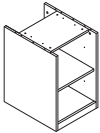
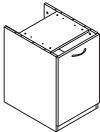
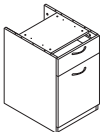

	Description	Model	Ship Weight	Cube	List Price by Laminate Grade	
					L1	L2
 <p>Open Market</p> <p>Model HTLMC18280 shown</p>	Modular Pedestal, Bookshelf, No Door	HTLMC18280 E♦A	70	9.8	\$ 501	\$ 526
 <p>Open Market</p> <p>Model HTLMC1828L shown</p>	Modular Pedestal, Bookshelf, with Door (left)	HTLMC1828L E♦A	70	9.8	\$ 611	\$ 641
	Modular Pedestal, Bookshelf, with Door (right)	HTLMC1828R E♦A	70	9.8	\$ 611	\$ 641
 <p>Open Market</p> <p>Model HTLMC1828DR shown</p>	Modular Pedestal, Box Drawer, Cabinet Door (left)	HTLMC1828DL E♦A	70	9.8	\$ 650	\$ 680
	Modular Pedestal, Box Drawer, Cabinet Door (right)	HTLMC1828DR E♦A	70	9.8	\$ 650	\$ 680

How to specify	1st Option	2nd Option
<p>Select Model Number from above</p> <p>H T L M C 1 8 2 8 L .</p>	<p>Select Pull Option</p> <ul style="list-style-type: none"> J Loop Satin Handle G Loop Back 3 Rounded Square Matte Chrome 4 Rounded Square Black X No Pull (for model HTLMC18280 only) <p>J .</p>	<p>Select Laminate</p> <p>See page 680</p> <p>N</p>

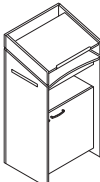
	Description	Model	Ship Weight	Cube	List Price by Laminate Grade	
					L1	L2
 <p>SIN 711-2</p>	<p>Laminate Lectern</p> <ul style="list-style-type: none"> • Overall cabinet dimensions 24"W x 18"D x 50"H. • Adjustable top worksurface features 3 tilt positions. • Top of lectern can be removed and used on table top. • Laptop shelf slides left or right. • Includes 2 locking and 2 non-locking casters. • Includes adjustable shelf in storage compartment. • Features scallops in rear of lectern to route and conceal cables and wires. • Metal components standard in black finish. 	HTLLECTA	132	15.6	\$1376	\$1441

How to specify	1st Option	2nd Option
<p>Select Model Number from above</p> <p>H T L L E C T A .</p>	<p>Select Laminate</p> <p>See page 680</p> <p>H .</p>	<p>Select Handle</p> <ul style="list-style-type: none"> J Loop Satin Nickel G Loop Black <p>G</p>

E♦A Icon Legend on page 10

► Use Concinnity™ laminate tops and backs with Preside® modular storage for a finished look.

△ **Grain direction on all rectangle worksurfaces runs horizontal (side-to-side) except as follows: 30"W - 36"W - 42"W - 48"W - 54"W - 60"W x 24"D tops can be specified with horizontal (side-to-side) or vertical (front-to-back) grain.**

△ **42"W and 48"W x 20"D tops are available with vertical (front-to-back) grain only.**



Description	Model	Ship Weight	Cube	List Price by Laminate Grade	
				L1	L2
 Concinnity™ Rectangle Worksurface with Horizontal Grain 90"W x 24"D 72"W x 24"D 54"W x 24"D	HNLRC2490	75	5.5	\$ 454	\$ 484
	HNLRC2472	60	4.6	\$ 319	\$ 339
	HNLRC2454	45	3.5	\$ 259	\$ 279
36"W x 24"D Rectangle Worksurface/Pedestal Top	HNLRC2436	30	2.4	\$ 199	\$ 214

How to specify	1st Option	2nd Option	3rd Option
Select Model Number from above H N L R C 2 4 9 0 . B H .	Select Edge Profile and Edge Color See page 51 B H .	Select Worksurface Grommet Finish P Black T1 Platinum X No Grommet P .	Select Worksurface Color See page 51 H

► Provide approach-side kneespace privacy for user seated at desks, credenzas, returns, and bridges.



Description	Model	Ship Weight	Cube	List Price by Laminate Grade	
				L1	L2
 Concinnity™ Modesty/Back Panels — Full Length 90"W x 27 1/8"H 72"W x 27 1/8"H 54"W x 27 1/8"H	HNLMP9028	58	6.7	\$ 379	\$ 404
	HNLMP7228	46	5.3	\$ 257	\$ 277
	HNLMP5428	34	4.0	\$ 211	\$ 231
36"W x 27 1/8"H Modesty/Pedestal Back Panel	HNLMP3628	22	2.8	\$ 169	\$ 181

NOTES: Component is 3/4" thick.

How to specify	1st Option	2nd Option
Select Model Number from above H N L M P 7 2 2 8 .	Select Grommet P Black X No Grommet X .	Select Laminate Color See page 51 H

  Icon Legend on page 10

Wall Mount Storage

Not on GSA Contract



- ▶ Preside® tables pair well with Concinnity™ Wall Mounted Storage to create a complete conference or collaborative layout.
- ▶ Convenient off-the-worksurface storage requires no additional floor space.
- ▶ Available with laminate doors, frosted/silver doors, or sliding door.
- ▶ Doors are sized to overlap the top, end panels and light valance, to provide a clean design.
- ▶ Laminate and frosted/silver door units are equipped with self-closing, adjustable hinges.
- ▶ Laminate hinged door units are available with or without a lock.
- ▶ For tackboards, see page 78.
- ▶ For task lights, see page 117.
- ▶ For paper organizers, see page 114.
- ▶ **IMPORTANT: See installation guidelines at top of page 74.**

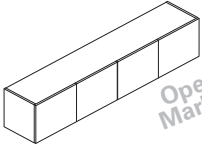
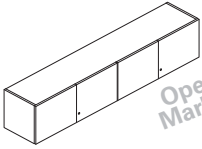
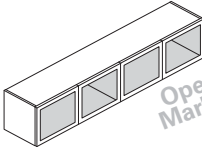
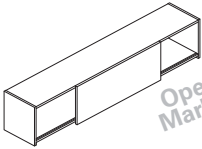

Description	Model	Ship Weight	Cube	L1 List	L2 Upcharges	
					Chassis	Fronts
 <p>Concinnity™ Wall Mount Storage, Laminate Doors</p> <p>78"W x 15"D x 15"H — 4 doors, 2 compartments</p> <p>72"W x 15"D x 15"H — 4 doors, 2 compartments</p> <p>66"W x 15"D x 15"H — 4 doors, 2 compartments</p> <p>60"W x 15"D x 15"H — 4 doors, 2 compartments</p> <p>48"W x 15"D x 15"H — 3 doors, 2 compartments</p> <p>42"W x 15"D x 15"H — 2 doors, 1 compartment</p> <p>36"W x 15"D x 15"H — 2 doors, 1 compartment</p> <p>30"W x 15"D x 15"H — 2 doors, 1 compartment</p>	HNL1578LD	126	17.1	\$1129	\$ 35	\$ 20
	HNL1572LD	118	15.9	\$1049	\$ 25	\$ 20
	HNL1566LD	109	14.6	\$ 999	\$ 25	\$ 20
	HNL1560LD	100	13.3	\$ 897	\$ 25	\$ 20
	HNL1548LD	83	10.9	\$ 809	\$ 20	\$ 15
	HNL1542LD	68	9.7	\$ 764	\$ 20	\$ 10
	HNL1536LD	60	8.4	\$ 697	\$ 20	\$ 10
	HNL1530LD	51	7.2	\$ 644	\$ 20	\$ 10
 <p>Concinnity™ Wall Mount Storage, Laminate Locking Doors</p> <p>78"W x 15"D x 15"H — 4 doors, 2 compartments</p> <p>72"W x 15"D x 15"H — 4 doors, 2 compartments</p> <p>66"W x 15"D x 15"H — 4 doors, 2 compartments</p> <p>60"W x 15"D x 15"H — 4 doors, 2 compartments</p> <p>48"W x 15"D x 15"H — 3 doors, 2 compartments</p> <p>42"W x 15"D x 15"H — 2 doors, 1 compartment</p> <p>36"W x 15"D x 15"H — 2 doors, 1 compartment</p> <p>30"W x 15"D x 15"H — 2 doors, 1 compartment</p> <p>⚠ Lock available in Black (P) or Satin (SA) finish. Lock is core removable. Keyed alike cores must be ordered separately. For stack-on and wall mount storage with locking hinged doors, specify model HF27B (Black) or HF27S (Satin) and the key number, see page 116. Model HNL1548LL has one lock, which secures two of the three doors.</p>	HNL1578LL	126	17.1	\$1209	\$ 35	\$ 20
	HNL1572LL	118	15.9	\$1129	\$ 25	\$ 20
	HNL1566LL	109	14.6	\$1079	\$ 25	\$ 20
	HNL1560LL	100	13.3	\$ 977	\$ 25	\$ 20
	HNL1548LL	83	10.9	\$ 849	\$ 20	\$ 15
	HNL1542LL	68	9.7	\$ 804	\$ 20	\$ 10
	HNL1536LL	60	8.4	\$ 737	\$ 20	\$ 10
	HNL1530LL	51	7.2	\$ 684	\$ 20	\$ 10
 <p>Concinnity™ Wall Mount Storage, Frosted Doors with Silver Frame</p> <p>78"W x 15"D x 15"H — 4 doors, 2 compartments</p> <p>72"W x 15"D x 15"H — 4 doors, 2 compartments</p> <p>66"W x 15"D x 15"H — 4 doors, 2 compartments</p> <p>60"W x 15"D x 15"H — 4 doors, 2 compartments</p> <p>48"W x 15"D x 15"H — 3 doors, 2 compartments</p> <p>42"W x 15"D x 15"H — 2 doors, 1 compartment</p> <p>36"W x 15"D x 15"H — 2 doors, 1 compartment</p> <p>30"W x 15"D x 15"H — 2 doors, 1 compartment</p> <p>⚠ Frosted door models do not have a lock option.</p>	HNL1578FD	106	17.1	\$1729	\$ 35	N/A
	HNL1572FD	99	15.9	\$1649	\$ 25	N/A
	HNL1566FD	92	14.6	\$1599	\$ 25	N/A
	HNL1560FD	85	13.3	\$1497	\$ 25	N/A
	HNL1548FD	71	10.9	\$1259	\$ 20	N/A
	HNL1542FD	57	9.7	\$1064	\$ 20	N/A
	HNL1536FD	50	8.4	\$ 997	\$ 20	N/A
	HNL1530FD	43	7.2	\$ 944	\$ 20	N/A
 <p>Concinnity™ Wall Mount Storage, Sliding Door</p> <p>78"W x 15"D x 15"H</p> <p>72"W x 15"D x 15"H</p> <p>66"W x 15"D x 15"H</p> <p>60"W x 15"D x 15"H</p> <p>48"W x 15"D x 15"H</p>	HNL1578SD	114	17.1	\$1099	\$ 35	\$ 20
	HNL1572SD	107	15.9	\$1009	\$ 25	\$ 20
	HNL1566SD	99	14.6	\$ 939	\$ 25	\$ 20
	HNL1560SD	91	13.3	\$ 854	\$ 25	\$ 20
	HNL1548SD	76	10.9	\$ 799	\$ 20	\$ 20

NOTES: One door per unit. Standard with black lock, which is located on the inside vertical support panel.

How to specify	Select Model Number from above H N L 1 5 7 8 L D .	1st Option Select Chassis Color See page 51 H .	2nd Option Select Door Front Color See page 51 H 	
How to specify	Select Model Number from above H N L 1 5 7 8 L L .	1st Option Select Lock Finish See page 51 P .	2nd Option Select Chassis Color See page 51 H .	3rd Option Select Door Front Color See page 51 H
How to specify	Select Model Number from above H N L 1 5 7 8 F D .	1st Option Select Chassis Color See page 51 H 		
How to specify	Select Model Number from above H N L 1 5 7 8 S D .	1st Option Select Chassis Color See page 51 H .	2nd Option Select Door Front Color See page 51 H 	

  Icon Legend on page 10

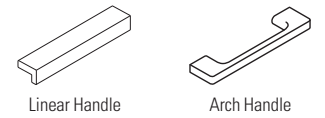

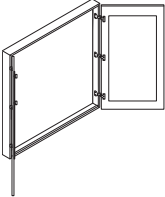
	Description	Model	Ship Weight	Cube	List Price by Laminate Grade	
					L1	L2
	Laminate Presentation Cabinet • Overall cabinet dimensions 48 1/8"W x 5"D x 49 1/2"H. • Mounts to wall. • Presentation cabinet features one magnetic white board, one tackboard and one paper pad. • Top quality markerboard designed with long lasting, non-ghosting surface. • Attractive doors enclose cabinet to provide a professional appearance and to ensure privacy. • Self-adjusting hinges ensure doors are in alignment.	HTLPRES	169	10.9	\$1509	\$1589
	How to specify Select Model Number from above H T L P R E S . D 1st Option Select Laminate See page 680					

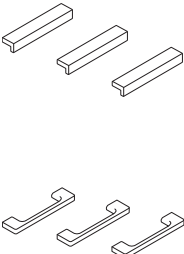
	Description	Model	Ship Weight	Cube	List
	Field Installable Drawer/Door Handle Kits Linear, Black, 1-pack Linear, Matte Chrome, 1-pack Linear, Black, 8-pack Linear, Matte Chrome, 8-pack Arch, Black, 1-pack Arch, Matte Chrome, 1-pack Arch, Black, 8-pack Arch, Matte Chrome, 8-pack	HLINEARA1 HLINEARC1 HLINEARA8 HLINEARC8 HARCHA1 HARCHC1 HARCHA8 HARCHC8	0.5 [S] 0.5 [S] 0.5 [S] 0.5 [S] 0.5 [S] 0.5 [S] 0.5 [S] 0.5 [S]	1.4 1.4 1.4 1.4 1.4 1.4 1.4 1.4	\$ 29 \$ 29 \$ 164 \$ 164 \$ 29 \$ 29 \$ 164 \$ 164
	How to specify Select Model Number from above H L I N E A R A 1 NOTES: Handles are for purchase and field installation and include hardware.				



	Description	Model	Ship Weight	Cube	List
How to specify Select Model Number from above H C T R O U G H 1 7 					

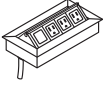
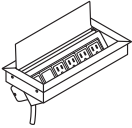

	Description	Model	Ship Weight	Cube	List
	Pop-up Port <ul style="list-style-type: none"> Fits into 4" x 8" cutout. Specify G1 cutout in table top. Pop-up Port provides three power ports and one blank data receptacle. Sits flush with worksurface when closed. Finish is anodized aluminum. Includes 6' cord with three-prong plug. 	HTPWGROM1	5.0	0.3	\$ 343
	Flip-top Port <ul style="list-style-type: none"> Fits into 5" x 11" cutout. Specify G2 cutout in table top. Flip-top Port provides four power ports and two blank data receptacles. Conceals wires and allows power cords to be plugged in while in use. Includes 6' cord with three-prong circuit breaker plug. <p>NOTES: Two circuit breaker plugs do not fit into one duplex.</p>	HTPWGROM2	5.0	0.3	\$ 496
	Flip-top Port <ul style="list-style-type: none"> Fits into 5" x 11" cutout. Specify G2 cutout in table top. Flip-top Port provides one VGA port, one HDMI port and four power ports. Conceals wires and allows power cords to be plugged in while in use. Includes 6' cord with three-prong circuit breaker plug. 	HTPWGROM3	5.0	0.3	\$ 777
	Flip-top Port <ul style="list-style-type: none"> Fits into 5" x 11" cutout. Specify G2 cutout in table top. Flip-top Port provides one blank Extron plate and three power ports. Extron AAP plates can be integrated into grommet to support changing technology. Conceals wires and allows power cords to be plugged in while in use. Includes 6' cord with three-prong circuit breaker plug. 	HTPWGROM4	5.0	0.3	\$ 608
	Flip-top Port <ul style="list-style-type: none"> Fits into 5" x 11" cutout. Specify G2 cutout in table top. Flip-top Port provides 3 Power, 1 USB, 2 Blank Data Ports and 1 Blank. Conceals wires and allows power cords to be plugged in while in use. Includes 6' cord with three-prong circuit breaker plug. 	HTPWGROM5	5.0	0.3	\$ 721

Hardwire Power System:

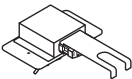
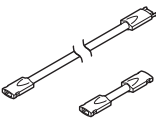
The hardwire power system is only needed if 6' power cables from power ports are not long enough to reach an outlet, or if there is a need to route power below entire length of worksurface from one power infeed. By specifying one power kit for each top section, there will be two duplex receptacles below each top section. For technical details regarding 2-circuit power system, see page 667.

	Power Entry Plate <ul style="list-style-type: none"> Connects to wall to route power to table. 	HMAPLATE	1.0	0.2	\$ 81
	Power Entry Cable <ul style="list-style-type: none"> 6' power entry cable with male/female adapter. Connects table to power entry plate. 	HMACABLE	1.8	0.2	\$ 127
	Circuit 1 Power Kit for 60"W Top Section Circuit 1 Power Kit for 72"W Top Section Circuit 1 Power Kit for 84"W Top Section Circuit 1 Power Kit for 96"W Top Section	HMAPOWER60 HMAPOWER72 HMAPOWER84 HMAPOWER96	2.0 2.2 2.4 2.6	0.3 0.3 0.3 0.3	\$ 245 \$ 250 \$ 260 \$ 268

How to specify



Select Model Number
from above

H T P W R G R O M 1

► 1 Double Space or 2 Single Space plates can be used in a single HTPWRGROM4 flip-top port.

⚠ Extron plates can be retrofitted to be used on HTPWRGROM4.

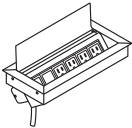
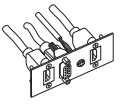
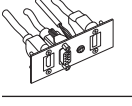
A_B

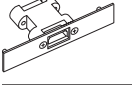
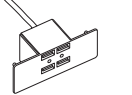
	Description	Model	Ship Weight	Cube	List
 <p>SIN 711-11</p>	Flip-top Port <ul style="list-style-type: none"> Fits into 5" x 11" cutout. Specify G2 cutout in table top. Flip-top Port provides one blank Extron plate and three power ports. Extron AAP plates can be integrated into grommet to support changing technology. Conceals wires and allows power cords to be plugged in while in use. Includes 6' cord with three-prong circuit breaker plug. 	HTPWRGROM4	5	0.3	\$ 608
 <p>Open Market</p>	Extron Plate (Double Space) — VGA, HDMI , HDMI, Audio	HTPLATEVHAU E⚡A	1	0.1	\$ 350
 <p>Open Market</p>	Extron Plate (Double Space) — DP, VGA, HDMI, Audio	HTPLATEDHAU E⚡A	1	0.1	\$ 350
 <p>Open Market</p>	Extron Plate (Single Space) — 1 VGA	HTPLATEVGA E⚡A	1	0.1	\$ 125
 <p>Open Market</p>	Extron Plate (Single Space) — 1 HDMI	HTPLATEHD E⚡A	1	0.1	\$ 185
 <p>Open Market</p>	Extron Plate (Double Space) — 4 USB	HTPLATEUSB4 E⚡A	1	0.1	\$ 550

How to specify

Select Model Number from above

H | T | P | W | R | G | R | O | M | 4

A_B ⚠ E⚡A Icon Legend on page 10

Preside® Laminate Tables

GSA SIN 711-11



- ▶ Tops and Modesty Panels are 1/8" Melamine.
- ▶ 168"W Boat-Shaped Top needs 3 bases; 72"W Middle Adder needs 1 base. All other tops need 2 bases.
- ▶ 120", 144", and 168"W Tops ship in 2 pieces to facilitate handling and installation; these top sizes will not have an exact grain alignment where the two halves meet, a reasonable match can be expected.
- ⚠ Available in Harvest (C) and Mahogany (N) finishes only.
- ⚠ Tops available in Boat Shape with G edge (2mm self edge) only; Middle Adder is rectangular with G edge.
- ⚠ Edge finish always matches top finish.

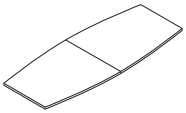
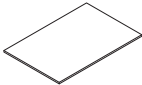

Description	Model	Ship Weight	Cube	List
 Laminate Boat Shaped Table Tops with Stretcher 168"W x 48"D 144"W x 48"D 120"W x 48"D	HTLB16848P	319	11.9	\$1326
	HTLB14448P	266	9.8	\$1054
	HTLB12048P	217	8.2	\$ 955
 Laminate Adder Section with Stretcher 72"W x 48"D	HTLM7248P	144	9.8	\$ 699
Laminate Bases Laminate Panel Bases, Double Pack Laminate Panel Bases, Single Pack	HTLPB HTLPBS	53 28	3.1 3.1	\$ 377 \$ 227

	With Panel Base
HTLB12048P HTLB14448P	1 x HTLPB (Laminate Panel Base)
HTLB16848P	1 x HTLPB (Laminate Panel Base) 1 x HTLPBS (Laminate Panel Mid-Base)
HTLM7248P	1 x HTLPBS (Laminate Panel Mid-Base)

Preside® Laminate Tables — Pre-defined Typicals

GSA SIN 711-11

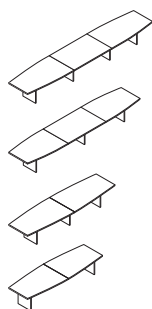

Boat Shape Laminate Tables with Panel Base
 240"W x 48"D
 216"W x 48"D
 192"W x 48"D
 168"W x 48"D
 144"W x 48"D
 120"W x 48"D

HTLB2048LP	572	31.0	\$2856
HTLB1848LP	491	25.9	\$2357
HTLB1648LP	442	24.3	\$2258
HTLB1448LP	400	18.1	\$1930
HTLB1248LP	319	12.9	\$1431
HTLB1048LP	270	11.3	\$1332

NOTES: Order entire typical with one model number to get desired table size. Table top and bases are included.

How to specify	1st Option	2nd Option
Select Model Number from above H T L B 1 6 8 4 8 P .	Select Grommet Option N No grommet (only option) N .	Select Laminate C Harvest N Mahogany C

Icon Legend on page 10

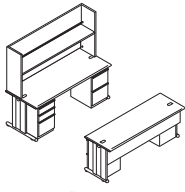

95 1/2" D 72" W



Edge Detail

- ▶ Tops are 1 1/8" thick, post-formed front and back with 3/16" full radius. Ends are self-edged.
- ▶ Specify laminate and paint.
- ▶ Two leveling glides per leg with 3/4" adjustability.
- ▶ Laminate tops have low-glare surfaces, radius edges, and black grommets for wire management.
- ▶ Wire management in C-legs is concealed.



Description	Model	Ship Weight	Cube	List by Paint Grade	
				Core	Metallics
<p>Desk 29 1/2" H 72"W x 29 1/2"D 66"W x 29 1/2"D 60"W x 29 1/2"D 48"W x 29 1/2"D 42"W x 29 1/2"D 36"W x 29 1/2"D</p>	H66591 E◆A	129	11.0	\$ 969	\$1043
	H66581 E◆A	122	10.1	\$ 942	\$1016
	H66571 E◆A	113	9.2	\$ 914	\$ 988
	H66551 E◆A	95	7.5	\$ 851	\$ 925
	H66531 E◆A	88	6.6	\$ 814	\$ 888
	H66541 E◆A	76	5.7	\$ 784	\$ 858
<p>Desk 29 1/2" H 72"W x 24"D 66"W x 24"D 60"W x 24"D 48"W x 24"D 42"W x 24"D 36"W x 24"D</p>	H66597 E◆A	116	9.1	\$ 936	\$1010
	H66582 E◆A	111	8.1	\$ 914	\$ 988
	H66577 E◆A	99	7.7	\$ 870	\$ 944
	H66557 E◆A	88	5.7	\$ 810	\$ 884
	H66537 E◆A	82	5.6	\$ 773	\$ 847
	H66547 E◆A	77	4.3	\$ 741	\$ 815



Corner Desk
 29 1/2" H with 24" sides
 29 1/2" H with 29 1/2" sides

H66280 E◆A	96	10.3	\$1169	\$1243
H66282 E◆A	104	12.3	\$1232	\$1306

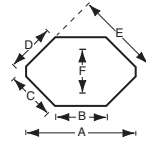

Chair Location

Dimensions for models with 24" sides:
 A=60" C=24" * E=43"
 B=27 1/4" D=27" F=36"
 (B=Leading Edge)

Dimensions for models with 29 1/2" sides:
 A=66" C=29 1/2" * E=49"
 B=27 3/4" D=21" F=36"
 (B=Leading Edge)

* Panel size for wrap-around application

NOTE: Additional accessories and design information on pages 295-296.

How to specify

1st Option	2nd Option	3rd Option
Select Model Number from above H 6 6 5 9 1 .	Select Grommet G Grommet (no upcharge) G .	Select Laminate See page 633 S .
		Select Paint See page 633 S

E◆A Icon Legend on page 10

Utility Tables

GSA SIN 711-2



- ▶ 1 1/2" thick top with self-edge.
 - ▶ Adjustable non-marring leveling floor glides.
 - ▶ 90-degree square corners.
 - ▶ Legs secured to top with steel corner brace.
- ⚠ 1 1/4" square Chrome or Black painted legs ONLY.





Description	Model	Ship Weight	Cube	List
Rectangle Shaped Utility Table — Metal 72"L x 18"W x 29"H	HUTM1872 E♦A	73 [S]	4.8	\$ 422
40"L x 20"W x 29"H	HUTM2040 E♦A	50 [S]	3.3	\$ 349
60"L x 20"W x 29"H	HUTM2060 E♦A	68 [S]	4.9	\$ 390
60"L x 24"W x 29"H	HUTM2460 E♦A	81 [S]	5.6	\$ 416
60"L x 30"W x 29"H	HUTM3060 E♦A	88	6.5	\$ 427
72"L x 30"W x 29"H	HUTM3072 E♦A	106	7.2	\$ 533
72"L x 36"W x 29"H	HUTM3672 E♦A	116	10.4	\$ 566

How to specify	1st Option	2nd Option	3rd Option
<p>Select Model Number from above</p> <p>H U T M 1 8 7 2 .</p>	<p>Select Laminate</p> <p>See page 633</p> <p>M O C H .</p>	<p>Select Paint Color</p> <p>See page 633</p> <p>P .</p>	<p>Select Leg Paint Color or Finish</p> <p>P Black CHR Chrome</p> <p>C H R </p>

ABJ Level E♦A [S] Icon Legend on page 10

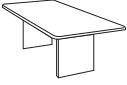
► Compatible with *basyx* by HON® BL Casegoods series. ► Tops and bases are packaged together. ► Durable, thermal-fused laminate is scratch- and spill-resistant.

	Description	Model	Ship		
			Weight	Cube	List
 Open Market	Rectangular Conference Table with Slab Base 72"L x 36"W	HBLC72R E ◆A	113	9.2	\$ 424
 Open Market	Round Conference Table with "X" Base 48" Dia.	HBLC48D E ◆A	120	7.9	\$ 349

How to specify	Select Model Number from above	1st Option
	H B L C 7 2 R .	Select Laminate A1A1 Medium Cherry NN Mahogany ESES Espresso A 1 A 1

► Coordinates with *basyx* by HON® BL Casegoods series. ► All models include top, slab base and stretcher rails. ► Order two end sections to create an 8' table. ► 2mm PVC edgebanding. ► Shapes include rectangle and boat. ► *basyx* by HON® 5-year Limited Warranty.

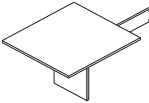
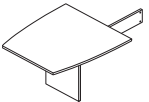
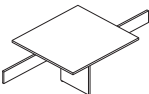
	Description	Model	Ship		
			Weight	Cube	List
 Open Market	Rectangle Table End Section 48"L x 44"W	HBLMT048R E ◆A	97	6.4	\$ 325
 Open Market	Boat Table End Section 48"L x 44"W	HBLMT048B E ◆A	96	6.4	\$ 325
 Open Market	Table Adder Section 48"L x 44"W NOTES: Adder Section expands tables in 48"L increments.	HBLMT048A E ◆A	97	6.4	\$ 340

How to specify	Select Model Number from above	1st Option
	H B L M T 4 8 R .	Select Laminate NN Mahogany A1A1 Medium Cherry ESES Espresso N N

BL Modular Conference Table Product Reference: Sizes, Sections, Seating Capacity

Feet	Inches	# of Sections	Seating Capacity
8	96	2	6-8
12	144	3	10-12
16	192	4	14-16
20	240	5	18-20
24	288	6	22-24

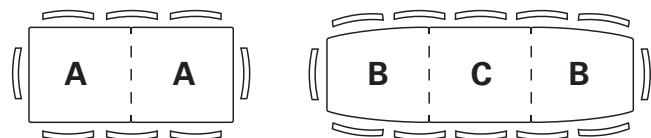

A – Rectangle Table End Section
B – Boat Table End Section
C – Table Adder Section

basyx by HON® Contemporary Occasional Tables

Not on GSA Contract



- ▶ Metal leg occasional tables available in Chestnut or Black laminate.
- ▶ Choose from Corner or Coffee Table options.
- ▶ Silver frame.

▶ **basyx by HON® 5-year Limited Warranty.**

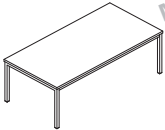

	Description	Model	Ship Weight	Cube	List
 Open Market	Laminated Corner Table 24"W x 24"D x 15½"H	HML8851 E♦A	24 S	1.7	\$ 153
 Open Market	Laminated Coffee Table 48"W x 24"D x 17½"H	HML8852 E♦A	38 S	3.1	\$ 194

How to specify	Select Model Number from above H M L 8 8 5 1 .	1st Option Select Laminate P Black C1 Chestnut P
----------------	---	---

basyx by HON® Laminate Occasional Tables

Not on GSA Contract

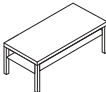
-  Square Edge Detail (Laminate)
- ▶ **basyx by HON® 5-year Limited Warranty.**
- ▶ Ideal for reception areas, lounges and offices.
- Laminate**
- ▶ Laminate tops have a hollow core honeycomb substructure, making them extremely light weight.
- ▶ 2" thick top.
- ▶ Sleek contemporary design.
- ▶ Black laminate finish only available on the BL Series Occasional Tables.

	Description	Model	Ship Weight	Cube	List
 Open Market	Coffee Table 42"L x 20"W x 16"H	HBLH3160 E♦A	24 S	3.0	\$ 241
 Open Market	Corner Table 24"L x 24"W x 20"H	HBLH3170 E♦A	9 S	1.7	\$ 188

How to specify	Select Model Number from above H B L H 3 1 6 0 .	1st Option Select Laminate ES Espresso N Mahogany P Black N
----------------	---	--

basyx by HON® Cantilever Tables

Not on GSA Contract

- ▶ Welded brackets increase overall strength.
- ▶ Single-piece, cross beam construction creates greater durability.
- ▶ Scratch-, spill- and stain-resistant laminate stands up to heavy use.

▶ **basyx by HON® 5-year Limited Warranty.**

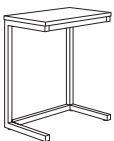
	Description	Model	Ship Weight	Cube	List
 Open Market	Cantilever Table 17½"W x 9⅞"D x 20¾"H	HML8858 E♦A	12.8 S	1.1	\$ 145

How to specify	Select Model Number from above H M L 8 8 5 8 .	1st Option Select Upholstery P Black C1 Chestnut WH Wheat P
----------------	---	--

E♦A S Icon Legend on page 10

- ▶ Choose from three widths and two base styles.
- ▶ All table tops 24"D.
- ▶ Table tops and bases ship in one box.
- ▶ Mesh Modesty Panels work with Multi-Purpose Table and Manage® Desk models.
- ▶ Ganging Hardware must be ordered and installed on tables when using 4-trac electrical systems.
- ▶ Ganging hardware attaches to underside of table in pre-drilled pilot holes.
- △ Modesty Panels available in Black Mesh fabric only.
- △ Table bases available in Black paint only.
- ▶ **basyx by HON® 5-year Limited Warranty.**

Description	Model	Ship Weight	Cube	List
 <p>Flip Base Table 72"W x 24"D 60"W x 24"D 48"W x 24"D</p> <p>△ Bases available in Black paint only, no need to specify.</p>	HBMP7224P E⬢A	100	8.9	\$ 668
	HBMP6024P E⬢A	88	7.5	\$ 630
	HBMP4824P E⬢A	76	6.7	\$ 596

 <p>Fixed Base Table 72"W x 24"D 60"W x 24"D 48"W x 24"D</p> <p>△ Bases available in Black paint only, no need to specify.</p>	HBMP7224X E⬢A	95	8.9	\$ 568
	HBMP6024X E⬢A	83	7.5	\$ 530
	HBMP4824X E⬢A	71	6.7	\$ 496

How to specify	1st Option
<p>Select Model Number from above</p> <p>H B M P T 7 2 2 4 P .</p>	<p>Select Laminate</p> <p>C1 Chestnut QZ Light Gray WH Wheat</p> <p>C 1 </p>

 <p>Mesh Modesty Panels 72"W 60"W 48"W</p> <p>△ Available in Black Mesh fabric only, specify .X.</p>	HBMP72MOD	4 [S]	0.3	\$ 140
	HBMP60MOD	3 [S]	0.3	\$ 124
	HBMP48MOD	2 [S]	0.2	\$ 113

 <p>Ganging Hardware</p> <ul style="list-style-type: none"> • Includes two ganging links and two screws • No color designator when specifying. <i>Example: HMAGANG.</i> 	HMAGANG	1 [S]	0.1	\$ 81
--	----------------	-------	-----	-------

basyx by HON® Height Adjustable Base

Not on GSA Contract



- ▶ Height Adjustable Base is a dual motor 2-stage column design.
- ▶ Frame rises from 28³/₄" to 48³/₄" for a sit-to-stand desk option.
- ▶ Height Adjustable Bases shipped complete with a preassembled motor.
- ▶ Base telescopes to accommodate any worksurface between 48"W and 72"W.
- ▶ Height Adjustable Base accommodates rectangular worksurfaces between 24"D x 48"W and 36"D x 72"W. Systems, Voi®, 10500, and Preside® all have worksurfaces within this range.

▶ **basyx by HON® 5-year Limited Warranty.**

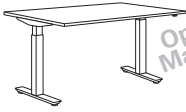
Description	Model	Ship Weight	Cube	List
 <p>Height Adjustable Base – 2 Stage 24"D Feet and Worksurface Brackets</p> <p>▲ Available in silver finish only. No specification needed.</p>	HBHAB2S24F E◆A	77	2.8	\$1100

Base shown with worksurface attached.

How to specify

Select Model Number from above

H | B | H | A | B | 2 | S | 2 | 4 | F

HON® Worksurfaces

GSA SIN 711-2

- ▶ Systems Rectangle Worksurfaces for Height Adjustable Bases designed for use in panel systems. Worksurface is 2" shorter in width and 3/4" shorter in depth to provide clearance between panels and other worksurfaces.
- ▶ Standard height-adjustable control ships with base.
- ▶ Dynamic load capacity when worksurface is moving is 250 lbs.

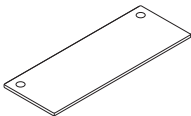
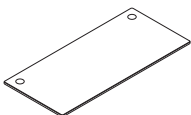
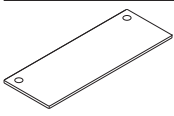

Description	Model	Ship Weight	Cube	List Price by Laminate Grade	
				L1	L2
 <p>Systems Rectangle Worksurfaces for Height Adjustable Bases</p> <p>46³/₄"W x 23¹/₄"D 52"W x 23¹/₄"D 58"W x 23¹/₄"D 64"W x 23¹/₄"D 70"W x 23¹/₄"D</p> <p>▲ Must be used as worksurfaces on Height Adjustable Bases within Panel Systems, as these are 1" shorter in width on each side to provide clearance between panels and other worksurfaces.</p> <p>▲ Available in all standard systems' laminate and edgebanding options. Only offered with grommets.</p> <p>Specify Model.LaminateColor.EdgeColor.GrommetColor SPECIFYING EXAMPLE: HHAW2448P.A5.K.T1</p>	<p>HHAW2448P HHAW2454P HHAW2460P HHAW2466P HHAW2472P</p>	<p>58 64 70 86 89</p>	<p>3.3 4.0 4.0 4.8 4.8</p>	<p>\$ 403 \$ 425 \$ 471 \$ 504 \$ 520</p>	<p>\$ 418 \$ 445 \$ 491 \$ 524 \$ 540</p>
 <p>Systems Rectangle Worksurfaces for Height Adjustable Bases</p> <p>46³/₄"W x 29¹/₄"D 52"W x 29¹/₄"D 58"W x 29¹/₄"D 64"W x 29¹/₄"D 70"W x 29¹/₄"D</p> <p>▲ Must be used as worksurfaces on Height Adjustable Bases within Panel Systems, as these are 1" shorter in width on each side to provide clearance between panels and other worksurfaces.</p> <p>▲ Available in all standard systems' laminate and edgebanding options. Only offered with grommets.</p> <p>Specify Model.LaminateColor.EdgeColor.GrommetColor SPECIFYING EXAMPLE: HHAW3048P.A5.K.T1</p>	<p>HHAW3048P HHAW3054P HHAW3060P HHAW3066P HHAW3072P</p>	<p>68 80 101 105 105</p>	<p>4.0 5.0 5.0 6.0 6.0</p>	<p>\$ 432 \$ 463 \$ 512 \$ 545 \$ 581</p>	<p>\$ 447 \$ 483 \$ 532 \$ 565 \$ 601</p>
 <p>Voi® Rectangle Worksurfaces for Height Adjustable Bases</p> <p>48"W x 24"D 54"W x 24"D 60"W x 24"D 66"W x 24"D 72"W x 24"D</p> <p>48"W x 30"D 54"W x 30"D 60"W x 30"D 66"W x 30"D 72"W x 30"D</p> <p>60"W x 36"D 66"W x 36"D 72"W x 36"D</p> <p>▲ For use with Height Adjustable Bases only in Freestanding Applications, which are applications where the tables/desks are not attached or adjacent to another unit, table/desk or systems panel. The widths are true to stated dimensions. If used with Panel Systems or other than in Freestanding Applications, worksurfaces will not provide proper clearance between panels or other worksurfaces, and may cause injury or worksurface damage (not covered by warranty).</p>	<p>HLSLR2448 HLSLR2454 HLSLR2460 HLSLR2466 HLSLR2472</p> <p>HLSLR3048 HLSLR3054 HLSLR3060 HLSLR3066 HLSLR3072</p> <p>HLSLR3660 HLSLR3666 HLSLR3672</p>	<p>61 68 75 82 89</p> <p>75 84 92 101 110</p> <p>110 120 130</p>	<p>3.4 4.2 4.2 5.0 5.0</p> <p>4.2 5.1 5.1 6.1 6.1</p> <p>6.1 7.2 7.2</p>	<p>\$ 264 \$ 284 \$ 309 \$ 336 \$ 347</p> <p>\$ 284 \$ 317 \$ 354 \$ 381 \$ 414</p> <p>\$ 444 \$ 480 \$ 539</p>	<p>\$ 279 \$ 304 \$ 329 \$ 356 \$ 367</p> <p>\$ 299 \$ 337 \$ 374 \$ 401 \$ 434</p> <p>\$ 469 \$ 505 \$ 564</p>

How to specify

<p>Select Model Number from above</p> <p>H H A W 2 4 7 2 P . A 5 .</p> <p>H L S L R 2 4 4 8 . N N .</p>	<p>1st Option</p> <p>Select Laminate</p> <p>See page 309</p>	<p>2nd Option</p> <p>Select Edge Color</p> <p>See page 309</p> <p>Specify for Systems Worksurfaces only</p>	<p>3rd Option</p> <p>Select Grommet Color</p> <p>See page 309</p> <p>Specify for Systems Worksurfaces only</p>	<p>4th Option</p> <p>Select Grommet Option and Color</p> <p>Specify for Voi® Worksurfaces only</p> <p>X No Grommet G Grommet</p> <p>If choosing the grommet option Select Grommet Color</p> <p>P Black Grommet WHIT Brilliant White Grommet T5 Greige Grommet T1 Platinum Grommet</p>
				<p>G T 5</p>

ABJ ▲ E◆A Icon Legend on page 10

	Page
CLASSROOM	
Student Desks/Seating	
SmartLink® Student Desks	730
SmartLink® Seating	733
Teacher/Administration Desks	
SmartLink® Teacher Stations	735
10700 Series™	248-270
10500 Series™	212-247
Mentor® Series Desks	285-286
38000 Series™	289-296
Seating	
SmartLink® Seating	733
Perpetual® Nesting	589
Olson Stacker® – 4040 Series High Density	583
Motivate® Seating	575-580
Volt® – 5700/5710/5720/5730 Series	607-610
ComforTask® – 5900 Series	530
7800 Series	612-613
Storage & Files	
SmartLink® Modular Storage	736-738
Brigade® Metal Overfiles	444
Brigade® 800 Series Lateral Files	437-438
Brigade® 700 Series Lateral Files	439-440
Brigade® 600 Series Lateral Files	441-442
Lateral File Accessories	481
310 Series Vertical Files – 26½”D	477
510 Series Vertical Files – 25”D	478
Flagship® Storage Cabinets and Bookcases	470
Brigade® Storage Cabinets	446
Brigade® Steel Bookcases	445
10500 Series™ Bookcases	483
1870/1890 Series Bookcases	484
Tables	
Huddle Multi-Purpose Tables	660-665
Motivate® Tables	670-675
66000 Series/The StationMaster®	713
Utility Tables	714
10500 Series™ Shared Components & Accessories	230-247
Learning Applications	
SmartLink® Wall Rail System	739-740

	Page
COMPUTER LAB	
Tables	
Huddle Multi-Purpose Tables	660-665
Motivate® Tables	670-675
66000 Series/The StationMaster®	713
Utility Tables	714
Seating	
Motivate® Seating	575-580
Perpetual® Nesting	589
CAFETERIA	
Seating	
SmartLink® Seating	733
Motivate® Seating	575-580
Olson Stacker® – 4040 Series High Density	583
Tables	
Cafeteria Tables	721-722
Hospitality Tables – Tops and Bases	655-657
STUDENT COMMONS	
Reception Seating	
Invitation® – 2110 Series	510
Cambia™ – 2150/2160 Series	506-507
Pagoda® – 4070/4090 Series	584-586
Invitation® Lounge	572
Flock® Lounge	541-543
Park Avenue Collection® Lounge Seating	587
Tables	
Huddle Multi-Purpose Tables	660-665
Motivate® Tables	670-675
Laminate Occasional Tables	669
10500 Series™ Shared Components & Accessories	230-247
LIBRARY / MEDIA CENTER	
Storage	
Flagship® Bookcases	470
Brigade® Steel Bookcases	445
SmartLink® Modular Storage	736-738
Reception Seating	
Invitation® – 2110 Series	510
Cambia™ – 2150/2160 Series	506-507
Pagoda® – 4070/4090 Series	584-586
Invitation® Lounge	572
Flock® Lounge	541-543
Park Avenue Collection® Lounge Seating	587
Student Seating	
SmartLink® Seating	733
Tables	
Huddle Multi-Purpose Tables	660-665
Motivate® Tables	670-675
Laminate Occasional Tables	669
10500 Series™ Shared Components & Accessories	230-247



	Page
ART ROOM	
Seating	
Motivate® Seating	575-580
Storage	
SmartLink® Modular Storage	736-738
Flagship® Storage Cabinets	470
Brigade® Storage Cabinets	446
Flagship® Bookcases	470
Brigade® Steel Bookcases	445
10500 Series™ Bookcases	483
1870/1890 Series Bookcases	484
Tables	
Huddle Multi-Purpose Tables	660-665
Motivate® Tables	670-675
Utility Tables	714
TEACHER PLANNING	
Desks	
SmartLink® Teacher Stations	735
Voi®	175-211
10700 Series™	248-270
10500 Series™	212-247
Mentor® Series Desks	285-286
38000 Series™	289-296
Seating	
Volt® – 5700/5710/5720/5730 Series	607-610
ComforTask® – 5900 Series	530
7800 Series	612-613
Storage	
SmartLink® Modular Storage	736-738
Flagship® Storage Cabinets	470
Brigade® Storage Cabinets	446
Flagship® Bookcases	470
Brigade® Steel Bookcases	445
10500 Series™ Bookcases	483
1870/1890 Series Bookcases	484
Tables	
Huddle Multi-Purpose Tables	660-665
Motivate® Adjustable Height Tables	673
Utility Tables	714

	Page
ADMINISTRATION	
Desks	
10700 Series™	248-270
10500 Series™	212-247
Mentor® Series Desks	285-286
38000 Series™	289-296
Reception Seating	
Invitation® – 2110 Series	510
Cambia™ – 2150/2160 Series	506-507
Pagoda® – 4070/4090 Series	584-586
Park Avenue Collection® Lounge Seating	587
Task / Administrative Seating	
Ignition® Series	566-571
Motivate® Series	575-580
Pillow-Soft® – 2190 Series	513
Volt® – 5700/5710/5720/5730 Series	607-610
ComforTask® – 5900 Series	530
7800 Series	612-613
Storage & Files	
SmartLink® Modular Storage	736-738
Flagship® Bookcases	470
Brigade® Metal Overfiles	444
Brigade® 800 Series Lateral Files	437-438
Brigade® 700 Series Lateral Files	439-440
Brigade® 600 Series Lateral Files	441-442
Lateral File Accessories	481
310 Series Vertical Files – 26½”D	477
510 Series Vertical Files – 25”D	478
Flagship® Storage Cabinets and Bookcases	470
Brigade® Storage Cabinets	446
Brigade® Steel Bookcases	445
10500 Series™ Bookcases	483
1870/1890 Series Bookcases	484
Tables	
Huddle Multi-Purpose Tables	660-665
Motivate® Adjustable Height Tables	673
Utility Tables	714
Occasional Tables	
Laminate Occasional Tables	669
10500 Series™ Shared Components & Accessories	230-247

- ▶ 5/8" thick laminate top and bench (where applicable).
- ▶ Width shown is the table top width only, not overall including seating.
- ▶ Benches are 10"D.
- ▶ All table tops and benches feature a permanent polyurea bonded edge. This sealed edge offers superior resistance to moisture and eliminates unsanitary food traps.
- ▶ Leg design allows table to be folded for compact storage.
- ▶ High strength steel frame with a durable powder-coated finish.
- ▶ Polyolefin wheel and non-marring casters.
- ▶ All tables are GREENGUARD Indoor Air Quality and GREENGUARD Children and Schools certified.
- ▶ Units ship blanket wrapped from the factory.

▲ Only Cafeteria Tables with Benches are UL Listed.

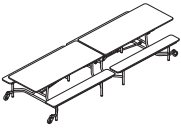

Description	Model	Ship Weight	Cube	List
 <p>Rectangular Bench Tables 145"L x 30"W x 29"H 145"L x 30"W x 27"H</p> <p>NOTES: Benches are 10"D. 4" diameter ball-bearing swivel casters. UL Listed. Folded rectangular tables with benches occupy an area 56"L x 34"W x 81"H. Seats 12–16 people.</p>	HB293012M D	305	80.6	\$3902
	HB273012M D	300	80.6	\$3902
 <p>Rectangular Tables without Benches 145"L x 30"W x 29"H 145"L x 30"W x 27"H</p> <p>NOTES: 4" diameter ball-bearing swivel casters. Folded rectangular tables without benches occupy an area 30"L x 22 1/4"W x 80 1/2"H. Seats 12–16 people.</p>	HR293012M D	185	33.8	\$2073
	HR273012M D	180	33.8	\$2073
 <p>Convertible Bench Tables 96"L x 29"H 96"L x 27"H</p> <p>NOTES: Bench is 10"D. 3" diameter ball-bearing swivel casters. UL Listed. Folded convertible bench tables occupy an area 96"L x 9"W x 32"H. Seats 5–6 people.</p>	HC291508M D	136	30.0	\$1886
	HC271508M D	131	30.0	\$1886

desks workstations storage & files seating tables education/learning accessories bundles index

How to specify	Select Model Number from above.	1st Option Select Table Laminate	2nd Option Select Bench Laminate	3rd Option Select Frame Color
Table Size		CC Harvest	CC Harvest	P Black
Table Height		DD Natural Maple	DD Natural Maple	
Table Type		G1 White	G1 White	
		Specify for models HB293012M, HB273012M, HC291508M and HC271508M only		
		C C .	C C .	P

Icon Legend on page 10 D Discontinued 3/1/2017.



Cafeteria Tables

Not on GSA Contract

- ▶ 5/8" thick laminate top and bench (where applicable).
- ▶ All table tops feature a permanent polyurea bonded edge. This sealed edge offers superior resistance to moisture and eliminates unsanitary food traps.
- ▶ Leg design allows table to be folded for compact storage.
- ▶ Units ship blanket wrapped from the factory.
- ▶ High strength steel frame with a durable powder-coated finish.
- ▶ All tables are GREENGUARD Indoor Air Quality and GREENGUARD Children and Schools certified.
- ▶ Width and diameter shown are for table top only, not overall including seating.

▲ **Only Cafeteria Tables with Stools are UL Listed.**

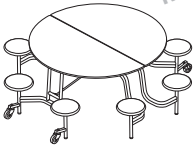

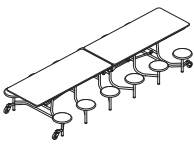
	Description	Model	Ship Weight	Cube	List
 <p>Open Market</p>	Round Tables with Stools				
	60" Diameter x 29"H	HRS2960M D	226	75.0	\$3847
	60" Diameter x 27"H	HRS2760M D	221	75.0	\$3847
	NOTES: 4" diameter ball-bearing swivel casters. Stools are 13" diameter polypropylene. UL Listed. Folded round tables with stools occupy an area 83"W x 34 1/4"D x 55 3/4"H. Seats 6-8 people.				
 <p>Open Market</p>	Round Tables without Stools				
	60" Diameter x 29"H	HRN2960M D	130	17.1	\$1596
	60" Diameter x 27"H	HRN2760M D	125	17.1	\$1596
	NOTES: Folded round tables without stools occupy an area 60"W x 18 1/2"D x 39 1/2"H. Seats 8-10 people.				
	48" Diameter x 29"H	HRN2948M D	100	17.1	\$1433
	48" Diameter x 27"H	HRN2748M D	95	17.1	\$1433
	NOTES: 4" diameter ball-bearing swivel casters. Folded round tables without stools occupy an area 48"W x 16 1/2"D x 37 1/2"H. Seats 6-8 people.				
 <p>Open Market</p>	Rectangular Tables with Stools				
	145"L x 30"W x 29"H	HS293012M D	259	69.9	\$3847
	145"L x 30"W x 27"H	HS273012M D	254	69.9	\$3847
	NOTES: 4" diameter ball-bearing swivel casters. Stools are 13" diameter polypropylene. UL Listed. Folded rectangular tables with stools occupy an area 59"W x 38 1/2"D x 80"H. Seats 12 people.				

If matching existing stools, please use the chart below for color cross-reference.

Previous plastic stool color:	Suggested replacement:
98 Green	99 Evergreen
11 Lava	14 Onyx
91 Navy	92 Indigo
40 Red	42 Ruby Red

How to specify	Select Model Number from above.	1st Option Select Table Laminate	2nd Option Select Stool Color	3rd Option Select Frame Color
Table Size	<div style="display: flex; justify-content: space-around; align-items: center;"> HRS2960M </div>	<div style="display: flex; justify-content: space-around; align-items: center;"> CC </div>	<div style="display: flex; justify-content: space-around; align-items: center;"> 99 </div> <p>Specify for models HRS2960M, HRS2760M, HS293012M and HS273012M only</p>	<div style="display: flex; justify-content: space-around; align-items: center;"> P </div>
Table Height				
Table Type				

Icon Legend on page 10 D Discontinued 3/1/2017.

		Teacher's Station Top/Base	Metal Surface and T-Mold Color	Modular Storage Top/Base	Metal Surface and T-Mold Color	Student Desk Tops	Student Desk Upper Leg	Wall Rail System Metal Accessories
PAINTED SURFACES	CODES							
Charcoal	S		•		•		•	
Platinum	T1		•		•		•	•
HARD PLASTIC	CODES							
Breeze	G9					•		
Harvest	CC					•		
Natural Maple	DD					•		
Sand	G8					•		
White	G1					•		
LAMINATES	CODES							
Harvest	CC	•		•		•		
Natural Maple	DD	•		•		•		
Sheer Mesh	A5	•		•		•		
Silver Mesh	B9	•		•		•		
T-MOLD	CODES							
Charcoal	S		•		•			
Platinum	T1		•		•			

STUDENT DESK

With the SmartLink® student desk's innovative shape, you can create dynamic learning environments and every space can be tailored to fit the lesson plan whether the need is for individual, student/group collaboration or teacher centered layouts. In addition to the desk's innovative top shape you can also select from three leg configurations to meet your specific needs for classroom or collaborative spaces.



Model: HLD-M3A
Adjustable Height
23"-33" Height Range



Model: HLD-M3F
Fixed Height
30" Fixed Height

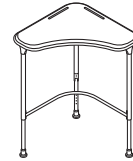

Model: HLD-M3T
Sit-to-Stand
30"-43" Height Range

HON STUDENT SEATING & DESKS
PRODUCT SELECTION GUIDELINES

		SmartLink			GRADE LEVEL								
	SEAT HEIGHT	DESK HEIGHT	Adjustable	Sit-to-Stand	Fixed	K-2		3-5		6-8		9 and above	
CHAIR	12"	22"											
	12"	23"	HM3A										
	12"	24"											
	14"	25"					SIT 22"-27"						
	14"	26"						SIT 23"-29"					
	14"	27"					STAND 24"-30"						
	16"-18"	28"									SIT 25"-30"		
16"-18"	29"											SIT 29"-30"	
	18"	30"			HM3F								
STOOL	22"	31"	HM3T										
	22"	32"											
	22"-23"	33"											
	23"-24"	34"											
	24"-25"	35"											
	25"-26"	36"											
	26"-27"	37"											
	27"-28"	38"											
	28"-29"	39"											
	29"-30"	40"											
	30"-31"	41"											
32"	42"												
32"	43"											STAND 38"-43"	

Desk height ranges for seated students at specified grade levels
 Desk height ranges for standing students at specified grade levels

Individual Layouts

- The non-handed top allows the desk to be positioned to better support right-handed or left-handed individuals or be used in a forward position.
- 30" distance between legs is wheelchair friendly.



LH Position

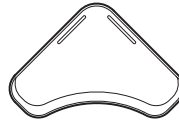

Forward Position



RH Position

Group/Collaborative Layouts

Below are examples of how the student desks can be configured to support multiple students or group activities.

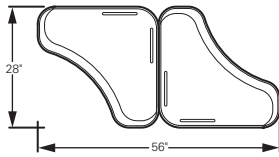

Student Desk
2-Desk Configuration

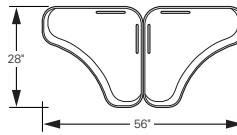

Opposing Student Desk
2-Desk Configuration

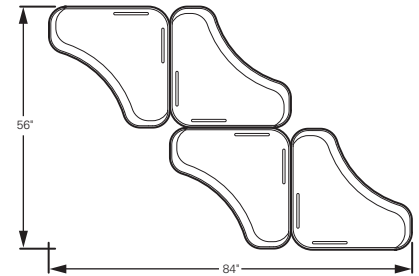

Student Desk
4-Desk Configuration

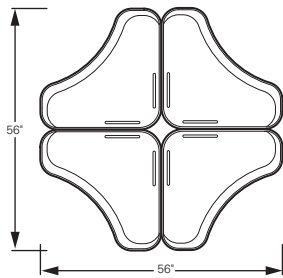

Student Desk
4-Desk Cluster Configuration

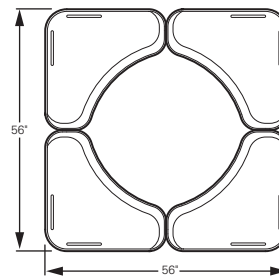

Student Desk
4-Desk Work Group Configuration
Can accommodate up to 8 students

Teacher Centered Layouts

- Reverse the layout and use the student desks instead of Build™ Tables to create layouts for teacher centers that can accommodate up to 6 students.
- 23⁵/₈" distance between legs when used from either side.

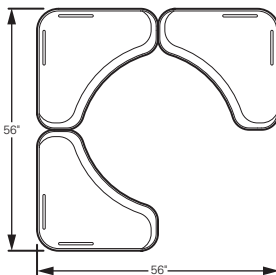

Teacher Centered Layout

Standard Row Layout

While a variety of classroom configurations are possible, a standard row layout shown below with 25 student desks utilizes a footprint of 199" deep by 284" wide. A 30 student desk row layout (5 rows deep by 6 rows wide) will require a footprint of 199" deep by 348" wide.

These dimensions are based upon 36"W aisles. Actual dimensions should be based upon local building codes.

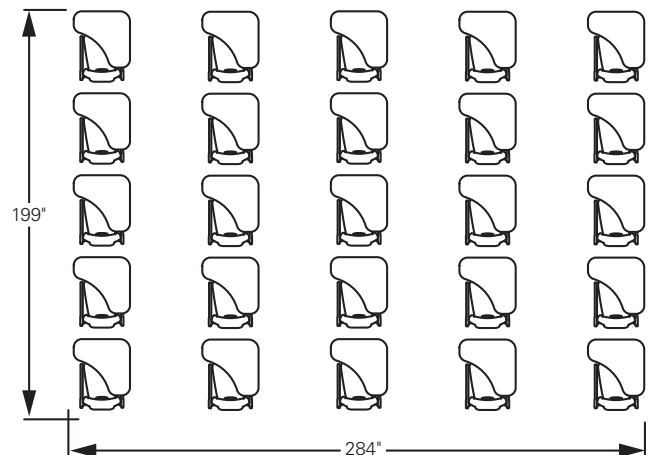

TEACHER STATION**SmartLink®**

The following planning and specifying information is intended to help you imagine and create stimulating SmartLink classrooms that can integrate technology while helping rooms stay adaptable, organized and attractive. With just four basic product categories, SmartLink offers you everything you need to create flexible, clutter-free learning environments for students of all ages.

Teacher stations are available in two sizes. Select from the standard double pedestal model (26 x 72) or the compact single pedestal model (24 x 60) based upon your specific storage, technology and space needs. A laminate top with a soft feel t-mold edge provides a classic look with exceptional durability.

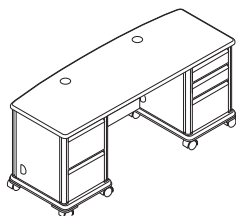
Teacher Station – Standard Double Pedestal

HLT2672-23.C

Storage

- Box/box/file pedestal is always standard on the right-hand side. Pedestal is locking.
- Available kneespace is 33¹/₄"W x 20"D for all models.
- Trays and 12"W shelves are specified and sold separately.
- Non-locking Center Drawer (HD8X) may be field installed in the kneespace. Tops are pre-drilled to accept the drawer.
- Center drawers and CPU holders cannot be installed together.

Cable Management

- Both the left-hand and right-hand end panels may be removed to provide access to power and cable management within the side power cabinet.
- Grommets are standard in each removable end panel allow a power cord to exit and be plugged into a floor or wall outlet.
- Two "Smart Grommets" with a wireway cover are standard on each station's top surface.

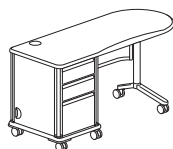
Teacher Station – Compact Single Pedestal

HLT2460-L3

Storage

- Single pedestal desk available in Left-hand or Right-hand pedestal/storage configurations.
- Pedestal options include Box/Box/File locking.

Cable Management

- The pedestals end panel may be removed to provide access to power and cable management within the side power cabinet.
- A grommet is standard in the removable end panel to allow a power cord to exit and be plugged into a floor or wall outlet.
- A single "Smart Grommet" with a wireway cover is standard on each station's top surface.

MODULAR STORAGE

SmartLink® Modular Storage is comprised of cases, accessories and support rails. However, only the cases and accessories need to be specified. The following guidelines should help you plan and specify SmartLink Storage.

Planning Notes

Cases

- A laminate top with a soft feel vinyl edge provides a classic look with exceptional durability.
- Storage cases do NOT include accessories. Accessories are specified and sold separately.
- Case configurations are based off of 12"W or 30"W columns.
- Internal case configurations cannot be changed (i.e., cannot change an HLSF52-3 to a HLSF52-21).
- Cases are designed to allow the users to create a variety of accessory configurations using different tray heights and shelves.
- Cases must be specified with or without locking doors.
- Door models may be converted to non-door models in the field.

Accessories

- Accessories include trays in 3", 6" and 12" heights, shelves in 12" and 30" widths and a 12"W coat rod.
- All accessories are sold and specified separately as kits and include 1 pair of storage rails per tray or shelf.
- The support rails simple "no tool" attachment method allows users to easily install and change rail (tray or shelf) positions as needed.
- Kits include:

Accessory	Quantity Per Kit	Where Used
3"H trays	7 trays / 14 support rails	12"W columns only
6"H trays	4 trays / 8 support rails	12"W columns only
12"H trays	2 trays / 4 support rails	12"W columns only
12"W shelf	2 shelves / 4 support rails	12"W columns only
30"W shelf	2 shelves / 4 support rails	30"W columns only
Coat Rod	1 coat rod	12"W columns — Full Height case only

- Cabinet Whiteboard Bracket kit is available which allows whiteboards to be mounted to the back of the full height cabinets. Kit includes upper and lower rails with integrated marker tray and attachment hardware. Use wall rail sliding whiteboards. Rails will accept one (1) 48" x 48" board or two (2) 24" x 48" boards.

Specification Notes

- Number of accessory openings

SmartLink storage cases are available in six (6) standard case types that feature combinations of 12" or 30" internal column widths. The following illustration shows the number of openings by column width for each case configuration.

Credenza Height Storage (30"H)

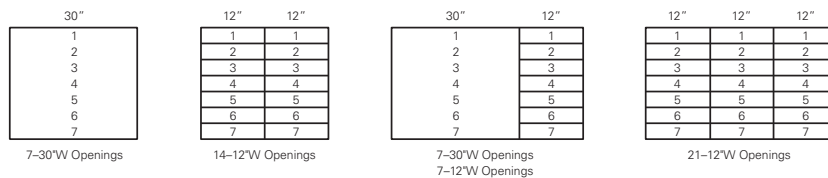

HLSC36-1

HLSC36-2

HLSC52-21

HLSC52-3

Full Height Storage (61 1/4"H)

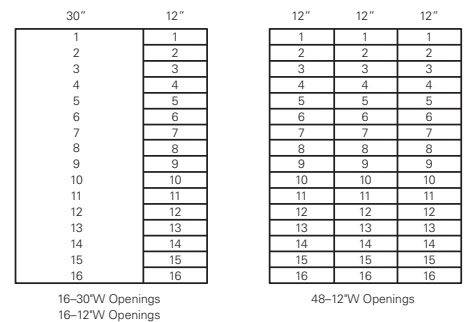

HLSF52-21

HLSF52-3

- Openings used by Accessory type:

Accessory	Openings used per Accessory
3"H tray	1
6"H tray	2
12"H tray	4
12"W shelf	1
30"W shelf	1

- Any combination of trays or shelves (of common width) can be used as long as the openings used equal the total number of openings available per column. The following illustrations show a variety of tray configuration options. Numbers shown in the opening refers to the tray size.

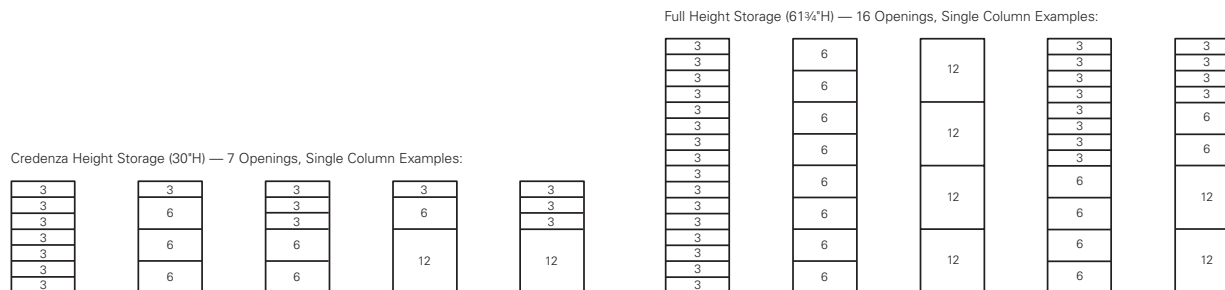

Using the information above, follow these guidelines to help determine accessory quantities.

- Determine the total number of available "openings" by width (12", 30") for each case type.
Example: HLSF52T-3F has 3 columns of 16 openings, total 48 openings
- On a PER COLUMN basis, determine the desired tray/self configurations total number of opening used so they equal the total openings available per column. Total accessory quantities per case then multiply by the total number of like cases.
Example: If each column will have 2-12" trays, 2-6" trays and 4-3" trays. The number of openings used for this column combination is 16. Assuming all three columns are the same total tray quantities for this case will be 12-3", 6-6" and 6-12".
- Once total tray and shelf quantities are determined, simply divide by the kit quantity to determine the number of kits required.
Example: 3" trays = $12 \div 7 = 2$ kits, 6" trays = $6 \div 4 = 2$ kits, 12" trays = $6 \div 2 = 3$ kits

• Shelf Spacing

The clearance between shelves is approximately 3¾" for every support rail that is not used between shelves. The following illustration shows the clearance between shelves when 0-4 support rail positions are not utilized.

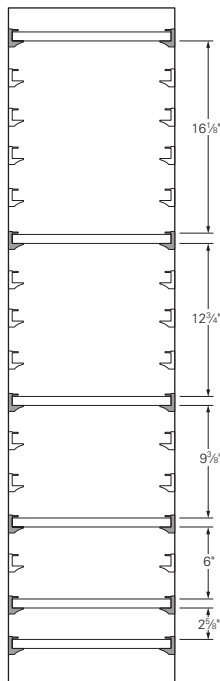

WALL RAIL SYSTEM

The SmartLink® wall rail is a multi-layered, multi-functional system that can accommodate a variety of presentation boards and accessories. The multiple tracks allow boards to be easily positioned and changed to support today's interactive learning environments.

Planning Notes

- Installation of the wall rail system over existing white or chalkboards is not recommended.
- The rail and wall bracket provide three separate tracks for the Learning boards. The REAR or wall/bracket track is occupied by the fixed wall board. The MIDDLE and FRONT tracks are for sliding boards.
- To allow for greater utilization of the rear fixed board a maximum width of 96" of sliding boards on the middle or front track is recommended.

The illustration below shows the overall wall space requirements for the rail system and recommended mounting height for use in K-12 classroom applications.

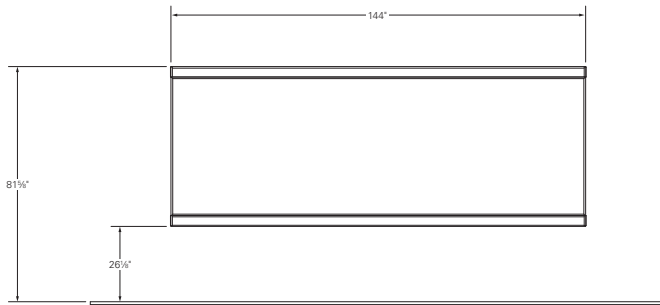

Sliding boards are removable and reversible so a wide variety of layouts are possible. The following illustrations highlight a couple of the more common applications. Layouts 2A and 2B provide the greatest amount of board space and overall flexibility. When used with rail mounted worksurfaces, use 24"W boards on the front rail as shown in 2C in front of each worksurface to provide information specific to that work area. Boards could then be added to the middle rail for information/work to be shared between the stations.

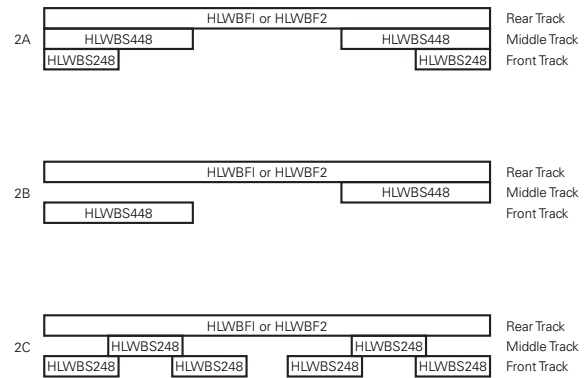



Specification Notes

- Boards are specified individually.
- Hardware to mount to the wall brackets is not provided by HON and MUST BE SOURCED LOCALLY.
- Learning board only applications require two (2) HLWR-12 rails to be specified.
- REFER TO PRODUCT INSTALLATION INSTRUCTIONS FOR DETAILED INSTALLATION INFORMATION.

- ▶ Laminate desk top constructed of 3/4" thick particleboard, high-pressure laminate top with SecurEdge for superior durability. Tamper and moisture resistant.
- ▶ Non-handed desk top constructed of 3/4" hard plastic, includes dual pencil grooves.
- ▶ Hard plastic top features comfort edge on user side and soft radius with rounded corners on all sides.
- ▶ Legs ship unattached for easy field installation on E♦A models.
- ▶ May also be specified to ship fully assembled, with or without HLDA-15 Book Box.
- ▶ Upper leg is painted, lower leg standard chrome finish on Adjustable and Sit-to-Stand models.
- ▶ Nylon swivel glides are standard on adjustable and fixed leg models.
- ▶ Hard plastic tops include pencil grooves. Laminate tops do not.
- ▶ All student desk models ship 2 per carton.
- ▶ Accepts optional felt glide caps (HGDK3-F) which are recommended for softer floors including VCT.
- ▶ Wheelchair friendly, 29.60" distance between legs on user side. Outside distance between legs is 23 3/8".
- ▶ Sit-to-Stand model features bell glides.
- ▶ Sit-to-Stand is height adjustable from 30"-43"H and includes a footrest.
- ▶ Accepts optional book basket (HLDA-15) and backpack hooks (HCLA65).

△ **Field installed felt glide caps (HGDK3-F) are recommended for use on VCT flooring.**

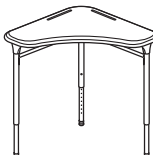

	Description	Model	Ship Weight	Cube	List
	Student Desk, Fixed Height 28"W x 28"W, User side 36 1/4"W 30" Fixed Height Hard Plastic Top Ships E♦A Ships Assembled Ships Assembled with HLDA-15 Book Box attached	HLD-M3F HLD-M3FA HLD-M3FB	63 58 65	5.5 17.9 17.9	\$ 654 \$ 689 \$ 797
	Laminate Top with SecurEdge Ships E♦A Ships Assembled Ships Assembled with HLDA-15 Book Box attached	HLD-L3F HLD-L3FA HLD-L3FB	63 58 65	5.5 17.9 17.9	\$ 586 \$ 621 \$ 729
		Student Desk, Adjustable Height 28"W x 28"W, User side 36 1/4"W Adjustable: 23"-33" height adjustment range. Legs ship pre-set for 30" overall desk height when factory installed. Hard Plastic Top Ships E♦A Ships Assembled Ships Assembled with HLDA-15 Book Box attached	HLD-M3A HLD-M3AA HLD-M3AB	63 ^S 58 65	5.5 17.9 17.9
	Laminate Top with SecurEdge Ships E♦A Ships Assembled Ships Assembled with HLDA-15 Book Box attached	HLD-L3A HLD-L3AA HLD-L3AB	63 58 65	5.5 17.9 17.9	\$ 586 \$ 621 \$ 729
	Student Desk, Sit-to-Stand 28"W x 28"W, User side 36 1/4"W Adjustable: 30"-43" height adjustment range Leg height is set during field installation. Hard Plastic Top Laminate Top, with SecurEdge	HLD-M3T E♦A HLD-L3T E♦A	65 65	5.5 5.5	\$ 930 \$ 862

All Student Desks are ordered and shipped two (2) desks per carton. Legs and cross-brace ship unattached on E♦A models. Pricing shown is per carton. Ordering two of model HLD-M3A, HLD-L3F or HLD-M3T will result in 2 cartons being shipped, giving you 4 desks.

How to specify		1st Option	2nd Option	3rd Option
Hard Plastic	Select Model Number from above H L D - M 3 A .	Select Glide Option E Hard Surface (no upcharge) (Fixed or Adjustable models only) G Bell Glide (Sit-to-stand model only) E .	Select Top Color G9 Breeze CC Harvest DD Natural Maple G8 Sand G1 White G 9 .	Select Upper Leg Color S Charcoal T1 Platinum S



How to specify		1st Option	2nd Option	3rd Option	4th Option
Laminate with SecurEdge	Select Model Number from above H L D - L 3 F .	Select Glide Option E Hard Surface (no upcharge) (Fixed or Adjustable models only) G Bell Glide (Sit-to-stand model only) E .	Select Laminate Top Color CC Harvest DD Natural Maple A5 Sheer Mesh B9 Silver Mesh C C .	Select Edge Color P Black P .	Select Frame Color S Charcoal T1 Platinum S



Icon Legend on page 10

- ▶ Choose from Hard Plastic or Laminate tops.
- ▶ Non-handed desk top constructed of 3/4" hard plastic.
- ▶ Laminate desk top constructed of 3/4" thick particleboard, high-pressure laminate top with SecurEdge for superior durability. Tamper and moisture resistant.
- ▶ Hard plastic tops include pencil grooves. Laminate tops do not.
- ▶ Nylon swivel glides are standard on adjustable and fixed leg models.
- ▶ Fixed Height models ship fully assembled. Adjustable models have the upper leg and cross-brace installed. The lower leg ships unattached for field installation.
- ▶ Wheelchair friendly, 29.60" distance between legs on user side. Outside distance between legs is 23 3/8".
- ▶ Accepts optional book basket (HLDA-15) and requires cross-brace repositioning and backpack hooks (HCLA65).
- ▶ Book boxes are only available as an accessory for field installation on Value Series desks.

⚠ **Field installed felt glide caps (HGDK3-F) are recommended for use on VCT flooring.**





Description	Model	Ship		List
		Weight	Cube	
 <p>Student Desk, Fixed Height 28"W x 28"W, User side 36 1/4"W 30" Fixed Height Hard Plastic Top Laminate Top, with SecurEdge</p> <p>NOTES: The cross-brace is installed to maximize kneespace but will not allow for book basket (HLDA-15) installation. The cross-brace orientation can be switched in the field to allow for book basket install.</p> <p> Student Desks are ordered and shipped two (2) desks per carton. Legs and cross-brace ship attached. The cross-brace is installed to maximize kneespace but will not allow for book basket (HLDA-15) installation. Pricing shown is per carton. Ordering two of model HLDV-M3F will result in 2 cartons being shipped, giving you 4 desks.</p>	HLDV-M3F E♦A	63	5.5	\$ 550
	HLDV-L3F E♦A	63	5.5	\$ 482

 <p>Student Desk, Adjustable Height 28"W x 28"W, User side 36 1/4"W Adjustable: 23"-33" height adjustment range. Hard Plastic Top Laminate Top, with SecurEdge</p> <p>SPECIFICATION TIP: Consider available kneespace when specifying under desk storage Wire Book Box. Available kneespace will vary significantly given set desk height. Use the following example to calculate the available and usable kneespace. EXAMPLE: HLDV-M3A Student Desk, HLDA-15 Wire Book Box (user set desk height – top thickness – seat height = available kneespace) (29"H – 1" thickness – 18" seat height = 10" available kneespace) (available kneespace – book basket/box height = usable kneespace) (10" available kneespace – 5" basket height = 5" usable kneespace)</p> <p>NOTES: The cross-brace is installed to maximize kneespace but will not allow for book basket (HLDA-15) installation. The cross-brace orientation can be switched in the field to allow for book basket install.</p> <p> Student Desks are ordered and shipped two (2) desks per carton. Upper Leg and Cross-brace ship attached. Lower adjustable legs ship unattached for field installation. Pricing shown is per carton. Ordering two of model HLDV-M3A will result in 2 cartons being shipped, giving you 4 desks.</p>	HLDV-M3A E♦A	59	5.5	\$ 550
	HLDV-L3A E♦A	59	5.5	\$ 482

How to specify Hard Plastic	Select Model Number from above H L D V - M 3 F .	1st Option Select Glide Option E Hard Surface (no upcharge) E .	2nd Option Select Top Color CC Harvest G9 Breeze DD Natural Maple G8 Sand G1 White G 9 .	3rd Option Select Upper Leg Color S Charcoal T1 Platinum S
How to specify Laminate with SecurEdge	Select Model Number from above H L D V - L 3 F .	1st Option Select Glide Option E Hard Surface (no upcharge) (Fixed or Adjustable models only) E .	2nd Option Select Laminate Top Color CC Harvest DD Natural Maple A5 Sheer Mesh B9 Silver Mesh C C .	3rd Option Select Edge Color P Black P .
				4th Option Select Frame Color S Charcoal T1 Platinum S

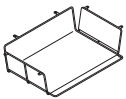

	Description	Model	Ship Weight	Cube	List
	<p>Wire, Book Box (4 per carton) 19½"W x 13"D x 5"H</p> <p>NOTES: Attaches to bottom of desk with 6 screws, included. Field installed. For use on model HLD-M3A, HLD-M3F or HLD-M3T. Features integrated, full-width pencil holder. Bent wire and perforated steel construction for durability and visibility.</p> <p>⚠️ Platinum finish only. Must be ordered with a configurable end product. If ordered separately, not on GSA Contract.</p>	HLDA-15 E⬢A	15	2.0	\$ 196
	<p>Back Pack Hook (10 per carton)</p> <p>NOTES: Assembly; attaches to bottom of desk with (2) screws, included.</p> <p>⚠️ Available in Chrome finish only. Must be ordered with a configurable end product. If ordered separately, not on GSA Contract.</p>	HCLA65 E⬢A	10	0.1	\$ 88
	<p>Glide Kit — Felt Glide Caps</p> <ul style="list-style-type: none"> • Recommended for use on VCT flooring. • Caps easily and securely snap over existing nylon swivel glide. • Kit includes 100 caps for 33 desks. • Field installed. <p>⚠️ Not designed to be used with Sit-to-Stand Bell Glides (model HLD-M3T). Must be ordered with a configurable end product. If ordered separately, not on GSA Contract.</p>	HGDK3-F	2	0.2	\$ 116

How to specify

Select Model Number from above

H | L | D | A | - | 1 | 5 |

Icon Legend on page 10







- ▶ High strength tubular steel frame.
- ▶ Glides available in nylon or nickel plated steel.

- ▶ Seat Shell is one-piece injection molded.
- ▶ 16"H and 18"H models accept Wire Storage Basket model HSSA-WB1618.
- ▶ Casters are available on 16"H and 18"H chairs only.
- ▶ 4-Leg models stack 5-high on floor.

- ▶ Nylon or steel glides accept felt glide caps (GDK3-F) which are recommended for use on VCT flooring.
- ▶ Durable textured powder coated paint finish.

- ▶ 4-Leg chairs ship 4 per carton.
- ▶ Lead-times may vary by shell color.
- ▶ **CA Technical Bulletin 133 compliant shells available in LA-Lava ONLY, ordering instructions below.**

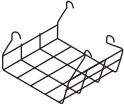

Model/Description	Depth	Width	Height	Ship Weight	Cube	Per Carton List
 HSS4L-12A 12"H 4-Leg Chair, 4 Leg, Armless	Maximum Seat Back Seat to Floor Usable Seat Depth	17 14 1/4 17 3/8 14	17 14 5/8 11 5/8 12	45	11.9	\$ 502 (reference single unit @ \$125.50)
 HSS4L-14A 14"H 4-Leg Chair, 4 Leg, Armless	Maximum Seat Back Seat to Floor Usable Seat Depth	17 14 1/4 17 3/8 14	17 14 5/8 11 5/8 14	49	11.9	\$ 502 (reference single unit @ \$125.50)
 HSS4L-16B 16"H 4-Leg Chair, 4 Leg, Armless ♂	Maximum Seat Back Seat to Floor Usable Seat Depth	19 5/8 16 1/4 15 3/8 16 1/8	19 1/4 16 1/2 13 3/8 16	54	15.6	\$ 529 (reference single unit @ \$132.25)
 HSS4L-18B 18"H 4-Leg Chair, 4 Leg, Armless ♂	Maximum Seat Back Seat to Floor Usable Seat Depth	19 5/8 16 1/4 15 3/8 16 1/8	19 1/2 16 1/2 13 3/8 18	58	15.6	\$ 529 (reference single unit @ \$132.25)
 HSSA-WB1618 Wire Storage Basket, 15 3/4"W x 12 1/4"D x 9 3/4"H For 16" and 18" Chairs only Ships 4 per carton ▲ Chrome finish only.				14	1.6	\$ 104
 HGDK3-F Glide Kit for 4-Leg SmartLink® • Recommended for use on VCT flooring. • Caps easily and securely snap over the existing nylon swivel glide. • Kit includes 100 caps for 25 chairs or desks. • Field installed.				2	0.2	\$ 116

 **SmartLink® 4-Leg Chairs are ordered and shipped four (4) chairs per carton. Pricing shown is per carton. Each set of four chairs (one carton) must have the same shell/frame color combination. Ordering 2 of Model HSS4L-12A, HSS4L-14A, HSS4L-16B or HSS4L-18B will result in 2 cartons being shipped, giving you 8 chairs.**

Must be ordered with a configurable end product. If ordered separately, not on GSA Contract.

How to specify	1st Option	2nd Option	3rd Option
Select Model Number from above	Select Glide Option	Select Shell Color	Select Frame Color
	E Nylon Glide N Nickel Steel Glide C Caster (\$196 upcharge) Caster option not available for models HSS4L-12A or HSS4L-14A	RG Tangelo MB Mulberry CR Cherry LO Loft LM Lime PT Platinum CP Calypso SD Shadow BU Surf LA Lava RE Regatta ON Onyx	PLAT Platinum Textured P7A Charcoal Textured Y Chrome (\$52 upcharge)
H S S 4 L - 1 2 A .	E .	R G .	P L A T
 Fire Code Option: For CA Technical Bulletin 133 compliant shells, color limited to LA-Lava. Add Suffix: FC to model number as shown below. Note \$30 upcharge per seat.			
H S S 4 L F C - 1 2 A . E .		L A .	P L A T

       Icon Legend on page 10

SmartLink® Chairs

- ▶ High strength tubular steel frame.
- ▶ Glides available with nylon or felt inserts. See ordering information below.
- ▶ Seat shell is one-piece injection molded.
- ▶ Cantilever models stack 5-high on floor.
- ▶ Durable textured powder coated paint or chrome option finish.
- ▶ Cantilever chairs ship 4 per carton.
- ▶ Lead-times may vary by shell color.



Model/Description	Depth	Width	Height	Ship Weight	Cube	Per Carton List
 HSSCL-18B 18"H Cantilever Base Chair, Armless	Maximum	21 ³ / ₄	22 ³ / ₄	31 ¹ / ₄	80	23.7
	Seat	16 ¹ / ₈	16 ¹ / ₂	18		
	Back		15 ³ / ₈	13 ³ / ₈		
	Seat to Floor			18 ¹ / ₄		
	Usable Seat Depth	16 ¹ / ₈				
						\$ 767 (reference single unit @ \$191.75)

Open Market

 **SmartLink® Cantilever Chairs are ordered and shipped four (4) chairs per carton. Pricing shown is per carton. Each set of four chairs (one carton) must have the same shell/frame color combination. Ordering 2 of Model HSSCL-18B will result in 2 cartons being shipped, giving you 8 chairs.**



How to specify	1st Option	2nd Option	3rd Option
Select Model Number from above H S S C L - 1 8 B .	Select Glide Option E All-purpose Glide Insert (no upcharge) F Felt Glide Insert (\$36 list upcharge; \$9 per single unit see page 732) E .	Select Shell Color RG Tangelo MB Mulberry CR Cherry LO Loft LM Lime PT Platinum CP Calypso SD Shadow BU Surf LA Lava RE Regatta ON Onyx R G .	Select Frame Color PLAT Platinum Textured P7A Charcoal Textured Y Chrome (\$52 upcharge) P L A T
<input type="checkbox"/> Fire Code Option: For CA Technical Bulletin 133 compliant shells, color limited to LA-Lava. Add Suffix: FC to model number as shown below. Note \$32.25 upcharge per seat. H S S C L F C - 1 8 B . E .		L A .	P L A T

SmartLink® Chairs

GSA SIN 71-302

- ▶ Seat Shell is one-piece injection molded.
- ▶ Task Swivel Chair has a pneumatic seat height adjustment.
- ▶ Choose between hard and soft casters (no upcharge) or bell glide (\$25 upcharge) options.
- ▶ Stool has an adjustable footring.
- ▶ Swivel Task Chair and Stool ship one per carton.
- ▶ Lead-times may vary by shell color.
- ▶ **Swivel Task Chair and Stool are available with a black frame only.**

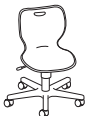

Model/Description	Depth	Width	Height	Ship Weight	Cube	Per Carton List
 HSSTK-18B 18"H Task Swivel Chair, Swivel, Pneumatic Seat Height Adjustment ▲ Black frame only.	Maximum	22 ⁵ / ₈	22 ¹ / ₂	34 ³ / ₄	23	5.2
	Seat	16 ¹ / ₄	16 ¹ / ₂	18		
	Back		15 ³ / ₈	13 ³ / ₈		
	Seat to Floor			16-21		
	Usable Seat Depth	16 ¹ / ₈				
						\$ 249
 HSSST-18B 18"H Task Swivel Stool, Swivel, Pneumatic Seat Height Adjustment, Footring Adjustment ▲ Black frame only.	Maximum	24 ¹ / ₄	25 ³ / ₄	45 ¹ / ₂	28	12.8
	Seat	16 ¹ / ₄	16 ¹ / ₂	18		
	Back		15 ³ / ₈	13 ³ / ₈		
	Seat to Floor			22-32		
	Usable Seat Depth	16 ³ / ₈				
						\$ 336

How to specify	1st Option	2nd Option
Select Model Number from above H S S T K - 1 8 B .	Select Glide Option S Soft Caster (no upcharge) H Hard Caster (no upcharge) G Bell Glide (\$25 upcharge) S .	Select Shell Color RG Tangelo MB Mulberry CR Cherry LO Loft LM Lime PT Platinum CP Calypso SD Shadow BU Surf LA Lava RE Regatta ON Onyx R G

Icon Legend on page 10

- ▶ Tops/Bases are Laminate with T-mold edge.
- ▶ Larger top size provides ample work/conference area or space for equipment.
- ▶ Standard with Heavy-duty 3", 360-degree swivel casters, 4-locking, 4-non-locking.



- ▶ Storage options include: Locking box/box/file and locking file/file.
- ▶ Kneewell space accommodates separately specified and field installed non-locking center drawer and CPU holders (see page 735).

- ▶ End panels are removable to access standard power management cabinets on both ends of the station for safe and secure storage of plug-strips, power cords and cables.
- ▶ Removable end panels have one outside cord management grommet.

- ▶ Full width cable management system provides easy access to and from each side cabinet.
- ▶ Standard with two Smart Grommets with wireway covers.
- ▶ Smart Grommets accept optional power inserts (see page 735).

- ▶ Single pedestal available in right and left handed configurations.
- ▶ D-shape top encourages conferencing and provides ample work and conference area.
- ▶ Standard with modesty panel.
- ▶ Modesty and column leg will match the specified metal surface color.

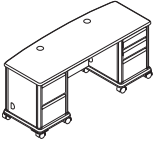

	Description	Model	Ship Weight	Cube	List
	Teacher Station 72"W x 26"D x 30"H File/File Pedestal, left Box/Box/File Pedestal, right	HLT2672T-23	254	37.2	\$1846
	Teacher Station 60"W x 24"D x 30"H Box/Box/File Storage, Single Pedestal, right	HLT2460T-R3	136	29.3	\$1661
	Teacher Station 60"W x 24"D x 30"H Box/Box/File Storage, Single Pedestal, left	HLT2460T-L3	136	29.3	\$1661

How to specify	1st Option	2nd Option	3rd Option
Select Model Number from above	Select Casters	Select Top and Base Color	Select T-Mold and Paint Color
H L T 2 6 7 2 T - 2 3 .	C Hard Surface (no upcharge)	Laminate See page 723 B 9 .	S Charcoal T1 Platinum T 1



- ▶ Accessory rail mounts to either side of the Teachers Station or Storage Cases.

- ▶ Accessory Rail accepts file folder, CD/Pencil holder or other accessories (see page 740).

- ▶ Metal Center drawer mounts within kneespace of 26" x 72" Teachers Stations.

- ▶ Center drawer has ball-bearing suspension with 3/4 extension.
- ▶ Side panel power kit fits within side panel power management cabinets.

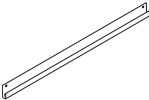
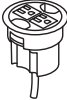

	Description	Model	Ship Weight	Cube	List
 (Angled front)	Metal Center Drawer, non-locking 24 ³ / ₄ "W x 14 ³ / ₄ "D x 3"H NOTES: Not for use on 24" x 60" Teacher's Stations. Field installed. Non-locking. Minimum clearance for mounting: 27 ³ / ₈ "W x 19 ¹ / ₄ "D. Specify paint. Available in Charcoal (S), Platinum (T1) \$10 upcharge. SPECIFYING EXAMPLE: HD8X.S	HD8X	12.0 [S]	1.2	\$ 201
	CPU Holder • Vertically mounts to underside of worksurface. • 360° swivel. • Supports up to 55 lbs. ▲ Silver finish only, no specification needed.	HCPU	16.0 [S]	0.5	\$ 230
	Accessory Rail (side mount) 21"W x 1/2"D x 1 1/2"H NOTES: Field installed. See page 740 for accessory options. 21" Usable width. Specify paint.	HLTA-TR24	3.0 [S]	0.3	\$ 150
	Power Hub, 3" Grommet Mount • Fits in 3" round grommet holes on the following product lines: 10500, 10700, Coordinate, Pennsylvania Avenue and Voi desks; Abound Worksurfaces; Huddle and Motivate tables and SmartLink. • Two grounded AC power outlets. • Includes 6' cord with three-prong plug. • Field installed with Plug-and-play ease. ▲ Available in black only (no color designation so use .X - Specify: HGRMTAC.X).	HGRMTAC	1.3	0.2	\$ 100

How to specify	1st Option
Select Model Number from above	Select Frame Color
H L T A - T R 2 4 .	S Charcoal T1 Platinum (\$10 upcharge) S

- ▶ Available with or without 3-point locking doors.
- ▶ Cases will accept a variety of storage accessories including trays, shelves and coat rods.
- ▶ Specify trays, shelves or coat rod accessories separately, see page 738. ▶ See specification/planning section on capacity for accessories (see pages 727-728).
- ▶ Standard with Heavy-duty 3", 360-degree swivel casters, 36" with case includes four casters (2-locking, 2-non-locking), 52"W cases include six casters (3-locking, 3-non-locking).
- ▶ Full height cases accept a coat rod in the 12"W columns only.

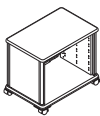
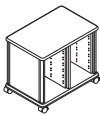
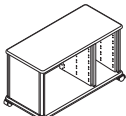
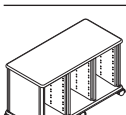
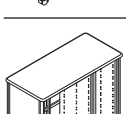
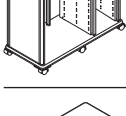

	Description	Model	Ship Weight	Cube	List
	Modular Storage Cabinet, Credenza Height 1 – 30"W Column 36¾"W x 24¼"D x 30"H NOTES: Capacity is dependent upon tray heights used. See tray kits on page 738. Accepts up to seven pairs of rails per column.	HLSC36T-1N	98	17.7	\$1051
	Modular Storage Cabinet, Credenza Height 2 – 12"W Columns 36¾"W x 24¼"D x 30"H NOTES: Capacity is dependent upon tray heights used. See tray kits on page 738. Accepts up to seven pairs of rails per column.	HLSC36T-2N	103	17.7	\$1151
	Modular Storage Cabinet, Credenza Height 1 – 30"W Left-hand Column 1 – 12"W Right-hand Column 52¾"W x 24¼"D x 30"H NOTES: Capacity is dependent upon tray heights used. See tray kits on page 738. Accepts up to seven pairs of rails per column.	HLSC52T-21N	154	25.3	\$1352
	Modular Storage Cabinet, Credenza Height 3 – 12"W Columns 52¾"W x 24¼"D x 30"H NOTES: Capacity is dependent upon tray heights used. See tray kits on page 738. Accepts up to seven pairs of rails per column.	HLSC52T-3N	159	25.3	\$1452
	Modular Storage Cabinet, Full Height 1 – 30"W Left-hand Column 1 – 12"W Right-hand Column 52¾"W x 24¼"D x 61¾"H NOTES: Capacity is dependent upon tray heights used. See tray kits on page 738. Accepts up to sixteen pairs of rails per column.	HLSF52T-21N	254	51.4	\$1833
	Modular Storage Cabinet, Full Height 3 – 12"W Columns 52¾"W x 24¼"D x 61¾"H NOTES: Capacity is dependent upon tray heights used. See tray kits on page 738. Accepts up to sixteen pairs of rails per column.	HLSF52T-3N	164	51.4	\$2031

How to specify	1st Option	2nd Option	3rd Option
Select Model Number from above	Select Casters	Select Top and Base Color	Select T-Mold and Paint Color
	C Hard Surface (no upcharge)	Laminate See page 723	S Charcoal T1 Platinum
H L S C 3 6 T - 1 N .	C .	D D .	T 1

- ▶ Available with or without 3-point locking doors.
- ▶ Cases will accept a variety of storage accessories including trays, shelves and coat rods.
- ▶ Specify trays, shelves or coat rod accessories separately, see page 738.
- ▶ See specification/planning section on capacity for accessories (see pages 727-728).
- ▶ Standard with Heavy-duty 3", 360-degree swivel casters, 36" with case includes four casters (2-locking, 2-non-locking), 52"W cases include six casters (3-locking, 3-non-locking).
- ▶ Full height cases accept a coat rod in the 12"W columns only.

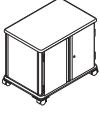
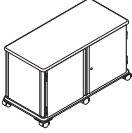
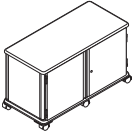
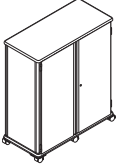
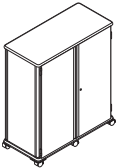

	Description	Model	Ship Weight	Cube	List
	Modular Storage Cabinet, Credenza Height 1 – 30"W Column 36¾"W x 24¼"D x 30"H NOTES: Capacity is dependent upon tray heights used. See tray kits on page 738. Accepts up to seven pairs of rails per column.	HLSC36T-1D	114	17.7	\$1189
	Modular Storage Cabinet, Credenza Height 2 – 12"W Columns 36¾"W x 24¼"D x 30"H NOTES: Capacity is dependent upon tray heights used. See tray kits on page 738. Accepts up to seven pairs of rails per column.	HLSC36T-2D	119	17.7	\$1283
	Modular Storage Cabinet, Credenza Height 1 – 30"W Left-hand Column 1 – 12"W Right-hand Column 52¾"W x 24¼"D x 30"H NOTES: Capacity is dependent upon tray heights used. See tray kits on page 738. Accepts up to seven pairs of rails per column.	HLSC52T-21D	174	25.3	\$1454
	Modular Storage Cabinet, Credenza Height 3 – 12"W Columns 52¾"W x 24¼"D x 30"H NOTES: Capacity is dependent upon tray heights used. See tray kits on page 738. Accepts up to seven pairs of rails per column.	HLSC52T-3D	179	25.3	\$1547
	Modular Storage Cabinet, Full Height 1 – 30"W Left-hand Column 1 – 12"W Right-hand Column 52¾"W x 24¼"D x 61¾"H NOTES: Capacity is dependent upon tray heights used. See tray kits on page 738. Accepts up to sixteen pairs of rails per column.	HLSF52T-21D	286	51.4	\$1961
	Modular Storage Cabinet, Full Height 3 – 12"W Columns 52¾"W x 24¼"D x 61¾"H NOTES: Capacity is dependent upon tray heights used. See tray kits on page 738. Accepts up to sixteen pairs of rails per column.	HLSF52T-3D	296	51.4	\$2145

How to specify	1st Option	2nd Option	3rd Option
Select Model Number from above	Select Casters	Select Top and Base Color	Select T-Mold and Paint Color
H L S C 3 6 T - 1 D .	C Hard Surface (no upcharge)	Laminate See page 723	S Charcoal T1 Platinum
	C .	D D .	T 1

- ▶ Mounting bracket model HLSA-WBK52 mounts whiteboard to back of full-height Modular Storage unit.
- ▶ For use in Modular Storage cases and Teachers Station with tray storage.
- ▶ Trays for use in 12" width columns only. Shelves are available for use in 12" and 30" width columns.
- ▶ Trays and shelves hang off a pair of accessory rails.
- ▶ Trays and shelves are sold in "kit quantities" and include necessary accessory rails for installation.
- ▶ 12" trays accept rails to accommodate hanging file folders (side-to-side).
- ▶ All accessories are field installed.
- ▶ Trays feature front and rear handles for easy handling and are translucent for visibility to contents.
- ▶ All shelves feature an integrated finger pull and safety mechanism to prevent accidental removal.
- ▶ Coat rod is for use full height cases, 12"W columns only.
- ▶ See pages 727-728 for specifying details.



	Description	Model	Ship			
			Weight	Cube	List	
	Tray Kits 3"H, 7 trays and 14 rails per kit 6"H, 4 trays and 8 rails per kit 12"H, 2 trays and 4 rails per kit NOTES: Field installed. See pages 727-728 for specifying guidelines. ▲ Translucent SPECIFYING EXAMPLE: HLSA-TK3.X	HLSA-TK3 HLSA-TK6 HLSA-TK12	12.0 10.0 7.0	2.7 2.7 2.7	\$ 172 \$ 119 \$ 89	
		Shelf Kits, 2 shelves and 4 rails per kit 12"W x 24"D 30"W x 24"D NOTES: Field installed. See pages 727-728 for specifying guidelines. Specify color.	HLSA-SK1220T HLSA-SK3020T	14.0 28.0	0.6 1.2	\$ 252 \$ 367
		Coat Rod, Single Unit 12"W x 1" diameter NOTES: Use with Full-height cases, 12" columns only. Field installed. ▲ Anodized finish only.	HLSA-CR12	0.5	0.1	\$ 87
		Hanging Folder Rail Kit 12"W Rails 4 rails per kit, each tray uses 2 rails NOTES: Use with 12" trays only. Field installed. ▲ Anodized finish only.	HLSA-HRK	0.5	0.2	\$ 34
	Cabinet Whiteboard Mounting Bracket 52"W Includes 1 pair (upper and lower) of rails and mounting hardware. <ul style="list-style-type: none"> • Accommodates: 1 – 48" x 48" Sliding Board or 2 – 24" x 48" Sliding Boards • Compatible Sliding Boards (see page 739) HLWBS-448WW HLWBS-248WW HLWBS-448WT HLWBS-248WT • Requires field installation. NOTES: For use on full-height cabinets only. Rails feature an integrated marker tray. Specify Charcoal (S) or Platinum (T1) color. SPECIFYING EXAMPLE: HLSA-WBK52.S	HLSA-WBK52	5.0	0.3	\$ 158	

How to specify	1st Option
Select Model Number from above H L S A - S K 1 2 2 0 T .	Select Shelf Color C Harvest D Natural Maple LOFT Loft WHIT Brilliant White C

Icon Legend on page 10

- ▶ Multi-functional wall rails can accommodate whiteboards, worksurfaces and organizational accessories. See below and page 740.
- ▶ Sliding learning boards may be attached to the back of Mobile, full height cabinets with bracket kit HLSA-WBK52 (see page 738).
- ▶ Multi-track rail allows for up to three layers of whiteboards. Rear track supports a fixed board, middle and front tracks support sliding boards. Outer rail channel is for attachment of worksurfaces and organizational accessories.
- ▶ Sliding learning boards are removable and reversible.
- ▶ All fixed and sliding boards:
 - Require two (upper and lower) rails for installation.
 - Feature a full aluminum frame.
 - Are high quality porcelain over steel and non-shadowing.
 - Are low gloss for projection use and allows for use of magnets.

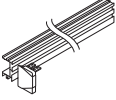
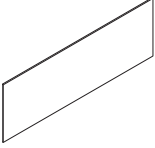
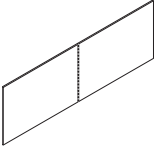
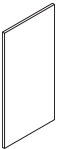
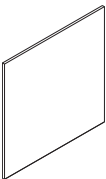

	Description	Model	Ship Weight	Cube	List
	Wall Rail 144" NOTES: Rail model includes: 1 – 144" rail, 9 – wall mounting brackets and 2 – rail end caps. ▲ Must be mounted in accordance with published installation instructions. Wall mounting hardware NOT INCLUDED. Must be sourced locally. ▲ Platinum finish only.	HLWR-12	22	1.4	\$ 688
	Learning Board, Fixed Whiteboard, 1-sided 144"W x 48"H, Quantity 1 SPECIFYING EXAMPLE: HLWBF1-1248W.X	HLWBF1-1248W	124	13.0	\$1649
	Learning Board, Fixed Whiteboards, 1-sided 72"W x 48"H, Quantity 2 with spacer (included) NOTES: Includes center cover/spacer. SPECIFYING EXAMPLE: HLWBF2-1248W.X	HLWBF2-1248W	125	6.7	\$1649
	Learning Board, Sliding Whiteboard/Whiteboard 48"W x 48"H 24"W x 48"H NOTES: May be used with HLSA-WBK52 to mount to the back of full-height Mobile Cabinets. (See page 738.) SPECIFYING EXAMPLE: HLWBS-448WW.X	HLWBS-448WW HLWBS-248WW	47 26	4.6 2.5	\$ 794 \$ 506
<i>Model HLWBS-248WW shown</i>					
	Learning Board, Sliding Whiteboard/Tackboard 48"W x 48"H 24"W x 48"H NOTES: May be used with HLSA-WBK52 to mount to the back of full-height Mobile Cabinets. (See page 738.) Tackboard Side available in the following fabrics: Lucy Neutra (LC24), Element Veil (GN13), Element Warm Beige (GN55) SPECIFYING EXAMPLE: HLWBS-448WT.X.GN13	HLWBS-448WT HLWBS-248WT	64 34	4.6 2.5	\$ 827 \$ 528
<i>Model HLWBS-448WT shown</i>					

How to specify	1st Option	2nd Option
Select Model Number from above H L W B S - 4 4 8 W T .	Select Side A Color X Whiteboard X .	Select Tackboard Fabric GN13 Element Veil GN55 Element Warm Beige LC24 Lucy Neutra Specify for models HLWBS-448WT and HLWBS-248WT only G N 1 3











SmartLink® Wall Rail System Accessories

GSA SIN 71-302 Except as Noted



- ▶ Accessories below to be used on the Wall Rail System — see page 739.
 - ▶ All accessories mount on the rail's outer channel and may be used with sliding boards.
 - ▶ All accessories may be mounted and moved to any position along the width of the rail.
 - ▶ All accessories may be easily removed from the rail with the exception of the All-Purpose Hook. All-Purpose Hook can slide horizontally along the rail but cannot be removed without removing a rail end cap.
- ⚠ **All-Purpose Hook Model HPPMHK is available in Platinum Metallic (T1) only.**

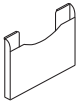

	Description	Model	Ship Weight	Cube	List
	Marker Tray (Single Pack) 7"W x 3 1/2"D x 2"H NOTES: Holds dry-erase markers, push pins and other small objects.	HPPMMT	1 	0.2	\$ 79
	Paper Clip (2 per carton) 5"W x 2"H NOTES: Use individually for artwork or smaller items. Use in pairs for larger notepad size pieces of paper.	HPPMPC	1 	0.2	\$ 81
	All-Purpose Hook (10 per carton) NOTES: Use for hanging back-packs, coats and other items. Hooks slide horizontally and cannot be removed without first removing the rail end cap. ⚠ Specify paint — Platinum Metallic only.	HPPMHK	1 	0.2	\$ 186
 SIN 711-2	CD/Pencil Holder 5 1/4"W x 1 1/2"D x 5"H NOTES: Installs on the Wall Rail or Accessory Rail (HLTA-TR24) for use on the Teacher's Desk or Storage Cases. May also be mounted on Folder Bins.	HPPMPB	1 	0.2	\$ 94
 SIN 711-2	Folder Bin 12 1/4"W x 1 1/4"D x 9"H NOTES: Installs on the Wall Rail or Accessory Rail (HLTA-TR24) for use on the Teacher's Desk or Storage Cases. Folder Bin may be mounted (stacked) to each other.	HPPMFB	2 	0.3	\$ 94

How to specify	Select Model Number from above H P P M M T .	1st Option Select Paint Color S Charcoal T1 Platinum Metallic (\$12 upcharge) Model HPPMHK available in Platinum Metallic only T 1
----------------	---	--

   Icon Legend on page 10

			Laminate Center Drawers ©	Laminate Keyboard Platform © Models H4022/HE4022	Metal Center Drawers ©	Corner Sleeve ©	Metal Keyboard Platform ©
L1 LAMINATES		CODES					
Woodgrain	Bourbon Cherry	H	•	•			
	Cognac	COGN	•	•			
	Harvest	C	•	•			
	Mahogany	N	•	•			
	Mocha	MOCH	•	•			
	Natural Maple	D	•	•			
	Pinnacle	PINC	•	•			
	Shaker Cherry	F	•	•			
Solid	Black	P	•	•			
	Brilliant White	WHIT	•	•			
	Charcoal	S	•	•			
	Loft	LOFT					
	Whitestone	K4		•			
Patterned	Sheer Mesh	A5		•			
	Silver Mesh	B9		•			
	Steel Mesh	A9		•			
	Taupe Mesh	A8		•			
	Canyon Zephyr	K9		•			
	Desert Zephyr	K8		•			
	Shadow Zephyr	K1		•			
	Gray	G2		•			
	Grey Tigris	L6		•			
	White	G1		•			
L2 LAMINATES		CODES					
Woodgrain	Lowell Ash <i>NEW! 1/30/2017</i>	LLA1		•			
	Natural Recon <i>NEW! 1/30/2017</i>	LNR1		•			
	Phantom Ecu <i>NEW! 1/30/2017</i>	LPE1		•			
	Portico Teak <i>NEW! 1/30/2017</i>	LPT1		•			
	Skyline Walnut <i>NEW! 1/30/2017</i>	LSW1		•			
PAINTS		CODES					
Core	Black	P			•	•	•
	Charcoal	S			•	•	•
	Greige	T5			•	•	•
	Light Gray	Q			•	•	•
	Loft	LOFT			•	•	•
	Muslin	T3			•	•	•
	Putty	L			•	•	•
	Shadow	SHDW			•	•	•
Choice/ Metallics	Brilliant White	WHIT			•	•	•
	Champagne Metallic	T4			•	•	•
	Platinum Metallic	T1			•	•	•

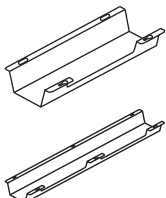

SIN 711-1



SIN 711-2

Description	Model	Ship		List
		Weight	Cube	
Cable Management Troughs 17"W — Single 17"W — 10-Pack 36"W — Single 36"W — 10-Pack • Cable management troughs ship flat packed. • The troughs attach to underneath the worksurface with screws. • The 17"W has one wire access cut out on the user side. The 36" has two wire access cut outs. These cut outs give users access to inside the trough without having to detach it from the worksurface. • Color: Graphite. • Material: Metal. • TAA Compliant.	HCTROUGH17	2.7	0.5	\$ 60
	HCTROUGH1710	14.0	0.5	\$ 568
	HCTROUGH36	4.9	0.9	\$ 101
	HCTROUGH3610	30.0	0.9	\$ 959

O-Leg Cord Clips Clips for 28 1/2" Worksurface O-Legs — 8-Pack Clips for Stack-on Storage, Hutch and Layering O-Legs — 4-Pack NOTES: Wire clips work with 7" Low Credenza O-leg and 29"H Support O-leg. Wire clips also work with the 50" and 65" Overhead O-leg supports. ▲ Available in frosted plastic material only.	HWMCLIPLG	0.8	0.1	\$ 86
	HWMCLIPSM	0.5	0.1	\$ 55

How to specify











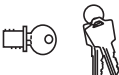

Select Model Number from above

H | C | T | R | O | U | G | H | 1 | 7 |

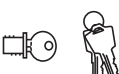
Icon Legend on page 10

- ▶ HON "One Key" interchangeable core removable locks are standard on most HON products. Look for the HON "One Key" icon.
- ▶ Keyed alike cores are listed below.
- ▶ If key number is not specified, number will be at random.
- ▶ For keyed alike locks:
 - Order standard product which will be shipped with factory installed locks and random numbered cores or omit lock option where offered.
 - Order the appropriate quantity of like numbered cores required for each workstation or keyed area.
 - Simply replace the factory installed cores with the replacement cores after product has been installed.
- ▶ To install new core:
 - Lock must be in the unlocked position.
 - Insert core removal key and pull core straight out.
 - Insert new core with core removable key, hold core into lock and withdraw core removal key.
 - Retain original core for future use.
- ▶ To provide normal lead times, key numbers cannot be specified on HON products at time of order. This also eliminates need for tagging and tracking each product's lock number during installation.
- ▶ Black removable lock core kit used on laminate casegoods.
- ▶ Chrome removable lock core kit used on metal casegoods.



	Description	Model	Ship Weight	Cube	List
 SIN 711-3	Chrome Removable Lock Core Kit (for metal casegoods) Use when specifying omit lock application. <ul style="list-style-type: none"> • Specify quantity of each key number from 101E-225E. • Includes: 1-core, 2-keys, 1-core removal tool and instructions. • Removable lock core kits with specific key number must be ordered to facilitate keying alike in the field. • For specific models, look for the Omit Lock Core icon throughout this publication. NOTES: If key number isn't specified, number will be at random. Core matches manufactured lock on metal casegoods product but can be used with Contain [®] and laminate product.	HF23C	0.1 	0.1	\$ 36
 SIN 711-3	Satin Removable Lock Core Kit (for metal casegoods) Use when specifying omit lock application. <ul style="list-style-type: none"> • Specify quantity of each key number from 101E-225E. • Includes: 1-core, 2-keys, 1-core removal tool and instructions. • Removable lock core kits with specific key number must be ordered to facilitate keying alike in the field. • For specific models, look for the Omit Lock Core icon throughout this publication. NOTES: If key number isn't specified, number will be at random. Core matches manufactured lock on metal casegoods product but can be used with metal casegoods and laminate product.	HF23S	0.1 	0.1	\$ 34
 SIN 711-2	Black Removable Lock Core Kit (for laminate products) Specify quantity of each key number from 101E-225E. Includes: 1-core, 2-keys, 1-core removal tool, and instructions. NOTES: If key number isn't specified, number will be at random. Core matches manufactured lock on laminate product but can be used with metal casegoods product.	HF23B	0.1 	0.1	\$ 28
 SIN 711-3 SIN 711-2 for HF24	Removable Lock Core Kit Black Satin For stack-on and wall mounted storage laminate models (with locks) in 10500, 10700, Valido, Park Avenue Laminate, Concinnity, and 94000 Series. Specify quantity of each key number from 101E to 225E. Includes: 1-core, 2-keys, 1-core removal tool, and instructions. NOTES: If key number isn't specified, number will be at random.	HF27B HF27S	0.2	0.02	\$ 28
					\$ 28
 SIN 711-3	Master Key (one key) Will open all HON product with HON "One Key" interchangeable core removable locks. Available to authorized dealers only. Will open HF23B, HF23C, HF23S and HF24 locks numbered 101E-225E. Will open old HON style MB series locks.	HF22	0.1 	0.1	\$ 21
 SIN 711-3	Chrome Core Removable Lock Kit for Vertical Files Field Installable. Specify key number from 101E-225E. Includes: 1-lock with core, 2-keys and attaching linkage. NOTES: If key number isn't specified, number will be at random.	HF24	0.2 	0.2	\$ 50
 SIN 711-3 SIN 711-2 for HF24	Bulk Package 6 HF24 Lock Kits (Individually shrink wrapped) NOTES: Bulk Package key numbers are at random and cannot be specified.	HF246	1.2 	0.2	\$ 242



HOW TO ORDER CORE REMOVABLE LOCK KITS:

Specify: Model Number.X
Key Number

Examples: HF23C.X121E
HF23C.X (Key number not specified)

NOTES: Key orders without numbers specified will be keyed at random.
Numbers 101E-225E are available.

SAMPLE ORDER:

Quantity	Model	Key Code
6	HF23C.	X121E
4	HF23B.	X121E
5	HF24.	X121E
1	HF22.	X
2	HF24.	X





Corner Sleeves

GSA SIN 711-1, 711-2, 711-11

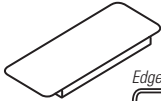

- ▶ Corner sleeve connects intersecting worksurfaces to create "corner desk" work areas.
- ▶ Corner sleeve has pre-drilled holes to allow attachment of articulating keyboard platforms shown on page 749.
- ▶ Specify paint color.

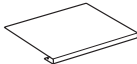

	Description	Model	Ship Weight	Cube	List by Paint Grade	
					Core	Choice/Metallics
 <p>Edge Detail Model H51204</p>	<p>Metal Corner Sleeve</p> <ul style="list-style-type: none"> • Fits 1 1/8" thick square edge detail. • Smaller design is more aesthetically pleasing. • 22 1/2"W leading edge x 9"D. 	H51204	10 	1.5	\$ 138	\$ 145
 <p>Edge Detail Model H51206</p>	<ul style="list-style-type: none"> • Fits 1 1/8" thick square edge detail. • 22 1/2"W leading edge x 18"D. 	H51206	10 	1.5	\$ 138	\$ 148

How to specify	<p>Select Model Number from above</p> <p>H 5 1 2 0 4 .</p>	<p>1st Option</p> <p>Select Paint Color</p> <p>See page 741</p> <p>P</p>
----------------	---	---

  Icon Legend on page 10

Monitor Arms

▶ Arms fold back to post to allow more desktop room.

▶ Arms feature double extension, allowing 20"+ of back and forth movement.

▶ Cable management on both pole and arm assemblies.

▶ Counterbalance adjustment provides stability for monitors up to 17.6 lbs per arm.

▶ Made of high quality aluminum alloy material.

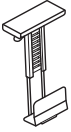
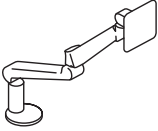
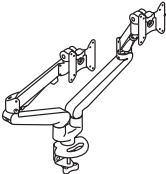

	Description	Model	Ship		List
			Weight	Cube	
 SIN 711-1, 711-2	<p>CPU Holder</p> <ul style="list-style-type: none"> Vertically mounts to underside of worksurface. 360° swivel. Supports up to 55 lbs. Height adjustable from 16" to 22" below worksurface. Width adjustable to accept units from 3¼" to 6". <p>⚠ Silver finish only, no specification needed.</p>	HCPU	16	0.5	\$ 230
 SIN 711-2	<p>Single Monitor Arm — Effortless Adjustment</p> <ul style="list-style-type: none"> Effortless adjustment. Height adjusts from 7" to 20" for a total range of 13". Monitor extends 22½". Monitor retracts 3½" to save space. 360° swivel at two points with folding capabilities. Monitor tilts +25" to -90". Enclosed cable management. Includes desk clamp or grommet mount. <p>⚠ Silver finish only, no specification needed.</p>	H5210	11	1.3	\$ 497
 SIN 711-2	<p>Dual Monitor Arm — Effortless Adjustment</p> <ul style="list-style-type: none"> Single mount with dual monitor adjustment. Effortless adjustment. Height adjusts from 7" to 20" for a total range of 13". Monitor extends 22½". Monitor retracts 3½" to save space. 360° swivel at two points with folding capabilities. Monitor tilts +25" to -90". Enclosed cable management. Dual screen models allow screens to be aligned horizontally for optimal ergonomic positioning. Includes desk clamp or grommet mount. Includes VESA plate for 75 x 75mm or 100 x 100mm (converter plate for 100mm x 200mm is available separately). <p>⚠ Silver finish only, no specification needed.</p>	H5220	15	1.8	\$ 889

How to specify

Select Model Number from above

H | C | P | U









Icon Legend on page 10

Directional™ Desktop Sit-to-Stand

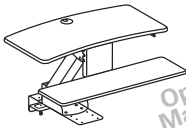
Not on GSA Contract

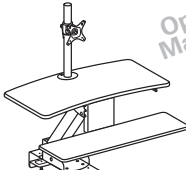

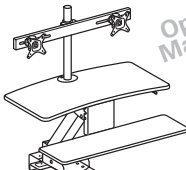
- ▶ These products are designed to allow the user to transition from seating position to standing position throughout the workday.
 - ▶ Gas-assist lever-operated mechanism with positive stop.
 - ▶ Clamp mount compatible with worksurfaces depths of 20"-30".
 - ▶ Clamp requires 3.5" of clearance along back edge of worksurface.
 - ▶ Black seamless worksurfaces.
 - ▶ Silver powder coated metal components.
 - ▶ Lowers below worksurface level on 24" and 30"D worksurfaces.
 - ▶ All models contain a large primary worksurface and a smaller keyboard / mouse surface.
 - ▶ Beveled edges for sleek appearance and comfort while typing.
 - ▶ Monitor arms include height, width, and swivel adjustment.
- ⚠ **Not recommended for use on mobile (castered) worksurfaces.**

	Description	Model	Ship Weight	Cube	List
	Directional™ Desktop Sit-to-Stand Device NOTES: Does not include a monitor arm and is suitable for laptops and/or monitors on their original stands.	HS1100	60 	3.2	\$ 525
	Directional™ Desktop Sit-to-Stand Device with Single Monitor Arm NOTES: Includes a monitor arm for a single monitor.	HS1101	62 	3.2	\$ 615
	Directional™ Desktop Sit-to-Stand Device with Dual Monitor Arm NOTES: Includes a monitor arm for dual monitors.	HS1102	63 	3.2	\$ 700

Mounting and Compatibility:

- This product is intended to be installed on commercial-grade worksurfaces in good condition.
- Compatible with freestanding worksurfaces 24"-30"D or panel-supported worksurfaces 24"-30"D.
- Not for use on mobile worksurfaces.

Clamp Mount

Use when 3.5" minimum overhang is available

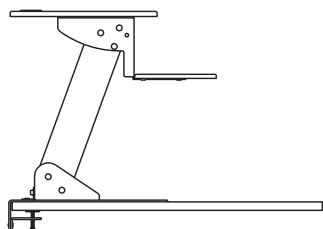

Screw Mount

Use when no overhang is available. Worksurface must be minimum 1" thick.

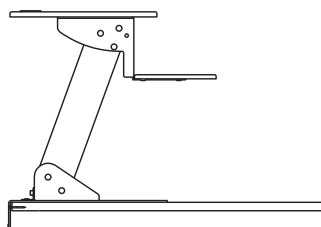







How to specify

Select Model Number from above

H S 1 1 0 0

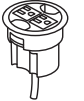
⚠  Icon Legend on page 10



	Description	Model	Ship Weight	Cube	List
 Black only	Field Installable Grommet <ul style="list-style-type: none"> Intended for use in tops and end panels to route/hide cords and in modesty panels to facilitate reaching wall electrical outlets. Grommet is field installable. Requires a 2 1/2" diameter hole saw and drill for installation (not included). Grommet shape is round. Includes grommet cap and sleeve. Grommet cap measures 3" diameter and includes a 3/4" diameter cord access hole. Grommet sleeve measures 2 1/2" O.D. x 3/4" thick. Includes instructions to locate grommet position for desks, credenzas, returns and bridges. <p>△ Black Finish</p> <p>NOTES: Grommet is specifically designed for use with the following HON Wood Laminate Desk Series only: Valido®, 10700 and 10500 Series.</p> <p>△ The grommet is not designed to be used with the following HON Series: 94000, 38000, Mentor®, Metro Classic or 34000.</p>	HFLDGRMT	0.1	0.01	\$ 28
	Field Installable Grommet <ul style="list-style-type: none"> Intended for use in tops and end panels to route/hide cords and in modesty panels to facilitate reaching wall electrical outlets. Black Finish Grommet is field installable. Requires a 3" diameter hole saw and drill for installation (not included). Grommet shape is round. Includes grommet cap and sleeve. Grommet outside dimensions measures 3 1/2" diameter and includes two cord access holes. Grommet sleeve measures 3" O.D. x 1" thick. Includes instructions to locate grommet position for desks, credenzas, returns and bridges. 	HFLDGRMT3	0.1	0.3	\$ 28
 SIN 71-302	Power Hub, 3" Grommet Mount <ul style="list-style-type: none"> Fits in 3" round grommet holes on the following product lines: 10500, 10700, Coordinate, Pennsylvania Avenue and Voi desks; Abound Worksurfaces; Huddle and Motivate tables and SmartLink. Two grounded AC power outlets. Includes 6' cord with three-prong plug. Field installed with Plug-and-play ease. <p>△ Available in black only (no color designation so use .X – Specify: HGRMTAC.X).</p>	HGRMTAC	1.3	0.2	\$ 100
 Open Market	Grommet Accessory 3" Grommet with USB <ul style="list-style-type: none"> One grounded AC power outlet with 2 USB ports. UL Listed. <p>△ Available in black only (no color designation so use .X – Specify: HGRMTUSB2.X).</p>	HGRMTUSB2	1.3	0.2	\$ 198
 SIN 711-11	Pop-up Port <ul style="list-style-type: none"> Fits into 4" x 8" cutout. Pop-up Port provides three power ports and one blank data receptacle. Sits flush with worksurface when closed. Finish is anodized aluminum. Includes 6' cord with three-prong plug. 	HTPWRGROM1	5.0	0.3	\$ 343
 SIN 711-11	Data Grommet Blank grommet kit that includes adapters for a variety of manufacturers jacks and couplers. <ul style="list-style-type: none"> Fits in 3" round grommet holes Available in Black only. <i>Specify P when ordering. Example: HGRMTDATA.P.</i> 	HGRMTDATA	0.2	0.2	\$ 15

How to specify

Select Model Number from above

H | F | L | D | G | R | M | T

Icon Legend on page 10

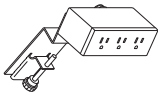
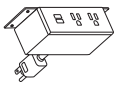

	Description	Model	Ship Weight	Cube	List
 <p>Model HPWRMOD3WC shown</p>	<p>Power Modules</p> <p>3 Receptacles with Worksurface Clamp</p> <p>3 Receptacles with Under-Worksurface Mounting Bracket</p> <p>2 Receptacles 2 USB with Worksurface Clamp</p> <p>2 Receptacles 2 USB with Under-Worksurface Mounting Bracket</p> <ul style="list-style-type: none"> • 6' power cord with standard three-prong plug. • Under-worksurface mounting bracket models work with any top that has a 5" x 5" square clearance. • Worksurface clamp models work on any top with a 4" overhang. • UL Listed. <p>⚠ Color finish coordinates with HON's Charcoal or White. Specify S for Charcoal or WHIT for White when ordering. Example: HPWRMOD3WC.S.</p>	HPWRMOD3WC	2.3	0.2	\$ 272
		HPWRMOD3UWM	2.3	0.2	\$ 272
		HPWRMOD2WC	2.3	0.2	\$ 436
		HPWRMOD2UWM	2.3	0.2	\$ 436
 <p>Model HPWRMOD2UWM shown</p>	<p>Power & Data Center</p> <p>2 Receptacles 2 Data Accessory</p> <ul style="list-style-type: none"> • Standard with two receptacles and openings for two data ports. • 6' power cord with standard three-prong plug. • Fits on any worksurface with a 4" overhang. • UL Listed. <p>⚠ Color finish coordinates with HON's Loft. Specify LOFT when ordering. Example: HCOMDOME2.LOFT.</p>	HCOMDOME2	2.5	0.2	\$ 259

How to specify	1st Option
<p>Select Model Number from above</p> <p>H P W R M O D 3 W C .</p>	<p>Select Finish</p> <p>S Charcoal</p> <p>WHIT White</p> <p>LOFT Loft</p> <p>Specify Loft finish for HCOMDOME2 only</p> <p>S</p>

Icon Legend on page 10

△ Black only finish.

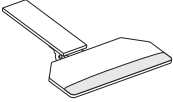
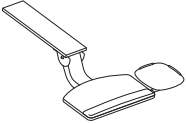
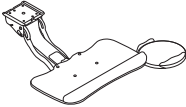
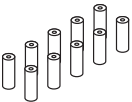

	Description	Model	Ship Weight	Cube	List
	Articulating Arm with Keyboard <ul style="list-style-type: none"> • 17" glide track. • Spring assisted. • Height adjustment 6¼" (1¼" above and 5" below track). • Tilt: +10°/-15°. • 25" cut corner platform. • Accommodates keyboard and mouse on same level. • Detachable palm rest. • Cord management clips included. 	H1706	16	1.4	\$ 440
	Articulating Arm with Convertible Keyboard <ul style="list-style-type: none"> • 21" glide track. • Lift and lock height adjustment. • Height adjustment 7" (2½" above and 4½" below track). • Release handle for independent tilt adjustment. • Tilt: +/-15°. • Independent tilt and swivel mousing platform. • Positions platform flush with worksurface. • 360° rotation. • Mouse can be used in line, over, or forward at platform height or above. • Mouse can be placed at platform height or above height. • Left or right handed mousing; no tools required. • Detachable palm rest. • Cord management clips included. 	H2107	16	1.3	\$ 472
	Sit to Stand Arm with Keyboard <ul style="list-style-type: none"> • Sit to stand application. • No knob or lever for adjustment, simply lift into place. • One-hand tilt adjustment for maximum flexibility. • For use on surfaces 24" or deeper. • Height adjustment without levers. • +10°/-20° tilt adjustment. • Height adjustment 12½" (7" above and 5½" below). • Tilt and swivel mouse surface with gel palm rest. • Detachable palm rest. • Mouse pad can mount right or left. 	H2516	17	1.6	\$ 551
 Open Market	Keyboard Spacer <ul style="list-style-type: none"> • For use when attaching a keyboard tray to Coordinate™ and Voi® or Systems Worksurface with an external channel. • The kit includes ten cylinder spacers and ten screws. • Spacers are ¾"W x 2½"H. • Specify one kit per keyboard tray. 	HKBS	1	0.8	\$ 80





How to specify

Select Model Number from above



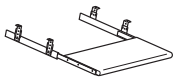

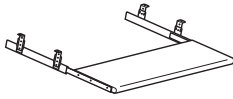
H | 1 | 7 | 0 | 6 |

Icon Legend on page 10

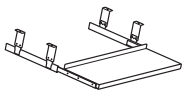

	Description	Model	Ship		L1	L2
			Weight	Cube	List	Upcharge
	Laminated Keyboard Platform Laminated Tray dimensions: 21 1/2"W x 10"D x 1 1/8" Thick • Minimum clearance for mounting: 22 1/8"W x 17"D. • Surface can be positioned 2", 2 1/2", 3" or 3 1/2" below bottom of worksurface. • Will not fit on a 37" x 24" Corner worksurface. • Specify laminate.	H4022	10 	0.6	\$ 194	\$ 15
	Laminated Keyboard Platform with Extended Tray Laminated Tray dimensions: 30"W x 10"D x 1 1/8" Thick • Minimum clearance for mounting: 32 1/2"W x 17"D • Surface can be positioned 2", 2 1/2", 3" or 3 1/2" below bottom of worksurface. • Will not fit on a 37" x 24" Corner worksurface. • Ball-bearing slide; slide and brackets are Black.	HE4022	12 	0.7	\$ 278	\$ 15

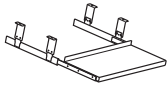
How to specify	Select Model Number from above H 4 0 2 2 .	1st Option Select Laminate See page 741 H
----------------	---	---

Description	Model	Ship Weight	Cube	List by Paint Grade		
				Core	Choice/Metallics	Custom
 Metal Keyboard Platforms 30"W Metal Keyboard and Mouse Tray. • Designed to hold keyboards and allow room for mouse pads. • Tray dimensions: 30"W x 10"D. • Minimum clearance for mounting: 32 1/2"W x 15"D. • Surface is positioned 3" below bottom of worksurface. • Non-articulating, only movement is front-to-back. Does not tilt or swivel. • Specify paint color.	H4028	11 	1.5	\$ 140	\$ 150	\$ 158
 24"W Metal Keyboard Tray. • Designed to hold ONLY keyboards. • Tray dimensions: 24"W x 10"D. • Minimum clearance for mounting: 26 1/2"W x 15"D. • Surface is positioned 3" below bottom of worksurface. • Non-articulating, only movement is front-to-back. Does not tilt or swivel. • Specify paint color.	H4029	11 	1.5	\$ 125	\$ 135	\$ 143

How to specify	Select Model Number from above H 4 0 2 8 .	1st Option Select Paint Color See page 741 T 1
----------------	---	--

  Icon Legend on page 10



▶ See specifying information below for Choice/Metallic paint and pages 9 and 435 for Custom paint ordering instructions.

▶ Laminate center drawers designed for use with Valido®/11500, 10700 and 10500 Series™.
▶ Laminate center drawers include pencil tray.

▶ All metal center drawers feature pencil trays with three compartments for storage.

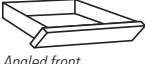

▶ All metal center drawers feature core removable locks for greater personal and departmental security.

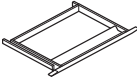

	Description	Model	Ship Weight	Cube	List
 Angled front	Laminate Center Drawer 22"W x 15 ³ / ₈ "D x 2 ¹ / ₂ "H Specify laminate.	H1522	11 	1.1	\$ 168
	26"W x 15 ³ / ₈ "D x 2 ¹ / ₂ "H Specify laminate. • Ball-bearing slide suspension. • 12" drawer extension (3/4). • Inside drawer dimension for H1522: 18 ⁷ / ₈ "W x 15 ¹ / ₂ "D x 1 ¹ / ₂ "H. • Inside drawer dimension for H1526: 22 ⁷ / ₈ "W x 15 ¹ / ₂ "D x 1 ¹ / ₂ "H. • Minimum clearance for mounting H1522: 22 ³ / ₄ "W x 18 ¹ / ₂ "D compatible with 72"W x 36"D, 66"W x 30"D, 60"W x 30"D Double Pedestal Desks, 72"W x 36"D, 66"W x 30"D Single Pedestal Desks, Bullet and P-Shaped Peninsulas, 72"W x 24"D, 66"W x 24"D, 60"W x 24"D Credenza w/Kneespace, 72"W x 24"D, 66"W x 24"D Single Pedestal Credenzas, 48"W x 24"D, 42"W x 24"D Returns • Minimum clearance for mounting H1526: 27 ¹ / ₄ "W x 18 ¹ / ₂ "D compatible with 72"W x 36"D, 66"W x 30"D, 60"W x 30"D Double Pedestal Desks, 72"W x 24"D, 66"W x 24"D, 60"W x 24"D Credenza w/Kneespace, 48"W x 24"D Return NOTES: For 60"W x 30"D Modular Desk Shells with two 15 ⁵ / ₈ "W Storage Pedestals or 60"W x 24"D Modular Credenza Shells with two 15 ⁵ / ₈ "W Storage Pedestals, use center drawer H1522.	H1526	12 	1.2	\$ 182

 Open Market	Center Drawer 26"W x 22"D x 2 ¹ / ₄ "H	HVPACCD26	20	2.3	\$ 489
	NOTES: Inside drawer dimensions: 20 ¹ / ₁₆ "W x 11 ¹ / ₁₆ "D x 1 ¹ / ₂ "H. Minimum clearance for mounting: 25 ⁵ / ₈ "W x 19"D x 2 ¹ / ₄ "H. For use with desks, peninsulas, credenzas, and returns. Ball-bearing slide suspensions. Includes pencil tray. Specify finish.				

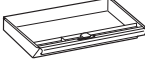
How to specify	Select Model Number from above H 1 5 2 2 .	1st Option Select Finish See page 741 H
----------------	--	---

	Description	Model	Ship Weight	Cube	List by Paint Grade		
					Core	Choice/Metallics	Custom
 Angled front	Metal Center Drawer w/Lock 19"W x 14 ³ / ₄ "D x 3"H Specify paint color. • Ball-bearing slide suspension. • 12" drawer extension (3/4). • Inside drawer dimension: 19"W x 13"D x 2 ³ / ₈ "H. • Minimum clearance for mounting: 21 ³ / ₄ "W x 19 ¹ / ₄ "D. • Core removable lock.	HD2	9 	1.0	\$ 227	\$ 237	\$ 245
	24 ³ / ₄ "W x 14 ³ / ₄ "D x 3"H Specify paint color. • Ball-bearing slide suspension. • 12" drawer extension (3/4). • Inside drawer dimension: 24 ¹ / ₂ "W x 13"D x 2 ³ / ₈ "H. • Minimum clearance for mounting: 27 ³ / ₈ "W x 19 ¹ / ₄ "D. • Core removable lock.	HD8	12 	1.2	\$ 227	\$ 237	\$ 245

How to specify	Select Model Number from above H D 2 .	1st Option Select Paint Color See page 741 T 1
----------------	--	--

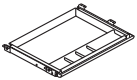
	Description	Model	Ship Weight	Cube	List
 Open Market	Polymer Center Drawer • Color: Black. • Material: ABS. • Opening Requirements: 23"W x 16 ¹ / ₄ "D x 2"H. • Retracts on 16" ball bearing slides. • Can be used on worksurfaces with Coordinate™ and basyx by HON® Height Adjustable Bases as long as it is attached with spacer model HKBS. • Can store up to 25 lbs. ▲ Black finish only, no specification needed.	HCD1	7	0.5	\$ 96

How to specify	Select Model Number from above H C D 1
----------------	--

    Icon Legend on page 10





















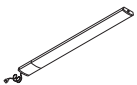

Task Lights

GSA SIN 711-1 Except as Noted



- ▶ Choose from a variety of task lights that mount under overhead storage or sit on the worksurface.
- ▶ LED Task Lights have a wide range of motion for precise placement.



	Description	Model	Ship		List
			Weight	Cube	
	Articulating Desk Lamp	HLED1	1.2 	6.5	\$ 350
	Articulating Desk Lamp w/ Occupancy Sensor <ul style="list-style-type: none"> • Color: Matte Silver. • Full-range dimming from 10% to 100%. • Designed for 50,000 hours of life. • Occupancy sensor is built into the head of the lamp and will automatically shut the lamp off after 6 minutes of undetected movement. • Base swivel is 180 degrees. • Uses only 5 watts of energy. • Light comes with a silver 9' 4" power cord. • Base diameter is 7.5". • 3500K Color Temperature. • 80 Color Rendering Index. • TAA Compliant. 	HLED10C	1.2 	6.5	\$ 428
	Task Desk Lamp <ul style="list-style-type: none"> • Color: Brushed Nickel. • Full-range dimming from 10% to 100%. • Designed for 50,000 hours of life. • Lamp is 15.83" tall. • Desk lamp does not articulate at base. The pivoting head provides custom positioning, as it can be twisted 360 degrees. • Uses only 5 watts of energy. • Light comes with a silver 9' 4" power cord. • Base diameter is 6.7". • 3500K Color Temperature. • 80 Color Rendering Index. • TAA Compliant. 	HLED2	0.7 	3.0	\$ 303
	Recessed Task Lights <ul style="list-style-type: none"> • Color: Black. • Slim profile design. • Mount to stack-on storage and wall mounted storage cabinets. • Electronic ballast for increased energy efficiency. • T5 bulb, included, which contains less mercury. • 9-foot black cord and switch off right rear corner. 				
	18 ³ / ₈ "W x 3 ¹¹ / ₁₆ "D x 1 ¹ / ₈ "H Chicago code version (with fused plug)	HH870924	5.0 	0.4	\$ 201
	22 ⁷ / ₈ "W x 3 ¹¹ / ₁₆ "D x 1 ¹ / ₈ "H Chicago code version (with fused plug)	HH870924CH	5.0 	0.4	\$ 262
	22 ⁷ / ₈ "W x 3 ¹¹ / ₁₆ "D x 1 ¹ / ₈ "H Chicago code version (with fused plug)	HH870930	7.0 	0.6	\$ 205
	34 ⁵ / ₈ "W x 3 ¹¹ / ₁₆ "D x 1 ¹ / ₈ "H Chicago code version (with fused plug)	HH870930CH	7.0 	0.6	\$ 268
	34 ⁵ / ₈ "W x 3 ¹¹ / ₁₆ "D x 1 ¹ / ₈ "H Chicago code version (with fused plug)	HH870942	10.0 	0.9	\$ 222
	46 ¹ / ₂ "W x 3 ¹¹ / ₁₆ "D x 1 ¹ / ₈ "H Chicago code version (with fused plug)	HH870942CH	10.0 	0.9	\$ 282
	46 ¹ / ₂ "W x 3 ¹¹ / ₁₆ "D x 1 ¹ / ₈ "H Chicago code version (with fused plug)	HH870960	12.0 	1.1	\$ 240
	46 ¹ / ₂ "W x 3 ¹¹ / ₁₆ "D x 1 ¹ / ₈ "H Chicago code version (with fused plug)	HH870960CH	12.0 	1.1	\$ 300
	LED Task Lights				
	17" LED Light with Power Supply (Single)	HLED17AS	1.2 	0.05	\$ 374
31" LED Light with Power Supply (Single)	HLED31AS	1.5 	0.09	\$ 503	
17" LED Light with Power Supply for Daisy-chain (Starter)	HLED17A	1.0 	0.05	\$ 411	
31" LED Light with Power Supply for Daisy-chain (Starter)	HLED31A	1.4 	0.09	\$ 553	
17" LED Light with 8" Jumper Cord for Daisy-chain (Follower)	HLED17AUO	1.0 	0.03	\$ 335	
31" LED Light with 8" Jumper Cord for Daisy-chain (Follower)	HLED31AUO	1.0 	0.05	\$ 448	
Undercabinet Occupancy Sensor with 1" End to End Connector	HLEDOSA	0.2 	0.01	\$ 78	

NOTES: To use the daisy chain application, must start with model HLED17A or HLED31A. No finish specification required. Attaches magnetically to underside of overhead storage or attaches with provided screws. Occupancy sensor attaches to a single or starter LED light and will automatically turn the light off after no motion is detected for 30 minutes. Just like all the LED light models, the occupancy sensor features a soft-touch on/off switch. LED task lights have a lifetime of 50,000 hours and have a dimmer feature that allows the user to adjust the amount of light output.

How to specify	<p>Select Model Number from above</p> <p>H L E D 1</p>
----------------	--

  Icon Legend on page 10

- ▶ Touch-up kit allows minor repairs in the field.
- ▶ Kit includes markers for small touch-ups to metal casegoods products.
- ▶ Shippable by small package carrier, ground only.
- ▶ **Model HPKT001 includes:**
 - 1 Marker each of Black (P), Charcoal (S), Greige (T5), Light Gray (Q), Loft (LOFT), Muslin (T3), Putty (L) and Shadow (SHDW).
- ▶ **Model HPMARKER1 includes:**
 - 1 Marker (color must be specified when ordering).



	Description	Model	Ship		List
			Weight	Cube	
	Touch-up Kit, includes all 8 Core paint colors	HPKT001	0.3	0.1	\$ 148
	1 Touch-up Marker Available in: Black (P), Charcoal (S), Greige (T5), Light Gray (Q), Loft (LOFT), Muslin (T3), Putty (L) and Shadow (SHDW). ⚠ Metallic colors available only in touch-up paint, not markers.	HPMARKER1	0.1	0.1	\$ 38

How to specify	Select Model Number from above	1st Option
	Select Model Number from above <div style="border: 1px solid black; padding: 2px; display: inline-block;"> H P K T 0 0 1 </div> <div style="border: 1px solid black; padding: 2px; display: inline-block;"> H P M A R K E R 1 . P </div>	Select Color P Black S Charcoal T5 Greige Q Light Gray LOFT Loft T3 Muslin L Putty SHDW Shadow

Icon Legend on page 10

Bundles

What is a Bundled Solution?

A bundled solution is comprised of several individual components and is ordered with a single, all-encompassing number (SKU).

Why Bundles?

With bundles, you identify one SKU rather than multiple models/SKUs. Order one SKU and get everything you need!

How do you order a bundle?

Get everything in this picture with one number.

Still Prefer Ordering Individual Components?

You can do that! See the "bundle components" section for individual item SKUs.

Contemporary U-Station SKU

VC7292U1B

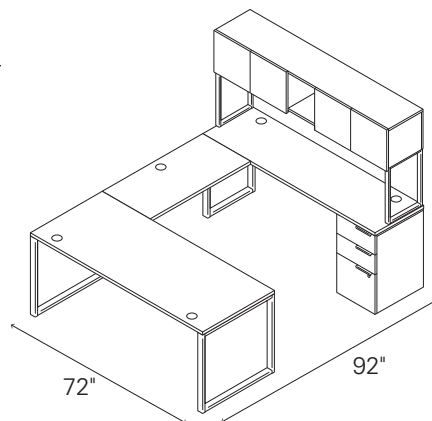

With this bundle you get the following components:

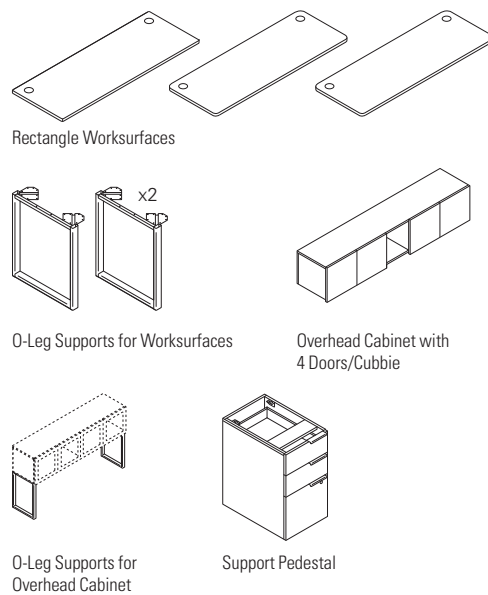

Availability

Specific bundle options are now available in the following HON Series:

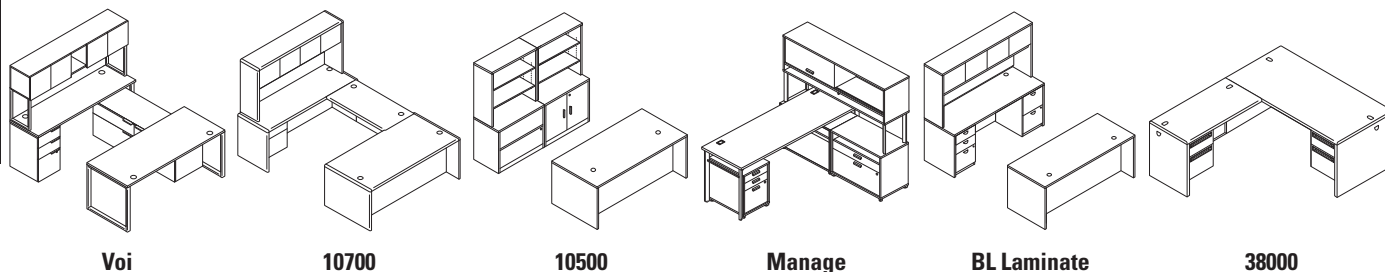
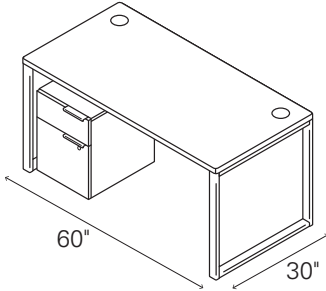

Table Desk with Mobile Pedestal (Non-handed)



VT6030MB

Worksurface is Silver Mesh, Mobile Pedestal is Harvest, O-Leg Supports and grommets are Platinum Metallic.

Qty.	Model #	Description	List Price	Price Extension
1	HLSLR3060W*	Rectangle Worksurface with External Support Channel	\$406	\$ 406
2	HLSL30280	O-Leg Support for Worksurface	\$314	\$ 628
1	HLSL2016MP2	Mobile Pedestal	\$716	\$ 716
TOTAL:			\$1,750	

Small Footprint L-Station (Non-handed)

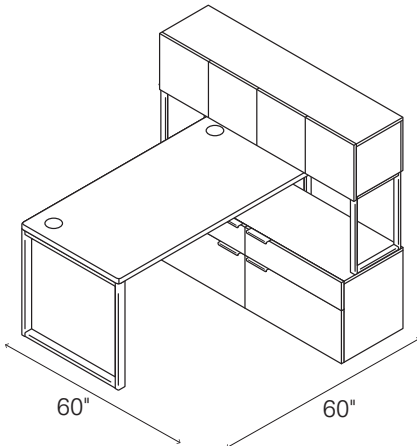

VS6060L1B

Worksurface is Silver Mesh, Low Credenza and Overhead Cabinet are Harvest, O-Leg Supports and grommets are Platinum Metallic.

Qty.	Model #	Description	List Price	Price Extension
1	HLSLR3060W*	Rectangle Worksurface with External Support Channel	\$ 406	\$ 406
2	HLSL30280	O-Leg Support for Worksurface	\$ 314	\$ 628
1	HLSL2060LD4	Low Credenza, 2 File/2 Box	\$1,320	\$1,320
1	HLSL1460D	Overhead Cabinet with 4 Doors	\$1,027	\$1,027
1	HLSL650S	O-Leg Support for Overhead Cabinet (Pair)	\$ 417	\$ 417
TOTAL:			\$3,798	

Small Footprint L-Station (Right Handed, Low Credenza)

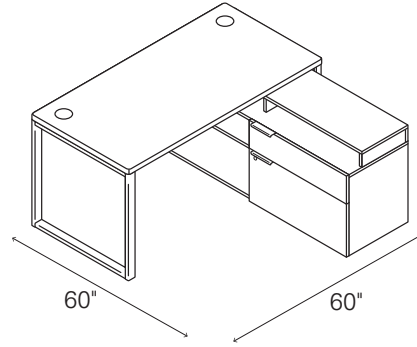

VS6060L6B

Worksurface is Silver Mesh, Low Credenza and Layering Shelf are Harvest, O-Leg Supports and grommets are Platinum Metallic.

Qty.	Model #	Description	List Price	Price Extension
1	HLSLR3060W*	Rectangle Worksurface with External Support Channel	\$ 406	\$ 406
2	HLSL30280	O-Leg Support for Worksurface	\$ 314	\$ 628
1	HLSL2060LR2	Low Credenza, Right-hand Drawers	\$1,131	\$1,131
1	HLSL1460LS	Layering Shelf	\$ 321	\$ 321
TOTAL:			\$2,486	

Small Footprint L-Station (Left Handed, Low Credenza)

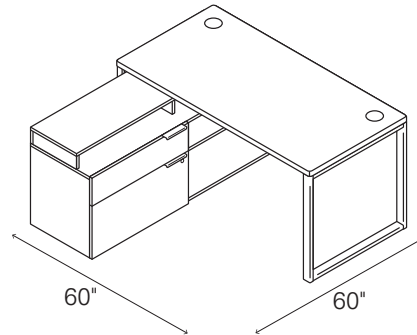

VS6060L4B

Worksurface is Silver Mesh, Low Credenza and Layering Shelf are Harvest, O-Leg Supports and grommets are Platinum Metallic.

Qty.	Model #	Description	List Price	Price Extension
1	HLSLR3060W*	Rectangle Worksurface with External Support Channel	\$ 406	\$ 406
2	HLSL30280	O-Leg Support for Worksurface	\$ 314	\$ 628
1	HLSL2060LL2	Low Credenza, Left-hand Drawers	\$1,131	\$1,131
1	HLSL1460LS	Layering Shelf	\$ 321	\$ 321
TOTAL:			\$2,486	

*Worksurface model HLSLR3060W can only be ordered with bundles.

Voi® Bundles Typicals

Small Footprint L-Station (Right Handed, Low Credenza)

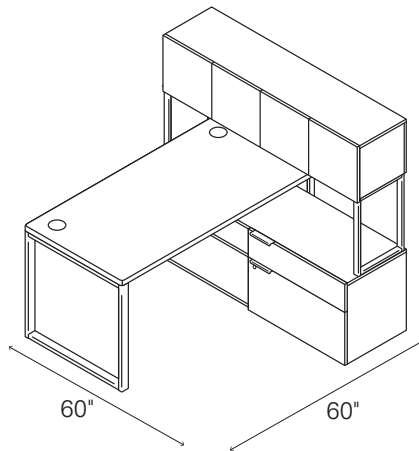

VS6060L5B

Worksurface is Silver Mesh, Low Credenza and Overhead Cabinet are Harvest, O-Leg Supports and grommets are Platinum Metallic.

Qty.	Model #	Description	List Price	Price Extension
1	HLSLR3060W*	Rectangle Worksurface with External Support Channel	\$ 406	\$ 406
2	HLSL30280	O-Leg Support for Worksurface	\$ 314	\$ 628
1	HLSL2060LR2	Low Credenza, Right-hand Drawers	\$1,131	\$1,131
1	HLSL1460D	Overhead Cabinet with 4 Doors	\$1,027	\$1,027
1	HLSL650S	O-Leg Support for Overhead Cabinet (Pair)	\$ 417	\$ 417
TOTAL:			\$3,609	

Small Footprint L-Station (Left Handed, Low Credenza)

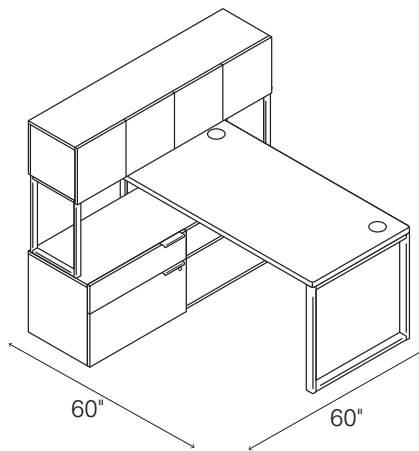

VS6060L3B

Worksurface is Silver Mesh, Low Credenza and Overhead Cabinet are Harvest, O-Leg Supports and grommets are Platinum Metallic.

Qty.	Model #	Description	List Price	Price Extension
1	HLSLR3060W*	Rectangle Worksurface with External Support Channel	\$ 406	\$ 406
2	HLSL30280	O-Leg Support for Worksurface	\$ 314	\$ 628
1	HLSL2060LL2	Low Credenza, Left-hand Drawers	\$1,131	\$1,131
1	HLSL1460D	Overhead Cabinet with 4 Doors	\$1,027	\$1,027
1	HLSL650S	O-Leg Support for Overhead Cabinet (Pair)	\$ 417	\$ 417
TOTAL:			\$3,609	

Contemporary L-Station (Non-handed)

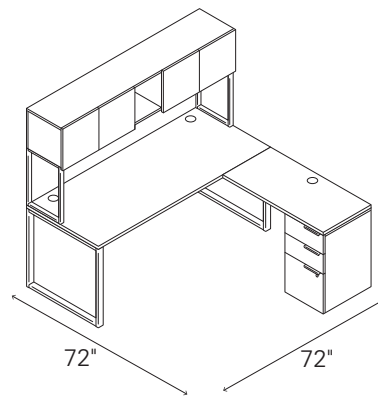

VC7272L1B2

Worksurfaces and Overhead Cabinet are Brilliant White, Support Pedestal is Harvest, O-Leg Supports and grommets are Platinum Metallic.

Qty.	Model #	Description	List Price	Price Extension
1	HLSLR3072W*	Rectangle Worksurface with External Support Channel	\$ 481	\$ 481
1	HLSLR2042	Rectangle Worksurface	\$ 230	\$ 230
2	HLSL30280	O-Leg Support for Worksurface	\$ 314	\$ 628
1	HLSL2028B	Support Pedestal, Box/Box/File	\$ 609	\$ 609
1	HLSL1472D	Overhead Cabinet with 4 Doors/Cubbie	\$1,239	\$1,239
1	HLSL650S	O-Leg Support for Overhead Cabinet (Pair)	\$ 417	\$ 417
TOTAL:			\$3,604	

Small Footprint L-Station (Low Credenza, Layering Shelf) (Non-handed)

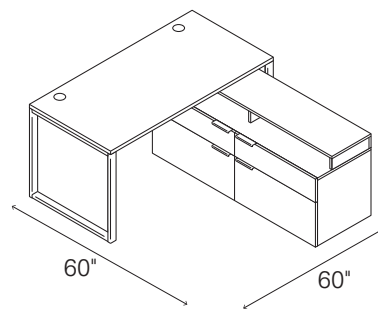

VS6060L2B

Worksurface is Silver Mesh, Low Credenza and Layering Shelf are Harvest, O-Leg Supports and grommets are Platinum Metallic.

Qty.	Model #	Description	List Price	Price Extension
1	HLSLR3060W*	Rectangle Worksurface with External Support Channel	\$ 406	\$ 406
2	HLSL30280	O-Leg Support for Worksurface	\$ 314	\$ 628
1	HLSL2060LD4	Low Credenza, 2 File/2 Box	\$1,320	\$1,320
1	HLSL1460LS	Layering Shelf	\$ 321	\$ 321
TOTAL:			\$2,675	

*Worksurface models **HLSLR3060W** and **HLSLR3072W** can only be ordered with bundles.

Contemporary U-Station (Low Credenza, Overhead Cabinet) (Non-handed)

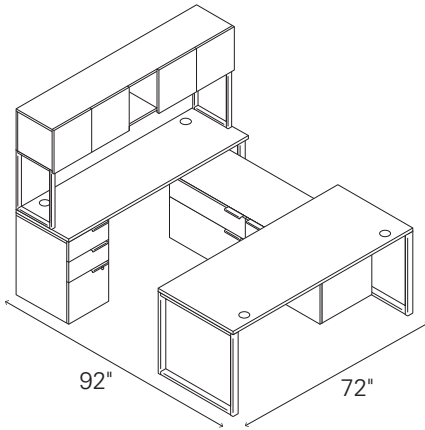

VC7292U2B2

Worksurfaces and Overhead Cabinet are Brilliant White, Low Credenza and Support Pedestal are Harvest, O-Leg Supports and grommets are Platinum Metallic.

Qty.	Model #	Description	List Price	Price Extension
1	HLSLR3072W*	Rectangle Worksurface with External Support Channel	\$ 481	\$ 481
1	HLSLR2072W*	Rectangle Worksurface with External Support Channel	\$ 395	\$ 395
2	HLSL30280	O-Leg Support for Worksurface	\$ 314	\$ 628
1	HLSL20280	O-Leg Support for Worksurface	\$ 260	\$ 260
1	HLSL2028B	Support Pedestal, Box/Box/File	\$ 609	\$ 609
1	HLSL1472D	Overhead Cabinet with 4 Doors/Cubbie	\$1,239	\$1,239
1	HLSL650S	O-Leg Support for Overhead Cabinet (Pair)	\$ 417	\$ 417
1	HLSL2060LD4	Low Credenza, 2 File/2 Box	\$1,320	\$1,320
TOTAL:			\$5,349	

Contemporary L-Station (Non-handed)

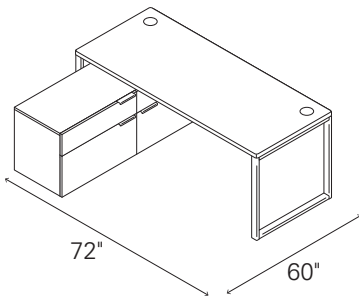

VC7260L2B

Worksurface is Silver Mesh, Low Credenza is Harvest, O-Leg Supports and grommets are Platinum Metallic.

Qty.	Model #	Description	List Price	Price Extension
1	HLSLR3072W*	Rectangle Worksurface with External Support Channel	\$ 481	\$ 481
2	HLSL30280	O-Leg Support for Worksurface	\$ 314	\$ 628
1	HLSL2060LD4	Low Credenza, 2 File/2 Box	\$1,320	\$1,320
TOTAL:			\$2,429	

Contemporary U-Station (Non-handed)

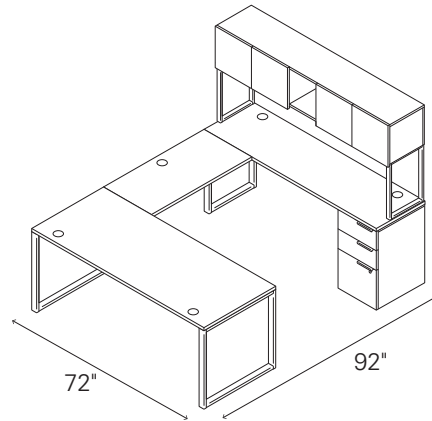

VC7292U1B2

Worksurfaces and Overhead Cabinet are Brilliant White, Support Pedestal is Harvest, O-Leg Supports and grommets are Platinum Metallic.

Qty.	Model #	Description	List Price	Price Extension
1	HLSLR3072W*	Rectangle Worksurface with External Support Channel	\$ 481	\$ 481
1	HLSLR2072W*	Rectangle Worksurface with External Support Channel	\$ 395	\$ 395
1	HLSLR2042	Rectangle Worksurface	\$ 230	\$ 230
2	HLSL30280	O-Leg Support for Worksurface	\$ 314	\$ 628
1	HLSL20280	O-Leg Support for Worksurface	\$ 260	\$ 260
1	HLSL1472D	Overhead Cabinet with 4 Doors/Cubbie	\$1,239	\$1,239
1	HLSL650S	O-Leg Support for Overhead Cabinet (Pair)	\$ 417	\$ 417
1	HLSL2028B	Support Pedestal, Box/Box/File	\$ 609	\$ 609
TOTAL:			\$4,259	

*Worksurface models HLSLR3072W and HLSLR2072W can only be ordered with bundles.

10500 Series™ Bundles Typicals



L-Station (Left Desk/Right Return)

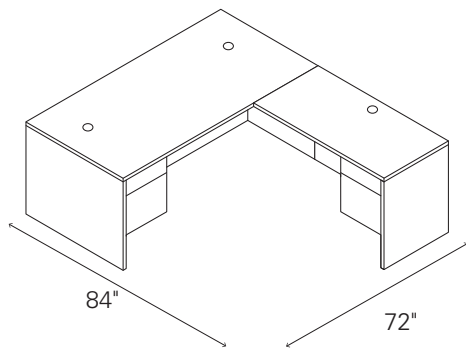

Mahogany
H105LL7284N

Harvest
H105LL7284C

Qty.	Model #	Description	List Price	Price Extension
1	H10586L	Left Pedestal Desk	\$1,093	\$1,093
1	H10515R	Right Return	\$ 774	\$ 774
TOTAL:			\$1,867	

L-Station (Right Desk/Left Return)

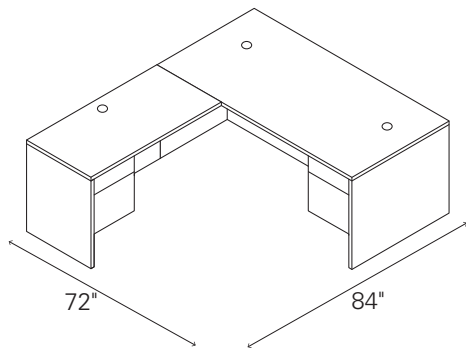

Mahogany
H105LR7284N

Harvest
H105LR7284C

Qty.	Model #	Description	List Price	Price Extension
1	H10585R	Right Pedestal Desk	\$1,093	\$1,093
1	H10516L	Left Return	\$ 774	\$ 774
TOTAL:			\$1,867	

L-Station with Stack-on Storage (Left Desk/Right Return)

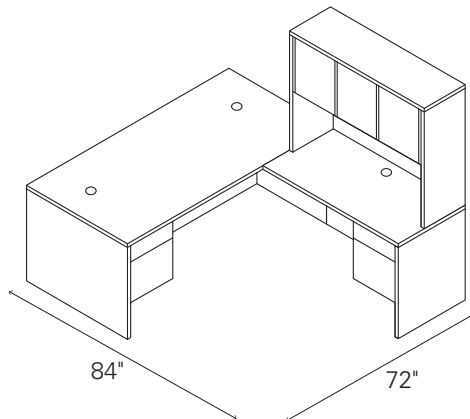

Mahogany
H105LLH7284N

Harvest
H105LLH7284C

Qty.	Model #	Description	List Price	Price Extension
1	H10586L	Left Pedestal Desk	\$1,093	\$1,093
1	H10515R	Right Return	\$ 774	\$ 774
1	H105323	Stack-on Storage	\$ 785	\$ 785
TOTAL:			\$2,652	

L-Station with Stack-on Storage (Right Desk/Left Return)

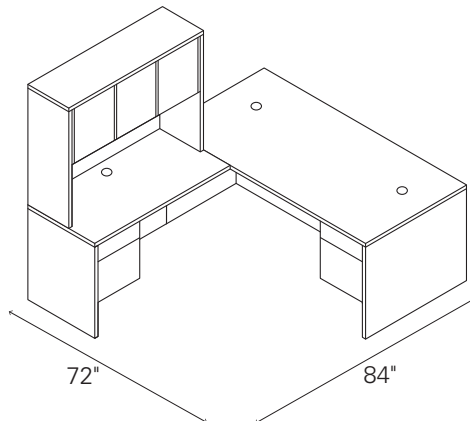

Mahogany
H105LRH7284N

Harvest
H105LRH7284C

Qty.	Model #	Description	List Price	Price Extension
1	H10585R	Right Pedestal Desk	\$1,093	\$1,093
1	H10516L	Left Return	\$ 774	\$ 774
1	H105323	Stack-on Storage	\$ 785	\$ 785
TOTAL:			\$2,652	

U-Station with Stack-on Storage (Left Desk/Right Credenza)

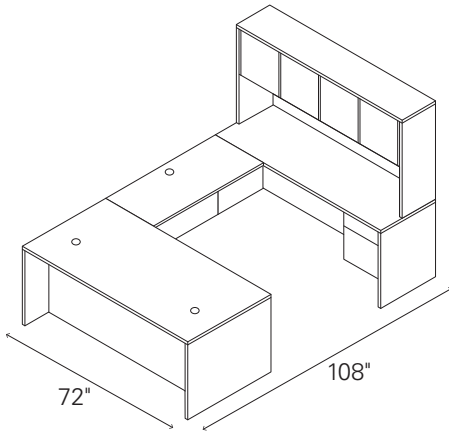

Mahogany
H105ULH72108N

Harvest
H105ULH72108C

Qty.	Model #	Description	List Price	Price Extension
1	H10586L	Left Pedestal Desk	\$1,093	\$1,093
1	H10545R	Right Pedestal Credenza	\$ 945	\$ 945
1	H10570	Bridge	\$ 335	\$ 335
1	H10534	Stack-on Storage	\$ 935	\$ 935
TOTAL:			\$3,308	\$3,308

U-Station with Stack-on Storage (Right Desk/Left Credenza)

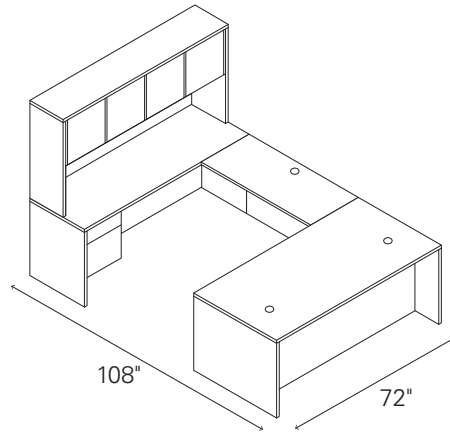

Mahogany
H105URH72108N

Harvest
H105URH72108C

Qty.	Model #	Description	List Price	Price Extension
1	H10585R	Right Pedestal Desk	\$1,093	\$1,093
1	H10546L	Left Pedestal Credenza	\$ 945	\$ 945
1	H10570	Bridge	\$ 335	\$ 335
1	H10534	Stack-on Storage	\$ 935	\$ 935
TOTAL:			\$3,308	\$3,308

10500 Series™ Bundles Typicals

Storage Workstation

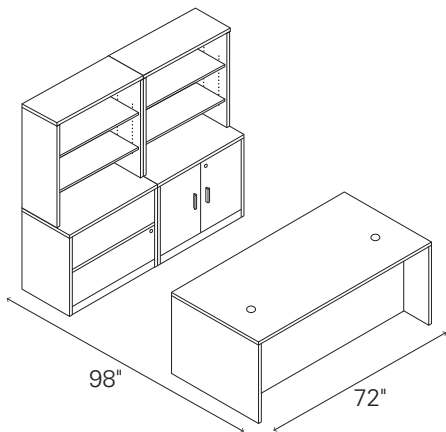

Mahogany
H105DLH7298N

Harvest
H105DLH7298C

Qty.	Model #	Description	List Price	Price Extension
1	H10593	Double Pedestal Desk	\$1,287	\$1,287
2	H105292	Bookcase Hutch	\$ 527	\$1,054
1	H10563	2-Drawer Lateral File	\$ 899	\$ 899
1	H105291	Storage Cabinet with Doors	\$ 722	\$ 722
TOTAL:			\$3,962	

Desk Credenza Stack-on #2

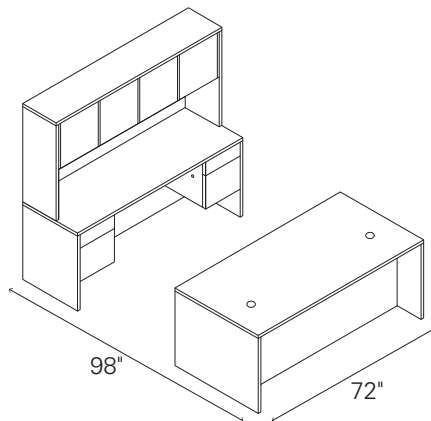

Mahogany
H105DCH7298N

Harvest
H105DCH7298C

Qty.	Model #	Description	List Price	Price Extension
1	H10593	Double Pedestal Desk	\$1,287	\$1,287
1	H10543	Double Pedestal Credenza	\$1,147	\$1,147
1	H10534	Stack-on Storage	\$ 935	\$ 935
TOTAL:			\$3,369	

Desk Credenza Stack-on #1

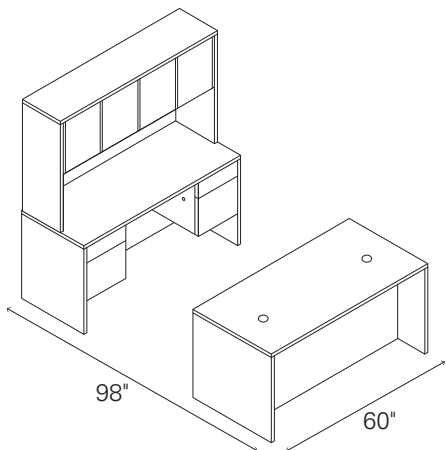

Mahogany
H105DCH6098N

Harvest
H105DCH6098C

Qty.	Model #	Description	List Price	Price Extension
1	H10573	Double Pedestal Desk	\$1,084	\$1,084
1	H10565	Double Pedestal Credenza	\$1,084	\$1,084
1	H105324	Stack-on Storage	\$ 872	\$ 872
TOTAL:			\$3,040	

L-Station (Left Desk, Right Return)

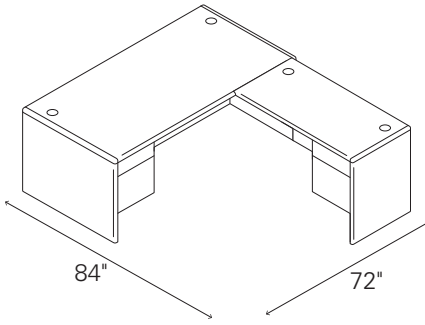

Mahogany
H107LL7284N

Qty.	Model #	Description	List Price	Price Extension
1	H10786L	Left Pedestal Desk	\$1,181	\$1,181
1	H10715R	Right Return	\$ 793	\$ 793
TOTAL:			\$1,974	

L-Station (Right Desk, Left Return)

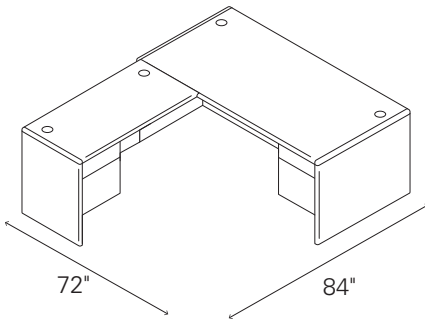

Mahogany
H107LR7284N

Qty.	Model #	Description	List Price	Price Extension
1	H10785R	Right Pedestal Desk	\$1,181	\$1,181
1	H10716L	Left Return	\$ 793	\$ 793
TOTAL:			\$1,974	

U-Station (Left Desk, Right Credenza)

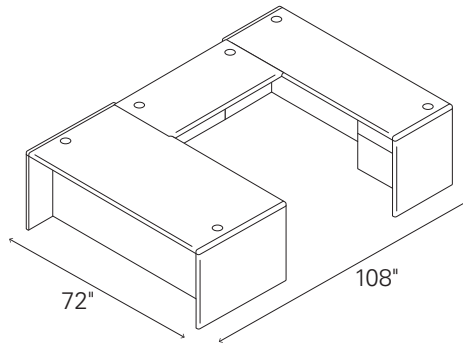

Mahogany
H107UL72108N

Qty.	Model #	Description	List Price	Price Extension
1	H10786L	Left Pedestal Desk	\$1,181	\$1,181
1	H10745R	Right Pedestal Credenza	\$1,035	\$1,035
1	H10770	Bridge	\$ 358	\$ 358
TOTAL:			\$2,574	

U-Station (Right Desk, Left Credenza)

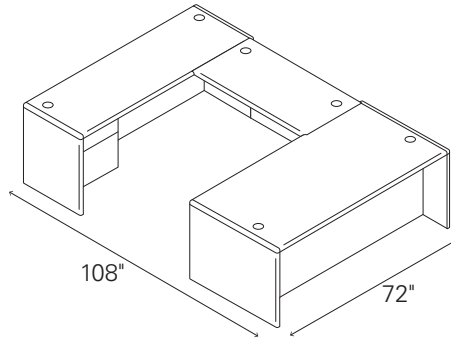

Mahogany
H107UR72108N

Qty.	Model #	Description	List Price	Price Extension
1	H10785R	Right Pedestal Desk	\$1,181	\$1,181
1	H10746L	Left Pedestal Credenza	\$1,035	\$1,035
1	H10770	Bridge	\$ 358	\$ 358
TOTAL:			\$2,574	

10700 Series™ Bundles Typical

L-Station with Stack-on Storage (Left Desk, Right Return)

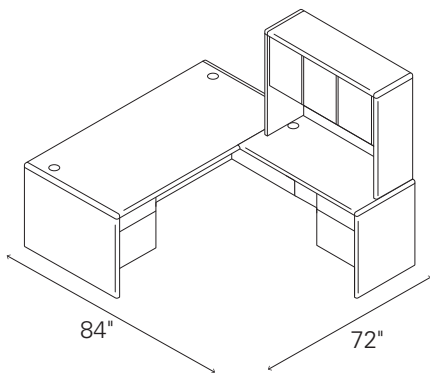

Mahogany
H107LLH7284N

Qty.	Model #	Description	List Price	Price Extension
1	H10786L	Left Pedestal Desk	\$1,181	\$1,181
1	H10715R	Right Return	\$ 793	\$ 793
1	H107313	Stack-on Storage	\$ 935	\$ 935
TOTAL:			\$2,909	

L-Station with Stack-on Storage (Right Desk, Left Return)

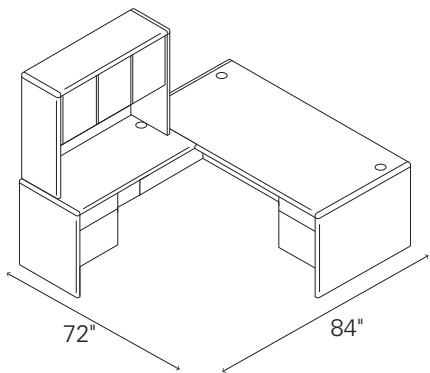

Mahogany
H107LRH7284N

Qty.	Model #	Description	List Price	Price Extension
1	H10785R	Right Pedestal Desk	\$1,181	\$1,181
1	H10716L	Left Return	\$ 793	\$ 793
1	H107313	Stack-on Storage	\$ 935	\$ 935
TOTAL:			\$2,909	

U-Station with Stack-on Storage (Left Desk, Right Credenza)

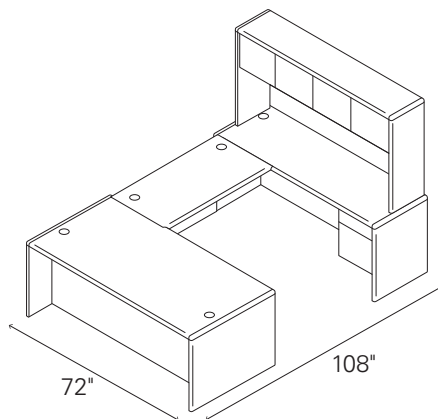

Mahogany
H107ULH72108N

Qty.	Model #	Description	List Price	Price Extension
1	H10786L	Left Pedestal Desk	\$1,181	\$1,181
1	H10745R	Right Pedestal Credenza	\$1,035	\$1,035
1	H10770	Bridge	\$ 358	\$ 358
1	H10734	Stack-on Storage	\$1,062	\$1,062
TOTAL:			\$3,636	

U-Station with Stack-on Storage (Right Desk, Left Credenza)

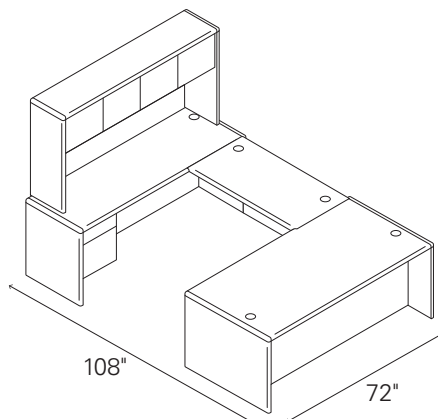

Mahogany
H107URH72108N

Qty.	Model #	Description	List Price	Price Extension
1	H10785R	Right Pedestal Desk	\$1,181	\$1,181
1	H10746L	Left Pedestal Credenza	\$1,035	\$1,035
1	H10770	Bridge	\$ 358	\$ 358
1	H10734	Stack-on Storage	\$1,062	\$1,062
TOTAL:			\$3,636	

L-Station (Left Desk/Right Return)

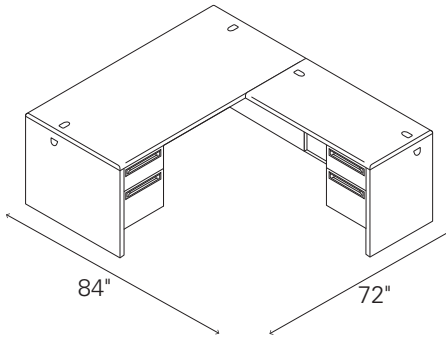

Mahogany/Charcoal
H38LL7284NS

Harvest/Putty
H38LL7284CL

Qty.	Model #	Description	List Price	Price Extension
1	H38294L	Left Pedestal Desk	\$1,508	\$1,508
1	H38215R	Right Return	\$ 912	\$ 912
TOTAL:			\$2,420	\$2,420

L-Station (Right Desk/Left Return)

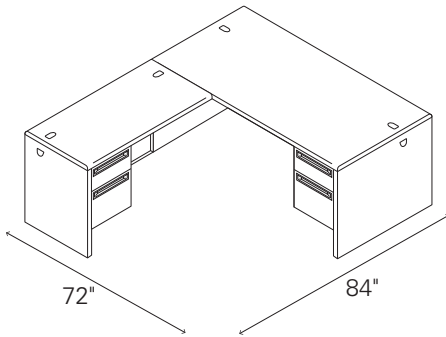

Mahogany/Charcoal
H38LR7284NS

Harvest/Putty
H38LR7284CL

Qty.	Model #	Description	List Price	Price Extension
1	H38293R	Right Pedestal Desk	\$1,508	\$1,508
1	H38216L	Left Return	\$ 912	\$ 912
TOTAL:			\$2,420	\$2,420

U-Station with Hutch (Right Desk/Left Credenza)

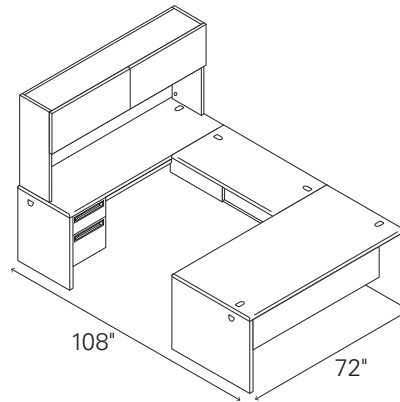

Mahogany/Charcoal
H38URH72108NS2

Harvest/Putty
H38URH72108CL2

Qty.	Model #	Description	List Price	Price Extension
1	H38293R	Single Pedestal Desk, Right	\$1,508	\$1,508
1	H38855L	Single Pedestal Credenza, Left	\$1,252	\$1,252
1	H386572N	Hutch without Doors	\$ 796	\$ 796
1	H387215	Flipper Doors, Pair	\$ 454	\$ 454
1	H38210	Bridge	\$ 506	\$ 506
TOTAL:			\$4,516	\$4,516

U-Station with Hutch (Left Desk/Right Credenza)

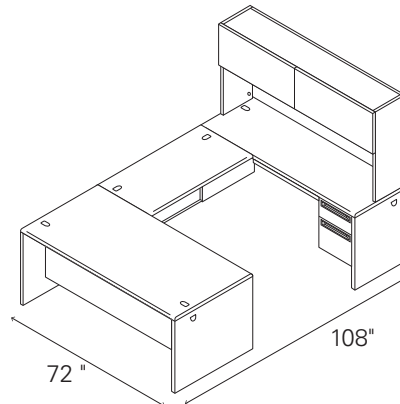

Mahogany/Charcoal
H38ULH72108NS2

Harvest/Putty
H38ULH72108CL2

Qty.	Model #	Description	List Price	Price Extension
1	H38294L	Single Pedestal Desk, Left	\$1,508	\$1,508
1	H38856R	Single Pedestal Credenza, Right	\$1,252	\$1,252
1	H386572N	Hutch without Doors	\$ 796	\$ 796
1	H387215	Flipper Doors, Pair	\$ 454	\$ 454
1	H38210	Bridge	\$ 506	\$ 506
TOTAL:			\$4,516	\$4,516

38000 Desks Bundles Typicals

Workstation

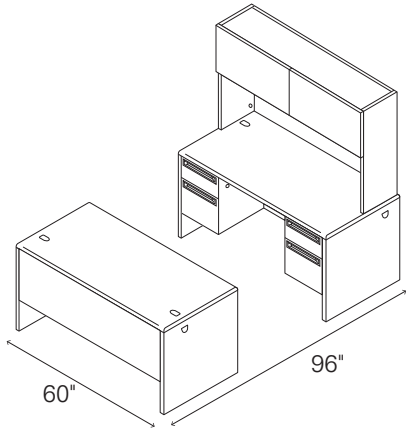

Mahogany/Charcoal
H38DCH6096NS2

Harvest/Putty
H38DCH6096CL2

Qty.	Model #	Description	List Price	Price Extension
1	H38155	Double Pedestal Desk	\$1,447	\$1,447
1	H38852	Double Pedestal Credenza	\$1,412	\$1,412
1	H386560N	Hutch without Doors	\$ 699	\$ 699
1	H386015	Flipper Doors, Pair	\$ 428	\$ 428
TOTAL:			\$3,986	

Table Desk with Pedestal

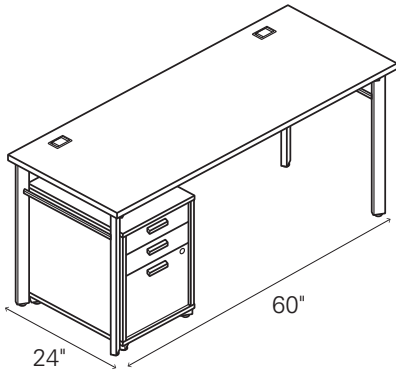

Wheat
HMLDP6024W

Chestnut
HMLDP6024C

Qty.	Model #	Description	List Price	Price Extension
1	HMNG60WKS	Worksurface	\$209	\$209
2	HMNGDLEG	Desk Leg (single)	\$ 88	\$176
1	HMNG15PED	Pedestal	\$364	\$364
TOTAL:			\$749	

L-Station with Storage

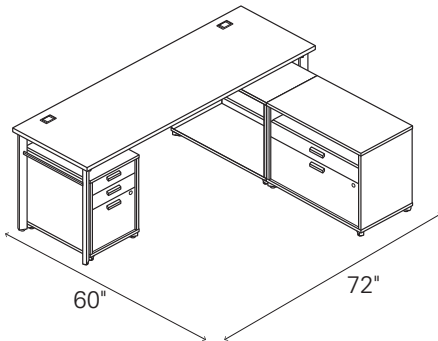

Wheat
HMLDPF7260W

Chestnut
HMLDPF7260C

Qty.	Model #	Description	List Price	Price Extension
1	HMNG72WKS	Worksurface	\$242	\$ 242
2	HMNGDLEG	Desk Leg (single)	\$ 88	\$ 176
1	HMNG15PED	Pedestal	\$364	\$ 364
1	HMNG30FCD	File Center	\$509	\$ 509
1	HMNG30FCO	File Center	\$319	\$ 319
TOTAL:			\$1,610	

L-Station with Storage

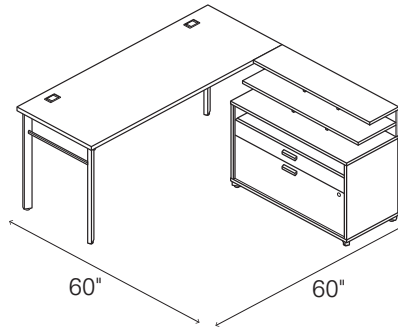

Wheat
HMLDF6060W

Chestnut
HMLDF6060C

Qty.	Model #	Description	List Price	Price Extension
1	HMNG60WKS	Worksurface	\$209	\$ 209
2	HMNGDLEG	Desk Leg (single)	\$ 88	\$ 176
1	HMNG36FCD	File Center	\$566	\$ 566
1	HMNG36STDM	Stadium	\$127	\$ 127
TOTAL:			\$1,078	

L-Station with Storage and Overhead

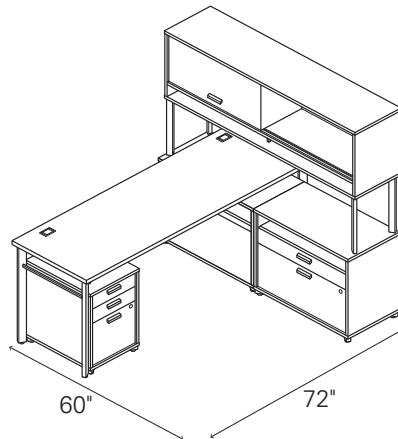

Wheat
HMLDPFO7260W

Chestnut
HMLDPFO7260C

Qty.	Model #	Description	List Price	Price Extension
1	HMNG72WKS	Worksurface	\$242	\$ 242
2	HMNGDLEG	Desk Leg (single)	\$ 88	\$ 176
1	HMNG15PED	Pedestal	\$364	\$ 364
1	HMNG30FCD	File Center	\$509	\$ 509
1	HMNG30FCO	File Center	\$319	\$ 319
1	HMNG60OVRD	Overhead	\$305	\$ 305
1	HMNGOHLEG	Overhead Leg	\$111	\$ 111
TOTAL:			\$2,026	

L-Station with Pedestal, Storage and Overhead

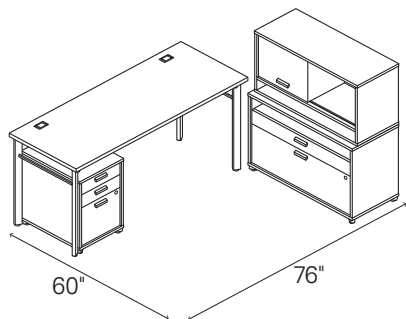

Wheat
HMLDPF07660W

Chestnut
HMLDPF07660C

Qty.	Model #	Description	List Price	Price Extension
1	HMNG60WKS	Worksurface	\$209	\$ 209
2	HMNGDLEG	Desk Leg (single)	\$ 88	\$ 176
1	HMNG15PED	Pedestal	\$364	\$ 364
1	HMNG36OVRD	Overhead	\$221	\$ 221
1	HMNG36FCD	File Center	\$566	\$ 566
TOTAL:			\$1,536	

L-Station with Stadium and Work Wall

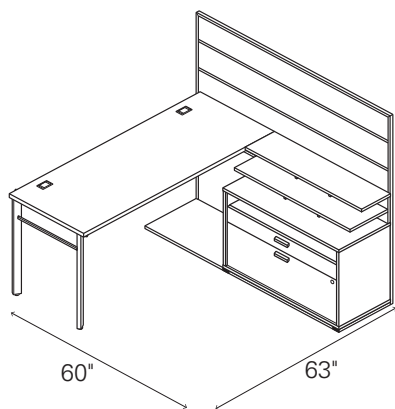

Wheat
HMLDFW6160W

Chestnut
HMLDFW6160C

Qty.	Model #	Description	List Price	Price Extension
1	HMNG60WKS	Worksurface	\$209	\$ 209
1	HMNGDLEG	Desk Leg (single)	\$ 88	\$ 88
1	HMNGWKWL	Work Wall	\$542	\$ 542
1	HMNG36FCD	File Center	\$566	\$ 566
1	HMNG36STDM	Stadium	\$127	\$ 127
TOTAL:			\$1,532	

Desk, Credenza Workstation with Overhead Storage

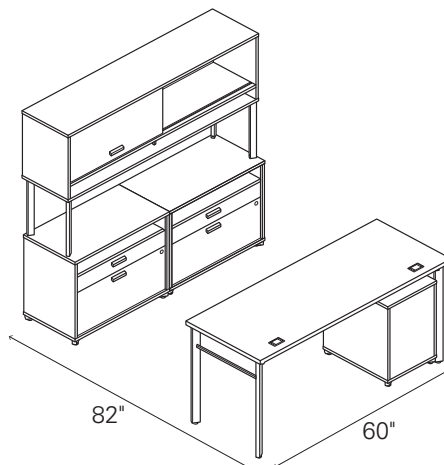

Wheat
HMLDPF06082W

Chestnut
HMLDPF06082C

Qty.	Model #	Description	List Price	Price Extension
1	HMNG60WKS	Worksurface	\$209	\$ 209
2	HMNGDLEG	Desk Leg (single)	\$ 88	\$ 176
1	HMNG15PED	Pedestal	\$364	\$ 364
2	HMNG30FCD	File Center	\$509	\$1,018
1	HMNG60OVRD	Overhead	\$305	\$ 305
1	HMNGOHLEG	Overhead Leg	\$111	\$ 111
TOTAL:			\$2,183	

L-Station with Storage and Work Wall

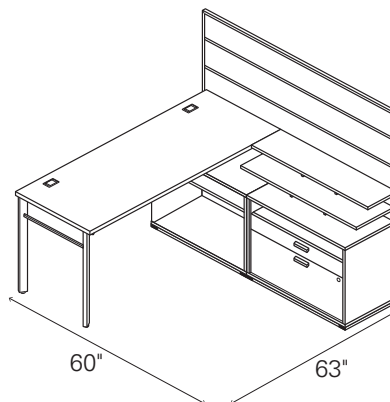

Wheat
HMLDFW61602W

Chestnut
HMLDFW61602C

Qty.	Model #	Description	List Price	Price Extension
1	HMNG60WKS	Worksurface	\$209	\$ 209
1	HMNGDLEG	Desk Leg (single)	\$ 88	\$ 88
1	HMNGWKWL	Work Wall	\$542	\$ 542
1	HMNG30FCD	File Center	\$509	\$ 509
1	HMNG30FCO	File Center	\$319	\$ 319
1	HMNG30STDM	Stadium	\$116	\$ 116
TOTAL:			\$1,783	

Laminate Desk with 2 Pedestals

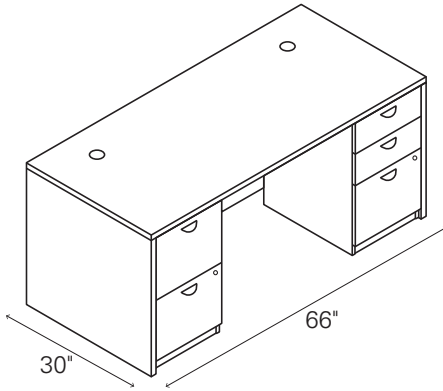

Espresso
HBLPP3066ES

Mahogany
HBLPP3066N

Medium Cherry
HBLPP3066A1

Qty.	Model #	Description	List Price	Price Extension
1	HBL2102	Desk Shell	\$348	\$ 348
1	HBL2162	Box / Box / File Pedestal	\$329	\$ 329
1	HBL2163	File / File Pedestal	\$329	\$ 329
TOTAL:			\$1,006	

Desk Shell with 1 Pedestal (Non-handed)

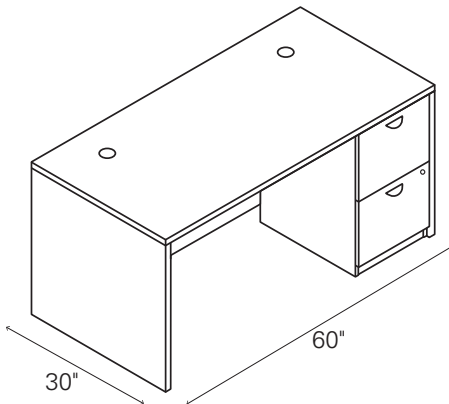

Espresso
HBLP3060ES

Mahogany
HBLP3060N

Medium Cherry
HBLP3060A1

Qty.	Model #	Description	List Price	Price Extension
1	HBL2103	Desk Shell	\$323	\$323
1	HBL2163	File / File Pedestal	\$329	\$329
TOTAL:			\$652	

Office Suite

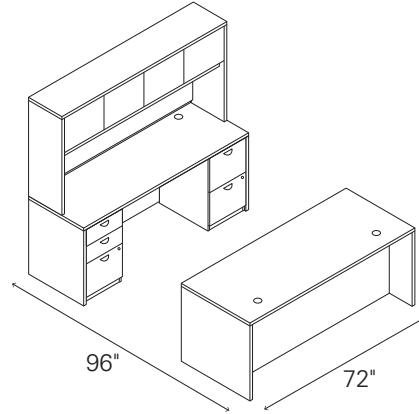

Espresso
HBLDCH7296ES

Mahogany
HBLDCH7296N

Medium Cherry
HBLDCH7296A1

Qty.	Model #	Description	List Price	Price Extension
1	HBL2101	Desk Shell	\$395	\$ 395
1	HBL2121	Credenza Shell	\$319	\$ 319
1	HBL2180	Hutch with Doors	\$431	\$ 431
2	HBL2162	Box / Box / File Pedestal	\$329	\$ 658
2	HBL2163	File / File Pedestal	\$329	\$ 658
TOTAL:			\$2,461	

L-Station with 2 Pedestals (Non-handed)

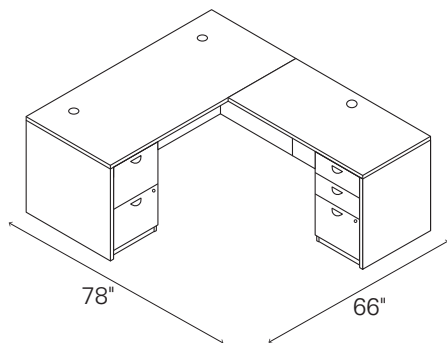

Espresso
HBLPP6678ES

Mahogany
HBLPP6678N

Medium Cherry
HBLPP6678A1

Qty.	Model #	Description	List Price	Price Extension
1	HBL2102	Desk Shell	\$348	\$ 348
1	HBL2145	Return Shell	\$217	\$ 217
1	HBL2162	Box / Box / File Pedestal	\$329	\$ 329
1	HBL2163	File / File Pedestal	\$329	\$ 329
TOTAL:			\$1,223	

Office Suite with Storage

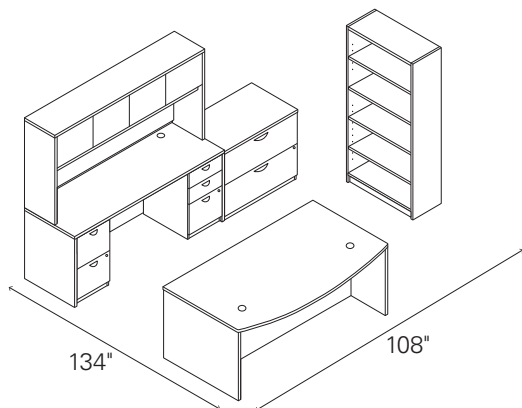

Espresso
HBLDCHL7272ES

Mahogany
HBLDCHL7272N

Medium Cherry
HBLDCHL7272A1

Qty.	Model #	Description	List Price	Price Extension
1	HBL2111	Bow Front Desk Shell	\$443	\$ 443
1	HBL2121	Credenza Shell	\$319	\$ 319
1	HBL2180	Hutch with Doors	\$431	\$ 431
1	HBL2194	5-Shelf Bookcase	\$284	\$ 284
1	HBL2171	2-Drawer Lateral File	\$508	\$ 508
2	HBL2162	Box / Box / File Pedestal	\$329	\$ 658
2	HBL2163	File / File Pedestal	\$329	\$ 658
TOTAL:			\$3,301	

U-Station (Non-handed)

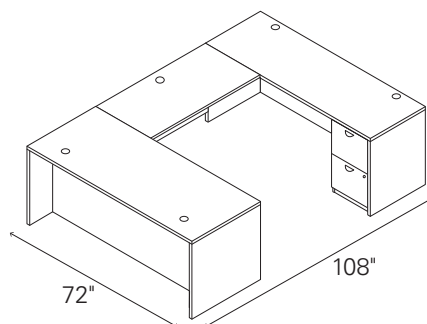

Espresso
HBLUPP72108ES

Mahogany
HBLUPP72108N

Medium Cherry
HBLUPP72108A1

Qty.	Model #	Description	List Price	Price Extension
1	HBL2101	Desk Shell	\$395	\$ 395
1	HBL2121	Credenza Shell	\$319	\$ 319
1	HBL2155	Bridge	\$183	\$ 183
1	HBL2162	Box / Box / File Pedestal	\$329	\$ 329
1	HBL2163	File / File Pedestal	\$329	\$ 329
TOTAL:			\$1,555	

Model	Page	Model	Page	Model	Page	Model	Page	Model	Page	Model	Page
H10501	225, 254	H105349	163, 232	H105679	156, 226, 255	H10595	229	H10746L	259	H10788LG	256
H105012	225	H10534G	232	H10568	218	H10596	214	H10747R	261	H10791	258
H105014	225	H10534K	232	H10568X	218	H10596X	214	H10748L	261	H10799	256
H10502	225, 254	H10536	231	H105680	218	H10598	214	H107492	261	H10799G	256
H10503	226, 255	H105360	235	H105680X	218	H10598X	214	H10751	261	H1110	656
H10504	225, 254	H105361	235	H105681	218	H105B3060	219	H10752	264	H1111	656
H10505	226, 255	H105362	235	H105681X	218	H105B3066	219	H10753	264	H1112	656
H105062	225	H105363	235	H105684	218	H105B3072	219	H10754	264	H1120	656
H105064	225	H10537	231	H105684X	218	H105R2442	219, 223	H10755	264	H1121	656
H10508	226, 255	H105380	234	H105686	218	H105R2448	219, 223	H107569	264	H1122	656
H105093	225, 254	H105380G	235	H105686X	218	H105R2460	219, 223	H10760	261	H1123	656
H105098	153, 215, 251	H105380K	234	H105690	237	H105R2466	219, 223	H10762	263	H1133	656
H105099	153, 215, 251	H105381	234	H105691	215	H105R2472	219, 223	H10763R	259	H1134	656
H1050CST	479	H105381G	235	H105691X	215	H105R3048	219, 223	H10764L	259	H1135	656
H105102	237, 263	H105381K	234	H105692	215	H105R3060	219, 223	H10765	259	H1143	656
H105104	237, 263	H105382	234	H105692X	215	H105R3066	219, 223	H10766	259	H1144	656
H105106	237, 263	H105382G	235	H105698	231	H105R3072	219, 223	H10767	257	H1145	656
H105109	237, 263	H105382K	234	H105699	231	H105T2430C	243	H10768	257	H11501	155
H10511R	229	H105383	234	H10570	231	H105T3036C	243	H107690	263	H115012	155
H10512L	229	H105383G	235	H10571	229	H10701R	256	H107697	263	H115014	155
H10515R	229	H105383K	234	H105720	240	H10702L	256	H107698	263	H11502	155
H10516	237	H105386	231	H105721	169, 240	H10705R	257	H107699	263	H11503	156
H10516L	229	H105388	231	H105722	169, 240	H10706L	257	H10770	261	H11504	155
H10517	237	H105392	217	H105724	240	H10707R	257	H10771	258	H11505	156
H105201R	230	H105393	217	H105726	240	H10708L	257	H107720	266	H11508	156
H105202L	230	H105397	217	H105729	240	H10709R	257	H107721R	266	H115093	155
H105203R	230	H10541	215	H10573	229	H10710L	257	H107722L	266	H115102	166
H105204L	230	H105410	216	H10578	214	H10711R	257	H107725R	252	H115104	166
H105205R	230	H105410X	216	H10578X	214	H10712L	257	H107726L	252	H115106	166
H105206L	230	H105411	216	H10579	214	H10715R	259	H107727R	252	H115109	166
H105209	230	H105411X	216	H10579X	214	H10716L	259	H107727RX	253	H11511R	159
H10521	230	H105412	216	H105810	236	H10717R	259	H107728L	252	H11512L	159
H10522	230	H105412X	216	H105811	236	H10718L	259	H107728LX	253	H11515R	159
H10523	230	H105413	216	H105815R	236	H107191R	257	H10773	256	H11516	166
H10524	225, 254	H105413X	216	H105816L	236	H107192L	257	H10774	256	H11516L	159
H10524LEP	220	H10541X	215	H105817R	236	H107193R	259	H10775	258	H11517	166
H10524TEP	220	H10542	215	H105818L	236	H107194L	259	H107801R	252	H115201R	161
H10525R	230	H10542X	215	H10583R	229	H10721	260	H107801RX	253	H115202L	161
H10526L	230	H10543	229	H10584L	229	H10722	260	H107802L	252	H115203R	161
H10528	161, 230, 260	H10544	229	H105851	164, 234	H10724	260	H107802LX	253	H115204L	161
H105290	237	H10545R	229	H105852	164, 234	H107242	266	H107803R	252	H115205R	161
H105291	237	H10546L	229	H105853	164, 234	H10726	260	H107803RX	253	H115206L	161
H105292	237	H10547R	231	H105854	164, 234	H107270X	253	H107804L	252	H11521	161
H105293	238	H10548L	231	H105855	164, 234	H107290	263	H107804LX	253	H11522	161
H105295R	238	H105491	231	H105856	164, 234	H107291	263	H107805R	252	H11523	161
H105296L	238	H105492	231	H105857	164, 234	H107292	263	H107805RX	253	H11525R	161
H105297R	238	H105493	231	H10585R	229	H107293	265	H107806L	252	H11526L	161
H105298L	238	H105520	239	H10586L	229	H107295R	265	H107806LX	253	H115290	166
H105299	238	H105523	239	H10587R	229	H107296L	265	H107807R	252	H115291	166
H10530	238	H105524	239	H105885R	229	H107299	265	H107807RX	253	H115292	166
H105301R	238	H105525R	239	H10588L	229	H10730	265	H107808L	252	H115293	167
H105302L	238	H105526L	239	H105890	227	H107301R	265	H107808LX	253	H115295R	167
H10530LEP	220	H105527R	239	H105891	227	H107302L	265	H107811	260	H115296L	167
H10530TEP	220	H105528L	239	H105892	227	H107313	262	H107815	251	H115297R	167
H105313R	233	H105531	237	H105893R	227	H107313K	262	H107815X	251	H115298L	167
H105314L	233	H105532	239, 483	H105894L	227	H107318	262	H107816	251	H115299	167
H105319	233	H105533	239, 483	H105895R	227	H107318K	262	H107816X	251	H11530	167
H105321	232	H105534	239, 483	H105896L	227	H10732	262	H107817	251	H115301R	167
H105321G	232	H105535	239, 483	H105897R	227	H10732K	262	H107817X	251	H115302L	167
H105321K	232	H105581	215	H105898L	227	H10733	262	H107824	250	H115321	163
H105322	232	H105581X	215	H105899	227	H10733K	262	H107825	250	H115321G	163
H105322G	232	H105582	215	H105900	228	H10734	262	H107825X	250	H115321K	163
H105322K	232	H105582X	215	H105901	228	H10734G	262	H107826	250	H115322	163
H105323	232	H105583	215	H105902	228	H10734K	262	H107827	250	H115322G	163
H105323G	232	H105583X	215	H105903R	228	H107353	262	H107829	250	H115322K	163
H105323K	232	H105598	231	H105904L	228	H107358	262, 273	H107835	251	H115323	163
H105324	232	H105599	231	H105905R	228	H10736	262	H107836	251	H115323G	163
H105324G	232	H10560	231	H105906L	228	H10737	262	H107837	251	H115323K	163
H105324K	232	H10561	218	H105907R	228	H10738	262, 273	H10783R	258	H115324	163
H105327	232	H10561X	218	H105908L	228	H107398	261	H10784L	258	H115324G	163
H105327G	232	H10563	237	H105909	228	H107399	261	H10785R	258	H115324K	163
H105327K	232	H10564	215	H10592	214	H10741	257	H10786L	258	H115327	163
H10533	232	H10564X	215	H10592X	214	H10742	257	H10787R	256	H115327G	163
H10533G	232	H10565	229	H10593	229	H10743	259	H10787RG	256	H115327K	163
H10533K	232	H10566	229	H10594	214	H10744	259	H107885R	258	H11533	163
H10534	232	H105663	217	H10594X	214	H10745R	259	H10788L	256	H11533G	163

Cross Reference Index

HON

Model	Page	Model	Page	Model	Page	Model	Page	Model	Page	Model	Page
H11533K	163	H11578	152	H1894	484	H38170	291	H4095	585	H6551	521
H11534	163	H11579	152	H1895	484	H38180	291	H4097	585	H6552	521
H11534G	163	H115811	165	H1896	484	H38210	293	H4099	586	H662	442
H11534K	163	H115815R	165	H1897	484	H38215R	291	H432	485	H66280	713
H115380	164	H115816L	165	H19717(?)	466	H38216L	291	H434	485	H66282	713
H115380K	164	H11583R	159	H19723(?)	466	H38217R	291	H482	485	H663	442
H115381	164	H11584L	159	H19730(?)	466	H38218L	291	H484	485	H664	442
H115381K	164	H11585R	159	H19817(?)	466	H38220	293	H5001	512	H665	442
H115382	164	H11586L	159	H19823(?)	466	H38251	291	H5002	512	H66531	713
H115382K	164	H11587R	159	H19830(?)	466	H38252L	291	H5003	512	H66537	713
H115383	164	H115885R	159	H20040AG	479	H38291R	291	H5021	588	H66541	713
H115383K	164	H11588L	159	H2071	556	H38292L	291	H5022	588	H66547	713
H11541	153	H115890	157	H2072	556	H38293R	291	H5023	588	H66551	713
H11541X	153	H115891	157	H2073	556	H38294L	291	H511596	445	H66557	713
H11542	153	H115892	157	H2091	590	H384815	295	H512	478	H66571	713
H11542X	153	H115893R	157	H2092	590	H386015	295	H51204	744	H66577	713
H11543	160	H115894L	157	H2093	590	H386548N	287, 295	H51206	269, 293, 744	H66581	713
H11544	160	H115895R	157	H2107	118, 140, 170, 246, 269, 275, 286, 288, 425, 749	H386560N	287, 295	H512C	478	H66582	713
H11545R	160	H115896L	157			H386566N	287, 295	H514	478	H66591	713
H11546L	160	H115897R	157			H386572N	295	H514C	478	H66597	713
H11547R	162	H115898L	157	H2111	510	H386615	295	H515700	443	H672	441
H11548L	162	H115899	157	H2112	510	H387215	295	H515704	481	H673	441
H115491	162	H115900	158	H212	476	H38851	291	H517514	443	H674	441
H115492	162	H115901	158	H212C	476	H38852	291	H519480	481	H675	441
H115493	162	H115902	158	H214	476	H38853	291	H519481	481	H675LS	441
H1155	656	H115903R	158	H2141	510	H38854	291	H519482	481	H682	441
H11552	168	H115904L	158	H2142	510	H38855L	291	H519483	481	H683	441
H115520	168	H115905R	158	H2143	510	H38856R	291	H519489	481	H684	441
H115523	168	H115906L	158	H2144	510	H38857L	291	H519490	481	H685	441
H115524	168	H115907R	158	H2145	510	H38858R	291	H519495	287, 288, 293, 479	H685LS	441
H115525R	168	H115908L	158	H2146	510	H38921	292	H52	474	H692	441
H115526L	168	H115909	158	H214C	476	H38922	292	H5210	118, 171, 246, 424, 745	H693	441
H115527R	168	H11592	152	H215	476	H38923	292	H5220	118, 171, 246, 424, 745	H694	441
H115528L	168	H11593	159	H2153	506	H38925	292	H52C	474	H695	441
H11553	168	H11594	152	H2155	506	H38928	293	H54	474	H695LS	441
H11554	168	H11595	159	H215C	476	H38931	292	H54C	474	H742	440
H11555	168	H11596	152	H2163	507	H38932	292	H5701	607	H743	440
H115581	153	H11598	152	H2164	507	H38933	292	H5703	607	H744	440
H115581X	153	H1310	656	H2165	507	H38934	292	H5705	607	H745	440
H115582	153	H1311	656	H2166	507	H38935	292	H5711	608	H752	440
H115582X	153	H1312	656	H2171	511	H38941	293	H5713	608	H753	440
H115583	153	H1320	656	H2172	511	H38942	293	H5715	608	H754	440
H115583X	153	H1321	656	H2191	513	H38943R	292	H572	475	H755	440
H115598	162	H1322	656	H2192	513	H38944L	292	H5721	609	H762	440
H115599	162	H1323	656	H2194	513	H38945R	292	H5723	609	H763	440
H11560	162	H1333	656	H2281	573	H38946L	292	H5725	609	H764	440
H11561	154	H1334	656	H2283	573	H38947R	292	H5731	610	H765	440
H11561X	154	H1335	656	H2285	574	H38948L	292	H5733	610	H7701	611
H11563	166	H1343	656	H2403	520	H38949R	292	H5735	610	H7703	611
H11564	153	H1344	656	H2516	118, 140, 170, 246, 269, 275, 286, 288, 425, 749	H38950L	292	H574	475	H7705	611
H11564X	153	H1345	656			H38966	293	H5795	607, 608, 609, 610	H7708	611
H11565	160	H1355	656	H312	477	H38SHFDV	296, 376, 377	H582	475	H772	439
H11566	160	H14917(?)	466	H312C	477	H4001	595	H584	475	H773	439
H11568	154	H14923(?)	466	H314	477	H4002	595	H585	475	H774	439
H115680	154	H1522	111, 140, 170, 246, 268, 275, 751	H314C	477	H4003	595	H5901	530	H775	439
H115680X	154			H315	477	H4008	595	H5902	530	H775LS	439
H115681	154	H1526	111, 140, 170, 246, 268, 275, 751	H315C	477	H4022	118, 140, 170, 246, 269, 275, 293, 750	H5903	530	H7795	611
H115681X	154			H32	474	H4028	118, 140, 170, 246, 269, 293, 750	H5905	530	H7803	612
H115684	154	H15923(?)	467	H33720(?)	436	H4029	118, 140, 170, 246, 269, 293, 750	H5991	530	H7808	612
H115684X	154	H1706	118, 140, 170, 246, 269, 275, 286, 288, 425, 749	H33723(?)	436			H5995	530	H782	439
H115686	154			H33820(?)	436			H625	443	H7823	613
H115686X	154	H1801	484	H33823(?)	436	H4031	565	H625C	443	H7828	613
H11568X	154	H1871	484	H34	474	H4033	565	H626	443	H783	439
H115690	166	H18717(?)	466	H34002R	288	H4039	565	H626C	443	H784	439
H115691	153	H1872	484	H34251	288	H4041	583	H626CN	443	H785	439
H115691X	153	H18723(?)	466	H34480	288	H4043	583	H626N	443	H785LS	439
H115692	153	H18730(?)	466	H34834R	288	H4048	583	H642	442	H7895	612
H115692X	153	H1874	484	H34835L	288	H4049	583	H643	442	H792	439
H115698	162	H1875	484	H34962	288	H4069	586	H644	442	H793	439
H115699	162	H1876	484	H34973R	288	H4071	584	H645	442	H794	439
H11570	162	H1877	484	H34974L	288	H4073	584	H652	442	H795	439
H11571	159	H18817(?)	466	H36720(?)	436	H4075	584	H653	442	H795LS	439
H115720	169	H18823(?)	466	H36723(?)	436	H4077	584	H654	442	H80170	669
H115724	169	H18830(?)	466	H36820(?)	436	H4079	586	H6541	521	H80180	669
H115726	169	H1891	484	H36823(?)	436	H4091	585	H6545	521	H80191	242, 669
H11573	159	H1892	484	H38155	291	H4093	585	H655	442	H80192	242, 669

Model	Page	Model	Page	Model	Page	Model	Page	Model	Page	Model	Page
H80193	242, 669	H919472	452, 481	H8CKIT66	407	HBV-P6048	429	HCTRND36	635	HEC72PT	366
H842	438	H919491	481	H8CKIT72	407	HBV-P6060	429	HCTRND42	635	HEC72PX	366
H843	438	H919492	481	H8CR22	657	HBV-P6072	429	HCTRND48	635	HEC80P2	366
H844	438	H9195(?)	468	H8CR28	657	HBV-P7224	429	HCTROUGH17	113, 173, 211, 376, 392, 665, 666, 668, 676, 679, 709, 742	HEC80P3	366
H845	438	H9275(?)	468	H8CR28BH	657	HBV-P7230	429			HEC80PL	366
H852	438	H9285(?)	468	H8CR28FR	657	HBV-P7236	429			HEC80PS	366
H853	438	H9295(?)	468	H8CSR1524(?)	406	HBV-P7242	429	HCTROUGH1710	113, 173, 211, 376, 392, 665, 666, 668, 676, 679, 709, 742	HEC80PT	366
H854	438	H9317	444	H8CSR1530(?)	406	HBV-P7248	429			HEC80PX	366
H855	438	H9318	444	H8CSR1536(?)	406	HBV-P7260	429			HEC801	407
H862	438	H9319	444	H8CSR1542(?)	406	HBV-PBS	430	HCTROUGH36	113, 173, 211, 376, 392, 665, 666, 668, 676, 679, 709, 742	HEC842	407
H863	438	H94011	695, 703	H8CSR1548(?)	406	HBV-PWB1	430			HECC10	377
H864	438	H94210	274	H8CSR1560(?)	406	HBV-QC180	430	HCTROUGH3610	113, 173, 211, 376, 392, 665, 666, 668, 679, 709, 742	HECC15	377
H865	438	H94211R	272	H8CSR1566(?)	406	HBV-QC90	430			HECPP	390
H872	437	H94212L	272	H8CSR1572(?)	406	HBV-TBASE	430			HECPP156	390
H873	437	H94215R	272	H8CSR2424(?)	406	HBV-VSH24	430			HECVH07P	367
H874	437	H94216L	272	H8CSR3030(?)	406	HBV-VSH30	430	HCTSDS	637	HECVH15P	367
H875	437	H94220	274	H8CSR3636(?)	406	HBV-VSH36	430	HCTSFT24	635	HECVH22P	367
H875LS	437	H94221	274	HBHAB2S24F	413, 718	HBV-VSH42	430	HCTSFT30	635	HECVH30P	367
H882	437	H94222	274	HBL2101	276	HBV-VSH48	430	HCTSFT36	635	HEFEC35P	367
H88231	286	H94223	274	HBL2101BF	276	HBV-VSH60	430	HCTSFT42	635	HEFEC42P	367
H88235R	286	H94224	274	HBL2102	276	HBWCT3624(?)	402	HCTSFT48	635	HEFEC50P	367
H88236L	286	H94225	274	HBL2103	276	HBWCT4224(?)	402	HCTSQR24	635	HEFEC57P	367
H88251R	285	H94226	274	HBL2111	276	HBWCT4230(?)	402	HCTSQR30	635	HEFEC65P	367
H88263R	285	H94229	274	HBL2111BF	276	HBWCT4824(?)	402	HCTSQR36	635	HEFEC72P	367
H88265R	285	H94234	273	HBL2115	276	HBWCT4830(?)	402	HCTSQR42	635	HEFEC80P	367
H88266L	285	H94234K	273	HBL2121	276	HBWD2450(?)	405	HCW1	529	HEFG0720	365
H883	437	H94235	273	HBL2123	276	HBWD3062(?)	405	HCW2450(?)	405	HEFG0724	365
H884	437	H94236	273	HBL2145	277	HBWQ2424(?)	405	HCW3062(?)	405	HEFG0730	365
H885	437	H94237	273	HBL2146	277	HBWQ3030(?)	405	HCWQ2424(?)	405	HEFG0736	365
H885LS	437	H94237K	273	HBL2155	277	HBWQ2424(?)	405	HCWQ3030(?)	405	HEFG0742	365
H88962	285	H94243	272	HBL2162	278, 486	HBWQ3030(?)	405	HD2	293, 751	HEFG0748	365
H88976	285	H94244	272	HBL2163	278, 486	HC14	287, 288	HD8	293, 751	HEFG0754	365
H892	437	H94245R	272	HBL2164	278, 486	HC184236	485	HD8X	735	HEFG0760	365
H893	437	H94246L	272	HBL2171	278, 486	HC187236	485	HDA001	508	HEFG0766	365
H894	437	H94247R	272	HBL2180	277	HC271508M	721	HDA011	509	HEFG0772	365
H895	437	H94248L	272	HBL2183	277	HC291508M	721	HDA01	508	HEFG1520	365
H895LS	437	H94251	272	HBL2194	278, 486	HCD1 246, 293, 416, 424, 751		HDAC11	509	HEFG1524	365
H90031	262	H94260	272	HBL2211	277	HCG6	529	HDAL02	508	HEFG1530	365
H90032	262	H94270	272	HBL2213	277	HCLA65	732	HDAL12	509	HEFG1536	365
H90033	262	H94271	272	HBL42CU	277	HCONLEG29	415	HDPS1	114, 171, 241, 268	HEFG1542	365
H90034	262, 273	H94276	272	HBL72BFMDG	276	HCOMDOME2	391, 423, 642, 748	HE4022	118, 140, 170, 246, 269, 275, 750	HEFG1548	365
H90035	262, 273	H94283R	272	HBL72HDG	277	HCPU	286, 424, 735, 745	HEC35P2	366	HEFG1554	365
H90050	72, 78, 234	H94284L	272	HBL48D	715	HCRESCENTA2	244, 267	HEC35P3	366	HEFG1560	365
H90051	72, 78, 135, 164, 234	H94285R	272	HBL72R	715	HCRESCENTA3	244, 267	HEC35PL	366	HEFG1566	365
H90052	72, 78, 135, 164, 234	H94286L	272	HBLH3160	716	HCRESCENTC2	244, 267	HEC35PS	366	HEFG1572	365
H90053	72, 78, 135, 164, 234	H94291	274	HBLH3170	716	HCRESCENTC3	244, 267	HEC35PT	366	HENTP3520FP	359
H90054	72, 78, 135, 164, 234	H94430	274	HBLMTO48A	715	HCS3636(?)	408	HEC35PX	366	HENTP3524FP	359
H90055	72, 78, 135, 164, 234	H94435	274	HBLMTO48B	715	HCS4242(?)	408	HEC42P2	366	HENTP3530FP	359
H90056	72, 78, 135, 164, 234	H94720	275	HBLMTO48R	715	HCT29LX	636	HEC42P3	366	HENTP3536FP	359
H90057	72, 78, 135, 164, 234	H94721R	275	HBLPBIDGE	278	HCT29MT	636	HEC42PL	366	HENTP3542FP	359
H90061	148	H94722L	275	HBLPCLASSIC	278	HCT29MX	636	HEC42PS	366	HENTP3548FP	359
H90063	148	HARCHA1	709	HBLPCONTEMP	278	HCT29ST	636	HEC42PT	366	HENTP3560FP	359
H90065	148	HARCHA2	170, 244, 267	HBLPWC	277, 486	HCT29SX	636	HEC42PX	366	HENTP3572FP	359
H90066	148	HARCHA3	170, 244, 267	HBMPT2B	485	HCT36LX	636	HEC50P2	366	HENTP4220FP	359
H9170(?)	468	HARCHA8	709	HBMPT2F	485	HCT36MT	636	HEC50P3	366	HENTP4224FP	359
H9172(?)	468	HARCHC1	709	HBMPT4824P	717	HCT36MX	636	HEC50PL	366	HENTP4230FP	359
H9173(?)	468	HARCHC2	170, 244, 267	HBMPT4824X	717	HCT36ST	636	HEC50PS	366	HENTP4236FP	359
H9174(?)	468	HARCHC3	170, 244, 267	HBMPT48MOD	282, 717	HCT36SX	636	HEC50PT	366	HENTP4242FP	359
H9175(?)	468	HARCHC8	709	HBMPT6024P	717	HCT42LX	636	HEC50PX	366	HENTP4248FP	359
H9180(?)	468	HAS18	446	HBMPT6024X	717	HCT42MT	636	HEC57P2	366	HENTP4260FP	359
H9182(?)	468	HAS24	446	HBMPT60MOD	282, 717	HCT42MX	636	HEC57P3	366	HENTP4272FP	359
H9183(?)	468	HB273012M	721	HBMPT7224P	717	HCT42ST	636	HEC57PL	366	HENTP5020DP	361
H9184(?)	468	HB293012M	721	HBMPT7224X	717	HCT42SX	636	HEC57PS	366	HENTP5020FP	359
H9185(?)	468	HB9	445	HBMPT72MOD	282, 717	HCTL182	415	HEC57PT	366	HENTP5024DP	361
H9185LS(?)	469	HBX22	657	HBTMS	665, 666, 676	HCTL242	415	HEC57PX	366	HENTP5024FP	359
H9185LSN(?)	469	HBX36	657	HBV-P4224	429	HCTLDS	637	HEC65P2	366	HENTP5030DP	361
H9190(?)	468	HBX40	657	HBV-P4230	429	HCTMDS	637	HEC65P3	366	HENTP5030FP	359
H9192(?)	468	HBCKKIT24	407	HBV-P4236	429	HCTRECT2448	635	HEC65PL	366	HENTP5036DP	361
H9193(?)	468	HBCKKIT30	407	HBV-P4242	429	HCTRECT2460	635	HEC65PS	366	HENTP5036FP	359
H9194(?)	468	HBCKKIT36	407	HBV-P4248	429	HCTRECT2472	635	HEC65PT	366	HENTP5042DP	361
H919430	452, 481	HBCKKIT24	407	HBV-P4260	429	HCTRECT3048	635	HEC65PX	366	HENTP5042FP	359
H919436	452, 481	HBCKKIT30	407	HBV-P4272	429	HCTRECT3060	635	HEC72P2	366	HENTP5048DP	361
H919442	481	HBCKKIT36	407	HBV-P6024	429	HCTRECT3072	635	HEC72P3	366	HENTP5048FP	359
H919448	452	HBCKKIT42	407	HBV-P6030	429	HCTRND24	635	HEC72PL	366	HENTP5060DP	361
H919460	452, 481	HBCKKIT48	407	HBV-P6036	429	HCTRND30	635	HEC72PS	366	HENTP5060FP	359
H919466	481	HBCKKIT60	407	HBV-P6042	429					HENTP5072DP	361

Cross Reference Index



Model	Page	Model	Page	Model	Page	Model	Page	Model	Page	Model	Page
HENTP5072FP	359	HETC20	363	HEWS72P	367	HFSC183640(?)	470	HH870930	46, 117, 148, 172, 235, 752	HH871912	389
HENTP6520DP	361	HETC24	363	HEWS80P	367	HFSC183640W	470			HH871912A	389
HENTP6520FP	359	HETC30	363	HF22	479, 743	HFSC183664(?)	470	HH870930(?)	376, 377	HH871918	389
HENTP6524DP	361	HETC36	363	HF23B	116, 124, 140, 170, 246, 268, 743	HFSC183664W	470	HH870930CH	46, 117, 148, 172	HH871918A	389
HENTP6524FP	359	HETC42	363			HFSS7	543	HH870942	46, 117, 148, 172, 235, 269, 296, 752	HH873500	389
HENTP6530DP	361	HETC48	363	HF23C	479, 482, 743	HFSS74L	543			HH873501	391
HENTP6530FP	359	HETC60	363	HF23S	116, 246, 452, 743	HFSS74LDF	547	HH870942(?)	376, 377	HH873501A	391
HENTP6536DP	361	HETC66	363	HF24	482, 743	HFTB17N	552, 652	HH870942CH	46, 117, 148, 172	HH873502A	391
HENTP6536FP	359	HETC72	363	HF246	482, 743	HFTLA2460	551, 651	HH870960	46, 117, 148, 172, 235, 269, 273, 296, 752	HH873502	391
HENTP6542DP	361	HETC78	363	HF27B	116, 246, 743	HFTLA3372	551, 651			HH873503	391
HENTP6542FP	359	HETC84	363	HF27S	45, 116, 246, 743	HFTLA3384	551, 651	HH870960(?)	376, 377	HH873503A	391
HENTP6548DP	361	HETC90	363	HF50	482	HFTLA3396	551, 651	HH870960CH	46, 117, 148, 273, 752	HH873504	391
HENTP6548FP	359	HETC96	363	HF60	482	HFTLA2460	551, 651			HH873506	391
HENTP6560DP	361	HETP3520FP	358	HF80	479	HFTLC3372	551, 651	HH8710120	389	HH873506A	391
HENTP6560FP	359	HETP3524FP	358	HFAA01	572	HFTLC3384	551, 651	HH8710120A	389	HH879072	389
HENTP6572DP	361	HETP3530FP	358	HFAL1	554, 654	HFTLC3396	551, 651	HH8710144	389	HH879072A	389
HENTP6572FP	359	HETP3536FP	358	HFAL02	572	HFTLD26	553, 653	HH8710144A	389	HH879168	389
HEOHRTA1524FD	371	HETP3542FP	358	HFALA1	554, 654	HFTLD30	551, 651	HH871024	389	HH879168A	389
HEOHRTA1530FD	371	HETP3548FP	358	HFAS03	572	HFTLD36	551, 651	HH871024A	389	HH8988EBN	392
HEOHRTA1536FD	371	HETP3560FP	358	HFASH1	554, 654	HFTLS24	553, 653	HH871030	389	HHAB3S24F	38, 101, 223, 409, 643
HEOHRTA1542FD	371	HETP3572FP	358	HFC01	555	HFTLS30	551, 651	HH871030A	389		
HEOHRTA1548FD	371	HETP4220FP	358	HFC02	555	HFTLS36	551, 651	HH871036	389	HHAB3S3C24F	38, 101, 223, 409, 643
HEOHRTA1560FD	371	HETP4224FP	358	HFC16730(?)	473	HFTPTL18	553, 653	HH871036A	389		
HEOHRTA1572FD	371	HETP4230FP	358	HFC1830BD(?)	472	HFTPTV18	553, 653	HH871042	389	HHABCASTER	223, 409, 642, 643
HEP35	390	HETP4236FP	358	HFC1830DB(?)	472	HFTTAL14	553, 560, 564, 653	HH871042A	389		
HEP65	390	HETP4242FP	358	HFC1830DD(?)	471	HFTTAV14	553, 653	HH871048	389	HHABCCEXTL	409, 643
HEPDMK42P	362	HETP4248FP	358	HFC1830DF(?)	472	HFTVA2460	551, 651	HH871048A	389	HHABCCEXTR	409, 643
HERPCVCR	390	HETP4260FP	358	HFC1830DLF(?)	471	HFTVA3372	551, 651	HH871060	389	HHABMEM	38, 101, 187, 223, 409, 643
HES1520F	364	HETP4272FP	358	HFC1830FD(?)	472	HFTVA3384	551, 651	HH871060A	389		
HES1520G	364	HETP5020DP	360	HFC1830NLF(?)	471	HFTVA3396	551, 651	HH871072	389	HHAW2448P	410, 413, 644, 718
HES1524F	364	HETP5020FP	358	HFC1830NN	471	HFTVC2460	551, 651	HH871072A	389	HHAW2454P	410, 413, 644, 718
HES1524G	364	HETP5024DP	360	HFC18730(?)	473	HFTVC3372	551, 651	HH871096	389	HHAW2460P	410, 413, 644, 718
HES1530F	364	HETP5024FP	358	HFC32	555	HFTVC3384	551, 651	HH871096A	389	HHAW2466P	413, 410, 644, 718
HES1530G	364	HETP5030DP	360	HFCG6	543	HFTVC3396	551, 651	HH871124	389	HHAW2472P	410, 413, 644, 718
HES1536F	364	HETP5030FP	358	HFCG6DF	547	HFTVD26	553, 653	HH871124A	389	HHAW3048P	410, 413, 644, 718
HES1536G	364	HETP5036DP	360	HFLC1	543	HFTVD30	551, 651	HH871130	389	HHAW3054P	410, 413, 644, 718
HES1542F	364	HETP5036FP	358	HFLC1DF	547	HFTVD36	551, 651	HH871130A	389	HHAW3060P	410, 413, 644, 718
HES1542G	364	HETP5042DP	360	HFDB17B	552, 652	HFTVS24	553, 653	HH871136	389	HHAW3072P	410, 413, 644, 718
HES1548F	364	HETP5042FP	358	HFDB17N	552, 652	HFTVS30	551, 651	HH871136A	389	HHAWV603624LP	411, 645
HES1548G	364	HETP5048DP	360	HFDB29A	552, 652	HFTVS36	551, 651	HH871142	389	HHAWV603624RP	411, 645
HES1560F	364	HETP5048FP	358	HFDB29AN	552, 652	HFXB17B	552, 652	HH871142A	389	HHAWV604824LP	411, 645
HES1560G	364	HETP5060DP	360	HFDB29B	552, 652	HFXB29A	552, 652	HH871148	389	HHAWV604824RP	411, 645
HES1572F	364	HETP5060FP	358	HFDB42A	552, 652	HFXB29AN	552, 652	HH871148A	389	HHAWV604830LP	411, 645
HES1572G	364	HETP5072DP	360	HFDB42AF	552, 652	HFXB29B	552, 652	HH871160	389	HHAWV604830RP	411, 645
HES3020G	364	HETP5072FP	358	HFDB42AF72	552, 652	HFXB42A	552, 652	HH871160A	389	HHAWV723624LP	411, 645
HES3024G	364	HETP6520DP	360	HFDB42AF84	552, 652	HFXB42AN	552, 652	HH871172	389	HHAWV723624RP	411, 645
HES3030G	364	HETP6520FP	358	HFDB42AF96	552, 652	HFXB42B	552, 652	HH871172A	389	HHAWV724824LP	411, 645
HES3036G	364	HETP6524DP	360	HFDB42AFN	552, 652	HGXK3-F	732, 733	HH871224	389	HHAWV724824RP	411, 645
HES3042G	364	HETP6524FP	358	HFDB42AN	552, 652	HGRMTAC	46, 113, 173, 210, 245, 269, 392, 408, 554, 560, 564, 637, 648, 654, 668, 678, 735, 747	HH871224A	389	HHAWV724830LP	411, 645
HES3048G	364	HETP6530DP	360	HFDB42B	552, 652	HGRMTAC1HW26	209	HH871230	389	HHAWV724830RP	411, 645
HES3060G	364	HETP6530FP	358	HFDB42BF	552, 652	HGRMTAC1HW34	209	HH871230A	389	HHB02	518
HESA-2440E-4L	642	HETP6536DP	360	HFLC01	544	HGRMTAC2	409, 643, 678	HH871236	389	HHB03	518
HESA-3050E-4L	642	HETP6536FP	358	HFLC01DF	548	HGRMTAC2HW26	209	HH871236A	389	HHCB50	519
HESDMK30	362	HETP6542DP	360	HFLC01T	544	HGRMTAC2HW34	209	HH871242	389	HHCG11	601
HESDMK36	362	HETP6542FP	358	HFLC01TDF	548	HGRMTAC3	112, 172, 245, 269, 747	HH871242A	389	HHCG11DF	602
HESDMK42	362	HETP6548DP	360	HFLDGRMT		HGRMTAC3HW26	209	HH871248	389	HHCG21	601
HESDMK48	362	HETP6548FP	358	HFLDGRMT3	112, 124, 172, 211, 245, 269, 637, 747	HGRMTAC3HW34	209	HH871248A	389	HHCG21DF	602
HESH-3060E-4L	642	HETP6560DP	360			HGRMTDATA	210, 554, 654, 668, 678, 747	HH871260	389	HHCG50	601
HESHRTA24	371	HETP6560FP	358	HFLDGRMT4	112	HGRMTMINIAC	637	HH871260A	389	HHCG50DF	602
HESHRTA30	371	HETP6572DP	360	HFLGANG	542, 546	HGRMTMINIUSB	637	HH871272	389	HHCGB21	603
HESHRTA36	371	HETR-2448E-4L	642	HFLMC1	542	HGRMTUSB2	46, 113, 173, 245, 269, 392, 554, 560, 564, 637, 654, 668, 747	HH871272A	389	HHCGB31	603
HESHRTA48	371	HETR-2460E-4L	642	HFLMC1DF	546			HH871366	389	HHCGBR	604
HESHRTA60	371	HETR-2472E-4L	642	HFLML1	542			HH871366A	389	HHCGBRCH	604
HESHRTA72	371	HETR-3048E-4L	642	HFLML1DF	546			HH871400	389	HHCTM24	392
HESKD-7248E-4L	642	HETR-3060E-4L	642	HFLMR1	542			HH871400A	389	HHCMT36	392
HESN-3054E-4L	642	HETR-3072E-4L	642	HFLMR1DF	546			HH871500	389	HHCP1	601
HESW-3054E-4L	642	HEVHF07P	367	HFLRC1	541			HH871501	391	HHCP1DF	602
HETB2018	370, 371	HEVHF15P	367	HFLRC1DF	545			HH871501A	391	HHCR1	606
HETB2418	370, 371	HEVHF22P	367	HFLSC1	541			HH871502	391	HHCR1CL	606
HETB3018	370, 371	HEVHF30P	367	HFLSC1DF	545			HH871502A	391	HHCRFP	606
HETB3618	370, 371	HEWS35P	367	HFLSO1	542			HH871503	391	HHCT01	519
HETB4218	370, 371	HEWS42P	367	HFLYO1	544			HH871503A	391	HHCT02	519
HETB4818	370, 371	HEWS50P	367	HFLYO1DF	548			HH871504	391	HHCT020	518
HETB6018	370, 371	HEWS57P	367	HFLYO1T	544			HH871506	391	HHCT024	518
HETB7218	370, 371	HEWS85P	367	HFLYO1TDF	548			HH871601	391	HHCT048	518
								HH870924CH	752	HHCT12	519

Model	Page	Model	Page	Model	Page	Model	Page	Model	Page	Model	Page
HHCTC	604	HLDV-L3F	731	HLSF52T-3D	737	HLSL2036LD1	201	HLSL3041S	190	HLSLR2484	184
HHCTL4	604	HLDV-M3A	731	HLSF52T-3N	736	HLSL2036LD2	201	HLSL3041SL	100, 187, 222, 418	HLSLR3036	185
HHCTRT	604	HLDV-M3F	731	HLSL1212	197, 207, 374	HLSL2036SC	203	HLSL3070	100, 186, 199	HLSLR3042	185
HHCTS	604	HLED1	46, 117, 172, 245, 269, 423, 752	HLSL1220FS	193	HLSL2036TS	193	HLSL307SL	186	HLSLR3048	185, 187, 410, 413, 644, 718
HHMEM20	392	HLED17A	46, 117, 172, 207, 235, 269, 296, 376, 752	HLSL1220GS	193	HLSL2060LDO	199	HLSL300BC	189, 421	HLSLR3054	185, 187, 410, 413, 644, 718
HHKDMK30	328	HLED17AS	46, 117, 172, 207, 235, 269, 296, 376, 752	HLSL1220TS	193	HLSL2060LD2	199	HLSL3414LM	96, 191	HLSLR3060	185, 187, 410, 413, 644, 718
HHKDMK36	328	HLED17AUS	46, 117, 172, 207, 235, 269, 296, 376, 752	HLSL1224FS	102, 193	HLSL2060LD4	199	HLSL3428LM	96, 191	HLSLR3066	185, 187, 410, 413, 644, 718
HHKDMK42	328	HLED17AUO	46, 117, 172, 207, 235, 269, 296, 376, 752	HLSL1224GS	102, 193	HLSL2060LL2	199	HLSL3614L	96, 191, 224, 412, 646	HLSLR3072	185, 187, 410, 413, 644, 718
HHKDMK48	328	HLED17AUC	46, 117, 172, 207, 235, 269, 296, 376, 752	HLSL1224TS	193	HLSL2060LR2	199	HLSL3614MM	96, 191, 224, 412, 646	HLSLR3072	185, 187, 410, 413, 644, 718
HHKHSM100	401	HLED17AUC	46, 117, 172, 207, 235, 269, 296, 376, 752	HLSL1230	102, 192, 224, 258	HLSL2060LR2PWR	200	HLSL3635TS	193	HLSLR3084	185
HHMRK36	370, 422	HLED17AUC	46, 117, 172, 207, 235, 269, 296, 376, 752	HLSL1230FS	102, 193	HLSL2060S4	199	HLSL367W	195, 197	HLSLR3660	185, 410, 413, 644, 718
HHMRK42	370, 422	HLED17AUC	46, 117, 172, 207, 235, 269, 296, 376, 752	HLSL1230GS	102, 193	HLSL2072LDO	199	HLSL4014LM	96, 191	HLSLR3666	185, 410, 413, 644, 718
HHMRK48	370, 422	HLED17AUC	46, 117, 172, 207, 235, 269, 296, 376, 752	HLSL1230TS	193	HLSL2072LD2	199	HLSL4028LM	96, 191	HLSLR3672	185, 410, 413, 644, 718
HHN831118	415	HLED17AUC	46, 117, 172, 207, 235, 269, 296, 376, 752	HLSL1236	102, 192, 224, 258	HLSL2072LD4	199	HLSL4214L	96, 191, 224, 412, 646	HLSLR3672	185, 410, 413, 644, 718
HHN831124	305, 415	HLED17AUC	46, 117, 172, 207, 235, 269, 296, 376, 752	HLSL1236FS	102, 193	HLSL2072LL2	199	HLSL4214MM	96, 191, 224, 412, 646	HLSLR3672	185, 410, 413, 644, 718
HHN831130	305, 415	HLED17AUC	46, 117, 172, 207, 235, 269, 296, 376, 752	HLSL1236GS	102, 193	HLSL2072LL2PWR	200	HLSL4235TS	193	HLSLR3672	185, 410, 413, 644, 718
HHPMC6	347, 362	HLED17AUC	46, 117, 172, 207, 235, 269, 296, 376, 752	HLSL1236TS	193	HLSL2072LR2	199	HLSL4235TS	193	HLSLR3672	185, 410, 413, 644, 718
HHPS1	114, 171, 241, 268	HLED17AUC	46, 117, 172, 207, 235, 269, 296, 376, 752	HLSL1242	102, 192, 224, 258	HLSL2072LR2PWR	200	HLSL4243TS	193	HLSLR3672	185, 410, 413, 644, 718
HHT2DP	391	HLED17AUC	46, 117, 172, 207, 235, 269, 296, 376, 752	HLSL1248	102, 192, 224, 258	HLSL2072S4	199	HLSL4243TS	193	HLSLR3672	185, 410, 413, 644, 718
HHTAD3	392	HLED17AUC	46, 117, 172, 207, 235, 269, 296, 376, 752	HLSL1254	102, 192, 224, 258	HLSL2070	186, 199	HLSL4243TS	193	HLSLR3672	185, 410, 413, 644, 718
HHTAD4	392	HLED17AUC	46, 117, 172, 207, 235, 269, 296, 376, 752	HLSL1260	102, 192, 224, 258	HLSL207SL	186	HLSL4243TS	193	HLSLR3672	185, 410, 413, 644, 718
HHTADJ5	392	HLED17AUC	46, 117, 172, 207, 235, 269, 296, 376, 752	HLSL1336B2	206	HLSL220SPL	196, 375	HLSL4243TS	193	HLSLR3672	185, 410, 413, 644, 718
HHTADJ6	392	HLED17AUC	46, 117, 172, 207, 235, 269, 296, 376, 752	HLSL1336B3	206	HLSL2428B	188, 420	HLSL4243TS	193	HLSLR3672	185, 410, 413, 644, 718
HHW103	611	HLED17AUC	46, 117, 172, 207, 235, 269, 296, 376, 752	HLSL1336B4	206	HLSL2428BPWR	188	HLSL4243TS	193	HLSLR3672	185, 410, 413, 644, 718
HIAAA	571	HLED17AUC	46, 117, 172, 207, 235, 269, 296, 376, 752	HLSL1436BH	203	HLSL2428E	186	HLSL4243TS	193	HLSLR3672	185, 410, 413, 644, 718
HIATA	571	HLED17AUC	46, 117, 172, 207, 235, 269, 296, 376, 752	HLSL1436D	194, 373	HLSL2428EBL	414	HLSL4243TS	193	HLSLR3672	185, 410, 413, 644, 718
HIB50	569	HLED17AUC	46, 117, 172, 207, 235, 269, 296, 376, 752	HLSL1436S	194, 373	HLSL2428E	186	HLSL4243TS	193	HLSLR3672	185, 410, 413, 644, 718
HICG12	327, 362	HLED17AUC	46, 117, 172, 207, 235, 269, 296, 376, 752	HLSL1442D	194, 373	HLSL2428E	186	HLSL4243TS	193	HLSLR3672	185, 410, 413, 644, 718
HICS7	570	HLED17AUC	46, 117, 172, 207, 235, 269, 296, 376, 752	HLSL1442S	194, 373	HLSL2428F	188, 420	HLSL4243TS	193	HLSLR3672	185, 410, 413, 644, 718
HIDTA	571	HLED17AUC	46, 117, 172, 207, 235, 269, 296, 376, 752	HLSL1448D	194, 373	HLSL2428FPWR	188	HLSL4243TS	193	HLSLR3672	185, 410, 413, 644, 718
HIEH1	566	HLED17AUC	46, 117, 172, 207, 235, 269, 296, 376, 752	HLSL1448S	194, 373	HLSL2428G	100, 186, 222, 414	HLSL4243TS	193	HLSLR3672	185, 410, 413, 644, 718
HIEH2	566	HLED17AUC	46, 117, 172, 207, 235, 269, 296, 376, 752	HLSL1460D	194, 373	HLSL2428S	188, 420	HLSL4243TS	193	HLSLR3672	185, 410, 413, 644, 718
HIEH3	566	HLED17AUC	46, 117, 172, 207, 235, 269, 296, 376, 752	HLSL1460S	207	HLSL2428SL	100, 186	HLSL4243TS	193	HLSLR3672	185, 410, 413, 644, 718
HIFHA	538, 571	HLED17AUC	46, 117, 172, 207, 235, 269, 296, 376, 752	HLSL1460M	195, 374	HLSL2428SPWR	188	HLSL4243TS	193	HLSLR3672	185, 410, 413, 644, 718
HIGB1	570	HLED17AUC	46, 117, 172, 207, 235, 269, 296, 376, 752	HLSL1460S	194, 373	HLSL2430L	189, 421	HLSL4243TS	193	HLSLR3672	185, 410, 413, 644, 718
HIGCL	569	HLED17AUC	46, 117, 172, 207, 235, 269, 296, 376, 752	HLSL1466D	194, 373	HLSL2430LPWR	189	HLSL4243TS	193	HLSLR3672	185, 410, 413, 644, 718
HIGS6	570	HLED17AUC	46, 117, 172, 207, 235, 269, 296, 376, 752	HLSL1466M	195, 374	HLSL2430MF	189, 421	HLSL4243TS	193	HLSLR3672	185, 410, 413, 644, 718
HIHC	569	HLED17AUC	46, 117, 172, 207, 235, 269, 296, 376, 752	HLSL1466S	194, 373	HLSL2436L2	203	HLSL4243TS	193	HLSLR3672	185, 410, 413, 644, 718
HIL2L	569	HLED17AUC	46, 117, 172, 207, 235, 269, 296, 376, 752	HLSL1472D	194, 373	HLSL2436L4	203	HLSL4243TS	193	HLSLR3672	185, 410, 413, 644, 718
HILT	569	HLED17AUC	46, 117, 172, 207, 235, 269, 296, 376, 752	HLSL1472DB	198	HLSL2436SC	203	HLSL4243TS	193	HLSLR3672	185, 410, 413, 644, 718
HIPAA	538, 571	HLED17AUC	46, 117, 172, 207, 235, 269, 296, 376, 752	HLSL1472LS	207	HLSL2441BCL	190	HLSL4243TS	193	HLSLR3672	185, 410, 413, 644, 718
HISB6	570	HLED17AUC	46, 117, 172, 207, 235, 269, 296, 376, 752	HLSL1472M	195, 374	HLSL2441BCR	190	HLSL4243TS	193	HLSLR3672	185, 410, 413, 644, 718
HITL1	568	HLED17AUC	46, 117, 172, 207, 235, 269, 296, 376, 752	HLSL1472MB	195	HLSL2441O	100, 187, 222, 418	HLSL4243TS	193	HLSLR3672	185, 410, 413, 644, 718
HITL2	568	HLED17AUC	46, 117, 172, 207, 235, 269, 296, 376, 752	HLSL1472S	194, 373	HLSL2441S	190	HLSL4243TS	193	HLSLR3672	185, 410, 413, 644, 718
HITL3	568	HLED17AUC	46, 117, 172, 207, 235, 269, 296, 376, 752	HLSL1472SB	198	HLSL2441SL	100, 187, 222, 418	HLSL4243TS	193	HLSLR3672	185, 410, 413, 644, 718
HITS5	568	HLED17AUC	46, 117, 172, 207, 235, 269, 296, 376, 752	HLSL1478D	194, 373	HLSL2472LC	203	HLSL4243TS	193	HLSLR3672	185, 410, 413, 644, 718
HIWM1	567	HLED17AUC	46, 117, 172, 207, 235, 269, 296, 376, 752	HLSL1478M	195, 374	HLSL2470	100, 186, 199	HLSL4243TS	193	HLSLR3672	185, 410, 413, 644, 718
HIWM2	567	HLED17AUC	46, 117, 172, 207, 235, 269, 296, 376, 752	HLSL1478S	194, 373	HLSL247SL	186	HLSL4243TS	193	HLSLR3672	185, 410, 413, 644, 718
HIWM3	567	HLED17AUC	46, 117, 172, 207, 235, 269, 296, 376, 752	HLSL1478S	194, 373	HLSL247SL	186	HLSL4243TS	193	HLSLR3672	185, 410, 413, 644, 718
HIWM8	566	HLED17AUC	46, 117, 172, 207, 235, 269, 296, 376, 752	HLSL140SPL	196, 375	HLSL240BC	189, 421	HLSL4243TS	193	HLSLR3672	185, 410, 413, 644, 718
HJ625C	443	HLED17AUC	46, 117, 172, 207, 235, 269, 296, 376, 752	HLSL1530SOMB	111, 196, 375	HLSL2814LM	96, 191	HLSL4243TS	193	HLSLR3672	185, 410, 413, 644, 718
HJ625CN	443	HLED17AUC	46, 117, 172, 207, 235, 269, 296, 376, 752	HLSL1536SOMB	111, 196, 375	HLSL2828LM	96, 191	HLSL4243TS	193	HLSLR3672	185, 410, 413, 644, 718
HKBS	425, 749	HLED17AUC	46, 117, 172, 207, 235, 269, 296, 376, 752	HLSL1760SOL	196, 375	HLSL2830	102, 192	HLSL4243TS	193	HLSLR3672	185, 410, 413, 644, 718
HKP2800	480	HLED17AUC	46, 117, 172, 207, 235, 269, 296, 376, 752	HLSL1760SOR	196, 375	HLSL2836	102, 192	HLSL4243TS	193	HLSLR3672	185, 410, 413, 644, 718
HL1SL	539	HLED17AUC	46, 117, 172, 207, 235, 269, 296, 376, 752	HLSL1772SOL	196, 375	HLSL2842	102, 192	HLSL4243TS	193	HLSLR3672	185, 410, 413, 644, 718
HL2DARM	538	HLED17AUC	46, 117, 172, 207, 235, 269, 296, 376, 752	HLSL1772SOR	196, 375	HLSL2848	102, 192	HLSL4243TS	193	HLSLR3672	185, 410, 413, 644, 718
HL2SL	539	HLED17AUC	46, 117, 172, 207, 235, 269, 296, 376, 752	HLSL2016MP2	202	HLSL2854	102, 192	HLSL4243TS	193	HLSLR3672	185, 410, 413, 644, 718
HL3SL	539	HLED17AUC	46, 117, 172, 207, 235, 269, 296, 376, 752	HLSL2016PH2	81, 202	HLSL2860	102, 192	HLSL4243TS	193	HLSLR3672	185, 410, 413, 644, 718
HL4DARM	538	HLED17AUC	46, 117, 172, 207, 235, 269, 296, 376, 752	HLSL2020TS	193	HLSL2860	102, 192	HLSL4243TS	193	HLSLR3672	185, 410, 413, 644, 718
HLD-L3A	730	HLED17AUC	46, 117, 172, 207, 235, 269, 296, 376, 752	HLSL2024TS	193	HLSL28P	63, 101, 186, 221, 415	HLSL4243TS	193	HLSLR3672	185, 410, 413, 644, 718
HLD-L3AA	730	HLED17AUC	46, 117, 172, 207, 235, 269, 296, 376, 752	HLSL2028B	188, 420	HLSL3014L	96, 191, 224, 412, 646	HLSL4243TS	193	HLSLR3672	185, 410, 413, 644, 718
HLD-L3AB	730	HLED17AUC	46, 117, 172, 207, 235, 269, 296, 376, 752	HLSL2028BPWR	188	HLSL3014MM	96, 191, 224, 412, 646	HLSL4243TS	193	HLSLR3672	185, 410, 413, 644, 718
HLD-L3F	730	HLED17AUC	46, 117, 172, 207, 235, 269, 296, 376, 752	HLSL2028E	186	HLSL3028B	188, 420	HLSL4243TS	193	HLSLR3672	185, 410, 413, 644, 718
HLD-L3FA	730	HLED17AUC	46, 117, 172, 207, 235, 269, 296, 376, 752	HLSL2028F	188, 420	HLSL3028BPWR	188	HLSL4243TS	193	HLSLR3672	185, 410, 413, 644, 718
HLD-L3FB	730	HLED17AUC	46, 117, 172, 207, 235, 269, 296, 376, 752	HLSL2028FPWR	188	HLSL3028E	186	HLSL4243TS	193	HLSLR3672	185, 410, 413, 644, 718
HLD-L3T	730	HLED17AUC	46, 117, 172, 207, 235, 269, 296, 376, 752	HLSL2028G	186, 414</						

Cross Reference Index

HON

Model	Page	Model	Page	Model	Page	Model	Page	Model	Page	Model	Page
HMACREDPK72	209	HML3SDF	562	HMVH-3672(?) -FX	671	HMVR-3066(?) -FX	671	HNL206021LD2	66	HNL2930LL	77
HMACCON	210	HML8851	631, 716	HMVH-3672(?) -NS	672	HMVR-3066(?) -NS	672	HNL206021RD2	66	HNL2936FD	77
HMAADUPLEX1	210	HML8852	631, 716	HMVMB-3072WWW	675	HMVR-3072(?) -AH	673	HNL207221D4	66	HNL2936LD	77
HMAADUPLEX1BP5	210	HML8858	630, 716	HMVMB-3672WWW	675	HMVR-3072(?) -FD	674	HNL207221LD2	66	HNL2936LL	77
HMAADUPLEX2	210	HMN1	578	HMVPC-DTLG	675	HMVR-3072(?) -FX	671	HNL207221RD2	66	HNL2942FD	77
HMAADUPLEX2BP5	210	HMN2	578	HMVPC-MP	675	HMVR-3072(?) -NS	672	HNL2116MIBBF	81	HNL2942LD	77
HMAGANG	665, 666, 676, 717	HMNG15PED	281, 487	HMVPCA1-1830G	675	HMVR-3084(?) -FX	671	HNL2116MBF	81	HNL2942LL	77
HMAINFEED156	209	HMNG30FCD	281, 487	HMVPCA1-1830R	675	HMVR-3084(?) -NS	672	HNL2116MFF	81	HNL2948FD	77
HMAINFEED72	209	HMNG30FCO	281, 487	HMVPCA2-1830G	675	HMVR-3096(?) -FX	671	HNL231028PBFF	105	HNL2948LD	77
HMAINFEED72ST	209	HMNG30STDM	281	HMVPCA2-1830R	675	HMVR-3096(?) -NS	672	HNL231028PFF	105	HNL2948LL	77
HMAJUMP	668, 678	HMNG36FCD	281, 487	HMVPCF-1830G	675	HMVR-3648(?) -AH	673	HNL231041PBFF	107	HNL2948SD	78
HMAJUMP108	209	HMNG360VRD	282	HMVPCF-1830R	675	HMVR-3648(?) -FX	671	HNL231628PBFF	105	HNL2960FD	77
HMAJUMP12	209	HMNG36STDM	281	HMVPCSS-4C	675	HMVR-3648(?) -NS	672	HNL231628PFF	105	HNL2960LD	77
HMAJUMP120	209	HMNG48WKSL	280	HMVPCSS-4C4C	675	HMVR-3660(?) -AH	673	HNL231641PBFF	107	HNL2960LL	77
HMAJUMP132	209	HMNG600VRD	282	HMVPCSS-4C9C	675	HMVR-3660(?) -FX	671	HNL231641PSBFF	107	HNL2960SD	78
HMAJUMP144	209	HMNG60WKS	280	HMVPCSS-4O	675	HMVR-3660(?) -NS	672	HNL231828PBFF	105	HNL2966FD	77
HMAJUMP18	209	HMNG60WKSL	280	HMVPCSS-4O4C	675	HMVR-3672(?) -AH	673	HNL231828PFF	105	HNL2966LD	77
HMAJUMP24	209	HMNG72WKS	280	HMVPCSS-4O9C	675	HMVR-3672(?) -FX	671	HNL233028PBK	106	HNL2966LL	77
HMAJUMP30	209	HMNGDIV	280	HMVR-1848(?) -AH	673	HMVR-3672(?) -NS	672	HNL233028PLF	105	HNL2966SD	78
HMAJUMP36	209	HMNGDLEG	280	HMVR-1848(?) -FD	674	HMVT-2448(?) -FX	671	HNL233028PSC	106	HNL2972FD	77
HMAJUMP42	209	HMNGPPS	282	HMVR-1848(?) -FX	671	HMVT-2448(?) -NS	672	HNL233028PSL	106	HNL2972LD	77
HMAJUMP48	209	HMNGOHLG	282	HMVR-1848(?) -NS	672	HMVT-3060(?) -FX	671	HNL233628PBK	106	HNL2972LL	77
HMAJUMP54	209	HMNGSHTR	282	HMVR-1860(?) -AH	673	HMVT-3060(?) -NS	672	HNL233628PLF	105	HNL2972SD	78
HMAJUMP60	209	HMNGWVKWL	282	HMVR-1860(?) -FD	674	HMVT-3672(?) -FX	671	HNL233628PSC	106	HNL2978FD	77
HMAJUMP66	209	HMNNT1	580	HMVR-1860(?) -FX	671	HMVT-3672(?) -NS	672	HNL233628PSL	106	HNL2978LD	77
HMAJUMP72	209	HMNNT2	580	HMVR-1860(?) -NS	672	HN1	581	HNL241850TLL	85	HNL2978LL	77
HMAJUMP84	209	HMS1	576	HMVR-1872(?) -AH	673	HN1U	581	HNL241850TLR	85	HNL2978SD	78
HMAJUMP96	209	HMS2	576	HMVR-1872(?) -FD	674	HN6	582	HNL241865SFLL	83	HNL301850TLL	85
HMAPLATE	668, 678, 710	HMSCART	576	HMVR-1872(?) -FX	671	HN7	582	HNL241865SFLR	83	HNL301850TLR	85
HMAPOWER36	678	HMSFLTGLD	576	HMVR-1872(?) -NS	672	HN899900	327, 362	HNL241865SFX	83	HNL3060DPRF	62
HMAPOWER362	678	HMSGANG	576	HMVR-2436(?) -AH	673	HN899910	327, 362	HNL241865WLL	84	HNL3066BUEP	63
HMAPOWER42	678	HMSGLD	576	HMVR-2436(?) -FX	671	HNATA	582	HNL241865WLR	84	HNL3066DPRF	62
HMAPOWER422	678	HMSSTLGLD	576	HMVR-2436(?) -NS	672	HNFA	582	HNL241879WLL	84	HNL3066BPRF	62
HMAPOWER48	668, 678	HMT1	575	HMVR-2442(?) -AH	673	HNL11SUPP	99	HNL241879WLR	84	HNL3066RPRF	62
HMAPOWER482	668, 678	HMT1848E	662	HMVR-2442(?) -FX	671	HNL122428BKE	106	HNL242465TLR	85	HNL3072BUEP	63
HMAPOWER54	678	HMT1848G	662	HMVR-2442(?) -NS	672	HNL123028BKE	106	HNL242465TLL	85	HNL3605SSEP	70
HMAPOWER542	678	HMT1860E	662	HMVR-2448(?) -AH	673	HNL123628BKE	106	HNL242479TLL	85	HNL3630BHLD	79
HMAPOWER60	668, 678, 710	HMT1860G	662	HMVR-2448(?) -FD	674	HNL1530BK2	86	HNL242479TLR	85	HNL3630BHDX	79
HMAPOWER602	668, 678	HMT1872E	662	HMVR-2448(?) -FX	671	HNL1530BK3	86	HNL24248K5CL	86	HNL3630TB	111
HMAPOWER66	678	HMT1872G	662	HMVR-2448(?) -NS	672	HNL1530BK4	86	HNL24248K5CR	86	HNL3630WB	111
HMAPOWER662	678	HMT2448E	662	HMVR-2454(?) -AH	673	HNL1530BK5	86	HNL243629SC	83	HNL3636BHF	79
HMAPOWER72	668, 678, 710	HMT2448G	662	HMVR-2454(?) -FX	671	HNL1530BK6	86	HNL243665SC	83	HNL3636BHLD	79
HMAPOWER722	668, 678	HMT2460E	662	HMVR-2454(?) -NS	672	HNL1530FD	76, 708	HNL243665SLL	83	HNL3636BHXD	79
HMAPOWER84	668, 678, 710	HMT2460G	662	HMVR-2460(?) -AH	673	HNL1530LD	76, 708	HNL243665WL	84	HNL3636CU	64
HMAPOWER842	668, 678	HMT2472E	662	HMVR-2460(?) -FD	674	HNL1530LL	76, 708	HNL243665WLB	84	HNL3636FD	69
HMAPOWER96	668, 678, 710	HMT2472G	662	HMVR-2460(?) -FX	671	HNL1536FD	76, 708	HNL243665WRBL	84	HNL3636LD	69
HMAPOWER962	668, 678	HMT2484G	662	HMVR-2460(?) -NS	672	HNL1536LD	76, 708	HNL243679SC	83	HNL3636LL	69
HMASPLIT	210	HMT2496G	662	HMVR-2466(?) -AH	673	HNL1536LD	76, 708	HNL243679WL	84	HNL3636TB	111
HMASPLITBP5	210	HMT3048E	662	HMVR-2466(?) -FX	671	HNL1542FD	76, 708	HNL243679WLB	84	HNL3636WB	111
HMBFLIP18L	664	HMT3048G	662	HMVR-2466(?) -NS	672	HNL1542LD	76, 708	HNL243679WRBL	84	HNL3642FD	69
HMBFLIP18S	664	HMT3060E	662	HMVR-2472(?) -AH	673	HNL1542LL	76, 708	HNL2436LD2	82	HNL3642LD	69
HMBFLIP24L	664	HMT3060G	662	HMVR-2472(?) -FD	674	HNL1548FD	76, 708	HNL2436LD3	82	HNL3642LL	69
HMBFLIP24S	664	HMT3072E	662	HMVR-2472(?) -FX	671	HNL1548LD	76, 708	HNL2436LD4	82	HNL3648FD	69
HMBFLIP24XL	664	HMT3072G	662	HMVR-2472(?) -NS	672	HNL1548LL	76, 708	HNL2442BF	67	HNL3648LD	69
HMBFLIP30L	664	HMT3084G	662	HMVR-2484(?) -FX	671	HNL1548SD	76, 708	HNL2442LP	67	HNL3648LL	69
HMBFLIP30S	664	HMT3096G	662	HMVR-2484(?) -NS	672	HNL1560FD	76, 708	HNL2442RP	67	HNL3648SD	70
HMBFLIP30XL	664	HMT5	575	HMVR-2496(?) -FX	671	HNL1560LD	76, 708	HNL2448BF	67	HNL3660FD	69
HMBPOST	101, 664	HMTHR3060E	663	HMVR-2496(?) -NS	672	HNL1560LL	76, 708	HNL2448LP	67	HNL3660LD	69
HMBPOST1	415	HMTHR3060G	663	HMVR-3036(?) -AH	673	HNL1560SD	76, 708	HNL2448RP	67	HNL3660LL	69
HMBTLEG18	664	HMTHR3248E	663	HMVR-3036(?) -FX	671	HNL1566FD	76, 708	HNL2460DPK	65	HNL3660SD	70
HMBTLEG24	101, 664	HMTHR3248G	663	HMVR-3036(?) -NS	672	HNL1566LD	76, 708	HNL2466DPK	65	HNL3666FD	69
HMG1	577	HMTS01	527	HMVR-3042(?) -AH	673	HNL1566LL	76, 708	HNL2472DPK	65	HNL3666LD	69
HMG2	577	HMTS11	527	HMVR-3042(?) -FX	671	HNL1566SD	76, 708	HNL2472DPS	65	HNL3666LL	69
HMG5	577	HMTUMOD26	675	HMVR-3042(?) -NS	672	HNL1572FD	76, 708	HNL2472LLC	65	HNL3666SD	70
HMG7	577	HMTUMOD32	665, 675	HMVR-3048(?) -AH	673	HNL1572LD	76, 708	HNL2472LP	65	HNL3672BUEP	63
HMG1T	579	HMTUMOD38	675	HMVR-3048(?) -FD	674	HNL1572LL	76, 708	HNL2472RLC	65	HNL3672PB	62
HMG2T	579	HMTUMOD44	665, 675	HMVR-3048(?) -FX	671	HNL1572SD	76, 708	HNL2472RP	65	HNL3672PBFF	62
HMH01	528	HMTUMOD50	675	HMVR-3048(?) -NS	672	HNL1578FD	76, 708	HNL291028PBFF	105	HNL3672PB	62
HMH02	528	HMTUMOD56	665, 675	HMVR-3054(?) -AH	673	HNL1578LD	76, 708	HNL291028PFF	105	HNL3672PRB	62
HML1S	557	HMTUMOD62	675	HMVR-3054(?) -FX	671	HNL1578LL	76, 708	HNL291041PBFF	107	HNL3672PRBF	62
HML1SDF	561	HMTUMOD74	675	HMVR-3054(?) -NS	672	HNL1578SD	76, 708	HNL291628PBFF	105	HNL3672PR	62
HML2S	557	HMTUMOD86	675	HMVR-3060(?) -AH	673	HNL1772RT	80	HNL291628PFF	105	HNL3672FD	69
HML2SDF	561	HMVH-2448(?) -FX	671	HMVR-3060(?) -FD	674	HNL203021D2	66	HNL291641PBFF	107	HNL3672LD	69
HML2ST	559	HMVH-2448(?) -NS	672	HMVR-3060(?) -FX	671	HNL2030MSFC	81	HNL291641PSBFF	107	HNL3672LL	69
HML2STDF	563	HMVH-3060(?) -FX	671	HMVR-3060(?) -NS	672	HNL203621D2	66	HNL2930FD	77	HNL3672LPB	62
HML3S	558	HMVH-3060(?) -NS	672	HMVR-3066(?) -AH	673	HNL206021D4	66	HNL2930LD	77	HNL3672LPBFF	62

Model	Page	Model	Page	Model	Page	Model	Page	Model	Page	Model	Page
HNL3672LPBR	62	HNLEP2441L	98	HNLRC2484	90	HPC325L	131	HPM637X	144	HRFF3530P	324
HNL3672LPBR	62	HNLEP2441R	98	HNLRC2490	90, 707	HPC325R	131	HPM640X	144	HRFF3536P	324
HNL3672LPBR	62	HNLEP247L	99	HNLRC2496	90	HPC402X	134	HPM680L	146	HRFF3542P	324
HNL3672LPBR	62	HNLEP247R	99	HNLRC3048	90	HPC403X	134	HPM680R	146	HRFF3548P	324
HNL3672RPBB	62	HNLEP3028L	98	HNLRC3060	90	HPC404X	134	HPM682L	146	HRFF3560P	324
HNL3672RPBB	62	HNLEP3028R	98	HNLRC3066	90	HPC405X	134	HPM682R	146	HRFF4224P	324
HNL3672RPBR	62	HNLEP3041L	98	HNLRC3072	90	HPC500G	135	HPM692L	146	HRFF4230P	324
HNL3672RPBR	62	HNLEP3041R	98	HNLRC3078	90	HPC500K	135	HPM692R	146	HRFF4236P	324
HNL3672RPBR	62	HNLEP307L	99	HNLRC3084	90	HPC500W	135	HPM701X	143	HRFF4242P	324
HNL3672RPBR	62	HNLEP307R	99	HNLRC3672	90	HPC501G	135	HPM702X	143	HRFF4248P	324
HNL3672SD	70	HNLEP3628L	98	HNLRC3684	90	HPC501K	135	HPM704X	143	HRFF4260P	324
HNL3678FD	69	HNLEP3628R	98	HNLEP2428	99	HPC501W	135	HPM706X	142	HRFF5024P	324
HNL3678LD	69	HNLB1013	109	HNLEP3028	99	HPC502G	135	HPM708X	142	HRFF5030P	324
HNL3678LL	69	HNLB1018	109	HNLEP3628	99	HPC502K	135	HPM709X	142	HRFF5036P	324
HNL3678SD	70	HNLB1613	109	HNPMBSW24	342, 422	HPC502W	135	HPM801K	147	HRFF5042P	324
HNL4272JLEP	63	HNLB1618	109	HNPMBSW30	342, 422	HPC503G	135	HPM801W	147	HRFF5048P	324
HNL4272JREP	63	HNLB1818	109	HNPMBSW36	342, 422	HPC503K	135	HPM802K	147	HRFF5060P	324
HNL4872JLEP	63	HNLB3018	109	HNPMBSW42	342, 422	HPC503W	135	HPM802W	147	HRFF6524P	324
HNL4872JREP	63	HNLB3618	109	HNPMBSW48	342, 422	HPC505G	135	HPM804K	147	HRFF6530P	324
HNL4905SSEP	72	HNLEP2428L	99	HNPMBSW60	342, 422	HPC505K	135	HPM804W	147	HRFF6536P	324
HNL4930BHLD	79	HNLEP2428R	99	HOLEG24	414	HPC505W	135	HPM806K	147	HRFF6542P	324
HNL4930BHLD	79	HNLEP2441L	99	HOLEG30	414	HPC506G	135	HPM806W	147	HRFF6548P	324
HNL4930TB	111	HNLEP2441R	99	HP3231	287	HPC506K	135	HPM828X	148	HRFF6560P	324
HNL4930WB	111	HNLEP3028L	99	HP3235R	287	HPC506W	135	HPMARKER1	753	HRN2748M	722
HNL4936BHFD	79	HNLEP3028R	99	HP3236L	287	HPC507G	135	HPN1	589	HRN2760M	722
HNL4936BHLD	79	HNLEP3041L	99	HP3251R	287	HPC507K	135	HPN2	589	HRN2948M	722
HNL4936BHLD	79	HNLEP3041R	99	HP3261	287	HPC507W	135	HPPMAS	343, 422	HRN2960M	722
HNL4936FD	71	HNLMP3010	95	HP3262	287	HPC522G	136	HPPMFB	343, 422, 740	HRS2760M	722
HNL4936LD	71	HNLMP3028	95	HP3265R	287	HPC522K	136	HPPMHK	740	HRS2960M	722
HNL4936LL	71	HNLMP3610	95	HP3266L	287	HPC522W	136	HPPMMT	740	HRVBR1524	407
HNL4936TB	111	HNLMP3628	95, 707	HP3276	287	HPC523G	136	HPPMPB	343, 422, 740	HRVBR1524P	407
HNL4936WB	111	HNLMP4210	95	HPA820X	512	HPC523K	136	HPPMPC	740	HRVBR1530	407
HNL4942FD	71	HNLMP4228	95	HPA824X	512	HPC523W	136	HPPMPS	343, 422	HRVBR1530P	407
HNL4942LD	71	HNLMP4810	95	HPA848X	512	HPC524G	136	HPPMPT	343, 422	HRVBR1536	407
HNL4942LL	71	HNLMP4828	95	HPA8A01	587	HPC524K	136	HPPMST	343, 422	HRVBR1536P	407
HNL4948FD	71	HNLMP5410	95	HPAL02	587	HPC524W	136	HPSEAT18ND	479	HRVBR1542	407
HNL4948LD	71	HNLMP5428	95, 707	HPA503	587	HPC525G	136	HPSEAT24ND	463, 465, 467, 479	HRVBR1548	407
HNL4948LL	71	HNLMP6010	95	HPBC1D1D18	658	HPC525K	136	HPTA072	149	HRVBR1560	407
HNL4948SD	72	HNLMP6028	95	HPBC1F1D18	658	HPC525W	136	HPTA096	149	HRVBR1566	407
HNL4960FD	71	HNLMP6610	95	HPBC1S18	659	HPC541X	139	HPTA120	149	HRVBR1572	407
HNL4960LD	71	HNLMP6628	95	HPBC2D2D36	658	HPC553X	139	HPTA144	149	HRVBR1584	407
HNL4960LL	71	HNLMP7210	95	HPBC4D18	658	HPC613X	137	HPTB072	149	HRVBR1584	407
HNL4960SD	72	HNLMP7228	95, 707	HPC023D	131	HPC614X	137	HPTB096	149	HRVBR1584	407
HNL4966FD	71	HNLMP7810	95	HPC023L	131	HPC630X	137	HPTB120	149	HRVBR1584	407
HNL4966LD	71	HNLMP7828	95	HPC023R	131	HPC634X	137	HPTB144	149	HRVBR1584	407
HNL4966LL	71	HNLMP8410	95	HPC027D	131	HPC670X	138	HPTC072	149	HRVBR1584	407
HNL4966SD	72	HNLMP8428	95	HPC027L	131	HPC673X	138	HPTC096	149	HRVBR1584	407
HNL4972FD	71	HNLMP9010	95	HPC027R	131	HPC690G	137	HPTC120	149	HRVBR1584	407
HNL4972LD	71	HNLMP9028	95, 707	HPC031D	131	HPC690X	137	HPTC144	149	HRVBR1584	407
HNL4972LL	71	HNLMP9610	95	HPC031L	131	HPC700X	137	HPTD042	149	HRVBR1584	407
HNL4972SD	72	HNLMP9628	95	HPC031R	131	HPC710L	138	HPTD048	149	HRVBR1584	407
HNL4978FD	71	HNLPB1028	109	HPC032D	131	HPC710R	138	HPWRMOD2	223, 409, 643	HRVBR1584	407
HNL4978LD	71	HNLPB1041	109	HPC100X	133	HPC720G	138	HPWRMOD2UWM	391, 423, 748	HRVBR1584	407
HNL4978LL	71	HNLPB1628	109	HPC111X	133	HPC720W	138			HRVBR1584	407
HNL4978SD	72	HNLPB1641	109	HPC130L	133	HPC740W	138	HPWRMOD2WC	391, 423, 748	HRVBR1584	407
HNL7872RLT	80	HNLPB1828	109	HPC130R	133	HPC736	659	HPWRMOD3UWM	391, 423, 748	HRVBR1584	407
HNL7872RT	80	HNLPT2416	108	HPC131L	133	HPC754	659			HRVBR1584	407
HNL8472RLT	80	HNLPT2418	108	HPC131R	133	HPC772	659	HPWRMOD3WC	391, 423, 748	HRVBR1584	407
HNL8472RT	80	HNLPT3016	108	HPC140L	133	HPC790	659	HQB	666, 676	HRVBR1584	407
HNLBU3048	91	HNLRC2042V	90	HPC140R	133	HPCW1	463, 479	HQH1-3	666, 676	HRVBR1584	407
HNLBU3060	91	HNLRC2048V	90	HPC153X	134	HPD2PNBRK2L	416	HQH5-3	666, 676	HRVBR1584	407
HNLBU3066	91	HNLRC2430	90	HPC180G	63, 133, 161, 230, 260	HPD2PNBRK2R	416	HQJ3	666, 676	HRVBR1584	407
HNLBU3072	91	HNLRC2430V	90			HPHC1D18	658	HQTMM	594	HRVBR1584	407
HNLBU3078	91	HNLRC2436V	90, 707	HPC180W	63, 133	HPHC2D36	658	HQTSM	594	HRVBR1584	407
HNLBU3084	91	HNLRC2442	90	HPC190X	63, 101, 133, 221	HPKT001	753	HR1P	591	HRVBR1584	407
HNLBW3672	91	HNLRC2448	90	HPC191X	63, 101, 133, 221	HPLKIT	659	HR1S	591	HRVBR1584	407
HNLBW3684	91	HNLRC2448V	90	HPC200D	132	HPM512X	141	HR1W	591	HRVBR1584	407
HNLCDSHLDF	111	HNLRC2454	90, 707	HPC210D	132	HPM514X	141	HR273012M	721	HRVBR1584	407
HNLEP367224L	91	HNLRC2454V	90	HPC211D	132	HPM520X	141	HR293012M	721	HRVBR1584	407
HNLEP367224R	91	HNLRC2460	90	HPC212D	132	HPM522X	141	HR5P	592	HRVBR1584	407
HNLEP367224R	91	HNLRC2460V	90	HPC230L	132	HPM524X	141	HR5S	592	HRVBR1584	407
HNLEP1128	98	HNLRC2466	90	HPC230R	132	HPM630X	144	HR5W	592	HRVBR1584	407
HNLEP1141	98	HNLRC2472	90, 707	HPC233L	132	HPM631X	145	HRAAP	593	HRVBR1584	407
HNLEP2428L	98	HNLRC2478	90	HPC233R	132	HPM632X	145	HRFAP	593	HRVBR1584	407
HNLEP2428R	98			HPC324L	131	HPM633X	144	HRFF3524P	324	HRVBR1584	407
				HPC324R	131	HPM634X	145			HRVBR1584	407

Cross Reference Index

HON

Model	Page	Model	Page	Model	Page	Model	Page	Model	Page	Model	Page
HRVC42PY3	330	HRVFSB30	325	HRVT0796F	340	HRV13024G	338	HRVT4524E	336	HSCBX223018BFL(?)	450
HRVC50PF	331	HRVFSB36	325	HRVT1524CK	347	HRVT3024HS	337	HRVT4524T	334	HSCBX223018BFM(?)	448
HRVC50PL	329	HRVFSB42	325	HRVT1524E	335	HRVT3024M	344	HRVT4530E	336	HSCBX2230180	448
HRVC50PS	329	HRVFSB48	325	HRVT1524F	340	HRVT3024P	341	HRVT4530T	334	HSCBX223618BFL(?)	450
HRVC50PT	329	HRVFSB60	325	HRVT1524G	338	HRVT3024PM	345	HRVT4536E	336	HSCBX223618BFM(?)	448
HRVC50PX	329	HRVFSBW24	332	HRVT1524HS	337	HRVT3024R	339	HRVT4536T	334	HSCBX2236180	448
HRVC50PY2	330	HRVFSBW30	332	HRVT1524M	344	HRVT3024ST	346	HRVT4542E	336	HSCBX224818LBFL(?)	450
HRVC50PY3	330	HRVFSBW36	332	HRVT1524PM	345	HRVT3024T	333	HRVT4542T	334	HSCBX224818LBFOM(?)	448
HRVC65PF	331	HRVFSBW42	332	HRVT1524R	339	HRVT3030CK	347	HRVT4548E	336	HSCBX224818RBFOL(?)	450
HRVC65PL	329	HRVFSBW48	332	HRVT1524ST	346	HRVT3030E	335	HRVT4548T	334	HSCBX224818RBFOM(?)	448
HRVC65PS	329	HRVFSBW60	332	HRVT1524T	333	HRVT3030G	338	HRVT4560E	336	HSCBX226018LBFL(?)	450
HRVC65PT	329	HRVOH1530RM	370	HRVT1524W	342	HRVT3030HS	337	HRVT4560T	334	HSCBX226018LBFOM(?)	448
HRVC65PV	331	HRVOH1536RM	370	HRVT1530CK	347	HRVT3030M	344	HRVT6024E	336	HSCBX226018RBFOL(?)	450
HRVC65PX	329	HRVOH1542RM	370	HRVT1530E	335	HRVT3030P	341	HRVT6024T	334	HSCBX226018RBFOM(?)	448
HRVC65PY2	330	HRVOH1548RM	370	HRVT1530F	340	HRVT3030PM	345	HRVT6030E	336	HSCBX227218LBFL(?)	450
HRVC65PY3	330	HRVOH1560RM	370	HRVT1530G	338	HRVT3030R	339	HRVT6030T	334	HSCBX227218LBFOM(?)	448
HRVC7FFV	331	HRVOH24FM	370	HRVT1530HS	337	HRVT3030ST	346	HRVT6036E	336	HSCBX227218RBFOL(?)	450
HRVC7PFT	331	HRVOH30FM	370	HRVT1530M	344	HRVT3030T	333	HRVT6036T	334	HSCBX227218RBFOM(?)	448
HRVC7PFV	331	HRVOH36FM	370	HRVT1530PM	345	HRVT3036CK	347	HRVT6042E	336	HSCCK24BF	452
HRVC7PL	329	HRVOH42FM	370	HRVT1530R	339	HRVT3036E	335	HRVT6042T	334	HSCCK30BF	452
HRVC7PS	329	HRVOH48FM	370	HRVT1530ST	346	HRVT3036G	338	HRVT6048E	336	HSCCK300	452
HRVC7PT	329	HRVOH60FM	370	HRVT1530T	333	HRVT3036HS	337	HRVT6048T	334	HSCCK36BF	452
HRVC7PX	329	HRVOH72FM	370	HRVT1530W	342	HRVT3036M	344	HRVT6060E	336	HSCCK360	452
HRVC80PF	331	HRVOHV24HLA	372	HRVT1536CK	347	HRVT3036P	341	HRVT6060T	334	HSCCKTPS	366
HRVC80PL	329	HRVOHV24HMA	372	HRVT1536E	335	HRVT3036PM	345	HRVTC24	323	HSCS1	524
HRVC80PS	329	HRVOHV30HLA	372	HRVT1536F	340	HRVT3036R	339	HRVTC30	323	HSCS1DF	525
HRVC80PT	329	HRVOHV30HMA	372	HRVT1536G	338	HRVT3036ST	346	HRVTC36	323	HSCS2	524
HRVC80PX	329	HRVOHV36HLA	372	HRVT1536HS	337	HRVT3036T	333	HRVTC42	323	HSCS2DF	526
HRVCLG24	305, 414	HRVOHV36HMA	372	HRVT1536M	344	HRVT3042CK	347	HRVTC48	323	HSCSF223018BFL(?)	451
HRVCLG30	305, 414	HRVOHV42HLA	372	HRVT1536PM	345	HRVT3042E	335	HRVTC54	323	HSCSF223018BFM(?)	449
HRVD0742T	327	HRVOHV42HMA	372	HRVT1536R	339	HRVT3042G	338	HRVTC60	323	HSCSF2230180	449
HRVD9542P	327	HRVOHV48HLA	372	HRVT1536ST	346	HRVT3042HS	337	HRVTC66	323	HSCSF223618BFL(?)	451
HRVEP1129L	305, 414	HRVOHV48HMA	372	HRVT1536T	333	HRVT3042M	344	HRVTC72	323	HSCSF223618BFM(?)	449
HRVEP1129R	305, 414	HRVOMOD	332	HRVT1536W	342	HRVT3042P	341	HRVTC78	323	HSCSF2236180	449
HRVEP2429L	305, 414	HRVP24P	390	HRVT1542CK	347	HRVT3042PM	345	HRVTC84	323	HSCSF224818LBFL(?)	451
HRVEP2429R	305, 414	HRVP30P	390	HRVT1542E	335	HRVT3042R	339	HRVTC90	323	HSCSF224818LBFOM(?)	449
HRVEP3029L	305, 414	HRVP36P	390	HRVT1542F	340	HRVT3042ST	346	HRVTC96	323	HSCSF224818RBFOL(?)	451
HRVEP3029R	305, 414	HRVP42P	390	HRVT1542G	338	HRVT3042T	333	HRVTRAYM	344	HSCSF224818RBFOM(?)	449
HRVF1524	325	HRVP48P	390	HRVT1542HS	337	HRVT3048CK	347	HRVUP24	377	HSCSF226018LBFL(?)	451
HRVF1530	325	HRVP60P	390	HRVT1542M	344	HRVT3048E	335	HRVUP30	377	HSCSF226018LBFOM(?)	449
HRVF1536	325	HRVSH24	370	HRVT1542PM	345	HRVT3048G	338	HRVUP36	377	HSCSF226018RBFOL(?)	451
HRVF1542	325	HRVSH30	370	HRVT1542R	339	HRVT3048HS	337	HRVUP42	377	HSCSF226018RBFOM(?)	449
HRVF1548	325	HRVSH36	370	HRVT1542ST	346	HRVT3048M	344	HRVUP48	377	HSCSF227218LBFL(?)	451
HRVF1560	325	HRVSH42	370	HRVT1542T	333	HRVT3048P	341	HRVUP60	377	HSCSF227218LBFOM(?)	449
HRVF3024	325	HRVSH48	370	HRVT1542W	342	HRVT3048PM	345	HS1100 119, 174, 208, 247, 270, 294, 426, 647, 746		HSCSF227218RBFOL(?)	451
HRVF3030	325	HRVSH60	370	HRVT1548CK	347	HRVT3048R	339	HS1101 119, 174, 208, 247, 270, 294, 426, 647, 746		HSCSF227218RBFOM(?)	449
HRVF3036	325	HRVSH72	370	HRVT1548E	335	HRVT3048ST	346	HS1102 119, 174, 208, 247, 270, 294, 426, 647, 746		HSDDBK29	306
HRVF3042	325	HRVSHV24	372	HRVT1548F	340	HRVT3048T	333	HS273012M	722	HSDCDPA29L	306
HRVF3048	325	HRVSHV30	372	HRVT1548G	338	HRVT3060CK	347	HS293012M	722	HSDCDPA29R	306
HRVF3060	325	HRVSHV36	372	HRVT1548HS	337	HRVT3060E	335	HS30ABC	445	HSDCMP3614	307
HRVF3524P	323	HRVSHV42	372	HRVT1548M	344	HRVT3060G	338	HS42ABC	445	HSDCMP3629	307
HRVF3530P	323	HRVSHV48	372	HRVT1548PM	345	HRVT3060HS	337	HS60ABC	445	HSDCMP4214	307
HRVF3536P	323	HRVSS24	326	HRVT1548R	339	HRVT3060M	344	HS72ABC	445	HSDCMP4229	307
HRVF3542P	323	HRVSS30	326	HRVT1548ST	346	HRVT3060P	341	HS82ABC	445	HSDCMP4814	307
HRVF3548P	323	HRVSS36	326	HRVT1548T	333	HRVT3060PM	345	HSB50	524	HSDCMP4829	307
HRVF3560P	323	HRVSS42	326	HRVT1548W	342	HRVT3060R	339	HSB50DF	526	HSDCMP6014	307
HRVF4224P	323	HRVSS48	326	HRVT1554F	340	HRVT3060ST	346	HSC1842	446	HSDCMP6029	307
HRVF4230P	323	HRVSS60	326	HRVT1560CK	347	HRVT3060T	333	HSC1872	446	HSDCMP7214	307
HRVF4236P	323	HRVTO724F	340	HRVT1560E	335	HRVT3724E	335	HSC2472	446	HSDCMP7229	307
HRVF4242P	323	HRVTO724T	333, 341	HRVT1560F	340	HRVT3724HS	337	HSCABD02	453	HSDDL29	305
HRVF4248P	323	HRVTO730F	340	HRVT1560G	338	HRVT3724T	333	HSCABD10	453	HSDDPA29L	306
HRVF4260P	323	HRVTO730T	333, 341	HRVT1560HS	337	HRVT3730E	335	HSCACW25	452	HSDDPA29R	306
HRVF5024P	323	HRVTO736F	340	HRVT1560M	344	HRVT3730HS	337	HSCACW35	452	HSDEF1129F	305
HRVF5030P	323	HRVTO736T	333, 341	HRVT1560PM	345	HRVT3730T	333	HSCACW50	452	HSDEF2429F	305
HRVF5036P	323	HRVTO742F	340	HRVT1560R	339	HRVT3736E	335	HSCAFD02	453	HSDEF3029F	305
HRVF5042P	323	HRVTO742T	333, 341	HRVT1560ST	346	HRVT3736HS	337	HSCAFD10	453	HSDG	305
HRVF5048P	323	HRVTO748F	340	HRVT1560T	333	HRVT3736T	333	HSCAFD11	452	HSDMP244	307
HRVF5060P	323	HRVTO748T	333, 341	HRVT1560W	342	HRVT3742E	335	HSCAHR12	452	HSDMP249	307
HRVF6524P	323	HRVTO754F	340	HRVT1566F	340	HRVT3742HS	337	HSCAPB	452	HSDMP304	307
HRVF6530P	323	HRVTO760F	340	HRVT1572F	340	HRVT3742T	333	HSCAUC1824	453	HSDMP309	307
HRVF6536P	323	HRVTO760T	333, 341	HRVT1578F	340	HRVT3748E	335	HSCAUC1830	453	HSDMP364	307
HRVF6542P	323	HRVTO766F	340	HRVT1584F	340	HRVT3748HS	337	HSCAUC1836	453	HSDMP369	307
HRVF6548P	323	HRVTO772F	340	HRVT1590F	340	HRVT3748T	333	HSCAW56520	452	HSDMP424	307
HRVF6560P	323	HRVTO778F	340	HRVT1596F	340	HRVT3760E	335	HSCAW56524	452	HSDMP429	307
HRVFFOOT	324	HRVTO784F	340	HRVT3024CK	347	HRVT3760HS	337	HSCAW56530	452	HSDMP484	307
HRVFSB24	325	HRVTO790F	340	HRVT3024E	335	HRVT3760T	333			HSDMP489	307

Model	Page	Model	Page	Model	Page	Model	Page	Model	Page	Model	Page
HSDMP544	307	HSPSSF281530BBFM(?)	463	HSTSSF652424RFFL(?)	461	HTLCUBES168	701	HTLRCM	702	HTVCUBES168	693
HSDMP549	307	HSPSSF281530FFLA(?)	465	HSTSSF652424RFFM(?)	459	HTLCUBES180	701	HTLRM	702	HTVCUBES180	693
HSDMP604	307	HSPSSF281530FFM(?)	463	HSWEEPA2	244, 267	HTLCUBES192	701	HTLSHELF	697, 705	HTVCUBES192	693
HSDMP609	307	HSS4L-12A	733	HSWEEPA3	244, 267	HTLCUBES216	701	HTLT120	700	HTVCUBES216	693
HSDMP664	307	HSS4L-14A	733	HSWEEPC2	244, 267	HTLCUBES240	701	HTLT144	700	HTVCUBES240	693
HSDMP669	307	HSS4L-16B	733	HSWEEPC3	244, 267	HTLCUBES48	701	HTLT168	700	HTVCUBES96	693
HSDMP724	307	HSS4L-18B	733	HT-20B	657	HTLCUBES96	701	HTLT72	700	HTVCUBESM	693
HSDMP729	307	HSSA-WB1618	733	HT-26B	657	HTLCUBESM	701	HTLT96	700	HTVF3060	691
HSDRK29	306	HSSCL-18B	734	HT48ND	296	HTLF3060	699	HTLXP36	703	HTVF3672	691
HSDSL2429F	305	HSSST-18B	734	HT60ND	296	HTLF3672	699	HTLXP42	703	HTVF4284	691
HSDSL29	305	HSSTK-18B	734	HT66ND	296	HTLF4284	699	HTLXP48	703	HTVF4896	691
HSDSL3029F	305	HSTAKL	461	HT72ND	296	HTLF4896	699	HTPLATEDHAU	697, 711	HTVG3060	691
HSGANG	526	HSTAKR	461	HTBINSLIDE	697, 705	HTLG3060	699	HTPLATEHD	697, 711	HTVG3672	691
HSGS6	524	HSTB2W1	92, 204, 222, 416	HTCOL52	80, 139, 169, 240, 266, 275	HTLG3672	699	HTPLATEUSB4	697, 711	HTVG4284	691
HSGS6DF	525	HSTBX502424LBBFL(?)	456	HTL(?)3060	698	HTLG4284	699	HTPLATEVGA	697, 711	HTVG4896	691
HSLV2DAP	600	HSTBX502424LBBFM(?)	454	HTL(?)36	699	HTLG4896	699	HTPLATEVHAU	697, 711	HTVHP108	693
HSLV4DAP	600	HSTBX502424LFFL(?)	456	HTLHP108	701	HTLHP108	701	HTPWGRM1	42, 149, 540, 560, 564, 648, 668, 679, 697, 710, 747	HTVHP120	693
HSLVFAP	600	HSTBX502424LFFM(?)	454	HTL(?)3672	698	HTLHP120	701			HTVHP144	693
HSLVLMBR	600	HSTBX502424RBBFL(?)	456	HTL(?)42	699	HTLHP144	701			HTVHP168	693
HSLVSM	597	HSTBX502424RBBFM(?)	454	HTL(?)4284	698	HTLHP168	701	HTPWGRM2	149, 697, 710	HTVHP180	693
HSLVSMR	598	HSTBX502424RFFL(?)	456	HTL(?)48	699	HTLHP180	701	HTPWGRM3	697, 710	HTVHP192	693
HSLVSMU	599	HSTBX502424RFFM(?)	454	HTL(?)48108	698	HTLHP180	701	HTPWGRM4	697, 710, 711	HTVHP216	693
HSLVTMM	597	HSTBX652424LBBFL(?)	456	HTL(?)48120	698	HTLHP192	701	HTPWGRM5	697, 710	HTVHP240	693
HSLVTMR	598	HSTBX652424LBBFM(?)	454	HTL(?)48144	698	HTLHP216	701	HTPWRGROM1	697, 710	HTVHP84	693
HSLVTMU	599	HSTBX652424LFFL(?)	456	HTL(?)48168	698	HTLHP240	701	HTRACK	697, 705	HTVHP96	693
HSPAK15	463	HSTBX652424LFFM(?)	454	HTL(?)48180	698	HTLHP240	701	HTTLEG108	692, 700	HTVHPM	693
HSPAST1518	463	HSTBX652424RBBFL(?)	456	HTL(?)48180	698	HTLHP96	701	HTTLEG120	692, 700	HTVM4872	690
HSPAST1524	463	HSTBX652424RBBFM(?)	454	HTL(?)48216	698	HTLHPM	701	HTTLEG144	692, 700	HTVM5472	690
HSPAST1530	463	HSTBX652424RFFL(?)	456	HTL(?)48240	698	HTLLECTA	706	HTTLEG168	692, 700	HTVP108	692
HSPFSF221518BFLA(?)	465	HSTBX652424RFFM(?)	454	HTL(?)4896	698	HTLM4872	698	HTTLEG180	692, 700	HTVP120	692
HSPFSF221518BFM(?)	463	HSTSBX502424LBBFL(?)	457	HTL(?)54108	698	HTLM5472	698	HTTLEG192	692, 700	HTVP144	692
HSPFSF221524BFLA(?)	465	HSTSBX502424LBBFM(?)	455	HTL(?)54120	698	HTLM7248P	712	HTTLEG216	692, 700	HTVP168	692
HSPFSF221524BFM(?)	463	HSTSBX502424LFFL(?)	457	HTL(?)54144	698	HTLMC1828DL	706	HTTLEG240	692, 700	HTVP180	692
HSPH181518BFLA(?)	464	HSTSBX502424LFFM(?)	455	HTL(?)54168	698	HTLMC1828L	706	HTTLEG60	692, 700	HTVP192	692
HSPH181518BFM(?)	462	HSTSBX502424RBBFL(?)	457	HTL(?)54180	698	HTLMC1828O	706	HTTLEG72	692, 700	HTVP216	692
HSPH181524BFLA(?)	464	HSTSBX502424RBBFM(?)	455	HTL(?)54192	698	HTLMC1828R	706	HTTLEG84	692, 700	HTVP240	692
HSPH181524BFM(?)	462	HSTSBX502424RFFL(?)	457	HTL(?)54216	698	HTLMC1828R	706	HTTLEG96	692, 700	HTVP60	692
HSPH181530BFLA(?)	464	HSTSBX502424RFFM(?)	455	HTL(?)54240	698	HTLP108	700	HTTLEGM	692, 700	HTVP72	692
HSPH181530BFM(?)	462	HSTSBX652424LBBFL(?)	457	HTLB1048LP	712	HTLP120	700	HTV(?)3060	690	HTVP84	692
HSPM211518BFLA(?)	464	HSTSBX652424LBBFM(?)	455	HTLB12048P	712	HTLP144	700	HTV(?)36	691	HTVP96	692
HSPM211518BFM(?)	462	HSTSBX652424LFFL(?)	457	HTLB1248LP	712	HTLP168	700	HTV(?)3672	690	HTVPM	692
HSPM211524BFLA(?)	464	HSTSBX652424LFFM(?)	455	HTLB14448P	712	HTLP180	700	HTV(?)42	691	HTVPM	692
HSPM211524BFM(?)	462	HSTSBX652424RBBFL(?)	457	HTLB1448LP	712	HTLP192	700	HTV(?)4284	690	HTVPM	692
HSPM211518BFLA(?)	464	HSTSBX652424RBBFM(?)	455	HTLB1648LP	712	HTLP216	700	HTV(?)48	691	HTVRC108	694
HSPM211518BFM(?)	462	HSTSBX652424RFFL(?)	457	HTLB16848P	712	HTLP240	700	HTV(?)48108	690	HTVRC120	694
HSPM211518FFLA(?)	464	HSTSBX652424RFFM(?)	455	HTLB1848LP	712	HTLP60	700	HTV(?)48120	690	HTVRC144	694
HSPM211518FFM(?)	462	HSTSF502424LBBFL(?)	460	HTLB2048LP	712	HTLP72	700	HTV(?)48144	690	HTVRC168	694
HSPM211524BFLA(?)	464	HSTSF502424LBBFM(?)	458	HTLC4272HCTFP	704	HTLP84	700	HTV(?)48168	690	HTVRC180	694
HSPM211524BFM(?)	462	HSTSF502424LFFL(?)	460	HTLC4272HCTHP	704	HTLP96	700	HTV(?)48180	690	HTVRC192	694
HSPM211524FFLA(?)	464	HSTSF502424LFFM(?)	458	HTLC4272HCTP	704	HTLPB	712	HTV(?)48192	690	HTVRC240	694
HSPM211524FFM(?)	462	HSTSF502424RBBFL(?)	460	HTLC4272LCTFP	704	HTLPBS	712	HTV(?)48216	690	HTVRC240	694
HSPM211530BFLA(?)	464	HSTSF502424RBBFM(?)	458	HTLC4272LCTHP	704	HTLPM	700	HTV(?)48240	690	HTVRC36	694
HSPM211530BFM(?)	462	HSTSF502424RFFL(?)	460	HTLC4272LCTP	704	HTLPRES	709	HTV(?)4896	690	HTVRC48	694
HSPM211530FFLA(?)	464	HSTSF502424RFFM(?)	458	HTLC4296HCTFP	704	HTLR108	702	HTV(?)54108	690	HTVRC84	694
HSPM211530FFM(?)	462	HSTSF652424LBBFL(?)	460	HTLC4296HCTHP	704	HTLR120	702	HTV(?)54120	690	HTVRC84	694
HSPSBX281518BBFLA(?)	464	HSTSF652424LBBFM(?)	458	HTLC4296LCTFP	704	HTLR144	702	HTV(?)54144	690	HTVRC96	694
HSPSBX281518BBFM(?)	462	HSTSF652424LFFL(?)	460	HTLC4296LCTHP	704	HTLR168	702	HTV(?)54168	690	HTVRC108	694
HSPSBX281518FFLA(?)	464	HSTSF652424LFFM(?)	458	HTLC4296LCTP	704	HTLR180	702	HTV(?)54180	690	HTVRC120	694
HSPSBX281518FFM(?)	462	HSTSF652424RBBFL(?)	460	HTLCREDA	705	HTLR192	702	HTV(?)54192	690	HTVRC144	694
HSPSBX281524BBFLA(?)	464	HSTSF652424RBBFM(?)	458	HTLCREDB	705	HTLR216	702	HTV(?)54216	690	HTVRC168	694
HSPSBX281524BBFM(?)	462	HSTSF652424RFFL(?)	460	HTLCREDA	705	HTLR240	702	HTV(?)54240	690	HTVRC180	694
HSPSBX281524FFLA(?)	464	HSTSF652424RFFM(?)	458	HTLCUBE108	701	HTLR36	702	HTVRCREDA	696	HTVRC192	694
HSPSBX281524FFM(?)	462	HSTSSF502424LBBFL(?)	461	HTLCUBE120	701	HTLR42	702	HTVCUBE108	693	HTVRC216	694
HSPSBX281530BBFLA(?)	464	HSTSSF502424LBBFM(?)	459	HTLCUBE144	701	HTLR48	702	HTVCUBE120	693	HTVRC240	694
HSPSBX281530BBFM(?)	462	HSTSSF502424LFFL(?)	461	HTLCUBE168	701	HTLR84	702	HTVCUBE144	693	HTVRC84	694
HSPSBX281530FFLA(?)	464	HSTSSF502424LFFM(?)	459	HTLCUBE180	701	HTLR96	702	HTVCUBE168	693	HTVRC96	694
HSPSBX281530FFM(?)	462	HSTSSF502424RBBFL(?)	461	HTLCUBE192	701	HTLRC108	702	HTVCUBE180	693	HTVRCM	694
HSPSSF281518BBFLA(?)	463	HSTSSF502424RBBFM(?)	459	HTLCUBE216	701	HTLRC120	702	HTVCUBE192	693	HTVRCM	694
HSPSSF281518BBFM(?)	463	HSTSSF502424RFFL(?)	461	HTLCUBE240	701	HTLRC144	702	HTVCUBE216	693	HTVT120	692
HSPSSF281518FFLA(?)	465	HSTSSF502424RFFM(?)	459	HTLCUBE48	703	HTLRC168	702	HTVCUBE240	693	HTVT144	692
HSPSSF281518FFM(?)	463	HSTSSF652424LBBFL(?)	461	HTLCUBE84	701	HTLRC180	702	HTVCUBE48	695	HTVT168	692
HSPSSF281524BBFLA(?)	465	HSTSSF652424LBBFM(?)	459	HTLCUBE96	701	HTLRC192	702	HTVCUBE84	693	HTVT72	692
HSPSSF281524BBFM(?)	463	HSTSSF652424LFFL(?)	461	HTLCUBEM	701	HTLRC216	702	HTVCUBE96	693	HTVT96	692
HSPSSF281524FFLA(?)	465	HSTSSF652424LFFM(?)	459	HTLCUBES108	701	HTLRC240	702	HTVCUBEM	693	HTVXP36	695
HSPSSF281524FFM(?)	463	HSTSSF652424RBBFL(?)	461	HTLCUBES120	701	HTLRC48	702	HTVCUBES108	693	HTVXP42	695
HSPSSF281530BBFLA(?)	465	HSTSSF652424RBBFM(?)	459	HTLCUBES144	701	HTLRC84	702	HTVCUBES120	693	HTVXP48	695
						HTLRC96	702	HTVCUBES144	693	HTWTH	372

Cross Reference Index

HON

Model	Page	Model	Page	Model	Page	Model	Page	Model	Page	Model	Page
HXLLEG	695, 703	HVPBKN3H30-WW	33	HVPMCF72-W	37	HVPSMC1H90-WVV	29	HVPWMC2H36-WVV	31	HWR1854(?)	395
HXLLEGSH	695, 703	HVPBKN3H36-WW	33	HVPMCF78-W	37	HVPSMC1H96-WVV	29	HVPWMC2H60-WG	31	HWR1860(?)	395
HUCART	586	HVPBKN4H30-WW	33	HVPMCF84-W	37	HVPSMC2H60-WG	29	HVPWMC2H60-WVV	31	HWR1866(?)	395
HUTM1872	714	HVPBKN4H36-WW	33	HVPMCF90-W	37	HVPSMC2H60-WVV	29	HVPWMC2H66-WVV	31	HWR1872(?)	395
HUTM2040	714	HVPBKN5H30-WW	33	HVPMCF96-W	37	HVPSMC2H66-WVV	29	HVPWMC2H72-WG	31	HWR2424(?)	395
HUTM2060	714	HVPBKN5H36-WW	33	HVPMDISC18-LD	43	HVPSMC2H72-WG	29	HVPWMC2H72-WVV	31	HWR2430(?)	395
HUTM2460	714	HVPBKN6H30-WW	33	HVPMDISC24-LD	43	HVPSMC2H72-WVV	29	HVPWMC2H78-WVV	31	HWR2436(?)	395
HUTM3060	714	HVPBKN6H36-WW	33	HVPMEP24-W	38	HVPSMC2H78-WVV	29	HVPWMC2H84-WVV	31	HWR2442(?)	395
HUTM3072	714	HVPBRG2442-WW	28	HVPMML24-W	38	HVPSMC2H84-WVV	29	HVPWMC2H90-WG	31	HWR2448(?)	395
HUTM3672	714	HVPBRG2448-WW	28	HVPMMPD2415-6WWW	33	HVPSMC2H90-WG	29	HVPWMC2H90-WVV	31	HWR2454(?)	395
HVFB20R	419	HVPBRX2442-WW	28	HVPMMPF-W	41	HVPSMC2H90-WVV	29	HVPWML48120	43	HWR2460(?)	395
HVFB23R	419	HVPBRX2448-WW	28	HVPMMPW2415-2W	40	HVPSPC2466L-2WWW	27	HVPWML48144	43	HWR2466(?)	395
HVFF20R	419	HVPBSMTL33X-LD	43	HVPMMPW2415-3W	40	HVPSPC2466R-2WWW	27	HVPWML4896	43	HWR2472(?)	395
HVFF23R	419	HVPBSMTL38X-LD	43	HVPMMPW2430-4W	40	HVPSPC2472L-2WWW	27	HVPXBH3072-WW	25	HWR3024(?)	396
HVL103	619	HVPCBF2474-WW	44	HVPMMPW2430-5W	40	HVPSPC2472R-2WWW	27	HVPXDH3072-WW	25	HWR3030(?)	396
HVL105	619	HVPCLD5H30-DW	35	HVPMMPW2430-MFLW	41	HVPSTF2H18L-WVV	34	HVPXRH3072L-WW	25	HWR3036(?)	396
HVL108	619	HVPCLD6H30-DW	35	HVPMPLS24-W	41	HVPSTF2H18R-WVV	34	HVPXRH3072R-WW	25	HWR3042(?)	396
HVL131	619	HVPCLF2472L-4WWW	27	HVPMPLS2436-4W	40	HVPSTF2H30-WVV	34	HVSHELF	697	HWR3048(?)	396
HVL151	620	HVPCLF2472R-4WWW	27	HVPMPLS2436-5W	40	HVPSTF2H36-WVV	34	HV-UT1	419	HWR3054(?)	396
HVL161	621	HVPCLF2478L-4WWW	27	HVPMRF42-W	37	HVPSTN1H18-WN	34	HWC3624(?)	399	HWR3060(?)	396
HVL171	621	HVPCLF2478R-4WWW	27	HVPMRF48-W	37	HVPSTN1H30-WN	34	HWC4224(?)	399	HWR3066(?)	396
HVL205	614	HVPCLF2484L-4WWW	27	HVPMRF54-W	37	HVPSTN1H36-WN	34	HWC4230(?)	399	HWR3072(?)	396
HVL210	623	HVPCLF2484R-4WWW	27	HVPMRF60-W	37	HVPSTN2H18-WN	34	HWC4824(?)	399	HWSA2	415
HVL215	623	HVPCLS5H15L-WW	35	HVPMRF66-W	37	HVPSTN2H30-WN	34	HWC4830(?)	399	HWSB2	415
HVL220	623	HVPCLS5H15R-WW	35	HVPMRF72-W	37	HVPSTN2H36-WN	34	HWC72	446	HWSC4224P	401
HVL302	625	HVPCLS6H18L-WW	35	HVPMSJ24-W	38	HVPTDR3072-WW	23	HWCS3624(?)	400	HWSR24	417
HVL303	625	HVPCLS6H18R-WW	35	HVPMSP12-W	38	HVPTDR3672-WW	23	HWCS4224(?)	400	HWSR30	417
HVL402	619	HVPCOLUMN3	39	HVPMSP13-W	38	HVPTKS60	30	HWCS4230(?)	400	HWSR36	417
HVL443	627	HVPDB03672-32WWW	23	HVPMW24102-W	36	HVPTKS66	30	HWCS4824(?)	400	HWSR42	417
HVL508	626	HVPDB03672L-3WWW	24	HVPMW24108-W	36	HVPTKS72	30	HWCS4830(?)	400	HWSR48	417
HVL511	614	HVPDB03672R-3WWW	24	HVPMW2430-W	36	HVPTKS78	30	HWD244830(?)	398	HWW73AAL(?)	403
HVL515	614	HVPDMHA48-W	37	HVPMW2436-W	36	HVPTKS84	30	HWD245430(?)	398	HWW73AAR(?)	403
HVL518	626	HVPDMHA54-W	37	HVPMW2442-W	36	HVPTKS90	30	HWD246030(?)	398	HWW75ABL(?)	403
HVL521	614	HVPDMHA60-W	37	HVPMW2448-W	36	HVPTKS96	30	HWD246630(?)	398	HWW75ABR(?)	403
HVL525	614	HVPDMHA66-W	37	HVPMW2454-W	36	HVPTKW30	32	HWD247230(?)	398	HWW75AAL(?)	403
HVL528	626	HVPDMHA72-W	37	HVPMW2460-W	36	HVPTKW36	32	HWD304824(?)	398	HWW75AAR(?)	403
HVL531	615	HVPDP2472-22WWW	27	HVPMW2466-W	36	HVPTKW42	32	HWD305424(?)	398	HWW75ABL(?)	403
HVL532	615	HVPDRF3066L-3WWW	24	HVPMW2472-W	36	HVPTKW48	32	HWD306024(?)	398	HWW75ABR(?)	403
HVL534	615	HVPDRF3066R-3WWW	24	HVPMW2478-W	36	HVPTKW72	32	HWD306624(?)	398	HWW75BAL(?)	403
HVL538	626	HVPDRF3072L-3WWW	24	HVPMW2484-W	36	HVPTO2424L16	44	HWD307224(?)	398	HWW75BAR(?)	403
HVL541	616	HVPDRF3072R-3WWW	24	HVPMW2490-W	36	HVPTO2424L21	44	HWGN1	515	HWW75BBL(?)	403
HVL551	616	HVPDR03672-32WWW	23	HVPMW2496-W	36	HVPTO2448L16	44	HWGN1B	516	HWW75BBR(?)	403
HVL601	621	HVPDR03672L-3WWW	24	HVPPT15	45	HVPTRD36-W	42	HWGN2	515	HWW93AAL(?)	403
HVL604	621	HVPDR03672R-3WWW	24	HVPRRH3054L-WW	26	HVPTRD42-W	42	HWGN2B	516	HWW93AAR(?)	403
HVL605	628	HVPDWRA2442V-W	36	HVPRRH3054R-WW	26	HVPTRD48-W	42	HWGN3	515	HWW93ABL(?)	403
HVL606	627	HVPDWRA2448V-W	36	HVPRRH3060L-WW	26	HVPTRT48120-W	42	HWGN3B	516	HWW93BAR(?)	403
HVL616	627	HVPDWRA3048-W	36	HVPRRH3060R-WW	26	HVPTRT48144-W	42	HWGN4	515	HWW95AAL(?)	403
HVL641	620	HVPDWRA3048V-W	36	HVPRRL3054L-WW	26	HVPTRT4896-W	42	HWGN4B	516	HWW95AAR(?)	403
HVL643	628	HVPDWRA3054-W	36	HVPRRL3054R-WW	26	HVPTUC5H24R-WW	35	HWGN5	515	HWW95ABL(?)	403
HVL653	628	HVPDWRA3060-W	36	HVPRRL3060L-WW	26	HVPTUC6H24R-WW	35	HWGN5B	516	HWW95ABR(?)	403
HVL685	618	HVPDWRA3066-W	36	HVPRRL3060R-WW	26	HVPTC6H24L-WW	35	HWGN6	517	HWW95BAL(?)	403
HVL691	620	HVPDWRA3072-W	36	HVPRTN2442L-2WWW	28	HVPTC6H24R-WW	35	HWGNT	517	HWW95BAR(?)	403
HVL693	628	HVPFSC2460-44WWW	27	HVPRTN2442R-2WWW	28	HVPWBRK	36	HWJ58ABL(?)	404	HWW95BBL(?)	403
HVL701	617	HVPFSC2460-55WWW	27	HVPRTN2448L-2WWW	28	HVPWCYL18	43	HWJ58ABR(?)	404	HWW95BBR(?)	403
HVL702	617	HVPFSC2472-44WWW	27	HVPRTN2448R-2WWW	28	HVPWCYL18WMM	43	HWJ58BBL(?)	404	HWW30AB(?)	397
HVL705	618	HVPFSC2472-55WWW	27	HVPRTN2454L-2WWW	28	HVPWLBK24	39, 92, 222	HWJ58BBR(?)	404	HWW30BA(?)	397
HVL712	617	HVPLEGMTL-LD	39	HVPRTN2454R-2WWW	28	HVPWLBK30	39, 92, 222	HWJ59ABL(?)	404	HWW36AB(?)	397
HVL721	617	HVPLFS2H30-4WWW	33	HVPRTN2460L-2WWW	28	HVPWMC1H102-WW	31	HWJ59ABR(?)	404	HWW36BA(?)	397
HVL844	622	HVPLFS2H36-4WWW	33	HVPRTN2460R-2WWW	28	HVPWMC1H108-WG	31	HWJ59BBL(?)	404	HWW42AB(?)	397
HVL852	629	HVPLFS3H30-4WWW	33	HVPSBD5H30-WN	34	HVPWMC1H108-WVV	31	HWJ59BBR(?)	404	HWW42BA(?)	397
HVL853	629	HVPLFS3H36-4WWW	33	HVPSBD5H30-WW	34	HVPWMC1H36-WG	31	HWMCLIPLG	113, 211, 742	HWW48AB(?)	397
HVL862	630	HVPLFS4H30-4WWW	33	HVPSBD6H30-WN	34	HVPWMC1H36-WW	31	HWMCLIPSM	113, 211, 742	HWW48BA(?)	397
HVL864	630	HVPLFS4H36-4WWW	33	HVPSBD6H30-WW	34	HVPWMC1H60-WG	31	HWP2460(?)	404	HWW54AB(?)	397
HVL871	632	HVPLFS5H30-4WWW	33	HVPSCF2430-5WWW	33	HVPWMC1H60-WVV	31	HWP2466(?)	404	HWW54BA(?)	397
HVL872	632	HVPLFS5H36-4WWW	33	HVPSCF2436-5WWW	33	HVPWMC1H66-WW	31	HWP2472(?)	404	HWW60AB(?)	397
HVL873	632	HVPMBP15-W	41	HVPSMC1H60-WG	29	HVPWMC1H72-WG	31	HWP3060(?)	404	HWW60BA(?)	397
HVL887	631	HVPMBP30-MFW	41	HVPSMC1H60-WW	29	HVPWMC1H72-WVV	31	HWP3066(?)	404	HWW66AB(?)	397
HVL888	631	HVPMBP30-W	41	HVPSMC1H66-WW	29	HVPWMC1H78-WW	31	HWP3072(?)	404	HWW66BA(?)	397
HVL995	614, 623	HVPMBP36-W	41	HVPSMC1H72-WG	29	HVPWMC1H84-WW	31	HWR1824(?)	395	HWW72AB(?)	397
HVLPERCH	624	HVPMCF102-W	37	HVPSMC1H72-WW	29	HVPWMC1H90-WG	31	HWR1830(?)	395	HWW72BA(?)	397
HVPACCD26	45, 751	HVPMCF108-W	37	HVPSMC1H78-WW	29	HVPWMC1H90-WW	31	HWR1836(?)	395	HXSP-26	657
HVPBKN2H30-WW	33	HVPMCF60-W	37	HVPSMC1H84-WW	29	HVPWMC1H96-WW	31	HWR1842(?)	395	HXSP-36	657
HVPBKN2H36-WW	33	HVPMCF66-W	37	HVPSMC1H90-WG	29	HVPWMC2H36-WG	31	HWR1848(?)	395		

When parts are needed to repair HON products, the following guidelines should be followed to expedite the process.

1. Contact the Parts Department at **Consumer Number: 1-800-336-8398**. They will assist you with your order and answer any questions on parts.
2. There are no discounts applied to parts. Pricing quoted is the net value. Parts pricing is subject to change without notice.
3. The minimum order for a part not covered by warranty is \$7.50 (includes shipping and handling).
4. All keys are \$6.00 each plus a shipping and handling fee of \$3.00 per shipping location.
5. Touch-up paint brush bottles are \$7.00 each, spray cans of paint are \$14.50 each, plus shipping and handling. Note: All aerosol spray paint will be shipped via FedEx ground only.
6. Parts may be paid for with an approved credit card. Approved Cards: MasterCard, VISA and American Express.
7. Payment terms for invoiced parts are Net 30 days.
8. Due to short leadtimes on parts, no changes will be accepted after the order has been placed.
9. When placing a **warranty** parts order:

If the product is under warranty, the product serial number must be provided. Most finished goods products have a serial number placed on them at the factory. The label containing the serial number is located:

Vertical Files — right side of the uppermost drawer

Lateral Files — left side of the uppermost drawer or shelf

Desk Towers — outside of top drawer

Desks, Credenzas, & Returns — on the outside, kneespace side of the top drawer. Fully extend the drawer to find it.

Desks, Credenzas, Corner Units, Bridges, Peninsulas & Returns without drawers — underside of top

Tables and Stands — underside of the top

Table Trucks — underside of side rail

Cabinets & Bookcases — left inner side of the case

Modular Component Top and Backs — underside of top

Modular End Panels — top inside surface

Reception Stations — top inside surface of back panel

Organizers — top inside surface of left end panel near back panel

Vertical Paper Manager — back panel inside surface near top

Pedestals — bottom drawer right side exterior

Seating — underside of the seat

Panels — underside of the top cap

Hutches, Storage Units, Overhead Storage — underside of the shelf

Hanging Bookshelves — underside of shelf

NOTE: Removal of the serial number tag from the product voids the warranty.

An important note regarding Product Serial Numbers:

HON desks, tables, chairs, files and systems components are tagged with a serial number. This number helps us identify *when and where your product was made*, and to identify and correct the root causes for the problem. NEITHER THE DEALER NOR THE CONSUMER SHOULD REMOVE THIS TAG UNDER ANY CIRCUMSTANCES. To do so immediately voids your Warranty coverage for that particular item *and prevents us from further identifying it*. Instead, please transcribe the number and call your Dealer.

HON®

The HON Company
200 Oak Street
Muscatine, IA 52761
800.833.3964
hon.com

© 2016 The HON Company H4889 (11/2016)
HON is a registered trademarks of HNI Technologies,
under license to The HON Company.



Check us out at
hon.com