



The following documentation is an electronically-submitted vendor response to an advertised solicitation from the *West Virginia Purchasing Bulletin* within the Vendor Self-Service portal at [wvOASIS.gov](http://wvOASIS.gov). As part of the State of West Virginia's procurement process, and to maintain the transparency of the bid-opening process, this documentation submitted online is publicly posted by the West Virginia Purchasing Division at [WVPurchasing.gov](http://WVPurchasing.gov) with any other vendor responses to this solicitation submitted to the Purchasing Division in hard copy format.

## Header 1

[List View](#)

## General Information

Contact

Default Values

Discount

Document Information

Procurement Folder: 763901

Procurement Type: Central Purchase Order

Vendor ID: 000000210569

Legal Name: ALPHA TECHNOLOGIES INC

Alias/DBA:

Total Bid: \$172,621.61

Response Date: 08/24/2020

Response Time: 11:51

SO Doc Code: CRFQ

SO Dept: 0603

SO Doc ID: ADJ2100000016

Published Date: 8/17/20

Close Date: 8/24/20

Close Time: 13:30

Status: Closed

Solicitation Description: Addendum No. 2 CCTV Cameras and Install - MCA SOUTH

Total of Header Attachments: 1

Total of All Attachments: 1



Line	Comm Ln Desc	Qty	Unit Issue	Unit Price	Ln Total Or Contract Amount
1	Security Cameras & Installation				\$172,621.61

Comm Code	Manufacturer	Specification	Model #
46171610			

**Extended Description :** Contract Item #1- Lump Sum Price for Camera System and Installation



Purchasing Division  
 2019 Washington Street East  
 Post Office Box 50130  
 Charleston, WV 25305-0130

State of West Virginia  
 Request for Quotation  
 09 - Construction

Proc Folder: 763901

Doc Description: CCTV Cameras and Install - Challenge Academy South

Proc Type: Central Purchase Order

Date Issued	Solicitation Closes	Solicitation No	Version
2020-08-05	2020-08-24 13:30:00	CRFQ 0603 ADJ2100000016	1

**BID RECEIVING LOCATION**

BID CLERK  
 DEPARTMENT OF ADMINISTRATION  
 PURCHASING DIVISION  
 2019 WASHINGTON ST E  
 CHARLESTON WV 25305  
 US

**VENDOR**

Vendor Name, Address and Telephone Number:

Alpha Technologies  
 4003 Outlook Dr  
 Hurricane, WV 25526  
 304-721-8987

**FOR INFORMATION CONTACT THE BUYER**

Tara Lyle  
 (304) 558-2544  
 tara.l.yle@wv.gov

Signature X

FEIN #

550774279

DATE

08-24-20

All offers subject to all terms and conditions contained in this solicitation

**ADDITIONAL INFORMATION:**

The West Virginia Purchasing Division is soliciting bids on behalf of the West Virginia Adjutant General's Office Mountaineer Challenge Academy SOUTH located at 305 Fayette Pike, Montgomery, WV 25136, to establish a contract to provide all labor, materials, tools and equipment to complete the install of newclosed circuit television security camera system, per the attached documentation.  
 \*\*\*\*\*

Mandatory pre-bid meeting will be held on 08/13/2020 at 10:30 am at the WV Mountaineer Challenge Academy SOUTH located at 350 Fayette Pike Montgomery, WV 25136.

See information attached relating to the mandatory pre-bid meeting. Per Governor Justice's Executive Order, no one will be allowed entry into the building without a mask.  
 \*\*\*\*\*

INVOICE TO		SHIP TO	
STATE FINANCE ADJUTANT GENERALS OFFICE 1703 COONSKIN DR		MOUNTAINEER CHALLENGE PROGRAM - SOUTH ADJUTANT GENERALS OFFICE 305 FAYETTE PIKE	
CHARLESTON	WV25311-1085	MONTGOMERY	WV 25136
US		US	

Line	Comm Ln Desc	Qty	Unit Issue	Unit Price	Total Price
1	Security Cameras & Installation				\$172,621.61

Comm Code	Manufacturer	Specification	Model #
46171610			

**Extended Description :**  
 Contract Item #1- Lump Sum Price for Camera System and Installation

**SCHEDULE OF EVENTS**

Line	Event	Event Date
1	Mandatory pre-bid meeting at 10:30 am	2020-08-13
2	Technical questions due by 12:00 pm	2020-08-17

ADJ2100000016	<b>Document Phase</b> Final	<b>Document Description</b> CCTV Cameras and Install - Challenge Academy South	<b>Page 3 of 3</b>
---------------	--------------------------------	--	------------------------

**ADDITIONAL TERMS AND CONDITIONS**

See attached document(s) for additional Terms and Conditions

alpha  
TECHNOLOGIES



State Finance Adjutant Generals Office

**We have prepared a quote for you**

**Mountaineer Challenge Academy - South  
Campus**

Quote #1002960

Version 1

 304-201-7485

 [www.alpha-tech.us](http://www.alpha-tech.us)



**Hardware**

Description	Price	Qty	Ext. Price
WV-U2142L <b>4MP Indoor Dome Network Camera, H.265.V/F Lens with IRLED,SSG</b>	\$297.31	179	\$53,218.49
WV-Q174B <b>Embedded Ceiling mount bracket for SFN/SFR/SF33X Series,Color: Silver</b>	\$49.34	88	\$4,341.92
WV-QWL500-W <b>Intergrated Wall Mount Bracket, Gray for Indoor/Outdoor Domes (S21xx, S22xx, U21xx, U25xx), Compact Domes (S31xx,S35xx), 360 Cameras. Use PACA4W Corner Mount Adaptor or PAPM4W Pole Mount Adaptor</b>	\$90.02	91	\$8,191.82
WV-X8570N <b>4X4K MULTI-SENSOR DOME CAMERA H.265</b>	\$1,965.80	9	\$17,692.20
PACA4GR <b>Corner Mount Adaptor f/PWM20, PWM40, WV-Q122A-PantoneCool Gray Color</b>	\$78.53	8	\$628.24
VZ-43CMP <b>43" FHD 1920x1080 LED Monitor, BNC(1n/1out) /VGA/HDMI,Black plastic frame, 12VDC, Built for 24/7 operation</b>	\$523.78	2	\$1,047.56
FO-SC10010 <b>C -100 24 Port Gigabit PoE+ Switch with 2 SFP Ports</b>	\$462.91	10	\$4,629.10
FO-065-79SXMG <b>1 000SX SFP Module 850nm LC/MM, 220/550 m</b>	\$86.96	12	\$1,043.52
NVR-R-2-196TB-V2 <b>I-PRO SR3E-C,2U, DUAL XEON OCTA CORE CPU, 32GB RAM,WINDOWS SERVER STANDARD. OS ON 2X1TB HDD, TOTAL STORAGE 196TB (RAID 5), USABLE 182TB, KEYBOARD MOUSE. NO RAILS, NO OPTICAL DRIVE. TOTAL USABLE STORAGE ISCALCULATED BASED ON ADVERTISED HDD SIZE, NOT OS R</b>	\$19,614.54	1	\$19,614.54
EPQ5P550R <b>5P 550 RACK1U</b>	\$235.10	6	\$1,410.60
DATFR-12-18 <b>12SP SWING FRAME WALL RACK</b>	\$197.92	2	\$395.84
MLK10-4323 <b>1RU - 2 PANEL FIBER TERM BOX</b>	\$90.38	4	\$361.52
MLK10-4327 <b>2RU - 4 PANEL FIBER TERM BOX</b>	\$115.72	1	\$115.72
MLK065-245-10 <b>12-PK MM 10G LC FIBER ADAPTER PANEL</b>	\$21.41	5	\$107.05
MLK10-7666 <b>BLANK FIBER ADAPTER PANEL</b>	\$4.44	7	\$31.08
WCEBELFD3D 006P9A <b>6F OM3 I/O OFNP AQUA</b>	\$0.64	500	\$320.00
BELFT3LC900 PR063MD <b>6F OM3 LC-PIGTAIL</b>	\$42.35	10	\$423.50

### Hardware

Description	Price	Qty	Ext. Price
<b>Subtotal:</b>			<b>\$113,572.70</b>

### Services

Description	Price	Qty	Ext. Price
<b>CABLEANDLA BOR</b>  <b>Complete Installation of (188) new cameras and system for both Tech Center and Maclin Hall.</b>	\$59,048.91	1	\$59,048.91
<b>Subtotal:</b>			<b>\$59,048.91</b>



## Mountaineer Challenge Academy - South Campus

**Prepared by:**

**Alpha Technologies**  
James Stewart  
304-201-7485  
jstewart@alpha-tech.us

**Prepared for:**

**State Finance Adjutant Generals Office**  
1703 Coonskin Drive  
Charleston, WV 25311  
Tara Lyles  
(304) 558-2544  
Tara.I.Lyles@wv.gov

**Quote Information:**

**Quote #: 1002960**  
Version: 1  
Delivery Date: 08/24/2020  
Expiration Date: 09/21/2020

### Quote Summary

Description	Amount
Hardware	\$113,572.70
Services	\$59,048.91
<b>Total:</b>	<b>\$172,621.61</b>

### Alpha Technologies

Signature:   
Name: James Stewart  
Title: Client Executive  
Date: 08/24/2020

### State Finance Adjutant Generals Office

Signature: \_\_\_\_\_  
Name: Tara Lyles  
Date: \_\_\_\_\_

Bond No: 11523-WV-BB

Adjutant Generals Office  
Agency Mountaineer Challenge Academy  
REQ.P.O# CRFQ 0623 ADJ210000016

**BID BOND**

KNOW ALL MEN BY THESE PRESENTS, That we, the undersigned, Alpha Technologies Inc.  
of 4003 Outlook Drive, Hurricane, West Virginia, as Principal, and First Surety Corporation  
of Charleston, West Virginia, a corporation organized and existing under the laws of the State of West Virginia with its principal office in the City of Charleston, WV, as Surety, are held and firmly bound unto the State of West Virginia, as Oblige, in the penal sum of 5% (\$ 5% ) for the payment of which, well and truly to be made, we jointly and severally bind ourselves, our heirs, administrators, executors, successors and assigns.

The Condition of the above obligation is such that whereas the Principal has submitted to the Purchasing Section of the Department of Administration a certain bid or proposal, attached hereto and made a part hereof, to enter into a contract in writing for Mountaineer Challenge Academy CCTV Cameras & Installation

**NOW THEREFORE,**

- (a) If said bid shall be rejected, or
- (b) If said bid shall be accepted and the Principal shall enter into a contract in accordance with the bid or proposal attached hereto and shall furnish any other bonds and insurance required by the bid or proposal, and shall in all other respects perform the agreement created by the acceptance of said bid, then this obligation shall be null and void, otherwise this obligation shall remain in full force and effect. It is expressly understood and agreed that the liability of the Surety for any and all claims hereunder shall, in no event, exceed the penal amount of this obligation as herein stated.

The Surety, for the value received, hereby stipulates and agrees that the obligations of said Surety and its bond shall be in no way impaired or affected by any extension of the time within which the Oblige may accept such bid, and said Surety does hereby waive notice of any such extension.

WITNESS, the following signatures and seals of Principal and Surety, executed and sealed by a proper officer of Principal and Surety, or by Principal individually if Principal is an individual, this 24th day of August, 2020.

Principal Seal

Alpha Technologies, Inc.

(Name of Principal)

By

Douglas Tate (Must be President, Vice President, or Duly Authorized Agent)

President  
(Title)

Surety Seal

First Surety Corporation

(Name of Surety)

Mark Thomas Attorney-in-Fact

**IMPORTANT - Surety executing bonds must be licensed in West Virginia to transact surety insurance, must affix its seal, and must attach a power of attorney with its seal affixed.**





# CERTIFICATE OF LIABILITY INSURANCE

DATE (MM/DD/YYYY)  
08/14/2020

THIS CERTIFICATE IS ISSUED AS A MATTER OF INFORMATION ONLY AND CONFERS NO RIGHTS UPON THE CERTIFICATE HOLDER. THIS CERTIFICATE DOES NOT AFFIRMATIVELY OR NEGATIVELY AMEND, EXTEND OR ALTER THE COVERAGE AFFORDED BY THE POLICIES BELOW. THIS CERTIFICATE OF INSURANCE DOES NOT CONSTITUTE A CONTRACT BETWEEN THE ISSUING INSURER(S), AUTHORIZED REPRESENTATIVE OR PRODUCER, AND THE CERTIFICATE HOLDER.

**IMPORTANT:** If the certificate holder is an **ADDITIONAL INSURED**, the policy(ies) must have **ADDITIONAL INSURED** provisions or be endorsed. If **SUBROGATION IS WAIVED**, subject to the terms and conditions of the policy, certain policies may require an endorsement. A statement on this certificate does not confer rights to the certificate holder in lieu of such endorsement(s).

<b>PRODUCER</b> Payne and Garlow Insurance Inc. 3744 Teays Valley Road Suite 101 Hurricane WV 25526		<b>CONTACT NAME:</b> Margaret Gunnoe <b>PHONE (A/C No, Ext):</b> (304) 757-6880 <b>E-MAIL ADDRESS:</b> Margaret@garlowinsurance.com <b>FAX (A/C, No):</b> (304) 757-6894	
<b>INSURED</b> Alpha Technologies, Inc. P O Box 1114 Scott Depot WV 25560		<b>INSURER(S) AFFORDING COVERAGE</b> <b>INSURER A:</b> Travelers Companies, Inc <b>INSURER B:</b> <b>INSURER C:</b> <b>INSURER D:</b> <b>INSURER E:</b> <b>INSURER F:</b>	
		<b>NAIC #</b> 36161	

**COVERAGES**      **CERTIFICATE NUMBER:** CL2042204980

**REVISION NUMBER:**

THIS IS TO CERTIFY THAT THE POLICIES OF INSURANCE LISTED BELOW HAVE BEEN ISSUED TO THE INSURED NAMED ABOVE FOR THE POLICY PERIOD INDICATED. NOTWITHSTANDING ANY REQUIREMENT, TERM OR CONDITION OF ANY CONTRACT OR OTHER DOCUMENT WITH RESPECT TO WHICH THIS CERTIFICATE MAY BE ISSUED OR MAY PERTAIN, THE INSURANCE AFFORDED BY THE POLICIES DESCRIBED HEREIN IS SUBJECT TO ALL THE TERMS, EXCLUSIONS AND CONDITIONS OF SUCH POLICIES. LIMITS SHOWN MAY HAVE BEEN REDUCED BY PAID CLAIMS.

INSR LTR	TYPE OF INSURANCE	ADDL SUBR		POLICY NUMBER	POLICY EFF (MM/DD/YYYY)	POLICY EXP (MM/DD/YYYY)	LIMITS	
		INSD	WVD					
A	<input checked="" type="checkbox"/> <b>COMMERCIAL GENERAL LIABILITY</b> <input type="checkbox"/> CLAIMS-MADE <input checked="" type="checkbox"/> OCCUR GEN'L AGGREGATE LIMIT APPLIES PER: <input type="checkbox"/> POLICY <input type="checkbox"/> PRO-JECT <input type="checkbox"/> LOC OTHER:			I-680-7F378967-20-42	04/15/2020	04/15/2021	EACH OCCURRENCE \$ 1,000,000 DAMAGE TO RENTED PREMISES (Ea occurrence) \$ 300,000 MED EXP (Any one person) \$ 5,000 PERSONAL & ADV INJURY \$ 1,000,000 GENERAL AGGREGATE \$ 2,000,000 PRODUCTS - COMP/OP AGG \$ 2,000,000 Terrorism Coverage \$ included	
A	<b>AUTOMOBILE LIABILITY</b> <input checked="" type="checkbox"/> ANY AUTO <input type="checkbox"/> OWNED AUTOS ONLY <input type="checkbox"/> SCHEDULED AUTOS <input type="checkbox"/> HIRED AUTOS ONLY <input type="checkbox"/> NON-OWNED AUTOS ONLY			BA 6F331749	04/15/2020	04/15/2021	COMBINED SINGLE LIMIT (Ea accident) \$ 1,000,000 BODILY INJURY (Per person) \$ BODILY INJURY (Per accident) \$ PROPERTY DAMAGE (Per accident) \$ UM/UIM CSL \$ 1,000,000	
A	<input checked="" type="checkbox"/> <b>UMBRELLA LIAB</b> <input type="checkbox"/> EXCESS LIAB <input type="checkbox"/> OCCUR <input type="checkbox"/> DED <input checked="" type="checkbox"/> RETENTION \$ 5,000 <input type="checkbox"/> CLAIMS-MADE			CUP-6F332710-20-42	04/15/2020	04/15/2021	EACH OCCURRENCE \$ 8,000,000 AGGREGATE \$ 8,000,000	
A	<b>WORKERS COMPENSATION AND EMPLOYERS' LIABILITY</b> ANY PROPRIETOR/PARTNER/EXECUTIVE OFFICER/MEMBER EXCLUDED? (Mandatory in NH) If yes, describe under DESCRIPTION OF OPERATIONS below	Y/N	N/A	UB-2J051298	06/15/2020	06/15/2021	<input checked="" type="checkbox"/> PER STATUTE <input type="checkbox"/> OTH-ER E.L. EACH ACCIDENT \$ 1,000,000 E.L. DISEASE - EA EMPLOYEE \$ 1,000,000 E.L. DISEASE - POLICY LIMIT \$ 1,000,000	

DESCRIPTION OF OPERATIONS / LOCATIONS / VEHICLES (ACORD 101, Additional Remarks Schedule, may be attached if more space is required)

**CERTIFICATE HOLDER**
**CANCELLATION**

 West Virginia Army National Guard  
 1707 Coonskin Drive

Charleston

WV 25311

SHOULD ANY OF THE ABOVE DESCRIBED POLICIES BE CANCELLED BEFORE THE EXPIRATION DATE THEREOF, NOTICE WILL BE DELIVERED IN ACCORDANCE WITH THE POLICY PROVISIONS.

AUTHORIZED REPRESENTATIVE

## ADDITIONAL COVERAGES

Ref #	Description Employee Benefits	Coverage Code EBLIA	Form No.	Edition Date
Limit 1 1,000,000	Limit 2	Limit 3	Deductible Amount	Deductible Type
Premium				
Ref #	Description Cyberfirst Essentials	Coverage Code	Form No.	Edition Date
Limit 1 3,000,000	Limit 2 3,000,000	Limit 3	Deductible Amount 2,500	Deductible Type Per Claim
Premium				
Ref #	Description Medical payments	Coverage Code MEDPM	Form No.	Edition Date
Limit 1 5,000	Limit 2	Limit 3	Deductible Amount	Deductible Type
Premium				
Ref #	Description Uninsured motorist combined single limit	Coverage Code UMCSL	Form No.	Edition Date
Limit 1 1,000,000	Limit 2	Limit 3	Deductible Amount	Deductible Type
Premium				
Ref #	Description Waiver of Subrogation	Coverage Code WWSUB	Form No.	Edition Date
Limit 1 Blanket	Limit 2	Limit 3	Deductible Amount	Deductible Type
Premium				
Ref #	Description	Coverage Code	Form No.	Edition Date
Limit 1	Limit 2	Limit 3	Deductible Amount	Deductible Type
Premium				
Ref #	Description	Coverage Code	Form No.	Edition Date
Limit 1	Limit 2	Limit 3	Deductible Amount	Deductible Type
Premium				
Ref #	Description	Coverage Code	Form No.	Edition Date
Limit 1	Limit 2	Limit 3	Deductible Amount	Deductible Type
Premium				
Ref #	Description	Coverage Code	Form No.	Edition Date
Limit 1	Limit 2	Limit 3	Deductible Amount	Deductible Type
Premium				
Ref #	Description	Coverage Code	Form No.	Edition Date
Limit 1	Limit 2	Limit 3	Deductible Amount	Deductible Type
Premium				

OFADTLCV

STATE OF WEST VIRGINIA  
Purchasing Division

# PURCHASING AFFIDAVIT

**CONSTRUCTION CONTRACTS:** Under W. Va. Code § 5-22-1(i), the contracting public entity shall not award a construction contract to any bidder that is known to be in default on any monetary obligation owed to the state or a political subdivision of the state, including, but not limited to, obligations related to payroll taxes, property taxes, sales and use taxes, fire service fees, or other fines or fees.

**ALL CONTRACTS:** Under W. Va. Code §5A-3-10a, no contract or renewal of any contract may be awarded by the state or any of its political subdivisions to any vendor or prospective vendor when the vendor or prospective vendor or a related party to the vendor or prospective vendor is a debtor and: (1) the debt owed is an amount greater than one thousand dollars in the aggregate; or (2) the debtor is in employer default.

**EXCEPTION:** The prohibition listed above does not apply where a vendor has contested any tax administered pursuant to chapter eleven of the W. Va. Code, workers' compensation premium, permit fee or environmental fee or assessment and the matter has not become final or where the vendor has entered into a payment plan or agreement and the vendor is not in default of any of the provisions of such plan or agreement.

**DEFINITIONS:**

**"Debt"** means any assessment, premium, penalty, fine, tax or other amount of money owed to the state or any of its political subdivisions because of a judgment, fine, permit violation, license assessment, defaulted workers' compensation premium, penalty or other assessment presently delinquent or due and required to be paid to the state or any of its political subdivisions, including any interest or additional penalties accrued thereon.

**"Employer default"** means having an outstanding balance or liability to the old fund or to the uninsured employers' fund or being in policy default, as defined in W. Va. Code § 23-2c-2, failure to maintain mandatory workers' compensation coverage, or failure to fully meet its obligations as a workers' compensation self-insured employer. An employer is not in employer default if it has entered into a repayment agreement with the Insurance Commissioner and remains in compliance with the obligations under the repayment agreement.

**"Related party"** means a party, whether an individual, corporation, partnership, association, limited liability company or any other form or business association or other entity whatsoever, related to any vendor by blood, marriage, ownership or contract through which the party has a relationship of ownership or other interest with the vendor so that the party will actually or by effect receive or control a portion of the benefit, profit or other consideration from performance of a vendor contract with the party receiving an amount that meets or exceeds five percent of the total contract amount.

**AFFIRMATION:** By signing this form, the vendor's authorized signer affirms and acknowledges under penalty of law for false swearing (W. Va. Code §61-5-3) that: (1) for construction contracts, the vendor is not in default on any monetary obligation owed to the state or a political subdivision of the state, and (2) for all other contracts, that neither vendor nor any related party owe a debt as defined above and that neither vendor nor any related party are in employer default as defined above, unless the debt or employer default is permitted under the exception above.

**WITNESS THE FOLLOWING SIGNATURE:**

Vendor's Name: Alpha Technologies

Authorized Signature: [Signature] Date: 08-24-20

State of West Virginia

County of Lincoln, to-wit:

Taken, subscribed, and sworn to before me this 20th day of August, 2020

My Commission expires Aug 29, 2021.

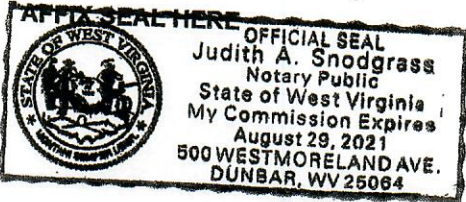

NOTARY PUBLIC [Signature]  
Purchasing Affidavit (Revised 01/19/2018)



# State of West Virginia

## VENDOR PREFERENCE CERTIFICATE

Certification and application is hereby made for Preference in accordance with **West Virginia Code, §5A-3-37**. (Does not apply to construction contracts). **West Virginia Code, §5A-3-37**, provides an opportunity for qualifying vendors to request (at the time of bid) preference for their residency status. Such preference is an evaluation method only and will be applied only to the cost bid in accordance with the **West Virginia Code**. This certificate for application is to be used to request such preference. The Purchasing Division will make the determination of the Vendor Preference, if applicable.

1. **Application is made for 2.5% vendor preference for the reason checked:**  
Bidder is an individual resident vendor and has resided continuously in West Virginia, or bidder is a partnership, association or corporation resident vendor and has maintained its headquarters or principal place of business continuously in West Virginia, for four (4) years immediately preceding the date of this certification; **or**,  
 Bidder is a resident vendor partnership, association, or corporation with at least eighty percent of ownership interest of bidder held by another entity that meets the applicable four year residency requirement; **or**,  
 Bidder is a nonresident vendor which has an affiliate or subsidiary which employs a minimum of one hundred state residents and which has maintained its headquarters or principal place of business within West Virginia continuously for the four (4) years immediately preceding the date of this certification; **or**,
2. **Application is made for 2.5% vendor preference for the reason checked:**  
Bidder is a resident vendor who certifies that, during the life of the contract, on average at least 75% of the employees working on the project being bid are residents of West Virginia who have resided in the state continuously for the two years immediately preceding submission of this bid; **or**,
3. **Application is made for 2.5% vendor preference for the reason checked:**  
Bidder is a nonresident vendor that employs a minimum of one hundred state residents, or a nonresident vendor which has an affiliate or subsidiary which maintains its headquarters or principal place of business within West Virginia and employs a minimum of one hundred state residents, and for purposes of producing or distributing the commodities or completing the project which is the subject of the bidder's bid and continuously over the entire term of the project, on average at least seventy-five percent of the bidder's employees or the bidder's affiliate's or subsidiary's employees are residents of West Virginia who have resided in the state continuously for the two immediately preceding years and the vendor's bid; **or**,
4. **Application is made for 5% vendor preference for the reason checked:**  
Bidder meets either the requirement of both subdivisions (1) and (2) or subdivision (1) and (3) as stated above; **or**,
5. **Application is made for 3.5% vendor preference who is a veteran for the reason checked:**  
Bidder is an individual resident vendor who is a veteran of the United States armed forces, the reserves or the National Guard and has resided in West Virginia continuously for the four years immediately preceding the date on which the bid is submitted; **or**,
6. **Application is made for 3.5% vendor preference who is a veteran for the reason checked:**  
Bidder is a resident vendor who is a veteran of the United States armed forces, the reserves or the National Guard, if, for purposes of producing or distributing the commodities or completing the project which is the subject of the vendor's bid and continuously over the entire term of the project, on average at least seventy-five percent of the vendor's employees are residents of West Virginia who have resided in the state continuously for the two immediately preceding years.
7. **Application is made for preference as a non-resident small, women- and minority-owned business, in accordance with West Virginia Code §5A-3-59 and West Virginia Code of State Rules.**  
Bidder has been or expects to be approved prior to contract award by the Purchasing Division as a certified small, women- and minority-owned business.
8. **Application is made for reciprocal preference.**  
Bidder is a West Virginia resident and is requesting reciprocal preference to the extent that it applies.

Bidder understands if the Secretary of Revenue determines that a Bidder receiving preference has failed to continue to meet the requirements for such preference, the Secretary may order the Director of Purchasing to: (a) rescind the contract or purchase order; or (b) assess a penalty against such Bidder in an amount not to exceed 5% of the bid amount and that such penalty will be paid to the contracting agency or deducted from any unpaid balance on the contract or purchase order.

By submission of this certificate, Bidder agrees to disclose any reasonably requested information to the Purchasing Division and authorizes the Department of Revenue to disclose to the Director of Purchasing appropriate information verifying that Bidder has paid the required business taxes, provided that such information does not contain the amounts of taxes paid nor any other information deemed by the Tax Commissioner to be confidential.

Bidder hereby certifies that this certificate is true and accurate in all respects; and that if a contract is issued to Bidder and if anything contained within this certificate changes during the term of the contract, Bidder will notify the Purchasing Division in writing immediately.

Bidder: Alpha Technologies

Signed: [Signature]

Date: 08-24-20

Title: Account Executive

\*Check any combination of preference consideration(s) indicated above, which you are entitled to receive.

**DESIGNATED CONTACT:** Vendor appoints the individual identified in this Section as the Contract Administrator and the initial point of contact for matters relating to this Contract.

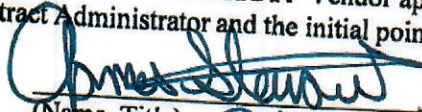
 Account Executive  
(Name, Title)  
James Stewart, Account Executive  
(Printed Name and Title)  
4003 Outlook Dr. Hurricane, WV 25526  
(Address)  
304-721-8987 304-201-2610  
(Phone Number) / (Fax Number)  
stewart@alpha-tech.us  
(email address)

**CERTIFICATION AND SIGNATURE:** By signing below, or submitting documentation through WV OASIS, I certify that I have reviewed this Solicitation in its entirety; that I understand the requirements, terms and conditions, and other information contained herein; that this bid, offer or proposal constitutes an offer to the State that cannot be unilaterally withdrawn; that the product or service proposed meets the mandatory requirements contained in the Solicitation for that product or service, unless otherwise stated herein; that the Vendor accepts the terms and conditions contained in the Solicitation, unless otherwise stated herein; that I am submitting this bid, offer or proposal for review and consideration; that I am authorized by the vendor to execute and submit this bid, offer, or proposal, or any documents related thereto on vendor's behalf; that I am authorized to bind the vendor in a contractual relationship; and that to the best of my knowledge, the vendor has properly registered with any State agency that may require registration.

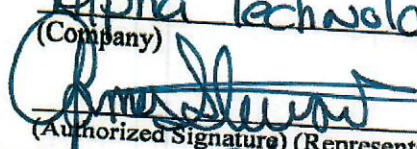
Alpha Technologies  
(Company)  
 Account Executive  
(Authorized Signature) (Representative Name, Title)  
James Stewart, Account Executive  
(Printed Name and Title of Authorized Representative)  
08-24-20  
(Date)  
304-721-8987 304-201-2610  
(Phone Number) (Fax Number)

**ADDITIONAL TERMS AND CONDITIONS (Construction Contracts Only)**

**1. CONTRACTOR'S LICENSE:** West Virginia Code § 21-11-2 requires that all persons desiring to perform contracting work in this state be licensed. The West Virginia Contractors Licensing Board is empowered to issue the contractor's license. Applications for a contractor's license may be made by contacting the West Virginia Division of Labor. West Virginia Code § 21-11-11 requires any prospective Vendor to include the contractor's license number on its bid. If an apparent low bidder fails to submit a license number in accordance with this section, the Purchasing Division will promptly request by telephone and electronic mail that the low bidder and the second low bidder provide the license number within one business day of the request. Failure of the bidder to provide the license number within one business day of receiving the request shall result in disqualification of the bid. Vendors should include a contractor's license number in the space provided below.

Contractor's Name: Alpha Technologies  
Contractor's License No.: WV- 040843

The apparent successful Vendor must furnish a copy of its contractor's license prior to the issuance of a contract award document.

**2. DRUG-FREE WORKPLACE AFFIDAVIT:** W. Va. Code § 21-1D-5 provides that any solicitation for a public improvement contract requires each Vendor that submits a bid for the work to submit an affidavit that the Vendor has a written plan for a drug-free workplace policy. If the affidavit is not submitted with the bid submission, the Purchasing Division shall promptly request by telephone and electronic mail that the low bidder and second low bidder provide the affidavit within one business day of the request. Failure to submit the affidavit within one business day of receiving the request shall result in disqualification of the bid. To comply with this law, Vendor should complete the enclosed drug-free workplace affidavit and submit the same with its bid. Failure to submit the signed and notarized drugfree workplace affidavit or a similar affidavit that fully complies with the requirements of the applicable code, within one business day of being requested to do so shall result in disqualification of Vendor's bid. Pursuant to W. Va. Code 21-1D-2(b) and (k), this provision does not apply to public improvement contracts the value of which is \$100,000 or less or temporary or emergency repairs.

**2.1. DRUG-FREE WORKPLACE POLICY:** Pursuant to W. Va. Code § 21-1D-4, Vendor and its subcontractors must implement and maintain a written drug-free workplace policy that complies with said article. The awarding public authority shall cancel this contract if: (1) Vendor fails to implement and maintain a written drug-free workplace policy described in the preceding paragraph, (2) Vendor fails to provide information regarding implementation of its drug-free workplace policy at the request of the public authority; or (3) Vendor provides to the public authority false information regarding the contractor's drug-free workplace policy.

Pursuant to W. Va. Code 21-1D-2(b) and (k), this provision does not apply to public improvement contracts the value of which is \$100,000 or less or temporary or emergency repairs.

# CONTRACTOR LICENSE

Authorized by the  
**West Virginia Contractor Licensing Board**

**Number:** WV040843

**Classification:**  
COMMUNICATION & SOUND

ALPHA TECHNOLOGIES INC  
DBA ALPHA FEDERAL  
PO BOX 1114  
SCOTT DEPOT, WV 25560

**Date Issued**

JUNE 11, 2020

**Expiration Date**

JUNE 11, 2021

  
Authorized Company Signature

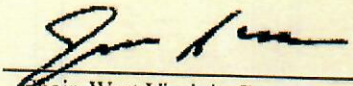
  
Chair, West Virginia Contractor  
Licensing Board



**WEST VIRGINIA  
CONTRACTOR  
LICENSING  
BOARD**

This license, or a copy thereof, must be posted in a conspicuous place at every construction site where work is being performed. This license number must appear in all advertisements, on all bid submissions and on all fully executed and binding contracts. This license cannot be assigned or transferred by licensee. Issued under provisions of West Virginia Code, Chapter 21, Article 11.

# CONTRACTOR LICENSE

Authorized by the

**West Virginia Contractor Licensing Board**

**Number:**

WV056147

**Classification:**

LOW VOLTAGE SYSTEMS  
COMMUNICATION & SOUND

C & E TECH SERVICES LLC  
DBA C & E TECH SERVICES LLC  
356 TOWNSHIP ROAD 1110  
PROCTORVILLE, OH 45669

**Date Issued**

**Expiration Date**

APRIL 17, 2020

APRIL 17, 2021

**WEST VIRGINIA  
CONTRACTOR  
LICENSING  
BOARD**

  
Authorized Company Signature

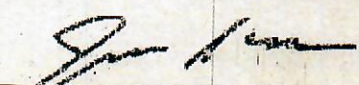
  
Chair, West Virginia Contractor  
Licensing Board

This license, or a copy thereof, must be posted in a conspicuous place at every construction site where work is being performed. This license number must appear in all advertisements, on all bid submissions and on all fully executed and binding contracts. This license cannot be assigned or transferred by licensee. Issued under provisions of West Virginia Code, Chapter 21, Article 11.



WV-72  
Approved / Revised 08/01/15

State of West Virginia  
Purchasing Division

**CERTIFIED DRUG-FREE WORKPLACE REPORT COVERSHEET**

In accordance with *West Virginia Code* § 21-1D-7b, no less than once per year, or upon completion of the project, every contractor shall provide a certified report to the public authority which let the contract. That report must include each of the items identified below in the Required Report Content section.

**Instructions:** Vendor should complete this coversheet, attach it to the required report, and submit it to the appropriate location as follows: For contracts more than \$25,000, the report should be mailed to the West Virginia Purchasing Division at 2019 Washington Street East, Charleston, WV 25305. For contracts of \$25,000 or less, the vendor should mail the report to the public authority issuing the contract.

**Contract Identification:**

Contract Number: ADJ 2100000016  
Contract Purpose: Mountaineer Challenger Division  
Agency Requesting Work: Mountaineer Challenger Division

**Required Report Content:** The attached report must include each of the items listed below. The vendor should check each box as an indication that the required information has been included in the attached report.

- Information indicating the education and training service to the requirements of *West Virginia Code* § 21-1D-5 was provided;
- Name of the laboratory certified by the United States Department of Health and Human Services or its successor that performs the drug tests;
- Average number of employees in connection with the construction on the public improvement;
- Drug test results for the following categories including the number of positive tests and the number of negative tests: (A) Pre-employment and new hires; (B) Reasonable suspicion; (C) Post-accident; and (D) Random.

**Vendor Contact Information:**

Vendor Name: <u>Alpha Technologies</u>	Vendor Telephone: <u>304-721-8987</u>
Vendor Address: <u>4003 Outlook Dr.</u>	Vendor Fax: <u>304-201-2610</u>
<u>Hurricane, WV 25526</u>	Vendor E-Mail: <u>jstewart@alpha-tech.us</u>



**State of West Virginia  
DRUG FREE WORKPLACE CONFORMANCE AFFIDAVIT  
West Virginia Code §21-1D-5**

I, Richard O'Brien, after being first duly sworn, depose and state as follows:

- 1. I am an employee of Alpha Technologies; and,  
(Company Name)
- 2. I do hereby attest that Alpha Technologies  
(Company Name)

maintains a written plan for a drug-free workplace policy and that such plan and policy are in compliance with **West Virginia Code §21-1D**.

The above statements are sworn to under the penalty of perjury.

Printed Name: Richard O'Brien  
 Signature: [Handwritten Signature]  
 Title: CMO  
 Company Name: Alpha Technologies  
 Date: 8/19/20

STATE OF WEST VIRGINIA,

COUNTY OF Putnam, TO-WIT:

Taken, subscribed and sworn to before me this 19<sup>th</sup> day of August, 2020.

By Commission expires October 25, 2023

(Seal)

Amy L. Holley  
(Notary Public)

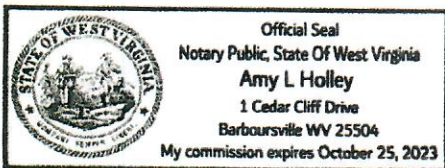



## 4-megapixel iA(Intelligent Auto) H.265 Varifocal Camera

Panasonic WV-U2142L captures the highest quality 4MP resolution images in even very challenging and dynamic environments. Intelligent Auto (iA) monitors scene dynamics and motion to adjust key camera settings automatically in real-time reducing distortion such as motion blur on moving objects. By adopting H.265 Smart Coding technology, bandwidth efficiency is intelligently increased for longer recording and less storage.

### Extreme image quality allows evidence to be captured even under challenging conditions

- Auto Shutter speed control for fast moving objects
- Sharp and clear images of a walking person day & night
- Outstanding low light performance in true color with low noise for night time applications
- Super Dynamic 102dB for backlit situations involving headlights and shadows on night streets

### Extreme bandwidth compression with Panasonic H.265 Smart Coding

- Longer recording and less storage compared to any H.264 based compression techniques
- Self-learning ROI\* encoding (Auto VIQS) detects movement within the image and compresses the areas with little motion in order to reduce transmitted data while maintaining the quality of the image.

\*Region of Interest

### Key Features

- 4-megapixel images up to 30fps
- 2.5x built-in motorized zoom and motorized focus lens
- iA (intelligent Auto)
- Super Dynamic 102dB
- Color night vision (0.019 to 0.3 lx)
- H.265 Smart Coding
- Corridor mode  
(90 degrees or 270 degrees in image rotation)

### Industry examples

- Retail
- Education
- Public safety
- Bank / Hospital / Building



# Specifications

<b>Camera</b>	<b>Image Sensor</b>	Approx. 1/2.7 type CMOS image sensor	
	<b>Minimum Illumination</b>	Color : 0.3 lx, BW : 0.12 lx (50IRE, F2.0, Maximum shutter : Off (1/30s), AGC : 11) BW : 0 lx (50IRE, F2.0, Maximum shutter : Off (1/30 s), AGC : 11, when the IR LED is lit) Color : 0.019 lx, BW : 0.0075 lx (50IRE, F2.0, Maximum shutter : max. 16/30s, AGC : 11) <sup>1</sup>	
	<b>White Balance</b>	AWC (2,000 - 10,000 K), ATW1 (2,700 - 6,000 K), ATW2 (2,000 - 6,000 K)	
	<b>Maximum shutter</b>	Max. 1/10000 s to Max. 16/30 s	
	<b>Intelligent Auto</b>	On / Off	
	<b>Super Dynamic</b>	On / Off, the level can be set in the range of 0 to 31.	
	<b>Dynamic Range</b>	Max. 102 dB (Super Dynamic : On, Level: 31)	
	<b>Adaptive Black Stretch</b>	-	
	<b>Back light compensation / High light compensation</b>	BLC (Back light compensation) / HLC (High light compensation) / Off (only when Super dynamic / Intelligent Auto : Off)	
	<b>Fog compensation</b>	On/ Off The level can be set in the range of 0 to 8, (only when Intelligent auto / auto contrast adjust: Off)	
	<b>Maximum gain (AGC)</b>	The level can be set in the range of 0 to 11.	
	<b>Color/BW (ICR)</b>	Off / On (IR Light Off) / On (IR Light On) / Auto1 (IR Light Off) / Auto2 (IR Light On) / Auto3 (SCC)	
	<b>IR LED Light</b>	High / Middle / Low / Off, Maximum irradiation distance : 20 m (Approx. 65 ft)	
	<b>Digital Noise Reduction</b>	The level can be set in the range of 0 to 255.	
	<b>Video Motion Detection (VMD)</b>	On / Off, 4 areas available	
	<b>Privacy Zone</b>	On / Off (up to 8 zones available)	
	<b>Image rotation<sup>2</sup></b>	0° / Off/ 90° / 180° (Upside-down/ 270°)	
	<b>Camera Title (OSD)</b>	On / Off Up to 20 characters (alphanumeric characters, marks)	
	<b>Lens</b>	<b>Focal length</b>	2.9 mm - 7.3 mm (1/8inches-9/32inches)
		<b>Zoom ratio</b>	2.5x Optical zoom (Motorized zoom / Motorized focus) 3.3x FHD Extra Optical Zoom (when resolution is 1920x1080)
<b>Digital (electronic) zoom</b>		Choose from 3 levels of x1, x2, x4	
<b>Angular Field of View</b>		[16 : 9 mode] * [4:3 mode] is not supported. Horizontal : 44° (TELE) - 102° (WIDE) Vertical : 25° (TELE) - 57° (WIDE)	
<b>Maximum Aperture Ratio</b>		1 : 2.0 (WIDE) - 1 : 3.0 (TELE)	
<b>Focusing Range</b>		1 m (39-3/8 inches) - ∞	
<b>Adjusting Angle</b>		Horizontal (PAN) angle: ±180°, Vertical (TILT) angle: -30° ~ +85° Azimuth (YAW) angle: ±100°	
<b>Browser GUI</b>	<b>Camera Control</b>	Brightness	
	<b>GUI / Setup Menu Language</b>	English, Italian, French, German, Spanish, Portuguese, Russian, Chinese, Japanese	
<b>Network</b>	<b>Network I/F</b>	10Base-T / 100Base-TX, RJ45 connector	
	<b>Resolution H.265</b>	[16 : 9 mode] * [4:3 mode] is not supported. 2560x1440, 1920x1080, 640x360, 320x180	
	<b>H.265</b>	<b>Transmission Mode</b>	Constant bit rate / VBR / Frame rate / Best effort
		<b>Transmission Type</b>	Unicast / Multicast
	<b>JPEG</b>	<b>Image Quality</b>	10 steps
	<b>Smart Coding</b>	<b>GOP(Group of pictures) control:</b> On(Frame rate control)/ On(Advanced)/ On(Mid./) On(Low)/ Off <b>AUTO VIGS:</b> On/ Off	

<b>Network</b>	<b>Audio Compression</b>	-
	<b>Audio transmission mode</b>	-
	<b>Supported Protocol</b>	IPv6 : TCP/IP, UDP/IP, HTTP, HTTPS, RTP, SMTP, DNS, NTP, SNMP, DHCPv6, MLD, ICMP, ARP, IEEE 802.1X, DiffServ IPv4 : TCP/IP, UDP/IP, HTTP, HTTPS, RTSP, RTP, RTCP, SMTP, DHCP, DNS, DDNS, NTP, SNMP, UPnP, IGMP, ICMP, ARP, IEEE 802.1X, DiffServ
	<b>No. of Simultaneous Users</b>	Up to 14 users (Depends on network conditions)
	<b>SDXC/SDHC/SD Memory Card (Option)</b>	H.265 recording: Manual REC / Alarm REC (Pre/Post) / Schedule REC / Backup upon network failure Compatible microSDXC/microSDHC Memory Card: Panasonic 32 GB*, 64 GB**model *microSDHC card, **microSDXC card
	<b>Mobile Terminal Compatibility</b>	iPad, iPhone, Android™ terminals
<b>Alarm</b>	<b>Alarm Source</b>	VMD alarm, SCD alarm, Command alarm
	<b>Alarm Actions</b>	SDXC/SDHC/SD memory recording, E-mail notification, HTTP alarm notification indication on browser, Panasonic alarm protocol output
<b>Input/Output</b>	<b>Monitor Output (for adjustment)</b>	-
	<b>Audio Input</b>	-
	<b>Audio Output</b>	-
	<b>External I/O Terminals</b>	-
<b>General</b>	<b>Safety</b>	UL (UL60950-1), c-UL (CSA C22.2 No.60950-1), CE, IEC60950-1
	<b>EMC</b>	FCC (Part15 ClassA), ICES003 ClassA, EN55032 ClassB, EN55024
	<b>Power Source and Power Consumption</b>	PoE (IEEE802.3af compliant) Device : DC48 V 135 mA, Approx. 6.5 W (Class 0 device)
	<b>Ambient Operating Temperature</b>	-10 °C to +50 °C (+14 °F to +122 °F) (Power On range: 0 °C to +50 °C (+32°F to +122 °F))
	<b>Ambient Operating Humidity</b>	10 to 90 % (no condensation)
	<b>Dimensions</b>	ø129.5 mm x 101 mm (H) (ø5-3/32 inches x 3-31/32 inches (H)) Dome radius 40 mm (1-9/16 inches)
	<b>Mass (approx.)</b>	Approx. 350 g (0.77 lbs)
	<b>Finish</b>	Main body : ABS resin, i-PRO white Dome section : Acrylic resin, Clear

<sup>1</sup> Converted value

<sup>2</sup> When "4:3(30fps mode)" or "4:3(25fps mode)" is selected for "Image capture mode", "90 °" and "270 °" cannot be selected.

# Appearance

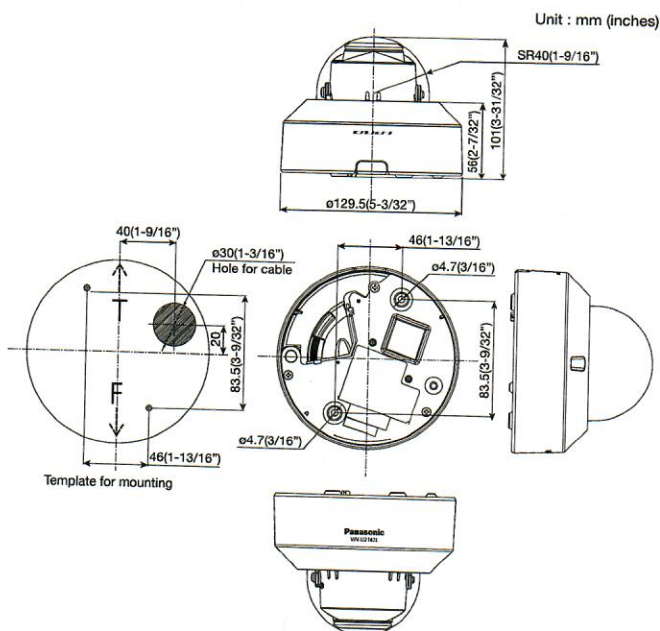

# Optional Accessories

## Mount Bracket / Dome Cover

<b>Ceiling Mount Bracket WV-Q105A</b> 	<b>Ceiling Mount Bracket (Embedded) WV-QEM100-W (i-PRO white)</b> 	<b>Ceiling Mount Bracket WV-QCL101-W (i-PRO white)</b> 
<b>Wall Mount Bracket WV-QWL500-W (i-PRO white)</b> 	<b>Dome Cover (Smoke type) WV-CF5SA</b> 	

## Trademarks and registered trademarks

- iPad and iPhone are trademarks of Apple Inc., registered in the U.S. and other countries.
- Android is a trademark of Google LLC.
- ONVIF and the ONVIF logo are trademarks or registered trademarks of Onvif Inc.
- All other trademarks identified herein are the property of their respective owners.

## Important

- Safety Precaution : Carefully read the Basic Information, Installation Guide and Operating Instructions before using this product.
- Panasonic cannot be responsible for the performance of the network and/or other manufacturers' products used on the network.

• Masses and dimensions are approximate. • Specifications are subject to change without notice.

DISTRIBUTED BY :

Panasonic i-PRO Sensing Solutions Co., Ltd.

<https://ipro.panasonic.com>

<https://security.panasonic.com>

<https://www.facebook.com/Panasonicnetworkcamera/>

(2A-235CL)

## 4 x 4K(33MP) iA H.265 Multi-Sensor Camera

Panasonic WV-X8570N captures the highest quality images in even very challenging and dynamic environments. In particular, the camera can capture clear vehicle image in color even at night intersections of low light intensity. And the four repositionable lenses minimize blind spots and flexibly correspond to intersections of various shapes and monitoring areas of cities. Easily set up with a smartphone or tablet device via Wi-Fi connection. \*Wi-Fi USB adapter is required. Intelligent Auto (iA) monitors scene dynamics and motion to adjust key camera settings automatically in real-time reducing distortion such as motion blur on moving objects. Adopting H.265 Smart Coding technology, bandwidth efficiency is intelligently increased for longer recording and less storage. Cameras out-of-the-box, use an encryption module standardized by FIPS Publication 140-2 for secure video streaming.

### Extreme image quality for evidence capturing under challenging conditions

- Four repositionable lenses with easy adjustment include a wide range tilt angle mechanism minimizes blind spots
- Four high image quality 4K image sensors and produce a resolution of 3,840 x 2,160 pixels at up to 15 fps
- Sharp and clear images of fast moving vehicles with Intelligent Auto and ClearSight Coating
- Outstanding low light performance in true color with low noise for night time applications
- Super Dynamic 108dB for backlit situations and shadows on night streets
- Environmental durability : IP66, IK10 and Dehumidification device

### Extreme bandwidth compression with new Panasonic H.265 Smart Coding

- Reduced the amount of transferred data and less storage space compared to any H.264 based compression techniques
- New self-learning ROI\* encoding (Auto VIQS) dynamically detect motion areas to keep vehicles and human in good picture quality while lowering your bandwidth \*Region of Interest

### Extreme Data Security

- Full encryption SD card edge recording to keep your data safe
- FIPS140-2 CAVP compliant \*Using encryption module standardized by FIPS publication 140-2
- Full end-to-end system encryption with supported VMS and devices to protect from IP snooping/spoofing and detect data alteration

### Key Features

- 4 x 4K(33MP) 3840x2160 15fps
- iA (intelligent Auto)
- Super Dynamic 108dB
- Color night vision (0.008 to 0.12 lx)
- H.265 Smart Coding
- ClearSight Coating
- Wide range tilt angle adjustment mechanism

### Industry examples

- Public safety (City / Highway toll / Parking gate)
- Transportation (Airport / Train / Subway)

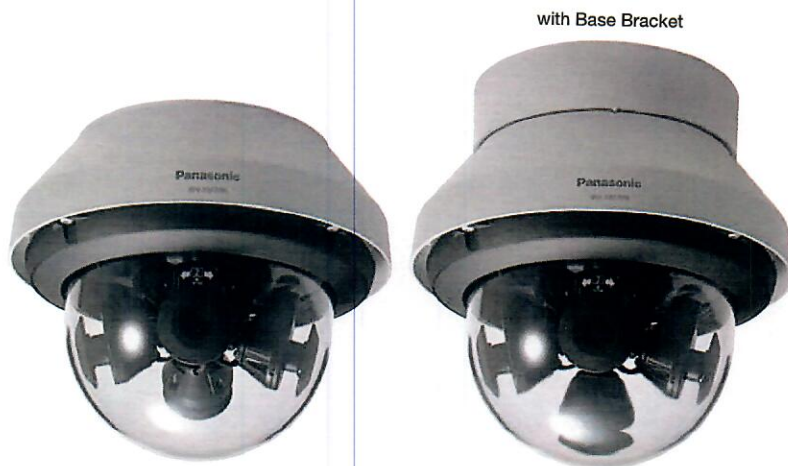

## 4 x True 4K high resolution



- Can identify vehicles 100 feet diagonal from intersection corners at three lane streets

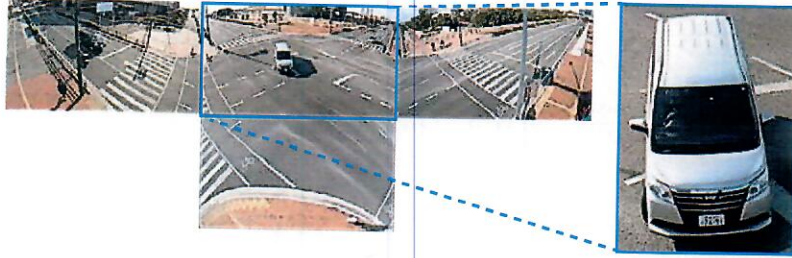

## Combining H.265 compression with Smart Coding technology

- In spite of the high resolution of 4 x 4 K, it achieved the bit rate lower than the bit rate of one 4K camera of H.264.

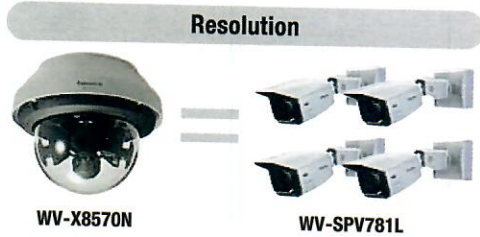

\* "H.265 with Smart Coding" provides max.95% reduction in total file size when compared to "H.264 without Smart Coding" but it depends on a scene.

## Wide range tilt angle adjustment mechanism

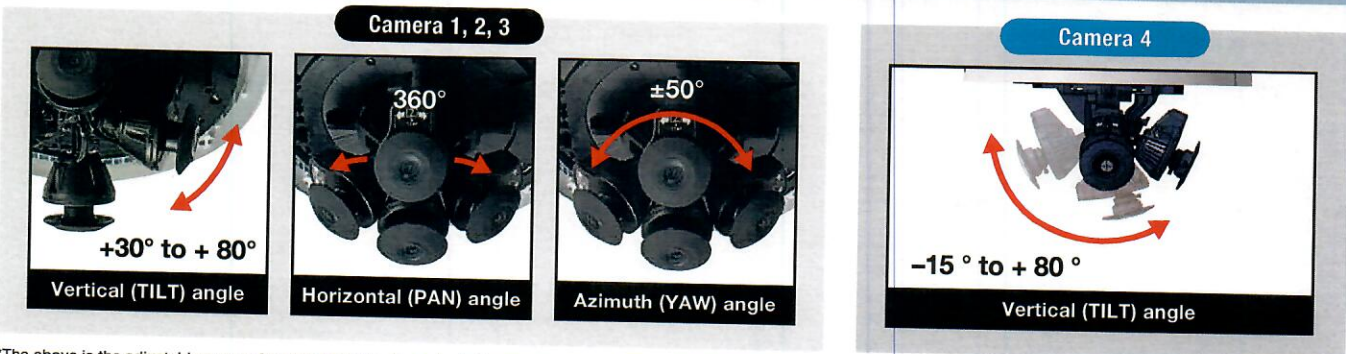

\*The above is the adjustable range of a single camera. The adjustable range of each camera varies according to the positional relationship with other cameras.

## Four repositionable lenses enables to monitoring at minimize blind spots

### 270-degree view (Full intersection view)

- One multi sensor camera at intersection corner, It enables monitoring with minimized blind spots
- Enables to monitoring even if bottom view angle

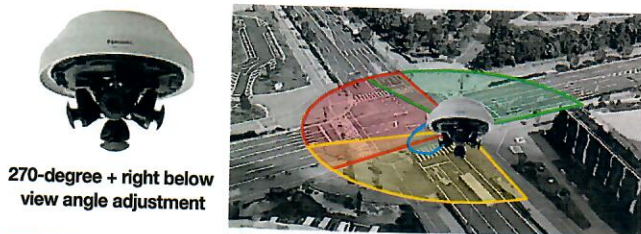

### 360-degree view

- One multi-sensor camera enables monitor the park by minimize blind spots

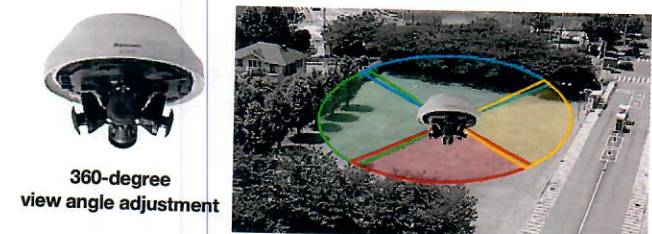

# Specifications

<b>Camera</b>	<b>Image Sensor</b>	1/1.8 type CMOS image sensor
	<b>Minimum Illumination</b>	Color : 0.12 lx, BW : 0.05 lx (F1.6, Maximum shutter : Off (1/30s), AGC : 11) Color : 0.008 lx, BW : 0.003 lx (F1.6, Maximum shutter : max. 16/30s, AGC : 11) <sup>*1</sup>
	<b>Intelligent Auto</b>	On / Off
	<b>Maximum shutter</b>	Max. 1/10000s to Max. 16/30s
	<b>Super Dynamic</b>	On / Off, the level can be set in the range of 0 to 31.
	<b>Dynamic Range</b>	108 dB typ. (Super Dynamic : On, level : 31)
	<b>Image Settings</b>	Gain (AGC), White balance
	<b>Image Compensation</b>	Adaptive black stretch, Back light compensation (BLC), High light compensation (HLC), Fog compensation, Digital noise reduction
	<b>Color/BW (ICR)</b>	Off / On / Auto1 (Normal) / Auto2 (IR Light) / Auto3 (SCC)
	<b>Video Motion Detection (VMD)</b>	On / Off, 4 areas available
	<b>Privacy Zone</b>	On / Off (up to 8 zones available)
	<b>Upside-down</b>	On / Off
	<b>Camera Title (OSD)</b>	On / Off Up to 20 characters (alphanumeric characters, marks)
	<b>Adjusting angle</b>	Camera 1, 2, 3: Horizontal (PAN) angle : 360° Vertical (TILT) angle : +30° to +80° Azimuth (YAW) angle : ±50° Camera 4: Horizontal (PAN) angle : 360° Vertical (TILT) angle : -15° to +80° Azimuth (YAW) angle : ±50° <sup>*The above is the adjustable range of a single camera. The adjustable range of each camera varies according to the positional relationship with other cameras.</sup>
	<b>Lens</b>	<b>Zoom Ratio</b>
<b>Digital (electronic) zoom</b>		Choose from 3 levels of x1, x2, x4
<b>Focal length</b>		4.6 mm (3/16 inches)
<b>Maximum Aperture Ratio</b>		1 : 1.6
<b>Focus range</b>		3.0 m (9.84 feet) ~ ∞
<b>Browser GUI</b>	<b>Angular Field of view</b>	Horizontal : 97° Vertical : 53°
	<b>Camera Control</b>	Brightness, AUX On / Off
<b>Network</b>	<b>Audio</b>	Mic (Line) Input : On / Off Volume adjustment : Low / Middle / High
	<b>GUI / Setup Menu Language</b>	English, Italian, French, German, Spanish, Portuguese, Russian, Chinese, Japanese
<b>Network</b>	<b>Network IF</b>	10Base-T / 100Base-TX / 1000Base-T, RJ45 connector
	<b>Resolution</b>	[16:9 mode] <sup>*</sup> *Cannot be changed. 3840 x 2160 / 2560 x 1440 / 1280 x 720 / 640 x 360 / 320 x 180
	<b>H.265<sup>1</sup> / H.264<sup>2</sup> Transmission Mode</b>	Constant bit rate / VBR / Frame rate / Best effort
	<b>H.265<sup>1</sup> / H.264<sup>2</sup> Transmission Type</b>	Unicast / Multicast
	<b>JPEG Image Quality</b>	10 steps
	<b>Smart Coding</b>	<b>GOP (Group of pictures) control :</b> On (Frame rate control) / On (Advanced) / On (Mid) / On (Low) / Off <sup>*On (Frame rate control) and On (Advanced) are only available with H.265.</sup> <b>Auto VIQS : On / Off</b>
	<b>Audio Compression</b>	G.726 (ADPCM) : 16 kbps / 32 kbps G.711 : 64 kbps AAC-LC <sup>3</sup> : 64 kbps / 96 kbps / 128 kbps
	<b>Supported Protocol</b>	IPv6 : TCP/IP, UDP/IP, HTTP, HTTPS, FTP (Server), SMTP, DNS, NTP, SNMP, DHCPv6, RTP, MLD, ICMP, ARP, IEEE 802.1X, DiffServ IPv4 : TCP/IP, UDP/IP, HTTP, HTTPS, RTSP, RTP, RTCP, FTP (Server), SMTP, DHCP, DNS, DDNS, NTP, SNMP, UPnP, IGMP, ICMP, ARP, IEEE 802.1X, DiffServ

<b>Network</b>	<b>Maximum concurrent access number</b>	Up to 24 users (Depends on network conditions)
	<b>SDXC/SDHC/SD Memory Card</b>	H.265 / H.264 recording : Manual REC / Alarm REC (Pre/Post) / Schedule REC / Backup upon network failure Compatible SDXC/SDHC/SD card : Panasonic 2 GB, 4 GB*, 8 GB*, 16 GB*, 32 GB*, 64 GB**, 128 GB**, 256 GB**model *SDHC card, **SDXC card (except miniSD card and microSD card)
<b>Alarm</b>	<b>Mobile Terminal Compatibility</b>	iPad / iPhone, Android™ mobile terminals
	<b>Alarm Source / Alarm Actions</b>	3 terminals input, VMD alarm, Command alarm SDXC/SDHC/SD memory recording, E-mail notification, HTTP alarm notification, Indication on browser, Panasonic alarm protocol output
<b>Input/Output</b>	<b>Audio Input</b>	ø3.5 mm stereo mini jack (Audio input is monaural)
	<b>For microphone input :</b>	Recommended applicable microphone: Plug-in power type (Sensitivity of microphone : -48 dB±3 dB (0 dB=1 V/Pa, 1 kHz)) Input impedance : Approx. 2 k (unbalanced) Supply voltage : 4.0 V ±0.5 V <b>For line input :</b> Input level : Approx. -10 dBV
<b>External I/O Terminals</b>	<b>ALARM IN 1 (Alarm input 1/ Black &amp; white input/ Auto time adjustment input) (x1), ALARM IN 2 (Alarm input 2/ ALARM OUT) (x1), ALARM IN 3 (Alarm input 3/ ALARM OUT/ AUX OUT) (x1)</b>	
	<b>Safety</b>	UL (UL60950-1), c-UL (CSA C22.2 No.60950-1), CE, IEC60950-1
<b>General</b>	<b>EMC</b>	FCC (Part15 ClassA), ICES003 ClassA, EN55032 ClassB, EN55024
	<b>Power Source and Power Consumption</b>	PoE (IEEE802.3af compliant) Device : DC 48 V 265 mA/Approx. 12.95 W (Class 0 device)
	<b>Ambient Operating Temperature</b>	-40 °C to +60 °C (-40 °F to +140 °F) (Power On range : -20 °C to +60 °C (-4 °F to +140 °F))
	<b>Ambient Operating Humidity</b>	10 to 100 % (no condensation)
	<b>Water and Dust Resistance</b>	IP66 (IEC60529), Type 4X (UL50), NEMA 4X compliant
	<b>Shock Resistance</b>	IK10 (IEC62262)
	<b>Dimensions</b>	<b>When using the attachment plate only :</b> ø230 mm x 196 mm (H) (ø9-1/16 inches x 7-23/32 inches (H)), Dome radius 80 mm (3-5/32 inches) <b>When using the base bracket :</b> ø230 mm x 232 mm (H) (ø9-1/16 inches x 9-1/8 inches (H)), Dome radius 80 mm (3-5/32 inches)
	<b>Mass (approx.)</b>	<b>When using the attachment plate only :</b> Approx. 2.8 kg (6.17 lbs) <b>When using the base bracket :</b> Approx. 3.3 kg (7.28 lbs)
	<b>Finish</b>	Main body : Aluminum die cast, Light gray, Outer fixing screws : Stainless steel (Corrosion-resistant treatment) Dome cover : Polycarbonate resin (with ClearSight coating), Clear

<sup>\*1</sup> Converted value  
<sup>\*2</sup> H.265/H.264 can be selected for each stream.  
<sup>\*3</sup> When recording audio on an SD memory card, only use AAC-LC (Advanced Audio Coding-Low Complexity).

# Appearance

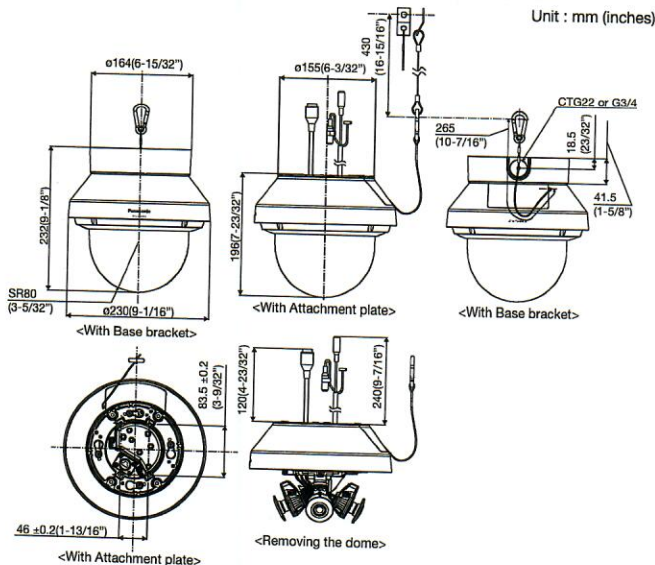

DISTRIBUTED BY :

**Trademarks and registered trademarks**  
- iPad and iPhone are trademarks of Apple Inc., registered in the U.S. and other countries.  
- Android is a trademark of Google LLC.  
- ONVIF and the ONVIF logo are trademarks or registered trademarks of Onvif Inc.  
- All other trademarks identified herein are the property of their respective owners.

**Important**  
- Safety Precaution : Carefully read the Important Information, Installation Guide and operating instructions before using this product.  
- Panasonic cannot be responsible for the performance of the network and/or other manufacturers' products used on the network.

• Masses and dimensions are approximate. • Specifications are subject to change without notice.

# Panasonic

<https://security.panasonic.com>

<https://www.facebook.com/Panasonicnetworkcamera/>

# i-PRO



## TOWER WORKSTATION | WT1-B | NVR-T-1-MWS-V2

MODEL	TOTAL STORAGE	USABLE STORAGE	RAM	PROCESSOR	POWER SUPPLY
NVR-T-1-MWS-V2	1TB (1 x 1TB)	1TB	16GB	Single	Single

- To meet total storage, individual HDD size and quantity may be subject to change.
- Total usable storage is calculated based on advertised HDD size, not OS recognition.
- Usable storage size may vary slightly.
- Performance for multi-monitor use depends on camera codec, resolution, FPS, and network.

### PRELOADED NETWORK WORKSTATION - TOWER WORKSTATION

- VI MonitorPlus Installed
- Fully Configured And Tested
- The "Plug & Play" Workstation Is Ready For Out-Of-The-Box Deployment
- I-PRO US-Based Technical Support
- Standard Dell® 3-Year Service Warranty (After Remote Diagnosis By i-PRO Support Team)
- Recommended Use Case | 4 Monitor Capable  
31 Channels X Full 1080P X 15FPS: H.264  
28 Channels X Full 1080P X 15FPS: H.265 (Total Performance)

### SERVER SPECIFICATIONS

#### PROCESSOR

9th Gen Intel Hex Core / Hex Threads

#### MEMORY

16GB

#### I/O SLOTS

One PCIe 3.0 x 16 Slot (Full Height, Half Length)

#### OPTICAL DRIVE

No

#### DRIVE BAY

2 x 3.5" Drive

#### IDRAC

iDRAC9, Basic

#### EMBEDDED NIC

1 x 1GBE

#### POWER SUPPLY

465W Power Supply

#### SECURITY

On-board Encryption | TPM

#### OPERATING SYSTEM

Windows 10 Pro

#### ACCESSORIES

Keyboard and Mouse

#### GRAPHICS CARD

Nvidia GTX1660

#### VIDEO OUTPUT

3 X DP 1 X HDMI

#### WEIGHT

21 lbs.

#### DIMENSIONS

Tower: (H) 13.19", (W) 6.95", (D) 13.58"

#### HDD BAYS USED VS OPEN

1X Used | 2X Open  
OS on (1TB) 3.5" Drive

#### WARRANTY

Standard Dell® 3-Year Service Warranty (After Remote Diagnosis By i-PRO Support Team)

#### MONITOR

Not Included

- Rear drives - If unit supported, are special order and will require extra configuration time.
- Dell warranty will not cover issues arising from non-Dell parts, including third-party drives.
- No returns accepted after 30 days from invoice date.
- Recommended use case based on overall system throughput.

# i-PRO

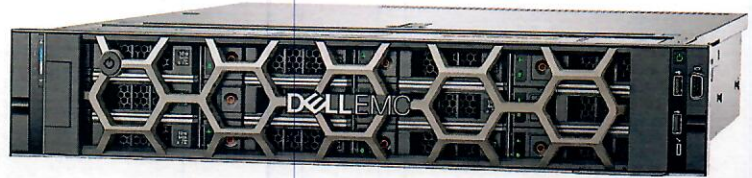

## RACK - NVR | SR2E | NVR-R-2 (24TBA - 72TB)

MODEL	TOTAL STORAGE	USABLE STORAGE	RAM	PROCESSOR	POWER SUPPLY
NVR R-2-24TB-A-V2	24TB (6 x 4TB)	20TB	32GB	DUAL	DUAL
NVR R-2-32TB-V2	32TB (4 x 8TB)	24TB	32GB	DUAL	DUAL
NVR R-2-40TB-V2	40TB (5 x 8TB)	32TB	32GB	DUAL	DUAL
NVR R-2-48TB-V2	48TB (6 x 8TB)	40TB	32GB	DUAL	DUAL
NVR R-2-60TB-V2	60TB (5 x 12TB)	48TB	32GB	DUAL	DUAL
NVR R-2-72TB-V2	72TB (6 x 12TB)	60TB	32GB	DUAL	DUAL

- To meet total storage, individual HDD size and quantity may be subject to change.
- Total usable storage is calculated based on advertised HDD size, not OS recognition.
- Usable storage size may vary slightly.

### PRELOADED NETWORK VIDEO RECORDER - RACK SERVER

- VI Server License Included
- VI Software Installed And Activated
- Fully Configured And Tested
- Unlimited Software Updates For Installed Video Insight Software Licenses
- The "Plug & Play" NVR Is Ready for Out-Of-The-Box Deployment
- Pro Level, 3-Year Dell Next Business Day On-site Service (After Remote Diagnosis By i-PRO Support Team)
- Recommended Use Case | 300Mbs-600 Recording Rate Performance | 1Gbs Network

### SERVER SPECIFICATIONS

#### PROCESSOR

2x Intel Xeon Silver Octa Core / Sixteen Threads

#### MEMORY

32GB ECC

#### I/O SLOTS

Up to 5x Gen3 Slots

#### OPTICAL DRIVE

No

#### DRIVE BAY

8 x 3.5" Drive

#### RAID LEVEL

RAID5 ( Perc H730 )

#### IDRAC

iDRAC9, Express, + Port

#### EMBEDDED NIC

1GBE Dual Port

#### POWER SUPPLY

2x 495W Power Supply Hot Swap

#### SECURITY

On-board Encryption | TPM

#### OPERATING SYSTEM

Windows Server Standard

#### ACCESSORIES

Keyboard and Mouse

#### GRAPHICS CARD

Intel Onboard Graphics

#### VIDEO OUTPUT

VGA

#### WEIGHT

65.43lbs.

#### DIMENSIONS

2U Rack Mount:  
(H) 3.41", (W) 17.08", (D) 27.71"  
(Dimensions Do Not Account For Bezel)

#### HDD BAYS USED VS OPEN

Listed  
OS on ( 2 x 1TB ) 3.5" Drive

#### WARRANTY

Pro Level, 3-Year Dell Next Business Day On-site Service (After Remote Diagnosis By i-PRO Support Team)

#### MONITOR

Not Included

- Rear drives - If unit supported, are special order and will require extra configuration time.
- Dell warranty will not cover issues arising from non-Dell parts, including third-party drives.
- No returns accepted after 30 days from invoice date.
- Recommended use case based on overall system throughput.

### VZ-43CMP ADVANTAGES

- 43" Full HD Resolution
- 3D Comb-filter, De-Interlace, 600 TV Line
- 16:9 / 4:3 Ratio Available, HDMI, VGA, PC Audio, AV Audio
- 1 AV (CVBS) Input / Output (Loop-through)
- Built-in Speakers, Auto Source & Power Recovery
- 3-Year Warranty

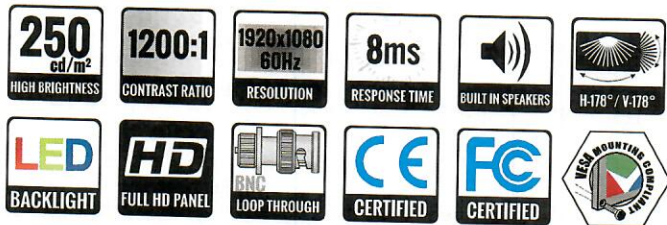

MODEL #	VZ-43CMP	
<b>VIDEO</b>		
Screen Size	43"	
Max. Resolution	1920 x 1080 @60Hz	
Pixel Pitch	0.4902 mm x 0.4902 mm	
Brightness	250cd/m²(Typical)	
Contrast Ratio	1200:1	
Aspect Ratio	16 : 9	
Viewing Angle (H/V)	178° / 178°	
Display Color	16.7 Million	
Response Time	< 8ms	
Video System	NTSC / PAL	
<b>INTERFACE</b>		
AV (CVBS) In / Out	1 / 1	
VGA In (15Pin D-Sub)	1	
HDMI In	1	
PC Audio In / AV Audio In	1 / 1	
<b>AUDIO</b>		
Built in speaker	5W X 2	
<b>SPECIAL FEATURES</b>		
Filter Type	3D Comb-filter / De-Interlace	
Language	English, Deutsch, French, Spanish, Italian	
<b>DIMENSIONS &amp; WEIGHT</b>		
Outline Dimension (W x H x D)	39.10" x 24.8" x 7.08"	
Net Weight / Gross Weight	TBD	
<b>MOUNT</b>		
VESA	300mm x 300mm / 4 x (M8x L8) Screws	
<b>GENERAL</b>		
Power	Electrical Ratings	AC100 ~ 240V(50/60Hz)
	Consumption	TBD
Operating Temperature   Humidity Regulations	14 ~ 122°F / -10 ~ 50°C   20 ~ 70% RH	
Compatible Mounts	WALL	VZ-AM02, VZ-WM50
	CEILING	VZ-CMKIT-01, VZ-CMKIT-02

### DIMENSIONS

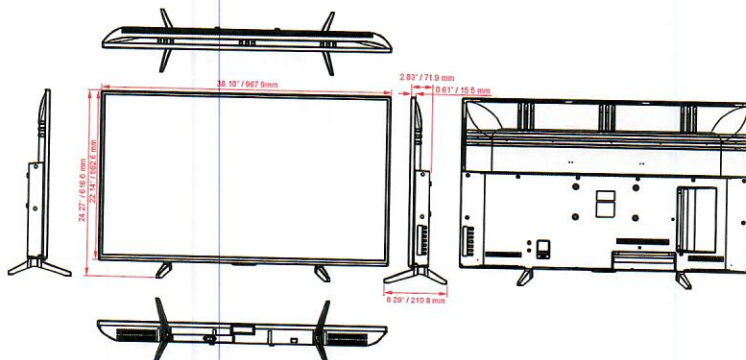

### INTERFACE

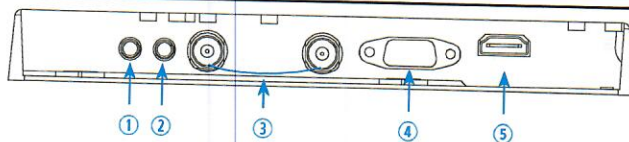

1. PC Audio IN
2. AV Audio IN
3. AV IN / OUT
4. VGA IN
5. HDMI IN

### Contact ViewZ

- Address : 177 W. Orangethorpe Ave., Placentia, CA 92870
- Phone : (714) 996-1177, Fax : (714) 996-1138
- Sales : sales@viewzusa.com
- Specification subject to change without notice.