



Purchasing Division  
2019 Washington Street East  
Post Office Box 50130  
Charleston, WV 25305-0130

State of West Virginia  
Request for Quotation  
13 - Equipment

Proc Folder: 558157

Doc Description: Energy Savings - Lights Project

Proc Type: Central Purchase Order

Date Issued	Solicitation Closes	Solicitation No	Version
2019-03-22	2019-04-04 13:30:00	CRFQ 0211 GSD1900000019	1

#### BID RECEIVING LOCATION

BID CLERK  
DEPARTMENT OF ADMINISTRATION  
PURCHASING DIVISION  
2019 WASHINGTON ST E  
CHARLESTON WV 25305  
US

#### VENDOR

Vendor Name, Address and Telephone Number:

140 E Commercial Street, Suite1  
Wood Dale  
IL, 60191

RECEIVED

2019 APR -4 PM 1:13

WV PURCHASING  
DIVISION

#### FOR INFORMATION CONTACT THE BUYER

Linda B Harper  
(304) 558-0468  
linda.b.harper@wv.gov

Signature X

FEIN # 20 - 5825048

DATE

All offers subject to all terms and conditions contained in this solicitation

**ADDITIONAL INFORMATION:**

The West Virginia Purchasing Division for the Agency, The West Virginia Department of Administration's, General Services Division is soliciting bids from qualified vendors to establish a "One-Time" contract for the purchase of LED Light Fixtures and Accessories per the Specifications, Terms & Conditions and bid requirements as attached.

INVOICE TO		SHIP TO	
DEPARTMENT OF ADMINISTRATION GENERAL SERVICES DIVISION 112 CALIFORNIA AVENUE, 5TH FLOOR CHARLESTON WV25305 US		STATE OF WEST VIRGINIA JOBSITE - SEE SPECIFICATIONS No City WV 99999 US	

Line	Comm Ln Desc	Qty	Unit Issue	Unit Price	Total Price
1	Light emitting diode LED fixture	37.00000	EA	\$278	\$10,286

Comm Code	Manufacturer	Specification	Model #
39111544	AOK	LED Canopy with occupancy sensor	AOK - 40WiDB

**Extended Description :**

3.1.1 Barron Lighting Group, Trace Lite RCL Series, or equal.

INVOICE TO		SHIP TO	
DEPARTMENT OF ADMINISTRATION GENERAL SERVICES DIVISION 112 CALIFORNIA AVENUE, 5TH FLOOR CHARLESTON WV25305 US		STATE OF WEST VIRGINIA JOBSITE - SEE SPECIFICATIONS No City WV 99999 US	

Line	Comm Ln Desc	Qty	Unit Issue	Unit Price	Total Price
2	Light emitting diode LED fixture	41.00000	EA	\$295	\$12,095

Comm Code	Manufacturer	Specification	Model #
39111544	Britelite	2X4 Troffer with emergency backup and occupancy sensor	BLSO-LTR24-36W35KD1-EM W490

**Extended Description :**

3.1.2 Metalux Cruz Series, AMSEM 24CZ-LD5-40SE-S-UNV-EL7W-L835-CD1-SVPD1-RV-U, or equal.

INVOICE TO		SHIP TO	
DEPARTMENT OF ADMINISTRATION GENERAL SERVICES DIVISION 112 CALIFORNIA AVENUE, 5TH FLOOR CHARLESTON WV25305 US		STATE OF WEST VIRGINIA JOBSITE - SEE SPECIFICATIONS No City WV 99999 US	

Line	Comm Ln Desc	Qty	Unit Issue	Unit Price	Total Price
3	Light emitting diode LED fixture	30.00000	EA	\$278	\$8,340

Comm Code	Manufacturer	Specification	Model #
39111544	Britelite	2X4 Troffer with emergency backup and occupancy sensor	BLSO-LTR24-36W35KD1-EM W490

**Extended Description :**

3.1.3 Metalux Cruz Series AMSGEN 24CZ-LD5-40SE-S-UNV-ETRD-L835-CD1-SVPD1-DV-U, or equal.

INVOICE TO		SHIP TO	
DEPARTMENT OF ADMINISTRATION GENERAL SERVICES DIVISION 112 CALIFORNIA AVENUE, 5TH FLOOR CHARLESTON WV25305 US		STATE OF WEST VIRGINIA JOBSITE - SEE SPECIFICATIONS No City WV 99999 US	

Line	Comm Ln Desc	Qty	Unit Issue	Unit Price	Total Price
4	Interior lighting fixtures and accessories	8.00000	EA	\$91	\$728

Comm Code	Manufacturer	Specification	Model #
39111500	Greengate	Operable in range of -40F to 125F	OXC-P extreme temperature sensor

**Extended Description :**

3.1.4 Greengate OXC-P extreme temperature sensors, or equal.

INVOICE TO		SHIP TO	
DEPARTMENT OF ADMINISTRATION GENERAL SERVICES DIVISION 112 CALIFORNIA AVENUE, 5TH FLOOR CHARLESTON WV25305 US		STATE OF WEST VIRGINIA JOBSITE - SEE SPECIFICATIONS No City WV 99999 US	

Line	Comm Ln Desc	Qty	Unit Issue	Unit Price	Total Price
5	Light emitting diode LED fixture	155.00000	EA	\$147	\$22,785

Comm Code	Manufacturer	Specification	Model #
39111544	Britelite	2X4 Troffer with occupancy sensor	BLSO-LTR24-36W35KD1

**Extended Description :**

3.1.5 Metalux Cruz series Type AMS 24CZ-LD5-40SE-S-UNV-L835-CDI-SVPD1-DV-U, or equal.

INVOICE TO		SHIP TO	
DEPARTMENT OF ADMINISTRATION GENERAL SERVICES DIVISION 112 CALIFORNIA AVENUE, 5TH FLOOR CHARLESTON WV25305 US		STATE OF WEST VIRGINIA JOBSITE - SEE SPECIFICATIONS No City WV 99999 US	

Line	Comm Ln Desc	Qty	Unit Issue	Unit Price	Total Price
6	Light emitting diode LED fixture	45.00000	EA	\$77	\$3,465

Comm Code	Manufacturer	Specification	Model #
39111544	Britelite	2X2 LED Troffer	BLSO-LTR22-24W35KD

**Extended Description :**

3.1.6 Metalux Cruz Series 22CZ-LD5-39E-S\_UNV-L835-CD1-U, or equal.

INVOICE TO		SHIP TO	
DEPARTMENT OF ADMINISTRATION GENERAL SERVICES DIVISION 112 CALIFORNIA AVENUE, 5TH FLOOR CHARLESTON WV25305 US		STATE OF WEST VIRGINIA JOBSITE - SEE SPECIFICATIONS No City WV 99999 US	

Line	Comm Ln Desc	Qty	Unit Issue	Unit Price	Total Price
7	Interior lighting fixtures and accessories	100.00000	EA	\$59	\$5,900

Comm Code	Manufacturer	Specification	Model #
39111500	Cooper/ Eaton	Integrated photocell with adaptive daylight harvesting	OSW - P - 010

**Extended Description :**

3.1.7 COOPER/EATON controller OSW-P-010, or equal.

INVOICE TO		SHIP TO	
DEPARTMENT OF ADMINISTRATION GENERAL SERVICES DIVISION 112 CALIFORNIA AVENUE, 5TH FLOOR CHARLESTON WV25305 US		STATE OF WEST VIRGINIA JOBSITE - SEE SPECIFICATIONS No City WV 99999 US	

Line	Comm Ln Desc	Qty	Unit Issue	Unit Price	Total Price
8	Interior lighting fixtures and accessories	200.00000	EA	\$5	\$1,000

Comm Code	Manufacturer	Specification	Model #
39111500	Cooper/ Eaton		EQ - CLIP - U

**Extended Description :**  
 3.1.8 Seismic Lighting Fixture Clamp, COOPER EATON EQ-CLIP-U, or equal.

INVOICE TO	SHIP TO
DEPARTMENT OF ADMINISTRATION GENERAL SERVICES DIVISION 112 CALIFORNIA AVENUE, 5TH FLOOR CHARLESTON WV25305 US	STATE OF WEST VIRGINIA JOBSITE - SEE SPECIFICATIONS No City WV 99999 US

Line	Comm Ln Desc	Qty	Unit Issue	Unit Price	Total Price
9	Interior lighting fixtures and accessories	40.00000	EA	\$120	\$4,800

Comm Code	Manufacturer	Specification	Model #
39111500	Hubbell	Motion Sensor	ATP 1500C

**Extended Description :**  
 3.1.9 Hubbell ATP 1500C motion detector w/Acuity Sensor switch Low 35 Power relay included, or equal.

**SCHEDULE OF EVENTS**

Line	Event	Event Date
1	Question Deadline 3:00 pm	2019-03-28

**DESIGNATED CONTACT:** Vendor appoints the individual identified in this Section as the Contract Administrator and the initial point of contact for matters relating to this Contract.

Charlie Engasser, VP Business Development

(Name, Title)

Charlie Engasser, VP Business Development

(Printed Name and Title)

140 E Commercial Street, Suite 1, Wood Dale, IL 60191

(Address)

(708) 236 -9411 / (708) 236 - 9412

(Phone Number) / (Fax Number)

cengasser@ognigroup.com

(email address)

**CERTIFICATION AND SIGNATURE:** By signing below, or submitting documentation through wvOASIS, I certify that I have reviewed this Solicitation in its entirety; that I understand the requirements, terms and conditions, and other information contained herein; that this bid, offer or proposal constitutes an offer to the State that cannot be unilaterally withdrawn; that the product or service proposed meets the mandatory requirements contained in the Solicitation for that product or service, unless otherwise stated herein; that the Vendor accepts the terms and conditions contained in the Solicitation, unless otherwise stated herein; that I am submitting this bid, offer or proposal for review and consideration; that I am authorized by the vendor to execute and submit this bid, offer, or proposal, or any documents related thereto on vendor's behalf; that I am authorized to bind the vendor in a contractual relationship; and that to the best of my knowledge, the vendor has properly registered with any State agency that may require registration.

Ogni Inc.

(Company)



(Authorized Signature) (Representative Name, Title)

Charlie Engasser, VP Business Development

(Printed Name and Title of Authorized Representative)

04/04/2019

(Date)

(708) 236 -9411 / (708) 236 - 9412

(Phone Number) (Fax Number)

**ADDENDUM ACKNOWLEDGEMENT FORM  
SOLICITATION NO.:**

**Instructions:** Please acknowledge receipt of all addenda issued with this solicitation by completing this addendum acknowledgment form. Check the box next to each addendum received and sign below. Failure to acknowledge addenda may result in bid disqualification.

**Acknowledgment:** I hereby acknowledge receipt of the following addenda and have made the necessary revisions to my proposal, plans and/or specification, etc.

**Addendum Numbers Received:**

*(Check the box next to each addendum received)*

- |  |  |
|--|--|
| <input checked="" type="checkbox"/> Addendum No. 1 | <input type="checkbox"/> Addendum No. 6  |
| <input type="checkbox"/> Addendum No. 2            | <input type="checkbox"/> Addendum No. 7  |
| <input type="checkbox"/> Addendum No. 3            | <input type="checkbox"/> Addendum No. 8  |
| <input type="checkbox"/> Addendum No. 4            | <input type="checkbox"/> Addendum No. 9  |
| <input type="checkbox"/> Addendum No. 5            | <input type="checkbox"/> Addendum No. 10 |

I understand that failure to confirm the receipt of addenda may be cause for rejection of this bid. I further understand that any verbal representation made or assumed to be made during any oral discussion held between Vendor's representatives and any state personnel is not binding. Only the information issued in writing and added to the specifications by an official addendum is binding.

Ogni Inc.

Company

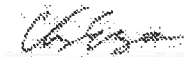

Authorized Signature

04/04/2019

Date

**NOTE:** This addendum acknowledgment should be submitted with the bid to expedite document processing.

STATE OF WEST VIRGINIA  
Purchasing Division

**PURCHASING AFFIDAVIT**

**CONSTRUCTION CONTRACTS:** Under W. Va. Code § 5-22-1(i), the contracting public entity shall not award a construction contract to any bidder that is known to be in default on any monetary obligation owed to the state or a political subdivision of the state, including, but not limited to, obligations related to payroll taxes, property taxes, sales and use taxes, fire service fees, or other fines or fees.

**ALL CONTRACTS:** Under W. Va. Code §5A-3-10a, no contract or renewal of any contract may be awarded by the state or any of its political subdivisions to any vendor or prospective vendor when the vendor or prospective vendor or a related party to the vendor or prospective vendor is a debtor and: (1) the debt owed is an amount greater than one thousand dollars in the aggregate; or (2) the debtor is in employer default.

**EXCEPTION:** The prohibition listed above does not apply where a vendor has contested any tax administered pursuant to chapter eleven of the W. Va. Code, workers' compensation premium, permit fee or environmental fee or assessment and the matter has not become final or where the vendor has entered into a payment plan or agreement and the vendor is not in default of any of the provisions of such plan or agreement.

**DEFINITIONS:**

"Debt" means any assessment, premium, penalty, fine, tax or other amount of money owed to the state or any of its political subdivisions because of a judgment, fine, permit violation, license assessment, defaulted workers' compensation premium, penalty or other assessment presently delinquent or due and required to be paid to the state or any of its political subdivisions, including any interest or additional penalties accrued thereon.

"Employer default" means having an outstanding balance or liability to the old fund or to the uninsured employers' fund or being in policy default, as defined in W. Va. Code § 23-2c-2, failure to maintain mandatory workers' compensation coverage, or failure to fully meet its obligations as a workers' compensation self-insured employer. An employer is not in employer default if it has entered into a repayment agreement with the Insurance Commissioner and remains in compliance with the obligations under the repayment agreement.

"Related party" means a party, whether an individual, corporation, partnership, association, limited liability company or any other form or business association or other entity whatsoever, related to any vendor by blood, marriage, ownership or contract through which the party has a relationship of ownership or other interest with the vendor so that the party will actually or by effect receive or control a portion of the benefit, profit or other consideration from performance of a vendor contract with the party receiving an amount that meets or exceeds five percent of the total contract amount.

**AFFIRMATION:** By signing this form, the vendor's authorized signer affirms and acknowledges under penalty of law for false swearing (W. Va. Code §61-6-3) that: (1) for construction contracts, the vendor is not in default on any monetary obligation owed to the state or a political subdivision of the state, and (2) for all other contracts, that neither vendor nor any related party owe a debt as defined above and that neither vendor nor any related party are in employer default as defined above, unless the debt or employer default is permitted under the exception above.

**WITNESS THE FOLLOWING SIGNATURE:**

Vendor's Name: Ogni Inc.

Authorized Signature: [Signature] Date: 04/04/2019

State of Illinois

County of De Walle to-wit:

Taken, subscribed, and sworn to before me this 9<sup>th</sup> day of April, 2019.

My Commission expires Feb 15, 2023.

**AFFIX SEAL HERE**

**NOTARY PUBLIC**

[Signature]

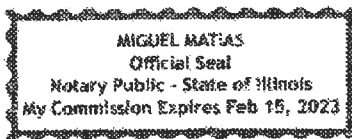





## BriteLite LED Slim (1.97") TROFFER BLSO-LTRXX-WWCKDS

White Power coat finish

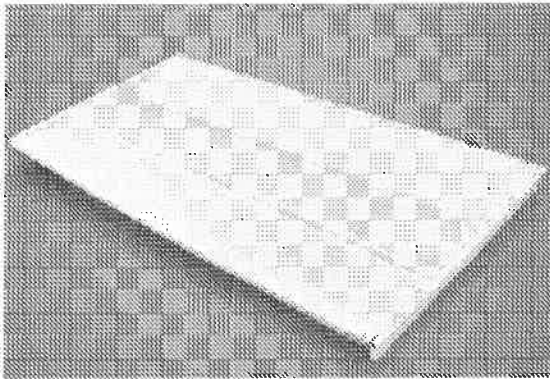

### PHYSICAL SPECIFICATION: 2 X 4

Length: 47.717" (1212mm)

Width: 23.74" (603mm)

Height: 1.97" (50mm)

Weight: 17 lbs

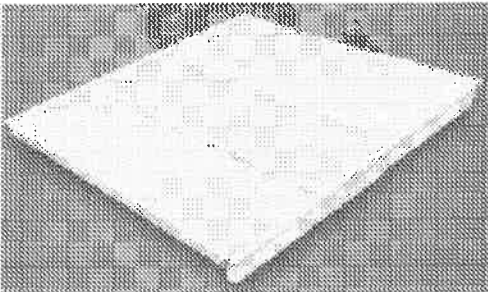

### PHYSICAL SPECIFICATION: 2 X 2

Length: 23.74 (603mm)

Width: 23.74" (603mm)

Height: 1.97" (50mm)

Weight: 10 lbs



## PRODUCT DESCRIPTION:

The BLSO-LTR22/24 Slim LED troffer fixture is a design based on the idea of green energy. It saves over 50% energy compared to fluorescent troffers. The BLSO-LTR22/24 accepts 100-277VAC, and has high lumen efficiency of 125-130Lm/W.

## FEATURES:

- 50,000 Hours L70 Lifespan
- ETL and DLC® Premium 4
- Size 2x4 available watt 24W
- Size 2x2 available watt 36W
- CCT Available: 3500K, 4000K, 5000K
- 125Lm+/W
- Optional: microwave sensor
- Internal Driver
- Standard PC diffuser
- 0-10V Dimming
- sensor optional

## APPLICATION:

- Residential Buildings, Home, Office, Meeting Room
- School, Library, Factory, Warehouse, Hotel;
- Parking Garage, Hospital, Commercial Center;
- Supermarket, Shopping mall;
- Train, Bus station, airport etc.

## TESTED DATA:

- Technical Requirements Version: 4
- Classification: Premium
- Light Output: 3000lm-8250lm
- Wattage: 24w (2x2) 36w (2X4)
- Efficacy: >125 lm/W
- Power Factor: >.90
- CCT: 3500K, 4000K, 5000 K
- CRI: >80
- THD: <15 %
- Frequency: 50-60Hz
- Input Voltage: AC120-277V
- IP Rating: IP20
- Working Environment: -4°F-113°F
- Beam Angle: 120°
- Dimming Compatible: Yes
- Mercury Content: No Hg
- Lens: Polycarbonate

## WARRANTY:

BriteLite LED warrants that our LED products will be free from defects in materials and workmanship for a period of five (5) years from the date of delivery to the end user, including coverage of light output, color stability, driver performance and fixture finish.



## BriteLite LED Slim (1.97") TROFFER Fixtures BLSO-TLR22/24 Series

Page: 2 of 2

### Ordering Information:

MODEL SELECTION Typical order example: BLSO-LTR22-24W40KD1					
Family	Size (xx)	Wattage (WW)	Controls (D)	CCT (CCK)	Sensor option (S)
BLSO-LTR	22 = 2X2	24 = 24W	D= 0-10V Dimmable	35K = 3500K	1 = Microwave sensor
	24 = 2X4	36 = 36W	Blank= Non- Dimmable	40K = 4000K 50K = 5000K	(Blank) = No sensor

### Sensor:

#### Product picture :

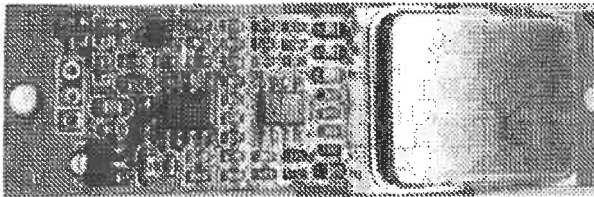

#### Product features :

This module is a microwave sensor equipped with Doppler technology. It can be hidden in the lights made from various Non-metal materials without damaging the exterior of the lighting and the lights can turn on or off lights automatically based on your setting. This advantage helps to upgrade traditional fixtures for operation convenience and energy savings..

#### Technical parameters :

- ◆ Frequency : 5.8GHz ±75MHz
- ◆ Rated voltage : 8~18V/DC
- ◆ Rated current : 20mA
- ◆ Output level : 0-10V(2-light level)
- ◆ Emissive power : Approx. 1mW
- ◆ Mounting height : 2~4M
- ◆ Detection range : φ12M (ceiling mount)
- ◆ Time and light Settings will be as per the customers requirement.
- ◆ Lux setting : 50Lux ±10Lux
- ◆ Product measurement : 68.5(L) \* 21.5 (W) \* 3.5mm(D)



LED GARAGE CANOPY LIGHT

Replace up to 200W MHL

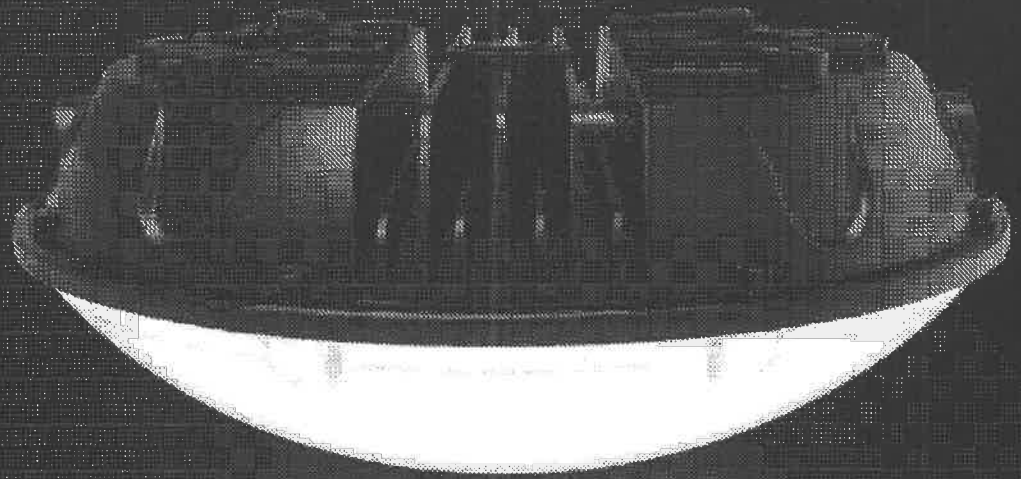

# I D S E R I E S

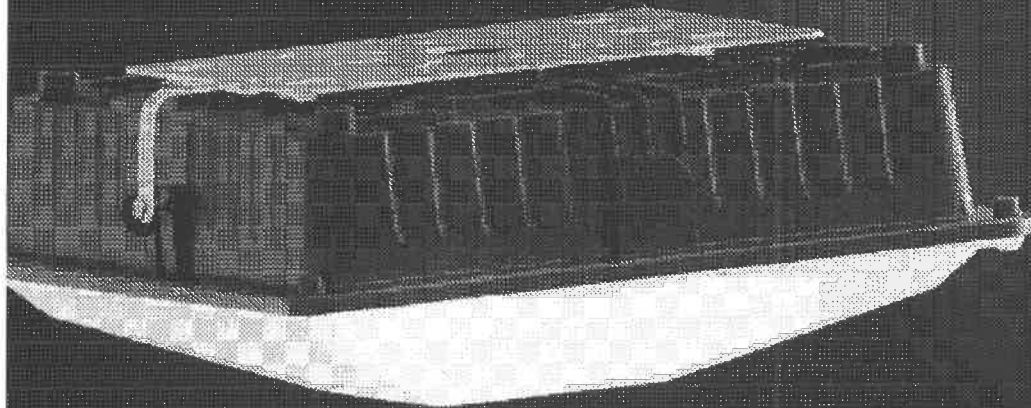

UP TO 130LM/W  
[www.aokledlight.com](http://www.aokledlight.com)



**LED GARAGE CANOPY LIGHT**

AK LED LIGHT CO., LTD.

**APPLICATION**

- Premium Square Garage Light with low-glare illumination and high-energy efficiency.
- AK ID series Canopy Garage Light is a low-profile fixture with high-design elements. This series was designed with performance and aesthetics in mind for an excellent value.

**PERFORMANCE**

- Lumens Per Watt (LPW): Up to 130lm/w
- Advanced garage optic designed for throwing light in the right places

**DURABLE**

- Silver industrial grade powder coat finish
- IP65-rated ready for tough environments

**OPTIONS FOR EVERY GARAGE**

- Beauty plate retrofitting incumbent technology
- Glare shield for reducing motorists glare
- Integrated Smart occupancy sensor

**RECOMMENDED USE**

- Parking garages
- Security and perimeter lighting
- Exterior canopies

**CERTIFICATIONS/LISTINGS**



up to 130lm/w

**IDA SERIES**

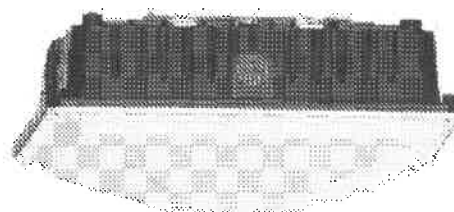

up to 130lm/w

**IDB SERIES**

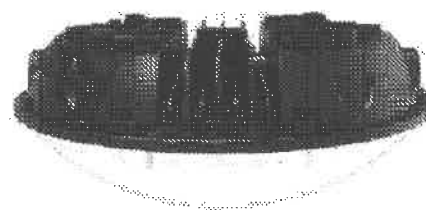

Fixture Specifications	
HOUSING	Silver Powder Coated Aluminum Gray polyester UV-stabilized acrylic polymer with polycarbonate lens
LENS ASSEMBLY	Monate lens with precision individual optics for uniform illumination
MOUNTING	Intended to be surface mounted or pendant mounted for use with conduit or pipe having 1/2" NPT thread

**PHOTOMETRY**

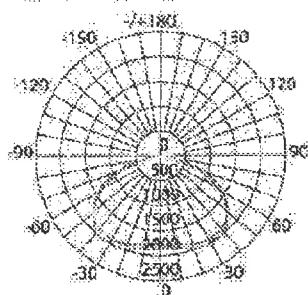

**AVERAGE BEAM ANGLE (50%): 139.2 DEG**  
**IDA**  
 UNIFIED  
 C0/160 Ic:1770 70.4,70.4  
 C90/278 Ic:1770 68.8,68.8

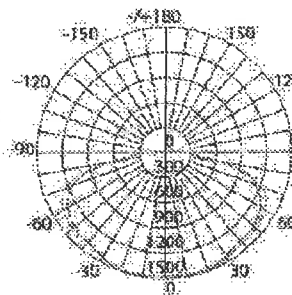

**AVERAGE BEAM ANGLE (50%): 157.5 DEG**  
**IDB**  
 UNIFIED  
 C0/180 Ic:1471 78.9,78.9  
 C90/270 Ic:1471 78.9,78.9

**ORDERING INFORMATION**



**WARRANTY**  
 5-year standard warranty, 10-year warranty optional. Please consult with AK sales for detailed agreement.

LED GARAGE CANOPY LIGHT

AOK LED LIGHT CO., LTD.

FIXTURE DIMENSIONS

FIXTURE DIMENSIONS

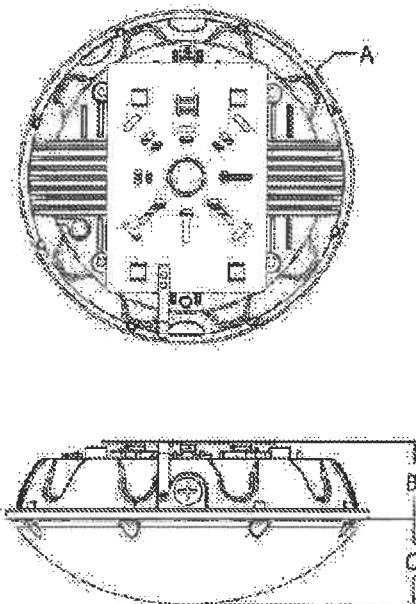
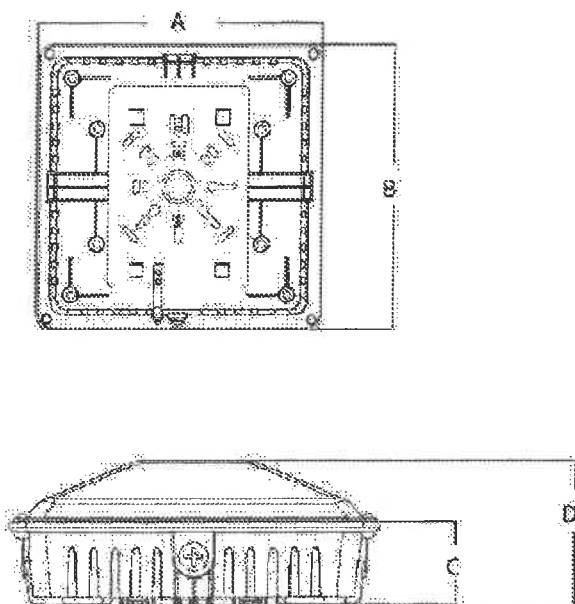

A	B	C	D
25.8cm/10.17"	25.8cm/10.17"	5.8cm/2.29"	16.3cm/4.04"

A	B	C
φ26.5cm/10.4"	3.55cm/1.2"	6.4cm/2.5"

Dimensions of 40W and 60W models

Dimensions of 40W and 60W models

CONSTRUCTION FEATURES

1. Die casting fixture housing
2. Top level performance driver 1-10V dimmable
3. Reflector
4. Optical grade polycarbonate cover
5. Occupancy sensor
6. Light source:PCB board with top level performance LEDs: system efficacy up to 130LM/w
7. Gasket



CONSTRUCTION FEATURES

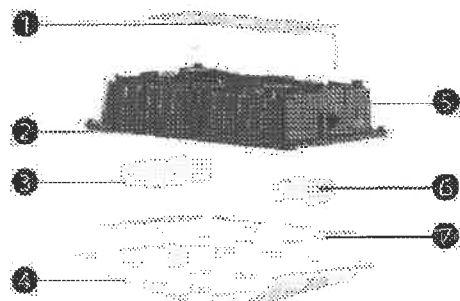

1. Installation adaptor plate
2. Top level performance light source system efficacy up to 130lm/w
3. Top level performance driver 1-10V dimmable
4. Optical grade polycarbonate cover
5. Die casting fixture body
6. Occupancy Sensor
7. Reflector

## LED GARAGE CANOPY LIGHT

AOK LED LIGHT CO., LTD.

## MULTIPLE APPLICATIONS OF IDB SERIES

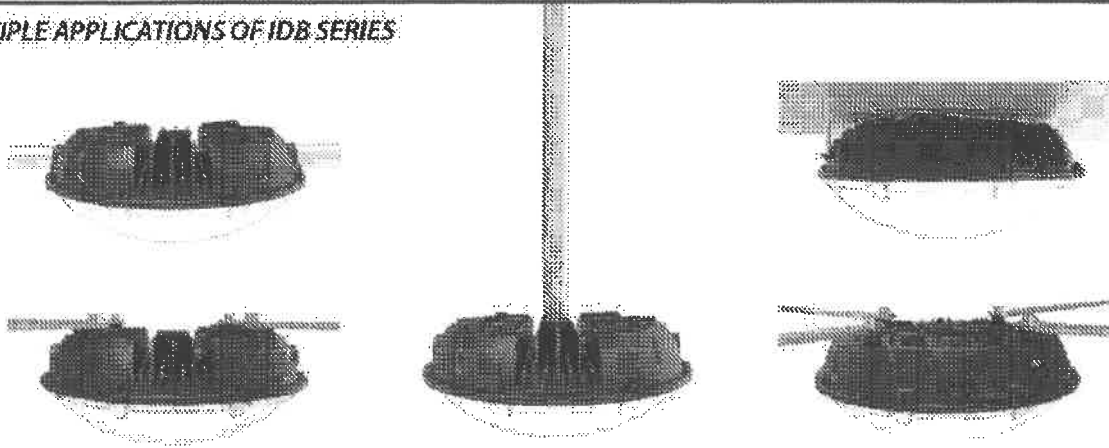

The IDB series supports >5 different installation applications

## MULTIPLE APPLICATIONS OF IDA SERIES

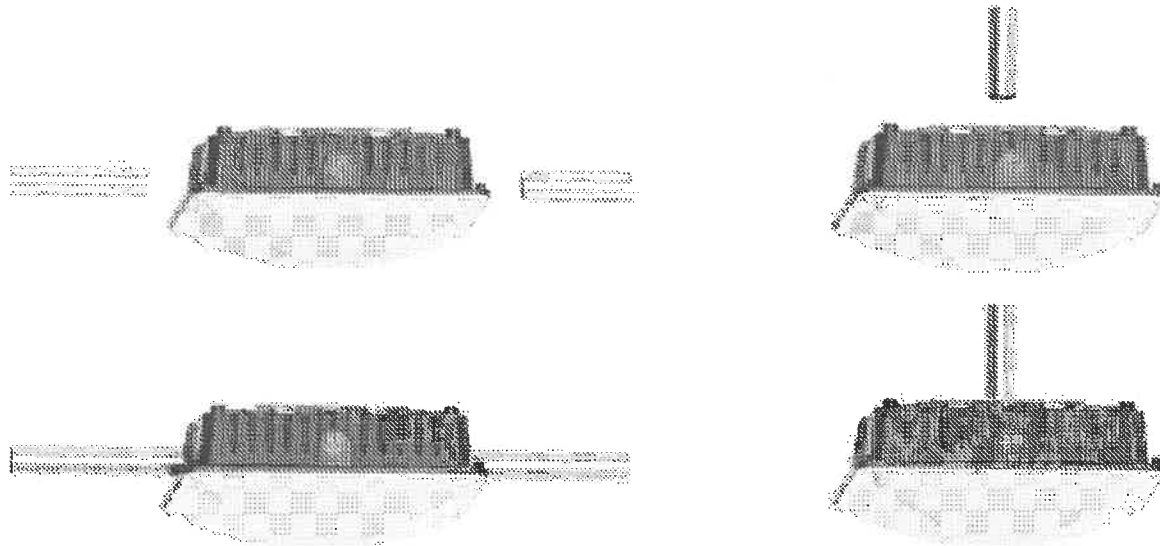

The IDA series supports both vertical and horizontal installations

## TECHNICAL SPECIFICATIONS

MODEL	WATTS	Shape	Initial Delivered Lumen (lm) @5000K	Efficacy (lm/W)	IP	IK	NW	Mounting type
AOK-40WIDA	40W	Square	4930.8	130.91	IP65	IK08	6.63lb(3kg)	Ceiling/ Pendant Mount
AOK-60WIDA	60W	Square	7811.47	137.16	IP65	IK08	6.63lb(3kg)	
AOK-40WIDB	40W	Round	4956.8	130.91	IP65	IK08	6.63lb(3kg)	
AOK-60WIDB	60W	Round	7579.82	137.56	IP65	IK08	6.63lb(3kg)	





BOARD OF SUPERVISORS

Hilda L. Sois  
Mark Ridley-Thomas  
Sheila Kuehl  
Janice Hahn  
Kathryn Barger

---

**COUNTY OF LOS ANGELES  
DEPARTMENT OF CONSUMER  
AND BUSINESS AFFAIRS**

---

*"To Enrich Lives Through Effective and Caring Service"*



**Joseph M. Nicchitta**  
Director

**Joel Ayala**  
Chief Deputy

**Rafael Carbajal**  
Chief Deputy

**March 05, 2019**

**Ramu Adusumilli, President  
OGNI INC. (D/B/A) THE OGNI GROUP  
4415 HARRISON STREET, STE 504  
HILLSIDE, IL 60162**

**CBE I.D. #  
086591  
Status: MBE**

Dear Ramu Adusumilli,

Congratulations! Your firm has been recertified as an eligible participant in the County of Los Angeles Community Business Enterprise (CBE) Program. This recertification is valid until March 05, 2021.

The County of Los Angeles Department of Consumer and Business Affairs (DCBA) reserves the right to request additional information and/or conduct an on-site visit at any time to verify any documentation submitted by the applicant. If there are any changes during this certification period, you are required to notify DCBA immediately.

We would also like to thank you for registering your business with the County's Vendor Registration website (WebVen) at <http://camisvr.co.la.ca.us/webven>. You are now eligible to participate in the County's on-line access to open bids, be placed on bid lists generated by County departments looking for prospective vendors and periodically be notified automatically via email of County bids by specific commodities/services.

Again, congratulations on your recertification. If you have any questions, please call (855) 230-6430 or email us at [cbesbe@dcbalacounty.gov](mailto:cbesbe@dcbalacounty.gov) and refer to the identification number above.

Sincerely,

**Joseph M. Nicchitta**  
Director

**CHRISTIAN OLMOS**  
Program Chief, Office of Small Business  
JMN: CO