



Purchasing Division
 2019 Washington Street East
 Post Office Box 88130
 Charleston, WV 25305-0130

State of West Virginia
 Request for Quotation
 27 - Miscellaneous

Proc Folder: 423113

Doc Description: Statewide contract for Light bulbs and Ballasts

Proc Type: Central Master Agreement

Date Issued	Solicitation Closes	Solicitation No	Version
2018-02-09	2018-02-28 13:30:00	CRFQ 0212 SWC180000012	1

BID RECEIVING LOCATION

BID CLERK
 DEPARTMENT OF ADMINISTRATION
 PURCHASING DIVISION
 2019 WASHINGTON ST E
 CHARLESTON WV 25305
 US

VENDOR

Vendor Name, Address and Telephone Number:

West Virginia Electric Supply
 250 12th St. West
 Huntington, WV 25704
 PH (800) 624-3433

RECEIVED

2018 FEB 28 PM 12:49

WV PURCHASING
 DIVISION

FOR INFORMATION CONTACT THE BUYER

Melissa Petrey
 (304) 558-0094
 melissa.k.petrey@wv.gov

Signature X *Tony Barber*

FEN # 55-0333898

DATE 2/27/2018

All offers subject to all terms and conditions contained in this solicitation

ADDITIONAL INFORMATION

West Virginia Purchasing Division is soliciting bids on behalf of the State of West Virginia to establish an open-end (Statewide) contract for light bulbs and ballast for all West Virginia Agencies and Political Subdivisions as well as county and city municipalities within the state of West Virginia's 50 counties. For the bid requirements, specifications, and terms and conditions that are a part of this solicitation and attached hereto.

INVOICE TO	SHIP TO
ALL STATE AGENCIES VARIOUS LOCATIONS AS INDICATED BY ORDER No City WV99999 US	STATE OF WEST VIRGINIA VARIOUS LOCATIONS AS INDICATED BY ORDER No City WV 99999 US

Line	Comm Ltr Desc	Qty	Unit Issue	Unit Price	Total Price
1	LIGHT BULBS & BALLAST	1.00000	EA		\$24,458.46

Comm Code	Manufacturer	Specification	Model #
39100000	EIKO Globell LLC & Sylvania Lighting		

Extended Description :

Vendors are to enter their TOTAL BID AMOUNT from Exhibit A Pricing Sheet on this line.

\$24,458.46

SWC18B0000012	Document Phase Draft	Document Description Statewide contract for Light bulbs and Ballasts	Page 3
----------------------	--------------------------------	--	---------------

ADDITIONAL TERMS AND CONDITIONS

See attached document(s) for additional Terms and Conditions

Lighting 18 - PRICING PAGE revised 02/16/2018

VENDORS SHOULD COMPLETE ALL GREEN SHADED COLUMNS														
Pricing Page Eligible Item Description						Discounted Unit Price Calculation					Bid Total Calculation			
All references to brand names are for illustration purposes only and vendors may bid the brand listed or an equal product.														
Item #	Product Category	Description	Manufacturer	Item #	Mfr. Model	Catalogue Price	Units Provided for Catalogue Price	Unit Price	Discount Percentage	Discounted Unit Price	Unit (For Calculation Purposes)	Yearly Estimated Unit Qty	Discounted Unit Price	Item Total Cost
1	Compact Fluorescent	23 watts Screw-In CFL, T3, Medium Screw (E26), 1600 Lumens 4100k Bulb Color Temp.	Lumapro	12T274	12T274	\$2.57	1	\$2.57	25%	\$1.93	each	4	\$1.93	\$7.72
Vendor submitted or Equal	Compact Fluorescent	23 watts Screw-In CFL, T3, Medium Screw (E26), 1600 Lumens 4100k Bulb Color Temp.	EIKO GLOBAL LLC	SP23/41K	49326									
2	Compact Fluorescent	23 watts Screw-In CFL, T3, Medium Screw (E26), 1600 Lumens 2700k Bulb Color Temp.	GE Lighting	19RT47	FLE23HT3/2/827	\$2.57	1	\$2.57	25%	\$1.93	each	80	\$1.93	\$154.40
Vendor submitted or Equal	Compact Fluorescent	23 watts Screw-In CFL, T3, Medium Screw (E26), 1600 Lumens 2700k Bulb Color Temp.	EIKO GLOBAL LLC	SP23/27K	49325									
3	Compact Fluorescent	32 watts Plug-In CFL, T4 PL, 4-Pin (GX24Q-3), 2400 Lumens 3500K Bulb Color Temp.	GE Lighting	1PHA4	F32TBX/835/A/ECO	\$2.33	1	\$2.33	25%	\$1.75	each	110	\$1.75	\$192.50
Vendor submitted or Equal	Compact Fluorescent	32 watts Plug-In CFL, T4 PL, 4-Pin (GX24Q-3), 2400 Lumens 3500K Bulb Color Temp.	EIKO GLOBAL LLC	TT32/35	49273									
4	Compact Fluorescent	13.0 watts Screw-In CFL, T2, Medium Screw (E26), 800 Lumen 4100K Bulb Color Temp.	Lumapro	2CUT5	2CUT5	\$1.89	1	\$1.89	25%	\$1.42	each	320	\$1.42	\$454.40
Vendor submitted or Equal	Compact Fluorescent	13.0 watts Screw-In CFL, T2, Medium Screw (E26), 800 Lumen 4100K Bulb Color Temp.	EIKO GLOBAL LLC	SP13/41K	00033									
5	Compact Fluorescent	23 watts Screw-In CFL, T2, Medium Screw (E26), 1600 Lumen 4100K Bulb Color Temp.	Lumapro	2CUU1	2CUU1	\$2.57	1	\$2.57	25%	\$1.93	each	315	\$1.93	\$607.95
Vendor submitted or Equal	Compact Fluorescent	23 watts Screw-In CFL, T2, Medium Screw (E26), 1600 Lumen 4100K Bulb Color Temp.	EIKO GLOBAL LLC	SP23/41K	49326									
6	Compact Fluorescent	40 watts Screw-In CFL, T4, Medium Screw (E26), 2400 Lumen 4100K Bulb Color Temp.	Lumapro	2CUU4	2CUU4	\$4.85	1	\$4.85	25%	\$3.64	each	175	\$3.64	\$637.00

Lighting 18 - PRICING PAGE revised 02/16/2018

Vendor submitted or Equal	Compact Fluorescent	40 watts Screw-In CFL, T4, Medium Screw (E26), 2400 Lumen 4100K Bulb Color Temp.	EIKO GLOBAL LLC	SP42/41K	05422														
7	Compact Fluorescent	26 watts Plug-In CFL, T4PL, 2-Pin (G24D-3), 1500 Lume, 2700K Bulb Color Temp.	Lumapro	3EMW2	3EMW2	\$1.74	1	\$1.74	25%	\$1.31	each	105	\$1.31	\$137.55					
Vendor submitted or Equal	Compact Fluorescent	26 watts Plug-In CFL, T4PL, 2-Pin (G24D-3), 1500 Lume, 2700K Bulb Color Temp.	EIKO GLOBAL LLC	QT26/27	15568														
8	Compact Fluorescent	13.0 watts Plug-In CFL, T4PL, 4-Pin (2GX7), 800 Lumen, 4100K Bulb Color Temp.	Lumapro	3EMX9	3EMX9	\$1.90	1	\$1.90	25%	\$1.43	each	39	\$1.43	\$55.77					
Vendor submitted or Equal	Compact Fluorescent	13.0 watts Plug-In CFL, T4PL, 4-Pin (2GX7), 800 Lumen, 4100K Bulb Color Temp.	SYLVANIA LIGHTING	CF13DTAW/841/ECO	20894														
9	Compact Fluorescent	13.0 watts Screw-In CFL, T2, Medium Screw (E26), 800 Lumen, 6500K Bulb Color Temp.	Lumapro	3TFP5	3TFP5	\$1.90	1	\$1.90	25%	\$1.43	each	26	\$1.43	\$37.18					
Vendor submitted or Equal	Compact Fluorescent	13.0 watts Screw-In CFL, T2, Medium Screw (E26), 800 Lumen, 6500K Bulb Color Temp.	EIKO GLOBAL LLC	SP13/65K	06131														
II																			
16	Fluorescent Lamps	18 inch 15.0 watts Linear Fluorescent Lamp, T8, Medium Bi-Pin (G13), 825 Lumen, 4100K Bulb color Temp.	GE Lighting	1V173	F15T8/CW	\$1.29	1	\$1.29	25%	\$0.97	each	30	\$0.97	\$29.10					
Vendor submitted or Equal	Fluorescent Lamps	18 inch 15.0 watts Linear Fluorescent Lamp, T8, Medium Bi-Pin (G13), 825 Lumen, 4100K Bulb color Temp.	EIKO GLOBAL LLC	F15T8/CW	15521														
17	Fluorescent Lamps	48 inch 32 watts Linear Fluorescent Lamp, T8, Bi-Pin (G13), 2900 Lumen, 4100K Bulb Color Temp.	GE Lighting	4PL16	F32T8/SPP41/ECO	\$1.56	1	\$1.56	25%	\$1.17	each	5750	\$1.17	\$6,739.20					
Vendor submitted or Equal	Fluorescent Lamps	48 inch 32 watts Linear Fluorescent Lamp, T8, Bi-Pin (G13), 2900 Lumen, 4100K Bulb Color Temp.	EIKO GLOBAL LLC	F32T8/841K	49589														
18	Fluorescent Lamps	21-19/32 inch 14.0 watts Linear Fluorescent Lamp, T5, Miniature Bi-Pin (G5), 1350 Lumen	GE Lighting	5AE13	F14WT5/835/ECO	\$1.93	1	\$1.93	25%	\$1.45	each	80	\$1.45	\$116.00					
Vendor submitted or Equal	Fluorescent Lamps	21-19/32 inch 14.0 watts Linear Fluorescent Lamp, T5, Miniature Bi-Pin (G5), 1350 Lumen	EIKO GLOBAL LLC	F14T5/835	81147														
19	Fluorescent Lamps	32 watts U-Shaped Fluorescent Lamp, T8, Medium Bi-Pin (G13), 2800 Lumen, 3500K Bulb Color Temp.	Lumapro	5NPL5	5NPL5	\$5.53	1	\$5.53	25%	\$4.15	each	72	\$4.16	\$298.80					

Lighting 18 - PRICING PAGE revised 02/16/2018

Vendor submitted or Equal	Fluorescent Lamps	32 watts U-Shopped Fluorescent Lamp, T8, Medium Bi-Pin (G13), 2800 Lumen, 3500K Bulb Color Temp.	EIKO GLOBAL LLC	F32T8/835K/U6	02403									
20	Fluorescent Lamps	24 inch, 17.0 watts Linear Fluorescent Lamp, T8, Medium Bi-Pin (G13), 1325 Lumen, 4100K Bulb Color Temp.	GE Lighting	6XT99	F17T8/SP41/ECO	\$1.64	1	\$1.64	25%	\$1.23	each	145	\$1.23	\$178.35
Vendor submitted or Equal	Fluorescent Lamps	24 inch, 17.0 watts Linear Fluorescent Lamp, T8, Medium Bi-Pin (G13), 1325 Lumen, 4100K Bulb Color Temp.	EIKO GLOBAL LLC	F17T8/841K	49577									
21	Fluorescent Lamps	36 inch 25 watts Linear Fluorescent Lamp, T8, Medium Bi-Pin (G13), 2080 Lumen, 4100K Bulb Color Temp.	GE Lighting	6XV06	F25T8/SP41/ECO	\$2.14	1	\$2.14	25%	\$1.61	each	98	\$1.61	\$157.78
Vendor submitted or Equal	Fluorescent Lamps	36 inch 25 watts Linear Fluorescent Lamp, T8, Medium Bi-Pin (G13), 2080 Lumen, 4100K Bulb Color Temp.	EIKO GLOBAL LLC	F25T8/841K	49583									
22	Fluorescent Lamps	36 inch 30 watts Linear Fluorescent Lamp, T8, Medium Bi-Pin (G13), 2150 Lumen, 4100K Bulb Color Temp.	GE Lighting	4V439	F30T8/CW	\$2.14	1	\$2.14	25%	\$1.61	each	19	\$1.61	\$30.59
Vendor submitted or Equal	Fluorescent Lamps	36 inch 30 watts Linear Fluorescent Lamp, T8, Medium Bi-Pin (G13), 2150 Lumen, 4100K Bulb Color Temp.	EIKO GLOBAL LLC	F25T8/841K	49583									
23	Metal Halide	250 watts Metal Halide HID, BT28, Mogul Screw (EX39), 21,300 Lumen, 4000K Bulb Color Temp.	GE Lighting	2PB28	MPR250/VBU/O	\$9.36	1	\$9.36	25%	\$7.02	each	58	\$7.02	\$386.10
Vendor submitted or Equal	Metal Halide	250 watts Metal Halide HID, BT28, Mogul Screw (EX39), 21,300 Lumen, 4000K Bulb Color Temp.	EIKO GLOBAL LLC	MH250/U	49185									
24	Metal Halide	1000 watts Metal Halide HID, BT56, Mogul Screw (E39), 4000K Bulb Color Temp.	GE Lighting	2V659	MVR1000/U	\$22.01	1	\$22.01	25%	\$16.51	each	45	\$16.51	\$742.95
Vendor submitted or Equal	Metal Halide	1000 watts Metal Halide HID, BT56, Mogul Screw (E39), 4000K Bulb Color Temp.	EIKO GLOBAL LLC	MH1000/U	49199									
25	Metal Halide	70 watts Metal Halide HID, ED17, Medium Screw (E26), 5800 Lumen, 4200K Bulb Color Temp.	Lumapro	2YGD5	2YGD5	\$9.36	1	\$9.36	25%	\$7.02	each	30	\$7.02	\$210.60
Vendor submitted or Equal	Metal Halide	70 watts Metal Halide HID, ED17, Medium Screw (E26), 5800 Lumen, 4200K Bulb Color Temp.	EIKO GLOBAL LLC	MH70/U/MED	15410									
26	Metal Halide	1000 watts Metal Halide HID, BT37, Mogul Screw (E39), 110,000 Lumen, 4200K Bulb Color Temp.	Lumapro	2YGE1	2YGE1	\$21.96	1	\$21.96	25%	\$16.47	each	40	\$16.47	\$658.80

Lighting 18 - PRICING PAGE revised 02/16/2018

34	LED	14.0 watts LED Lamp, A21, Medium Screw (E26), 1100 Lumen, 2700K Bulb Color Temp	GE Lighting	32WX12	LED14DA21/827W	\$3.10	1	\$3.10	25%	\$2.33	each	92	\$2.33	\$214.36
Vendor submitted or Equal	LED	14.0 watts LED Lamp, A21, Medium Screw (E26), 1100 Lumen, 2700K Bulb Color Temp	EIKO GLOBAL LLC	LED15WA19/OMN/827	09885									
35	LED	11.0 watts LED Lamp, A19, Medium Screw (E26), 800 Lumen, 2700K Bulb Color Temp.	GE Lighting	32WX16	LED11DA19/827	\$1.85	1	\$1.85	25%	\$1.39	each	110	\$1.39	\$152.90
Vendor submitted or Equal	LED	11.0 watts LED Lamp, A19, Medium Screw (E26), 800 Lumen, 2700K Bulb Color Temp.	EIKO GLOBAL LLC	LED9.5WA19/OMN/827	09889									
V														
36	Incandescent	40 watts Incandescent Lamp, B10, Candelabra Screw (E12), 370 Lumens, 2500K Bulb Color Temp	GE Lighting	1E337	40BC	\$0.53	1	\$0.53	25%	\$0.40	each	220	\$0.40	\$88.00
Vendor submitted or Equal	Incandescent	40 watts Incandescent Lamp, B10, Candelabra Screw (E12), 370 Lumens, 2500K Bulb Color Temp	SYLVANIA LIGHTING	40B10C	13456									
37	Incandescent	25 watts Incandescent Lamp, CA10, Candelabra Screw (E12), 235 Lumens, 2500K Bulb Color Temp	GE Lighting	1E343	25CAC	\$0.53	1	\$0.53	25%	\$0.40	each	75	\$0.40	\$30.00
Vendor submitted or Equal	Incandescent	25 watts Incandescent Lamp, CA10, Candelabra Screw (E12), 235 Lumens, 2500K Bulb Color Temp	SYLVANIA LIGHTING	25B10C	13452									
38	Incandescent	40 watts Incandescent Lamp, A15, Medium Screw (E26), 415 Lumen, 2600K Bulb Color Temp.	GE Lighting	5V755	40A15CD	\$0.60	1	\$0.60	25%	\$0.45	each	24	\$0.45	\$10.80
Vendor submitted or Equal	Incandescent	40 watts Incandescent Lamp, A15, Medium Screw (E26), 415 Lumen, 2600K Bulb Color Temp.	SYLVANIA LIGHTING	40A15	10141									
39	Incandescent	6.0 watts Incandescent Lamp, S6, Candelabra Screw (E12), 50 Lumen, 2700K Bulb Color Temp.	GE Lighting	4V751	6S6-145V	\$0.40	1	\$0.40	25%	\$0.30	each	24	\$0.30	\$7.20
Vendor submitted or Equal	Incandescent	6.0 watts Incandescent Lamp, S6, Candelabra Screw (E12), 50 Lumen, 2700K Bulb Color Temp.	EIKO GLOBAL LLC	6S6/145V	40789									
40	Incandescent	40 watts Incandescent Lamp, B13, Medium Screw (E26), 485 Lumen, 2800K Bulb Color Temp.	GE Lighting	3VA55	40BFM/CD2	\$0.60	1	\$0.60	25%	\$0.45	each	250	\$0.45	\$112.50
Vendor submitted or Equal	Incandescent	40 watts Incandescent Lamp, B13, Medium Screw (E26), 485 Lumen, 2800K Bulb Color Temp.	SYLVANIA LIGHTING	40B13C	13367									
VI														

Lighting 18 - PRICING PAGE revised 02/16/2018

41	Halogen	250 watts Halogen Lamp, T4, Double Contact Bayonet (BA15d), 5000 Lumen, 2950K Bulb Color Temp.	GE Lighting	2V703	Q250CL/DC(ESS)-120V	\$1.86	1	\$1.86	25%	\$1.40	each	25	\$1.40	\$35.00
Vendor submitted or Equal	Halogen	250 watts Halogen Lamp, T4, Double Contact Bayonet (BA15d), 5000 Lumen, 2950K Bulb Color Temp.	EIKO GLOBAL LLC	Q250CL/DC-120V	49610									
42	Halogen	250 watts Halogen Lamp, T4, Double Contact Bayonet (BA15d), 5000 Lumen, 3000K Bulb Color Temp.	GE Lighting	5V053	Q250CL/DC-130V	\$1.86	1	\$1.86	25%	\$1.40	each	20	\$1.40	\$28.00
Vendor submitted or Equal	Halogen	250 watts Halogen Lamp, T4, Double Contact Bayonet (BA15d), 5000 Lumen, 3000K Bulb Color Temp.	EIKO GLOBAL LLC	Q250CL/DC-130V	15264									
46	High Pressure Sodium	70 watts High Pressure Sodium HID, ED23-1/2, Mogul Screw (E39), 6400 Lumen, 1900K Bulb Color Temp.	GE Lighting	2VAD4	LU70/H/ECO	\$5.97	1	\$5.97	25%	\$4.48	each	40	\$4.48	\$179.20
Vendor submitted or Equal	High Pressure Sodium	70 watts High Pressure Sodium HID, ED23-1/2, Mogul Screw (E39), 6400 Lumen, 1900K Bulb Color Temp.	EIKO GLOBAL LLC	LU70	15308									
47	High Pressure Sodium	1000 watts High Pressure Sodium HID, E25, Mogul Screw (E39), 130,000 Lumen, 2100K Bulb Color Temp.	GE Lighting	2V754	LU1000/ECO	\$27.09	1	\$27.09	25%	\$20.32	each	10	\$20.32	\$203.20
Vendor submitted or Equal	High Pressure Sodium	1000 watts High Pressure Sodium HID, E25, Mogul Screw (E39), 130,000 Lumen, 2100K Bulb Color Temp.	EIKO GLOBAL LLC	LU1000	15324									
48	High Pressure Sodium	150 watts High Pressure Sodium HID, ED17, Medium Screw (E26), 14,500 Lume, 2000K Bulb Color Temp.	Lumapro	2YGF8	2YGF8	\$6.50	1	\$6.50	25%	\$4.88	each	10	\$4.88	\$48.80
Vendor submitted or Equal	High Pressure Sodium	150 watts High Pressure Sodium HID, ED17, Medium Screw (E26), 14,500 Lume, 2000K Bulb Color Temp.	EIKO GLOBAL LLC	LU150/55/MED	15314									
49	High Pressure Sodium	400 watts High Pressure Sodium HID, ED18, Mogul Screw (E39), 51,000 Lumen, 2100K Bulb Color Temp.	GE Lighting	3APT6	LU400/H/ECO	\$7.10	1	\$7.10	25%	\$5.33	each	28	\$5.33	\$149.24

Lighting 18 - PRICING PAGE revised 02/16/2018

57	Ballast	High Pressure Sodium HID Ballast Kit, 250 Max. Lamp Watts, 120/208/240/277/480 V, Pulse Ballast Start	Lumapro	1XUF6	1XUF6	\$76.67	1	\$76.67	25%	\$57.50	each	28	\$57.50	\$1,495.00
Vendor submitted or Equal	Ballast	High Pressure Sodium HID Ballast Kit, 250 Max. Lamp Watts, 120/208/240/277/480 V, Pulse Ballast Start	SYLVANIA LIGHTING	LU250/SUPER 5-KIT	47634									
58	Ballast	High Pressure Sodium HID Ballast Kit, 1000 Max. Lamp Watts 120/208/240/277/480V, Pulse Start	Philips Advance	1FYE2	71A8753-001	\$131.80	1	\$131.80	25%	\$98.85	each	30	\$98.85	\$2,965.50
Vendor submitted or Equal	Ballast	High Pressure Sodium HID Ballast Kit, 1000 Max. Lamp Watts 120/208/240/277/480V, Pulse Start	SYLVANIA LIGHTING	LU1000/SUPER 5-KIT	47659									
													Total Bid Cost	\$24,458.46

List of Discount Percentages:		
(Use additional sheets if needed for number of discount percentages being offered.)		
	Category	DISCOUNT PERCENTAGE
I	Compact Fluorescent Lamps (CFL)	25%
II	Fluorescent Lamps	25%
III	Metal Halide Lamps	25%
IV	LED Lamps	25%
V	Incandescent	25%
VI	Halogen	25%
VII	High Pressure Sodium	25%
VIII	Ballast	25%



SP23/41K



Description 23W 120V 4100K Spiral Shaped
Ordering Code 49326
UNSPSC Code 39101619

Specifications

Voltage Rating	120
Watts	23
mA	380
Lumens per Watt	69
Base Type	Medium Screw (E26)
Bulb Type	T-2
MOL in/mm	4.88/124
MOD in/mm	2.13/54
Mercury Content (mg)	1.6
HG Form	amalgam
Approx initial Lumens	1600
Approx Mean Lumens	1600
CT deg K	4100
CRI	80
Rated Life	10,000
Special Desc	Not for use with dimmers, electronic timers, photocells, totally enclosed fixtures, motion/occupancy sensors, or where directly exposed to water.
Equivalent	100W Incandescent
Ambient Operating Temp Range	-18° C (0° F) to 50° C (122° F)
Approvals	cULus, IMERC, TCLP Compliant

watch > like > follow



selection. solutions. simplicity. eiko.com
 23220 W. 84th St, Shawnee, KS 66227 · (P) 1.800.852.2217 (F) 1.800.492.8975
 Canada: 81 King St, Barrie, ON L4N 6B5 · (P) 1.888.410.8151 (F) 1.888.705.1335



SP23/27K



Description 23W 120V 2700K Spiral Shaped
Ordering Code 49325
UNSPSC Code 39101619

Specifications

Voltage Rating	120
Watts	23
mA	380
Lumens per Watt	69
Base Type	Medium Screw (E26)
Bulb Type	T-2
MOL in/mm	4.88/124
MOD in/mm	2.13/54
Mercury Content (mg)	1.6
HG Form	amalgam
Approx Initial Lumens	1600
Approx Mean Lumens	1600
CT deg K	2700
CRI	80
Rated Life	10,000
Special Desc	Not for use with dimmers, electronic timers, photocells, totally enclosed fixtures, motion/occupancy sensors, or where directly exposed to water.
Equivalent	100W Incandescent
Ambient Operating Temp Range	-18° C (0° F) to 50° C (122° F)
Approvals	cULus, IMERC, TCLP Compliant

watch > like > follow



selection. solutions. simplicity. eiko.com

23220 W. 84th St, Shawnee, KS 66227 · (P) 1.800.852.2217 (F) 1.800.492.8975

Canada: 81 King St, Barrie, ON L4N 6B5 · (P) 1.888.410.8151 (F) 1.888.705.1335



TT32/35



Description 32W Triple-Tube 3500K GX24q-3 Base Fluorescent
Ordering Code 49273
UNSPSC Code 39101619

Specifications

Watts	32
Base Type	GX24q-3
Bulb Type	T-4
MOL in/mm	5.8/147
Mercury Content (mg)	2.2
HG Form	solid
Approx Initial Lumens	2200
Approx Mean Lumens	1870
CT deg K	3500
CRI	82
Rated Life	10,000
Approvals	IMERC, TCLP Compliant

watch > like > follow



selection. solutions. simplicity. eiko.com

23220 W. 84th St, Shawnee, KS 66227 · (P) 1.800.852.2217 (F) 1.800.492.8975

Canada: 81 King St, Barrie, ON L4N 6B5 · (P) 1.888.410.8151 (F) 1.888.705.1335



SP13/41K



Description 13W 120V 4100K Spiral Shaped
Ordering Code 00033
UNSPSC Code 39101619

Specifications

Voltage Rating	120
Watts	13
mA	210
Lumens per Watt	69
Base Type	Medium Screw (E26)
Bulb Type	T-2
MOL in/mm	4.13/105
MOD in/mm	1.81/46
Mercury Content (mg)	1.6
HG Form	amalgam
Approx Initial Lumens	900
Approx Mean Lumens	900
CT deg K	4100
CRI	80
Rated Life	10,000
Special Desc	Not for use with dimmers, electronic timers, photocells, or motion/occupancy sensors.
Equivalent	60W Incandescent
Ambient Operating Temp Range	-18° C (0° F) to 50° C (122° F)
Approvals	cULus, IMERC

watch > like > follow



selection. solutions. simplicity. eiko.com
 23220 W. 84th St, Shawnee, KS 66227 · (P) 1.800.852.2217 (F) 1.800.492.8975
 Canada: 81 King St, Barrie, ON L4N 6B5 · (P) 1.888.410.8151 (F) 1.888.705.1335



SP23/41K



Description 23W 120V 4100K Spiral Shaped
Ordering Code 49326
UNSPSC Code 39101619

Specifications

Voltage Rating	120
Watts	23
mA	380
Lumens per Watt	69
Base Type	Medium Screw (E26)
Bulb Type	T-2
MOL in/mm	4.88/124
MOD in/mm	2.13/54
Mercury Content (mg)	1.6
HG Form	amalgam
Approx Initial Lumens	1600
Approx Mean Lumens	1600
CT deg K	4100
CRI	80
Rated Life	10,000
Special Desc	Not for use with dimmers, electronic timers, photocells, totally enclosed fixtures, motion/occupancy sensors, or where directly exposed to water.
Equivalent	100W Incandescent
Ambient Operating Temp Range	-18° C (0° F) to 50° C (122° F)
Approvals	cULus, IMERC, TCLP Compliant

watch > like > follow



selection. solutions. simplicity. eiko.com

23220 W. 84th St, Shawnee, KS 66227 · (P) 1.800.852.2217 (F) 1.800.492.8975

Canada: 81 King St, Barrie, ON L4N 6B5 · (P) 1.888.410.8151 (F) 1.888.705.1335



SP42/41K



Description 42W 120V 4100K Spiral Shaped
Ordering Code 05422
UNSPSC Code 39101619

Specifications

Voltage Rating	120
Watts	40
mA	680
Lumens per Watt	65
Base Type	Medium Screw (E26)
Bulb Type	T-3
MOL in/mm	7.28/185
MOD in/mm	2.64/67
Mercury Content (mg)	3.2
HG Form	amalgam
Approx initial Lumens	2600
Approx Mean Lumens	2600
CT deg K	4100
CRI	80
Rated Life	10,000
Special Desc	Not for use with dimmers, electronic timers, photocells, or motion/occupancy sensors.
Equivalent	150W Incandescent
Ambient Operating Temp Range	-18° C (0° F) to 50° C (122° F)
Approvals	cULus, IMERC

watch > like > follow



selection. solutions. simplicity. eiko.com

23220 W. 84th St, Shawnee, KS 66227 · (P) 1.800.852.2217 (F) 1.800.492.8975

Canada: 81 King St, Barrie, ON L4N 6B5 · (P) 1.888.410.8151 (F) 1.888.705.1335



QT26/27



Description 2700K 26W Quad-Tube 2700K G24d3 Base Fluorescent
Ordering Code 15568
UNSPSC Code 39101619

Specifications

Voltage Rating	120
Watts	26
Base Type	G24d-3
Bulb Type	T-4
MOL in/mm	6.7/170
Mercury Content (mg)	2.2
HG Form	solid
Approx Initial Lumens	1710
Approx Mean Lumens	1460
CT deg K	2700
CRI	82
Rated Life	10,000
Approvals	IMERC, TCLP Compliant

watch > like > follow



selection. solutions. simplicity. eiko.com

23220 W. 84th St, Shawnee, KS 66227 · (P) 1.800.852.2217 (F) 1.800.492.8975

Canada: 81 King St, Barrie, ON L4N 6B5 · (P) 1.888.410.8151 (F) 1.888.705.1335



Product Number: 20894

Order Abbreviation: CF13DT/E/841/ECO

General Description: DULUX 13W triple compact fluorescent lamp with 4-pin base, 4100K color temperature, 82 CRI, for use with electronic and dimming ballasts, ECOLOGIC

Product Information

Abbrev. With Packaging Info.	CF13DTE841ECO 50/CS 1/SKU
Average Rated Life (hr)	12000
Base	GX24Q-1
Bulb	T4
Color Rendering Index (CRI)	82
Color Temperature/CCT (K)	4100
Diameter (in)	0.472
Diameter (mm)	12.00
Family Brand Name	Dulux® T/E
Industry Standards	IEC 60901- 3413
Initial Lumens at 25C	900
Mean Lumens at 25C	774
Maximum Overall Length - MOL (in)	4.2
Maximum Overall Length - MOL (mm)	106
NEMA Generic Designation (old)	CFM13W/GX24Q/841
Nominal Voltage (V)	77.00
Nominal Wattage (W)	13.00



Footnotes

- Minimum starting temperature is a function of the ballast; consult the ballast manufacturer.
- There is a NEMA supported, industry issue where T2, T4, and T5 fluorescent and compact fluorescent lamps operated on high frequency ballasts may experience an abnormal end-of-life phenomenon. This end-of-life phenomenon can result in one or both of the following: 1. Bulb wall cracking near the lamp base. 2. The lamp can overheat in the base area and possibly melt the base and socket. NEMA recommends that high frequency compact fluorescent ballasts have an end-of-life shutdown circuit which will safely and reliably shut down the system in the rare event of an abnormal end-of-life failure mode described above. The final requirements of this system are yet to be defined by ANSI. For additional information refer to NEMA papers on their WEBSITE at www.NEMA.org.
- Lumen output and life rated on high frequency operation.
- Rule of Thumb for Compact Fluorescent Lamps: Divide wattage of incandescent lamp by 4 to determine approximate wattage of compact fluorescent lamp that will provide similar light output.
- Approximate initial lumens after 100 hours operation.
- The life ratings of fluorescent lamps are based on 3 hr. operating cycles under specified conditions and with ballast meeting ANSI specifications. If operating cycle is increased, there will be a corresponding increase in the average hours life.
- Minimum starting temperature is a function of the ballast; consult the ballast manufacturer.



SP13/65K



Description 13W 120V 6500K Spiral Shaped
Ordering Code 06131
UNSPSC Code 39101619

Specifications

Voltage Rating	120
Watts	13
mA	210
Lumens per Watt	69
Base Type	Medium Screw (E26)
Bulb Type	T-2
MOL in/mm	4.13/105
MOD in/mm	1.81/46
Mercury Content (mg)	1.6
HG Form	amalgam
Approx Initial Lumens	900
Approx Mean Lumens	900
CT deg K	6500
CRI	80
Rated Life	10,000
Special Desc	Not for use with dimmers, electronic timers, photocells, or motion/occupancy sensors.
Equivalent	60W Incandescent
Ambient Operating Temp Range	-18° C (0° F) to 50° C (122° F)
Approvals	cULus, IMERC

watch > like > follow



selection. solutions. simplicity. eiko.com

23220 W. 84th St, Shawnee, KS 66227 · (P) 1.800.852.2217 (F) 1.800.492.8975

Canada: 81 King St, Barrie, ON L4N 6B5 · (P) 1.888.410.8151 (F) 1.888.705.1335



F15T8/CW



Description 15W Cool White 4100K T-8 G13 Base
Ordering Code 15521
UNSPSC Code 39101605

Specifications

Watts	15
Base Type	G13
Bulb Type	T-8
MOL in/mm	18.0/457
MOD in/mm	1.0/26
Mercury Content (mg)	2.75
HG Form	amalgam
Lumens	825
Approx Initial Lumens	825
Approx Mean Lumens	725
CT deg K	4100
CRI	60
Rated Life	7,500
Special Desc	Cool White, Preheat
Approvals	IMERC, TCLP Compliant

watch > like > follow



selection. solutions. simplicity. eiko.com
 23220 W. 84th St, Shawnee, KS 66227 · (P) 1.800.852.2217 (F) 1.800.492.8975
 Canada: 81 King St, Barrie, ON L4N 6B5 · (P) 1.888.410.8151 (F) 1.888.705.1335



F32T8/841K



Description 32W Universal Start 4100K 85 CRI T-8 Medium Bi-pin
Ordering Code 49589
UNSPSC Code 39101605

Specifications

Watts	32
Base Type	G13
Bulb Type	T-8
MOL in/mm	48.0/1219
Length	4'
MOD in/mm	1.0/26
Mercury Content (mg)	3
HG Form	solid
Approx Initial Lumens	2950
Approx Mean Lumens	2800
CT deg K	4100
CRI	85
Avg Life 3 HR Inst Start	24,000
Avg Life 3 HR Prog Start	30,000
Avg Life 12 HR Inst Start	30,000
Avg Life 12 HR Prog Start	36,000
Special Desc	Three Phosphor, Universal Start
Approvals	IMERC, TCLP Compliant

watch > like > follow



selection. solutions. simplicity. eiko.com
 23220 W. 84th St, Shawnee, KS 66227 · (P) 1.800.852.2217 (F) 1.800.492.8975
 Canada: 81 King St, Barrie, ON L4N 6B5 · (P) 1.888.410.8151 (F) 1.888.705.1335



F14T5/835

Description 14W 3500K T5 85 CRI G5 Base
Ordering Code 81147
UNSPSC Code 39101605



Specifications

Watts	14
Base Type	G5
Bulb Type	T-5
MOL in/mm	22/559
Mercury Content (mg)	2.7
HG Form	solid
Approx Initial Lumens	1350
Approx Mean Lumens	1256
CT deg K	3500
CRI	85
Avg Life 3 HR Inst Start	25,000
Avg Life 12 HR Prog Start	35,000
Special Desc	Programmed Start
Approvals	IMERC, TCLP Compliant

watch > like > follow



selection. solutions. simplicity. eiko.com

23220 W. 84th St, Shawnee, KS 66227 · (P) 1.800.852.2217 (F) 1.800.492.8975

Canada: 81 King St, Barrie, ON L4N 6B5 · (P) 1.888.410.8151 (F) 1.888.705.1335



F32T8/835K/U6



Description 32W 3500K T8 85 CRI Medium Bi-Pin U-Bent 6 inch
Spacer

Ordering Code 02403

UNSPSC Code 39101605

Specifications

Watts	32
Base Type	G13
Bulb Type	T-8
MOL in/mm	22.5/571
Length	2'
MOD in/mm	1.0/26
Mercury Content (mg)	7.5
HG Form	solid
Approx Initial Lumens	2800
Approx Mean Lumens	2535
CT deg K	3500
CRI	85
Rated Life	20,000
Special Desc	U-Bend 6 inch centers, Universal Start
Approvals	IMERC, TCLP Compliant

watch > like > follow



selection. solutions. simplicity. eiko.com
 23220 W. 84th St, Shawnee, KS 66227 · (P) 1.800.852.2217 (F) 1.800.492.8975
 Canada: 81 King St, Barrie, ON L4N 6B5 · (P) 1.888.410.8151 (F) 1.888.705.1335



F17T8/841K



Description 17W Universal Start 4100K 85 CRI T-8 Medium Bi-pin
Ordering Code 49577
UNSPSC Code 39101605

Specifications

Watts	17
Base Type	G13
Bulb Type	T-8
MOL in/mm	24.0/610
Length	2'
MOD in/mm	1.0/26
Mercury Content (mg)	3
HG Form	solid
Approx Initial Lumens	1400
Approx Mean Lumens	1300
CT deg K	4100
CRI	85
Avg Life 3 HR Inst Start	20,000
Avg Life 12 HR Prog Start	25,000
Special Desc	Three Phosphor, Universal Start
Approvals	IMERC, TCLP Compliant

watch > like > follow



selection. solutions. simplicity. eiko.com
 23220 W. 84th St, Shawnee, KS 66227 • (P) 1.800.852.2217 (F) 1.800.492.8975
 Canada: 81 King St, Barrie, ON L4N 6B5 • (P) 1.888.410.8151 (F) 1.888.705.1335



F25T8/841K



Description 25W Universal Start 4100K 85 CRI T-8 Medium Bi-pin
Ordering Code 49583
UNSPSC Code 39101605

Specifications

Watts	25
Base Type	G13
Bulb Type	T-8
MOL in/mm	36.0/915
Length	3'
MOD in/mm	1.0/26
Mercury Content (mg)	3
HG Form	solid
Approx Initial Lumens	2225
Approx Mean Lumens	2050
CT deg K	4100
CRI	85
Avg Life 3 HR Inst Start	20,000
Avg Life 12 HR Prog Start	25,000
Special Desc	Three Phosphor, Universal Start
Approvals	IMERC, TCLP Compliant

watch > like > follow



selection. solutions. simplicity. eiko.com

23220 W. 84th St, Shawnee, KS 66227 · (P) 1.800.852.2217 (F) 1.800.492.8975

Canada: 81 King St, Barrie, ON L4N 6B5 · (P) 1.888.410.8151 (F) 1.888.705.1335



F25T8/841K



Description 25W Universal Start 4100K 85 CRI T-8 Medium Bi-pin
Ordering Code 49583
UNSPSC Code 39101605

Specifications

Watts	25
Base Type	G13
Bulb Type	T-8
MOL in/mm	36.0/915
Length	3'
MOD in/mm	1.0/26
Mercury Content (mg)	3
HG Form	solid
Approx Initial Lumens	2225
Approx Mean Lumens	2050
CT deg K	4100
CRI	85
Avg Life 3 HR Inst Start	20,000
Avg Life 12 HR Prog Start	25,000
Special Desc	Three Phosphor, Universal Start
Approvals	IMERC, TCLP Compliant

watch > like > follow



selection. solutions. simplicity. eiko.com
 23220 W. 84th St, Shawnee, KS 66227 · (P) 1.800.852.2217 (F) 1.800.492.8975
 Canada: 81 King St, Barrie, ON L4N 6B5 · (P) 1.888.410.8151 (F) 1.888.705.1335



MH250/U

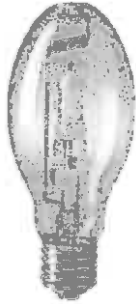

Description 250W ED-28 Mogul Base Universal Burn
Ordering Code 49195
UNSPSC Code 39101614

Specifications

Watts	250
Base Type	Mogul Screw (E39)
Bulb Type	ED-28
MOL in/mm	8.3/211.2
MOD in/mm	3.54/90.0
LCL in/mm	5.00/127.0
Mercury Content (mg)	30
HG Form	liquid
Approx Initial Lumens	21000
Approx Mean Lumens	13700
CT deg K	4000
CRI	70
Rated Life	10,000
Common Code	MVR250/U
ANSI Ballast	M58
Fixt Rqmt	Enclosed
Burning Position	Universal
Special Desc	Probe Start
Coating	Clear
Approvals	IMERC

watch > like > follow



selection. solutions. simplicity. eiko.com
 23220 W. 84th St, Shawnee, KS 66227 · (P) 1.800.852.2217 (F) 1.800.492.8975
 Canada: 81 King St, Barrie, ON L4N 6B5 · (P) 1.888.410.8151 (F) 1.888.705.1335



MH1000/U

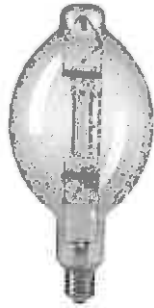

Description 1000W BT-56 Mogul Base Universal Burn
Ordering Code 49199
UNSPSC Code 39101614

Specifications

Watts	1000
Base Type	Mogul Screw (E39)
Bulb Type	BT-56
MOL in/mm	15.5/393.7
MOD in/mm	7.09/180
LCL in/mm	9.50/241.0
Mercury Content (mg)	82.5
HG Form	liquid
Approx Initial Lumens	110000
Approx Mean Lumens	71000
CT deg K	4000
CRI	70
Rated Life	12,000
Common Code	MVR1000/U
ANSI Ballast	M47
Fixt Rqmt	Enclosed
Burning Position	Universal
Special Desc	Probe Start
Coating	Clear
Approvals	IMERC

watch > like > follow



selection. solutions. simplicity. eiko.com
 23220 W. 84th St, Shawnee, KS 66227 · (P) 1.800.852.2217 (F) 1.800.492.8975
 Canada: 81 King St, Barrie, ON L4N 6B5 · (P) 1.888.410.8151 (F) 1.888.705.1335



MH70/U/MED



Description 70W ED-17 Medium Base Pulse Start Universal Burn
Ordering Code 15410
UNSPSC Code 39101614

Specifications

Watts	70
Base Type	Medium Screw (E26)
Bulb Type	ED-17
MOL in/mm	5.50/139.7
MOD In/mm	2.13/54.0
LCL in/mm	3.44/87.3
Mercury Content (mg)	10.8
HG Form	liquid
Approx Initial Lumens	5600
Approx Mean Lumens	3600
CT deg K	4000
CRI	70
Rated Life	15,000
Common Code	MVR70/U/MED
ANSI Ballast	M98
Fixt Rqmt	Enclosed
Burning Position	Universal
Special Desc	Pulse Start
Coating	Clear
Approvals	IMERC

watch > like > follow



selection. solutions. simplicity. eiko.com

23220 W. 84th St, Shawnee, KS 66227 · (P) 1.800.852.2217 (F) 1.800.492.8975

Canada: 81 King St, Barrie, ON L4N 6B5 · (P) 1.888.410.8151 (F) 1.888.705.1335



MH1000/U/BT37



Description 1000W BT37 Reduced Jacket Mogul Base Universal Burn
Ordering Code 49557
UNSPSC Code 39101614

Specifications

Watts	1000
Base Type	Mogul Screw (E39)
Bulb Type	BT-37
MOL in/mm	11.5/292.1
LCL in/mm	7.00/178.0
Mercury Content (mg)	82.5
HG Form	liquid
Approx Initial Lumens	110000
Approx Mean Lumens	71000
CT deg K	4000
CRI	65
Rated Life	12,000
Common Code	MVR1000/U/BT37
ANSI Ballast	M47
Fixt Rqmt	Enclosed
Burning Position	Universal
Special Desc	Probe Start
Coating	Clear
Approvals	IMERC

watch > like > follow



selection. solutions. simplicity. eiko.com
 23220 W. 84th St, Shawnee, KS 66227 · (P) 1.800.852.2217 (F) 1.800.492.8975
 Canada: 81 King St, Barrie, ON L4N 6B5 · (P) 1.888.410.8151 (F) 1.888.705.1335



MH175/U

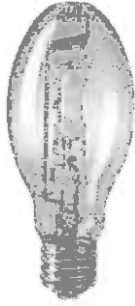

Description 175W ED-28 Mogul Base Universal Burn
Ordering Code 49193
UNSPSC Code 39101614

Specifications

Watts	175
Base Type	Mogul Screw (E39)
Bulb Type	ED-28
MOL in/mm	8.3/211.2
MOD in/mm	3.54/90.0
LCL in/mm	5.00/127.0
Mercury Content (mg)	21
HG Form	liquid
Approx Initial Lumens	14000
Approx Mean Lumens	9100
CT deg K	4000
CRI	70
Rated Life	10,000
Common Code	MVR175/U
ANSI Ballast	M57/M107
Fixt Rqmt	Enclosed
Burning Position	Universal
Special Desc	Probe Start
Coating	Clear
Approvals	IMERC

watch > like > follow



selection. solutions. simplicity. eiko.com
 23220 W. 84th St, Shawnee, KS 66227 · (P) 1.800.852.2217 (F) 1.800.492.8975
 Canada: 81 King St, Barrie, ON L4N 6B5 · (P) 1.888.410.8151 (F) 1.888.705.1335



MH400/U



Description 400W ED-37 Mogul Base Universal Burn
Ordering Code 49197
UNSPSC Code 39101614

Specifications

Watts	400
Base Type	Mogul Screw (E39)
Bulb Type	ED-37
MOL in/mm	11.5/292.1
MOD in/mm	4.65/118.0
LCL in/mm	7.00/178.0
Mercury Content (mg)	55
HG Form	liquid
Approx Initial Lumens	36000
Approx Mean Lumens	23000
CT deg K	4000
CRI	70
Rated Life	20,000
Common Code	MVR400/U
ANSI Ballast	M59
Fixt Rqmt	Enclosed
Burning Position	Universal
Special Desc	Probe Start
Coating	Clear
Approvals	IMERC

watch > like > follow



selection. solutions. simplicity. eiko.com

23220 W. 84th St, Shawnee, KS 66227 · (P) 1.800.852.2217 (F) 1.800.492.8975

Canada: 81 King St, Barrie, ON L4N 6B5 · (P) 1.888.410.8151 (F) 1.888.705.1335



MH175/U/MED



Description 175W ED-17 Medium Base Universal Burn
Ordering Code 15414
UNSPSC Code 39101614

Specifications

Watts	175
Base Type	Medium Screw (E26)
Bulb Type	ED-17
MOL in/mm	5.50/139.7
MOD in/mm	2.13/54.0
LCL in/mm	3.44/87.3
Mercury Content (mg)	21
HG Form	liquid
Approx Initial Lumens	14000
Approx Mean Lumens	9100
CT deg K	4000
CRI	70
Rated Life	10,000
Common Code	MVR175/U/MED
ANSI Ballast	M57/M107
Fixt Rqmt	Enclosed
Burning Position	Universal
Special Desc	Probe Start
Coating	Clear
Approvals	IMERC

watch > like > follow



selection. solutions. simplicity. eiko.com
 23220 W. 84th St, Shawnee, KS 66227 · (P) 1.800.852.2217 (F) 1.800.492.8975
 Canada: 81 King St, Barrie, ON L4N 6B5 · (P) 1.888.410.8151 (F) 1.888.705.1335



LED20WPAR38/FL/840K-DIM-G6



Description LED Litespan PAR38, Flood 45 Deg Beam 20W-1700lm Dim, 4000K 80+CRI, 120V E26

Ordering Code 09172

UNSPSC Code 39101628

Specifications

Voltage Rating	120
Watts	20
Amps	0.18
mA	180
Lumens per Watt	85
Base Type	Medium Screw (E26)
Bulb Type	PAR 38
MOL in/mm	5.16/131
MOD in/mm	4.72/120
Lumens	1700
CT deg K	4000
CRI	80+
Beam Angle	45°
Rated Life	25000
Design Life	25000
Replaces	LED17WPAR38/FL/840K-DIM-G4A
Equivalent	150W Halogen
Ambient Operating Temp Range	-20° C (-4° F) to 40° C (104° F)
Approvals	cULus, Energy Star, RoHS Compliant

watch > like > follow



selection. solutions. simplicity. eiko.com

23220 W. 84th St, Shawnee, KS 66227 · (P) 1.800.852.2217 (F) 1.800.492.8975

Canada: 81 King St, Barrie, ON L4N 6B5 · (P) 1.888.410.8151 (F) 1.888.705.1335



LED7WMR16/FL/827-DIM-G7



Description LED MR16 FLOOD 40 DEGREE BEAM 7W-500LM
DIMMABLE 2700K 80CRI 12V

Ordering Code 09493

UNSPSC Code 39101628

Specifications

Voltage Rating	12
Watts	7
Lumens per Watt	71
Base Type	GU5.3
Bulb Type	MR16
MOL in/mm	2.06/52.2
MOD in/mm	1.97/50
Lumens	500
CT deg K	2700
CRI	80
Beam Angle	40°
Rated Life	25000
Equivalent	50W Incandescent
Approvals	cULus, Energy Star

watch > like > follow



selection. solutions. simplicity. eiko.com
 23220 W. 84th St, Shawnee, KS 66227 · (P) 1.800.852.2217 (F) 1.800.492.8975
 Canada: 81 King St, Barrie, ON L4N 6B5 · (P) 1.888.410.8151 (F) 1.888.705.1335



LED7WMR16/FL/827-DIM-G7



Description LED MR16 FLOOD 40 DEGREE BEAM 7W-500LM
DIMMABLE 2700K 80CRI 12V

Ordering Code 09493

UNSPSC Code 39101628

Specifications

Voltage Rating	12
Watts	7
Lumens per Watt	71
Base Type	GU5.3
Bulb Type	MR16
MOL in/mm	2.06/52.2
MOD in/mm	1.97/50
Lumens	500
CT deg K	2700
CRI	80
Beam Angle	40°
Rated Life	25000
Equivalent	50W Incandescent
Approvals	cULus, Energy Star

watch > like > follow



selection. solutions. simplicity. eiko.com
 23220 W. 84th St, Shawnee, KS 66227 · (P) 1.800.852.2217 (F) 1.800.492.8975
 Canada: 81 King St, Barrie, ON L4N 6B5 · (P) 1.888.410.8151 (F) 1.888.705.1335



LED15WA19/OMN/827-DIM-G8



Description LED Litespan A19 Omni-directional 15W-1600lm DIM ENCLOSED 80CRI 2700K E26 120VAC

Ordering Code 09886

UNSPSC Code 39101628

Specifications

Voltage Rating	120
Voltage Type	AC
Watts	15
Lumens per Watt	106
Base Type	Medium Screw (E26)
Bulb Type	A-19
MOL in/mm	4.61/117
MOD in/mm	2.36/60
Lumens	1600
CT deg K	2700
CRI	80+
Beam Angle	240°
Rated Life	25000
Equivalent	100W Incandescent
Ambient Operating Temp Range	-20° C (-4° F) to 40° C (104° F)
Approvals	cULus, FCC

watch > like > follow



selection. solutions. simplicity. eiko.com
 23220 W. 84th St, Shawnee, KS 66227 · (P) 1.800.852.2217 (F) 1.800.492.8975
 Canada: 81 King St, Barrie, ON L4N 6B5 · (P) 1.888.410.8151 (F) 1.888.705.1335



LED11WA19/OMN/827-DIM-G8



Description LED Litespan A19 Omni-directional 11W-1100lm DIM
ENCLOSED 80CRI 2700K E26 120VAC

Ordering Code 09885

UNSPSC Code 39101628

Specifications

Voltage Rating	120
Voltage Type	AC
Watts	11
Lumens per Watt	100
Base Type	Medium Screw (E26)
Bulb Type	A-19
MOL in/mm	4.33/110
MOD in/mm	2.36/60
Lumens	1100
CT deg K	2700
CRI	80
Beam Angle	220°
Rated Life	25000
Equivalent	75W Incandescent
Ambient Operating Temp Range	-20° C (-4° F) to 45° C (113° F)
Approvals	cULus, FCC

watch > like > follow



selection. solutions. simplicity. eiko.com
 23220 W. 84th St, Shawnee, KS 66227 · (P) 1.800.852.2217 (F) 1.800.492.8975
 Canada: 81 King St, Barrie, ON L4N 6B5 · (P) 1.888.410.8151 (F) 1.888.705.1335



LED9.5WA19/OMN/827-G8



Description LED A19 9.5W-800LM NON-DIM 80CRI 2700K E26 120V
Ordering Code 09889
UNSPSC Code 39101628

Specifications

Voltage Rating	120
Voltage Type	AC
Watts	9.5
Lumens per Watt	84
Base Type	Medium Screw (E26)
Bulb Type	A-19
MOL in/mm	4.33/110
MOD in/mm	2.36/60
Lumens	800
CT deg K	2700
CRI	80
Beam Angle	220°
Rated Life	15000
Equivalent	60W Incandescent
Ambient Operating Temp Range	-20° C (-4° F) to 45° C (113° F)
Approvals	cULus, FCC

watch > like > follow



selection. solutions. simplicity. eiko.com
 23220 W. 84th St, Shawnee, KS 66227 · (P) 1.800.852.2217 (F) 1.800.492.8975
 Canada: 81 King St, Barrie, ON L4N 6B5 · (P) 1.888.410.8151 (F) 1.888.705.1335



Product Number: 13456

Order Abbreviation: 40B10C/BL/2PK 120V

General Description: Incandescent B10 Décor Bulb Shape Clear Finish Candelabra Base 40Watt 120Volt Blister Pack 12Bulbs Per Case 2Bulbs Per Package

Product Information

Abbrev. With Packaging Info.	40B10CBL2PK 120V 12/CS 2/SKU
Average Rated Life (hr)	1500
Base	Candelabra
Bulb	B10
Class	C (gas)
Color Rendering Index (CRI)	100
Color Temperature/CCT (K)	2850
Diameter (in)	1.250
Diameter (mm)	31.75
Filament	C-7A
Lamp Finish	Clear
Maximum Overall Length - MOL (in)	3.875
Maximum Overall Length - MOL (mm)	98.425
Nominal Voltage (V)	120.00
Nominal Wattage (W)	40.00



ECOLOGIC
™



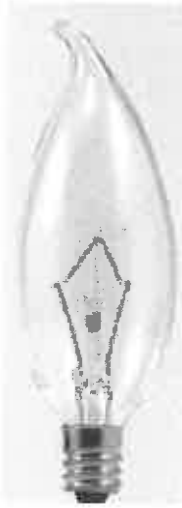

Product Number: 13452

Order Abbreviation: 25B10C/BL/2PK 120V

General Description: Incandescent B10 Décor Bulb Shape Clear Finish Candelabra Base 25Watt 120Volt Blister Pack 12Bulbs Per Case 2Bulbs Per Package

Product Information

Abbrev. With Packaging Info.	25B10CBL2PK 120V 12/CS 2/SKU
Average Rated Life (hr)	1500
Base	Candelabra
Bulb	B10
Class	C (gas)
Color Rendering Index (CRI)	100
Color Temperature/CCT (K)	2850
Diameter (in)	1.250
Diameter (mm)	31.75
Filament	C-7A
Lamp Finish	Clear
Maximum Overall Length - MOL (in)	3.875
Maximum Overall Length - MOL (mm)	98.425
Nominal Voltage (V)	120.00
Nominal Wattage (W)	25.00



ECOLOGIC
™





Product Number: 10141

Order Abbreviation: 40A15/2PK/RP 120V

General Description: Incandescent A15 Bulb Shape Appliance Clear Medium Aluminum Base 40Watt 120Volt Retail Pack 24Bulbs Per Case 2Bulbs Per Package

Product Information

Abbrev. With Packaging Info.	40A152PKRP 120V 24/CS 2/SKU
Approx. Lumens	430
Average Rated Life (hr)	1000
Base	Medium
Bulb	A15
Class	C (gas)
Color Rendering Index (CRI)	100
Color Temperature/CCT (K)	2850
Diameter (in)	1.875
Diameter (mm)	47.62
Filament	C-9
Lamp Finish	Clear
Light Center Length - LCL (in)	2.375
Light Center Length - LCL (mm)	60
Maximum Overall Length - MOL (in)	3.500
Maximum Overall Length - MOL (mm)	88.9
Nominal Voltage (V)	120.00
Nominal Wattage (W)	40.00



Footnotes

- Rated for oven use.



6S6/145V



Description 145V 6W S-6 Candelabra Base
Ordering Code 40789
UNSPSC Code 39101622

Specifications

Voltage Rating	145
Watts	6
Amps	0.041
Base Type	Candelabra Screw (E12)
Bulb Type	S-6
Filament	C-7A
MOL in/mm	1.88/47.8
MOD in/mm	0.75/19.1
Lumens	17.60
Rated Life	1,500
Coating	Clear

watch > like > follow



selection. solutions. simplicity. eiko.com
 23220 W. 84th St, Shawnee, KS 66227 · (P) 1.800.852.2217 (F) 1.800.492.8975
 Canada: 81 King St, Barrie, ON L4N 6B5 · (P) 1.888.410.8151 (F) 1.888.705.1335



Product Number: 13367

Order Abbreviation: 40B13/FAN/BL/2PK 120V

General Description: Incandescent 40W B13 medium base fan lamp 2/SKU 12/Case

Product information

Abbrev. With Packaging Info.	40B13FANBL2PK 120V 12/CS 2/SKU
Approx. Lumens	455
Average Rated Life (hr)	1500
Base	Medium
Bulb	B13
Class	C (gas)
Diameter (in)	1.614
Diameter (mm)	41.00
Filament	C-9
Lamp Finish	Clear
Maximum Overall Length - MOL (in)	4.625
Maximum Overall Length - MOL (mm)	118
Nominal Voltage (V)	120.00
Nominal Wattage (W)	40.00





Q250CL/DC-120V



Description 120V 250W T4-1/4 DC Bayonet Base (ESS)
Ordering Code 49610
UNSPSC Code 39101601

Specifications

Voltage Rating	120
Watts	250
Amps	2.08
Base Type	DC Bayonet (BA15d)
Bulb Type	T-4 1/4
Filament	CC-8
MOL in/mm	2.56/65
MOD in/mm	0.53/13.5
LCL in/mm	1.57/40
Lumens	5000
CT deg K	3000
Rated Life	2,000
Common Code	Q250CL/DC
ANSI Code	ESS
Type Use	S/S
Poss Sub	ETB

watch > like > follow



selection. solutions. simplicity. eiko.com
 23220 W. 84th St, Shawnee, KS 66227 · (P) 1.800.852.2217 (F) 1.800.492.8975
 Canada: 81 King St, Barrie, ON L4N 6B5 · (P) 1.888.410.8151 (F) 1.888.705.1335



Q250CL/DC-130V



Description 130V 250W T-4 DC Bayonet Base
Ordering Code 15264
UNSPSC Code 39101601

Specifications

Voltage Rating	130
Watts	250
Base Type	DC Bayonet (BA15d)
Bulb Type	T-4
Filament	CC-8
MOL in/mm	3.00/76.2
MOD in/mm	0.52/13.0
LCL in/mm	1.62/41.0
Lumens	5000
CT deg K	3000
Rated Life	2,000
Type Use	General

watch > like > follow



selection. solutions. simplicity. eiko.com
 23220 W. 84th St, Shawnee, KS 66227 · (P) 1.800.852.2217 (F) 1.800.492.8975
 Canada: 81 King St, Barrie, ON L4N 6B5 · (P) 1.888.410.8151 (F) 1.888.705.1335



LU70



Description ****2BD** 70W HPS ED23-1/2 Mogul Base**
Ordering Code **15308**
UNSPSC Code **39101617**

Specifications

Voltage Rating	52
Watts	70
Base Type	Mogul Screw (E39)
Bulb Type	ED-23.5
MOL in/mm	7.75/196.9
MOD in/mm	2.91/74.0
LCL in/mm	5.00/127.0
Mercury Content (mg)	3.75
HG Form	liquid
Approx Initial Lumens	6300
Approx Mean Lumens	5670
CT deg K	2100
CRI	21
Rated Life	24,000
Common Code	C70862
ANSI Ballast	S62
Fixt Rqmt	Open
Burning Position	Universal
Coating	Clear
Approvals	IMERC, TCLP Compliant

watch > like > follow



selection. solutions. simplicity. eiko.com
 23220 W. 84th St, Shawnee, KS 66227 · (P) 1.800.852.2217 (F) 1.800.492.8975
 Canada: 81 King St, Barrie, ON L4N 6B5 · (P) 1.888.410.8151 (F) 1.888.705.1335



LU1000



Description 1000W HPS ED-25 Mogul Base
Ordering Code 15324
UNSPSC Code 39101617

Specifications

Voltage Rating	250
Watts	1000
Base Type	Mogul Screw (E39)
Bulb Type	E-25
MOL in/mm	15.06/382.6
MOD in/mm	3.11/79.0
LCL in/mm	8.75/222.3
Mercury Content (mg)	12.5
HG Form	liquid
Approx Initial Lumens	140000
Approx Mean Lumens	126000
CT deg K	2100
CRI	21
Rated Life	24,000
Common Code	C1000S52
ANSI Ballast	S52
Fixt Rqmt	Open
Burning Position	Universal
Coating	Clear
Approvals	IMERC, TCLP Compliant

watch > like > follow



selection. solutions. simplicity. eiko.com

23220 W. 84th St, Shawnee, KS 66227 • (P) 1.800.852.2217 (F) 1.800.492.8975

Canada: 81 King St, Barrie, ON L4N 6B5 • (P) 1.888.410.8151 (F) 1.888.705.1335



LU150/55/MED



Description 150W HPS ED-17 Medium Base
Ordering Code 15314
UNSPSC Code 39101617

Specifications

Voltage Rating	55
Watts	150
Base Type	Medium Screw (E26)
Bulb Type	ED-17
MOL in/mm	5.44/138.0
MOD in/mm	2.17/55.0
LCL in/mm	3.50/88.9
Mercury Content (mg)	6.25
HG Form	liquid
Approx Initial Lumens	16000
Approx Mean Lumens	14400
CT deg K	2100
CRI	21
Rated Life	24,000
Common Code	C150S55/M
ANSI Ballast	S55
Fixt Rqmt	Open
Burning Position	Universal
Coating	Clear
Approvals	IMERC, TCLP Compliant

watch > like > follow



selection. solutions. simplicity. eiko.com
 23220 W. 84th St, Shawnee, KS 66227 · (P) 1.800.852.2217 (F) 1.800.492.8975
 Canada: 81 King St, Barrie, ON L4N 6B5 · (P) 1.888.410.8151 (F) 1.888.705.1335



LU400



Description 400W HPS ED-18 Mogul Base
Ordering Code 15322
UNSPSC Code 39101617

Specifications

Voltage Rating	100
Watts	400
Base Type	Mogul Screw (E39)
Bulb Type	ED-18
MOL in/mm	9.75/247.6
MOD in/mm	2.28/58.0
LCL in/mm	5.75/146.0
Mercury Content (mg)	12.5
HG Form	liquid
Approx Initial Lumens	50000
Approx Mean Lumens	45000
CT deg K	2100
CRI	21
Rated Life	24,000
Common Code	C400S51
ANSI Ballast	S51
Fixt Rqmt	Open
Burning Position	Universal
Coating	Clear
Approvals	IMERC, TCLP Compliant

watch > like > follow



selection. solutions. simplicity. eiko.com
 23220 W. 84th St, Shawnee, KS 66227 · (P) 1.800.852.2217 (F) 1.800.492.8975
 Canada: 81 King St, Barrie, ON L4N 6B5 · (P) 1.888.410.8151 (F) 1.888.705.1335



PM-2X32T8-UNV-IS



Description Instant Start Fluorescent Lamp Ballast 2x17W 25W 32W
120-277VAC

Ordering Code 07825

UNSPSC Code 39101901

Specifications

Voltage Rating	120-277
Voltage Type	AC
Approvals	cULus

watch > like > follow



selection. solutions. simplicity. eiko.com
 23220 W. 84th St, Shawnee, KS 66227 · (P) 1.800.852.2217 (F) 1.800.492.8975
 Canada: 81 King St, Barrie, ON L4N 6B5 · (P) 1.888.410.8151 (F) 1.888.705.1335



CERTIFIED GREEN

PM-2X32T8-UNV-IS

PowerMaster™ T8 Ballast

CEE

(07825)

PowerMaster™

RoHS Compliant



PRODUCT FEATURES

STARTING METHOD: Instant	INPUT VOLTAGE: 120-277VAC ± 10%	POWER FACTOR: High	WARRANTY: 5 Years
LAMP CONNECTION: Parallel	INPUT FREQUENCY: 50/60 Hz	BALLAST FACTOR: Normal	CEE Specified

- Sound Rated: A
- Minimum Starting Temperature: 0°F, -18°C
- Maximum Case Temperature: 167°F, 75°C
- Meets FCC Part 18 (Class B) Consumer Limits
- Transient Protection Meets ANSI/IEEE62.41 Cat. A
- Ballast frequency for all listed lamps: > 40KHz-52KHz

ELECTRICAL SPECIFICATIONS

LAMP TYPE	NO. OF LAMPS	INPUT VOLTS	INPUT WATTS	INPUT CURRENT (AMPS)	POWER FACTOR	CREST FACTOR	BALLAST FACTOR	BALLAST EFFICACY FACTOR	MAX THD%	WIRING DIAGRAM	
F32T8 F32T8/U6 (U-bend)	2	120	55.0	0.46	0.99	<1.70	0.87	1.58	10	F2-4	
		277	55.0	0.20	0.99	<1.70	0.87	1.58	10	F2-4	
	1	120	33.0	0.28	0.99	<1.70	1.05	3.18	12	F1-4	
		277	33.0	0.12	0.98	<1.70	1.05	3.18	12	F1-4	
F32T8/ES (30W)	2	120	52.0	0.44	0.99	<1.70	0.87	1.67	10	F2-4	
		277	52.0	0.19	0.99	<1.70	0.87	1.67	10	F2-4	
	1	120	32.0	0.27	0.99	<1.70	1.05	3.28	10	F1-4	
		277	32.0	0.12	0.98	<1.70	1.05	3.28	12	F1-4	
	F28T8/ES	2	120	49.0	0.41	0.99	<1.70	0.87	1.78	10	F2-4
			277	49.0	0.18	0.99	<1.70	0.87	1.78	10	F2-4
1		120	29.0	0.25	0.99	<1.70	1.10	3.79	10	F1-4	
		277	29.0	0.11	0.98	<1.70	1.10	3.79	12	F1-4	
F32T/ES (25W)	2	120	44.0	0.37	0.99	<1.70	0.87	1.98	10	F2-4	
		277	44.0	0.16	0.99	<1.70	0.87	1.98	10	F2-4	
	1	120	27.0	0.23	0.99	<1.70	1.07	3.96	10	F1-4	
		277	27.0	0.10	0.98	<1.70	1.07	3.96	12	F1-4	
F25T8 (3' lamp)	2	120	44.0	0.37	0.99	<1.70	0.88	2.00	10	F2-4	
		277	44.0	0.16	0.99	<1.70	0.88	2.00	10	F2-4	
	1	120	27.0	0.23	0.99	<1.70	1.10	4.07	12	F1-4	
		277	27.0	0.10	0.97	<1.70	1.10	4.07	15	F1-4	
F17T8	2	120	30.0	0.26	0.99	<1.70	0.90	3.00	12	F2-4	
		277	30.0	0.11	0.98	<1.70	0.90	3.00	12	F2-4	
	1	120	20.0	0.17	0.99	<1.70	1.25	6.25	12	F1-4	
		277	21.0	0.08	0.95	<1.70	1.25	5.95	15	F1-4	
F40T8	1	120	40.0	0.34	0.99	<1.70	1.00	2.50	10	F1-4	
		277	41.0	0.15	0.99	<1.70	1.00	2.44	10	F1-4	
PLL 25W	2	120	51.0	0.43	0.99	<1.70	0.88	1.73	10	P2-3	
		277	51.0	0.19	0.98	<1.70	0.89	1.75	10	P2-3	
	1	120	33.0	0.28	0.99	<1.70	1.01	3.06	10	P2-3	
		277	33.0	0.12	0.97	<1.70	1.01	3.06	12	P2-3	
PLL 28W	2	120	60.0	0.51	0.99	<1.70	0.93	1.55	10	P2-3	
		277	60.0	0.22	0.99	<1.70	0.94	1.57	10	P2-3	
	1	120	38.0	0.32	0.99	<1.70	1.07	2.82	10	P2-3	
		277	38.0	0.14	0.98	<1.70	1.07	2.82	10	P2-3	
DT40 (PLL 40W)	1	120	40.0	0.34	0.99	<1.70	0.80	2.00	10	P2-3	
		277	40.0	0.15	0.98	<1.70	0.80	2.00	10	P2-3	

PowerMaster™

WIRING DIAGRAMS

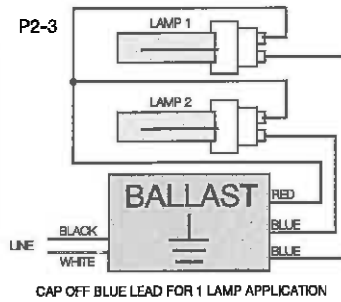
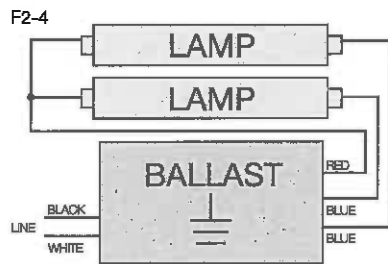
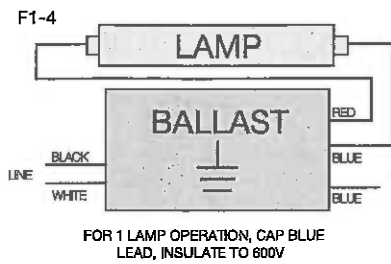

Instant Start T8 ballasts require the use of shunted lampholders/sockets.

CASE STYLE/DIMENSIONS

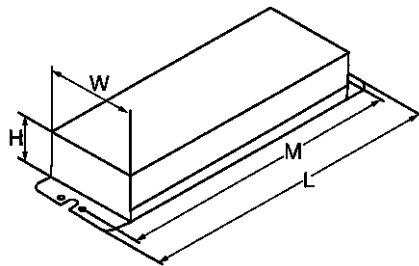

CASE DIMENSIONS

LENGTH: 9.57"
WIDTH: 1.16"
HEIGHT: 1.05"
MOUNTING: 8.90"
UNIT WEIGHT: 0.90 lbs.

STANDARD LEAD LENGTHS*

BLACK: 25.00"
WHITE: 25.00"
BLUE: 31.00" X 31.00"
RED: 44.00"

*Consult EIKO for special lead length requirements.

HOT SPOT LOCATION

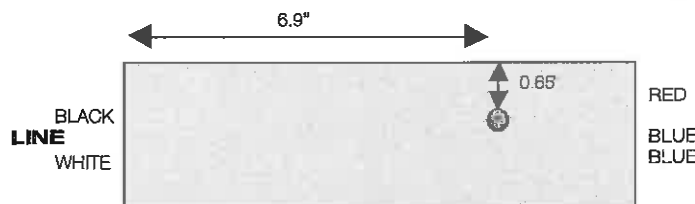



PM-2X32T8-UNV-IS

Description Instant Start Fluorescent Lamp Ballast 2x17W 25W 32W
120-277VAC

Ordering Code 07825

UNSPSC Code 39101901



Specifications

Voltage Rating 120-277

Voltage Type AC

Approvals cULus

watch > like > follow



selection. solutions. simplicity. eiko.com
23220 W. 84th St, Shawnee, KS 66227 · (P) 1.800.852.2217 (F) 1.800.492.8975
Canada: 81 King St, Barrie, ON L4N 6B5 · (P) 1.888.410.8151 (F) 1.888.705.1335



CERTIFIED GREEN

PM-2X32T8-UNV-IS

PowerMaster™ T8 Ballast



RoHS Compliant



PRODUCT FEATURES

STARTING METHOD: Instant	INPUT VOLTAGE: 120-277VAC ± 10%	POWER FACTOR: High	WARRANTY: 5 Years
LAMP CONNECTION: Parallel	INPUT FREQUENCY: 50/60 Hz	BALLAST FACTOR: Normal	CEE Specified

- Sound Rated: A
- Minimum Starting Temperature: 0°F, -18°C
- Maximum Case Temperature: 167°F, 75°C
- Meets FCC Part 18 (Class B) Consumer Limits
- Transient Protection Meets ANSI/IEEE62.41 Cat. A
- Ballast frequency for all listed lamps: > 40KHz-52KHz

ELECTRICAL SPECIFICATIONS

LAMP TYPE	NO. OF LAMPS	INPUT VOLTS	INPUT WATTS	INPUT CURRENT (AMPS)	POWER FACTOR	CREST FACTOR	BALLAST FACTOR	BALLAST EFFICACY FACTOR	MAX. THD%	WIRING DIAGRAM
F32T8 F32T8/U6 (U-bend)	2	120	55.0	0.46	0.99	<1.70	0.87	1.58	10	F2-4
		277	55.0	0.20	0.99	<1.70	0.87	1.58	10	F2-4
	1	120	33.0	0.28	0.99	<1.70	1.05	3.18	12	F1-4
		277	33.0	0.12	0.98	<1.70	1.05	3.18	12	F1-4
F32T8/ES (30W)	2	120	52.0	0.44	0.99	<1.70	0.87	1.67	10	F2-4
		277	52.0	0.19	0.99	<1.70	0.87	1.67	10	F2-4
	1	120	32.0	0.27	0.99	<1.70	1.05	3.28	10	F1-4
		277	32.0	0.12	0.98	<1.70	1.05	3.28	12	F1-4
F28T8/ES	2	120	49.0	0.41	0.99	<1.70	0.87	1.78	10	F2-4
		277	49.0	0.18	0.99	<1.70	0.87	1.78	10	F2-4
	1	120	29.0	0.25	0.99	<1.70	1.10	3.79	10	F1-4
		277	29.0	0.11	0.98	<1.70	1.10	3.79	12	F1-4
F32T/ES (25W)	2	120	44.0	0.37	0.99	<1.70	0.87	1.98	10	F2-4
		277	44.0	0.16	0.99	<1.70	0.87	1.98	10	F2-4
	1	120	27.0	0.23	0.99	<1.70	1.07	3.96	10	F1-4
		277	27.0	0.10	0.98	<1.70	1.07	3.96	12	F1-4
F25T8 (3' lamp)	2	120	44.0	0.37	0.99	<1.70	0.88	2.00	10	F2-4
		277	44.0	0.16	0.99	<1.70	0.88	2.00	10	F2-4
	1	120	27.0	0.23	0.99	<1.70	1.10	4.07	12	F1-4
		277	27.0	0.10	0.97	<1.70	1.10	4.07	15	F1-4
F17T8	2	120	30.0	0.26	0.99	<1.70	0.90	3.00	12	F2-4
		277	30.0	0.11	0.98	<1.70	0.90	3.00	12	F2-4
	1	120	20.0	0.17	0.99	<1.70	1.25	6.25	12	F1-4
		277	21.0	0.08	0.95	<1.70	1.25	5.95	15	F1-4
F40T8	1	120	40.0	0.34	0.99	<1.70	1.00	2.50	10	F1-4
		277	41.0	0.15	0.99	<1.70	1.00	2.44	10	F1-4
PLL 25W	2	120	51.0	0.43	0.99	<1.70	0.88	1.73	10	P2-3
		277	51.0	0.19	0.98	<1.70	0.89	1.75	10	P2-3
	1	120	33.0	0.28	0.99	<1.70	1.01	3.06	10	P2-3
		277	33.0	0.12	0.97	<1.70	1.01	3.06	12	P2-3
PLL 28W	2	120	60.0	0.51	0.99	<1.70	0.93	1.55	10	P2-3
		277	60.0	0.22	0.99	<1.70	0.94	1.57	10	P2-3
	1	120	38.0	0.32	0.99	<1.70	1.07	2.82	10	P2-3
		277	38.0	0.14	0.98	<1.70	1.07	2.82	10	P2-3
DT40 (PLL 40W)	1	120	40.0	0.34	0.99	<1.70	0.80	2.00	10	P2-3
		277	40.0	0.15	0.98	<1.70	0.80	2.00	10	P2-3

23220 W. 84th St., Shawnee, KS 66227 • Ph: 1.800.852.2217 • Fax: 1.800.492.8975 • eko@eiko.com

EIKO CANADA: 81 King Street, Barrie, ON L4N 6B5, Canada • Ph: 1.888.410.8151 • Fax: 1.888.705.1335 • orderdesk@eiko.com

www.eiko.com



CERTIFIED GREEN

PM-2X32T8-UNV-IS

PowerMaster™ T8 Ballast

PowerMaster™

WIRING DIAGRAMS

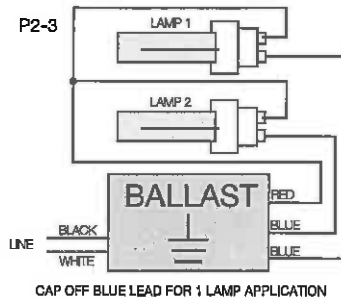
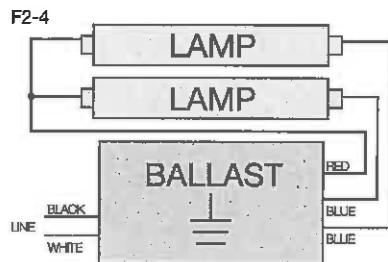
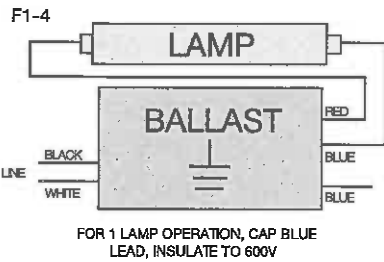

Instant Start T8 ballasts require the use of shunted lampholders/sockets.

CASE STYLE/DIMENSIONS

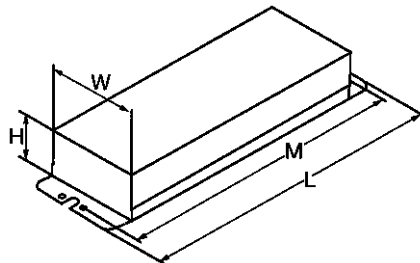

CASE DIMENSIONS

LENGTH: 9.57"
WIDTH: 1.16"
HEIGHT: 1.05"
MOUNTING: 8.90"
UNIT WEIGHT: 0.90 lbs.

STANDARD LEAD LENGTHS*

BLACK: 25.00"
WHITE: 25.00"
BLUE: 31.00" X 31.00"
RED: 44.00"

*Consult EIKO for special lead length requirements.

HOT SPOT LOCATION

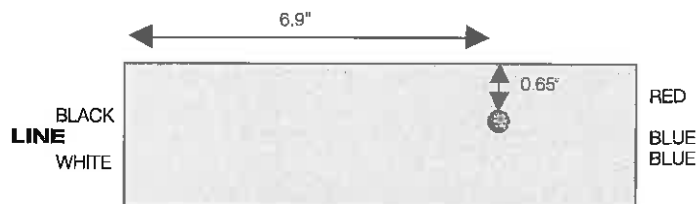

23220 W. 84th St., Shawnee, KS 66227 • Ph: 1.800.852.2217 • Fax: 1.800.492.8975 • eiko@eiko.com

EIKO CANADA: 81 King Street, Barrie, ON L4N 6B5, Canada • Ph: 1.888.410.8151 • Fax: 1.888.705.1335 • orderdesk@eiko.com

www.eiko.com



PM-4X32T8-UNV-IS



Description Instant Start Fluorescent Lamp Ballast 4x17W 25W 32W 120-277VAC

Ordering Code 07826

UNSPSC Code 39101901

Specifications

Voltage Rating	120~277
Voltage Type	AC
Approvals	cULus

watch > like > follow



selection. solutions. simplicity. eiko.com
 23220 W. 84th St, Shawnee, KS 66227 · (P) 1.800.852.2217 (F) 1.800.492.8975
 Canada: 81 King St, Barrie, ON L4N 6B5 · (P) 1.888.410.8151 (F) 1.888.705.1335



CERTIFIED GREEN

PM-4X32T8-UNV-1S

PowerMaster™ T8 Ballast



RoHS Compliant



PRODUCT FEATURES

STARTING METHOD: Instant	INPUT VOLTAGE: 120-277VAC ± 10%	POWER FACTOR: High	WARRANTY: 5 Years
LAMP CONNECTION: Parallel	INPUT FREQUENCY: 50/60 Hz	BALLAST FACTOR: Normal	CEE Specified

- Sound Rated: A
- Minimum Starting Temperature: 0°F, -18°C
- Maximum Case Temperature: 167°F, 75°C
- Meets FCC Part 18 (Class A) Non-Consumer Limits
- Transient Protection Meets ANSI/IEEE C62.41 Cat. A
- Ballast frequency for all listed lamps: > 40KHz

ELECTRICAL SPECIFICATIONS

LAMP TYPE	NO. OF LAMPS	INPUT VOLTS	INPUT WATTS	INPUT CURRENT (AMPS)	POWER FACTOR	CREST FACTOR	BALLAST FACTOR	BALLAST EFFICACY FACTOR	MAX THD%	WIRING DIAGRAM
F32T8 F32T8/U6 (I-bend)	4	120	110.0	0.92	0.99	<1.70	0.88	0.80	10	F4-1
		277	106.0	0.38	0.99	<1.70	0.87	0.82	10	F4-1
	3	120	89.0	0.74	0.99	<1.70	0.94	1.06	10	F3-3
		277	88.0	0.32	0.98	<1.70	0.95	1.08	10	F3-3
F32T8/ES (30W)	4	120	105.0	0.88	0.99	<1.70	0.86	0.82	10	F4-1
		277	106.0	0.38	0.98	<1.70	0.87	0.82	10	F4-1
	3	120	85.0	0.71	0.99	<1.70	0.93	1.09	10	F3-3
		277	85.0	0.31	0.97	<1.70	0.93	1.09	12	F3-3
F28T8/ES	4	120	100.0	0.83	0.99	<1.70	0.88	0.88	10	F4-1
		277	100.0	0.36	0.98	<1.70	0.87	0.87	10	F4-1
	3	120	83.0	0.69	0.99	<1.70	0.98	1.18	10	F3-3
		277	84.0	0.30	0.97	<1.70	0.99	1.18	12	F3-3
F32T/ES (25W)	4	120	94.0	0.78	0.99	<1.70	0.94	1.00	10	F4-1
		277	94.0	0.34	0.98	<1.70	0.93	0.99	10	F4-1
	3	120	77.0	0.64	0.99	<1.70	1.01	1.31	10	F3-3
		277	77.0	0.28	0.97	<1.70	1.01	1.31	12	F3-3
F25T8 (3' lamp)	4	120	83.0	0.69	0.99	<1.70	0.82	0.99	10	F4-1
		277	84.0	0.30	0.97	<1.70	0.83	0.99	12	F4-1
	3	120	69.0	0.58	0.99	<1.70	0.91	1.32	10	F3-3
		277	70.0	0.25	0.97	<1.70	0.92	1.31	12	F3-3
F17T8	4	120	62.0	0.52	0.99	<1.70	0.90	1.45	10	F4-1
		277	62.0	0.22	0.96	<1.70	0.90	1.45	12	F4-1
	3	120	51.0	0.43	0.99	<1.70	0.99	1.94	10	F3-3
		277	51.0	0.18	0.95	<1.70	0.99	1.94	15	F3-3
F40T8	3	120	109.0	0.91	0.99	<1.70	0.90	0.83	10	F3-3
		277	108.0	0.39	0.98	<1.70	0.89	0.82	10	F3-3
PLL 25W	4	120	101.0	0.85	0.99	<1.70	0.89	0.88	10	P4-1
		277	100.0	0.37	0.98	<1.70	0.89	0.89	10	P4-1
	3	120	82.0	0.68	0.99	<1.70	0.95	1.16	10	P4-1
		277	82.0	0.30	0.98	<1.70	0.96	1.17	10	P4-1
PLL 28W	4	120	117.0	0.98	0.99	<1.70	0.92	0.79	10	P4-1
		277	117.0	0.43	0.98	<1.70	0.93	0.79	10	P4-1
	3	120	97.0	0.81	0.99	<1.70	1.00	1.03	10	P4-1
		277	97.0	0.36	0.98	<1.70	1.01	1.04	10	P4-1
DT40 (PLL 40W)	3	120	100.0	0.84	0.99	<1.70	0.75	0.73	10	P4-1
		277	100.0	0.37	0.98	<1.70	0.75	0.74	10	P4-1



CERTIFIED GREEN

PM-4X32T8-UNV-IS

PowerMaster™ T8 Ballast



WIRING DIAGRAMS

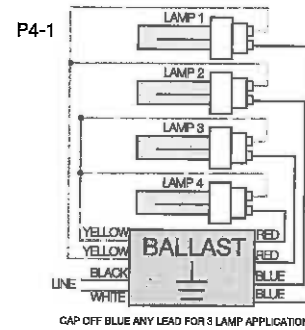
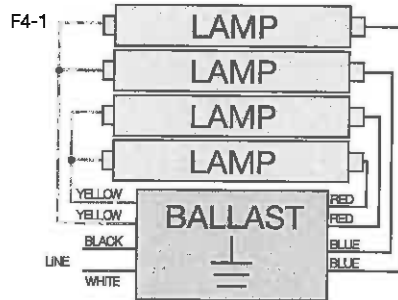
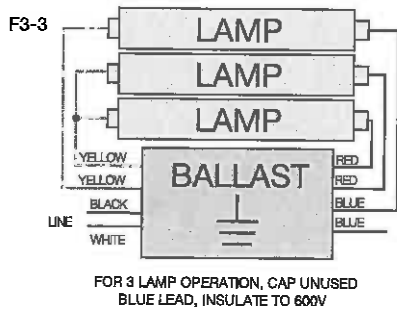

Instant Start T8 ballasts require the use of shunted lampholders/sockets.

CASE STYLE/DIMENSIONS

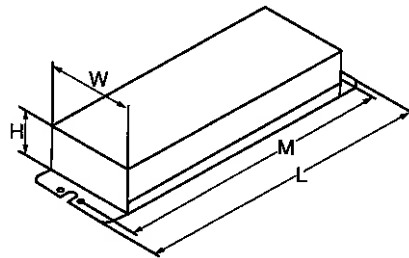

CASE DIMENSIONS

LENGTH: 9.50"
WIDTH: 1.38"
HEIGHT: 1.18"
MOUNTING: 8 90°
UNIT WEIGHT: 1.21 lbs.

STANDARD LEAD LENGTHS*

BLACK: 25.00"
WHITE: 25.00"
BLUE: 31.00" X 31.00"
RED: 31.00" X 31.00"
YELLOW: 45.00" X 45.00"

*Consult EIKO for special lead length requirements.

HOT SPOT LOCATION

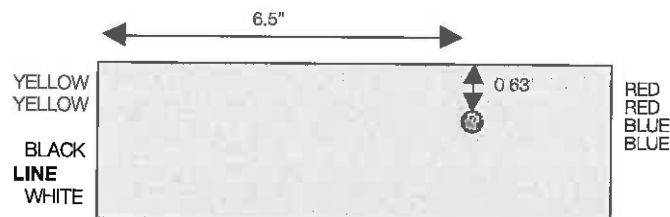

23220 W. 84th St., Shawnee, KS 66227 • Ph: 1.800.852.2217 • Fax: 1.800.492.8975 • eiko@eiko.com

EIKO CANADA: 81 King Street, Barrie, ON L4N 6B5, Canada • Ph: 1.888.410.8151 • Fax: 1.888.705.1335 • orderdesk@eiko.com

www.eiko.com



PM-3X32T8-UNV-IS



Description Instant Start Fluorescent Lamp Ballast 3x17W 25W 32W
120-277VAC

Ordering Code 07868

UNSPSC Code 39101901

Specifications

Voltage Rating	120~277
Voltage Type	AC
Approvals	cULus

watch > like > follow



selection. solutions. simplicity. eiko.com
 23220 W. 84th St, Shawnee, KS 66227 · (P) 1.800.852.2217 (F) 1.800.492.8975
 Canada: 81 King St, Barrie, ON L4N 6B5 · (P) 1.888.410.8151 (F) 1.888.705.1335



CERTIFIED GREEN

PM-3X32T8-UNV-IS

PowerMaster™ T8 Ballast



RoHS Compliant



PRODUCT FEATURES

STARTING METHOD: Instant	INPUT VOLTAGE: 120-277VAC ± 10%	POWER FACTOR: High	WARRANTY: 5 Years
LAMP CONNECTION: Parallel	INPUT FREQUENCY: 50/60 Hz	BALLAST FACTOR: Normal	CEE Specified

- Sound Rated: A
- Minimum Starting Temperature: 0°F, -18°C
- Maximum Case Temperature: 167°F, 75°C
- Meets FCC Part 18 (Class A) Non-Consumer Limits
- Transient Protection Meets ANSI/IEEE C62.41 Cat. A
- Ballast frequency for all listed lamps: > 40kHz

ELECTRICAL SPECIFICATIONS

LAMP TYPE	NO. OF LAMPS	INPUT VOLTS	INPUT WATTS	INPUT CURRENT (AMPS)	POWER FACTOR	CREST FACTOR	BALLAST FACTOR	BALLAST EFFICACY FACTOR	MAX THD%	WIRING DIAGRAM
F32T832W	3	120	83.0	0.69	0.99	<1.70	0.87	1.05	10	F3-2
		277	81.0	0.29	0.98	<1.70	0.88	1.09	10	F3-2
	2	120	64.0	0.53	0.99	<1.70	1.02	1.59	10	F2-5
		277	63.0	0.23	0.97	<1.70	1.01	1.60	12	F2-5
F32T830W	3	120	79.0	0.66	0.99	<1.70	0.87	1.10	10	F3-2
		277	79.0	0.29	0.98	<1.70	0.87	1.10	10	F3-2
		120	60.0	0.50	0.99	<1.70	0.98	1.63	10	F2-5
	2	277	60.0	0.22	0.97	<1.70	0.98	1.63	12	F2-5
		120	76.0	0.63	0.99	<1.70	0.89	1.17	10	F3-2
		277	77.0	0.28	0.97	<1.70	0.89	1.16	12	F3-2
F32T828W	3	120	57.0	0.48	0.99	<1.70	1.01	1.77	10	F2-5
		277	57.0	0.21	0.96	<1.70	1.01	1.77	12	F2-5
	2	120	71.0	0.59	0.99	<1.70	0.94	1.32	10	F3-2
		277	72.0	0.26	0.97	<1.70	0.95	1.32	12	F3-2
F32T825W	3	120	54.0	0.45	0.99	<1.70	1.07	1.98	10	F2-5
		277	54.0	0.20	0.96	<1.70	1.07	1.98	12	F2-5
		120	72.0	0.60	0.99	<1.70	0.95	1.32	10	F3-2
	2	277	72.0	0.26	0.99	<1.70	0.95	1.32	10	F3-2
		120	54.0	0.45	0.99	<1.70	1.07	1.98	10	F2-5
		277	55.0	0.20	0.96	<1.70	1.07	1.95	12	F2-5
F17T817W	3	120	47.0	0.39	0.99	<1.70	0.86	1.83	10	F3-2
		277	48.0	0.17	0.95	<1.70	0.88	1.83	15	F3-2
	2	120	37.0	0.31	0.99	<1.70	1.01	2.73	10	F2-5
		277	38.0	0.14	0.93	<1.70	1.03	2.71	15	F2-5
F40T840W	2	120	78.0	0.65	0.99	<1.70	0.92	0.92	10	F2-5
		277	77.0	0.28	0.98	<1.70	0.88	0.88	10	F2-5
PLL25W	3	120	75.0	0.62	0.99	<1.70	0.88	1.17	10	P3-1
		277	75.0	0.27	0.98	<1.70	0.89	1.19	10	P3-1
	2	120	59.0	0.49	0.99	<1.70	1.00	1.69	12	P3-1
		277	59.0	0.22	0.97	<1.70	1.01	1.71	10	P3-1
PLL28W	3	120	89.0	0.75	0.99	<1.70	0.93	1.04	10	P3-1
		277	89.0	0.32	0.98	<1.70	0.94	1.06	10	P3-1
	2	120	69.0	0.58	0.99	<1.70	1.06	1.54	10	P3-1
		277	70.0	0.25	0.98	<1.70	1.06	1.51	10	P3-1
DT40 (PLL40W)	2	120	71.0	0.59	0.99	<1.70	0.76	1.07	10	P3-1
		277	71.0	0.26	0.98	<1.70	0.78	1.10	10	P3-1



CERTIFIED GREEN

PM-3X32T8-UNV-IS

PowerMaster™ T8 Ballast

PowerMaster™

WIRING DIAGRAMS

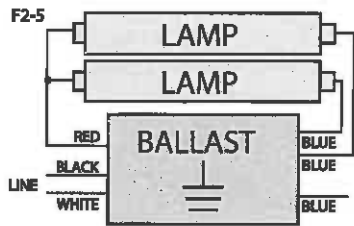

FOR 2 LAMP OPERATION, CAP UNUSED
BLUE LEAD, INSULATE TO 600V

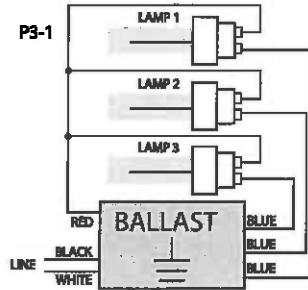
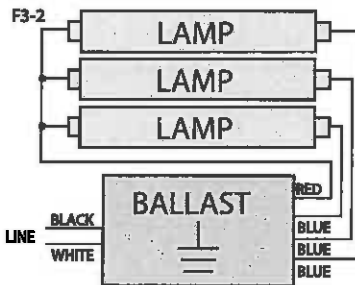

Instant Start
T8 ballasts
require the
use of shunted
lampholders/
sockets.

CASE STYLE/DIMENSIONS

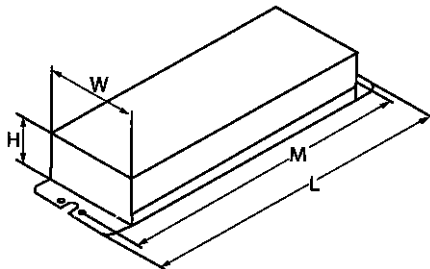

CASE DIMENSIONS

LENGTH: 9.50"
WIDTH: 1.38"
HEIGHT: 1.18"
MOUNTING: 8 90°
UNIT WEIGHT: 1.80 lbs.

STANDARD LEAD LENGTHS*

BLACK: 25.00"
WHITE: 25.00"
BLUE: 31.00" X 31.00" X 31.00"
RED: 48.00"

*Consult EIKO for special lead length requirements.

HOT SPOT LOCATION

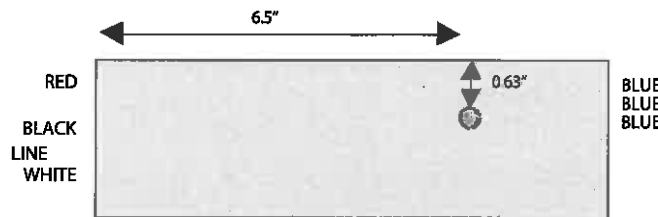

23220 W. 84th St., Shawnee, KS 66227 • Ph: 1.800.852.2217 • Fax: 1.800.492.8975 • eiko@eiko.com

EIKO CANADA: 81 King Street, Barrie, ON L4N 6B5, Canada • Ph: 1.888.410.8151 • Fax: 1.888.705.1335 • orderdesk@eiko.com

www.eiko.com



PM-4X54T5-UNV-PS



Description Program Start Fluorescent Lamp Ballast 4x49W-54W 120-277VAC 90CRated Short Case

Ordering Code 07828

UNSPSC Code 39101901

Specifications

Voltage Rating	120~277
Voltage Type	AC
Approvals	cULus

watch > like > follow



selection. solutions. simplicity. eiko.com
 23220 W. 84th St, Shawnee, KS 66227 · (P) 1.800.852.2217 (F) 1.800.492.8975
 Canada: 81 King St, Barrie, ON L4N 6B5 · (P) 1.888.410.8151 (F) 1.888.705.1335



CERTIFIED GREEN

PM-4X54T5-UNV-PS

PowerMaster™ T5 Ballast



RoHS Compliant



PRODUCT FEATURES

STARTING METHOD: Program	INPUT VOLTAGE: 120-277VAC ± 10%	POWER FACTOR: High	WARRANTY: 5 Years
LAMP CONNECTION: Series	INPUT FREQUENCY: 50/60 Hz	BALLAST FACTOR: Normal	

- Sound Rated: A
- Minimum Starting Temperature: -20°C, -30°C
- Maximum Case Temperature: 194°F, 90°C
- Meets FCC Part 18 (Class A) Non-Consumer Limits
- Transient Protection Meets ANSI/IEEE C62.41 Cat. A
- Lamp end-of-life protected
- Remote Lamping 20 feet

ELECTRICAL SPECIFICATIONS

LAMP TYPE	NO. OF LAMPS	RATED LAMP WATTS	MIN. START TEMP (°F/°C)	INPUT VOLTS	INPUT WATTS	INPUT CURRENT	BALLAST FACTOR	THD %	POWER FACTOR	C.F.	B.E.F.
F54T5HO	4	54	-20/-30	120	234	1.97	1.00	10	0.99	1.7	0.43
	4	54	-20/-30	277	227	0.84	1.00	10	0.97	1.7	0.44
	3	54	-20/-30	120	175	1.48	1.03	10	0.99	1.7	0.59
	3	54	-20/-30	277	170	0.64	1.03	10	0.97	1.7	0.61
	2	54	-20/-30	120	118	0.98	1.00	10	0.99	1.7	0.85
	2	54	-20/-30	277	115	0.42	1.00	10	0.96	1.7	0.87
FT55W 2G11	4	55	-20/-30	120	224	1.88	0.91	10	0.99	1.7	0.40
	4	55	-20/-30	277	220	0.80	0.91	10	0.97	1.7	0.41
	3	55	-20/-30	120	170	1.42	0.93	10	0.99	1.7	0.55
	3	55	-20/-30	277	166	0.61	0.93	10	0.97	1.7	0.56
	2	55	-20/-30	120	112	0.94	0.91	10	0.99	1.7	0.81
	2	55	-20/-30	277	110	0.41	0.91	10	0.96	1.7	0.83
FT50W 2G11	4	50	-20/-30	120	226	1.89	1.04	10	0.99	1.7	0.48
	4	50	-20/-30	277	222	0.82	1.04	10	0.98	1.7	0.49
	3	50	-20/-30	120	172	1.44	1.05	10	0.99	1.7	0.64
	3	50	-20/-30	277	167	0.62	1.05	10	0.97	1.7	0.66
	2	50	-20/-30	120	114	0.96	1.06	10	0.99	1.7	0.96
	2	50	-20/-30	277	111	0.41	1.06	10	0.96	1.7	0.98
FT36W 2G11	4	36	-20/-30	120	168	1.42	1.04	10	0.99	1.7	0.62
	4	36	-20/-30	277	165	0.65	1.04	10	0.96	1.7	0.63
	3	36	-20/-30	120	128	1.06	1.05	10	0.99	1.7	0.82
	3	36	-20/-30	277	126	0.48	1.05	10	0.97	1.7	0.83
	2	36	-20/-30	120	83	0.68	1.06	10	0.99	1.7	1.28
	2	36	-20/-30	277	82	0.33	1.06	10	0.94	1.7	1.29
F58T8	4	58	-20/-30	120	210	1.77	0.92	10	0.99	1.7	0.43
	4	58	-20/-30	277	207	0.78	0.92	10	0.97	1.7	0.44
	3	58	-20/-30	120	159	1.33	0.95	10	0.99	1.7	0.59
	3	58	-20/-30	277	156	0.58	0.95	10	0.97	1.7	0.61
	2	58	-20/-30	120	105	0.89	0.92	10	0.99	1.7	0.88
	2	58	-20/-30	277	103	0.41	0.92	10	0.95	1.7	0.89
F54T5HO /ES/49W	4	49	-20/-30	120	208	1.76	0.98	10	0.99	1.7	0.47
	4	49	-20/-30	277	204	0.75	0.98	10	0.98	1.7	0.48
	3	49	-20/-30	120	157	1.32	0.99	10	0.99	1.7	0.63
	3	49	-20/-30	277	155	0.56	0.99	10	0.97	1.7	0.64
	2	49	-20/-30	120	104	0.85	1.02	10	0.99	1.7	0.98
	2	49	-20/-30	277	102	0.36	1.02	10	0.96	1.7	1.00

23220 W. 84th St., Shawnee, KS 66227 • Ph: 1.800.852.2217 • Fax: 1.800.492.8975 • eiko@eiko.com

EIKO CANADA: 81 King Street, Barrie, ON L4N 6B5, Canada • Ph: 1.888.410.8151 • Fax: 1.888.705.1335 • orderdesk@eiko.com

www.eiko.com



CERTIFIED GREEN

PM-4X54T5-UNV-PS

PowerMaster™ T5 Ballast

WIRING DIAGRAMS

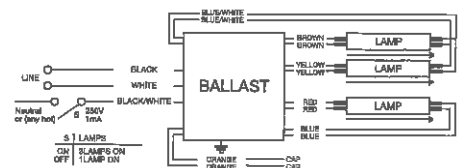
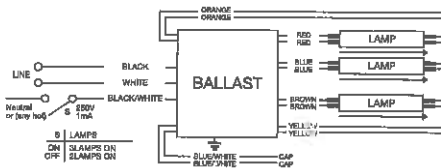
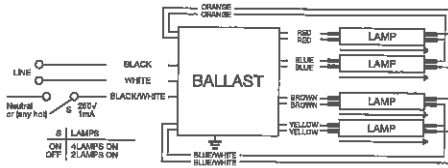

CASE STYLE/DIMENSIONS

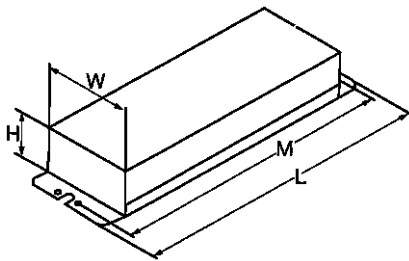

CASE DIMENSIONS

LENGTH: 16.7"
WIDTH: 1.7"
HEIGHT: 1.18"
MOUNTING: 16.3"
UNIT WEIGHT: 2.21 lbs.

STANDARD LEAD LENGTHS*

BLACK: 20.00"
WHITE: 20.00"
BLUE: 32.00"
RED: 32.00"
BLUE/WHITE: 49.00"
YELLOW: 49.00"
BROWN: 32.00"
ORANGE: 32.00"

*Consult EIKO for special lead length requirements.

HOT SPOT LOCATION

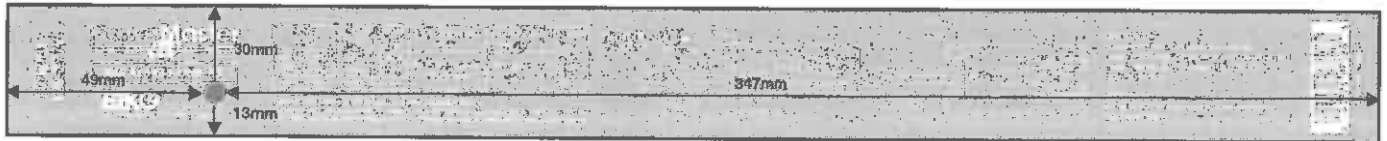

23220 W. 84th St., Shawnee, KS 66227 • Ph: 1.800.852.2217 • Fax: 1.800.492.8975 • eiko@eiko.com

EIKO CANADA: 81 King Street, Barrie, ON L4N 6B5, Canada • Ph: 1.888.410.8151 • Fax: 1.888.705.1335 • orderdesk@eiko.com

www.eiko.com

Product Number: 51843

Order Abbreviation: QTP2X26/32/42CF/UNV DM

General Description: Universal voltage programmed rapid start normal ballast factor electronic ballast in metal enclosure dual mount without leads for two 26W, 32W, or 42W CFL lamps.

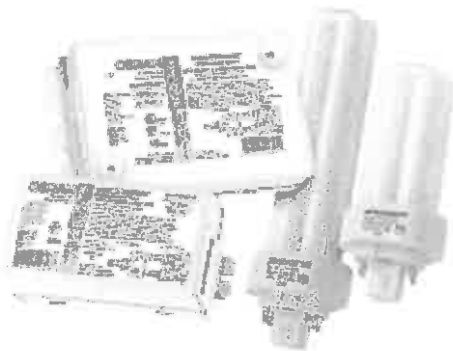

Product Information:

Abbrev. With Packaging Info.	QTP2X263242CFUNVDM 20/CS 1/SKU
Ballast Factor	1
Ballast Height H (in)	1.3500
Ballast Length L (in)	4.9500
Ballast Width W (in)	2.9300
Circuit Type	SERIES
Family Brand Name	QUICKTRONIC Professional
Input Current (Amps)	0.00
Nominal Voltage (V)	120-277V
Number of Lamps	2
Power Factor	>0.98
Primary Lamp Type	26W DD/E,T/E
Sound Rating	A
Starting Method	PROGRAMMED RAPID START
Starting Temperature - Fahrenheit	-5
Starting Temperature - Celsius	-20
Total Harmonic Distortion (THD)	<10%
Wiring Method	PLUG-IN CONNECTORS
Language Strategy	2

Footnotes

- 70C Max Case Temperature
- 75C Max Case Temperature
- UL Listed Class P, Type 1 Outdoor
- Ground ballast case
- Install in accordance with National Electric Codes
- Complies with FCC 47 CFR Part 18, Non-Consumer
- Class A Sound Rating.
- Input Frequency: 50/60Hz.
- Remote Mounting up to 19 feet (keep red wires short for 1&2 lamp).
- Minimum Starting Temperature: -4F/-20C.
- Remote Mounting up to 19 feet (keep red wires short for 1&2 lamp models).
- ANSI C62.41 cat. B3 Transient Protection.
- Remote mounting - Typically 6ft with suitable ground plane, but varies by model and application. Contact ECS Application Engineering for information on longer applications.

Product Number: 47634

Order Abbreviation: LU250/SUPER5-KIT

General Description: 120/208/240/277/480V 5-tap magnetic core and coil ballast for 250W high pressure sodium lamp



Product Information

Abbrev. With Packaging Info.	LU250SUPER5KIT 1/CS 1/SKU
ANSI Code	S50
Circuit Type	CWA
Nominal Voltage (V)	120/208/240/277/480V
Number of Lamps	1
Open Circuit Voltage (V)	190
Power Factor	>0.9
Primary Lamp Type	LU250
Sound Rating	N
Starting Method	PULSE IGNITOR
Starting Temperature - Fahrenheit	-40°F
Starting Temperature - Celsius	-40°C
Total Harmonic Distortion (THD)	<20%
Wiring Method	LEADS



Footnotes

- Product is a kit containing the core & coil, capacitor, ignitor (where required), brackets and mounting hardware
- Install in accordance with National Electric Codes
- High Voltage Pulse Present on Open Circuit
- Ground Ballast Core and Metallic Case of Capacitor and Ignitor
- Minimum Starting Temperature: -40F/-40C.
- Product contains installation instructions



Product Number: 47659

Order Abbreviation: LU1000/SUPER5-KIT

General Description: 120/208/240/277/480V 5-tap magnetic core and coil ballast for 1000W high pressure sodium lamp

Product Information

Abbrev. With Packaging Info.	LU1000SUPER5KIT 1/CS 1/SKU
ANSI Code	S52
Circuit Type	CWA
Nominal Voltage (V)	120/208/240/277/480V
Number of Lamps	1
Open Circuit Voltage (V)	440
Power Factor	>0.9
Primary Lamp Type	LU1000
Sound Rating	N
Starting Method	PULSE IGNITOR
Starting Temperature - Fahrenheit	-40°F
Starting Temperature - Celsius	-40°C
Total Harmonic Distortion (THD)	<20%
Wiring Method	LEADS
Total Maximum Wattage	1100



Footnotes

- Product is a kit containing the core & coil, capacitor, ignitor (where required), brackets and mounting hardware
- Install in accordance with National Electric Codes
- High Voltage Pulse Present on Open Circuit
- Ground Ballast Core and Metallic Case of Capacitor and Ignitor
- Minimum Starting Temperature: -40F/-40C.
- Product contains installation instructions

ADDENDUM ACKNOWLEDGEMENT FORM
SOLICITATION NO.: SWC1800000012

Instructions: Please acknowledge receipt of all addenda issued with this solicitation by completing this addendum acknowledgment form. Check the box next to each addendum received and sign below. Failure to acknowledge addenda may result in bid disqualification.

Acknowledgment: I hereby acknowledge receipt of the following addenda and have made the necessary revisions to my proposal, plans and/or specification, etc.

Addendum Numbers Received:

(Check the box next to each addendum received)

- | | |
|--|--|
| <input checked="" type="checkbox"/> Addendum No. 1 | <input type="checkbox"/> Addendum No. 6 |
| <input checked="" type="checkbox"/> Addendum No. 2 | <input type="checkbox"/> Addendum No. 7 |
| <input type="checkbox"/> Addendum No. 3 | <input type="checkbox"/> Addendum No. 8 |
| <input type="checkbox"/> Addendum No. 4 | <input type="checkbox"/> Addendum No. 9 |
| <input type="checkbox"/> Addendum No. 5 | <input type="checkbox"/> Addendum No. 10 |

I understand that failure to confirm the receipt of addenda may be cause for rejection of this bid. I further understand that that any verbal representation made or assumed to be made during any oral discussion held between Vendor's representatives and any state personnel is not binding. Only the information issued in writing and added to the specifications by an official addendum is binding.

W. VA. ELECTRIC SUPPLY CO.
Company

Authorized Signature

2/27/18
Date

NOTE: This addendum acknowledgment should be submitted with the bid to expedite document processing.

INSTRUCTIONS TO VENDORS SUBMITTING BIDS

1. REVIEW DOCUMENTS THOROUGHLY: The attached documents contain a solicitation for bids. Please read these instructions and all documents attached in their entirety. These instructions provide critical information about requirements that if overlooked could lead to disqualification of a Vendor's bid. All bids must be submitted in accordance with the provisions contained in these instructions and the Solicitation. Failure to do so may result in disqualification of Vendor's bid.

2. MANDATORY TERMS: The Solicitation may contain mandatory provisions identified by the use of the words "must," "will," and "shall." Failure to comply with a mandatory term in the Solicitation will result in bid disqualification.

3. PREBID MEETING: The item identified below shall apply to this Solicitation.

A pre-bid meeting will not be held prior to bid opening

A NON-MANDATORY PRE-BID meeting will be held at the following place and time:

A MANDATORY PRE-BID meeting will be held at the following place and time:

All Vendors submitting a bid must attend the mandatory pre-bid meeting. Failure to attend the mandatory pre-bid meeting shall result in disqualification of the Vendor's bid. No one person attending the pre-bid meeting may represent more than one Vendor.

An attendance sheet provided at the pre-bid meeting shall serve as the official document verifying attendance. The State will not accept any other form of proof or documentation to verify attendance. Any person attending the pre-bid meeting on behalf of a Vendor must list on the attendance sheet his or her name and the name of the Vendor he or she is representing.

Additionally, the person attending the pre-bid meeting should include the Vendor's E-Mail address, phone number, and Fax number on the attendance sheet. It is the Vendor's responsibility to locate the attendance sheet and provide the required information. Failure to complete the attendance sheet as required may result in disqualification of Vendor's bid.

All Vendors should arrive prior to the starting time for the pre-bid. Vendors who arrive after the starting time but prior to the end of the pre-bid will be permitted to sign in, but are charged with knowing all matters discussed at the pre-bid.

Questions submitted at least five business days prior to a scheduled pre-bid will be discussed at the pre-bid meeting if possible. Any discussions or answers to questions at the pre-bid meeting are preliminary in nature and are non-binding. Official and binding answers to questions will be published in a written addendum to the Solicitation prior to bid opening.

4. VENDOR QUESTION DEADLINE: Vendors may submit questions relating to this Solicitation to the Purchasing Division. Questions must be submitted in writing. All questions must be submitted on or before the date listed below and to the address listed below in order to be considered. A written response will be published in a Solicitation addendum if a response is possible and appropriate. Non-written discussions, conversations, or questions and answers regarding this Solicitation are preliminary in nature and are nonbinding.

Submitted e-mails should have solicitation number in the subject line.

Question Submission Deadline: 02/14/2018 @ 10:00 A.M. EST

Submit Questions to: Melissa Pettrey, Senior Buyer
2019 Washington Street, East
Charleston, WV 25305
Fax: (304) 558-4115 (Vendors should not use this fax number for bid submission)
Email: melissa.k.pettrey@wv.gov

5. VERBAL COMMUNICATION: Any verbal communication between the Vendor and any State personnel is not binding, including verbal communication at the mandatory pre-bid conference. Only information issued in writing and added to the Solicitation by an official written addendum by the Purchasing Division is binding.

6. BID SUBMISSION: All bids must be submitted electronically through wvOASIS or signed and delivered by the Vendor to the Purchasing Division at the address listed below on or before the date and time of the bid opening. Any bid received by the Purchasing Division staff is considered to be in the possession of the Purchasing Division and will not be returned for any reason. The Purchasing Division will not accept bids, modification of bids, or addendum acknowledgment forms via e-mail. Acceptable delivery methods include electronic submission via wvOASIS, hand delivery, delivery by courier, or facsimile.

The bid delivery address is:
Department of Administration, Purchasing Division
2019 Washington Street East
Charleston, WV 25305-0130

A bid that is not submitted electronically through wvOASIS should contain the information listed below on the face of the envelope or the bid may be rejected by the Purchasing Division.:

SEALED BID:

BUYER: Melissa Pettrey, Senior Buyer
SOLICITATION NO.: CRFQ 0212 SW C18 00000012
BID OPENING DATE: 2-28-18
BID OPENING TIME: 1:30 pm
FAX NUMBER:

The Purchasing Division may prohibit the submission of bids electronically through wvOASIS at its sole discretion. Such a prohibition will be contained and communicated in the wvOASIS system resulting in the Vendor's inability to submit bids through wvOASIS. Submission of a response to an Expression or Interest or Request for Proposal is not permitted in wvOASIS.

For Request For Proposal ("RFP") Responses Only: In the event that Vendor is responding to a request for proposal, the Vendor shall submit one original technical and one original cost proposal plus NA convenience copies of each to the Purchasing Division at the address shown above. Additionally, the Vendor should identify the bid type as either a technical or cost proposal on the face of each bid envelope submitted in response to a request for proposal as follows:

BID TYPE: (This only applies to CRFP)
 Technical
 Cost

7. BID OPENING: Bids submitted in response to this Solicitation will be opened at the location identified below on the date and time listed below. Delivery of a bid after the bid opening date and time will result in bid disqualification. For purposes of this Solicitation, a bid is considered delivered when confirmation of delivery is provided by wvOASIS (in the case of electronic submission) or when the bid is time stamped by the official Purchasing Division time clock (in the case of hand delivery).

Bid Opening Date and Time: 02/28/2018 @ 1:30 P.M. EST

Bid Opening Location: Department of Administration, Purchasing Division
2019 Washington Street East
Charleston, WV 25305-0130

8. ADDENDUM ACKNOWLEDGEMENT: Changes or revisions to this Solicitation will be made by an official written addendum issued by the Purchasing Division. Vendor should acknowledge receipt of all addenda issued with this Solicitation by completing an Addendum Acknowledgment Form, a copy of which is included herewith. Failure to acknowledge addenda may result in bid disqualification. The addendum acknowledgement should be submitted with the bid to expedite document processing.

9. BID FORMATTING: Vendor should type or electronically enter the information onto its bid to prevent errors in the evaluation. Failure to type or electronically enter the information may result in bid disqualification.

10. ALTERNATES: Any model, brand, or specification listed in this Solicitation establishes the acceptable level of quality only and is not intended to reflect a preference for, or in any way favor, a particular brand or vendor. Vendors may bid alternates to a listed model or brand provided that the alternate is at least equal to the model or brand and complies with the required specifications. The equality of any alternate being bid shall be determined by the State at its sole discretion. Any Vendor bidding an alternate model or brand should clearly identify the alternate items in its bid and should include manufacturer's specifications, industry literature, and/or any other relevant documentation demonstrating the equality of the alternate items. Failure to provide information for alternate items may be grounds for rejection of a Vendor's bid.

11. EXCEPTIONS AND CLARIFICATIONS: The Solicitation contains the specifications that shall form the basis of a contractual agreement. Vendor shall clearly mark any exceptions, clarifications, or other proposed modifications in its bid. Exceptions to, clarifications of, or modifications of a requirement or term and condition of the Solicitation may result in bid disqualification.

12. COMMUNICATION LIMITATIONS: In accordance with West Virginia Code of State Rules §148-1-6.6, communication with the State of West Virginia or any of its employees regarding this Solicitation during the solicitation, bid, evaluation or award periods, except through the Purchasing Division, is strictly prohibited without prior Purchasing Division approval. Purchasing Division approval for such communication is implied for all agency delegated and exempt purchases.

13. REGISTRATION: Prior to Contract award, the apparent successful Vendor must be properly registered with the West Virginia Purchasing Division and must have paid the \$125 fee, if applicable.

14. UNIT PRICE: Unit prices shall prevail in cases of a discrepancy in the Vendor's bid.

15. PREFERENCE: Vendor Preference may only be granted upon written request and only in accordance with the West Virginia Code § 5A-3-37 and the West Virginia Code of State Rules. A Vendor Preference Certificate form has been attached hereto to allow Vendor to apply for the preference. Vendor's failure to submit the Vendor Preference Certificate form with its bid will result in denial of Vendor Preference. Vendor Preference does not apply to construction projects.

16. SMALL, WOMEN-OWNED, OR MINORITY-OWNED BUSINESSES: For any solicitations publicly advertised for bid, in accordance with West Virginia Code §5A-3-37(a)(7) and W. Va. CSR § 148-22-9, any non-resident vendor certified as a small, women-owned, or minority-owned business under W. Va. CSR § 148-22-9 shall be provided the same preference made available to any resident vendor. Any non-resident small, women-owned, or minority-owned business must identify itself as such in writing, must submit that writing to the Purchasing Division with its bid, and must be properly certified under W. Va. CSR § 148-22-9 prior to contract award to receive the preferences made available to resident vendors. Preference for a non-resident small, women-owned, or minority owned business shall be applied in accordance with W. Va. CSR § 148-22-9.

17. WAIVER OF MINOR IRREGULARITIES: The Director reserves the right to waive minor irregularities in bids or specifications in accordance with West Virginia Code of State Rules § 148-1-4.6.

18. ELECTRONIC FILE ACCESS RESTRICTIONS: Vendor must ensure that its submission in wvOASIS can be accessed and viewed by the Purchasing Division staff immediately upon bid opening. The Purchasing Division will consider any file that cannot be immediately accessed and viewed at the time of the bid opening (such as, encrypted files, password protected files, or incompatible files) to be blank or incomplete as context requires, and are therefore unacceptable. A vendor will not be permitted to unencrypt files, remove password protections, or resubmit documents after bid opening to make a file viewable if those documents are required with the bid. A Vendor may be required to provide document passwords or remove access restrictions to allow the Purchasing Division to print or electronically save documents provided that those documents are viewable by the Purchasing Division prior to obtaining the password or removing the access restriction.

19. NON-RESPONSIBLE: The Purchasing Division Director reserves the right to reject the bid of any vendor as Non-Responsible in accordance with W. Va. Code of State Rules § 148-1-5.3, when the Director determines that the vendor submitting the bid does not have the capability to fully perform, or lacks the integrity and reliability to assure good-faith performance."

20. ACCEPTANCE/REJECTION: The State may accept or reject any bid in whole, or in part in accordance with W. Va. Code of State Rules § 148-1-4.5. and § 148-1-6.4.b."

21. YOUR SUBMISSION IS A PUBLIC DOCUMENT: Vendor's entire response to the Solicitation and the resulting Contract are public documents. As public documents, they will be disclosed to the public following the bid/proposal opening or award of the contract, as required by the competitive bidding laws of West Virginia Code §§ 5A-3-1 et seq., 5-22-1 et seq., and 5G-1-1 et seq. and the Freedom of Information Act West Virginia Code §§ 29B-1-1 et seq.

DO NOT SUBMIT MATERIAL YOU CONSIDER TO BE CONFIDENTIAL, A TRADE SECRET, OR OTHERWISE NOT SUBJECT TO PUBLIC DISCLOSURE.

Submission of any bid, proposal, or other document to the Purchasing Division constitutes your explicit consent to the subsequent public disclosure of the bid, proposal, or document. The Purchasing Division will disclose any document labeled "confidential," "proprietary," "trade secret," "private," or labeled with any other claim against public disclosure of the documents, to include any "trade secrets" as defined by West Virginia Code § 47-22-1 et seq. All submissions are subject to public disclosure without notice.

22. INTERESTED PARTY DISCLOSURE: W. Va. Code § 6D-1-2 requires that for contracts with an actual or estimated value of at least \$100,000, the vendor must submit to the Purchasing Division a disclosure of interested parties to the contract, prior to contract award. That disclosure must occur on the form prescribed and approved by the WV Ethics Commission. A copy of that form is included with this solicitation or can be obtained from the WV Ethics Commission. "Interested parties" means: (1) A business entity performing work or service pursuant to, or in furtherance of, the applicable contract, including specifically sub-contractors; (2) the person(s) who have an ownership interest equal to or greater than 25% in the business entity performing work or service pursuant to, or in furtherance of, the applicable contract; and (3) the person or business entity, if any, that served as a compensated broker or intermediary to actively facilitate the applicable contract or negotiated the terms of the applicable contract with the state agency: Provided, That subdivision (2) shall be inapplicable if a business entity is a publicly traded company: Provided, however, That subdivision (3) shall not include persons or business entities performing legal services related to the negotiation or drafting of the applicable contract.

GENERAL TERMS AND CONDITIONS:

1. **CONTRACTUAL AGREEMENT:** Issuance of a Award Document signed by the Purchasing Division Director, or his designee, and approved as to form by the Attorney General's office constitutes acceptance of this Contract made by and between the State of West Virginia and the Vendor. Vendor's signature on its bid signifies Vendor's agreement to be bound by and accept the terms and conditions contained in this Contract.
2. **DEFINITIONS:** As used in this Solicitation/Contract, the following terms shall have the meanings attributed to them below. Additional definitions may be found in the specifications included with this Solicitation/Contract.
 - 2.1. "Agency" or "Agencies" means the agency, board, commission, or other entity of the State of West Virginia that is identified on the first page of the Solicitation or any other public entity seeking to procure goods or services under this Contract.
 - 2.2. "Bid" or "Proposal" means the vendors submitted response to this solicitation.
 - 2.3. "Contract" means the binding agreement that is entered into between the State and the Vendor to provide the goods or services requested in the Solicitation.
 - 2.4. "Director" means the Director of the West Virginia Department of Administration, Purchasing Division.
 - 2.5. "Purchasing Division" means the West Virginia Department of Administration, Purchasing Division.
 - 2.6. "Award Document" means the document signed by the Agency and the Purchasing Division, and approved as to form by the Attorney General, that identifies the Vendor as the contract holder.
 - 2.7. "Solicitation" means the official notice of an opportunity to supply the State with goods or services that is published by the Purchasing Division.
 - 2.8. "State" means the State of West Virginia and/or any of its agencies, commissions, boards, etc. as context requires.
 - 2.9. "Vendor" or "Vendors" means any entity submitting a bid in response to the Solicitation, the entity that has been selected as the lowest responsible bidder, or the entity that has been awarded the Contract as context requires.

3. CONTRACT TERM; RENEWAL; EXTENSION: The term of this Contract shall be determined in accordance with the category that has been identified as applicable to this Contract below:

Term Contract

Initial Contract Term: This Contract becomes effective on UPON AWARD and extends for a period of ONE (1) year(s).

Renewal Term: This Contract may be renewed upon the mutual written consent of the Agency, and the Vendor, with approval of the Purchasing Division and the Attorney General's office (Attorney General approval is as to form only). Any request for renewal should be delivered to the Agency and then submitted to the Purchasing Division thirty (30) days prior to the expiration date of the initial contract term or appropriate renewal term. A Contract renewal shall be in accordance with the terms and conditions of the original contract. Unless otherwise specified below, renewal of this Contract is limited to THREE (3) successive one (1) year periods or multiple renewal periods of less than one year, provided that the multiple renewal periods do not exceed the total number of months available in all renewal years combined. Automatic renewal of this Contract is prohibited. Renewals must be approved by the Vendor, Agency, Purchasing Division and Attorney General's office (Attorney General approval is as to form only)

Alternate Renewal Term – This contract may be renewed for _____ successive _____ year periods or shorter periods provided that they do not exceed the total number of months contained in all available renewals. Automatic renewal of this Contract is prohibited. Renewals must be approved by the Vendor, Agency, Purchasing Division and Attorney General's office (Attorney General approval is as to form only)

Delivery Order Limitations: In the event that this contract permits delivery orders, a delivery order may only be issued during the time this Contract is in effect. Any delivery order issued within one year of the expiration of this Contract shall be effective for one year from the date the delivery order is issued. No delivery order may be extended beyond one year after this Contract has expired.

Fixed Period Contract: This Contract becomes effective upon Vendor's receipt of the notice to proceed and must be completed within _____ days.

Fixed Period Contract with Renewals: This Contract becomes effective upon Vendor's receipt of the notice to proceed and part of the Contract more fully described in the attached specifications must be completed within _____ days. Upon completion of the work covered by the preceding sentence, the vendor agrees that maintenance, monitoring, or warranty services will be provided for _____ year(s) thereafter.

One Time Purchase: The term of this Contract shall run from the issuance of the Award Document until all of the goods contracted for have been delivered, but in no event will this Contract extend for more than one fiscal year.

Other: See attached.

4. NOTICE TO PROCEED: Vendor shall begin performance of this Contract immediately upon receiving notice to proceed unless otherwise instructed by the Agency. Unless otherwise specified, the fully executed Award Document will be considered notice to proceed.

5. QUANTITIES: The quantities required under this Contract shall be determined in accordance with the category that has been identified as applicable to this Contract below.

Open End Contract: Quantities listed in this Solicitation are approximations only, based on estimates supplied by the Agency. It is understood and agreed that the Contract shall cover the quantities actually ordered for delivery during the term of the Contract, whether more or less than the quantities shown.

Service: The scope of the service to be provided will be more clearly defined in the specifications included herewith.

Combined Service and Goods: The scope of the service and deliverable goods to be provided will be more clearly defined in the specifications included herewith.

One Time Purchase: This Contract is for the purchase of a set quantity of goods that are identified in the specifications included herewith. Once those items have been delivered, no additional goods may be procured under this Contract without an appropriate change order approved by the Vendor, Agency, Purchasing Division, and Attorney General's office.

6. EMERGENCY PURCHASES: The Purchasing Division Director may authorize the Agency to purchase goods or services in the open market that Vendor would otherwise provide under this Contract if those goods or services are for immediate or expedited delivery in an emergency. Emergencies shall include, but are not limited to, delays in transportation or an unanticipated increase in the volume of work. An emergency purchase in the open market, approved by the Purchasing Division Director, shall not constitute a breach of this Contract and shall not entitle the Vendor to any form of compensation or damages. This provision does not excuse the State from fulfilling its obligations under a One Time Purchase contract.

7. REQUIRED DOCUMENTS: All of the items checked below must be provided to the Purchasing Division by the Vendor as specified below.

BID BOND (Construction Only): Pursuant to the requirements contained in W. Va. Code § 5-22-1(c), All Vendors submitting a bid on a construction project shall furnish a valid bid bond in the amount of five percent (5%) of the total amount of the bid protecting the State of West Virginia. The bid bond must be submitted with the bid.

PERFORMANCE BOND: The apparent successful Vendor shall provide a performance bond in the amount of _____. The performance bond must be received by the Purchasing Division prior to Contract award. On construction contracts, the performance bond must be 100% of the Contract value.

LABOR/MATERIAL PAYMENT BOND: The apparent successful Vendor shall provide a labor/material payment bond in the amount of 100% of the Contract value. The labor/material payment bond must be delivered to the Purchasing Division prior to Contract award.

In lieu of the Bid Bond, Performance Bond, and Labor/Material Payment Bond, the Vendor may provide certified checks, cashier's checks, or irrevocable letters of credit. Any certified check, cashier's check, or irrevocable letter of credit provided in lieu of a bond must be of the same amount and delivered on the same schedule as the bond it replaces. A letter of credit submitted in lieu of a performance and labor/material payment bond will only be allowed for projects under \$100,000. Personal or business checks are not acceptable. Notwithstanding the foregoing, West Virginia Code § 5-22-1 (d) mandates that a vendor provide a performance and labor/material payment bond for construction projects. Accordingly, substitutions for the performance and labor/material payment bonds for construction projects is not permitted.

MAINTENANCE BOND: The apparent successful Vendor shall provide a two (2) year maintenance bond covering the roofing system. The maintenance bond must be issued and delivered to the Purchasing Division prior to Contract award.

LICENSE(S) / CERTIFICATIONS / PERMITS: In addition to anything required under the Section entitled Licensing, of the General Terms and Conditions, the apparent successful Vendor shall furnish proof of the following licenses, certifications, and/or permits prior to Contract award, in a form acceptable to the Purchasing Division.

The apparent successful Vendor shall also furnish proof of any additional licenses or certifications contained in the specifications prior to Contract award regardless of whether or not that requirement is listed above.

8. INSURANCE: The apparent successful Vendor shall furnish proof of the insurance identified by a checkmark below prior to Contract award. Subsequent to contract award, and prior to the insurance expiration date, Vendor shall provide the Agency with proof that the insurance mandated herein has been continued. Vendor must also provide Agency with immediate notice of any changes in its insurance policies mandated herein, including but not limited to, policy cancelation, policy reduction, or change in insurers. The insurance coverages identified below must be maintained throughout the life of this contract. The apparent successful Vendor shall also furnish proof of any additional insurance requirements contained in the specifications prior to Contract award regardless of whether or not that insurance requirement is listed in this section.

Vendor must maintain:

Commercial General Liability Insurance in at least an amount of: \$500,000.00

Automobile Liability Insurance in at least an amount of: \$500,000.00

Professional/Malpractice/Errors and Omission Insurance in at least an amount of: _____

Commercial Crime and Third Party Fidelity Insurance in an amount of: _____

Cyber Liability Insurance in an amount of: _____

Builders Risk Insurance in an amount equal to 100% of the amount of the Contract.

9. WORKERS' COMPENSATION INSURANCE: The apparent successful Vendor shall comply with laws relating to workers compensation, shall maintain workers' compensation insurance when required, and shall furnish proof of workers' compensation insurance upon request.

10. [Reserved]

11. LIQUIDATED DAMAGES: This clause shall in no way be considered exclusive and shall not limit the State or Agency's right to pursue any other available remedy. Vendor shall pay liquidated damages in the amount specified below or as described in the specifications:

_____ for _____

Liquidated Damages Contained in the Specifications

12. ACCEPTANCE: Vendor's signature on its bid, or on the certification and signature page, constitutes an offer to the State that cannot be unilaterally withdrawn, signifies that the product or service proposed by vendor meets the mandatory requirements contained in the Solicitation for that product or service, unless otherwise indicated, and signifies acceptance of the terms and conditions contained in the Solicitation unless otherwise indicated.

13. PRICING: The pricing set forth herein is firm for the life of the Contract, unless specified elsewhere within this Solicitation/Contract by the State. A Vendor's inclusion of price adjustment provisions in its bid, without an express authorization from the State in the Solicitation to do so, may result in bid disqualification.

14. PAYMENT: Payment in advance is prohibited under this Contract. Payment may only be made after the delivery and acceptance of goods or services. The Vendor shall submit invoices, in arrears.

15. PURCHASING CARD ACCEPTANCE: The State of West Virginia currently utilizes a Purchasing Card program, administered under contract by a banking institution, to process payment for goods and services. The Vendor must accept the State of West Virginia's Purchasing Card for payment of all orders under this Contract unless the box below is checked.

Vendor is not required to accept the State of West Virginia's Purchasing Card as payment for all goods and services.

- 16. TAXES:** The Vendor shall pay any applicable sales, use, personal property or any other taxes arising out of this Contract and the transactions contemplated thereby. The State of West Virginia is exempt from federal and state taxes and will not pay or reimburse such taxes.
- 17. ADDITIONAL FEES:** Vendor is not permitted to charge additional fees or assess additional charges that were not either expressly provided for in the solicitation published by the State of West Virginia or included in the unit price or lump sum bid amount that Vendor is required by the solicitation to provide. Including such fees or charges as notes to the solicitation may result in rejection of vendor's bid. Requesting such fees or charges be paid after the contract has been awarded may result in cancellation of the contract.
- 18. FUNDING:** This Contract shall continue for the term stated herein, contingent upon funds being appropriated by the Legislature or otherwise being made available. In the event funds are not appropriated or otherwise made available, this Contract becomes void and of no effect beginning on July 1 of the fiscal year for which funding has not been appropriated or otherwise made available.
- 19. CANCELLATION:** The Purchasing Division Director reserves the right to cancel this Contract immediately upon written notice to the vendor if the materials or workmanship supplied do not conform to the specifications contained in the Contract. The Purchasing Division Director may also cancel any purchase or Contract upon 30 days written notice to the Vendor in accordance with West Virginia Code of State Rules § 148-1-5.2.b.
- 20. TIME:** Time is of the essence with regard to all matters of time and performance in this Contract.
- 21. APPLICABLE LAW:** This Contract is governed by and interpreted under West Virginia law without giving effect to its choice of law principles. Any information provided in specification manuals, or any other source, verbal or written, which contradicts or violates the West Virginia Constitution, West Virginia Code or West Virginia Code of State Rules is void and of no effect.
- 22. COMPLIANCE WITH LAWS:** Vendor shall comply with all applicable federal, state, and local laws, regulations and ordinances. By submitting a bid, Vendor acknowledges that it has reviewed, understands, and will comply with all applicable laws, regulations, and ordinances.
- SUBCONTRACTOR COMPLIANCE:** Vendor shall notify all subcontractors providing commodities or services related to this Contract that as subcontractors, they too are required to comply with all applicable laws, regulations, and ordinances. Notification under this provision must occur prior to the performance of any work under the contract by the subcontractor.
- 23. ARBITRATION:** Any references made to arbitration contained in this Contract, Vendor's bid, or in any American Institute of Architects documents pertaining to this Contract are hereby deleted, void, and of no effect.

- 24. MODIFICATIONS:** This writing is the parties' final expression of intent. Notwithstanding anything contained in this Contract to the contrary no modification of this Contract shall be binding without mutual written consent of the Agency, and the Vendor, with approval of the Purchasing Division and the Attorney General's office (Attorney General approval is as to form only). Any change to existing contracts that adds work or changes contract cost, and were not included in the original contract, must be approved by the Purchasing Division and the Attorney General's Office (as to form) prior to the implementation of the change or commencement of work affected by the change.
- 25. WAIVER:** The failure of either party to insist upon a strict performance of any of the terms or provision of this Contract, or to exercise any option, right, or remedy herein contained, shall not be construed as a waiver or a relinquishment for the future of such term, provision, option, right, or remedy, but the same shall continue in full force and effect. Any waiver must be expressly stated in writing and signed by the waiving party.
- 26. SUBSEQUENT FORMS:** The terms and conditions contained in this Contract shall supersede any and all subsequent terms and conditions which may appear on any form documents submitted by Vendor to the Agency or Purchasing Division such as price lists, order forms, invoices, sales agreements, or maintenance agreements, and includes internet websites or other electronic documents. Acceptance or use of Vendor's forms does not constitute acceptance of the terms and conditions contained thereon.
- 27. ASSIGNMENT:** Neither this Contract nor any monies due, or to become due hereunder, may be assigned by the Vendor without the express written consent of the Agency, the Purchasing Division, the Attorney General's office (as to form only), and any other government agency or office that may be required to approve such assignments. Notwithstanding the foregoing, Purchasing Division approval may or may not be required on certain agency delegated or exempt purchases.
- 28. WARRANTY:** The Vendor expressly warrants that the goods and/or services covered by this Contract will: (a) conform to the specifications, drawings, samples, or other description furnished or specified by the Agency; (b) be merchantable and fit for the purpose intended; and (c) be free from defect in material and workmanship.
- 29. STATE EMPLOYEES:** State employees are not permitted to utilize this Contract for personal use and the Vendor is prohibited from permitting or facilitating the same.
- 30. BANKRUPTCY:** In the event the Vendor files for bankruptcy protection, the State of West Virginia may deem this Contract null and void, and terminate this Contract without notice.
- 31. PRIVACY, SECURITY, AND CONFIDENTIALITY:** The Vendor agrees that it will not disclose to anyone, directly or indirectly, any such personally identifiable information or other confidential information gained from the Agency, unless the individual who is the subject of the information consents to the disclosure in writing or the disclosure is made pursuant to the Agency's policies, procedures, and rules. Vendor further agrees to comply with the Confidentiality Policies and Information Security Accountability Requirements, set forth in <http://www.state.wv.us/admin/purchase/privacy/default.html>.

32. YOUR SUBMISSION IS A PUBLIC DOCUMENT: Vendor's entire response to the Solicitation and the resulting Contract are public documents. As public documents, they will be disclosed to the public following the bid/proposal opening or award of the contract, as required by the competitive bidding laws of West Virginia Code §§ 5A-3-1 et seq., 5-22-1 et seq., and 5G-1-1 et seq. and the Freedom of Information Act West Virginia Code §§ 29B-1-1 et seq.

DO NOT SUBMIT MATERIAL YOU CONSIDER TO BE CONFIDENTIAL, A TRADE SECRET, OR OTHERWISE NOT SUBJECT TO PUBLIC DISCLOSURE.

Submission of any bid, proposal, or other document to the Purchasing Division constitutes your explicit consent to the subsequent public disclosure of the bid, proposal, or document. The Purchasing Division will disclose any document labeled "confidential," "proprietary," "trade secret," "private," or labeled with any other claim against public disclosure of the documents, to include any "trade secrets" as defined by West Virginia Code § 47-22-1 et seq. All submissions are subject to public disclosure without notice.

33. LICENSING: In accordance with West Virginia Code of State Rules § 148-1-6.1.e, Vendor must be licensed and in good standing in accordance with any and all state and local laws and requirements by any state or local agency of West Virginia, including, but not limited to, the West Virginia Secretary of State's Office, the West Virginia Tax Department, West Virginia Insurance Commission, or any other state agency or political subdivision. Obligations related to political subdivisions may include, but are not limited to, business licensing, business and occupation taxes, inspection compliance, permitting, etc. Upon request, the Vendor must provide all necessary releases to obtain information to enable the Purchasing Division Director or the Agency to verify that the Vendor is licensed and in good standing with the above entities.

SUBCONTRACTOR COMPLIANCE: Vendor shall notify all subcontractors providing commodities or services related to this Contract that as subcontractors, they too are required to be licensed, in good standing, and up-to-date on all state and local obligations as described in this section. Obligations related to political subdivisions may include, but are not limited to, business licensing, business and occupation taxes, inspection compliance, permitting, etc. Notification under this provision must occur prior to the performance of any work under the contract by the subcontractor.

34. ANTITRUST: In submitting a bid to, signing a contract with, or accepting a Award Document from any agency of the State of West Virginia, the Vendor agrees to convey, sell, assign, or transfer to the State of West Virginia all rights, title, and interest in and to all causes of action it may now or hereafter acquire under the antitrust laws of the United States and the State of West Virginia for price fixing and/or unreasonable restraints of trade relating to the particular commodities or services purchased or acquired by the State of West Virginia. Such assignment shall be made and become effective at the time the purchasing agency tenders the initial payment to Vendor.

35. VENDOR CERTIFICATIONS: By signing its bid or entering into this Contract, Vendor certifies (1) that its bid or offer was made without prior understanding, agreement, or connection with any corporation, firm, limited liability company, partnership, person or entity submitting a bid or offer for the same material, supplies, equipment or services; (2) that its bid or offer is in all respects fair and without collusion or fraud; (3) that this Contract is accepted or entered into without any prior understanding, agreement, or connection to any other entity that could be considered a violation of law; and (4) that it has reviewed this Solicitation in its entirety; understands the requirements, terms and conditions, and other information contained herein.

Vendor's signature on its bid or offer also affirms that neither it nor its representatives have any interest, nor shall acquire any interest, direct or indirect, which would compromise the performance of its services hereunder. Any such interests shall be promptly presented in detail to the Agency. The individual signing this bid or offer on behalf of Vendor certifies that he or she is authorized by the Vendor to execute this bid or offer or any documents related thereto on Vendor's behalf; that he or she is authorized to bind the Vendor in a contractual relationship; and that, to the best of his or her knowledge, the Vendor has properly registered with any State agency that may require registration.

36. VENDOR RELATIONSHIP: The relationship of the Vendor to the State shall be that of an independent contractor and no principal-agent relationship or employer-employee relationship is contemplated or created by this Contract. The Vendor as an independent contractor is solely liable for the acts and omissions of its employees and agents. Vendor shall be responsible for selecting, supervising, and compensating any and all individuals employed pursuant to the terms of this Solicitation and resulting contract. Neither the Vendor, nor any employees or subcontractors of the Vendor, shall be deemed to be employees of the State for any purpose whatsoever. Vendor shall be exclusively responsible for payment of employees and contractors for all wages and salaries, taxes, withholding payments, penalties, fees, fringe benefits, professional liability insurance premiums, contributions to insurance and pension, or other deferred compensation plans, including but not limited to, Workers' Compensation and Social Security obligations, licensing fees, etc. and the filing of all necessary documents, forms, and returns pertinent to all of the foregoing.

Vendor shall hold harmless the State, and shall provide the State and Agency with a defense against any and all claims including, but not limited to, the foregoing payments, withholdings, contributions, taxes, Social Security taxes, and employer income tax returns.

37. INDEMNIFICATION: The Vendor agrees to indemnify, defend, and hold harmless the State and the Agency, their officers, and employees from and against: (1) Any claims or losses for services rendered by any subcontractor, person, or firm performing or supplying services, materials, or supplies in connection with the performance of the Contract; (2) Any claims or losses resulting to any person or entity injured or damaged by the Vendor, its officers, employees, or subcontractors by the publication, translation, reproduction, delivery, performance, use, or disposition of any data used under the Contract in a manner not authorized by the Contract, or by Federal or State statutes or regulations; and (3) Any failure of the Vendor, its officers, employees, or subcontractors to observe State and Federal laws including, but not limited to, labor and wage and hour laws.

38. PURCHASING AFFIDAVIT: In accordance with West Virginia Code § 5-22-1(i), the contracting public entity shall not award a contract for a construction project to any bidder that is known to be in default on any monetary obligation owed to the state or a political subdivision of the state, including, but not limited to, obligations related to payroll taxes, property taxes, sales and use taxes, fire service fees, or other fines or fees. Accordingly, prior to contract award, Vendors are required to sign, notarize, and submit the Purchasing Affidavit to the Purchasing Division affirming under oath that it is not in default on any monetary obligation owed to the state or a political subdivision of the state.

39. ADDITIONAL AGENCY AND LOCAL GOVERNMENT USE: This Contract may be utilized by other agencies, spending units, and political subdivisions of the State of West Virginia; county, municipal, and other local government bodies; and school districts ("Other Government Entities"). Any extension of this Contract to the aforementioned Other Government Entities must be on the same prices, terms, and conditions as those offered and agreed to in this Contract, provided that such extension is in compliance with the applicable laws, rules, and ordinances of the Other Government Entity. If the Vendor does not wish to extend the prices, terms, and conditions of its bid and subsequent contract to the Other Government Entities, the Vendor must clearly indicate such refusal in its bid. A refusal to extend this Contract to the Other Government Entities shall not impact or influence the award of this Contract in any manner.

40. CONFLICT OF INTEREST: Vendor, its officers or members or employees, shall not presently have or acquire an interest, direct or indirect, which would conflict with or compromise the performance of its obligations hereunder. Vendor shall periodically inquire of its officers, members and employees to ensure that a conflict of interest does not arise. Any conflict of interest discovered shall be promptly presented in detail to the Agency.

41. REPORTS: Vendor shall provide the Agency and/or the Purchasing Division with the following reports identified by a checked box below:

Such reports as the Agency and/or the Purchasing Division may request. Requested reports may include, but are not limited to, quantities purchased, agencies utilizing the contract, total contract expenditures by agency, etc.

Quarterly reports detailing the total quantity of purchases in units and dollars, along with a listing of purchases by agency. Quarterly reports should be delivered to the Purchasing Division via email at purchasing.requisitions@wv.gov.

42. BACKGROUND CHECK: In accordance with W. Va. Code § 15-2D-3, the Director of the Division of Protective Services shall require any service provider whose employees are regularly employed on the grounds or in the buildings of the Capitol complex or who have access to sensitive or critical information to submit to a fingerprint-based state and federal background inquiry through the state repository. The service provider is responsible for any costs associated with the fingerprint-based state and federal background inquiry.

After the contract for such services has been approved, but before any such employees are permitted to be on the grounds or in the buildings of the Capitol complex or have access to sensitive or critical information, the service provider shall submit a list of all persons who will be physically present and working at the Capitol complex to the Director of the Division of

Protective Services for purposes of verifying compliance with this provision. The State reserves the right to prohibit a service provider's employees from accessing sensitive or critical information or to be present at the Capitol complex based upon results addressed from a criminal background check.

Service providers should contact the West Virginia Division of Protective Services by phone at (304) 558-9911 for more information.

43. PREFERENCE FOR USE OF DOMESTIC STEEL PRODUCTS: Except when authorized by the Director of the Purchasing Division pursuant to W. Va. Code § 5A-3-56, no contractor may use or supply steel products for a State Contract Project other than those steel products made in the United States. A contractor who uses steel products in violation of this section may be subject to civil penalties pursuant to W. Va. Code § 5A-3-56. As used in this section:

- a. "State Contract Project" means any erection or construction of, or any addition to, alteration of or other improvement to any building or structure, including, but not limited to, roads or highways, or the installation of any heating or cooling or ventilating plants or other equipment, or the supply of and materials for such projects, pursuant to a contract with the State of West Virginia for which bids were solicited on or after June 6, 2001.
- b. "Steel Products" means products rolled, formed, shaped, drawn, extruded, forged, cast, fabricated or otherwise similarly processed, or processed by a combination of two or more or such operations, from steel made by the open heath, basic oxygen, electric furnace, Bessemer or other steel making process. The Purchasing Division Director may, in writing, authorize the use of foreign steel products if:
 - c. The cost for each contract item used does not exceed one tenth of one percent (.1%) of the total contract cost or two thousand five hundred dollars (\$2,500.00), whichever is greater. For the purposes of this section, the cost is the value of the steel product as delivered to the project; or
 - d. The Director of the Purchasing Division determines that specified steel materials are not produced in the United States in sufficient quantity or otherwise are not reasonably available to meet contract requirements.

44. PREFERENCE FOR USE OF DOMESTIC ALUMINUM, GLASS, AND STEEL: In Accordance with W. Va. Code § 5-19-1 et seq., and W. Va. CSR § 148-10-1 et seq., for every contract or subcontract, subject to the limitations contained herein, for the construction, reconstruction, alteration, repair, improvement or maintenance of public works or for the purchase of any item of machinery or equipment to be used at sites of public works, only domestic aluminum, glass or steel products shall be supplied unless the spending officer determines, in writing, after the receipt of offers or bids, (1) that the cost of domestic aluminum, glass or steel products is unreasonable or inconsistent with the public interest of the State of West Virginia, (2) that domestic aluminum, glass or steel products are not produced in sufficient quantities to meet the contract requirements, or (3) the available domestic aluminum, glass, or steel do not meet the contract specifications. This provision only applies to public works contracts awarded in an amount more than fifty thousand dollars (\$50,000) or public works contracts that require more than ten thousand pounds of steel products.

The cost of domestic aluminum, glass, or steel products may be unreasonable if the cost is more than twenty percent (20%) of the bid or offered price for foreign made aluminum, glass, or steel products. If the domestic aluminum, glass or steel products to be supplied or produced in a "substantial labor surplus area", as defined by the United States Department of Labor, the cost of domestic aluminum, glass, or steel products may be unreasonable if the cost is more than thirty percent (30%) of the bid or offered price for foreign made aluminum, glass, or steel products. This preference shall be applied to an item of machinery or equipment, as indicated above, when the item is a single unit of equipment or machinery manufactured primarily of aluminum, glass or steel, is part of a public works contract and has the sole purpose or of being a permanent part of a single public works project. This provision does not apply to equipment or machinery purchased by a spending unit for use by that spending unit and not as part of a single public works project.

All bids and offers including domestic aluminum, glass or steel products that exceed bid or offer prices including foreign aluminum, glass or steel products after application of the preferences provided in this provision may be reduced to a price equal to or lower than the lowest bid or offer price for foreign aluminum, glass or steel products plus the applicable preference. If the reduced bid or offer prices are made in writing and supersede the prior bid or offer prices, all bids or offers, including the reduced bid or offer prices, will be reevaluated in accordance with this rule.

45. INTERESTED PARTY SUPPLEMENTAL DISCLOSURE: W. Va. Code § 6D-1-2 requires that for contracts with an actual or estimated value of at least \$100,000, the vendor must submit to the Agency a supplemental disclosure of interested parties reflecting any new or differing interested parties to the contract, which were not included in the original pre-award interested party disclosure, within 30 days following the completion or termination of the contract. A copy of that form is included with this solicitation or can be obtained from the WV Ethics Commission. "Interested parties" means: (1) A business entity performing work or service pursuant to, or in furtherance of, the applicable contract, including specifically sub-contractors; (2) the person(s) who have an ownership interest equal to or greater than 25% in the business entity performing work or service pursuant to, or in furtherance of, the applicable contract; and (3) the person or business entity, if any, that served as a compensated broker or intermediary to actively facilitate the applicable contract or negotiated the terms of the applicable contract with the state agency: Provided, That subdivision (2) shall be inapplicable if a business entity is a publicly traded company: Provided, however, That subdivision (3) shall not include persons or business entities performing legal services related to the negotiation or drafting of the applicable contract. The Agency shall submit a copy of the disclosure to the Ethics Commission within 15 days after receiving the supplemental disclosure of interested parties.

DESIGNATED CONTACT: Vendor appoints the individual identified in this Section as the Contract Administrator and the initial point of contact for matters relating to this Contract.

Erin Jones
 (Name, Title)
Erin Jones
 (Printed Name and Title)
250 12st W Huntington, WV. 25704
 (Address)
1-800-624-3433 (304)523-5337
 (Phone Number) / (Fax Number)
erin.jones @ wva electric.com
 (email address)

CERTIFICATION AND SIGNATURE: By signing below, or submitting documentation through wvOASIS, I certify that I have reviewed this Solicitation in its entirety; that I understand the requirements, terms and conditions, and other information contained herein; that this bid, offer or proposal constitutes an offer to the State that cannot be unilaterally withdrawn; that the product or service proposed meets the mandatory requirements contained in the Solicitation for that product or service, unless otherwise stated herein; that the Vendor accepts the terms and conditions contained in the Solicitation, unless otherwise stated herein; that I am submitting this bid, offer or proposal for review and consideration; that I am authorized by the vendor to execute and submit this bid, offer, or proposal, or any documents related thereto on vendor's behalf; that I am authorized to bind the vendor in a contractual relationship; and that to the best of my knowledge, the vendor has properly registered with any State agency that may require registration.

Wva Electric Supply
 (Company)
Tony Barber VP
 (Authorized Signature) (Representative Name, Title)
TONY BARBER VP
 (Printed Name and Title of Authorized Representative)
2/27/2018
 (Date)
304-525-0361 ext. 4530 Fax (304)525-2726
 (Phone Number) (Fax Number)

REQUEST FOR QUOTATION
Light18 - Bulbs, and Ballast

- 9.4 **Contract Manager:** During its performance of this Contract, Vendor must designate and maintain a primary contract manager responsible for overseeing Vendor's responsibilities under this Contract. The Contract manager must be available during normal business hours to address any customer service or other issues related to this Contract. Vendor should list its Contract manager and his or her contact information below.

Contract Manager: Erin Jones

Telephone Number: 1-800-624-3433

Fax Number: 304-523-5337

Email Address: erin.jones@wvraelectric.com

State of West Virginia VENDOR PREFERENCE CERTIFICATE

Certification and application is hereby made for Preference in accordance with *West Virginia Code*, §5A-3-37. (Does not apply to construction contracts). *West Virginia Code*, §5A-3-37, provides an opportunity for qualifying vendors to request (at the time of bid) preference for their residency status. Such preference is an evaluation method only and will be applied only to the cost bid in accordance with the *West Virginia Code*. This certificate for application is to be used to request such preference. The Purchasing Division will make the determination of the Vendor Preference, if applicable.

- 1. Application is made for 2.5% vendor preference for the reason checked:
Bidder is an individual resident vendor and has resided continuously in West Virginia, or bidder is a partnership, association or corporation resident vendor and has maintained its headquarters or principal place of business continuously in West Virginia, for four (4) years immediately preceding the date of this certification; or,
- Bidder is a resident vendor partnership, association, or corporation with at least eighty percent of ownership interest of bidder held by another entity that meets the applicable four year residency requirement; or,
- Bidder is a nonresident vendor which has an affiliate or subsidiary which employs a minimum of one hundred state residents and which has maintained its headquarters or principal place of business within West Virginia continuously for the four (4) years immediately preceding the date of this certification; or,

- 2. Application is made for 2.5% vendor preference for the reason checked:
Bidder is a resident vendor who certifies that, during the life of the contract, on average at least 75% of the employees working on the project being bid are residents of West Virginia who have resided in the state continuously for the two years immediately preceding submission of this bid; or,

- 3. Application is made for 2.5% vendor preference for the reason checked:
Bidder is a nonresident vendor that employs a minimum of one hundred state residents, or a nonresident vendor which has an affiliate or subsidiary which maintains its headquarters or principal place of business within West Virginia and employs a minimum of one hundred state residents, and for purposes of producing or distributing the commodities or completing the project which is the subject of the bidder's bid and continuously over the entire term of the project, on average at least seventy-five percent of the bidder's employees or the bidder's affiliate's or subsidiary's employees are residents of West Virginia who have resided in the state continuously for the two immediately preceding years and the vendor's bid; or,

- 4. Application is made for 5% vendor preference for the reason checked:
Bidder meets either the requirement of both subdivisions (1) and (2) or subdivision (1) and (3) as stated above; or,

- 5. Application is made for 3.5% vendor preference who is a veteran for the reason checked:
Bidder is an individual resident vendor who is a veteran of the United States armed forces, the reserves or the National Guard and has resided in West Virginia continuously for the four years immediately preceding the date on which the bid is submitted; or,

- 6. Application is made for 3.5% vendor preference who is a veteran for the reason checked:
Bidder is a resident vendor who is a veteran of the United States armed forces, the reserves or the National Guard, if, for purposes of producing or distributing the commodities or completing the project which is the subject of the vendor's bid and continuously over the entire term of the project, on average at least seventy-five percent of the vendor's employees are residents of West Virginia who have resided in the state continuously for the two immediately preceding years.

- 7. Application is made for preference as a non-resident small, women- and minority-owned business, in accordance with *West Virginia Code* §5A-3-59 and *West Virginia Code of State Rules*.
Bidder has been or expects to be approved prior to contract award by the Purchasing Division as a certified small, women- and minority-owned business.

Bidder understands if the Secretary of Revenue determines that a Bidder receiving preference has failed to continue to meet the requirements for such preference, the Secretary may order the Director of Purchasing to: (a) rescind the contract or purchase order; or (b) assess a penalty against such Bidder in an amount not to exceed 5% of the bid amount and that such penalty will be paid to the contracting agency or deducted from any unpaid balance on the contract or purchase order.

By submission of this certificate, Bidder agrees to disclose any reasonably requested information to the Purchasing Division and authorizes the Department of Revenue to disclose to the Director of Purchasing appropriate information verifying that Bidder has paid the required business taxes, provided that such information does not contain the amounts of taxes paid nor any other information deemed by the Tax Commissioner to be confidential.

Bidder hereby certifies that this certificate is true and accurate in all respects; and that if a contract is issued to Bidder and if anything contained within this certificate changes during the term of the contract, Bidder will notify the Purchasing Division in writing immediately.

Bidder: W Va Electrical Supply

Signed: Tom Butler

Date: 2/27/2018

Title: VP

*Check any combination of preference consideration(s) indicated above, which you are entitled to receive.

West Virginia Ethics Commission



Disclosure of Interested Parties to Contracts

Pursuant to *W. Va. Code* § 6D-1-2, a state agency may not enter into a contract, or a series of related contracts, that has/have an actual or estimated value of \$100,000 or more until the business entity submits to the contracting state agency a Disclosure of Interested Parties to the applicable contract. In addition, the business entity awarded a contract is obligated to submit a supplemental Disclosure of Interested Parties reflecting any new or differing interested parties to the contract within 30 days following the completion or termination of the applicable contract.

For purposes of complying with these requirements, the following definitions apply:

"Business entity" means any entity recognized by law through which business is conducted, including a sole proprietorship, partnership or corporation.

"Interested party" or "Interested parties" means:

- (1) A business entity performing work or service pursuant to, or in furtherance of, the applicable contract, including specifically sub-contractors;
- (2) the person(s) who have an ownership interest equal to or greater than 25% in the business entity performing work or service pursuant to, or in furtherance of, the applicable contract. (This subdivision does not apply to a publicly traded company); and
- (3) the person or business entity, if any, that served as a compensated broker or intermediary to actively facilitate the applicable contract or negotiated the terms of the applicable contract with the state agency. (This subdivision does not apply to persons or business entities performing legal services related to the negotiation or drafting of the applicable contract.)

"State agency" means a board, commission, office, department or other agency in the executive, judicial or legislative branch of state government, including publicly funded institutions of higher education: Provided, that for purposes of *W. Va. Code* § 6D-1-2, the West Virginia Investment Management Board shall not be deemed a state agency nor subject to the requirements of that provision.

The contracting business entity must complete this form and submit it to the contracting state agency prior to contract award and to complete another form within 30 days of contract completion or termination.

This form was created by the State of West Virginia Ethics Commission, 210 Brooks Street, Suite 300, Charleston, WV 25301-1804. Telephone: (304)558-0864; fax: (304)558-2169; e-mail: ethics@wv.gov; website: www.ethics.wv.gov.

West Virginia Ethics Commission
Disclosure of Interested Parties to Contracts
(Required by W. Va. Code § 6D-1-2)

Contracting Business Entity: WVA Electric Supply Address: 250 12th St W

Authorized Agent: Tony Barber Huntington, WV 25704

Contract Number: SWC1800000012 Address: 250 12th St W Huntington, WV

Contract Description: Lamp/Bulbs/Batteries

Governmental agency awarding contract: State of West Virginia

Check here if this is a Supplemental Disclosure

List the Names of Interested Parties to the contract which are known or reasonably anticipated by the contracting business entity for each category below (attach additional pages if necessary):

1. Subcontractors or other entities performing work or service under the Contract

Check here if none, otherwise list entity/individual names below.

2. Any person or entity who owns 25% or more of contracting entity (not applicable to publicly traded entities)

Check here if none, otherwise list entity/individual names below.

3. Any person or entity that facilitated, or negotiated the terms of, the applicable contract (excluding legal services related to the negotiation or drafting of the applicable contract)

Check here if none, otherwise list entity/individual names below.

Signature: Tony Barber

Date Signed: 2/27/2018

Notary Verification

State of W.V.A. County of Cabell

I, Tony Barber, the authorized agent of the contracting business entity listed above, being duly sworn, acknowledge that the Disclosure herein is being made under oath and under the penalty of perjury.

Taken, sworn to and subscribed before me this 27th day of February 2018.

Sharon A. Maynard
Notary Public's Signature

To be completed by State Agency:

Date Received by State Agency: _____

Date submitted to Ethics Commission: _____

Governmental agency submitting Disclosure: _____



STATE OF WEST VIRGINIA
Purchasing Division

PURCHASING AFFIDAVIT

CONSTRUCTION CONTRACTS: Under W. Va. Code § 5-22-1(f), the contracting public entity shall not award a construction contract to any bidder that is known to be in default on any monetary obligation owed to the state or a political subdivision of the state, including, but not limited to, obligations related to payroll taxes, property taxes, sales and use taxes, fire service fees, or other fines or fees.

ALL CONTRACTS: Under W. Va. Code §5A-3-10a, no contract or renewal of any contract may be awarded by the state or any of its political subdivisions to any vendor or prospective vendor when the vendor or prospective vendor or a related party to the vendor or prospective vendor is a debtor and: (1) the debt owed is an amount greater than one thousand dollars in the aggregate; or (2) the debtor is in employer default.

EXCEPTION: The prohibition listed above does not apply where a vendor has contested any tax administered pursuant to chapter eleven of the W. Va. Code, workers' compensation premium, permit fee or environmental fee or assessment and the matter has not become final or where the vendor has entered into a payment plan or agreement and the vendor is not in default of any of the provisions of such plan or agreement.

DEFINITIONS:

"Debt" means any assessment, premium, penalty, fine, tax or other amount of money owed to the state or any of its political subdivisions because of a judgment, fine, permit violation, license assessment, defaulted workers' compensation premium, penalty or other assessment presently delinquent or due and required to be paid to the state or any of its political subdivisions, including any interest or additional penalties accrued thereon.

"Employer default" means having an outstanding balance or liability to the old fund or to the uninsured employers' fund or being in policy default, as defined in W. Va. Code § 23-20-2, failure to maintain mandatory workers' compensation coverage, or failure to fully meet its obligations as a workers' compensation self-insured employer. An employer is not in employer default if it has entered into a repayment agreement with the Insurance Commissioner and remains in compliance with the obligations under the repayment agreement.

"Related party" means a party, whether an individual, corporation, partnership, association, limited liability company or any other form or business association or other entity whatsoever, related to any vendor by blood, marriage, ownership or contract through which the party has a relationship of ownership or other interest with the vendor so that the party will actually or by effect receive or control a portion of the benefit, profit or other consideration from performance of a vendor contract with the party receiving an amount that meets or exceeds five percent of the total contract amount.

AFFIRMATION: By signing this form, the vendor's authorized signer affirms and acknowledges under penalty of law for false swearing (W. Va. Code §81-5-3) that: (1) for construction contracts, the vendor is not in default on any monetary obligation owed to the state or a political subdivision of the state, and (2) for all other contracts, that neither vendor nor any related party owes a debt as defined above and that neither vendor nor any related party are in employer default as defined above, unless the debt or employer default is permitted under the exception above.

WITNESS THE FOLLOWING SIGNATURE:

Vendor's Name: West Virginia Electric Supply

Authorized Signature: Tony Bule

Date: 2/27/2018

State of W. V. A.

County of Cabell, to-wit:

Taken, subscribed, and sworn to before me this 27th day of February, 2018

My Commission expires June 15, 2018.



NOTARY PUBLIC Sharon A. Maynard