

**ADVANCED ALARM
TECHNOLOGIES**

**BID FOR CCTV SYSTEM AT
WILLIAM R SHARPE HOSPITAL**

02/20/15 11:33:56
West Virginia Purchasing Division

Advanced Alarm Technologies, Inc.

A Full-Service Security Company

P.O. Box 4368 • Parkersburg, WV 26104 • 304-422-4387

State of WV
Purchasing Division
PO Box 50130
Charleston, WV 25305

2/12/15

Advanced Alarm Technologies is pleased to provide the enclosed quotation for your consideration. Also included with the quotation is product literature on the system we are recommending.

The Exacg Technologies Video Management System we are proposing can be Integrated directly to the existing Kantech Access Control System, which allows for a lot of features that might be implemented in the future. For example, there could be Duress Buttons connected to the System which would alert Security of a situation and the System would not only give an Audible Indication, but would also bring up the Camera associated with the area where the Alarm originated.

Thank you for allowing Advanced Alarm Technologies to quote your security needs.
If you have any questions, please call at your convenience.

Sincerely,

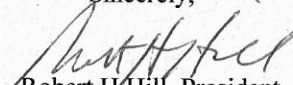

Robert H Hill, President



Purchasing Division
 2019 Washington Street East
 Post Office Box 50130
 Charleston, WV 25305-0130

State of West Virginia
 Request for Quotation

Proc Folder: 74028

Doc Description: PURCHASE AND COMPLETE INSTALLATION OF A CCTV SYSTEM

Proc Type: Central Purchase Order

Date Issued	Solicitation Closes	Solicitation No	Version
2015-02-03	2015-02-23 13:30:00	CRFQ 0506 WSH1500000005	1

BID RECEIVING LOCATION

BID CLERK
 DEPARTMENT OF ADMINISTRATION
 PURCHASING DIVISION
 2019 WASHINGTON ST E
 CHARLESTON WV 25305
 US

VENDOR

Vendor Name, Address and Telephone Number:

Advanced Alarm Technologies, Inc.
 PO Box 4368
 Parkersburg, WV 26104
 (304)422-4387

FOR INFORMATION CONTACT THE BUYER

Gregory Clay
 (304) 558-2566
 gregory.c.clay@wv.gov

Signature X

FEIN #

20-2085989

DATE

2/13/15

All offers subject to all terms and conditions contained in this solicitation

INVOICE TO		SHIP TO	
PROCUREMENT OFFICER - 304-269-1210 HEALTH AND HUMAN RESOURCES WILLIAM R SHARPE JR HOSPITAL 936 SHARPE HOSPITAL RD		PROCUREMENT OFFICER - 304-269-1210 HEALTH AND HUMAN RESOURCES WILLIAM R SHARPE JR HOSPITAL 936 SHARPE HOSPITAL RD	
WESTON	WV26452	WESTON	WV 26452
US		US	

Line	Comm Ln Desc	Qty	Unit Issue	Unit Price	Total Price
1	Purchase of parts, installation, and warranty of a CCTV Syst	1	1	\$275,000.00	\$275,000.00

Comm Code	Manufacturer	Specification	Model #
46171610			

See enclosed Price Sheet

Extended Description :

4.1.1 - 117 ea. Indoor Internet Protocol (IP) Cameras; 4.1.2 - 12 ea. Outdoor Internet Protocol (IP) Cameras; 4.1.3 - 2 ea. Network Video Recorder(s) NVRs); 4.1.4 - 11 ea. Desktop Computer with Monitor Stations; 4.1.5 - sufficient Network Switces to support the appropriate lenght of cabling; 4.1.6 - 1 lump sum Miscellaneous Materials for providing and installing CCTV to operational status; 4.1.7 All Labor necessary to complete project; 4.1.8 1 ea. One year Warranty on all Materials and Labor for entire CCTV System.

Item Number	Quantity	Description	Unit Cost	Extended Cost
4.1.1	117	Indoor IP Cameras - minimum of 1 megapixel 1280x720	325.00	38,025.00
4.1.2	12	Outdoor IP Cameras - minimum of 3 megapixels 1280x720	675.00	8,100.00
4.1.3	2	Network Video Recorder - include viewing software and able to accommodate the 129 cameras	36,500.00	73,000.00
4.1.4	11	Desktop Computer Monitoring Station - compatible with Windows 7 and include a 19 inch monitor	1,150.00	12,650.00
4.1.5		Network Switches - 24 port switch with Power over Ethernet, 1 gigabit (10/100/1000)	850.00	10,200.00
4.1.6	1	Miscellaneous installation materials and accessories needed to install, commission, and operate equipment	10,000.00	10,000.00
4.1.7	1	Labor - Installation and labor to install and program CCTV system. Set up workstations and system to operate and function correctly	123,025.00	123,025.00
4.1.8	1	One year warranty on all material and labor	0.00	0.00
				275,000.00

Scott Hill, President 2/13/15
Grand Total

Exacq Technologies
Matt Sorrells
11955 Exit 5 Pkwy
Fishers, IN 46037
October 29, 2014

Subject: Authorized Dealer Status

To whom it may concern,

Exacq Technologies, manufacturer of cutting edge video management software (VMS) and hardware solutions would like to provide this letter of authorized dealer status to Advanced Alarm Technologies who is based in Parkersburg, WV. Advanced Alarm Technologies is authorized to sell, install, and service all products that Exacq Technologies sells. They have the full support and backing of the factory and can support Exacq products with the high standards we demand from our dealers.

Matt Sorrells



Exacq Technologies
Regional Sales Manager
msorrells@exacq.com

REFERENCES

- 1) Braxton County Board of Education
98 Carter Braxton Dr.
Sutton, WV 26601
(304)765-7101
Contact: Brenda Wells
Installed Integrated Access Control System with Video Surveillance and Intercoms for all the Schools throughout the County which is administered from Board Office..
- 2) Goodwill Industries
3610 West Pike St.
Zanesville, Oh. 43701
(740)450-6060
Contact: Bob Waggoner, Facilities Director (Mobile: 740-319-5312)
Installed Video Surveillance Systems at facilities throughout Ohio & West Virginia
- 3) Silverheels Property Management
410 Third St.
Marietta, Oh. 45750
(740)374-8150
Contact: Mike Hinton (Mobile: 304-588-1405)
Installed Video Surveillance Systems at several commercial properties throughout Ohio and West Virginia

ADDITIONAL TERMS AND CONDITIONS (Construction Contracts Only)

1. **CONTRACTOR'S LICENSE:** West Virginia Code § 21-11-2 requires that all persons desiring to perform contracting work in this state be licensed. The West Virginia Contractors Licensing Board is empowered to issue the contractor's license. Applications for a contractor's license may be made by contacting the West Virginia Division of Labor. West Virginia Code § 21-11-11 requires any prospective Vendor to include the contractor's license number on its bid. Failure to include a contractor's license number on the bid shall result in Vendor's bid being disqualified. Vendors should include a contractor's license number in the space provided below.

Contractor's Name: Advanced Alarm Technologies, Inc.

Contractor's License No. WV025246

The apparent successful Vendor must furnish a copy of its contractor's license prior to the issuance of a Award Document.

2. **DRUG-FREE WORKPLACE AFFIDAVIT:** W. Va. Code § 21-1D-5 provides that any solicitation for a public improvement contract requires each Vendor that submits a bid for the work to submit at the same time an affidavit that the Vendor has a written plan for a drug-free workplace policy. To comply with this law, Vendor must either complete the enclosed drug-free workplace affidavit and submit the same with its bid or complete a similar affidavit that fulfills all of the requirements of the applicable code. Failure to submit the signed and notarized drug-free workplace affidavit or a similar affidavit that fully complies with the requirements of the applicable code, with the bid shall result in disqualification of Vendor's bid. Pursuant to W. Va. Code 21-1D-2(b) and (k), this provision does not apply to public improvement contracts the value of which is \$100,000 or less or temporary or emergency repairs.

2.1. **DRUG-FREE WORKPLACE POLICY:** Pursuant to W. Va. Code § 21-1D-4, Vendor and its subcontractors must implement and maintain a written drug-free workplace policy that complies with said article. The awarding public authority shall cancel this contract if: (1) Vendor fails to implement and maintain a written drug-free workplace policy described in the preceding paragraph, (2) Vendor fails to provide information regarding implementation of its drug-free workplace policy at the request of the public authority; or (3) Vendor provides to the public authority false information regarding the contractor's drug-free workplace policy. Pursuant to W. Va. Code 21-1D-2(b) and (k), this provision does not apply to public improvement contracts the value of which is \$100,000 or less or temporary or emergency repairs.

3. **DRUG FREE WORKPLACE REPORT:** Pursuant to W. Va. Code § 21-1D-7b, no less than once per year, or upon completion of the project, every contractor shall provide a certified report to the public authority which let the contract. For contracts over \$25,000, the

REQUEST FOR QUOTATION
CRFQ WSH150000005 Closed Circuit Television System

10.1.4. Failure to remedy deficient performance upon request.

10.2. The following remedies shall be available to Agency upon default.

10.2.1. Cancellation of the Contract.

10.2.2. Cancellation of one or more release orders issued under this Contract.

10.2.3. Any other remedies available in law or equity.

11. MISCELLANEOUS:

11.1. **Contract Manager:** During its performance of this Contract, Vendor must designate and maintain a primary contract manager responsible for overseeing Vendor's responsibilities under this Contract. The Contract manager must be available during normal business hours to address any customer service or other issues related to this Contract. Vendor should list its Contract manager and his or her contact information below.

Contract Manager: Robert H Hill

Telephone Number: (304) 422-4387

Fax Number: (304) 422-4387

Email Address: advancedalarm@suddenLink.net

ADDENDUM ACKNOWLEDGEMENT FORM
SOLICITATION NO.: WSH1500000005

Instructions: Please acknowledge receipt of all addenda issued with this solicitation by completing this addendum acknowledgment form. Check the box next to each addendum received and sign below. Failure to acknowledge addenda may result in bid disqualification.

Acknowledgment: I hereby acknowledge receipt of the following addenda and have made the necessary revisions to my proposal, plans and/or specification, etc.

Addendum Numbers Received:

(Check the box next to each addendum received)

- | | |
|--|--|
| <input checked="" type="checkbox"/> Addendum No. 1 | <input type="checkbox"/> Addendum No. 6 |
| <input type="checkbox"/> Addendum No. 2 | <input type="checkbox"/> Addendum No. 7 |
| <input type="checkbox"/> Addendum No. 3 | <input type="checkbox"/> Addendum No. 8 |
| <input type="checkbox"/> Addendum No. 4 | <input type="checkbox"/> Addendum No. 9 |
| <input type="checkbox"/> Addendum No. 5 | <input type="checkbox"/> Addendum No. 10 |

I understand that failure to confirm the receipt of addenda may be cause for rejection of this bid. I further understand that any verbal representation made or assumed to be made during any oral discussion held between Vendor's representatives and any state personnel is not binding. Only the information issued in writing and added to the specifications by an official addendum is binding.

Advanced Alarm Technologies, Inc.

Company

Authorized Signature

2/20/15

Date

NOTE: This addendum acknowledgment should be submitted with the bid to expedite document processing.

Revised 6/8/2012



**State of West Virginia
DRUG FREE WORKPLACE CONFORMANCE AFFIDAVIT
West Virginia Code §21-1D-5**

STATE OF WEST VIRGINIA,

COUNTY OF Wood, TO-WIT:

I, Robert H Hill, after being first duly sworn, depose and state as follows:

1. I am an employee of Advanced Alarm Technologies, Inc.; and,
(Company Name)
2. I do hereby attest that Advanced Alarm Technologies, Inc.
(Company Name)

maintains a valid written drug free workplace policy and that such policy is in compliance with **West Virginia Code §21-1D.**

The above statements are sworn to under the penalty of perjury.

By: *Pat A Hill*
 Title: President
 Company Name: Advanced Alarm Technologies, Inc.
 Date: 2/13/15

Taken, subscribed and sworn to before me this 13th day of February, 2015.

By Commission expires August 14 2015
 (Seal)  Notary Public, State of West Virginia
 Joyce A. Halley
 United Bank
 P.O. Box 1508 Parkersburg, WV 26104
 My Commission Expires August 14, 2015

Joyce A Halley
(Notary Public)

THIS AFFIDAVIT MUST BE SUBMITTED WITH THE BID IN ORDER TO COMPLY WITH WV CODE PROVISIONS. FAILURE TO INCLUDE THE AFFIDAVIT WITH THE BID SHALL RESULT IN DISQUALIFICATION OF THE BID.

STATE OF WEST VIRGINIA
Purchasing Division
PURCHASING AFFIDAVIT

MANDATE: Under W. Va. Code §5A-3-10a, no contract or renewal of any contract may be awarded by the state or any of its political subdivisions to any vendor or prospective vendor when the vendor or prospective vendor or a related party to the vendor or prospective vendor is a debtor and: (1) the debt owed is an amount greater than one thousand dollars in the aggregate; or (2) the debtor is in employer default.

EXCEPTION: The prohibition listed above does not apply where a vendor has contested any tax administered pursuant to chapter eleven of the W. Va. Code, workers' compensation premium, permit fee or environmental fee or assessment and the matter has not become final or where the vendor has entered into a payment plan or agreement and the vendor is not in default of any of the provisions of such plan or agreement.

DEFINITIONS:

"Debt" means any assessment, premium, penalty, fine, tax or other amount of money owed to the state or any of its political subdivisions because of a judgment, fine, permit violation, license assessment, defaulted workers' compensation premium, penalty or other assessment presently delinquent or due and required to be paid to the state or any of its political subdivisions, including any interest or additional penalties accrued thereon.

"Employer default" means having an outstanding balance or liability to the old fund or to the uninsured employers' fund or being in policy default, as defined in W. Va. Code § 23-2c-2, failure to maintain mandatory workers' compensation coverage, or failure to fully meet its obligations as a workers' compensation self-insured employer. An employer is not in employer default if it has entered into a repayment agreement with the Insurance Commissioner and remains in compliance with the obligations under the repayment agreement.

"Related party" means a party, whether an individual, corporation, partnership, association, limited liability company or any other form or business association or other entity whatsoever, related to any vendor by blood, marriage, ownership or contract through which the party has a relationship of ownership or other interest with the vendor so that the party will actually or by effect receive or control a portion of the benefit, profit or other consideration from performance of a vendor contract with the party receiving an amount that meets or exceeds five percent of the total contract amount.

AFFIRMATION: By signing this form, the vendor's authorized signer affirms and acknowledges under penalty of law for false swearing (W. Va. Code §61-5-3) that neither vendor nor any related party owe a debt as defined above and that neither vendor nor any related party are in employer default as defined above, unless the debt or employer default is permitted under the exception above.

WITNESS THE FOLLOWING SIGNATURE:Vendor's Name: Advanced Alarm Technologies, Inc.

Authorized Signature: _____

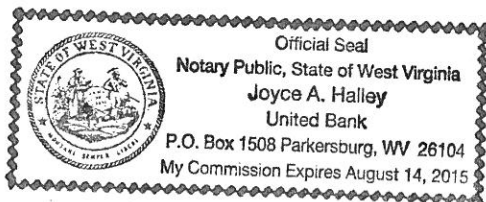
Date: 2/13/15State of West VirginiaCounty of Wood, to-wit:Taken, subscribed, and sworn to before me this 13th day of February, 2015.My Commission expires August 14, 2015.**AFFIX SEAL HERE****NOTARY PUBLIC** _____*Purchasing Affidavit (Revised 07/01/2012)*

CERTIFICATION AND SIGNATURE PAGE

By signing below, or submitting documentation through wvOASIS, I certify that I have reviewed this Solicitation in its entirety; understand the requirements, terms and conditions, and other information contained herein; that I am submitting this bid, offer or proposal for review and consideration; that I am authorized by the vendor to execute and submit this bid, offer, or proposal, or any documents related thereto on vendor's behalf; that I am authorized to bind the vendor in a contractual relationship; and that to the best of my knowledge, the vendor has properly registered with any State agency that may require registration.

Advanced Alarm Technologies, Inc.
(Company)

 Robert H Hill, President
(Authorized Signature) (Representative Name, Title)

(304) 422-4387 / (304) 422-4387 2/13/15
(Phone Number) (Fax Number) (Date)

**ERIE INSURANCE
PROPERTY & CASUALTY COMPANY
BID BOND**

Know All Men by These Presents,

Bond No. EE1462

That we, Advanced Alarm Technologies, Inc.
(hereinafter called the Principal) as Principal, and the ERIE INSURANCE PROPERTY & CASUALTY COMPANY, of
Erie, Pennsylvania, a corporation duly organized under the laws of the State of Pennsylvania, (hereinafter
called the Surety), as Surety, are held and firmly bound unto State of WV Purchasing Division

Charleston, WV hereinafter called the Obligee in the full and just sum of Two hundred

seventy five thousand dollars and zero cents Dollars, (\$275,000),
good and lawful money of the United States of America, to the payments of which sum of money well
and truly to be made, the said Principal and Surety bind themselves, their and each of their heirs, executors,
administrators, successors and assigns, jointly and severally, firmly by these presents.

Signed, sealed and dated this 18th day of February, A.D. 20. 15.

THE CONDITION OF THIS OBLIGATION IS SUCH: That, if the Obligee shall make any award within 30
days to the Principal for Installation of CCTV at William R. Sharpe Hospital, 936 Sharpe Hospital Road,
Weston, WV 26452

.
according to the terms of the proposal or bid made by the Principal therefor, and the Principal shall
duly make and enter into a contract with the Obligee in accordance with the terms of said proposal
or bid and award and shall give bond for the faithful performance thereof with the Surety or Sureties
approved by the Obligee; or if the Principal shall, in case of failure so to do, pay the Obligee the damages
which the Obligee may suffer by reason of such failure, not exceeding the penalty of this bond, then
this obligation shall be null and void; otherwise it shall be and remain in full force and effect.

In Testimony Whereof, the Principal and Surety have caused these presents to be duly signed and sealed.

Principal, Robert Hill

Witness: Karla E. Reeves

By: [Signature]

Witness: Kimberly A. Sheppard

ERIE INSURANCE
PROPERTY & CASUALTY COMPANY

By: [Signature]
Attorney-in-Fact



**ERIE INSURANCE
PROPERTY & CASUALTY COMPANY
ERIE, PA 16530
LIMITED POWER OF ATTORNEY**

KNOW ALL MEN BY THESE PRESENTS: That ERIE INSURANCE PROPERTY & CASUALTY COMPANY, a corporation duly organized under the laws of the Commonwealth of Pennsylvania, does hereby make, constitute and appoint

Steven P. Thompson, Randall E. Kerns, Michael W. Mason, Lisa McGuire, Dorinda Talerico, Khristine D. Mills, Sharon D. Boyles, Mark Sturm and Kathy Marcum

individually, its true and lawful Attorney-in-Fact, to make, execute, seal and deliver for and on its behalf, and as its act and deed: any and all bonds and undertakings of suretyship, each in a penalty not to exceed the sum of Five Hundred

Thousand Dollars (\$500,000.00)-----

And to bind ERIE INSURANCE PROPERTY & CASUALTY COMPANY thereby as fully and to the same extent as if such bonds and undertakings and other writings obligatory in the nature thereof were signed by the appropriate officer of ERIE INSURANCE PROPERTY & CASUALTY COMPANY and sealed and attested by one other of such officers, and hereby ratifies and confirms all that its said Attorney(s)-in-Fact may do in pursuance hereof.

The Power of Attorney is granted under and by authority of the following Resolution adopted by the Board of Directors of ERIE INSURANCE PROPERTY & CASUALTY COMPANY on the 11th day of March, 2008, and said Resolution has not been amended or repealed:

“RESOLVED, that the President, or any Senior Vice President or Vice President shall have power and authority to: (a) Appoint Attorney(s)-in-Fact and to authorize them to execute on behalf of the Company, bonds and undertakings, recognizances, contracts of indemnity and other writings obligatory in the nature thereof, and, (b) Remove any such Attorney-in-Fact at any time and revoke the power and authority given to him; and

RESOLVED, that Attorney(s)-in-Fact shall have power and authority, subject to the terms and limitations of the Power of Attorney issued to them, to execute and deliver on behalf of the Company, bonds and undertakings, recognizances, contracts of indemnity and other writings obligatory in the nature thereof. The corporate seal is not necessary for the validity of any bonds and undertakings, recognizances, contracts of indemnity and other writings obligatory in the nature thereof.”

This Limited Power of Attorney is signed and sealed by facsimiles under and by virtue of the following Resolution adopted by the Board of Directors of ERIE INSURANCE PROPERTY & CASUALTY COMPANY on the 18th day of September, 2008, at which a quorum was present and said Resolution has not been amended or repealed:

“RESOLVED, that the signature of Terrence W. Cavanaugh, as President and Chief Executive Officer of the Company, and the Seal of the Company may be affixed by the following facsimiles on any Limited Power of Attorney for the execution of bonds, undertakings, recognizances, contracts and other writings in the nature thereof, and the signature of James J. Tanous, as Secretary of the Company, the Seal of the Company, the signature of Sheila M. Hirsch, as Notary Public, and her Notarial Seal, may also be affixed by the following facsimiles to any certificate or acknowledgment of any such Limited Power of Attorney, and only under such circumstances shall said facsimiles be valid and binding on the Company.”

IN WITNESS WHEREOF, ERIE INSURANCE PROPERTY & CASUALTY COMPANY has caused these presents to be signed by its President and Chief Executive Officer, and its corporate seal to be hereto affixed this 3rd day of February, 2011.



Terrence W. Cavanaugh
Terrence W. Cavanaugh
President and Chief Executive Officer

STATE OF PENNSYLVANIA } ss.
COUNTY OF ERIE

On this 3rd day of February, 2011, before me personally came Terrence W. Cavanaugh, to me known, who being by me duly sworn, did depose and say: that he is President and Chief Executive Officer of ERIE INSURANCE PROPERTY & CASUALTY COMPANY, the corporation described in and which executed the above instrument; that he knows the Seal of said corporation; that the Seal affixed to the said instrument is such corporate Seal; that it was so affixed by order of the Board of Directors of said corporation and that he signed his name thereto by like order.



Sheila M. Hirsch
My commission expires June 27, 2016
Notary Public

CERTIFICATE

I, James J. Tanous, Secretary of ERIE INSURANCE PROPERTY & CASUALTY COMPANY, do hereby certify that the original LIMITED POWER OF ATTORNEY, of which the foregoing is a full, true and correct copy, is still in full force and effect as of the date below.

In witness whereof, I have hereunto subscribed my name and affixed corporate Seal of the Company by facsimiles pursuant to the action of the Board of Directors of the Company,



James J. Tanous
James J. Tanous, Secretary

this day of 20 .

CONTRACTOR LICENSE

Authorized by the
West Virginia Contractor Licensing Board

Number: WV025246

Classification:

LOW VOLTAGE SYSTEMS

ADVANCED ALARM TECHNOLOGIES INC
DBA ADVANCED ALARM TECHNOLOGIES INC
PO BOX 4368
PARKERSBURG, WV 26104-4368

Date Issued

MARCH 12, 2015

Expiration Date

MARCH 12, 2016

Authorized Company Signature

Michael A. Carl

Chair, West Virginia Contractor
Licensing Board

WEST VIRGINIA
CONTRACTOR
LICENSING
BOARD

This license, or a copy thereof, must be posted in a conspicuous place at every construction site where work is being performed. This license number must appear in all advertisements, on all bid submissions and on all fully executed and binding contracts. This license cannot be assigned or transferred by licensee. Issued under provisions of West Virginia Code, Chapter 21, Article 11.



From Tyco Security Products

exacqVision Z-Series IP Camera Recorders

Highest performance, reliability and capacity recorders



2U Z-Series IP Camera Recorder



3U Z-Series IP Camera Recorder

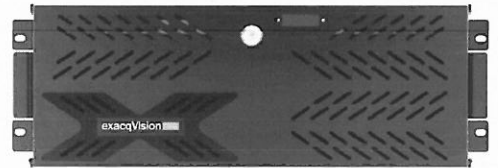

4U Z-Series IP Camera Recorder



Included VMS Client (Windows/Linux/Mac)



Free Exacq Mobile App works
with included WebService

• High Performance

- Continuously records up to 1,200 Mbps of video for high concentration of HD cameras
- Supports many simultaneous video to web/mobile clients with 1,800 FPS video
- Simultaneously connect up to 500 remote clients
- Optional dual 10Gbps network interfaces for fast archiving or mass client performance

• High Reliability

- Continuously record during single power source failure with dual power supplies
- Enterprise-class, continuous-duty hard drives
- Uninterrupted operation and video preservation in event of one or two drive failures
- Hot spare drive options for automatic replacement of failed drive
- Solid-state drive for Linux or Windows operating system
- Monitors hardware health in exacqVision client and with email/text notifications

• High Capacity

- Up to 128 IP cameras (8 licenses included) per recorder
- Compatible with thousands of IP camera models
- Store up to 80TB with front-accessible storage
- Expandable to over 1.6PB with exacqVision S-Series networked storage
- Compatible with all exacqVision recorders and software for maximum scalability

• Powerful VMS Software

- Pre-configured with exacqVision Professional software (standard)
 - EasyConnect - automatically finds, addresses and connects IP cameras
 - Powerful integration with retail, financial and access control systems
 - Timeline and thumbnail search investigations for recorded video, audio and data
 - Bookmark important video for long-term retention
 - Video multi-streaming to optimize storage utilization and network traffic

• View video anywhere (standard)

- Unlimited Windows/Linux/Mac PC clients
- Live and recorded video from browsers, tablets and smartphones

• Upgrade to exacqVision Enterprise software (optional)

- VideoPush to remotely control video wall clients
- Case management to organize critical evidence
- Active Directory/LDAP for IT administration of users
- Easy, single-screen administration of cameras, users, storage and notifications

• Enterprise System Manager (optional)

- Maximize uptime with health monitoring

• Host Certified Software Applications (CSA)

- Install CSAs such as video analytics, access control and POS software on the recorder
- Tested by Exacq to ensure compatibility
- Save money and rack space with single security server

• 3-Year Warranty

- Includes a 3-year hardware warranty and technical support from one source
- Constantly increasing VMS functionality with 3 years of unlimited software updates

exacq

From Tyco Security Products

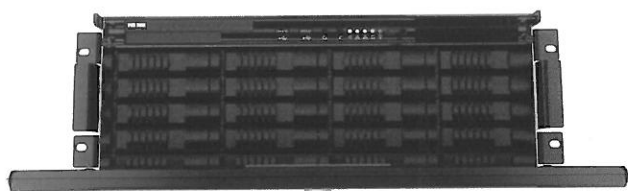

SETTINGS	2U SERVER	3U SERVER	4U SERVER
Maximum IP Cameras	128	128	128
Included IP Licenses	8	8	8
Alarm Inputs	4	8	8
Alarm Outputs	1 TTL & 1 Relay	3 TTL & 1 Relay	3 TTL & 1 Relay
SERVER			
Maximum Storage	8	16	20
Maximum Hard Drives	32 TB RAID 5	64 TB RAID 6	80 TB RAID 6
Typical Video Storage Rate (Mbps)	400 Mbps (Windows) 800 Mbps (Linux)	600 Mbps (Windows) 1000 Mbps (Linux)	800 Mbps (Windows) 1200 Mbps (Linux)
Pre-Loaded VMS Software	Professional (standard), Enterprise (optional)		
Local Client Display Rate (FPS)	1800 Mbps (Windows) 1200 Mbps (Linux)		
Monitor Output	1 DVI-I + 1 HDMI + 1 DisplayPort, max 2 simultaneous monitors		
Operating System	Windows 7 64-bit, Windows 2012 (Optional) Ubuntu Linux 12.04		
CPU	Gen 4 Intel Core i7 Gen 4 Intel Xeon E3 (Optional)		
RAM	8 GB, 16 GB (optional)		
NIC	2 x 1 Gbps, 2x10 Gbps SPF+ (Optional)		
USB	8 (2 front, 6 rear)		
DVD	Included		
Serial	1 RS485		
Audio Outputs	1		
Keyboard & Mouse	Included		
GENERAL			
Dimensions	27" x 16.875" x 3.5" 68.6 x 42.9 x 8.9 cm	26.5" x 16.875" x 5.5" 67.4 x 42.9 x 17.8 cm	27 x 16.875" x 7" 68.6 x 42.9 x 17.8 cm
Weight	39 - 53 lbs. 17.7 - 24.1 kg	44 - 72 lbs. 20 - 32.7 kg	49 - 90 lbs. 22.3 - 40.9 kg
Regulatory	CE, FCC, cULus, UL Listed		
Power Supplies	Dual Hot Swap		
Operating Temperature	40° - 95° F / 4.5° - 35° C		

Related Products



Exacq Mobile App



exacqVision S-Series
Storage Device



exacqVision Surveillance
Keyboard

www.exacq.com

exacq

From Tyco Security Products

exacqVision Enterprise Large-Scale, Intuitive VMS Software

exacqVision[®] enterprise

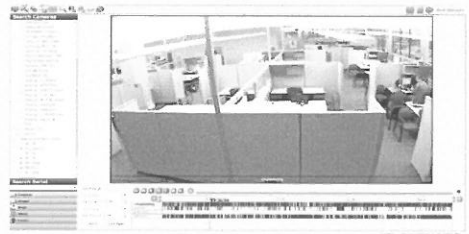

EasyConnect



• Large-Scale, Intuitive Video Management System (VMS) Features

- Effectively monitor video, audio and data in real time
 - Two-way audio
 - Interactive and multi-level mapping
 - Data integration from retail and access control systems
 - Notification overlays
- Conduct investigations on recorded video, audio and data
- **VideoPush** video wall sends video to another exacqVision user or public view monitor
- Constantly expand functionality with included regular software updates

• Multi-Server Administration

- Single-screen administration across multiple systems:
 - **Cameras:** Globally configure and monitor camera settings across the enterprise
 - **Storage:** Monitor storage health, configure S-Series storage connections
 - **Users:** Simultaneous administration of all users on multiple servers
 - **LDAP/Active Directory Integration:** standardized network administration
 - **E-mail and Text Notifications:** Quickly configure notification rules on all servers

• Enterprise System Manager

- Option to add Enterprise System Manager, a centralized health monitoring and software updating system available on a PC or mobile device

• Multi-Level Mapping

- Create hierarchical nesting of maps for faster camera and device navigation

• Ease of Use & Flexibility

- Requires little to no training
- Software installs in minutes
- **EasyConnect** automatically finds, assigns and addresses compatible IP cameras
- Easily add IP licenses at any time
- Per camera server licensing with no base server fee

• View Video Anywhere with Free Client Software

- Access live and recorded video on Windows, Linux or Mac PCs
- Use the free web service application with any modern browser
- Download the free exacq Mobile app available for iOS, Android, Windows Phone 8

• Highly Scalable

- Single client connects to thousands of servers
- Allows you to connect up to 64 analog and 128 IP cameras on exacqVision hybrid servers
- Offers high video throughput with minimal CPU and RAM requirements necessary

• Build a Best-of-Breed Physical Security System

- Integrates with:
 - Over 2,000 IP cameras and encoders from over 60 manufacturers
 - 20 access control systems
 - Video analytics solutions for LPR, heat mapping and intrusion detection
 - Retail/point-of-sale analytics

• Constantly Expanding Functionality with Included Software Updates

- Get more video management features without replacing your entire VMS
- Includes 1 year free software updates (three years on exacqVision NVRs)

www.exacq.com

CLIENT WORKSTATION MINIMUM HARDWARE REQUIREMENTS		TYPICALLY FOR VIEWING 1-4 ANALOG CAMERAS
Processor	Intel® Celeron® G540 or higher	
RAM	1 GB	
Hard Drive	40 GB	
Video	Intel HD (on-CPU GPU)	
Operating Systems	Microsoft® Windows XP, server 2003 (minimum), Ubuntu 8.04 or higher	
VMS SERVER HARDWARE MINIMUM REQUIREMENTS		TYPICALLY LESS THAN 50 MBPS CAMERA TRAFFIC, 1-2 SIMULTANEOUS REMOVE CLIENTS
Processor	Intel® Atom D525 1.8GHz or higher	
RAM	2 GB	
Hard Drive	60 GB (OS) + 250 GB (video) > 15 MBps non-sequential write	
Operating System	Microsoft® Windows 7 Pro, Microsoft® Server 2003, Ubuntu 8.04 or higher	
NIC	1 Gbps	
WEB BROWSER ACCESS		
Compatibility	Internet Explorer, Firefox, Safari, Opera, Chrome	
MOBILE DEVICE ACCESS		
Compatibility	iOS, Android, Windows Phone 8	

exacqVision Enterprise VMS Software is available on exacqVision servers:

exacqVision **Z-Series**



exacqVision **A-Series**



exacqVision **ELP**



Related Products



exacqVision Hybrid & IP Camera Servers



exacqVision Enterprise System Manager (ESM)



exacqVision Virtual

www.exacq.com



American Dynamics

From Tyco Security Products

Illustra 600 Series IP Compact Mini-Dome

High-Resolution Discreet
Indoor Mini-Dome



Features That Make a Difference:

- 720p and 1080p resolution
- Compact and discreet
- Motion detection
- Soft Day/Night and DSS for better low-light performance
- 3-axis gimbal for easy positioning
- Quick, easy installation and configuration
- Digital wide dynamic range and 2D noise reduction
- Factory focused lens
- 123° horizontal view for surveillance of wide areas (1080p only)
- Corridor mode for an optimal vertical field of view
- IK10-rated to protect against severe impacts
- ONVIF Profile S 2.2-compliant

The Illustra 600 Series IP Compact Mini-Dome is ideal for applications such as retail stores, commercial buildings, healthcare facilities and banks where discretion is important. This camera provides exceptional video quality, easy installation and low-light performance in a small, compact form factor. The size allows the mini-dome to discreetly blend into an existing environment.

Don't let the small size fool you. The Illustra 600 Series Compact Mini-Dome provides crisp and clear high-definition video at 720p and 1080p resolutions. Ideal for surveillance of wide areas, the 1080p model provides a 123° wide horizontal viewing angle. With a detailed resolution of 15 pixels per degree, this camera captures a crisp, clear image of an entire scene, even the perimeter. The camera's corridor mode provides a vertical field of view when a landscape format is not optimal. This feature is ideal for staircases, hallways, aisles and many other applications.

The Illustra Compact Mini-Dome Camera is designed to provide optimal imaging in a variety of lighting conditions with automatic exposure control. Manual exposure controls are available to help further tune the exposure for various lighting conditions. Backlight compensation helps with complex lighting condition where the foreground

objects are too dark. Low-light performance is enhanced via digital slow shutter (DSS) and Soft Day/Night (SDN) technologies.

The Illustra 600 Series Compact Mini-Dome motion detection sensor will send an alert to the operator or an email to any address or hand-held device.

Easy and fast installation is the hallmark of the Illustra camera line. Configuration is simple with our free Illustra Connect configuration software. Illustra Connect ships with all Illustra cameras and is designed to simplify network discovery and configuration. This software saves hours of installation time with remote firmware upgrading to selectable camera groups. Firmware upgrades include setting IP addresses, naming cameras and outputting a summary site audit with the configuration settings of all cameras on the network. The camera is also factory focused so there is no need for additional focusing at installation saving valuable time. And, the image will always be crisp and clear.

The Illustra 600 Series IP Compact Mini-Domes are not only vandal-resistant but have an IK10-rating which protects the cameras against severe impacts. This small camera can take a beating and still provide clear images.

Specifications

Operational

Video Compression H.264, MJPEG
 Max. Frame Rate 30 ips
 ONVIF-Compliant Yes, Profile S v2.3
 Resolution 1920 x 1080 (Illustra 610 only), 1280 x 720,
 800 x 450, 640 x 360 (nHD), 480 x 270,
 320 x 180

Imager

Illustra 600 1/4" CMOS progressive scan
 Illustra 610 1/2.7" CMOS progressive scan
 Soft Day/Night On, Off, Auto (with adjustable levels)
 Digital Slow Shutter (DSS) Off, 2X, 4X, 8X (default), 16X
 Motion Detection Yes
 Alarms Motion (user selectable ROI, event triggered)
 Minimum Illumination 0.3 lux color, 1/30 s, 30%, AGC on
 Shutter Speed 1/2-1/5000 sec
 Backlight Compensation On (center/left/right/top/bottom), Off
 Lens Focal Length
 Illustra 600 2.83 mm
 Illustra 610 2.80 mm
 Aperture F2.0
 Iris Type Fixed
 Factory Focused Distance 1.2 m (3.93 ft)
 Depth of Field 0.56 m (1.82 ft) to ∞
 Horizontal/Vertical Field of View
 Illustra 600 84.6° / 44.7°
 Illustra 610 123.2° / 81.5°
 White Balance ATW1/ATW2/Push/Manual
 Lens Bubble
 Transmittance 90%
 Material Type Polycarbonate

Network

Interface 10/100Base-TX Ethernet Port RJ-45
 LED Indicators Power/Network
 Supported Protocols TCP/IP, IPv4, TCP, UDP, HTTP, FTP, DHCP,
 WS-discovery, UPnP, DNS, mDNS, DDNS, RTP, Unicast, Multicast, NTP, IETF
 NTP, SMTP, WS-Security



Vertical Field of View with Corridor Mode



Horizontal Field of View

Configuration Management

Web Browser IE8, IE9, IE10, Firefox, Chrome, Safari
 Security Multi-users, password access, ONVIF
 Authentication, RTSP Authentication, HTTPS, IP connection log (logs an IP
 address when an RTSP connection is made)

Onboard Storage

Card Support MicroSDHC

Electrical

Power Input PoE IEEE 802.3af, Class 2
 Power Draw 7W maximum, average of 3-5W for normal
 daily use

Operational

Privacy Zones Four definable areas
 Text Overlay Yes

Menu Languages Arabic, Chinese (Simplified), Chinese (Traditional),
 Czech, Danish, Dutch, English (default), French, German, Hungarian, Italian,
 Japanese, Korean, Polish, Portuguese, Spanish, Swedish, Turkish

Physical

Dimensions 55 x 105 x 105 mm (2.17 x 4.13 x 4.13 in)
 Weight 280 g (0.62 lbs.)
 Housing Color White (RAL 9003)
 Bubble Clear
 Operating Temperature
 Illustra 600 0°C to 45°C (32°F to 113°F)
 Illustra 610 0°C to 40°C (32°F to 104°F)
 Humidity Up to 85% RH, non-condensing
 Storage Temperature -40°C to 60°C (-40°F to 140°F)
 Accessories Included Installation Guide CD, 4 x mounting screws with
 plastic anchors, 2x security screws, 1x T10 security Torx L-Key, 1x paper
 mounting template, 4x white plugs

Regulatory

Safety UL
 Emissions FCC Class A, CE; ICES-003/NMB-003 Class A
 AS/NZS CISPR 22 Class A
 EMC EU Directive 2004/108/EC
 Environmental RoHS, WEEE
 Vandal-Resistant IK10-rated

Ordering Information

Model #	Description
ADCi600-M111	Illustra 600 Compact Mini-Dome 720p, 2.8mm, PoE, white, clear bubble, vandal resistant
ADCi610-M111	Illustra 610 Compact Mini-Dome 1080p, 2.8mm, PoE, white, clear bubble, vandal resistant
ADCi6MPCAPIW	Illustra 600/610 Compact Mini-Dome pendant cap
ADCMGBXDBL	Illustra 600/610 Compact Mini-Dome double gang box adapter plate
ADCMGBXSGL	Illustra 600/610 Compact Mini-Dome single gang box adapter plate

Related Products



victor



VideoEdge
NVR



VideoEdge
Hybrid



VideoEdge Go



HDVR

Approvals



www.americandynamics.net

Illustra Flex IP Mini-Domes

Affordable and Versatile
Indoor and Outdoor



Indoor



***Outdoor**

Features That Make a Difference:

- 1MP or 3MP resolution for true HD quality images
- Bandwidth and storage friendly
- True Day/Night (TDN) functionality for a true color image
- 3D noise reduction for sharper images and lower bandwidth use in low light
- IR illuminators for clear images in low light conditions (Outdoor only)
- Motion detection for instant alerts of intruders
- IP66-rated enclosure to protect against dust and water damage (Outdoor only)
- Vandal-resistant housing (Outdoor only)
- A variety of mounting options for quick and easy installation
- ONVIF 2.2 profile S compliant

The versatile Illustra Flex Mini-Dome, Indoor or Outdoor, is a True Day/Night network camera that provides 1MP or 3MP full HD resolution for high quality images. H.264 and MJPEG video compression provides excellent image clarity, and efficient bandwidth and video storage.

With a small, aesthetically pleasing design, the affordably priced Illustra Flex Mini-Dome offers an effective solution for retail stores, K-12 schools, small bank branches and small to medium size offices with a tight budget and a variety of surveillance needs. With a variety of mounting options making it easy to install, these cameras can be strategically placed to blend into in a variety of interior locations such as the cash register terminal at a retail store, the lobby/corridor of an elementary school or inside a 24 hour ATM vestibule.

Featuring built-in IR illuminators, the outdoor Illustra Flex Mini-Dome produces clear images at an effective distance up to 49 feet in a variety of low light conditions. The outdoor camera also comes with a vandal-resistant housing to protect the camera against external impacts that might occur if an intruder was attempting to take the camera out of operation. With an IP66-rated enclosure, this outdoor mini-dome is ideal in situations where dust or water could damage the camera – a loading dock, parking lot or off-site warehouse.

*For indoor installations that require a vandal-resistant mini-dome, the Outdoor model can be used.



Specifications

Operational

Video Compression H.264/MJPEG
Max Frame Rate
Illustra Flex 600 720p @ 30ips
Illustra Flex 800 3MP @ 15ips
1080p @ 30ips

ONVIF-Compliant Yes

Resolutions

Illustra Flex 600 /20p (1280x720)
SVGA (800x600)
D1 (720x480)
VGA (640x480)
CIF (352x240)
Illustra Flex 800 3.1MP QXGA (2048x1536)
3MP (2304x1296)
1080p (1920x1080)
SXGA (1280x960)
720p (1280x720)
SVGA (800x600)
D1 (720x480)
4CIF (704x480)
VGA (640x480)
CIF (352x240)

Imager 1/3" CMOS
Day/Night Mechanical ICR

Minimum Illumination

Indoor 0.3 lux @ F1.2 color;
0.1 lux b/w
Outdoor 0.3 lux at F1.2 color;
0.00 lux in IR Illuminator mode

IR Illuminator (Outdoor) Effective distance is 15m/49ft,
IR wavelength 850nm

Shutter Speed 1/7.5~1/8000 sec
Backlight Compensation Off/On (6 selectable areas)
Lens Focal Length 3-9mm F1.2 varifocal lens
Field of View (H/V) Wide Angle: 98°/53°
Telephoto: 33°/19°

White Balance ATW (2500K~8000K)/Manual
Alarms Motion detection
Alarm Input 1
Audio Input 1
Audio Format G.711-Alaw/G.711-Ulaw
Video Output 1
Video Stream Triple
Wide Dynamic Range Digital WDR
Digital Noise Reduction 3D
Privacy Zones Yes, 4

Menu Languages Arabic, Chinese (Simplified), Chinese (Traditional),
Czech, Danish, Dutch, English (default), Finnish,
French, German, Italian, Japanese, Korean,
Norwegian, Polish, Portuguese, Russian, Spanish,
Swedish, Turkish

Network

Ethernet RJ-45 connector
Supported Protocols IPv4, HTTP, HTTPS, TCP, RTSP/RTCP/RTP,
ICMP, UDP, IGMP, DNS, DHCP, ARP, NTP, SMTP

Configuration Management

Web Browsing Internet Explorer 8.0 or above
Requirements Internet Explorer 8.0 or above
Security Multiple user access levels with
password protection

Onboard Storage

Card Support SDHC/SDXC

Electrical

Power
Indoor 12V DC, 24V AC, PoE 802.3af Class 0
Outdoor 24V AC, PoE 802.3af Class 0
Power Consumption
Illustra Flex 600 Indoor: 6.8W; Outdoor 10.3W
Illustra Flex 800 Indoor: 7W; Outdoor 10.5W

Physical

Dimension (DxH)
Indoor 125 x 106 mm (4.92 x 4.17 in)
Outdoor 147 x 140.5 mm (5.79 x 5.53 in)
Weight
Indoor 0.8 kg (1.76 lbs)
Outdoor 1.9 kg (4.18 lbs)
Housing Material
Indoor Polycarbonate & ABS
Outdoor ADC12
Housing Color
Indoor Pantone Cool Gray 1C
Outdoor Light Gray RAL 7035
Operating Temperature
Indoor -10°C to 50°C (14°F to 122°F)
Outdoor 24V AC power: -40°C to 50°C (-40°F to 122°F)
PoE power: -10°C to 50°C (14°F to 122°F)
Operating Humidity 0% to 90%, non-condensing
Storage Temperature -20°C to 60°C (-4°F to 140°F)

Regulatory

Emissions FCC Class A; CE Class A
IP Rating IP66 (Outdoor only)

Ordering Information

Model Numbers	Description
ADCi600F-D111	Illustra Flex 600 Indoor Mini-Dome, 1MP, varifocal 3-9mm lens
ADCi600F-D021	Illustra Flex 600 Outdoor Mini-Dome, 1MP, varifocal 3-9mm lens, IR, vandal-resistant
ADCi800F-D111	Illustra Flex 800 Indoor Mini-Dome, 3MP, varifocal 3-9mm lens
ADCi800F-D021	Illustra Flex 800 Outdoor Mini-Dome, 3MP, varifocal 3-9mm lens, IR, vandal-resistant

* Unless otherwise noted, all specifications are the same for both Illustra Flex 600 and Illustra Flex 800 Indoor and Outdoor models

Related Products



VideoEdge
NVR

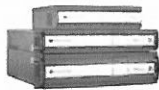

VideoEdge
Hybrid



exacqVision
NVR

Approvals



www.americandynamics.net



American Dynamics

A Tyco International Company

General Purpose Monitors

Performance Series

18.5" W and 21.5" W Displays

Features That Make a Difference:

- High quality and cost effective
- LED backlighting
- DVI and VGA input for DVRs or PC applications
- 18.5" monitor supports up to 1366 x 768 (HD) resolution
- 21.5" monitor supports up to 1920 x 1080 (FHD) resolution
- Low power consumption (< 30W)
- Slim design LCD
- Auto adjustment for image positioning
- Auto power recovery from outages
- Built-in stereo audio speakers



ADLCD19WGB



ADLCD22GB

American Dynamics 18.5" and 21.5" General Purpose Monitors feature a wide range of horizontal and vertical viewing angles that provide comfortable and clear viewing. Each monitor also features user-friendly, on-screen menus and front panel controls for adjusting monitor display parameters to your specific preference.

American Dynamics General Purpose Monitors deliver exceptionally sharp, crisp pictures with a brightness of 250 cd/m², a contrast ratio of 1000:1 and a response time of 5ms.

The LCDs are slim, lightweight and require less power and space. Monitors include a desktop stand and also feature a standard 100 x 100 (mm) VESA™ mounting pattern.

The long-life LED backlights help maintain consistent brightness levels and consume less power than traditional LCD monitors with CCFL backlighting.



Specifications

General

Panel size (diagonal)	18.5" and 21.5"
Backlight type	LED, edge-lit
Pixel pitch (H/V)	18.5" 0.300mm x 0.300mm 21.5" 0.248mm x 0.248mm
Native aspect ratio	16:9
Native resolution	8.5" 1366 x 768 21.5" 1920 x 1080
Brightness	250cd/m ²
Contrast ratio	1000:1
Viewing angle H/V	160 / 160
Response time	5ms
OSD Language	English (US), French (Fr), German, Spanish (Int), Italian, Portuguese (Brazilian), Chinese (Si), Dutch

Inputs / Outputs

VGA input	1 VGA (15pin D-Sub)
Plug & Play monitor	DDC compatible (DDC 2B)
DVI-D input	1 DVI-D Input
Audio input	Stereo audio input 3.5mm
Speaker output	1W x2 embedded

Electrical

Power input	100~240VAC, 50/60Hz
Power consumption	< 30W
Stand-by mode PC	< 2W
Off mode PC	< 1W

Environment

Operating temperature	0°C to 40°C (32°F to 104°F)
Operating humidity	10% to 85% (non-condensing)
Storage temperature	-20°C to 60°C (-4°F to 140°F)
Storage humidity	10% to 95% (non-condensing)

Mechanical

Cabinet	ABS plastic
Color	Black
Desktop Stand	Yes
Stand Tilt / Swivel / Lift	Tilt (-5° ~ +30°)
VESA™	100 x 100 (mm)
Dimension (H x W x D)	
Body	18.5" 337 x 444 x 172 mm (13.27 x 17.48 x 6.77 in) 21.5" 373 x 477 x 202 mm (14.69 x 18.78 x 7.95 in)
Shipping box	18.5" 390 x 498 x 102 mm (15.35 x 19.61 x 4.02 in) 21.5" 436 x 564 x 144 mm (17.17 x 22.20 x 5.67 in)

Weight

Monitor only (net)	18.5" 2.25 kg (4.96 lb), 21.5" 3.55 kg (7.83 lb)
Including stand (gross)	18.5" 2.60 kg (5.73 lb), 21.5" 3.90 kg (8.60 lb)
Shipping weight	18.5" 3.80 kg (8.38 lb), 21.5" 5.10 kg (11.24 lb)

Regulatory

UL/cUL, FCC, RoHS, WEEE, ENERGY STAR, CE

Accessories (included)

CD (user's guide, quick start guide), power cords, VGA cable

Ordering Information

Model Numbers	Description
Monitors	
ADLCD19WGB	19" W LCD 1366 x 768 LED, DVI-D, VGA, audio
ADLCD22GB	22" W LCD 1920 x 1080 FHD LED, DVI-D, VGA, audio
Optional Accessories	
ADMMTLCDWL	Dual pivoting wall mount with lanyard, VESA 75 mm and 100 mm compliant
ADMNMTLCDWAL	Articulating arm wall mount with lanyard, VESA 75 mm and 100 mm compliant
ADMMTLCDPL	Ceiling mount with lanyard, VESA 75 mm and 100 mm compliant (1.5" NPT pole required)

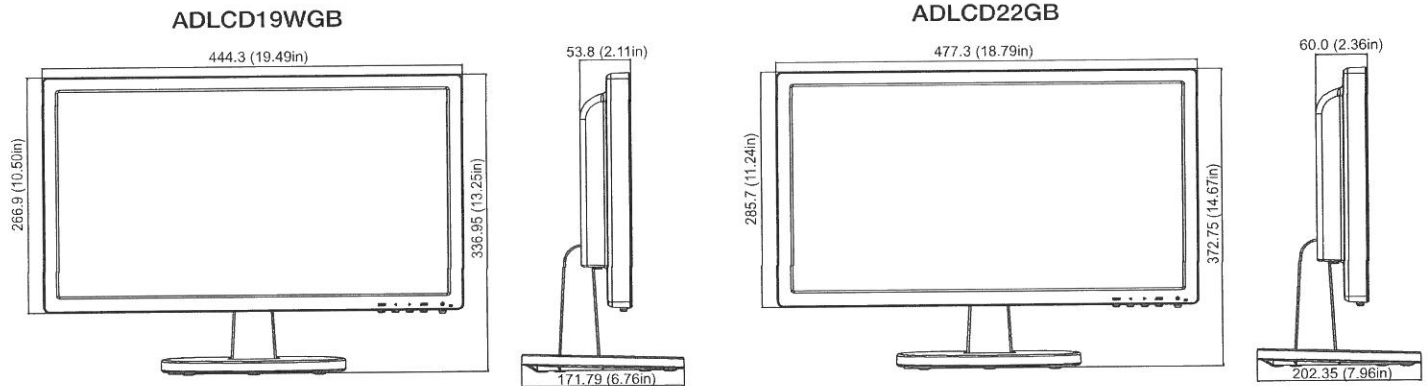

Related Products



ADTVR Series

HDVR

Intellex

www.americandynamics.net

The trademarks, logos, and service marks displayed on this document are registered in the United States for other countries. Any misuse of the trademarks is strictly prohibited and Tyco International Ltd. will aggressively enforce its intellectual property rights to the fullest extent of the law, including pursuit of criminal prosecution wherever necessary. All trademarks not owned by Tyco International Ltd. are the property of their respective owners, and are used with permission or allowed under applicable laws.

Product offerings and specifications are subject to change without notice. Actual products may vary from photos. Not all products include all features. Availability varies by region; contact your sales representative.
© 2012 Tyco International Ltd. and its respective companies. All rights reserved. AD0258-DS-201206-R01-11-EN