



State of West Virginia
 Department of Administration
 Purchasing Division
 2019 Washington Street East
 Post Office Box 50130
 Charleston, WV 25305-0130

WV PURCHASING ACA SECT Fax 304-558-4115

Aug 1 2012 01:54pm P001/005

Solicitation

DNR213015

1

ADDRESS CORRESPONDENCE TO ATTENTION OF:

FRANK WHITTAKER
 304-558-2316

RFQ COPY

*427103343

304-776-5600

Heritage International Trucks, Inc.
 408 Goff Mountain Road
 Cross Lanes, WV 25313

VENDOR

DIVISION OF NATURAL RESOURCES
 (IN CARE OF)
 SURPLUS PROPERTY
 2700 CHARLES AVENUE
 DUNBAR, WV
 25064 766-2626

BUYER TO

DATE PRINTED
 08/01/2012

BID OPENING DATE: 08/09/2012

BID OPENING TIME 1:30PM

LINE	QUANTITY	UOP	CAT NO	ITEM NUMBER	UNIT PRICE	AMOUNT
ADDENDUM NO. 1						
THIS ADDENDUM IS ISSUED TO AMEND THE ORIGINAL SOLICITATION PER THE ATTACHED DOCUMENTATION.						
0001	1	EA		070-54		
				TRUCKS, DIESEL		
***** THIS IS THE END OF RFQ DNR213015 ***** TOTAL:						see page 24

SIGNATURE: *[Signature]* TELEPHONE: 304-776-5600 DATE: 8-9-12
 TITLE: Sales Manager FEN: 27-1476356 ADDRESS CHANGES TO BE NOTED ABOVE

WHEN RESPONDING TO SOLICITATION, INSERT NAME AND ADDRESS IN SPACE ABOVE LABELED 'VENDOR'

SOLICITATION NUMBER: DNR213015
Addendum Number: 1

The purpose of this addendum is to modify the solicitation identified as ("Solicitation") to reflect the change(s) identified and described below.

Applicable Addendum Category:

- Modify bid opening date and time
- Modify specifications of product or service being sought
- Attachment of vendor questions and responses
- Attachment of pre-bid sign-in sheet
- Correction of error
- Other

Description of Modification to Solicitation:

To provide answers to all technical questions submitted in accordance with the provisions of the original solicitation (DNR213015) and to extend the bid opening date.

Bid opening date is extended to: 08/09/2012
Bid opening time remains: 1:30 PM EST

Additional Documentation: Documentation related to this Addendum (if any) has been included herewith as Attachment A and is specifically incorporated herein by reference.

Terms and Conditions:

1. All provisions of the Solicitation and other addenda not modified herein shall remain in full force and effect.
2. Vendor should acknowledge receipt of all addenda issued for this Solicitation by completing an Addendum Acknowledgment, a copy of which is included herewith. Failure to acknowledge addenda may result in bid disqualification. The addendum acknowledgement should be submitted with the bid to expedite document processing.

ATTACHMENT A

**ADDENDUM #1
DNR213015**

Question 1:

Engine: Would an engine that exceeds the horsepower and torque specifications, but has a smaller displacement – 506 or 543 VS 560 cubic inches – be accepted?

Answer 1:

Yes, as long as minimum horsepower and minimum torque specifications are met or exceeded.

Question 2:

If circuit breakers are not available, would solid state circuit protection and fuses be acceptable?

Answer 2:

No

Question 3:

There is a new government engine regulation for engines built after January 1, 2013. Since this contract could possibly involve these engines, would it be possible to postpone the bid opening to 8/9/2012 to ensure correct proposals on these units?

Answer 3:

Yes

ADDENDUM ACKNOWLEDGEMENT FORM
SOLICITATION NO.: DNR213015

Instructions: Please acknowledge receipt of all addenda issued with this solicitation by completing this addendum acknowledgment form. Check the box next to each addendum received and sign below. Failure to acknowledge addenda may result in bid disqualification.

Acknowledgment: I hereby acknowledge receipt of the following addenda and have made the necessary revisions to my proposal, plans and/or specification, etc.

Addendum Numbers Received:

(Check the box next to each addendum received)

- | | |
|--|--|
| <input checked="" type="checkbox"/> Addendum No. 1 | <input type="checkbox"/> Addendum No. 6 |
| <input type="checkbox"/> Addendum No. 2 | <input type="checkbox"/> Addendum No. 7 |
| <input type="checkbox"/> Addendum No. 3 | <input type="checkbox"/> Addendum No. 8 |
| <input type="checkbox"/> Addendum No. 4 | <input type="checkbox"/> Addendum No. 9 |
| <input type="checkbox"/> Addendum No. 5 | <input type="checkbox"/> Addendum No. 10 |

I understand that failure to confirm the receipt of addenda may be cause for rejection of this bid. I further understand that any verbal representation made or assumed to be made during any oral discussion held between Vendor's representatives and any state personnel is not binding. Only the information issued in writing and added to the specifications by an official addendum is binding.

Heritage International Trucks, Inc.

Company

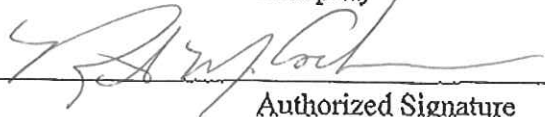

Authorized Signature

8-9-12

Date

NOTE: This addendum acknowledgment should be submitted with the bid to expedite document processing.
 Revised 6/8/2012



State of West Virginia
 Department of Administration
 Purchasing Division
 2019 Washington Street East
 Post Office Box 50130
 Charleston, WV 25305-0130

Solicitation

NUMBER
DNR213015

PAGE
1

ADDRESS CORRESPONDENCE TO ATTENTION OF
FRANK WHITTAKER 304-558-2316

VENDOR

RFQ COPY
 TYPE NAME/ADDRESS HERE
 *427103343 304-776-5600
 Heritage International Trucks, Inc.
 408 Goff Mountain Road
 Cross Lanes, WV 25313

SHIP TO

DIVISION OF NATURAL RESOURCES
 (IN CARE OF)
 SURPLUS PROPERTY
 2700 CHARLES AVENUE
 DUNBAR, WV
 25064 766-2626

DATE PRINTED
07/26/2012

BID OPENING DATE: 08/02/2012 BID OPENING TIME 1:30PM

LINE	QUANTITY	UOP	CAT NO	ITEM NUMBER	UNIT PRICE	AMOUNT
0001	1	EA		070-54		see page 24 (Fosson)
REQUEST FOR QUOTATION (RFQ) OPEN END CONTRACT THE WEST VIRGINIA PURCHASING DIVISION, FOR THE AGENCY, THE WEST VIRGINIA DIVISION OF NATURAL RESOURCES, IS SOLICITING BIDS FOR AN OPEN END CONTRACT TO PROVIDE THE AGENCY WITH 2012 OR CURRENT MODEL YEAR CONVENTIONA CAB TRUCK PER THE ATTACHED SPECIFICATIONS.						

SIGNATURE <i>T. A. W. Fosson</i>		TELEPHONE 304-776-5600	DATE 8-2-12
TITLE Sales Manager	FEN 27-1476356	ADDRESS CHANGES TO BE NOTED ABOVE	

WHEN RESPONDING TO SOLICITATION, INSERT NAME AND ADDRESS IN SPACE ABOVE LABELED 'VENDOR'

INSTRUCTIONS TO VENDORS SUBMITTING BIDS

1. **REVIEW DOCUMENTS THOROUGHLY:** The attached documents contain a solicitation for bids. Please read these instructions and all documents attached in their entirety. These instructions provide critical information about requirements that if overlooked could lead to disqualification of a Vendor's bid. All bids must be submitted in accordance with the provisions contained in these instructions and the Solicitation. Failure to do so may result in disqualification of Vendor's bid.
2. **MANDATORY TERMS:** The Solicitation may contain mandatory provisions identified by the use of the words "must," "will," and "shall." Failure to comply with a mandatory term in the Solicitation will result in bid disqualification.
3. **PREBID MEETING:** The item identified below shall apply to this Solicitation.

| A pre-bid meeting will not be held prior to bid opening.

| A **NON-MANDATORY PRE-BID** meeting will be held at the following place and time:

| A **MANDATORY PRE-BID** meeting will be held at the following place and time:

All Vendors submitting a bid must attend the mandatory pre-bid meeting. Failure to attend the mandatory pre-bid meeting shall result in disqualification of the Vendor's bid. No one person attending the pre-bid meeting may represent more than one Vendor.

An attendance sheet provided at the pre-bid meeting shall serve as the official document verifying attendance. The State will not accept any other form of proof or documentation to verify attendance. Any person attending the pre-bid meeting on behalf of a Vendor must list on the attendance sheet his or her name and the name of the Vendor he or she is representing. Additionally, the person attending the pre-bid meeting should include the Vendor's E-Mail address, phone number, and Fax number on the attendance sheet. It is the Vendor's responsibility to locate the attendance sheet and provide the required

information. Failure to complete the attendance sheet as required may result in disqualification of Vendor's bid.

All Vendors should arrive prior to the starting time for the pre-bid. Vendors who arrive after the starting time but prior to the end of the pre-bid will be permitted to sign in, but are charged with knowing all matters discussed at the pre-bid.

Questions submitted at least five business days prior to a scheduled pre-bid will be discussed at the pre-bid meeting if possible. Any discussions or answers to questions at the pre-bid meeting are preliminary in nature and are non-binding. Official and binding answers to questions will be published in a written addendum to the Solicitation prior to bid opening.

4. **VENDOR QUESTION DEADLINE:** Vendors may submit questions relating to this Solicitation to the Purchasing Division. Questions must be submitted in writing. All questions must be submitted on or before the date listed below and to the address listed below in order to be considered. A written response will be published in a Solicitation addendum if a response is possible and appropriate. Non-written discussions, conversations, or questions and answers regarding this Solicitation are preliminary in nature and are non-binding.

Question Submission Deadline: July 30, 2012 at 5:00 PM EST

Submit Questions to: Frank Whittaker, Senior Buyer File 44
2019 Washington Street, East
P.O. Box 50130
Charleston, WV 25305
Fax: 304-558-4115
Email: frank.m.whittaker@wv.gov

5. **VERBAL COMMUNICATION:** Any verbal communication between the Vendor and any State personnel is not binding, including that made at the mandatory pre-bid conference. Only information issued in writing and added to the Solicitation by an official written addendum by the Purchasing Division is binding.
6. **BID SUBMISSION:** All bids must be signed and delivered by the Vendor to the Purchasing Division at the address listed below on or before the date and time of the bid opening. Any bid received by the Purchasing Division staff is considered to be in the possession of the Purchasing Division and will not be returned for any reason. The bid delivery address is:

Department of Administration, Purchasing Division
2019 Washington Street East
P.O. Box 50130,
Charleston, WV 25305-0130

GENERAL TERMS AND CONDITIONS:

1. **CONTRACTUAL AGREEMENT:** Issuance of a Purchase Order signed by the Purchasing Division Director, or his designee, and approved as to form by the Attorney General's office constitutes acceptance of this Contract made by and between the State of West Virginia and the Vendor. Vendor's signature on its bid signifies Vendor's agreement to be bound by and accept the terms and conditions contained in this Contract.

2. **DEFINITIONS:** As used in this Solicitation / Contract, the following terms shall have the meanings attributed to them below. Additional definitions may be found in the specifications included with this Solicitation / Contract.
 - 2.1 "Agency" or "Agencies" means the agency, board, commission, or other entity of the State of West Virginia that is identified on the first page of the Solicitation or any other public entity seeking to procure goods or services under this Contract.
 - 2.2 "Contract" means the binding agreement that is entered into between the State and the Vendor to provide the goods and services requested in the Solicitation.
 - 2.3 "Director" means the Director of the West Virginia Department of Administration, Purchasing Division.
 - 2.4 "Purchasing Division" means the West Virginia Department of Administration, Purchasing Division.
 - 2.5 "Purchase Order" means the document signed by the Agency and the Purchasing Division, and approved as to form by the Attorney General, that identifies the Vendor as the successful bidder and Contract holder.
 - 2.6 "Solicitation" means the official solicitation published by the Purchasing Division and identified by number on the first page thereof.
 - 2.7 "State" means the State of West Virginia and/or any of its agencies, commissions, boards, etc. as context requires.
 - 2.8 "Vendor" or "Vendors" means any entity submitting a bid in response to the Solicitation, the entity that has been selected as the lowest responsible bidder, or the entity that has been awarded the Contract as context requires.

3. **CONTRACT TERM; RENEWAL; EXTENSION:** The term of this Contract shall be determined in accordance with the category that has been identified as applicable to this Contract below:

Term Contract

Initial Contract Term: This Contract becomes effective on
award

and extends for a period of one, (1), year(s).

Renewal Term: This Contract may be renewed upon the mutual written consent of the Agency, and the Vendor, with approval of the Purchasing Division and the Attorney General's office (Attorney General approval is as to form only). Any request for renewal must be submitted to the Purchasing Division Director thirty (30) days prior to the expiration date of the initial contract term or appropriate renewal term. A Contract renewal shall be in accordance with the terms and conditions of the original contract. Renewal of this Contract is limited to two, (2), successive one (1) year periods. Automatic renewal of this Contract is prohibited. Notwithstanding the foregoing, Purchasing Division approval is not required on agency delegated or exempt purchases. Attorney General approval may be required for vendor terms and conditions.

Reasonable Time Extension: At the sole discretion of the Purchasing Division Director, and with approval from the Attorney General's office (Attorney General approval is as to form only), this Contract may be extended for a reasonable time after the initial Contract term or after any renewal term as may be necessary to obtain a new contract or renew this Contract. Any reasonable time extension shall not exceed twelve (12) months. Vendor may avoid a reasonable time extension by providing the Purchasing Division Director with written notice of Vendor's desire to terminate this Contract 30 days prior to the expiration of the then current term. During any reasonable time extension period, the Vendor may terminate this Contract for any reason upon giving the Purchasing Division Director 30 days written notice. Automatic extension of this Contract is prohibited. Notwithstanding the foregoing, Purchasing Division approval is not required on agency delegated or exempt purchases, but Attorney General approval may be required.

- Fixed Period Contract:** This Contract becomes effective upon Vendor's receipt of the notice to proceed and must be completed within days.
- One Time Purchase:** The term of this Contract shall run for one year from the date the Purchase Order is issued or from the date the Purchase Order is issued until all of the goods contracted for have been delivered, whichever is shorter.
- Other:** See attached.

4. **NOTICE TO PROCEED:** Vendor shall begin performance of this Contract immediately upon receiving notice to proceed unless otherwise instructed by the Agency. Unless otherwise specified, the fully executed Purchase Order will be considered notice to proceed
5. **QUANTITIES:** The quantities required under this Contract shall be determined in accordance with the category that has been identified as applicable to this Contract below.
-
- Open End Contract:** Quantities listed in this Solicitation are approximations only, based on estimates supplied by the Agency. It is understood and agreed that the Contract shall cover the quantities actually ordered for delivery during the term of the Contract, whether more or less than the quantities shown.
- Service:** The scope of the service to be provided will be more clearly defined in the specifications included herewith.
- Combined Service and Goods:** The scope of the service and deliverable goods to be provided will be more clearly defined in the specifications included herewith.
- One Time Purchase:** This Contract is for the purchase of a set quantity of goods that are identified in the specifications included herewith. Once those items have been delivered, no additional goods may be procured under this Contract without an appropriate change order approved by the Vendor, Agency, Purchasing Division, and Attorney General's office.
6. **PRICING:** The pricing set forth herein is firm for the life of the Contract, unless specified elsewhere within this Solicitation/Contract by the State. A Vendor's inclusion of price adjustment provisions in its bid, without an express authorization from the State in the Solicitation to do so, may result in bid disqualification.
7. **EMERGENCY PURCHASES:** The Purchasing Division Director may authorize the Agency to purchase goods or services in the open market that Vendor would otherwise provide under this Contract if those goods or services are for immediate or expedited delivery in an emergency. Emergencies shall include, but are not limited to, delays in transportation or an unanticipated increase in the volume of work. An emergency purchase in the open market, approved by the Purchasing Division Director, shall not constitute a breach of this Contract and shall not entitle the Vendor to any form of compensation or damages. This provision does not excuse the State from fulfilling its obligations under a One Time Purchase contract.
8. **REQUIRED DOCUMENTS:** All of the items checked below must be provided to the Purchasing Division by the Vendor as specified below.
- BID BOND:** All Vendors shall furnish a bid bond in the amount of five percent (5%) of the total amount of the bid protecting the State of West Virginia. The bid bond must be submitted with the bid.

- [| **PERFORMANCE BOND:** The apparent successful Vendor shall provide a performance bond in the amount of . The performance bond must be issued and received by the Purchasing Division prior to Contract award. On construction contracts, the performance bond must be 100% of the Contract value.
- [| **LABOR/MATERIAL PAYMENT BOND:** The apparent successful Vendor shall provide a labor/material payment bond in the amount of 100% of the Contract value. The labor/material payment bond must be issued and delivered to the Purchasing Division prior to Contract award.

In lieu of the Bid Bond, Performance Bond, and Labor/Material Payment Bond, the Vendor may provide certified checks, cashier's checks, or irrevocable letters of credit. Any certified check, cashier's check, or irrevocable letter of credit provided in lieu of a bond must be of the same amount and delivered on the same schedule as the bond it replaces. A letter of credit submitted in lieu of a performance and labor/material payment bond will only be allowed for projects under \$100,000. Personal or business checks are not acceptable.

- [| **MAINTENANCE BOND:** The apparent successful Vendor shall provide a two (2) year maintenance bond covering the roofing system. The maintenance bond must be issued and delivered to the Purchasing Division prior to Contract award.
- [| **WORKERS' COMPENSATION INSURANCE:** The apparent successful Vendor shall have appropriate workers' compensation insurance and shall provide proof thereof upon request.
- [| **INSURANCE:** The apparent successful Vendor shall furnish proof of the following insurance prior to Contract award:

- [| **Commercial General Liability Insurance:**
or more.

- [| **Builders Risk Insurance:** builders risk -- all risk insurance in an amount equal to 100% of the amount of the Contract.

- [|

- [|

- [|

- [|

- [|

The apparent successful Vendor shall also furnish proof of any additional insurance requirements contained in the specifications prior to Contract award regardless of whether or not that insurance requirement is listed above.

[| **LICENSE(S) / CERTIFICATIONS / PERMITS:** In addition to anything required under the Section entitled Licensing, of the General Terms and Conditions, the apparent successful Vendor shall furnish proof of the following licenses, certifications, and/or permits prior to Contract award, in a form acceptable to the Purchasing Division.

[|]

[|]

[|]

[|]

The apparent successful Vendor shall also furnish proof of any additional licenses or certifications contained in the specifications prior to Contract award regardless of whether or not that requirement is listed above.

9. **LITIGATION BOND:** The Director reserves the right to require any Vendor that files a protest of an award to submit a litigation bond in the amount equal to one percent of the lowest bid submitted or \$5,000, whichever is greater. The entire amount of the bond shall be forfeited if the hearing officer determines that the protest was filed for frivolous or improper purpose, including but not limited to, the purpose of harassing, causing unnecessary delay, or needless expense for the Agency. All litigation bonds shall be made payable to the Purchasing Division. In lieu of a bond, the protester may submit a cashier's check or certified check payable to the Purchasing Division. Cashier's or certified checks will be deposited with and held by the State Treasurer's office. If it is determined that the protest has not been filed for frivolous or improper purpose, the bond or deposit shall be returned in its entirety.

10. **ALTERNATES:** Any model, brand, or specification listed herein establishes the acceptable level of quality only and is not intended to reflect a preference for, or in any way favor, a particular brand or vendor. Vendors may bid alternates to a listed model or brand provided that the alternate is at least equal to the model or brand and complies with the required specifications. The equality of any alternate being bid shall be determined by the State at its sole discretion. Any Vendor bidding an alternate model or brand should clearly identify the alternate items in its bid and should include manufacturer's specifications, industry literature, and/or any other relevant documentation demonstrating the equality of the alternate items. Failure to provide information for alternate items may be grounds for rejection of a Vendor's bid.

11. **EXCEPTIONS AND CLARIFICATIONS:** The Solicitation contains the specifications that shall form the basis of a contractual agreement. Vendor shall clearly mark any exceptions, clarifications, or

other proposed modifications in its bid. Exceptions to, clarifications of, or modifications of a requirement or term and condition of the Solicitation may result in bid disqualification.

- 12. LIQUIDATED DAMAGES:** Vendor shall pay liquidated damages in the amount n/a for . This clause shall in no way be considered exclusive and shall not limit the State or Agency's right to pursue any other available remedy.
- 13. ACCEPTANCE/REJECTION:** The State may accept or reject any bid in whole, or in part. Vendor's signature on its bid signifies acceptance of the terms and conditions contained in the Solicitation and Vendor agrees to be bound by the terms of the Contract, as reflected in the Purchase Order, upon receipt.
- 14. REGISTRATION:** Prior to Contract award, the apparent successful Vendor must be properly registered with the West Virginia Purchasing Division and must have paid the \$125 fee if applicable.
- 15. COMMUNICATION LIMITATIONS:** In accordance with West Virginia Code of State Rules §148-1-6.6, communication with the State of West Virginia or any of its employees regarding this Solicitation during the solicitation, bid, evaluation or award periods, except through the Purchasing Division, is strictly prohibited without prior Purchasing Division approval. Purchasing Division approval for such communication is implied for all agency delegated and exempt purchases.
- 16. FUNDING:** This Contract shall continue for the term stated herein, contingent upon funds being appropriated by the Legislature or otherwise being made available. In the event funds are not appropriated or otherwise made available, this Contract becomes void and of no effect beginning on July 1 of the fiscal year for which funding has not been appropriated or otherwise made available.
- 17. PAYMENT:** Payment in advance is prohibited under this Contract. Payment may only be made after the delivery and acceptance of goods or services. The Vendor shall submit invoices, in arrears, to the Agency at the address on the face of the purchase order labeled "Invoice To."
- 18. UNIT PRICE:** Unit prices shall prevail in cases of a discrepancy in the Vendor's bid.
- 19. DELIVERY:** All quotations are considered freight on board destination ("F.O.B. destination") unless alternate shipping terms are clearly identified in the bid. Vendor's listing of shipping terms that contradict the shipping terms expressly required by this Solicitation may result in bid disqualification.
- 20. INTEREST:** Interest attributable to late payment will only be permitted if authorized by the West Virginia Code. Presently, there is no provision in the law for interest on late payments.
- 21. PREFERENCE:** Vendor Preference may only be granted upon written request and only in accordance with the West Virginia Code § 5A-3-37 and the West Virginia Code of State Rules. A Resident Vendor Certification form has been attached hereto to allow Vendor to apply for the preference. Vendor's

failure to submit the Resident Vendor Certification form with its bid will result in denial of Vendor Preference. Vendor Preference does not apply to construction projects.

- 22. SMALL, WOMAN-OWNED, OR MINORITY-OWNED BUSINESSES:** For any solicitations publicly advertised for bid on or after July 1, 2012, in accordance with West Virginia Code §5A-3-37(a)(7) and W. Va. CSR § 148-22-9, any non-resident vendor certified as a small, women-owned, or minority-owned business under W. Va. CSR § 148-22-9 shall be provided the same preference made available to any resident vendor. Any non-resident small, women-owned, or minority-owned business must identify itself as such in writing, must submit that writing to the Purchasing Division with its bid, and must be properly certified under W. Va. CSR § 148-22-9 prior to submission of its bid to receive the preferences made available to resident vendors. Preference for a non-resident small, woman-owned, or minority owned business shall be applied in accordance with W. Va. CSR § 148-22-9.
- 23. TAXES:** The Vendor shall pay any applicable sales, use, personal property or any other taxes arising out of this Contract and the transactions contemplated thereby. The State of West Virginia is exempt from federal and state taxes and will not pay or reimburse such taxes.
- 24. CANCELLATION:** The Purchasing Division Director reserves the right to cancel this Contract immediately upon written notice to the vendor if the materials or workmanship supplied do not conform to the specifications contained in the Contract. The Purchasing Division Director may cancel any purchase or Contract upon 30 days written notice to the Vendor in accordance with West Virginia Code of State Rules § 148-1-7.16.2.
- 25. WAIVER OF MINOR IRREGULARITIES:** The Director reserves the right to waive minor irregularities in bids or specifications in accordance with West Virginia Code of State Rules § 148-1-4.6.
- 26. TIME:** Time is of the essence with regard to all matters of time and performance in this Contract.
- 27. APPLICABLE LAW:** This Contract is governed by and interpreted under West Virginia law without giving effect to its choice of law principles. Any information provided in specification manuals, or any other source, verbal or written, which contradicts or violates the West Virginia Constitution, West Virginia Code or West Virginia Code of State Rules is void and of no effect.
- 28. COMPLIANCE:** Vendor shall comply with all applicable federal, state, and local laws, regulations and ordinances. By submitting a bid, Vendors acknowledge that they have reviewed, understand, and will comply with all applicable law.
- 29. PREVAILING WAGE:** On any contract for the construction of a public improvement, Vendor and any subcontractors utilized by Vendor shall pay a rate or rates of wages which shall not be less than the fair minimum rate or rates of wages (prevailing wage), as established by the West Virginia Division of Labor under West Virginia Code §§ 21-5A-1 et seq. and available at <http://www.sos.wv.gov/administrative-law/wagerates/Pages/default.aspx>. Vendor shall be responsible for ensuring compliance with prevailing wage requirements and determining when prevailing wage

requirements are applicable. The required contract provisions contained in West Virginia Code of State Rules § 42-7-3 are specifically incorporated herein by reference.

- 30. ARBITRATION:** Any references made to arbitration contained in this Contract, Vendor's bid, or in any American Institute of Architects documents pertaining to this Contract are hereby deleted, void, and of no effect.
- 31. MODIFICATIONS:** This writing is the parties' final expression of intent. Notwithstanding anything contained in this Contract to the contrary, no modification of this Contract shall be binding without mutual written consent of the Agency, and the Vendor, with approval of the Purchasing Division and the Attorney General's office (Attorney General approval is as to form only). **No Change shall be implemented by the Vendor until such time as the Vendor receives an approved written change order from the Purchasing Division.**
- 32. WAIVER:** The failure of either party to insist upon a strict performance of any of the terms or provision of this Contract, or to exercise any option, right, or remedy herein contained, shall not be construed as a waiver or a relinquishment for the future of such term, provision, option, right, or remedy, but the same shall continue in full force and effect. Any waiver must be expressly stated in writing and signed by the waiving party.
- 33. SUBSEQUENT FORMS:** The terms and conditions contained in this Contract shall supersede any and all subsequent terms and conditions which may appear on any form documents submitted by Vendor to the Agency or Purchasing Division such as price lists, order forms, invoices, sales agreements, or maintenance agreements, and includes internet websites or other electronic documents. Acceptance or use of Vendor's forms does not constitute acceptance of the terms and conditions contained thereon.
- 34. ASSIGNMENT:** Neither this Contract nor any monies due, or to become due hereunder, may be assigned by the Vendor without the express written consent of the Agency, the Purchasing Division, the Attorney General's office (as to form only), and any other government agency or office that may be required to approve such assignments. Notwithstanding the foregoing, Purchasing Division approval may or may not be required on certain agency delegated or exempt purchases.
- 35. WARRANTY:** The Vendor expressly warrants that the goods and/or services covered by this Contract will: (a) conform to the specifications, drawings, samples, or other description furnished or specified by the Agency; (b) be merchantable and fit for the purpose intended; and (c) be free from defect in material and workmanship.
- 36. STATE EMPLOYEES:** State employees are not permitted to utilize this Contract for personal use and the Vendor is prohibited from permitting or facilitating the same.
- 37. BANKRUPTCY:** In the event the Vendor files for bankruptcy protection, the State of West Virginia may deem this Contract null and void, and terminate this Contract without notice.

- 38. HIPAA BUSINESS ASSOCIATE ADDENDUM:** The West Virginia State Government HIPAA Business Associate Addendum (BAA), approved by the Attorney General, is available online at <http://www.state.wv.us/admin/purchase/vrc/hipaa.html> and is hereby made part of the agreement provided that the Agency meets the definition of a Covered entity (45 CFR §160.103) and will be disclosing Protected Health Information (45 CFR §160.103) to the Vendor.
- 39. CONFIDENTIALITY:** The Vendor agrees that it will not disclose to anyone, directly or indirectly, any such personally identifiable information or other confidential information gained from the Agency, unless the individual who is the subject of the information consents to the disclosure in writing or the disclosure is made pursuant to the Agency's policies, procedures, and rules. Vendor further agrees to comply with the Confidentiality Policies and Information Security Accountability Requirements, set forth in <http://www.state.wv.us/admin/purchase/privacy/default.html>.
- 40. DISCLOSURE:** Vendor's response to the Solicitation and the resulting Contract are considered public documents and will be disclosed to the public in accordance with the laws, rules, and policies governing the West Virginia Purchasing Division. Those laws include, but are not limited to, the Freedom of Information Act found in West Virginia Code § 29B-1-1 et seq.

If a Vendor considers any part of its bid to be exempt from public disclosure, Vendor must so indicate by specifically identifying the exempt information, identifying the exemption that applies, providing a detailed justification for the exemption, segregating the exempt information from the general bid information, and submitting the exempt information as part of its bid but in a segregated and clearly identifiable format. Failure to comply with the foregoing requirements will result in public disclosure of the Vendor's bid without further notice. A Vendor's act of marking all or nearly all of its bid as exempt is not sufficient to avoid disclosure and WILL NOT BE HONORED. Vendor's act of marking a bid or any part thereof as "confidential" or "proprietary" is not sufficient to avoid disclosure and WILL NOT BE HONORED. In addition, a legend or other statement indicating that all or substantially all of the bid is exempt from disclosure is not sufficient to avoid disclosure and WILL NOT BE HONORED. Vendor will be required to defend any claimed exemption for nondisclosure in the event of an administrative or judicial challenge to the State's nondisclosure. Vendor must indemnify the State for any costs incurred related to any exemptions claimed by Vendor. Any questions regarding the applicability of the various public records laws should be addressed to your own legal counsel prior to bid submission.

- 41. LICENSING:** In accordance with West Virginia Code of State Rules §148-1-6.1.7, Vendor must be licensed and in good standing in accordance with any and all state and local laws and requirements by any state or local agency of West Virginia, including, but not limited to, the West Virginia Secretary of State's Office, the West Virginia Tax Department, West Virginia Insurance Commission, or any other state agency or political subdivision. Upon request, the Vendor must provide all necessary releases to obtain information to enable the Purchasing Division Director or the Agency to verify that the Vendor is licensed and in good standing with the above entities.

42. ANTITRUST: In submitting a bid to, signing a contract with, or accepting a Purchase Order from any agency of the State of West Virginia, the Vendor agrees to convey, sell, assign, or transfer to the State of West Virginia all rights, title, and interest in and to all causes of action it may now or hereafter acquire under the antitrust laws of the United States and the State of West Virginia for price fixing and/or unreasonable restraints of trade relating to the particular commodities or services purchased or acquired by the State of West Virginia. Such assignment shall be made and become effective at the time the purchasing agency tenders the initial payment to Vendor.

43. VENDOR CERTIFICATIONS: By signing its bid or entering into this Contract, Vendor certifies (1) that its bid was made without prior understanding, agreement, or connection with any corporation, firm, limited liability company, partnership, person or entity submitting a bid for the same material, supplies, equipment or services; (2) that its bid is in all respects fair and without collusion or fraud; (3) that this Contract is accepted or entered into without any prior understanding, agreement, or connection to any other entity that could be considered a violation of law; and (4) that it has reviewed this RFQ in its entirety; understands the requirements, terms and conditions, and other information contained herein. Vendor's signature on its bid also affirms that neither it nor its representatives have any interest, nor shall acquire any interest, direct or indirect, which would compromise the performance of its services hereunder. Any such interests shall be promptly presented in detail to the Agency.

The individual signing this bid on behalf of Vendor certifies that he or she is authorized by the Vendor to execute this bid or any documents related thereto on Vendor's behalf; that he or she is authorized to bind the Vendor in a contractual relationship; and that, to the best of his or her knowledge, the Vendor has properly registered with any State agency that may require registration.

44. PURCHASING CARD ACCEPTANCE: The State of West Virginia currently utilizes a Purchasing Card program, administered under contract by a banking institution, to process payment for goods and services. The Vendor must accept the State of West Virginia's Purchasing Card for payment of all orders under this Contract unless the box below is checked.

Vendor is not required to accept the State of West Virginia's Purchasing Card as payment for all goods and services.

45. VENDOR RELATIONSHIP: The relationship of the Vendor to the State shall be that of an independent contractor and no principal-agent relationship or employer-employee relationship is contemplated or created by this Contract. The Vendor as an independent contractor is solely liable for the acts and omissions of its employees and agents. Vendor shall be responsible for selecting, supervising, and compensating any and all individuals employed pursuant to the terms of this Solicitation and resulting contract. Neither the Vendor, nor any employees or subcontractors of the Vendor, shall be deemed to be employees of the State for any purpose whatsoever. Vendor shall be exclusively responsible for payment of employees and contractors for all wages and salaries, taxes, withholding payments, penalties, fees, fringe benefits, professional liability insurance premiums, contributions to insurance and pension, or other deferred compensation plans, including but not limited to, Workers' Compensation and Social Security obligations, licensing fees, *etc.* and the filing of all necessary documents, forms and returns pertinent to all of the foregoing. Vendor shall hold harmless the

State, and shall provide the State and Agency with a defense against any and all claims including, but not limited to, the foregoing payments, withholdings, contributions, taxes, Social Security taxes, and employer income tax returns.

- 46. INDEMNIFICATION:** The Vendor agrees to indemnify, defend, and hold harmless the State and the Agency, their officers, and employees from and against: (1) Any claims or losses for services rendered by any subcontractor, person, or firm performing or supplying services, materials, or supplies in connection with the performance of the Contract; (2) Any claims or losses resulting to any person or entity injured or damaged by the Vendor, its officers, employees, or subcontractors by the publication, translation, reproduction, delivery, performance, use, or disposition of any data used under the Contract in a manner not authorized by the Contract, or by Federal or State statutes or regulations; and (3) Any failure of the Vendor, its officers, employees, or subcontractors to observe State and Federal laws including, but not limited to, labor and wage and hour laws.
- 47. PURCHASING AFFIDAVIT:** In accordance with West Virginia Code § 5A-3-10a, all Vendors are required to sign, notarize, and submit the Purchasing Affidavit stating that neither the Vendor nor a related party owe a debt to the State in excess of \$1,000. The affidavit must be submitted prior to award, but should be submitted with the Vendor's bid. A copy of the Purchasing Affidavit is included herewith.
- 48. ADDITIONAL AGENCY AND LOCAL GOVERNMENT USE:** This Contract may be utilized by and extends to other agencies, spending units, and political subdivisions of the State of West Virginia; county, municipal, and other local government bodies; and school districts ("Other Government Entities"). This Contract shall be extended to the aforementioned Other Government Entities on the same prices, terms, and conditions as those offered and agreed to in this Contract. If the Vendor does not wish to extend the prices, terms, and conditions of its bid and subsequent contract to the Other Government Entities, the Vendor must clearly indicate such refusal in its bid. A refusal to extend this Contract to the Other Government Entities shall not impact or influence the award of this Contract in any manner.
- 49. CONFLICT OF INTEREST:** Vendor, its officers or members or employees, shall not presently have or acquire any interest, direct or indirect, which would conflict with or compromise the performance of its obligations hereunder. Vendor shall periodically inquire of its officers, members and employees to ensure that a conflict of interest does not arise. Any conflict of interest discovered shall be promptly presented in detail to the Agency.
- 50. REPORTS:** Vendor shall provide the Agency and/or the Purchasing Division with the following reports identified by a checked box below:
- Such reports as the Agency and/or the Purchasing Division may request. Requested reports may include, but are not limited to, quantities purchased, agencies utilizing the contract, total contract expenditures by agency, etc.

- [] Quarterly reports detailing the total quantity of purchases in units and dollars, along with a listing of purchases by agency. Quarterly reports should be delivered to the Purchasing Division via email at purchasing.requisitions@wv.gov.

51. BACKGROUND CHECK: In accordance with W. Va. Code § 15-2D-3, the Director of the Division of Protective Services shall require any service provider whose employees are regularly employed on the grounds or in the buildings of the Capitol complex or who have access to sensitive or critical information to submit to a fingerprint-based state and federal background inquiry through the state repository.

After the contract for such services has been approved, but before any such employees are permitted to be on the grounds or in the buildings of the Capitol complex or have access to sensitive or critical information, the service provider shall submit a list of all persons who will be physically present and working at the Capitol complex to the Director of the Division of Protective Services for purposes of verifying compliance with this provision.

The State reserves the right to prohibit a service provider's employees from accessing sensitive or critical information or to be present at the Capitol complex based upon results addressed from a criminal background check.

52. PREFERENCE FOR USE OF DOMESTIC STEEL PRODUCTS: Except when authorized by the Director of the Purchasing Division pursuant to W. Va. Code § 5A-3-56, no contractor may use or supply steel products for a State Contract Project other than those steel products made in the United States. A contractor who uses steel products in violation of this section may be subject to civil penalties pursuant to W. Va. Code § 5A-3-56. As used in this section:

- a. "State Contract Project" means any erection or construction of, or any addition to, alteration of or other improvement to any building or structure, including, but not limited to, roads or highways, or the installation of any heating or cooling or ventilating plants or other equipment, or the supply of and materials for such projects, pursuant to a contract with the State of West Virginia for which bids were solicited on or after June 6, 2001.
- b. "Steel Products" means products rolled, formed, shaped, drawn, extruded, forged, cast, fabricated or otherwise similarly processed, or processed by a combination of two or more or such operations, from steel made by the open heath, basic oxygen, electric furnace, Bessemer or other steel making process.

The Purchasing Division Director may, in writing, authorize the use of foreign steel products if:

- a. The cost for each contract item used does not exceed one tenth of one percent (.1%) of the total contract cost or two thousand five hundred dollars (\$2,500.00), whichever is greater. For the purposes of this section, the cost is the value of the steel product as delivered to the project; or

- b. The Director of the Purchasing Division determines that specified steel materials are not produced in the United States in sufficient quantity or otherwise are not reasonably available to meet contract requirements.

53. PREFERENCE FOR USE OF DOMESTIC ALUMINUM, GLASS, AND STEEL: In Accordance with W. Va. Code § 5-19-1 et seq., and W. Va. CSR § 148-10-1 et seq., for every contract or subcontract, subject to the limitations contained herein, for the construction, reconstruction, alteration, repair, improvement or maintenance of public works or for the purchase of any item of machinery or equipment to be used at sites of public works, only domestic aluminum, glass or steel products shall be supplied unless the spending officer determines, in writing, after the receipt of offers or bids, (1) that the cost of domestic aluminum, glass or steel products is unreasonable or inconsistent with the public interest of the State of West Virginia, (2) that domestic aluminum, glass or steel products are not produced in sufficient quantities to meet the contract requirements, or (3) the available domestic aluminum, glass, or steel do not meet the contract specifications. This provision only applies to public works contracts awarded in an amount more than fifty thousand dollars (\$50,000) or public works contracts that require more than ten thousand pounds of steel products.

The cost of domestic aluminum, glass, or steel products may be unreasonable if the cost is more than twenty percent (20%) of the bid or offered price for foreign made aluminum, glass, or steel products. If the domestic aluminum, glass or steel products to be supplied or produced in a "substantial labor surplus area", as defined by the United States Department of Labor, the cost of domestic aluminum, glass, or steel products may be unreasonable if the cost is more than thirty percent (30%) of the bid or offered price for foreign made aluminum, glass, or steel products.

This preference shall be applied to an item of machinery or equipment, as indicated above, when the item is a single unit of equipment or machinery manufactured primarily of aluminum, glass or steel, is part of a public works contract and has the sole purpose or of being a permanent part of a single public works project. This provision does not apply to equipment or machinery purchased by a spending unit for use by that spending unit and not as part of a single public works project.

All bids and offers including domestic aluminum, glass or steel products that exceed bid or offer prices including foreign aluminum, glass or steel products after application of the preferences provided in this provision may be reduced to a price equal to or lower than the lowest bid or offer price for foreign aluminum, glass or steel products plus the applicable preference. If the reduced bid or offer prices are made in writing and supersede the prior bid or offer prices, all bids or offers, including the reduced bid or offer prices, will be reevaluated in accordance with this rule.

CERTIFICATION AND SIGNATURE PAGE

By signing below, I certify that I have reviewed this Solicitation in its entirety; understand the requirements, terms and conditions, and other information contained herein; that I am submitting this bid or proposal for review and consideration; that I am authorized by the bidder to execute this bid or any documents related thereto on bidder's behalf; that I am authorized to bind the bidder in a contractual relationship; and that to the best of my knowledge, the bidder has properly registered with any State agency that may require registration.

Heritage International Trucks, Inc.

(Company)



(Authorized Signature)

R. Matt Cochran Sales Manager

(Representative Name, Title)

304-776-5600

(Phone Number)

304-769-0428

(Fax Number)

8-2-12

(Date)

ADDENDUM ACKNOWLEDGEMENT FORM
SOLICITATION NO.:

Instructions: Please acknowledge receipt of all addenda issued with this solicitation by completing this addendum acknowledgment form. Check the box next to each addendum received and sign below. Failure to acknowledge addenda may result in bid disqualification.

Acknowledgment: I hereby acknowledge receipt of the following addenda and have made the necessary revisions to my proposal, plans and/or specification, etc.

Addendum Numbers Received:

(Check the box next to each addendum received)

None
MC

- | | |
|--|--|
| <input checked="" type="checkbox"/> Addendum No. 1 | <input type="checkbox"/> Addendum No. 6 |
| <input type="checkbox"/> Addendum No. 2 | <input type="checkbox"/> Addendum No. 7 |
| <input type="checkbox"/> Addendum No. 3 | <input type="checkbox"/> Addendum No. 8 |
| <input type="checkbox"/> Addendum No. 4 | <input type="checkbox"/> Addendum No. 9 |
| <input type="checkbox"/> Addendum No. 5 | <input type="checkbox"/> Addendum No. 10 |

I understand that failure to confirm the receipt of addenda may be cause for rejection of this bid. I further understand that any verbal representation made or assumed to be made during any oral discussion held between Vendor's representatives and any state personnel is not binding. Only the information issued in writing and added to the specifications by an official addendum is binding.

Heritage International Trucks, Inc.

Company

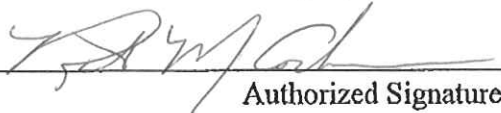
Authorized Signature

8-2-12

Date

NOTE: This addendum acknowledgment should be submitted with the bid to expedite document processing.

Hatchery Trucks

OPEN END

New conventional cab truck (2012 or current model year) with minimum GVWR of 36,000 pounds. The vehicle must meet the following minimum specifications.

- Wheel Base:** 198 inches minimum not to exceed 200 inches.
- Frame:** Minimum 120,000psi yield strength steel frame not to exceed 180,000psi.
- Engine:** (Maxx Force 9 or equal) turbo charged diesel with a minimum of 560 cubic inches, minimum 315 horsepower and minimum 950lb of torque. Also must have engine compression brake (not exhaust).
- Transmission:** (Fuller FRO-11210C or equal) 10 speed manual with overdrive. Must have provisions for a power takeoff. PTO control pad to be dash mounted.
- Front Axle:** (Meritor MFS-13-143A or equal), minimum 13,000lb. capacity with minimum 13,000lb taper leaf springs and shocks absorbers
- Rear Axle:** (Meritor RS-23-186 or equal) single reduction, minimum 23,000lb and minimum 4500lb auxiliary springs. Axle to have driver controlled locking differential with dash mounted switch. GEAR RATIO MUST BE 3.91 with a top speed of 75 mph. (if necessary electronics can be set to limit top speed to 75 mph).
- Brakes:** Air S-cam type anti-lock drum brakes with air compressor that has a minimum rating of 13.2CFM. Must also have air dryer and moisture, ejector systems, dust shields on front and rear brakes, and automatic slack adjuster on front and rear brakes.
- Batteries:** Dual 12-volt, minimum 1850 CCA
- Alternator:** 12-volt with 185amp output minimum
- Wheels:** Steel disc 5-handhold 22.5" painted steel
-

Hatchery Trucks

OPEN END

- Tires:** Front: 11R22.5 (load range H); Radial Highway Tread
Rear: 11R22.5 (load range H); Radial Mud and Snow tread
Spare tire and wheel to be same as front tire.
- Exhaust System:** Single horizontal with two position switch to inhibit diesel particulate filter regeneration.
- Fuel Tank:** 70 gallon minimum capacity mounted under cab on left side (clear frame from back of cab on left and right side to rear axles preferred; however, a protrusion beyond the cab on the left side is acceptable, providing right side is clear for consideration of DEF tank).
- Color:** Color of vehicle will be selected by purchaser from manufacturer's standard colors.

Vehicle must have the following minimum equipment:

- Reverse Warning Alarm
 - Front Tow Hooks (2)
 - Must have 12-volt auxiliary plug (mounted on dash)
 - AM/FM/CD Radio
 - Single trumpet air horn with or without weather shield, depending on where it's mounted.
 - Circuit breakers
 - Premium cab interior (cab sound insulation, sun visor, padded headliner, etc.)
 - Wrench to fit front and rear wheel lugs
 - Electric high idle switch or hand control throttle
 - Engine block heater – minimum of 115 to a maximum of 120 volt
 - Tilt steering column
 - Exterior cab assist entry handles (both sides)
 - Auxiliary driving/fog lights to be mounted in or on the bumper
 - Air conditioning with heater and defroster
 - Stop, turn, tail and backup lights (LED multi-function lamp)
 - Cloth material high back air suspension seats
-

Hatchery Trucks

OPEN END

- Dual 7" minimum x 16" maximum heated exterior mirrors with power adjust passenger side and 7/5" convex mirrors mounted both sides under existing mirrors.
 - Cruise control
-

Hatchery Trucks

OPEN END

BED SPECS:

Bidder must meet the following minimum specifications:

- Steel platform type with a minimum 15-ton single cylinder hydraulic scissor joist.
- Air shift PTO control to be mounted on dash of cab.
- Hoist pump control lever, cable type not acceptable, to be mounted in an easily accessible location to the outside rear of cab on driver's side.
- Platform is to be 15 feet long by 8 feet wide, constructed of 3/16" smooth steel to be welded to bed sills. Cross members shall extend to and be welded to side rails except where cross member may interfere with wheel clearance. Bed cross members to be 4" x 1/5", 11 gauge steel channel on 12 inch centers and welded to bed sills. Front and rear cross members and every one in between to be braced to bed sill with 1/4" steel plates, triangular in shape with 6" edges. One edge of plate to be welded to sill and the other edge welded to underside of cross member to extend 6" toward outside of bed.
- Side rails and ends to be 6" high and to be 12 gauge metal. Bed sills to be 7" construction channel, sufficient height to allow enough clearance for the use of tire chains on a fully loaded truck.
- Bed to be mounted 8" from rear of cab. Bed to have clearance and marker lights and mud flaps that comply with WV state law.

Note: Manufacturer's standard warranty and service policy to be included and shall be honored by all the manufacturer's authorized dealers.

**DNR213015
WILDLIFE RESOURCES
HATCHERY TRUCKS
PRICING PAGE**

Item	Estimated Quantity	Description	Unit Cost	Extended Cost
1	2	Conventional Cab Truck (2012) or Current Model Year) Minimum GVWR Of 36,000 Pounds (Initial order)	\$ 76,215.00	\$ 152,430.00
2	1	Conventional Cab Truck (2012) or Current Model Year) Minimum GVWR Of 36,000 Pounds (to be ordered at a later date)	\$ 76,215.00	\$ 76,215.00

Total Bid for Evaluation: \$ 228,645.00

The quantities listed above are for bid evaluation purposes only. Actual quantities may differ. The agency anticipates an initial order of two (2) vehicles to be ordered upon award of the contract. The agency may order additional trucks during the life of the contract.

Vendor must honor bid pricing throught the life of the contract. All orders after the initial order will be based on the cost submitted on Line Item 2 of the above bid scenario.

DNR213015
WILDLIFE RESOURCES
HATCHERY TRUCKS
OPEN END
MANUFACTURER PAGE

Item	Description	Manufacturer	Model No.
1	Conventional Cab Truck (2012) or Current Model Year) Minimum GVWR Of 36,000 Pounds	International	DuraStar 4400

VENDOR PREFERENCE CERTIFICATE

Certification and application* is hereby made for Preference in accordance with *West Virginia Code*, §5A-3-37. (Does not apply to construction contracts). *West Virginia Code*, §5A-3-37, provides an opportunity for qualifying vendors to request (at the time of bid) preference for their residency status. Such preference is an evaluation method only and will be applied only to the cost bid in accordance with the *West Virginia Code*. This certificate for application is to be used to request such preference. The Purchasing Division will make the determination of the Resident Vendor Preference, if applicable.

1. **Application is made for 2.5% resident vendor preference for the reason checked:**
 Bidder is an individual resident vendor and has resided continuously in West Virginia for four (4) years immediately preceding the date of this certification; or,

Bidder is a partnership, association or corporation resident vendor and has maintained its headquarters or principal place of business continuously in West Virginia for four (4) years immediately preceding the date of this certification; or 80% of the ownership interest of Bidder is held by another individual, partnership, association or corporation resident vendor who has maintained its headquarters or principal place of business continuously in West Virginia for four (4) years immediately preceding the date of this certification; or,

Bidder is a nonresident vendor which has an affiliate or subsidiary which employs a minimum of one hundred state residents and which has maintained its headquarters or principal place of business within West Virginia continuously for the four (4) years immediately preceding the date of this certification; or,

2. **Application is made for 2.5% resident vendor preference for the reason checked:**
 Bidder is a resident vendor who certifies that, during the life of the contract, on average at least 75% of the employees working on the project being bid are residents of West Virginia who have resided in the state continuously for the two years immediately preceding submission of this bid; or,

3. **Application is made for 2.5% resident vendor preference for the reason checked:**
 Bidder is a nonresident vendor employing a minimum of one hundred state residents or is a nonresident vendor with an affiliate or subsidiary which maintains its headquarters or principal place of business within West Virginia employing a minimum of one hundred state residents who certifies that, during the life of the contract, on average at least 75% of the employees or Bidder's affiliate's or subsidiary's employees are residents of West Virginia who have resided in the state continuously for the two years immediately preceding submission of this bid; or,

4. **Application is made for 5% resident vendor preference for the reason checked:**
 Bidder meets either the requirement of both subdivisions (1) and (2) or subdivision (1) and (3) as stated above; or,

5. **Application is made for 3.5% resident vendor preference who is a veteran for the reason checked:**
 Bidder is an individual resident vendor who is a veteran of the United States armed forces, the reserves or the National Guard and has resided in West Virginia continuously for the four years immediately preceding the date on which the bid is submitted; or,

6. **Application is made for 3.5% resident vendor preference who is a veteran for the reason checked:**
 Bidder is a resident vendor who is a veteran of the United States armed forces, the reserves or the National Guard, if, for purposes of producing or distributing the commodities or completing the project which is the subject of the vendor's bid and continuously over the entire term of the project, on average at least seventy-five percent of the vendor's employees are residents of West Virginia who have resided in the state continuously for the two immediately preceding years.

7. **Application is made for preference as a non-resident small, women- and minority-owned business, in accordance with *West Virginia Code* §5A-3-59 and *West Virginia Code of State Rules*.**
 Bidder has been or expects to be approved prior to contract award by the Purchasing Division as a certified small, women- and minority-owned business.

Bidder understands if the Secretary of Revenue determines that a Bidder receiving preference has failed to continue to meet the requirements for such preference, the Secretary may order the Director of Purchasing to: (a) reject the bid; or (b) assess a penalty against such Bidder in an amount not to exceed 5% of the bid amount and that such penalty will be paid to the contracting agency or deducted from any unpaid balance on the contract or purchase order.

By submission of this certificate, Bidder agrees to disclose any reasonably requested information to the Purchasing Division and authorizes the Department of Revenue to disclose to the Director of Purchasing appropriate information verifying that Bidder has paid the required business taxes, provided that such information does not contain the amounts of taxes paid nor any other information deemed by the Tax Commissioner to be confidential.

Under penalty of law for false swearing (*West Virginia Code*, §61-5-3), Bidder hereby certifies that this certificate is true and accurate in all respects; and that if a contract is issued to Bidder and if anything contained within this certificate changes during the term of the contract, Bidder will notify the Purchasing Division in writing immediately.

Bidder: Heritage International Trucks, Inc. Signed: 

Date: 8-2-12 Title: Sales Manager

STATE OF WEST VIRGINIA
Purchasing Division

PURCHASING AFFIDAVIT

MANDATE: Under W. Va. Code §5A-3-10a, no contract or renewal of any contract may be awarded by the state or any of its political subdivisions to any vendor or prospective vendor when the vendor or prospective vendor or a related party to the vendor or prospective vendor is a debtor and: (1) the debt owed is an amount greater than one thousand dollars in the aggregate; or (2) the debtor is in employer default.

EXCEPTION: The prohibition listed above does not apply where a vendor has contested any tax administered pursuant to chapter eleven of the W. Va. Code, workers' compensation premium, permit fee or environmental fee or assessment and the matter has not become final or where the vendor has entered into a payment plan or agreement and the vendor is not in default of any of the provisions of such plan or agreement.

DEFINITIONS:

"Debt" means any assessment, premium, penalty, fine, tax or other amount of money owed to the state or any of its political subdivisions because of a judgment, fine, permit violation, license assessment, defaulted workers' compensation premium, penalty or other assessment presently delinquent or due and required to be paid to the state or any of its political subdivisions, including any interest or additional penalties accrued thereon.

"Employer default" means having an outstanding balance or liability to the old fund or to the uninsured employers' fund or being in policy default, as defined in W. Va. Code § 23-2c-2, failure to maintain mandatory workers' compensation coverage, or failure to fully meet its obligations as a workers' compensation self-insured employer. An employer is not in employer default if it has entered into a repayment agreement with the Insurance Commissioner and remains in compliance with the obligations under the repayment agreement.

"Related party" means a party, whether an individual, corporation, partnership, association, limited liability company or any other form or business association or other entity whatsoever, related to any vendor by blood, marriage, ownership or contract through which the party has a relationship of ownership or other interest with the vendor so that the party will actually or by effect receive or control a portion of the benefit, profit or other consideration from performance of a vendor contract with the party receiving an amount that meets or exceeds five percent of the total contract amount.

AFFIRMATION: By signing this form, the vendor's authorized signer affirms and acknowledges under penalty of law for false swearing (W. Va. Code §61-5-3) that neither vendor nor any related party owe a debt as defined above and that neither vendor nor any related party are in employer default as defined above, unless the debt or employer default is permitted under the exception above.

WITNESS THE FOLLOWING SIGNATURE:

Vendor's Name: Heritage International Trucks, Inc.

Authorized Signature: [Signature] Date: 8-2-12

State of West Virginia

County of Kanawha, to-wit:

Taken, subscribed, and sworn to before me this 9th day of August, 2012.

My Commission expires 12-25, 2018.

AFFIX SEAL HERE

NOTARY PUBLIC

[Signature]

Purchasing Affidavit (Revised 07/01/2012)



Prepared For:
 WV Division of Natural Resources
 Frank Whittaker
 2700 Charles Ave.
 Dunbar, WV 25064-2236
 (304)558 - 2402

Presented By:
 HERITAGE INTERNATIONAL TRUCKS, INC.
 Chuck W Whitlow
 344 Old Goff Mountain Road
 CHARLESTON WV 25313 -
 (304)204-2601

Thank you for the opportunity to provide you with the following quotation on a new International truck. I am sure the following detailed specification will meet your operational requirements, and I look forward to serving your business needs.

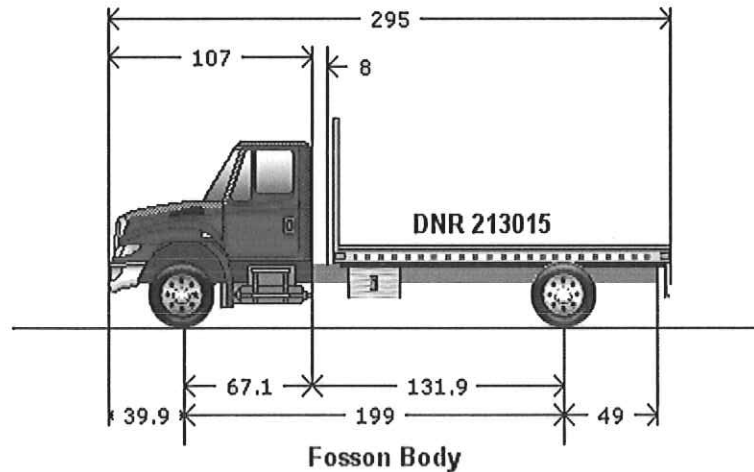

Model Profile
 2013 4400 SBA 4X2 (MA035)

APPLICATION:	Flat Dump
MISSION:	Requested GVWR: 36000. Calc. GVWR: 36000 Calc. Start / Grade Ability: 44.70% / 2.15% @ 55 MPH Calc. Geared Speed: 92.0 MPH
DIMENSION:	Wheelbase: 199.00, CA: 131.90, Axle to Frame: 49.00
ENGINE, DIESEL:	{MaxxForce 9} EPA 10, 315 HP @ 2000 RPM, 950 lb-ft Torque @ 1200 RPM, 2200 RPM Governed Speed
TRANSMISSION, MANUAL:	{Fuller FRO-11210C} 10-Speed Manual, With Overdrive, With Air Shift
CLUTCH:	{Eaton Fuller EP1402 SD} Easy-Pedal Plus, Two-Plate, Cast Angle Spring; Ceramic, 14" Diameter, "Super Duty", 8-Spring Coaxial Free Travel Damper, Mechanical Pull Type Control, Kwik-Adjust(Manual) Feature, With 1.75" Diam. Spline, 1400 lb-ft Torque Capacity
AXLE, FRONT NON-DRIVING:	{Meritor MFS-13-143A} Wide Track, I-Beam Type, 13,000-lb Capacity
AXLE, REAR, SINGLE:	{Meritor RS-23-186} Single Reduction, 23,000-lb Capacity, 200 Wheel Ends, Driver Controlled Locking Differential Gear Ratio: 3.91
CAB:	Conventional
TIRE, FRONT:	(3) 11R22.5 G287 MSA (GOODYEAR) 498 rev/mile, load range H, 16 ply
TIRE, REAR:	(4) 11R22.5 G182 RSD (GOODYEAR) 496 rev/mile, load range H, 16 ply
SUSPENSION, RR, SPRING, SINGLE:	Vari-Rate; 23,500-lb Capacity, With 4500 lb Auxiliary Rubber Spring
PAINT:	Cab schematic 100GA Location 1: 2303, Red (Std) Chassis schematic N/A

Description

Base Chassis, Model 4400 SBA 4X2 with 199.00 Wheelbase, 131.90 CA, and 49.00 Axle to Frame.

TOW HOOK, FRONT (2) Frame Mounted

FRAME RAILS Heat Treated Alloy Steel (120,000 PSI Yield); 10.125" x 3.580" x 0.312" (257.2mm x 90.9mm x 8.0mm); 420.0" (10668mm) Maximum OAL

BUMPER, FRONT Full Width, Aerodynamic, Steel; 0.142" Material Thickness

WHEELBASE RANGE 199" (505cm) Through and Including 254" (645cm)

AXLE, FRONT NON-DRIVING {Meritor MFS-13-143A} Wide Track, I-Beam Type, 13,000-lb Capacity

SUSPENSION, FRONT, SPRING Parabolic, Taper Leaf; 13,000-lb Capacity; With Shock Absorbers

BRAKE SYSTEM, AIR Dual System for Straight Truck Applications

DRAIN VALVE {Berg} Manual; With Pull Chain, for Air Tank

AIR BRAKE ABS {Bendix AntiLock Brake System} Full Vehicle Wheel Control System (4-Channel)

AIR DRYER {Bendix AD-9} With Heater

BRAKE CHAMBERS, FRONT AXLE {Haldex} 20 SqIn

BRAKE CHAMBERS, REAR AXLE {Haldex GC3030LHDHO} 30/30 Spring Brake

BRAKES, FRONT, AIR CAM S-Cam; 15.0" x 4.0"; Includes 20 Sq. In. Long Stroke Brake Chambers

BRAKES, REAR, AIR CAM S-Cam; 16.5" x 7.0"; Includes 30/30 Sq.In. Long Stroke Brake Chamber and Spring Actuated Parking Brake

AIR COMPRESSOR {Bendix Tu-Flo 550} 13.2 CFM Capacity

DUST SHIELDS, FRONT BRAKE for Air Brakes

DUST SHIELDS, REAR BRAKE for Air Brakes

STEERING COLUMN Tilting

STEERING WHEEL 2-Spoke, 18" Diam., Black

STEERING GEAR {Sheppard HD94} Power

EXHAUST SYSTEM Single, Horizontal, Aftertreatment Device Frame Mounted Right Side Back of Cab, Includes Horizontal Tail Pipe

ENGINE COMPRESSION BRAKE for MaxxForce I6 Engines; Electronically Activated

SWITCH, FOR EXHAUST 2 Position, Lighted & Latching, ON/OFF Type, Mounted in IP, Inhibits Diesel Particulate Filter Regeneration as Long as Switch is in ON Position

ELECTRICAL SYSTEM 12-Volt, Standard Equipment

POWER SOURCE Cigar Type Receptacle without Plug and Cord

ALTERNATOR {Leece-Neville BLP2361H} Brushless, 12 Volt 185 Amp. Capacity, Pad Mount, with Remote Voltage Sensor

BODY BUILDER WIRING Back of Standard Cab at Left Frame or Under Extended or Crew Cab at Left Frame; Includes Sealed Connectors for Tail/Amber Turn/Marker/ Backup/Accessory Power/Ground and Sealed Connector for Stop/Turn

BATTERY SYSTEM {International} Maintenance-Free, (2) 12-Volt 1850CCA Total

RADIO {International} AM/FM Stereo With CD Player, Weatherband, Clock, Auxiliary Input, Includes Multiple Speakers

BACK-UP ALARM Electric, 102 dBA

STOP, TURN, TAIL & B/U LIGHTS {Truck Lite} Super 44, With LED Bulbs for Stop, Turn & Tail Lights, License Plate Light and Backup lights, With Power Module, "International" Termination and Less Junction Box

HORN, AIR Black, Single Trumpet, Air Solenoid Operated

Description

FOG LIGHTS (2) Clear, Oval, With H355W Halogen Bulb

STARTING MOTOR {Delco Remy 38MT Type 300} 12 Volt; less Thermal Over-Crank Protection

INDICATOR, LOW COOLANT LEVEL With Audible Alarm

HEADLIGHTS Halogen; Composite Aero Design for Two Light System

CIRCUIT BREAKERS Manual-Reset (Main Panel) SAE Type III With Trip Indicators, Replaces All Fuses Except For 5-Amp Fuses

GRILLE Chrome

FRONT END Tilting, Fiberglass, With Three Piece Construction

PAINT SCHEMATIC, PT-1 Single Color, Design 100

TOOL KIT Rim Wrench and Handle Only

PAINT TYPE Base Coat/Clear Coat, 1-2 Tone

SAFETY TRIANGLES

CLUTCH {Eaton Fuller EP1402 SD} Easy-Pedal Plus, Two-Plate, Cast Angle Spring; Ceramic, 14" Diameter, "Super Duty", 8-Spring Coaxial Free Travel Damper, Mechanical Pull Type Control, Kwik-Adjust(Manual) Feature, With 1.75" Diam. Spline, 1400 lb-ft Torque Capacity

OIL FILTER, ENGINE {Hudgins Model 960 Spinner}

BLOCK HEATER, ENGINE {Phillips} 120 Volt/1250 Watt

ENGINE, DIESEL {MaxxForce 9} EPA 10, 315 HP @ 2000 RPM, 950 lb-ft Torque @ 1200 RPM, 2200 RPM Governed Speed

FAN DRIVE {Borg-Warner SA85} Viscous Type, Screw On

RADIATOR Aluminum; 2-Row, Cross Flow, Over Under System, 1045 SqIn Louvered, with 373 SqIn CAC, with 369 SqIn LTR

FEDERAL EMISSIONS for 2010; MaxxForce 9 & 10 Engines

AIR CLEANER With Service Protection Element

THROTTLE, HAND CONTROL Engine Speed Control; Electronic, Stationary, Variable Speed; Mounted on Steering Wheel

ENGINE CONTROL, REMOTE MOUNTED Provision for; Includes Wiring for Body Builder Installation of PTO Controls; With Ignition Switch Control for MaxxForce post 2007 Emissions Electronic Engines

FAN DRIVE SPECIAL EFFECTS Fan Cooling Ring with Fan Shroud Effects, Engine Mounted

EMISSION COMPLIANCE Federal, Does Not Comply With California Clean Air Idle Regulations

TRANSMISSION, MANUAL {Fuller FRO-11210C} 10-Speed Manual, With Overdrive, With Air Shift

TRANSMISSION OIL {EmGard 50W} Synthetic; 22 thru 33.99 Pints

PTO CONTROL, DASH MOUNTED For Customer Provided PTO; Includes Switch, Electric/Air Solenoid, Piping and Wiring

AXLE, REAR, SINGLE {Meritor RS-23-186} Single Reduction, 23,000-lb Capacity, 200 Wheel Ends, Driver Controlled Locking Differential, Gear Ratio: 3.91

SUSPENSION, RR, SPRING, SINGLE Vari-Rate; 23,500-lb Capacity, With 4500 lb Auxiliary Rubber Spring

FUEL TANK Top Draw; D Style, Non Polished Aluminum, 19" Deep, 70 U.S. Gal., 265 L Capacity, with Quick Connect Outlet, Mounted Left Side, Under Cab

CAB Conventional

GAUGE CLUSTER English With English Electronic Speedometer

IP CLUSTER DISPLAY On Board Diagnostics Display of Fault Codes in Gauge Cluster

Description

SEAT, DRIVER {National 2000 195} Air Suspension, High Back With Integral Headrest, Cloth, Isolator, 3 Chamber Lumbar, 2 Position Front Cushion Adjust, -3 to +14 Degree Back Angle Adjust, Cushion and Back Bolsters

SEAT, PASSENGER {National 2000 195} Air-Suspension, High Back With Integral Headrest, Cloth, Isolator, 3 Chamber Lumbar, 2 Position Front Cushion Adjustment, -3 to +14 Degree Back Angle Adjustment, Cushion and Back Bolsters

GRAB HANDLE (2) Chrome Towel Bar Type With Anti-Slip Rubber Inserts; for Cab Entry, Mounted Left and Right, Each Side at "B" Pillar

MIRRORS (2) {Lang Mekra} Styled; Rectangular, 7.09" x 15.75" & Integral Convex Both Sides, 102" Inside Spacing, Breakaway Type, Heated Heads Thermostat Controlled, Power Both Sides Flat Glass Only, Clearance Lights LED,

CAB MOUNTING HEIGHT EFFECTS Mid Cab in Lieu of Low Cab Mounting Height (Approx. 4") for Increased Cooling System Requirements

AIR CONDITIONER {Blend-Air} With Integral Heater & Defroster

INSTRUMENT PANEL Center Section, Flat Panel

CAB INTERIOR TRIM Premium

CAB REAR SUSPENSION Air Bag Type

WHEEL, SPARE, DISC 22.5" Painted Steel, 10 Stud (285.75MM BC Hub Piloted) 8.25 DC Rim

WHEELS, FRONT DISC; 22.5" Painted Steel, 2 Hand Hole, 10 Stud (285.75MM BC) Hub Piloted, Flanged Nut, Metric Mount, 8.25 DC Rims; With Steel Hubs

WHEELS, REAR DUAL DISC; 22.5" Painted Steel, 2 Hand Hole, 10-Stub (285.75MM BC) Hub Piloted, Flanged Nut, Metric Mount, 8.25 DC Rims; With Steel Hubs

TIRE, SPARE Equal to Model Standard

WHEEL, FRONT, IDENTITY {Accuride} Front Disc Wheels; Light Weight, 5 Hand-Hole, With 285.75mm B.C. Hub Piloted Mounting, DC Rims

WHEEL, REAR, IDENTITY {Accuride} Rear Disc Wheels; Light Weight, 5 Hand-Hole, With 285.75mm B.C. Hub Piloted Mounting, DC Rims

(4) TIRE, REAR 11R22.5 G182 RSD (GOODYEAR) 496 rev/mile, load range H, 16 ply

(3) TIRE, FRONT 11R22.5 G287 MSA (GOODYEAR) 498 rev/mile, load range H, 16 ply

L. B. Fossom Truck Body, Inc. - 15' body per specifications provided from bid; price good for (1) year from bid opening

(US DOLLAR)

Description

Price

Net Sales Price:

\$76,215.00

This proposal includes all equipment featured on DNR212113 and Addendum #1.

Approved by Seller:

Accepted by Purchaser:

Official Title and Date

Firm or Business Name

Authorized Signature

Authorized Signature and Date

This proposal is not binding upon the seller without
Seller's Authorized Signature

Official Title and Date

The TOPS FET calculation is an estimate for reference purposes only. The seller or retailer is responsible for calculating and reporting/paying appropriate FET to the IRS.

NOTES AND EXCEPTIONS ON DNR213015

- Single Trumpet air horn without weather shield; The International DuraStar air horn is mounted under the hood in the frame system. No weather shield required.
- Cruise Control: The cruise control is part of the Throttle, Hand Control for the engine
- The rear view mirrors are specified to be 7" x 16", heated and motorized. The International DuraStar offer a 7.09" x 15.75" heated (thermostatic) and motorized option on the flat glass only. The mirror assembly includes "Integral Convex" both sides. This mirror was ruled acceptable in most recent bid for DNR.
- Spare tire and rim will match the front specified tire.
- There is no DEF tank on this unit; International engines do not utilize this emission technology.
- Circuit breakers are provided replacing all fuses except for 5A fuses.

L. B. Fosson Truck Bodies, Inc.

642 Wheatley Road
Ashland, KY 41101
Office (606) 329-0016
Fax (606) 329-0134

Bed Specs:

Bidder must meet the following minimum specifications:

- Steel platform type with a minimum 15-ton single cylinder hydraulic scissor joist.
- Air shift PTO control to be mounted on dash of cab.
- Hoist pump control lever, cable type not acceptable, to be mounted in an easily accessible location to the outside rear of cab on driver's side.
- Platform is to be 15 feet long by 8 feet wide, constructed of 3/16" smooth steel to be welded to bed sills. Cross members shall extend to and be welded to side rails except where cross member may interfere with wheel clearance. Bed cross members to be 4" x 1/5", 11 gauge steel channel on 12 inch centers and welded to bed sills. Front and rear cross members and everyone in between to be braced to bed sills with 1/4" steel plates, triangular in shape with 6" edges. One edge of plate to be welded to sill and the other edge welded to underside of cross member to extend 6" toward outside of bed.
- Side rails and ends to be 6" high and to be 12 gauge metal. Bed sills to be 7" construction channel, sufficient height to allow enough clearance for the use of tire chains on a fully loaded truck.
- Bed to be mounted 8" from rear of cab. Bed to have clearance and marker lights and mud flaps that comply with WV state law.

Note: Manufacturer's standard warranty and service policy to be included and shall be honored by all the manufacturer's authorized dealers.

Thank You, for the opportunity to submit this Quote and look forward to working with you in the future

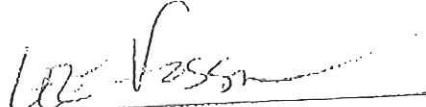

Lee Fosson, President

Date: 08/03/2012

12a

ENGINE

12a

MAXXFORCE® ENGINES PERFORMANCE SPECIFICATIONS

Engine Family: **MaxxForce® 9**
 HP Rating: **300 HP**
 Code: **12NUU**

Control Type	Electronic
Aspiration	Two-Stage Turbocharger, Intercooler & Aftercooler
Bore X Stroke	4.59 x 5.75 in.
Displacement	570 cu. in.
Compression Ratio	17.2:1
Advertised HP Rating	300 HP @ 2000 RPM
Peak HP	300 HP @ 2000 RPM
HP At Governed Speed	256 HP @ 2200 RPM
Peak Torque	860 lb-ft @ 1200 RPM
Torque Rise	40%
Clutch Engagement Torque	750 lb-ft @ 800 RPM
Weight	1,425

Engine Family: **MaxxForce® 9**
 HP Rating: **315 HP**
 Code: **12NUV**

Control Type	Electronic
Aspiration	Two-Stage Turbocharger, Intercooler & Aftercooler
Bore X Stroke	4.59 x 5.75 in.
Displacement	570 cu. in.
Compression Ratio	17.2:1
Advertised HP Rating	315 HP @ 2000 RPM
Peak HP	315 HP @ 2000 RPM
HP At Governed Speed	269HP @ 2200 RPM
Peak Torque	950 lb-ft @ 1200 RPM
Torque Rise	47%
Clutch Engagement Torque	750 lb-ft @ 800 RPM
Weight	1,425

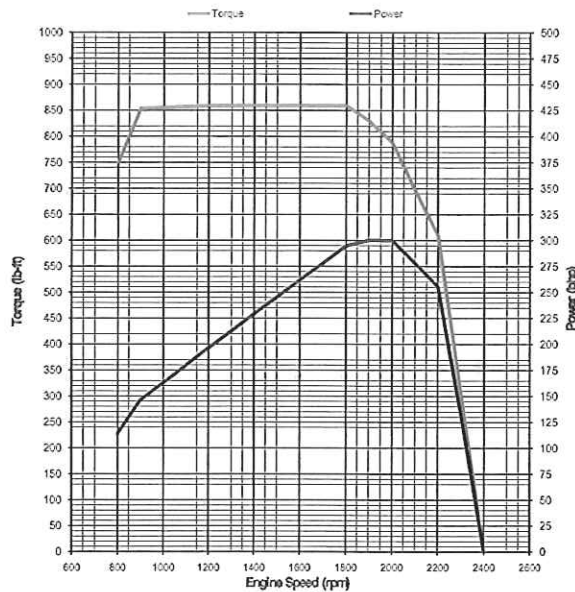

12NUU_curve

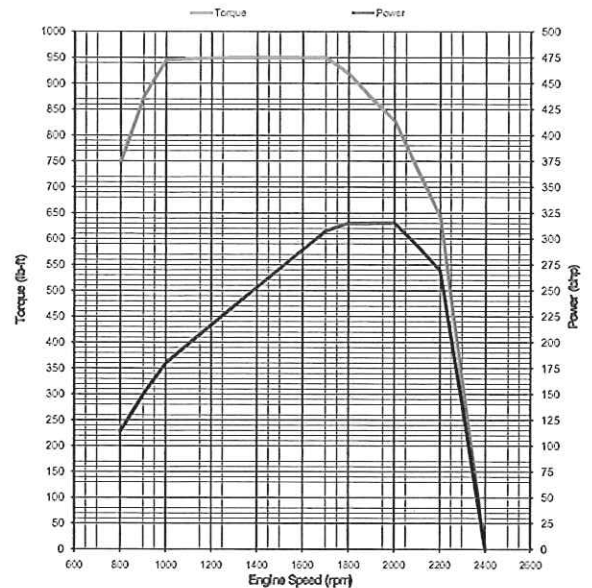

12NUV_curve

Manual Transmissions – 10-Speed (Continued)

Feature Code	13GGM	13GGV	13GHC	13GHL	13GNB
Manufacturer/ Model Number	Fuller FRO-11210C	Fuller FRO-12210C	Fuller FRO-13210C	Fuller FRO-14210C	Fuller FRO-17210C
GCWR (lbs.)	80,000	80,000	80,000	80,000	80,000
GVWR (lbs.)	80,000	80,000	80,000	80,000	80,000
Ratios & % Split to Next Lower Gear	1st	Ratio	% Split		Ratio % Split
	2nd	12.69	37		12.94 39
	3rd	9.29	38		9.29 38
	4th	6.75	37		6.75 37
	5th	4.90	36		4.90 36
	6th	3.62	40		3.62 40
	7th	2.59	37		2.64 39
	8th	1.90	38		1.90 38
	9th	1.38	37		1.38 37
	10th	1.00	36		1.00 36
	Rev. 1	0.74			0.74
Rev. 2	13.75			13.75	
Rev. 2	2.80			2.80	
PTO Opening	Right 6-Bolt; Bottom 8-Bolt	Right 6-Bolt; Bottom 8-Bolt	Right 6-Bolt; Bottom 8-Bolt	Right 6-Bolt; Bottom 8-Bolt	Right 6-Bolt; Bottom 8-Bolt
PTO Gear Speed (% of Engine RPM)	84.0	84.0	84.0	84.0	84.0
Gearing	Twin Countershaft with Conical Clutching Teeth and Helical Gears in Reduction Unit				
Synchronizers	None; But with Synchronized Reduction Unit				
Nominal Torque Capacity (lb-ft)	1150	1250	1350	1450	1750
Case Material	Grey Iron	Grey Iron	Grey Iron	Grey Iron	Grey Iron
Clutch Housing Material^[2]	Grey Iron	Grey Iron	Grey Iron	Grey Iron	Grey Iron
Dry Weight^[1] (lbs.)	668.0	668.0	668.0	668.0	678.0
Lubricant Capacity (Pints)	23.5	23.5	23.5	23.5	23.5
Comments	Includes Magnetic Discs (3) in Case & Magnetic Drain Plug				-

NOTES:

[1] = Includes Clutch Housing.

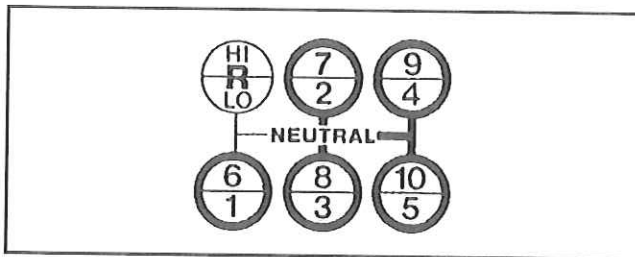
[2] = Aluminum Clutch Housing Available (13WAS) (53-lb. Wt. Saving).
Aluminum Clutch Housing Available (13WAR) (53-lb. Wt. Saving).

Shift Pattern – 009

13_0022

14a

REAR AXLES/SUSPENSIONS

SINGLE REAR AXLES

14a

Capacity: **23,000 lbs.**Code: **14ARX**Manufacturer: **Meritor**Model: **RS-23-186**

Type	Single Reduction		
Shift Mechanism	N/A		
Capacity (lbs.)	23,000		
GCW Rating (lbs.)	On/Off Highway		
	On-Highway	125,000	
	On Turnpike	140,000	
Brakes	Type	Air	
Drive Gear	Hypoid		
Ratios	2.93	3.91	5.38
	3.07	4.10	5.63
	3.21	4.30	5.86
	3.42	4.56	6.14
	3.58	4.89	6.83
	3.73	5.13	7.17
Housing	Type	Fabricated	
	Section @ Spring	4.62 x 5.25	
	Wall Thickness (in.)	0.5	
Ring Gear	Mounting	Bolted	
	Pitch Dia. (in.)	19.62	
Input Shaft	Major Dia. (in.)	2.35	
	Number of Splines	46	
Axle Shafts	Body Dia. (in.)	2.25	
	Number of Splines	46	
Wheel Bearings	Type	Tapered	
Wheel Ends	R		
Dry Weight (lbs.)	785		
Lubricant Capacity (Pints)	47.3		
Ground Clearance (in.)	8.75		
	W/11R22.5 Tires (SLR = 19.5")		
No-Spin Differential	N/A		
Comments	N/A		

Capacity: **23,000 lbs.**Code: **14ARY**Manufacturer: **Meritor**Model: **RS-23-186**

Type	Single Reduction		
Shift Mechanism	N/A		
Capacity (lbs.)	23,000		
GCW Rating (lbs.)	On/Off Highway		
	On-Highway	125,000	
	On Turnpike	140,000	
Brakes	Type	Air	
Drive Gear	Hypoid		
Ratios	2.93	3.91	5.38
	3.07	4.10	5.63
	3.21	4.30	5.86
	3.42	4.56	6.14
	3.58	4.89	6.83
	3.73	5.13	7.17
Housing	Type	Fabricated	
	Section @ Spring	4.62 x 5.25	
	Wall Thickness (in.)	0.5	
Ring Gear	Mounting	Bolted	
	Pitch Dia. (in.)	19.62	
Input Shaft	Major Dia. (in.)	2.35	
	Number of Splines	46	
Axle Shafts	Body Dia. (in.)	2.25	
	Number of Splines	46	
Wheel Bearings	Type	Tapered	
Wheel Ends	R		
Dry Weight (lbs.)	805		
Lubricant Capacity (Pints)	47.3		
Ground Clearance (in.)	8.75		
	W/11R22.5 Tires (SLR = 19.5")		
No-Spin Differential	Driver Controlled Locking Differential		
Comments	N/A		

**LIMITED WARRANTY FOR MODELS
1000, 4000, DURASTAR® SERIES**

*Effective with vehicles built July 12, 2011 or later.

BASIC VEHICLE

Navistar, Inc., at its option, will repair or replace any part of this vehicle which proves defective in material or workmanship, in normal use and service, with new or ReNEWed® parts, based on the Component Coverage's below. Exceptions are listed below:

BASIC VEHICLE COVERAGE	Months	Miles
Basic Vehicle Warranty (Feature Code 40024) (See exceptions listed below)	24	Unlimited
*Note-items not listed in warranty exceptions follow base warranty		
Warranty Exceptions		
CHASSIS COVERAGE	Months	Miles
Frame side rails	84	Unlimited
Cab/cowl structure	60	Unlimited
Cab/cowl perforation corrosion	60	Unlimited
ENGINE COVERAGE	Months	Miles
Non-Rescue Applications		
MaxxForce® 7 Engine (Includes DPF)	36	150/240
MaxxForce® 9 Engine (Includes DPF)	36	150/240
MaxxForce® DT Engine (Includes DPF)	36	150/240
MaxxForce® 7 Engine glow plugs, relay, harness/connector (07 EPA)	12	Unlimited
Rescue Application Only (Fire Truck, Ambulance, Emergency)		
MaxxForce® 7 Engine (Includes DPF)	60	100/160
MaxxForce® 9 Engine (Includes DPF)	60	100/160
MaxxForce® DT Engine (Includes DPF)	60	100/160
MaxxForce® 7 Engine glow plugs, relay, harness/connector (07 EPA)	36	Unlimited
DRIVETRAIN		
Meritor Axles (DuraStar model)	36	Unlimited
MISCELLANEOUS COVERAGE	Months	Miles
Batteries	12	Unlimited
Brightwork, Chassis Paint and Corrosion (other than Cab)	6	Unlimited
Hood/Cab Paint	12	Unlimited
FIRST 90 DAYS FROM DELIVERY TO USER (DTU)		
Correction of loose fasteners, squeaks, rattles and unusual noises		
Towing (unless specific stated coverage above)		
Adjustments and Maintenance (e.g. aim headlights, adjust brakes/clutch, adjust steering system, check and fill coolant levels.		

WHAT IS NOT INCLUDED UNDER BASIC COVERAGE

• **COMPONENTS / ITEMS:**

- Warranted by their respective manufacturers (e.g., non-Navistar brand engines, tires, Allison Transmissions, Eaton Hybrid components, lubricants, etc.)
- Bodies, equipment, and accessories installed by other than authorized Navistar Truck employees at Navistar Truck manufacturing plants.
- Front and rear axle alignment.

• **REPAIRS & MAINTENANCE:**

- Maintenance-related items/repairs, or those as a result of normal wear and tear, including tune-ups, brake/clutch linings, windshield wiper blades, tire balancing, lubrication and other similar procedures/parts required to keep vehicle in good working condition.
- Failures that are the result of poor fuel quality, water in fuel, rust, etc.
- Vehicle misuse, negligent care, improper maintenance, improper operation, or the result of accident or collision.
- Fade, runs, mismatch or damage to paint, trim items, upholstery, chrome, polished surfaces, etc., resulting from environmental causes, improper polishes, cleaners or washing solutions, or chemical and industrial fallout.
- Failure to observe published capacity or load specifications for engine, transmission, propshaft, axles (power train) and suspension.

• **OTHER:**

- Vehicles sold and/or operated outside the United States and Canada.
- Vehicles/components which have had unauthorized alterations or modifications.
- Vehicles on which the odometer reading has been altered.
- Loss of time or use of the vehicle, loss of profits, inconvenience, or other consequential or incidental damages or expenses.
- Replacement of defective parts with parts other than those provided by Navistar, Inc.

OBTAINING SERVICE

Return this vehicle to any International Truck Dealer authorized to service this model vehicle and engine.

This warranty is automatically transferred to subsequent owners at no charge. Visit your local Authorized International Truck Dealer for name and address change information.

Note: The customer has 365 days and up to a maximum of 100,000 miles (160,000 km) from DTU (delivery to end user) to purchase an extended warranty on the unit. For extended warranty purchases between, 181 through 365 days from DTU and <100,000 miles (160,000 km) an additional fee will be assessed. See your local International dealer for details.

IMPORTANT: The information contained in this Warranty Policy explains the coverage provided on your new Navistar vehicle. This policy should be kept in the vehicle for presentation to the Dealer when you request warranty services.

DISCLAIMER

NO WARRANTIES ARE GIVEN BEYOND THOSE DESCRIBED HEREIN. THIS WARRANTY IS IN LIEU OF ALL OTHER WARRANTIES, EXPRESSED OR IMPLIED. THE COMPANY SPECIFICALLY DISCLAIMS WARRANTIES OF MERCHANTABILITY AND FITNESS FOR A PARTICULAR PURPOSE, ALL OTHER REPRESENTATIONS TO THE USER/PURCHASER, AND ALL OTHER OBLIGATIONS OR LIABILITIES. THE COMPANY FURTHER EXCLUDES LIABILITY FOR INCIDENTAL AND CONSEQUENTIAL DAMAGES, ON THE PART OF THE COMPANY OR SELLER. No person is authorized to give any other warranties or to assume any liabilities on the Company's behalf unless made or assumed in writing by the Company; and no other person is authorized to give any warranties or to assume any liabilities on the seller's behalf unless made or assumed in writing by the seller.

Remedies Under State or Provincial Law: Some States and Provinces do not allow the exclusion or limitation of incidental or consequential damages, so the above limitation or exclusion may not apply to the owner. This warranty gives the owner specific legal rights, and he may also have other legal rights which may vary by state or province.

RECORD OF OWNERSHIP

Upon receipt of new vehicle by original owner, complete the following:
I have read this Warranty Brochure and fully understand the warranty coverage. I acknowledge that I have received a copy of the Owner's Limited Warranty and I accept the terms described herein.

Customer Signature	Date		
Owner's Address	City	State/Prov	Postal Code
Truck Model	Vehicle Identification Number		
Engine Number	Engine Serial Number		
Date Delivered to User (DTU)	Odometer Reading at Delivery		

SAMPLE

DURASTAR



MILES AHEAD



1

Our swept-back, front windshield comes with over 2,000 sq. in. of glass that offers a commanding view of the road.

2

Two-way breakaway mirrors and three-piece hood reduce repair costs.

3

Diamond Logic® Electrical System offers safety and convenience features like automated pre-trip inspection and parking brake alarm.

4

Our distinctive, chrome grille and variety of different color options add style to performance.

5

No-hassle MaxxFuel Advanced EGR engine technology eliminates need for extra equipment, liquid urea or traps.



IT DOESN'T JUST MAKE DELIVERIES, IT SETS THE EXAMPLE.

In your line of work, people rely on you. That's because you keep shelves stocked and their business flowing. Which is why your team drives the International[®] DuraStar[®]. Synchronized and extended service intervals reduce maintenance visits, which help save you money and keep you on the road. While breakaway mirrors and a three-piece hood make repairs quick, easy, and less expensive. Add in a spacious, ergonomically designed cab, with a best-in-class HVAC system and you get a truck that works hard, stays out on the road, and keeps everyone comfortable stop after stop, day after day. The International DuraStar. Miles ahead and raising the bar.

SEE WHAT IT'S LIKE TO LEAD THE
PACK AT INTERNATIONALTRUCKS.COM/DURASTARINFO

MILES AHEAD

6

The set-back front axle with up to 50-degree wheel cut offers better handling and a tighter turning radius.

7

Our optimized drivetrain performance matches transmission shift points with engine power curves for better responsiveness, reliability and fuel economy.

INTERNATIONAL® DURASTAR® SPECIFICATIONS

ENGINES / TORQUE

MaxxForce® 7 up to 300 HP / 660 lb -ft
MaxxForce® DT up to 300 HP / 860 lb -ft
MaxxForce® 9 up to 330 HP / 950 lb -ft
Diamond Logic® Engine Brake (9 and DT only)

GVWR CAPACITY

23,500 lbs. to 60,000 lbs.

AXLE CONFIGURATIONS

4x2, 4x4, and 6x4

TRANSMISSIONS

Allison automatic
Eaton manual
Eaton UltraShift automated manual

FRONT AXLES

Meritor
Dana
Fabco driving

REAR AXLES

Meritor
Dana

REAR SUSPENSION

Steel Spring standard
Hendrickson HMX (optional)
IROS air ride (optional)

ELECTRICAL SYSTEM

Diamond Logic: multiplexed
Alternators: Up to 320 amp pad mount
Battery Systems: Up to 3 batteries

DURASTAR® DIAMOND LOGIC® CONVENIENCE PACKAGE FEATURES

Parking brake alarm
Windshield wiper speed control (force wipers to slow)
Headlights on with wipers
Pre-trip exterior light inspection

CAB CONFIGURATION

Standard
Extended
Crew

BRAKES

4-wheel hydraulic disc with ABS
Dual air drum brakes with ABS
Traction control (optional)
Electronic stability control (optional)

INTERIOR FEATURES

- Gray color scheme with standard cup holders
- Available column shift with Allison 1000 and 2000 Transmissions
- Available tilts/telescoping column
- Standard cruise control on steering wheel
- LCD display for vehicle diagnostics
- Courtesy light and storage compartments mounted in door
- Extra long seat belts to accommodate larger drivers with heavy work clothing
- Top-quality cloth or vinyl facings seats with dual armrests
- One of the industry's most spacious cabs with more shoulder room, headroom and belly room to keep drivers of all sizes comfortable
- The standard overhead console provides ample storage and convenience

EXTERIOR FEATURES

- Standard rear rubber auxiliary springs provide better stability and a smoother ride for increased driver satisfaction
- The powder-coated bumper resists chips, scratches and corrosion
- Two-way breakaway mirrors improve durability while keeping repair costs low
- Chrome-finished, one-piece grille that's easy to remove delivers a bold and stylish appearance
- A three-piece hood reduces repair costs by letting you replace the fender independently of the hood
- Base coat/clear coat paint



A NAVISTAR COMPANY

*Standard Equipment Specifications are subject to change without notice.

Specifications, descriptors and illustrative material in this literature are as accurate as known at time of publication, but are subject to change without notice. Illustrations may include optional equipment and accessories, and may not include all standard equipment. International and the International Diamond logo are registered trademarks of Navistar Inc.

© 2010 Navistar, Inc. Warrenville, IL 60555

TAD10004
Lithographed in the United States of America

