

EXPRESSION OF INTEREST

To provide

**Professional Engineering Design
Services
and
Construction Monitoring Services
for the**

**Pepper Portals & Drainage
Barbour County, West Virginia
DEP16069**

**Prepared for the
West Virginia Department
of Environmental Protection
Office of AML&R**

CTL Engineering of West Virginia, Inc.

**733 Fairmont Road
Morgantown, WV 26501**

**510 C Street
South Charleston, WV 25303**

01/18/13 11:35:16 AM
West Virginia Purchasing Division

January 16, 2013

West Virginia Department of Environmental Protection
Office of Abandoned Mine Lands & Reclamation
601 57th Street SE
Charleston, WV 25304

Re: RFQ #DEP 16069
Expression of Interest
Design Engineering Services Proposal
Pepper Portals & Drainage Project

Gentlemen:

CTL Engineering of WV, Inc. is very pleased to present this proposal to provide design engineering and related services for the West Virginia Abandoned Mine Lands and Reclamation Program. With over 80 years in the business, we feel our firm can provide the professionals and facilities the State of West Virginia is looking for.

CTL has evolved into a recognized leader in the Abandoned Mine Lands Engineering Design and Investigation field. We offer the services necessary to provide a non-subcontract, quality product to support your program. Our capabilities include laboratory facilities, drilling rigs, surveying systems, design equipment, and a qualified staff. We have 12 Professional Engineers, five of which are registered in West Virginia and have direct AML Design Experience. Our in-house disciplines of professionals include: Civil & Mining Engineers, CAD Designers, Surveyors, Geologists, Hydrologists and Biologists. We are experienced in completing more than 50 projects annually that require aerial mapping, support surveying with GPS, and final contouring for design.

Our in-house ability reaches beyond simply being an AML design firm. We also have extensive contract administration and management experience with the procedures of the state of West Virginia. Our invoicing procedures and accounting software has been accepted, used, and audited by various state agencies.

CTL's primary staff has over 125 years of experience with mine reclamation engineering on both a national and international level. Our qualifications and facilities are unsurpassed when it comes to Abandoned Mine Reclamation Design. With offices in Charleston and Morgantown, we can effectively respond to any AML Design tasks throughout West Virginia. In addition, we have six full time design teams available to complete AML design projects. Our corporation and individual staff members have extensive experience relative to reclamation design, highwall elimination, abandoned portal seals and drainage control structures. The Pepper Portals and Drainage Project is similar in scope to

more than 35 AML design projects we have successfully completed. Attached to this proposal are numerous examples of similar projects successfully designed and completed, including several projects that were nominated and chosen as National AML Reclamation Award winners!

We sincerely appreciate the opportunity to submit this proposal to you for consideration. Should you have any questions or need additional information, please contact our office.

Respectfully submitted,

CTL Engineering of West Virginia, Inc.

A handwritten signature in black ink, appearing to read "Royden Loucks", with a long horizontal flourish extending to the right.

Royden L. Loucks
Director Business Development





State of West Virginia
 Department of Administration
 Purchasing Division
 2019 Washington Street East
 Post Office Box 50130
 Charleston, WV 25305-0130

Solicitation

NUMBER
DEP16069

PAGE
1

ADDRESS CORRESPONDENCE TO ATTENTION OF:
GUY NISBET
304-558-8802

VENDOR

RFQ COPY
 TYPE NAME/ADDRESS HERE
 CTL Engineering of West Virginia, Inc.
 733 Fairmont Road
 Morgantown, WV 26501

SHIP TO

ENVIRONMENTAL PROTECTION
 DEPARTMENT OF
 OFFICE OF AML&R
 601 57TH STREET SE
 CHARLESTON, WV
 25304 304-926-0499

DATE PRINTED
12/18/2012

BID OPENING DATE: 01/22/2013 BID OPENING TIME 1:30PM

LINE	QUANTITY	UOP	CAT NO	ITEM NUMBER	UNIT PRICE	AMOUNT
0001	1	JB		906-29		
PEPPER PORTALS & DRAINAGE DESIGN						
EXPRESSION OF INTEREST						
THE WEST VIRGINIA PURCHASING DIVISION, FOR THE AGENCY, THE WEST VIRGINIA DEPARTMENT OF ENVIRONMENTAL PROTECTION, IS SOLICITING EXPRESSIONS OF INTEREST FOR PROFESSIONAL ENGINEERING DESIGN SERVICES AND CONSTRUCTION MONITORING SERVICES AT THE PEPPER PORTALS & DRAINAGE PROJECT IN BARBOUR COUNTY, WEST VIRGINIA, PER THE FOLLOWING BID REQUIREMENTS AND ATTACHED SPECIFICATIONS.						
***** THIS IS THE END OF RFQ DEP16069 ***** TOTAL:						

SIGNATURE <i>Ryder Lee</i>	TELEPHONE (304) 292-1135	DATE Jan. 16, 2013
TITLE Dir. - Business Development	FEIN 55-063-1834	ADDRESS CHANGES TO BE NOTED ABOVE

WHEN RESPONDING TO SOLICITATION, INSERT NAME AND ADDRESS IN SPACE ABOVE LABELED 'VENDOR'

ADDENDUM ACKNOWLEDGEMENT FORM

SOLICITATION NO.: DEP16069

Instructions: Please acknowledge receipt of all addenda issued with this solicitation by completing this addendum acknowledgment form. Check the box next to each addendum received and sign below. Failure to acknowledge addenda may result in bid disqualification.

Acknowledgment: I hereby acknowledge receipt of the following addenda and have made the necessary revisions to my proposal, plans and/or specification, etc.

Addendum Numbers Received:

(Check the box next to each addendum received)

- | | |
|---|--|
| <input type="checkbox"/> Addendum No. 1 | <input type="checkbox"/> Addendum No. 6 |
| <input type="checkbox"/> Addendum No. 2 | <input type="checkbox"/> Addendum No. 7 |
| <input type="checkbox"/> Addendum No. 3 | <input type="checkbox"/> Addendum No. 8 |
| <input type="checkbox"/> Addendum No. 4 | <input type="checkbox"/> Addendum No. 9 |
| <input type="checkbox"/> Addendum No. 5 | <input type="checkbox"/> Addendum No. 10 |

I understand that failure to confirm the receipt of addenda may be cause for rejection of this bid. I further understand that any verbal representation made or assumed to be made during any oral discussion held between Vendor's representatives and any state personnel is not binding. Only the information issued in writing and added to the specifications by an official addendum is binding.

CTL Engineering of West Virginia, Inc.
Company

Authorized Signature

January 16, 2013
Date

NOTE: This addendum acknowledgment should be submitted with the bid to expedite document processing.

RFQ No. DEP 16069

STATE OF WEST VIRGINIA
Purchasing Division

PURCHASING AFFIDAVIT

MANDATE: Under W. Va. Code §5A-3-10a, no contract or renewal of any contract may be awarded by the state or any of its political subdivisions to any vendor or prospective vendor when the vendor or prospective vendor or a related party to the vendor or prospective vendor is a debtor and: (1) the debt owed is an amount greater than one thousand dollars in the aggregate; or (2) the debtor is in employer default.

EXCEPTION: The prohibition listed above does not apply where a vendor has contested any tax administered pursuant to chapter eleven of the W. Va. Code, workers' compensation premium, permit fee or environmental fee or assessment and the matter has not become final or where the vendor has entered into a payment plan or agreement and the vendor is not in default of any of the provisions of such plan or agreement.

DEFINITIONS:

"Debt" means any assessment, premium, penalty, fine, tax or other amount of money owed to the state or any of its political subdivisions because of a judgment, fine, permit violation, license assessment, defaulted workers' compensation premium, penalty or other assessment presently delinquent or due and required to be paid to the state or any of its political subdivisions, including any interest or additional penalties accrued thereon.

"Employer default" means having an outstanding balance or liability to the old fund or to the uninsured employers' fund or being in policy default, as defined in W. Va. Code § 23-2c-2; failure to maintain mandatory workers' compensation coverage; or failure to fully meet its obligations as a workers' compensation self-insured employer. An employer is not in employer default if it has entered into a repayment agreement with the Insurance Commissioner and remains in compliance with the obligations under the repayment agreement.

"Related party" means a party, whether an individual, corporation, partnership, association, limited liability company or any other form or business association or other entity whatsoever, related to any vendor by blood, marriage, ownership or contract through which the party has a relationship of ownership or other interest with the vendor so that the party will actually or by effect receive or control a portion of the benefit, profit or other consideration from performance of a vendor contract with the party receiving an amount that meets or exceeds five percent of the total contract amount.

AFFIRMATION: By signing this form, the vendor's authorized signer affirms and acknowledges under penalty of law for false swearing (W. Va. Code §61-5-3) that neither vendor nor any related party owe a debt as defined above and that neither vendor nor any related party are in employer default as defined above, unless the debt or employer default is permitted under the exception above.

WITNESS THE FOLLOWING SIGNATURE:

Vendor's Name: CTL Engineering of West Virginia, Inc

Authorized Signature: _____ Date: Jan. 16, 2013

State of West Virginia

County of Monongalia, to-wit:

Taken, subscribed, and sworn to before me this 16th day of January, 2013.

My Commission expires January 17, 2020.

AFFIX SEAL HERE

NOTARY PUBLIC Kathleen J. O'Brien

Purchasing Affidavit (Revised 07/01/2012)



CERTIFICATION AND SIGNATURE PAGE

By signing below, I certify that I have reviewed this Solicitation in its entirety; understand the requirements, terms and conditions, and other information contained herein; that I am submitting this bid or proposal for review and consideration; that I am authorized by the bidder to execute this bid or any documents related thereto on bidder's behalf; that I am authorized to bind the bidder in a contractual relationship; and that to the best of my knowledge, the bidder has properly registered with any State agency that may require registration.

CTL Engineering of West Virginia, Inc.
 (Company)

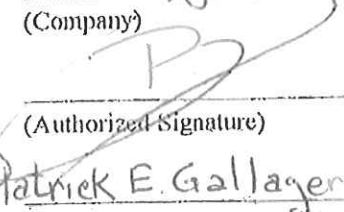
 (Authorized Signature)

Patrick E. Gallager, President
 (Representative Name, Title)

(304) 292-1135
 (Phone Number)

(304) 296-9302
 (Fax Number)

January 16, 2013
 (Date)

Client#: 101489

CTLENG

ACORD™

CERTIFICATE OF LIABILITY INSURANCE

DATE (MM/DD/YYYY)
1/15/2013

THIS CERTIFICATE IS ISSUED AS A MATTER OF INFORMATION ONLY AND CONFERS NO RIGHTS UPON THE CERTIFICATE HOLDER. THIS CERTIFICATE DOES NOT AFFIRMATIVELY OR NEGATIVELY AMEND, EXTEND OR ALTER THE COVERAGE AFFORDED BY THE POLICIES BELOW. THIS CERTIFICATE OF INSURANCE DOES NOT CONSTITUTE A CONTRACT BETWEEN THE ISSUING INSURER(S), AUTHORIZED REPRESENTATIVE OR PRODUCER, AND THE CERTIFICATE HOLDER.

IMPORTANT: If the certificate holder is an ADDITIONAL INSURED, the policy(ies) must be endorsed. If SUBROGATION IS WAIVED, subject to the terms and conditions of the policy, certain policies may require an endorsement. A statement on this certificate does not confer rights to the certificate holder in lieu of such endorsement(s).

PRODUCER Huntington Insurance, Inc. 440 Polaris Parkway Westerville, OH 43082 888 576-7900	CONTACT NAME: Ivy Hughes		
	PHONE (A/C, No, Ext): 614-899-8538	FAX (A/C, No): 877-829-4531	
E-MAIL ADDRESS: ivy.hughes@huntington.com			
INSURED CTL Engineering of WV Inc. 733 Fairmont Road Morgantown, WV 26501	INSURER(S) AFFORDING COVERAGE		NAIC #
	INSURER A: Cincinnati Insurance Company		10677
	INSURER B:		
	INSURER C:		
	INSURER D:		
INSURER E:			
INSURER F:			

COVERAGES **CERTIFICATE NUMBER:** **REVISION NUMBER:**

THIS IS TO CERTIFY THAT THE POLICIES OF INSURANCE LISTED BELOW HAVE BEEN ISSUED TO THE INSURED NAMED ABOVE FOR THE POLICY PERIOD INDICATED. NOTWITHSTANDING ANY REQUIREMENT, TERM OR CONDITION OF ANY CONTRACT OR OTHER DOCUMENT WITH RESPECT TO WHICH THIS CERTIFICATE MAY BE ISSUED OR MAY PERTAIN, THE INSURANCE AFFORDED BY THE POLICIES DESCRIBED HEREIN IS SUBJECT TO ALL THE TERMS, EXCLUSIONS AND CONDITIONS OF SUCH POLICIES. LIMITS SHOWN MAY HAVE BEEN REDUCED BY PAID CLAIMS.

INSR LTR	TYPE OF INSURANCE	ADDL INSR	SUBR WVD	POLICY NUMBER	POLICY EFF (MM/DD/YYYY)	POLICY EXP (MM/DD/YYYY)	LIMITS
A	GENERAL LIABILITY <input checked="" type="checkbox"/> COMMERCIAL GENERAL LIABILITY CLAIMS-MADE <input checked="" type="checkbox"/> OCCUR <input checked="" type="checkbox"/> BI/PD Ded:4,000 GEN'L AGGREGATE LIMIT APPLIES PER: <input checked="" type="checkbox"/> POLICY <input checked="" type="checkbox"/> PRO-JECT <input type="checkbox"/> LOC			CPP0895397	01/01/2013	01/01/2014	EACH OCCURRENCE \$1,000,000 DAMAGE TO RENTED PREMISES (Ea occurrence) \$500,000 MED EXP (Any one person) \$10,000 PERSONAL & ADV INJURY \$1,000,000 GENERAL AGGREGATE \$2,000,000 PRODUCTS - COMP/OP AGG \$2,000,000 \$
A	AUTOMOBILE LIABILITY <input checked="" type="checkbox"/> ANY AUTO ALL OWNED AUTOS <input checked="" type="checkbox"/> HIRED AUTOS <input checked="" type="checkbox"/> SCHEDULED AUTOS NON-OWNED AUTOS			CPP0895397	01/01/2013	01/01/2014	COMBINED SINGLE LIMIT (Ea accident) \$1,000,000 BODILY INJURY (Per person) \$ BODILY INJURY (Per accident) \$ PROPERTY DAMAGE (Per accident) \$ \$
A	<input checked="" type="checkbox"/> UMBRELLA LIAB <input type="checkbox"/> EXCESS LIAB OCCUR CLAIMS-MADE DED <input checked="" type="checkbox"/> RETENTION \$0	X	X	CPP0895397	01/01/2013	01/01/2014	EACH OCCURRENCE \$10,000,000 AGGREGATE \$10,000,000 \$
A	WORKERS COMPENSATION AND EMPLOYERS' LIABILITY ANY PROPRIETOR/PARTNER/EXECUTIVE OFFICER/MEMBER EXCLUDED? <input checked="" type="checkbox"/> Y <input type="checkbox"/> N (Mandatory in NH) If yes, describe under DESCRIPTION OF OPERATIONS below		X	WC1861217	01/01/2013	01/01/2014	<input checked="" type="checkbox"/> WC STATU-TORY LIMITS <input type="checkbox"/> OTH-ER E.L. EACH ACCIDENT \$1,000,000 E.L. DISEASE - EA EMPLOYEE \$1,000,000 E.L. DISEASE - POLICY LIMIT \$1,000,000
A	Leased/Rented Inst. Fltr			CPP0895397	01/01/2013	01/01/2014	\$200,000/\$2,500 Ded \$800,000/\$1,000 Ded

DESCRIPTION OF OPERATIONS / LOCATIONS / VEHICLES (Attach ACORD 101, Additional Remarks Schedule, if more space is required)
 Automatic Additional Insured including Waiver of Subrogation and Primary and Noncontributory included under General Liability per form GA233, where required by written contract, Automatic Additional Insured provided under the Auto per form AA4171, Blanket Waiver of Subrogation provided under the Auto per form AA4172, Blanket Waiver of Subrogation provided under the WC per form WC000313 (not applicable in KY), Broad form Employers Liability (code 23-4-2) included for West Virginia per form WC9906 140 per written contract.

CERTIFICATE HOLDER For Information Only	CANCELLATION SHOULD ANY OF THE ABOVE DESCRIBED POLICIES BE CANCELLED BEFORE THE EXPIRATION DATE THEREOF, NOTICE WILL BE DELIVERED IN ACCORDANCE WITH THE POLICY PROVISIONS. AUTHORIZED REPRESENTATIVE 
---	--

© 1988-2010 ACORD CORPORATION. All rights reserved.



CERTIFICATE OF LIABILITY INSURANCE

DATE (MM/DD/YYYY)
1/7/2013

THIS CERTIFICATE IS ISSUED AS A MATTER OF INFORMATION ONLY AND CONFERS NO RIGHTS UPON THE CERTIFICATE HOLDER. THIS CERTIFICATE DOES NOT AFFIRMATIVELY OR NEGATIVELY AMEND, EXTEND OR ALTER THE COVERAGE AFFORDED BY THE POLICIES BELOW. THIS CERTIFICATE OF INSURANCE DOES NOT CONSTITUTE A CONTRACT BETWEEN THE ISSUING INSURER(S), AUTHORIZED REPRESENTATIVE OR PRODUCER, AND THE CERTIFICATE HOLDER.

IMPORTANT: If the certificate holder is an ADDITIONAL INSURED, the policy(ies) must be endorsed. If SUBROGATION IS WAIVED, subject to the terms and conditions of the policy, certain policies may require an endorsement. A statement on this certificate does not confer rights to the certificate holder in lieu of such endorsement(s).

PRODUCER STA, a Division of Oswald Companies 3401 Enterprise Parkway, Suite 101 Beachwood OH 44122	CONTACT NAME: Patricia Cholewa	
	PHONE (A/C, No, Ext): 216-839-2807	FAX (A/C, No): 216-839-2815
E-MAIL ADDRESS: pcholewa@oswaldcompanies.com		
INSURER(S) AFFORDING COVERAGE		NAIC #
INSURER A: Evanston Insurance Company		35378
INSURER B:		
INSURER C:		
INSURER D:		
INSURER E:		
INSURER F:		

INSURED CTLEN-1
 CTL Engineering of W.V., Inc.
 733 Fairmont Road
 Morgantown WV 26501

COVERAGES **CERTIFICATE NUMBER:** 1221639039 **REVISION NUMBER:**

THIS IS TO CERTIFY THAT THE POLICIES OF INSURANCE LISTED BELOW HAVE BEEN ISSUED TO THE INSURED NAMED ABOVE FOR THE POLICY PERIOD INDICATED. NOTWITHSTANDING ANY REQUIREMENT, TERM OR CONDITION OF ANY CONTRACT OR OTHER DOCUMENT WITH RESPECT TO WHICH THIS CERTIFICATE MAY BE ISSUED OR MAY PERTAIN, THE INSURANCE AFFORDED BY THE POLICIES DESCRIBED HEREIN IS SUBJECT TO ALL THE TERMS, EXCLUSIONS AND CONDITIONS OF SUCH POLICIES. LIMITS SHOWN MAY HAVE BEEN REDUCED BY PAID CLAIMS.

INSR LTR	TYPE OF INSURANCE	ADDL INSR	SUBR WVD	POLICY NUMBER	POLICY EFF (MM/DD/YYYY)	POLICY EXP (MM/DD/YYYY)	LIMITS
	GENERAL LIABILITY <input type="checkbox"/> COMMERCIAL GENERAL LIABILITY <input type="checkbox"/> CLAIMS-MADE <input type="checkbox"/> OCCUR GENL AGGREGATE LIMIT APPLIES PER: <input type="checkbox"/> POLICY <input type="checkbox"/> PRO-JECT <input type="checkbox"/> LOC						EACH OCCURRENCE \$ DAMAGE TO RENTED PREMISES (Ea occurrence) \$ MED EXP (Any one person) \$ PERSONAL & ADV INJURY \$ GENERAL AGGREGATE \$ PRODUCTS - COMP/OP AGG \$ \$
	AUTOMOBILE LIABILITY <input type="checkbox"/> ANY AUTO <input type="checkbox"/> ALL OWNED AUTOS <input type="checkbox"/> SCHEDULED AUTOS <input type="checkbox"/> HIRED AUTOS <input type="checkbox"/> NON-OWNED AUTOS						COMBINED SINGLE LIMIT (Ea accident) \$ BODILY INJURY (Per person) \$ BODILY INJURY (Per accident) \$ PROPERTY DAMAGE (Per accident) \$ \$
	UMBRELLA LIAB <input type="checkbox"/> OCCUR EXCESS LIAB <input type="checkbox"/> CLAIMS-MADE DED RETENTION \$						EACH OCCURRENCE \$ AGGREGATE \$ \$
	WORKERS COMPENSATION AND EMPLOYERS' LIABILITY ANY PROPRIETOR/PARTNER/EXECUTIVE OFFICER/MEMBER EXCLUDED? <input type="checkbox"/> Y <input checked="" type="checkbox"/> N (Mandatory in NH) If yes, describe under DESCRIPTION OF OPERATIONS below		N/A				<input type="checkbox"/> WC STATUTORY LIMITS <input type="checkbox"/> OTH-ER E.L. EACH ACCIDENT \$ E.L. DISEASE - EA EMPLOYEE \$ E.L. DISEASE - POLICY LIMIT \$
A	Professional Liability Claims Made Retro Date: 1/1/1927	N	Y	AE822501	12/31/2012	12/31/2013	Each Claim \$2,000,000 Aggregate \$2,000,000 Pollution Liability Included

DESCRIPTION OF OPERATIONS / LOCATIONS / VEHICLES (Attach ACORD 101, Additional Remarks Schedule, if more space is required)
 Waiver of Subrogation as designated above is provided when required of the Named Insured by written contract or agreement.

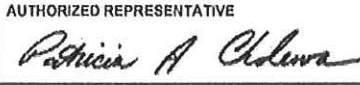
CERTIFICATE HOLDER Specimen Certificate for Insurance Evidencing Purposes Only 733 Fairmont Rd Morgantown WV 26501	CANCELLATION SHOULD ANY OF THE ABOVE DESCRIBED POLICIES BE CANCELLED BEFORE THE EXPIRATION DATE THEREOF, NOTICE WILL BE DELIVERED IN ACCORDANCE WITH THE POLICY PROVISIONS. AUTHORIZED REPRESENTATIVE 
---	--

Project Management Plan

Our approach to the **Pepper Portals & Drainage Project** will be similar to other CTL AML highwall elimination and portal seal projects. The Project Management Plan we have developed for these sites are as follows:

- The project manager will be solely responsible for expedient and accurate completion of each phase of the individual projects performed under this contract. He will review the project sites and discuss the specific scope of work for the project with the project representative from the WVDEP. A cost proposal will be prepared, in accordance with contract unit rates, based upon an estimate of manpower, equipment, and laboratory needs.
- CTL will then mobilize a fully equipped survey crew to set survey control and map the project sites. Permanent control monuments will be established to ensure that the construction contractor can tie into the necessary baselines. The project manager will supervise the surveying tasks and provide budgetary control for this portion of the work.
- A geotechnical investigation shall be performed to delineate the mine pool and to determine and design the optimum wet seals for each of the open and collapsed portals. If required, piezometers shall be installed to monitor the mine pool and determine hydraulic head associated with the pools. This investigation shall be performed with a focus on safety to insure the safety of the local inhabitants and dwellings as well as the safety of the drilling and geotechnical personnel.
- Should field conditions dictate that additional work or a major modification is required, the project manager will contact the WVDEP representative immediately to confirm the changed conditions.
- Following completion of the surveying, field investigation, and any material sampling, the analytical design work will begin. The Project Manager and Engineer will review the project data, evaluate the feasible alternatives and prepare a preliminary set of construction documents. The documents will include at a minimum:
 1. A site map indicating existing conditions;
 2. A tax map overlay with the parcels identified that may be impacted by the proposed design;

3. Proposed grading plans for elimination and backfilling of highwalls, including safely dewatering and excavation of all portals;
4. Design for all mine portal wet seals and bat gates;
5. Provide reclamation design for subsidence area;
6. Provide Sedimentation and Erosion Control Plan;
7. Site Profiles;
8. Cross Sections;
9. Drainage systems and control structures, with details;
10. Survey control points;
11. Miscellaneous Site details.

- CTL will also provide all necessary data for NPDES permits including S&E Control Plans as required for the site construction and if deemed necessary, perform environmental assessments.
- In addition to preparation of the above-described drawings, a complete set of specifications will be prepared and outlined to describe in detail the scope and methods of work to be accomplished. An estimate of construction costs and the design calculations will also be submitted to the WVDEP for review and future reference.
- Following the submission of the construction documents, a project design review meeting will be coordinated with the WVDEP, CTL, and appropriate individuals to review the proposed plans.
- Recommendations for plan revisions will be discussed and implemented, as necessary, into the final design documents. Upon completion, all final documents, drawings, plans and specifications will be forwarded to the WVDEP for bidding purposes.
- Construction observation will be provided during the construction phase of the projects
- At the request of the WVDEP, CTL will provide construction observation personnel.

Our Project Manager and/or Engineer will coordinate the pre-bid and pre-construction conferences with the WVDEP to address any questions and supply the necessary survey control data. Periodic inspections may be conducted by our Project Manager, as deemed necessary by the WVDEP, to address specific problems that arise during construction. A report will be prepared by CTL following each of these meetings detailing the findings, conclusions, recommendations, and responses to pertinent questions.

Project Scope

Pepper Portals & Drainage

Project Scope of Work:

Provide clearing and grubbing plan of site

Design diversion channels, ditches and/or underdrains to transport drainage safely off-site

Design Regrading plan to backfill highwall utilizing available material and borrowed soil to AOC. Also includes site clean-up of extraneous trash and waste from site.

Identify and provide plan for borrow area, if required

Design plan for draining 8 mine portals and design 1 mine wet seal and 7 bat gates.

Design subsidence area reclamation plan

Provide revegetation plan including soil cover for all areas disturbed during construction

Provide required data for clearing and grubbing, S&E Control Plans and NPDES Permit submittal by AML

CTL Engineering of West Virginia, Inc.

An Employee Owned Company

CTL Engineering of West Virginia, Inc. (CTL of WV) is a full service consulting civil engineering, testing, inspection, and analytical services company. CTL Engineering of West Virginia, Inc. was formed in 1981 to service West Virginia, Maryland and Pennsylvania. CTL of WV is part of CTL Engineering, Inc. formerly known as Columbus Testing Laboratory, which was established in Columbus, Ohio in 1927 as an independent engineering testing laboratory serving the local community. During the early years, our expertise focused mainly on soils, foundation engineering, and construction testing and inspection services.

The Engineering News-Record ranked CTL Engineering, Inc. among top 500 architectural and engineering firms in the nation. CTL Engineering maintains a staff of over 200 employees, including registered engineers, architects, chemists, environmental scientists, geologists, hydrologists, wetland scientists and technicians.

CTL of WV provides total Civil Site Design for development projects throughout West Virginia. These designs include site layouts, utility design and interconnections, stormwater management design, parking and roadway design, permit preparation and submittal, and interaction with architects, owners and all interested parties to the projects.

CTL of WV provides all necessary surveying services required of projects including boundary and ALTA surveys, topographic surveys, aerial survey control, GPS surveys, and site construction surveys to assure proper construction and compliance with specifications of the project.

CTL of WV has become an industry leader in geotechnical design and investigations. In the past 5 years, CTL of WV has provided over 1000 geotechnical investigations including drilling, sampling and design for both the public and private sectors. CTL of WV is regularly called upon to provide unique geotechnical engineering design services for projects throughout the United States and Canada.

CTL of WV provides environmental services for developments throughout West Virginia and Maryland. Environmental Services include Phase I and II ESAs, wetland delineation and mitigation plans, State and Federal 401 and 404 Permit submittals, Ms4 Phase II storm water permitting, soil and groundwater sampling, asbestos surveys and sampling, lead based paint testing, mold testing, UST removal oversight, hazardous material identification and remedial design and other environmental services as required

CTL of WV provides construction, material and concrete testing and observation services. CTL of WV has ten field technicians providing dedicated construction observation and compliance testing. CTL's in-house material laboratory provides the much needed prompt turn-around required for projects to be successful.

Additional services provided by CTL include Nondestructive Testing and Inspection, Forensic Science, Accident Re-Construction, Roofing Consulting, Product Testing, Laboratories, Analytical Chemistry and Metallurgy Services.





AML & Relevant Project Experience *(2008 – 2012)*

HIGHWALLS

- Anderson Highwalls, WVDEP
- Peninsula Highwalls, WVDEP
- St. Clair Portals, WVDEP
- Collins Mining, ODNR
- Miller Mining, ODNR

OPEN PITS

- Shinn's Run Portals, WVDEP
- Jones Trucking, ODNR
- General Clay #1 & #2, ODNR

OPEN MINE SHAFTS

- Kennel Mine Closure, MDE, AMLD
- Frostburg North Closure, MDE, AMLD
- Zilman Closure, MDE, AMLD

REFUSE PILES

- Ream Refuse Pile, WVDEP
- Williams Refuse Pile, Private
- Harrison Power Plant, Allegheny Power

MINE SUBSIDENCE

- Fairmont Subsidence, WV DEP
- Lower Consol Road MDE, AMLD
- Terra Haute Airport, IN AML
- Farmington UMC, WV DEP Emergency
- Morningside Baptist, WV DEP Emergency
- Eccles Subsidence, WV DEP
- McArthur Subsidence, WV DEP
- Mark Kempner, NJ Private
- WV BRIM
- OMSIUA

MINE DRAINAGE/STREAM RESTORATION

- St. Clair Portals, WV DEP
- Aaron's Run, MDE, AMLD
- Deckers Creek, WVDEP

LANDSLIDES

- Douglas Avenue Landslide, MDE, AMLD
- Schramm Landslide, MDE, AMLD
- Gordon Landslide, MDE, AMLD
- East Franklin Landslide, MDE, AMLD
- Cheat Neck Landslide, WV DEP
- McCourt Landslide, ODNR
- Caldonia Hill Slope Stability, MDE, AMLD

WATER SUPPLY REPLACEMENT

- Douglas Avenue Stormwater System Repair, MDE, AMLD
- Bald Knob & Potomas Hollow Water Invsetigations, MDE, AMLD
- Pee Wee Hill Supply Design, MDE, AMLD
- Pee Wee Will Water Feasibility Study, MDE, AMLD
- Fairview Water Feasibility, WV DEP
- Tioga Water Feasibility, WV DEP



CTL Engineering Inc.

Professional Services

Established 1927

Analytical Chemistry

- ◆ Soil
- ◆ Water
- ◆ Oils
- ◆ Sludges
- ◆ Solid and Hazardous Wastes
- ◆ Liquid and Solid Fuels
- ◆ Metals
- ◆ Organics
- ◆ Construction Materials

Construction Inspection

- ◆ Soils, Concrete, Asphalt, Masonry, Fireproofing, and Steel
- ◆ Single and Multi-Story Structures
- ◆ Pavement for Streets, Airports, Etc.
- ◆ Embankments, Fill, Cut, Etc.
- ◆ Earth and Concrete Dams
- ◆ Pre and Post Construction Inspection
- ◆ Floor Flatness

Drafting Services

- ◆ AutoCad
- ◆ Microstation
- ◆ Digitizing

Environmental

- ◆ Site/Facility Assessment
- ◆ Hydrogeologic Studies and Aquifer Characterization
- ◆ Site Remediation
- ◆ Site Abandonment and Closure Planning
- ◆ Permit Preparation
- ◆ Underground Storage Tank Management
- ◆ Wellhead Protection
- ◆ Asbestos Survey
- ◆ Abatement Monitoring
- ◆ Wetlands Delineation
- ◆ Wetlands Mitigation
- ◆ Wetlands Permitting

Existing Structure Evaluation

- ◆ Bridges/Buildings
- ◆ Sonic Velocity Testing
- ◆ Delamination Determination
- ◆ Half Cell Potential Tests

Facilities Management - Pavement

- ◆ Condition Assessment
- ◆ Maintenance & Rehabilitation Strategies
- ◆ Prioritization
- ◆ Deterioration Rates
- ◆ Network Needs & Long Range Goals
- ◆ Budgeting

Forensic Science

- ◆ Landslide, Soils and Foundation Failures
- ◆ Building Failures
- ◆ Product Liability Investigations
- ◆ Accident Reconstruction
- ◆ Roofing Failures
- ◆ Product Failures
- ◆ Legal Testimony

Geotechnical

- ◆ Site Selection
- ◆ Subsurface Exploration - Drilling Services
- ◆ Foundation Analysis & Design
- ◆ Embankment & Earth Dam Analysis
- ◆ Slope Stability Analysis
- ◆ Hydrogeologic Studies
- ◆ Bridges
- ◆ Pavement Design

Materials Testing

- ◆ Concrete
- ◆ Soils and Rock
- ◆ Aggregates
- ◆ Concrete and Asphalt Mix Designs
- ◆ Bituminous Materials
- ◆ Clay and Masonry Products
- ◆ Petrographic Studies

Metallurgy

- ◆ Fracture Analysis
- ◆ Metallography
- ◆ Application Recommendations
- ◆ Failure Analysis
- ◆ Corrosion studies
- ◆ Tensile and Hardness

Mining Engineering

- ◆ Mine Reclamation Design
- ◆ Permit Preparation
- ◆ Mine Plan Design
- ◆ Refuse Disposal Design
- ◆ Drainage Control Structures
- ◆ Environmental Monitoring
- ◆ Subsidence Investigations

Nondestructive Testing & Inspection

- ◆ X-ray Radiology
- ◆ Ultrasonic Inspections
- ◆ Magnetic Particle Inspection
- ◆ Liquid Penetrant Inspection
- ◆ Specialized Inspection / Test Programs
- ◆ Level III Services

Product Testing

- ◆ Consumer Product Testing
- ◆ Mechanical and Physical Property Testing
- ◆ Hydrostatic Testing
- ◆ Load and Strength Testing
- ◆ Mechanical Engineering Design and Analysis
- ◆ Pressure Gauge Calibration

Roofing Engineering Services

- ◆ Design & Construction Administration (Plans and Specifications)
- ◆ Quality Control/ Roof Inspection
- ◆ Roof Surveys Evaluation
- ◆ Moisture - Infrared & Nuclear
- ◆ Seminars Design
- ◆ Maintenance
- ◆ Management Programs
- ◆ Laboratory Testing

Site/Civil Engineering

- ◆ Commercial Land Development
- ◆ Residential/Community Planning
- ◆ Infrastructure Planning

Software Development

- ◆ Application Software
- ◆ Internet & Intranet

Surveying & Mapping

- ◆ Property surveying & boundary determination
- ◆ Topographic mapping development
- ◆ Global Positioning System

Welding & Quality Control

- ◆ Shop & Field Certified Welding Inspection
- ◆ Welding and Brazing Qualification
- ◆ Procedure Development
- ◆ QA/QC Programs

Corporate Headquarters

2860 Fisher Road **Columbus, Ohio 43204**
 Phone: (614) 276-8123, Fax: (614) 276-6377
 ctl@ctleng.com
 www.ctleng.com

OFFICES:

CTL of West Virginia.
 733 Fairmont Road
Morgantown, WV 26501
 Phone:(304) 292-1135
 Fax: (304) 296-9302
 ctlwv@ctleng.com

510 C Street
South Charleston, WV 25303
 Phone: (304) 746-1140
 Fax: (304) 746-1143

422 E. Wards Corner Road
Cincinnati, OH 45140
 Phone: (513) 722-8665
 Fax: (513) 722-8669
 ctlcinci@ctleng.com

633 High Street
Minford, OH 45653
 Phone: (740) 820-8355
 Fax: (740) 820-5698

3085 Interstate Parkway
Brunswick, OH 44212
 Phone: (330) 220-8900
 Fax: (330) 220-8944
 ctcleve@ctleng.com

102 Commerce Dr.
Wapakoneta, OH 45895
 Phone: (419) 738-1447
 Fax: (419) 738-7670
 ctlwapak@bright.net

4343 Saguaro Trail
Indianapolis, IN 46268
 Phone: (317) 295-8650
 Fax: (317) 295-8395
 ctlin@ctleng.com

Services Include:

- ◆ Commercial Land Development
- ◆ Residential/Community Planning
- ◆ Infrastructure Planning & Design
- ◆ Pavement Design and Management
- ◆ Conceptual Designs/Presentations
- ◆ Recreational Resort/Facility Planning
- ◆ Erosion & Sediment Control Design
- ◆ Stormwater Management Systems
- ◆ Preliminary Cost Estimates/ Feasibility Analyses

CTL Engineering's in house staff provide a full array of services in concert with our Site/Civil Department including mapping and surveying services.

From a Raw Piece of Property -- CTL Engineering Provides Full Site Layout Design.

- ◆ Topographic Mapping Development
- ◆ Global Positioning Systems (GPS) Services
- ◆ Aerial Mapping Layout & Control
- ◆ Construction Layout
- ◆ Wetlands Delineation/Flood Plain Determination & Certification
- ◆ Property Survey & Boundary Determination
- ◆ Micrometer Leveling



CTL Engineering of West Virginia, Inc. provided site plans for this Advance Auto Parts Store in Morgantown, West Virginia



CTL Engineering of West Virginia, Inc. provided geotechnical engineering, materials testing, observation services and surveying services for this project.

Surveying & Mapping



CTL Engineering, Inc. provided surveying services for this McDonald's site in Star City, West Virginia

CTL Engineering, Inc. maintains a full service, in-house survey and mapping team which has extensive experience in performing most common surveying needs and some not so common.

CTL has the professional staff and the latest equipment to support three (4) full survey crews, including 2 Global Positioning Systems (GPS) and robotics which gives us an added dimension to our surveying and mapping capabilities.

We have performed surveying and mapping on many of our civil site projects and have supplied construction stakeout and monitoring for many of our clients.

Professional Services:

- ◆ Property surveying and boundary determination
- ◆ Topographic mapping development
- ◆ Aerial mapping layout and control
- ◆ Global Positioning System (GPS)
- ◆ Construction Layout
- ◆ Settlement Plate Monitoring
- ◆ Micrometer Leveling
- ◆ Flood Plain Determination and Certification
- ◆ Wetland Delineations



Project Synopsis:

- ◆ Residential Subdivision Layout
- ◆ Commercial Development Layout
- ◆ Access Road and Parking Lot Layout
- ◆ Bridge Construction Layout and Monitoring
- ◆ Elevation Certificates (FEMA)
- ◆ Property Survey Projects
- ◆ Stormwater Surveillance Mapping
- ◆ Water body Sounding Studies



CTL Engineering has experienced engineers, geologists and mining technicians to provide the expertise to insure successful mining operations. We provide abandoned mine land reclamation design and project management, mine subsidence evaluations and remediation plans, hydraulic and hydrology studies, hydrogeologic evaluations, mine permitting, and coal reserve studies.

The CTL Mining Engineering Group coordinates with our drilling services and various testing departments to provide a full scope of services to the mining industry. Our laboratories are certified to perform the water and overburden analysis prescribed by federal regulatory programs.

CTL Engineering provides drainage control structure design to comply with the regulatory requirements for controlling and treating site damage. Exploration equipment and remote video camera monitoring are used by CTL Engineering to prepare accurate maps for reclamation, subsidence stabilization measures and mine closures.

We have experienced mechanical and metallurgical engineers on staff to provide mine equipment evaluation and consultation services. CTL Engineering is a proven source for accurate and dependable technical information.

CTL Mining Services Include:

- ◆ Subsidence Investigations
- ◆ Abandoned Mine Reclamation Design
- ◆ Permit Preparation
- ◆ Mine Design Plan
- ◆ Refuse Disposal Facility
- ◆ Environmental Monitoring
- ◆ Coal, Water and Overburden Analysis
- ◆ Drainage Control Structure Design
- ◆ Failure Analysis
- ◆ Legal Testimony
- ◆ Acid Mine Drainage



Taylor Creek Impoundment, West Virginia
Reclamation of a 120-acre burning refuse pile and dewatering and abandonment of a 24-acre coal-related impoundment.

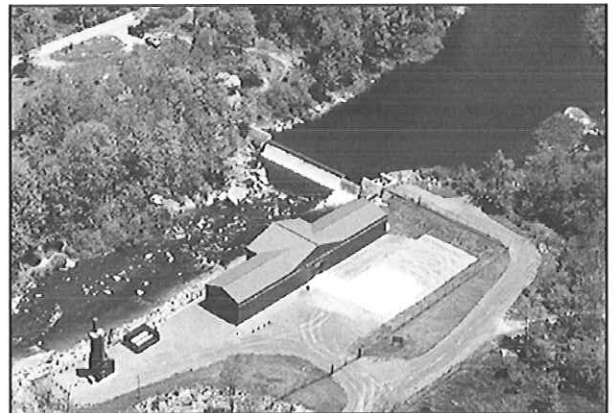

*Blackwater River, Water Improvement Project,
Davis, West Virginia*



Jamison Burning Refuse Reclamation Project



Geotechnical Engineering

The Geotechnical Engineering Department at CTL Engineering routinely performs subsurface investigations, and soil and rock testing. We prepare engineering reports, make recommendations regarding foundation and construction techniques, and perform other pertinent geotechnical services, as dictated by a given project.

Drilling Services

CTL Engineering owns and operates its own fleet of drill rigs, the largest of which has a capacity to drill and take samples up to 300 feet deep. Our rigs are equipped with large diameter soil and rock core samplers, *in-situ* pressure meters and cone penetrometers. These rotary drilling rigs conduct standard split spoon sampling. Our drill rigs have pumps, wireline and standard coring equipment for proper and efficient execution of subsurface investigations. We can perform pressure meter tests and vane shear tests in the field, in addition to conducting and/or monitoring of well pumps tests.

Analytical Laboratory

Our Soils Laboratory has consolidometers, triaxial and direct shear apparatus, state-of-the-art permeability devices and normal soils classification equipment.

CTL Engineering provides a detailed analysis of the surface and subsurface composition and chemistry of the soils at the proposed site. For existing structures, we provide a foundation analysis. We also provide services for foundations under construction.



CTL owns and operates a fleet of ten (10) drill rigs

Service Listing

- ◆ Complete Subsurface Exploration Study
- ◆ Foundation Analysis
- ◆ Pile, Pier and Caisson Analysis & Inspection
- ◆ Embankment & Earth Dam Analysis
- ◆ Slope Stability Analysis
- ◆ Settlement Analysis
- ◆ Pavement Design
- ◆ Rock & Mineral Testing
- ◆ Hydrogeologic Studies
- ◆ Field and Laboratory Testing of Soils
- ◆ Legal Testimony



Soils engineers conduct soils tests in CTL's analytical laboratory

www.ctleng.com

CTL Engineering's Environmental Department staff has a combined total of 98 years of experience in managing various types of environmental projects. Our personnel are familiar with regulatory requirements and have established good working relationships with state and local agencies; such as the Ohio EPA, the State Fire Marshal's office, local fire and health departments, etc. Our personnel has conducted thousands of background researches and file reviews at numerous state agencies, including ODNR, OHPO, BUSTR, Ohio EPA, county courthouses and local fire and health departments.

CTL Engineering closely follows the ASTM Standard of Practice 1527-00 as well as any additional requirements placed by the client, such as wetlands assessment, delineation, permitting and mitigation; asbestos survey, sampling, evaluation and abatement monitoring; and similar non-ASTM scope considerations.

CTL Engineering maintains an in-house analytical laboratory as well as experienced geologists, hydrogeologists, and environmental scientists to conduct the background review and site reconnaissance to develop a list of constituents of concern. Our environmental staff has designed, constructed, installed, and operated various types of innovative remedial technologies, such as *in-situ* and *ex-situ* bioremediation, soil vapor extraction, groundwater extraction, free-product recovery, and bioslurping.

The following is a listing of services CTL Engineering provides:

Environmental Management

Compliance Strategies

- ◆ NPDES
- ◆ RCRA
- ◆ TSCA
- ◆ Solid Hazardous Waste
- ◆ Regulatory Analysis

Management Systems Analysis

Wetland Systems

- ◆ Wetlands & "Jurisdictional Waters of the State Delineation"
- ◆ Wetland Permitting & Mitigation

Landfill

- ◆ Site Characterizations
- ◆ Explosive Gas Monitoring
- ◆ Liner and Cover Design
- ◆ Leachate Sampling & Testing

Pilot Testing Services

- ◆ Soil Vapor Extraction
- ◆ Groundwater Sparging
- ◆ Aquifer Testing
- ◆ Slug Testing
- ◆ Soil Gas Surveys

Analytical Chemistry

- ◆ GC/MS, AA and IR
- ◆ Solid and Hazardous Waste Characterization
- ◆ Metals and Organics
- ◆ BTEX, TPH and PNA
- ◆ TCLP
- ◆ Liquid and Solid Fuels
- ◆ PCB Analysis

UST Services

- ◆ Removal & Closure Assessments
- ◆ Contaminant Migration Assessments
- ◆ Remedial Corrective Actions

Hydrogeologic Investigations

- ◆ Hollow Stem Auger Drilling
- ◆ Soil and Rock Sampling
- ◆ Monitoring Well Installation
- ◆ Wellhead Protection Planning
- ◆ Water Resources Assessment

Environmental Permitting

- ◆ NPDES Permitting Support
- ◆ Wastewater Treatment
- ◆ Part B Permit Application Preparation
- ◆ Solid-Waste Landfill Permitting
- ◆ Construction Demolition and Debris Landfill Licensing
- ◆ Permit to Install (PTI)
- ◆ Permit to Operate (PTO)

Property Assessments

- ◆ Phase I Environmental Assessments
- ◆ Phase II Environmental Assessments
- ◆ Asbestos Hazard Evaluation
- ◆ Asbestos Abatement Monitoring

Environmental Restoration

Design, Procure, Install and Operation

- ◆ Soil Vapor Extraction Systems
- ◆ Bio Venting
- ◆ Landfarm
- ◆ Beneficial Reuse Projects
- ◆ Free Product Recovery
- ◆ Activated Carbon Filtration
- ◆ Air Stripping
- ◆ Groundwater Sparging
- ◆ Bioremediation



UST Site Assessment, Riverview Local School

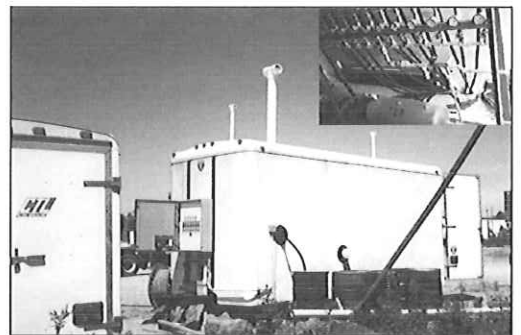

In Ohio, CTL was the first to employ a patented gaseous nutrient injection technology, PHOSTER™, to remediate soil/groundwater contaminated with gasoline and diesel in accordance with BUSTR action levels.

CTL Engineering is a leader in providing analytical services to the construction industry. We maintain a staff of experienced personnel and accurate equipment to guarantee dependable results. We evaluate all types of construction materials. Additionally, CTL can prepare and test Portland cement and bituminous concrete mixes for optimization studies to insure the proper mix design for specific jobs.

We provide complete testing of the following:

Aggregates

- Component Analysis (sand, gravel, limestone)–Department of Transportation
- Filter Sand – Environmental Protection Agency (EPA)
- Railroad Ballast – American Railroad Engineering Association
- Rip-Rap – U.S. Soil Conservation Service

Soils

- Classification
- Compaction Parameters
- Permeability Tests

Concrete

- Mix Designs
- Mix Verification Tests to verify strength, air content, consistency and yield of concrete
- Compression Tests
- Flexural and Split Tensile Strength Tests
- Modulus of Elasticity
- Creep Testing



CTL Engineering offers petrographic examination of construction materials. These specialized microscopic evaluations allow us to closely evaluate concrete quality and determine the causes and extent of failures in concrete in addition to potential future performance.

In addition to the standard ASTM tests of strength, absorption, dimensions unit weights, etc. CTL Engineering provides several specialty tests on concrete block and brick including the fire rating test specified by the BOCA and efflorescence testing required by many architectural firms.

Asphalts

- Mix Designs
- Nuclear Gauge Calibrations Extraction and Grading
- Core Testing for Density and Strength.

You can be assured of complete quality testing for all your construction mixes.

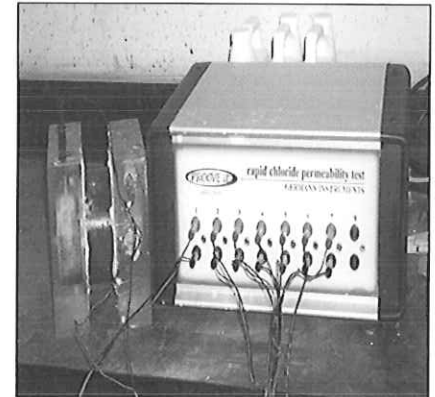

Rapid Chloride Permeameter

Clay-brick, Pipe & Tile

CTL Engineering provides complete and thorough analysis of clay products. Some of the more common tests include:

- Compressive Strength
- Absorption
- Freeze-thaw
- Efflorescence
- Dimensional Analysis
- Acid resistance.

In addition to the standard tests that are required by specification, we perform specific tests on construction materials as dictated by the needs of the customer.

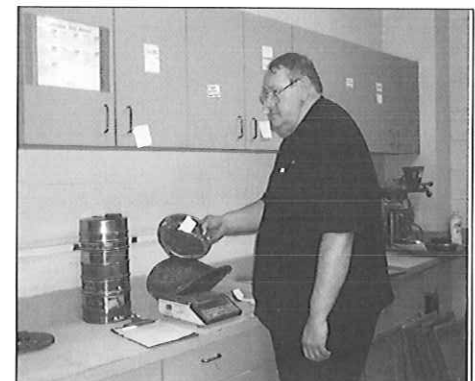

A project's construction phase requires quality control inspections and reliable testing. Building owners, architects, engineers and contractors choose CTL Engineering for field inspections because they know that we are accurate, dependable and perform our services in a timely manner. Our experienced engineers and inspectors are your partners in construction. We help provide a finished quality product.

CTL Engineering provides inspections of the following:

- ◆ **Earthwork including Embankment & Foundations**
- ◆ **Reinforced Concrete**
- ◆ **Floor Flatness**
- ◆ **Roofing Systems**
- ◆ **Structural Steel**
- ◆ **Masonry**
- ◆ **Sprayed-on Fire Proofing Installation**
- ◆ **Bituminous & Portland Cement Concrete Paving**
- ◆ **Single & Multi-Story Building Structures**
- ◆ **Pavement for Streets, Airports Runways, etc.**
- ◆ **Parking Garages & Bridges**
- ◆ **Water & Wastewater Treatment Facilities & Associated Piping Systems**



We perform quality control testing of the above materials and structures in addition to destructive and nondestructive testing of finished pavements and structures.

CTL Engineering examines existing structures to evaluate potential problems. Failed structures are analyzed to determine the cause and extent of damage. We evaluate structural integrity during initial construction and at regular intervals after completion. Our work includes steel reinforced concrete structures. CTL Engineering routinely evaluates metal and concrete pipes.

We perform audio/video surveys, sonic velocity testing, x-ray examinations, half-cell potential and other destructive and nondestructive tests.

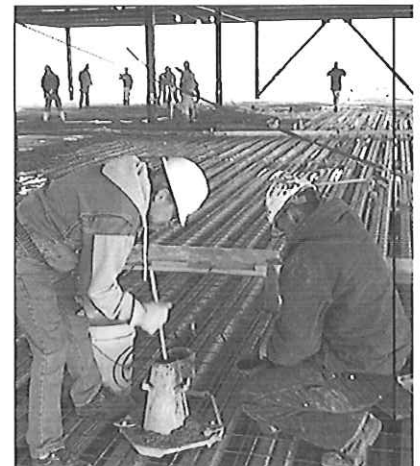

CTL Engineering's technicians maintain the following certifications:

- ACI (American Concrete Institute)
- NICET Certification
- Hazardous Material Certification
- Confined Space Entry Training
- Radiation Safety Training
- Soil Technicians

WEST VIRGINIA DEPARTMENT OF ENVIRONMENTAL PROTECTION

AML CONSULTANT CONFIDENTIAL QUALIFICATION QUESTIONNAIRE "Attachment B"

PROJECT NAME Pepper Portals & Drainage DEP16069		DATE (DAY, MONTH, YEAR) 11/01/2013	FEIN 55-063-1834
1. FIRM NAME CTL Engineering of West Virginia, Inc.		2. HOME OFFICE BUSINESS ADDRESS 2860 Fisher Road Columbus, OH 43204	3. FORMER FIRM NAME Columbus Testing Laboratories
4. HOME OFFICE TELEPHONE (614)276-8123	5. ESTABLISHED (YEAR) CTL-1927 CTL-WV 1983	6. TYPE OWNERSHIP Individual <u>Corporation</u> Partnership Joint-Venture	6a. WV REGISTERED DBE (Disadvantaged Business Enterprise) YES <u>NO</u>
6. PRIMARY AML DESIGN OFFICE: ADDRESS/ TELEPHONE/ PERSON IN CHARGE/ NO. AML DESIGN PERSONNEL EACH OFFICE 733 Fairmont Road, Morgantown, WV 26501/ 304-292-1135/ Patrick E. Gallagher, President / Morgantown - 16			
7. NAMES OF PRINCIPAL OFFICERS OR MEMBERS OF FIRM Patrick E. Gallagher, President CK Satyapriya, VP/Sec.		8a. NAME, TITLE, & TELEPHONE NUMBER - OTHER PRINCIPALS Ali Jamshidi, Treasurer (614) 276-8123	

9. PERSONNEL BY DISCIPLINE

<u>5</u> ADMINISTRATIVE	- ECOLOGISTS	- LANDSCAPE ARCHITECTS	<u>1</u> STRUCTURAL ENGINEERS
- ARCHITECTS	- ECONOMISTS	- MECHANICAL ENGINEERS	<u>6</u> SURVEYORS/RODMEN
<u>1</u> BIOLOGIST	- ELECTRICAL ENGINEERS	<u>1</u> MINING ENGINEERS	- TRAFFIC ENGINEERS
<u>3</u> CADD DESIGNERS	<u>4</u> ENVIRONMENTALISTS	- PHOTOGRAMMETRISTS	<u>X</u> OTHER,
- CHEMICAL ENGINEERS	- ESTIMATORS	- PLANNERS: URBAN/REGIONAL	<u>3</u> Geotechnical Drillers
<u>3</u> CIVIL ENGINEERS	<u>1</u> GEOLOGISTS/GEOTECH ENG.	<u>1</u> SANITARY ENGINEERS	<u>2</u> Driller Helpers
<u>9</u> CONSTRUCTION INSPECTORS	- HISTORIANS	<u>2</u> SOILS ENGINEERS	<u>2</u> Geotechnical Engineers
<u>2</u> DESIGNERS	<u>1</u> HYDROLOGISTS	- SPECIFICATION WRITERS	<u>4</u> Laboratory Technicians
<u>0</u> DRAFTSMEN			

TOTAL NUMBER OF WV REGISTERED PROFESSIONAL ENGINEERS IN PRIMARY OFFICE: 4 51 TOTAL PERSONNEL

*RPEs other than Civil and Mining must provide supporting documentation that qualifies them to supervise and perform this type of work.

The TOTAL PERSONNEL number is for CTL Engineering of West Virginia, Inc.

TOTAL PERSONNEL for CTL Engineering, Inc. is 180, which includes CTL Engineering of WV.

10. HAS THIS JOINT-VENTURE WORKED TOGETHER BEFORE? YES NO

12. A. Are your firm's personnel experienced in Abandoned Mine Lands Remediation/Mine Reclamation Engineering?

YES Description and Number of Projects: CTL Engineering has completed more than 800 AML related projects nationally and internationally. See attached "AML Past Project Experience" for some specific examples.

NO

B. Is your firm experienced in Soil Analysis?

YES Description and Number of Projects: Our in-house laboratories perform all ASTM mechanical, organic and in-organic analyses for soils. Our labs are certified by WVDOH, OEPA and US Corps of Engineers.

NO

C. Is your firm experienced in hydrology and hydraulics?

YES Description and Number of Projects: Each of our site design and AML projects require hydrology & hydraulic evaluations. We estimate that annually, we complete more than 100 projects requiring hydrology design.

NO

D. Does your firm produce its own Aerial Photography and Develop Contour Mapping?

YES Description and Number of Projects:

NO However, we annually complete more than 25 projects requiring aerial photography & mapping. While we sub-contract the aerial photography, in-house we provide GPS, surveying and develop the contouring as needed.

E. Is your firm experienced in domestic waterline design? (Include any experience your firm has in evaluation of aquifer degradation as a result of mining.)

YES Description and Number of Projects: We have completed numerous waterline design projects and our in-house staff has more than 50 years of combined experience with aquifer degradation.

NO

F. Is your firm experienced in Acid Mine Drainage Evaluation and Abatement Design?

YES Description and Number of Projects: CTL has developed more than 20 active and passive treatment systems for AMD. More than 50 of our AML Design projects required some form of AMD evaluation and design.

NO

13. PERSONAL HISTORY STATEMENT OF PRINCIPALS AND ASSOCIATES RESPONSIBLE FOR AML PROJECT DESIGN (Furnish complete data but keep to essentials)

NAME & TITLE (Last, First, Middle Int.)	YEARS OF EXPERIENCE		
	YEARS OF AML DESIGN EXPERIENCE:	YEARS OF AML RELATED DESIGN EXPERIENCE:	YEARS OF DOMESTIC WATERLINE DESIGN EXPERIENCE:
Gallagher, Patrick E., PE President, Project Manager	34	34	27

Brief Explanation of Responsibilities
 President of CTL Engineering of WV, Inc.; responsible for the overall administration of the Morgantown, WV office along with the management of the individual engineering projects. His administration and management responsibilities include marketing, proposal preparation, client contact, supervision of design personnel, scheduling, budget control, and report preparation. Projects successfully completed by Mr. Gallagher include: Geotechnical Investigations, Foundation Design Investigations, Dam Stability Analyses, Mine Subsidence Evaluations, Mineral Reserve Studies, Landslide Investigations, Mine Reclamation Designs, Failure Investigations, and Mining Permits.

EDUCATION (Degree, Year, Specialization)

B.S., 1975, Civil Engineering
 B.S., 1975, Equivalent, Geology

MEMBERSHIP IN PROFESSIONAL ORGANIZATIONS

American Society of Civil Engineers
 Society of Mining Engineers of A.I.M.E.
 Triangle Fraternity of Engineers, Architects and Scientists
 International Society of Soil Mechanics and Foundation Engineers
 American Institute of Professional Geologists

REGISTRATION (Type, Year, State)

Registered Professional Engineer; 1983-West Virginia, 1984-Ohio, 1983-Maryland, 1993-Pennsylvania, 2006-Wyoming, 2006-North Carolina
 Certified Professional Geological Scientist - 1984
 Professional Surveyor, 1995-West Virginia

13. PERSONAL HISTORY STATEMENT OF PRINCIPALS AND ASSOCIATES RESPONSIBLE FOR AML PROJECT DESIGN (Furnish complete data but keep to essentials)

NAME & TITLE (Last, First, Middle Int.)	YEARS OF EXPERIENCE		
	YEARS OF AML DESIGN EXPERIENCE:	YEARS OF AML RELATED DESIGN EXPERIENCE:	YEARS OF DOMESTIC WATERLINE DESIGN EXPERIENCE:
Selfridge, Carl G. Department Head, Geotechnical Services	3	3	

Brief Explanation of Responsibilities
 Department Head Geotechnical Engineering. Responsible for subsurface investigations, geotechnical reporting, foundation analysis & recommendations, program development for investigative and laboratory analysis.

EDUCATION (Degree, Year, Specialization)

Graduate Studies, 1996-1999, Civil Engineering (Geotechnical)
 B.S., 1996, Civil Engineering, Geotechnical and Structural
 A.S., 1994, Engineering Science
 A.A.S., 1991, Mechanical Technology - Design & Drafting

MEMBERSHIP IN PROFESSIONAL ORGANIZATIONS

Fellow of the American Society of Civil Engineers, The GEO-Institute, Timber Framers Guild, Construction Institute (ASCE)

REGISTRATION (Type, Year, State)

Engineering Intern (EI), 1996, New York
 Level II Drilling Inspector, 1999, PennDOT

13. PERSONAL HISTORY STATEMENT OF PRINCIPALS AND ASSOCIATES RESPONSIBLE FOR AML PROJECT DESIGN (Furnish complete data but keep to essentials)

NAME & TITLE (Last, First, Middle Int.) Darrah, Timothy A. Civil Site Dept. Mgr., Project Manager	YEARS OF EXPERIENCE		
	YEARS OF AML DESIGN EXPERIENCE: 20	YEARS OF AML RELATED DESIGN EXPERIENCE: 20	YEARS OF DOMESTIC WATERLINE DESIGN EXPERIENCE: 20
Brief Explanation of Responsibilities Mr. Darrah is presently responsible for Management and Design for various types of civil engineering projects including reclamation design, commercial and residential development projects. He is also responsible for scheduling, invoicing and client contacts for all surveying projects including topographic, property and construction layout. Mr. Darrah's duties include drafting, writing of property descriptions, hydrology calculations, quantity calculations and various other forms of surveying and civil engineering related duties. He is also proficient in computer software including AutoCAD, Civilsoft, HEC-1, HEC-RAS and various other engineering software.			
EDUCATION (Degree, Year, Specialization) B.S., 1988, Civil Engineering Technology			
MEMBERSHIP IN PROFESSIONAL ORGANIZATIONS		REGISTRATION (Type, Year, State)	

13. PERSONAL HISTORY STATEMENT OF PRINCIPALS AND ASSOCIATES RESPONSIBLE FOR AML PROJECT DESIGN (Furnish complete data but keep to essentials)

NAME & TITLE (Last, First, Middle Int.) Moore, David P.E. Project Manager/Project Engineer	YEARS OF EXPERIENCE		
	YEARS OF AML DESIGN EXPERIENCE: 1	YEARS OF AML RELATED DESIGN EXPERIENCE: 1	YEARS OF DOMESTIC WATERLINE DESIGN EXPERIENCE: 25
Brief Explanation of Responsibilities Thirty years experience in design and construction. He has designed and constructed numerous dams, ponds, irrigation lakes, stormwater management ponds, sediment and erosion control ponds. He has designed ponds and lakes for residential, commercial, and industrial projects as well as self courses combining water features, irrigation, stormwater management and water quality unto aesthetically pleasing amenities.			
EDUCATION (Degree, Year, Specialization) M.S, 1983, Civil Engineering Civil Design B.S., 1978, Civil Engineering			
MEMBERSHIP IN PROFESSIONAL ORGANIZATIONS ASCE, AIA, Home Builders Assoc., SAME		REGISTRATION (Type, Year, State) Registered Professional Engineer: 1986, MD; 2008, NV; 2006, WY; 1984, CO; 2008, Alberta CAN; 2009, WV; 2010, OH; 2010, KY	

13. PERSONAL HISTORY STATEMENT OF PRINCIPALS AND ASSOCIATES RESPONSIBLE FOR AML PROJECT DESIGN (Furnish complete data but keep to essentials)			
NAME & TITLE (Last, First, Middle Int.) Stanley, Joseph Project/ Staff Engineer	YEARS OF EXPERIENCE		
	YEARS OF AML DESIGN EXPERIENCE: 6	YEARS OF AML RELATED DESIGN EXPERIENCE: 6	YEARS OF DOMESTIC WATERLINE DESIGN EXPERIENCE: 2
Brief Explanation of Responsibilities			
Mr. Stanley is responsible for Reclamation Design, Drafting Hydrology, Quantity Calculations, Stability Analysis, Residential Development, Valley Fill Footprinting, Surveying, Subsidence Surveys, Pre-Blast Surveys, Acid Base Accounts, Groundwater Inventory. PC Software includes Hydrologic TR-20, TR-55, Excel, Harstad Methods, Word, AutoCADD Land, Quarttro, Access.			
EDUCATION (Degree, Year, Specialization)			
A.S., 2001 Civil -Engineering Technology Drafting & Design			
MEMBERSHIP IN PROFESSIONAL ORGANIZATIONS		REGISTRATION (Type, Year, State)	

13. PERSONAL HISTORY STATEMENT OF PRINCIPALS AND ASSOCIATES RESPONSIBLE FOR AML PROJECT DESIGN (Furnish complete data but keep to essentials)			
NAME & TITLE (Last, First, Middle Int.) Foreman, Gregory P.E.	YEARS OF EXPERIENCE		
	YEARS OF AML DESIGN EXPERIENCE: 3	YEARS OF AML RELATED DESIGN EXPERIENCE: 17	YEARS OF DOMESTIC WATERLINE DESIGN EXPERIENCE: 17
Brief Explanation of Responsibilities			
Mr. Foreman serves as Project Manager and Design Engineer for various civil site design projects including reclamation, water supply, sanitary design for public and private projects. Design services provided include site grading, potable water, sanitary sewer, storm sewer, pedestrian walkways, vehicular thoroughfares, preparation of permits, project specifications, plans and engineering calculations.			
EDUCATION (Degree, Year, Specialization)			
A.S, Fairmont State, 1989, Drafting & Design A.S., Fairmont State, 1989, Mechanical B.S., Fairmont, 1989, Civil Engineering Technology			
MEMBERSHIP IN PROFESSIONAL ORGANIZATIONS		REGISTRATION (Type, Year, State)	
		Registered Professional Engineer, 1999, WV (no. 014165)	

13. PERSONAL HISTORY STATEMENT OF PRINCIPALS AND ASSOCIATES RESPONSIBLE FOR AML PROJECT DESIGN (Furnish complete data but keep to essentials)

NAME & TITLE (Last, First, Middle Int.)

Waltz, Charles P.E.

YEARS OF EXPERIENCE

YEARS OF AML DESIGN EXPERIENCE:

8

YEARS OF AML RELATED DESIGN EXPERIENCE:

12

YEARS OF DOMESTIC WATERLINE DESIGN EXPERIENCE:

0

Brief Explanation of Responsibilities

Project Engineer / Staff Engineer providing engineering services for a variety of projects including, site development, geotechnical subsurface investigations and foundation recommendations and road construction.

EDUCATION (Degree, Year, Specialization)

B.A., Fairmont State, Business Administration

B.S., Fairmont State, Civil Engineering

Graduate Studies, West Virginia University, Geotechnical Engineering

MEMBERSHIP IN PROFESSIONAL ORGANIZATIONS

REGISTRATION (Type, Year, State)

Registered Professional Engineer, WV (no.17626), VA (no. 37038)

14. PROVIDE A LIST OF SOFTWARE AND EQUIPMENT AVAILABLE IN THE PRIMARY OFFICE WHICH WILL BE USED TO COMPLETE AML DESIGN SERVICES.

OFFICE EQUIPMENT

3 HP Color Plotters
HP Color Scanner
Duplicating equipment, copiers, blueprinting, laser printers, etc.
Facsimile Machine

DESIGN SOFTWARE

Windows XP & 2000 based operating systems
Microsoft Office 2000 & 2002 is used for word processing, spreadsheet creation, data processing, and presentation creation. Alternative software including Corel Suite is available, if necessary Project designs and specifications are produced in our Computer Aided Drafting and Design (CADD) section using all versions of AutoCAD including Release 2013.

Hydrogeologic Studies

MODFLO
MODPATH
SURFER
CAPZONE
GWPATH
SKUGIS
PHREEQCI
WATEQ4F
Groundwater for Windows

Civil Engineering Software

Civil 3D 2013(AutoCADD) - 13 Seats
Profiling
Civilsoft
TR-20 & TR-55
SEDCAD
HEC 1 & 2
HEC-RAS
Arc GIS
ArcPAD
Carson Software

Geotechnical

GINT
STABL6
SHAFT
WSPRO
Various Bridge, Pavement, Pile and Foundation Software

SURVEY EQUIPMENT

- 2 - Trimble GPS Systems - 3-R8 Receivers & 1- R10 Receiver
- 6 Total Stations (1- Robotic)
- NAK Micrometer Level System & Direct Levels
- 4X4 Vehicles, including ATV for off-road use
- 2-Way Radios

SUBSURFACE INVESTIGATION EQUIPMENT

- 3 - CME 75 Drilling Rigs, 4-Wheel Drive Truck Mounted
- 2 - CME 75 HD Drilling Rigs, 2-Wheel Drive Truck Mounted
- 1 - CME 55 HD Drilling Rig, All-Terrain Mounted
- 1 - CME 45 Drill Rig, 2-Wheel Drive Truck Mounted
- 1 - CME 45 Drill Rig, 2-Wheel Drive Skid Mounted
- 1 Simco 4000 Track Rig
- 4-Wheel Drive Support Vehicles
- Portable barges for water borne drilling (including supply boats w/outboard motors)
- In-situ permeability apparatus
- Single or double ring field infiltrometers for hydraulic conductivity testing
- Down hole temperature gauges
- Color Borehole Camera with 300 foot range
- Ground Penetrating Radar Undisturbed shelby tube sampling devices
- Standard penetration testing equipment (1", 2", 3" split spoons)
- Settlement probes
- Tripod portable drilling equipment for interior drilling with 7 feet of clearance
- CBR equipment
- Hand Augers
- Solid flight augers - 4" O.D.
- Hollow stem augers - 33", 43", 63" 83" I.D.
- Rotary drilling capability up to 12" O.D.
- Hydro Punch - In-situ groundwater monitoring
- Conventional and wireline coring capabilities - (1", 2", 3", & 4")
- Soil-gas survey equipment
- Pump testing equipment
- Decontamination Equipment - Steam cleaners, drums, generators, etc.
- Electronic Data Loggers
- Field Sampling equipment for soil, water and groundwater
- Nuclear Densometer - Soil Compaction
- PID, FID, CGI and various field monitoring equipment
- Groundwater and Soil Remediation Equipment
- Mobile activated carbon system
- Air and chemical stripping of soils and water

15. CURRENT ACTIVITIES ON WHICH YOUR FIRM IS THE DESIGNATED ENGINEER OF RECORD (AML Projects)

PROJECT NAME, TYPE AND LOCATION	NAME AND ADDRESS OF OWNER	NATURE OF YOUR FIRM'S RESPONSIBILITY	ESTIMATED CONSTRUCTION COST	PERCENT COMPLETE
Open Contract to provide engineering design services throughout the State of Ohio (2 year contract)	OH Department of Natural Resources AML Emergency Program 1855 Fountain Square Court, 2nd Floor Columbus, Ohio 43224	Reclamation Design, geotechnical drilling, mine subsidence, slope stability analysis and design, pressure grout stabilization design, risk assessment, acid mine drainage, burning refuse extinguishment and earthwork calculations	\$75,000 /year Fees	50%
Open Contract to provide engineering design services throughout the State of Maryland. (5 year contract)	MD Department of Environment-AMLD 160 S. Water St. Frostburg, MD 21532	Reclamation Design, geotechnical drilling, mine subsidence, slope stability analysis and design, pressure grout stabilization design, risk assessment, acid mine drainage, burning refuse extinguishment and earthwork calculations	\$500,000 Fees \$15,000,000+ Const.	40%
Anderson Highwalls, AML Project, Monongalia County, WV	WVDEP - AML 601 57 th Street SE Charleston, WV 25304	Draining mine portal remediation design, mine seals, drainage systems, grading design, specifications		Design - 35%
Douglas Avenue Landslide Repair Project, MD AMLD Project, Allegany County, MD	MD Department of Environment-AMLD 160 S. Water St. Frostburg, MD 21532	Landslide remediation including H-Pile design, drainage systems, grading design, construction specifications. Included geotechnical investigation & surveying.	\$1,200,000	Design 95%
TOTAL NUMBER OF PROJECTS: 4	TOTAL ESTIMATED CONSTRUCTION COSTS: +\$18,000,000			

17. COMPLETED WORK WITHIN LAST 5 YEARS ON WHICH YOUR FIRM WAS THE DESIGNATED ENGINEER OF RECORD (AML Projects)

PROJECT NAME, TYPE AND LOCATION	NAME AND ADDRESS OF OWNER	ESTIMATED CONSTRUCTION COST	YEAR	CONSTRUCTED (YES OR NO)
Peninsula Highwalls, AML Project, Monongalia County, WV	WVDEP- AML 601 57 th Street SE Charleston, WV 25304	\$244,000	2009	YES
St. Clair Portals, AML Project, Monongalia County, WV	WVDEP- AML 601 57 th Street SE Charleston, WV 25304	\$1,462,000	2009	YES
Shinn's Run Portals & AMD, AML Project, Harrison County, WV	WVDEP- AML 601 57 th Street SE Charleston, WV 25304	\$1,887,000	2012	YES
Pee Wee Hill Water Supply, MD AML Project, Garrett County, MD	MD Department of Environment 160 S. Water St. Frostburg, MD 21532	\$650,000	2011	YES
Terra Haute Airport, IN AMLD, Subsidence Grouting	Indiana Abandoned Mine Land Division Indianapolis, IN	\$6,500,000	2010	YES

18. COMPLETED WORK WITHIN LAST 5 YEARS ON WHICH YOUR FIRM HAS BEEN A SUB-CONSULTANT TO OTHER FIRMS (INDICATE PHASE OF WORK FOR WHICH YOUR FIRM WAS RESPONSIBLE) (AML Project)

PROJECT NAME, TYPE AND LOCATION	NAME AND ADDRESS OF OWNER	ESTIMATED CONSTRUCTION COST OF YOUR FIRM'S PORTION	YEAR	CONSTRUCTED (YES OR NO)	FIRM ASSOCIATED WITH
WV Blue Cross / Blue Shield Headquarters Parkersburg, WV	Civil Site Design, utilities, storm water, foundation, grading, coordination	Oxford Development Pittsburgh, PA	2008	\$8,000,000	\$100,000
Hazelton Prison #4, Hazelton, WV	Subsurface investigations and Geotechnical Drilling, Construction Observation	US Federal Bureau of Prisons	2012	\$12,000,000	\$300,000
Nelsonville, ODOT, Nelsonville, OH	Subsurface investigations and Geotechnical Drilling, Construction Observation	Ohio Department of Transportation, District 10 338 Muskingum Drive Marietta, OH 45750	2012	\$100,000,000	\$2,000,000

19. Use this space to provide any additional information or description of resources supporting your firm's qualifications to perform work for the West Virginia Abandoned Mine Lands Program. For the past 25 years, CTL has successfully designed more than 200 AML projects. We have worked nationally and internationally on a variety of AML problem sites. We have developed unique solutions that have been applied to site development, AMD Treatment, Mine Subsidence Abatement, Mine Fires and Highwall Elimination. Routinely, CTL is involved with highwall and refuse pile stabilization and extinguishment.

20. The foregoing is a statement of facts.

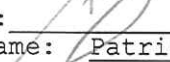
Signature: 
 Printed Name: Patrick E. Gallagher, P.E.

Title: President

Date: January 11, 2013

NOTE: THIS DOCUMENT WILL BECOME VOID AFTER DECEMBER 31 IN CALENDAR YEAR OF DATE HEREON.

CTL Engineering of West Virginia, Inc.

PROJECT ORGANIZATION CHART & KEY PERSONNEL

**Patrick Gallagher, P.E.,
CPGS, WV PS**
President, Project Executive

**Geotechnical
Engineering/Drilling
Services**

Carl Selfridge
Department Manager

**Charles Waltz, P.E.
Ruben Mick**
Project Engineers

Drillers / Driller Helpers

**Surveying/
Civil Site Design
Services**

Tim Darrah
Department Manager

**David Moore, P.E.
Gregory Foreman, P.E.
Joseph Stanley**
Project Engineers

**Steve Hegedis
Bucky Nicholson**
Staff Engineers /
CAD Designers

J B Chambers
Survey Party Chief
4 Field Survey Crews

**Natural Stream
Engineering**

Tim Darrah
ROSGEN Level 1

**Construction Services
& Materials
Laboratory**

James Gowarty, Jr.
Department Manager

Charles Huff
Department Supervisor

**Field &
Lab Technicians**



Expertise:

Mr. Gallagher serves as President of CTL Engineering of West Virginia, Inc. Projects successfully completed under Mr. Gallagher's direction include: Civil Site Design, Foundation Design, Storm Water Management, Waste Water Design, Roadway design, Parking Lot Design, Geotechnical Investigations & Design, Site Stability Analyses, Mine Subsidence Evaluations, Failure Investigations and Environmental Investigations and Permitting.

Prior to joining CTL Engineering, Mr. Gallagher was the chief of the Abandoned Mine Reclamation Program for the State of Maryland, Department of Natural Resources, and Bureau of Mines. In addition, he was also responsible for overall engineering/geologic support to the Maryland Bureau of Mines Program.

Education:

B.S., Civil Engineering

Virginia Polytechnic Institute and State University, Blacksburg, Virginia, 1975

B.S., Geology

Virginia Polytechnic Institute and State University, Blacksburg, Virginia, 1975

Professional Registration / Certifications:

Registered Professional Engineer

Ohio, # 48459; Maryland, # 13256; West Virginia, # 9297; Pennsylvania, # PE-044930-R; Wyoming, # 11033; North Carolina, # 0 32503; Kentucky, # 24988

Certified Professional Geological Scientist, # 6575

Professional Surveyor, WV

Adjunct Professor – Civil Engineering – Fairmont State College 2001 – 2002

Career Experience:

CTL Engineering, Inc.- 29 years

Other – 6 years

Project Experience:

Mining Related

Abandoned Mine Lands and Reclamation Projects

Project manager overseeing the design of various abandoned mine lands and reclamation projects for the West Virginia Department of Environmental Protection. These projects include coal refuse pile stabilization, burning refuse extinguishment and stabilization, acid mine drainage abatement plans, storm water management plans, mine permits, slope stability analysis and hydraulic analysis.

American Bituminous Power Partners, LLP

Project manager for services involving permitting and environmental issues. Conducted on-going inspections and certifications of the impounding refuse facilities and all drainage/sediment control structures for all permitted facilities.

Ohio Valley Plaza, St. Clairsville, Ohio

Project manager for the engineering design services for the dynamic compactions of surface mine spoil for this project. This site was in need of major overhaul; no building could take place without the deep dynamic compaction activities, which made this site fit for construction, while reducing site development costs.

Newpointe Center, Clarksburg, West Virginia

Project Manager for geotechnical engineering, materials testing, and observation services and surveying services for this project. CTL is currently performing materials testing and observation for Phase II of this development.

Ohio Department of Natural Resources (ODNR)

Project manager overseeing mine subsidence investigations throughout the state of Ohio. These projects include hydrology/hydraulic evaluations, floodplain designs, wetland delineations, slope stability designs, surface and deep mine permitting, refuse pile analysis/certification, earthwork calculations, storm water management design, pressure grout abatement, and numerous emergency projects under the ODNR-AML Emergency Program.

Amigo Coal Refuse Facility, Amigo, West Virginia

Project Manager responsible for designing two 42 inch microtunnels beneath an existing and active railroad line. The twin 42 inch culverts were for the diversion of Amigo Creek beneath the railroad. The twin culvert system was approximately 750 lf in total length and required 2 weeks to complete.

Highway / Landslide / Slope Stability

PENNDOT, Open-End Contract, Pennsylvania

Project Manager/Engineer responsible for overseeing geotechnical investigations for 30 separate transportation projects.

Star City Bridge, Star City, WV

Project Manager/Engineer for geotechnical investigations, borings and road relocation during construction of the Star City Bridge.

WVDOH Open-End Contract

Project Manager/Engineer providing geotechnical support to 40 separate projects including new roads and landslides.

Allegheny Restorations, West Virginia

Provided geotechnical engineering, surveying services and shoring design, in coordination with the West Virginia Department of Transportation, for 3 covered bridge projects in West Virginia.

Foundations / Structure

WVU Wise Library

Project Manager/Engineer provided geotechnical oversight of investigations for the building foundation systems on the construction of a new six (6) story library, which included the design of an extensive tie-back/soldier pile wall system.

WVU Eye Institute

Project Manager/Engineer providing geotechnical oversight for the geotechnical investigations and foundation recommendations performed for this \$5 M dollar patient care facility.

Physicians Office Center, WVU Hospital

Project Engineer responsible for the oversight of the geotechnical drilling and site investigations for this project.

WVU Life Sciences Building

Project Manager/Engineer providing geotechnical oversight of the drilling and investigations and recommendations needed for the construction of the Life Sciences Building.

Civil Site Geotechnical Design

Suncrest Executive Plaza

Under Phase 1 of this five-story office complex project, CTL provided the following services: surveying, geotechnical and civil site design. The civil site design included sedimentation and erosion control plans and permits, storm water management design utilizing 1,600 feet of 48' GCMP for storage, grading plans, utility coordination and WV DOH entrance permits for turning lane access to the site. CTL also provided construction drawings for the project.

WVU Hospitals, Morgantown, WV

CTL provided geotechnical, surveying and civil site design support services in conjunction with WVDOH and WVU for a new access road and parking area design for surrounding hospital area.

Chaplin Hill Business Park, Morgantown, West Virginia

Responsible for site conceptual design, hydrology, stormwater management, grant preparation, supervision during bidding phase, construction management, and final grant approval.

Blanchette Rockefeller Neuroscience Building, WVUHospitals, Morgantown, WV

Project included Site Plan, Site Grading, Utility Coordination, Sedimentation & Erosion Control, Bid Documents & Pre-Bid Conference. Design required close tie to existing facilities and utilities. Coordination between WVU Hospitals and architect to meet site needs and limit day to day disruptions from construction and traffic.

Glenmark Center, Shopping Plaza, Morgantown, West Virginia

CTL provided geotechnical engineering, Phase 1 environmental assessment, civil site design, "site specific" storm water management, surveying, sanitary treatment facilities for this ten plus acre plaza.

E A Development, The District, Student Housing, Morgantown, WV

This is a 30 acre development including 20 apartment buildings, clubhouse. CTL provided geotechnical investigations, conceptual and final plans, road layout, bridge location, DOH permit and design for access, grading plans, retaining wall design, storm water systems and detention. CTL was responsible for permitting, including: Sediment & Erosion Control, DOH Highway Access, Stream Crossing Permit, Right of Access and License Agreement for temporary and permanent culverts and stream crossing, 100 year Flood Study for Monongalia County Development Permit, 401 Water Quality Certification and the Section 404 Permit.

Summersville Fresh Water Intake, Summersville, West Virginia

Responsible for site review and rock mechanics evaluation for North American drillers where approximately 500 lf of a 48 inch micro tunnel was constructed for the intake at the City of Summersville WV water treatment facility adjacent to Summersville Lake. The tunnel was installed through excessively hard, 25,000 psi, crystallized sandstone requiring specialized bits and techniques to overcome the difficult horizontal boring.

Construction Observation & Testing

Allegheny Power Systems (open-ended contract for transmission distribution and power station projects)

CTL performs construction testing and observation, material testing, structural steel and surveying for various projects under this contract.

Fayette Energy Facility, Masontown, PA

Project Manager responsible for overseeing the concrete, soils, aggregates, asphalt and bolted connections for the project site. CTL has provided specialty-testing including: soil resistivity testing, and Windsor Pin testing

Cheat Lake Waste Water Treatment Plant Expansion, Morgantown, WV

Project Manager responsible for providing oversight and recommendations for this project. The project included increasing the capacity from 250,000 gallons/day to 750,000 gallons/day.

Chaplin Hill Sewer and Water System Expansion, Morgantown, WV

Project Manager responsible for overseeing quality assurance for corrosion protection, utility trenching, line expansion and construction methods for this project.

Warrior Run Generation Plant, Cumberland, MD

Project manager for the construction observation and structural steel inspection services for this project.

Professional Affiliations:

American Society of Civil Engineers

Society of Mining Engineers, of A.I.M.E.

Triangle Fraternity of Engineers, Architects, and Scientists

International Society for Soil Mechanics and Foundation Engineers

American Institute of Professional Geologists

TIMOTHY A. DARRAH

*Civil Site and Survey
Department Manager*

Expertise:

Mr. Darrah is presently responsible for department management for civil site design and surveying projects including topographic, property and construction layout. Mr. Darrah also serves as project engineer on various types of civil engineering projects including residential and commercial developments, and reclamation design projects. Office work includes site designs, hydrology calculations, quantity calculations, and various other forms of engineering related duties.

Education:

B.S. Civil Engineering Technology
Fairmont State College, Fairmont, West Virginia, 1988

Certifications:

West Virginia Dept. of Highways Compaction Technician
West Virginia Department of Highways Concrete Technician

Career Experience:

CTL Engineering, Inc.: 20 years

Project Experience:

Reclamation

West Virginia Department of Environmental Protection, Division of Abandoned Mined Lands and Reclamation

Performed the survey and design manager on abandoned mined lands on numerous projects for this state agency including: Peninsula Highwalls, St. Clair Portals, Cheat Neck Landslide, Lost Creek Landslide, all within the past five years.

Civil Site Design

Adelphia Cable Company, Various Locales

Project manager responsible for WVDOH and Railroad Crossings permits.

West Virginia University Hospital, Morgantown, West Virginia

Project manager responsible for the design and permitting of a 500 foot turning lane in conjunction with the WVDOH.

Surveying

Lock & Dam Rehabilitation Project in Point Marion, Pennsylvania

Responsible for all Second Order, Class I Surveying for this \$45 million Corps of Engineers project.



TIMOTHY A. DARRAH

*Civil Site and Survey
Department Manager*

ODNR Reclamation and Emergency Programs

Survey control and layout for 5 ODNR Reclamation Projects and 5 ODNR Emergency Projects.

Harrison Power Station for a \$900 Million SO₂ Removal Project in Shinnston, WV

Survey crew chief responsible for construction stakeout and surveying.

Monongalia County Board of Education

Project surveyor responsible for various surveying services for new school development and additions to existing schools.

Guardian Food Corporation, Various Locales, WV, PA, OH

Project manager that provided ALTA surveys for 34 Hardees Restaurants throughout Ohio, Pennsylvania and West Virginia.

Ohio Department of Transportation

Survey chief responsible for construction stake out of nearly nine miles of proposed road for Route 250 from Cadiz, OH to New Athens, OH. Stake out preliminary centerline and proposed bore hole locations.

Green River Group, Hazelton, WV

Survey chief responsible for construction stake out for Hazelton Road in Preston County, WV. Staked out centerline and cuts and fills.

American Fiber Resources, Fairmont, WV

Survey chief responsible for construction stake out of paper recycling plant, including columns, buildings, wall lines, column plumbness, roads, clarifiers, etc.

Cell Towers, Various Locales

Responsible for surveying lease areas, topographic mapping, road layout and developing plats and descriptions for proposed cell tower sites.

Aerial Photography, Various Locales

Project manager in charge of establishing GPS control for the aerial mapping of numerous projects throughout West Virginia.

Site Development / Residential & Commercial

Chaplin Hill Business Park, Morgantown, West Virginia

Project Manager responsible for conceptual layout and initial site design for the Monongalia County Economic Development Authority.

EA Morgantown, LLC, Morgantown, West Virginia

Project manager responsible for the civil site design of a 900 bedroom student housing complex. Submitted permits to the WVDOH for a turning lane and entrances. Prepared sediment and erosion permits for the WVDEP. Also, prepared stream crossing permits and performed a 100 year Flood Study.



TIMOTHY A. DARRAH

*Civil Site and Survey
Department Manager*

Glenmark Centre, Morgantown, West Virginia

Project manager responsible for civil site design and ALTA surveys at this facility for the following Glenmark businesses including: Lowes Home Improvement Warehouse, Outback Steakhouse, Wendy's, Bob Evans, Holiday Inn Express, and Ruby Tuesday's.

Sterling Ridge Student Apartments, Morgantown, West Virginia

Project Manager for the civil site design for this student-housing complex. CTL also provided surveying design and inspection services.

Suncrest Executive Plaza, Morgantown, West Virginia

Project manager responsible for the civil site design of this project. Duties included the preparation of storm water detention plans, grading, pavement, turning lane and permits for the WVDOH, and sediment and erosion permits.

Water / Waste Water

WVDEP Water Feasibility Investigations:

Project Manager for numerous water feasibility studies over his career at CTL including: Fairview, Tioga / Craigsville, Douglas and Horner's Run in the past five years.

EXPERTISE:

Annually manages 100+ various geotechnical projects; including transportation, commercial development, public schools, and a variety of public and private clients. Directs all aspects of the geotechnical engineering for CTL WV. This includes the management of field drilling activities, field classification of soil, rock, field and laboratory safety procedures, the assignment of a laboratory testing program, and performing geotechnical evaluations. Engineering evaluations include foundation recommendations, settlement analysis, slope stability analysis, earth pressure coefficients and report preparation.

EDUCATION:

A.A.S., Mechanical Technology - Design & Drafting, 1991
Adirondack Community College; Queensbury, NY

A.S., Engineering Science, 1994
Adirondack Community College; Queensbury, NY

B.S., Civil Engineering (Geotechnical & Structural), 1996
Rensselaer Polytechnic Institute; Troy, NY

Graduate Studies, Civil Engineering (Geotechnical), 1996-1999
Rensselaer Polytechnic Institute; Troy, NY

REGISTRATIONS / CERTIFICATIONS:

Engineer Intern (EI): New York, 1996
Pennsylvania Dept of Transportation Level II Drilling Inspector, 1999
ARC Adult CPR Trained, Expires: 08/30/2006
ARC First Aid Trained, Expires: 08/30/2008
CSX Transportation Contractor Safety Trained, Expired: 2004
Mine Safety Trained (Construction), Expired: 2003
AMTRAK Contractor Safety Trained, Expired: 2001

CAREER EXPERIENCE:

CTL Experience – 3 years
Other Engineering – 8 years

Project Experience:

US Route 35 Little Fivemile Creek to Coast Guard Station, Mason County, WV, R. D. Zande / West Virginia Department of Transportation, Division of Highways. Geotechnical Engineer responsible for the site reconnaissance, core boring program bid documents, geotechnical site investigation program, laboratory testing program.

Dolls Run Bridge Replacement, Monongalia County, WV, West Virginia Department of Transportation, Division of Highways. Geotechnical Engineer responsible for the site reconnaissance, geotechnical site investigation program, core boring bid documents, laboratory testing program, geotechnical analysis and prepared recommendations, prepared Geotechnical Engineering Report.

CARL G. SELFRIDGE

Geotechnical Engineer

King's Covered Bridge Rehabilitation, Somerset County, PA, Simone Jaffe Collins (SJC) / Pennsylvania Department of Transportation, District 9-0. Engineer responsible for the inspection and documentation of the current conditions and details of historic wood timber covered bridge.

WV 705 Connector Alternative Study, Monongalia County, WV, West Virginia Department of Transportation, Division of Highways. Geotechnical Engineer responsible for performing site reconnaissance of the project area and evaluated the existing site conditions as they may pertain to the design of different proposed alternatives.

King Coal Highway (US Route 52) with WV Route 65 Relocation, Mingo County, WV, Nicewonder Contracting, Inc. / West Virginia Department of Transportation, Division of Highways. Geotechnical Engineer responsible for geologic reconnaissance, geotechnical site investigation program, site mining issues, cut slope analysis and design, very large embankment fills analysis and design, and other geotechnical design and analysis.

S.R. 0040, Section 06M, Youghiogeny Bridge Replacement over the Youghiogeny Reservoir, Fayette and Somerset Counties, PA, WAGMAN, Inc. / Pennsylvania Department of Transportation, District 12-0. Geotechnical Engineer responsible for conducting on-site geotechnical investigation and analyses of subsurface information for a proposed alternate replacement bridge structure over the Youghiogeny Reservoir.

S.R. 885, Section A03, Boulevard of the Allies Bridge Replacement over Forbes Avenue, Pittsburgh, PA, Pennsylvania Department of Transportation, District 11-0. Geotechnical Engineer responsible for conducting on-site geotechnical investigation and performed analyses of the subsurface investigation information for use in the design and analysis of two replacement bridge structures, new roadways and six retaining walls.

Osage Mine Complex Reclamation, Monongalia County, WV, West Virginia Department of Environmental Protection. Geotechnical Engineer responsible for assisting with preliminary field and office site reconnaissance for the preparation of construction plans and specifications for the reclamation of five abandoned mining sites under the Abandoned Mine Lands and Reclamation Program.

Lick Run Bridge (LC09), and Scotia Hollow Bridge (XC01), Allegheny County, PA, County of Allegheny. Geotechnical Engineer responsible for assisting with the preparation of the Problem Statement and Draft Exploration Plan for preliminary and final design activities for the rehabilitation or replacement of the two bridges in the Allegheny County Bridge Design Group B.

Martins Ferry Water System Improvement Project, Belmont County, OH, City of Martins Ferry. Geotechnical Engineer responsible for the geotechnical site investigation, subsurface investigation program, mine subsidence investigation, cut-and-fill slope stability review and analysis, embankment settlement analysis, and geotechnical design and analysis

Thompson Run Road Bridge No. 2, Allegheny County, PA, Allegheny County. Geotechnical Engineer responsible for conducting the inspection of the subsurface investigation program.

S.R. 0028, Galleria Mall Interchange, Allegheny County, PA, Mills Corporation. Geotechnical Engineer responsible for conducting on-site inspection and analyses of a subsurface investigation for a new interchange on S.R. 0028.

Ambridge-Aliquippa Bridge Replacement, Beaver County, PA, Pennsylvania Department of Transportation, District 11-0. Geotechnical Engineer responsible for performing site reconnaissance and



assessments of five alternative locations for a proposed new bridge to replace the existing Ambridge-Aliquippa Bridge that connects State Routes 65 and 51 over the Ohio River.

Midway Sewerage Treatment Plant, Washington County, PA, Midway Sewerage Authority. Geotechnical Engineer responsible for drilling inspection, subsurface analyses, and foundation analyses for the design and construction of a proposed sewerage treatment plant at an alternate site.

King Coal Highway, Mingo County, WV, West Virginia Department of Transportation, Division of Highways. Geotechnical Engineer responsible for geotechnical site investigation, boring layout, drilling program, mine subsidence investigation, cut-and-fill slope stability review and analysis, embankment settlement analysis, and geotechnical design and analysis.

Sharon Heights Connector, Mingo County, WV, West Virginia Department of Transportation, Division of Highways. Geotechnical Engineer responsible for geotechnical site investigation, boring layout, drilling program, mine subsidence investigation, slope stability.

Southern Beltway, Findlay Connector, PA Route 60 to U.S. Route 22, Allegheny and Washington Counties, PA, Pennsylvania Turnpike Commission. Geotechnical Engineer responsible for reviewing boring logs and profiles, along with the proposed designed alignment geotechnical cross sections, plan views, and profiles for correctness and completeness.

Stage II Light Rail Transit System, Pittsburgh, PA, Port Authority of Allegheny County. Geotechnical Quality Control Inspector on the Construction Management Team assisting in monitoring geotechnical field activities of tieback anchor installations and load testing in soldier pile and lagging walls.

Source Water Assessment and Protection (SWAP) Program, Beckley District, WV, West Virginia Department of Health & Human Resources, Bureau for Public Health. Engineer responsible for performing wellhead delineation and assisting in preparing reports for 44 public water systems.

S.R. 2040, Curry Hollow Road Realignment, Allegheny County, PA, Pennsylvania Department of Transportation, District 11-0. Geotechnical Engineer responsible for conducting on-site inspection and analyses of the subsurface investigation for the proposed widening and realignment of approximately one mile of a four-lane roadway, including the replacement of a deteriorated bridge.

S.R. 3016, Section B02, Green Garden Road Bridge Replacement and Green Garden Road Realignment, Beaver County, PA, Pennsylvania Department of Transportation, District 11-0. Geotechnical Engineer responsible for slope stability analyses of embankment fill slopes and retaining walls, and for a settlement analysis of embankment fill into wetlands, as part of a roadway alignment and bridge replacement project.

S.R. 3088, Section A01, Hookstown Grade Road Bridge, Allegheny County, PA, Pennsylvania Department of Transportation, District 11-0. Geotechnical Engineer assisting with the technical preparation of a final geotechnical engineering report (GER) of a ten-meter-long single-span adjacent box beam bridge to replace a deteriorated single-span bridge.

Structural Stabilization and Rehabilitation Grouting Program, United States Postal Service Eastpointe Facility, Clarksburg, WV, United States Postal Service (USPS)/Advanced Construction Techniques, Ltd. (ACT). Resident Quality Control Engineer responsible for inspecting and monitoring on-site construction activities for a single-story structure used as a mail transfer facility and post office.

Sinkhole Remediation, Bridgeport Wastewater Treatment Plant, Bridgeport, PA, Borough of Bridgeport. Geotechnical Engineer responsible for inspecting the drilling and installation of four new groundwater

monitoring wells, and for assisting with the investigation of the causes of sinkhole formation at a wastewater treatment plant.

S.R. 0202 Improvement Project, Section 404, Chester and Montgomery Counties, PA, Pennsylvania Department of Transportation, District 5-0. Geotechnical Engineer responsible for the analysis of bridge foundation piles for down-drag and alternative design options for bitumen coating. Also designed a cased-bentonite mix around the pile in the zone of negative skin friction.

PI 125, Orms Street Bridge, Providence, RI, Amtrak. Geotechnical Engineer responsible for the 90 percent design and analysis of a jet grouting underpinning specification for the temporary support of a stone masonry retaining wall while lowering the tracks along the face of the wall.

S.R. 0309, Section 100, Montgomery County, PA, Pennsylvania Department of Transportation, District 6-0. Geotechnical Engineer for the widening and realignment of five miles of a four-lane expressway.

S.R. 0222, Warren Street Bypass, Section 002, Berks County, PA, Pennsylvania Department of Transportation, District 5-0. Geotechnical Engineer responsible for conducting technical reviews and preparing comments for District 5-0 on geotechnical reports submitted by the design consultants.

PI 125, Crib Wall at Mineral Springs Avenue, Pawtucket, RI, Amtrak. Geotechnical Engineer responsible for assisting in the evaluation of alternatives for supporting a crib wall structure during the lowering of the tracks along its face.

PI 126, Track 4 Extension, Attleboro, MA, Amtrak. Geotechnical Engineer responsible for the evaluation and analysis of consolidation settlement of a peat layer in the evaluation of the peat to support the proposed new track.

Instrumentation Monitoring, Northern Solid Waste Management Center B 2 at Cherry Island, Wilmington, DE, Delaware Solid Waste Authority. Geotechnical Engineer assisting in the quarterly and monthly monitoring and maintenance of 300 geotechnical instruments at this landfill which is constructed on 70 feet of soft dredge spoils. Instrumentation includes settlement plates and the use of an inclinometer probe.

Longwood Gardens Service Road Underpass, Kennett Square, Chester County, PA, Longwood Gardens, Inc. Geotechnical Engineer responsible for performing site reconnaissance and the preparation of the reconnaissance soils and geological engineering report (RSGER) for a simple-span, prestressed concrete box beam bridge for S.R. 0926 over a proposed maintenance driveway.

S.R. 0202 Improvement Project, Section 400, Chester and Montgomery Counties, PA, Pennsylvania Department of Transportation (PennDOT), District 6-0. Geotechnical Engineer responsible for assisting with the evaluation and organization of hydrologic information used to evaluate stormwater runoff and its influence on groundwater infiltration at drainage structures and wetland areas.

Liberty Street, Clinton, CT, Amtrak. Geotechnical Engineer responsible for drilling inspection and stability analysis of an existing road bridge abutment for the Amtrak Northeast Corridor High-Speed Rail Improvement Project.

Buttonball Road, Old Lyme, CT, Amtrak. Geotechnical Engineer responsible for drilling inspection and stability analysis of an existing bridge abutment for the Amtrak Northeast Corridor High-Speed Rail Improvement Project.

CARL G. SELFRIDGE

Geotechnical Engineer

Lake Road, East Haven, CT, Amtrak. Geotechnical Engineer responsible for drilling inspection and stability analysis of the existing road bridge abutment for the Amtrak Northeast Corridor High-Speed Rail Improvement Project.

Ferry Street, New Haven, CT, Amtrak. Geotechnical Engineer responsible for drilling inspection and stability analysis of an existing road bridge abutment for the Amtrak Northeast Corridor High-Speed Rail Improvement Project.

I-95, East Haven, CT, Amtrak. Geotechnical Engineer responsible for the geotechnical exploration of a bridge pier for the Amtrak Northeast Corridor High-Speed Rail Improvement Project.

PROFESSIONAL AFFILIATIONS:

American Society of Civil Engineers
The GEO-Institute
Timber Framers Guild
Construction Institute (ASCE)

CHARLES T. WALTZ, P.E.

Geotechnical Project Manager

Expertise:

Mr. Waltz serves as a Project Manager in the Geotechnical Engineering Services Department of CTL Engineering of West Virginia, Inc.

A recent addition to CTL's staff, Mr. Waltz was with Triad Engineering where he was Staff Engineer/Project Engineer and provided engineering services to a variety of projects, including site development, geotechnical subsurface investigations, and road construction. The majority of these projects were performed in West Virginia where concerns for mine subsidence and slope stability were routinely investigated.

Education:

B.A., Business Administration
Fairmont State University
B.S., Engineering
Fairmont State University
Graduate Studies, Geotechnical Engineering
West Virginia University

Professional Registration / Certifications:

Registered Professional Engineer
West Virginia, # 17626; Virginia, # 37038

Project Experience:

Geotechnical Engineering / Intelos, USCellular, CellOne / North central West Virginia

Geotechnical investigations were performed for numerous guyed, freestanding, and monopole towers communication towers. These towers varied in height from 40 and 200 feet tall.

Geotechnical Engineering / Various Clients /

Geotechnical investigations were performed for numerous projects including from waste water treatment plants, church additions, and commercial developments. In addition, routinely performed slope stability analysis and provided remediation recommendations.

Geotechnical Engineering / Pyrite Remediation / North Marion High School / Marion County, WV

Extensive project involving identification and removal of pyritic material from the foundation bearing soils situated beneath existing buildings. The reaction of the pyritic material had contributed to foundation heave and damage to the structures at the facility. Pyrite is a natural occurring mineral, which may react in the presence of air and water resulting in swelling. The mineral is frequently concentrated around coal seams. It is also a reactant in the formation of acid mine drainage (AMD). After the pyritic material was removed, the excavated bearing surface was treated to inhibit future reaction and structural support reestablished to the buildings.

Feasibility Study / Morgantown Airport / Monongalia County, WV

A study on the viability of employing fly ash material from local coal fired power plants as fill material for the development of runway extensions was performed. Research included investigation of the characteristics of the material and the economic effect of current regulations regarding its use.

Geotechnical Engineering / West Virginia Division of Highways

Blackshere Bridge (Marion County)

Kyle Bridge (Tyler County)

Geotechnical investigation included test borings, laboratory tests, and analyses ascertain foundation depths for piers and abutments, as well as slope stability of the approaches and suitability of roadway realignment options.

Jarvisville Road Bridge (Harrison County)

This project was a joint venture between an International Coal Group (ICG) and the State of West Virginia. Supervised the various geotechnical, civil design, and hydrological studies performed to advance this project. Project involved roadway redesign, temporary road location, stream crossing, utility relocation, stormwater management, and stream restoration.

Lodgville Road (Harrison County)

Geotechnical investigation provided for primary consultant. Project involved upgrading and realignment of an existing rural road to accommodate increased traffic. Analytical services included numerous slope stability analyses of proposed side valley fills and design of a steepened slope embankment for the railroad overpass abutments.

I-68 Visitors Center (Preston County)

Geotechnical investigation provided for the primary consultant. Project involved development of a visitor's center near the I-68 West Virginia/Maryland state line. Design included a mechanically stabilized slopes (MES) for the return ramp, which was the first MES incorporated into a project by the West Virginia Division of Highways (WVDOH). In addition, assisted the WVDOH in the development of WVDOH standards for reinforced slope design.

Geotechnical Engineering / University Town Center (Mon-View) / Granville, WV

This is a commercial development initiated by Consolidation Coal Company to utilize abandoned mine property. The project involved a subsurface investigation, stabilization design, and grout injection of potential mine voids underlying several of the marketable parcels. In addition, developed sites were reevaluated with respect to the competency of fill placed by others to verify the sites were ready for construction. Additional tasks included the stabilization of a landslide, which had been precipitated by water discharging from abandoned mines.

Gregory L. Foreman, P.E.

Project Engineer

EXPERTISE:

Mr. Foreman serves as Project Manager and Design Engineer for a multitude of civil site design projects. Mr. Foreman's provides civil site design services for a multitude of clients, including municipal, commercial and private developers. Design services provided include site grading, potable water, sanitary sewer, storm sewer, pedestrian walkways, vehicular thoroughfares, preparation of permits, project specifications, plans and engineering calculations.

EDUCATION:

Bachelors of Civil Engineering Technology Fairmont State College, Fairmont, West Virginia, 1989
Associates of Science (Mechanical) Fairmont State College, Fairmont, West Virginia, 1989
Associates of Science (Drafting and Design) Fairmont State College, Fairmont, West Virginia, 1989

PROFESSIONAL REGISTRATION / CERTIFICATIONS:

Registered Professional Engineer: West Virginia, 1999, No. 014165.

CAREER EXPERIENCE:

CTL Experience – 5 years
Other Engineering – 17 years

RELEVANT PROJECT EXPERIENCE

Commercial / Industrial

WV Blue Cross / Blue Shield Parkersburg Headquarters – Parkersburg, WV - *Project Manager* – Site Development, Storm Water Management, Parking Lot, Utility, Permitting
Cumberland Concrete- Lavale, MD – *Project Engineer* – Storm Water Management Plan
NFI NDC Warehouse – Canton, OH – *Project Engineer* – Development & Parking Lot Pavement Design
WD Partners Red Lobster Restaurant – Morgantown, WV – *Project Engineer* – Site & Retaining Wall Design
Ray Dental Office – New Building Complex - Fairmont, WV - *Project Engineer* – grading plan, parking facilities and storm water management.

Energy Resources

Stone Energy Marcellus Shale Gas Development– Various, WV – *Project Engineer* – Impoundments and Pad Design
Atlas Energy Resources Marcellus Shale Gas Development– Various, WV – *Project Engineer* – Impoundments and Pad Design

Parks & Recreational

BOPARK Dorseys Knob – Morgantown, WV – *Project Engineer* – Access Road, Pavilion, Handicap Access

Residential Development

Johnson Miller Hill Development – Morgantown, WV – *Project Engineer* – Site Development – Storm Water Management, Entrance Permits
The Woods Mid-Rise – Martinsburg, WV – *Project Engineer* – Site Development, Utilities, Permitting
Charles Point – Bridgeport, WV – *Project Engineer* – Site Design, Pond Design and Certification
South Hills Farms Subdivision expansion – Bridgeport, WV - *Project Engineer* – lot layout and sanitary sewer
Timber Valley Development - Fairmont, WV - *Project Engineer* – layout of lots, streets, sewer and water lines.



Gregory L. Foreman, P.E.

Project Engineer

Crest View Acres Housing Development - Taylor County, WV - *Project Engineer* – utility locations and infrastructure development
Auburn Woods Housing Development

Sanitary Sewer and Water Systems

Idlewood Enterprises Townhome Development – *Project Manager* - Sanitary Sewer Design / Permitting
Adrian Enterprises Harvest Ridge Development – Morgantown, WV - *Project Manager* - Sanitary Sewer Design / Permitting
WHX Canterbury Woods Development - *Project Manager* - Sanitary Sewer Design / Permitting
MDE –MBOM Pee Wee Hill Water Supply - Kitzmiller, MD - *Project Engineer* – New Water Supply System Design
WVDEP – Fairview Water Supply Investigation – Fairview, WV - *Project Engineer*
WVDEP – Tioga / Craigs ville Water Supply Investigation – Tioga, WV - *Project Engineer*
MDE –MBOM Pee Wee Hill Water Supply Investigation- Kitzmiller, MD - *Project Engineer*
City of Fairmont - Sanitary Sewer Improvements - Fairmont, WV - *Project Engineer* - field investigation, design, specifications and permitting for replacement of an existing sewer line
City of Shinnston Waste Water Improvement Project - Shinnston, WV - *Project Engineer* - design and analysis of alternatives for residential lot layout and sanitary sewer service
Dominion Transmission - Oakford Compressor Station, Sanitary Sewer Extension Project, Delmont, PA- *Project Engineer*
City of Shinnston Water System Improvement Project - Shinnston, WV - *Project Engineer* - design, plans and specifications for upgrading an existing potable water system
Clarksburg Water Board – Waterline Replacement - Clarksburg, WV- *Project Engineer* - conducting field surveys and developing construction plans & specifications for replacement of waterlines
Clarksburg Waterline Extension for FBI Facility - Bridgeport, WV- *Project Engineer* - conducting field surveys, developing site plans, creating design plan & specifications for the construction of a water storage facility. Responsible for engineering inspection during construction.
Century Volga Public Service District - three waterline extension projects, Philippi, WV - *Project Engineer* – site condition survey, conducting research for right-of-way acquisitions, determining waterline sizes, calculating storage tank capacity, developing plans for the erection of water storage facilities
Wetzel County Public Service District – *Waterline Extension* - , Wetzel County, WV - *Project Engineer* – site condition survey, determining waterline sizes, calculating storage tank capacity, developing plans for the erection of water storage facilities
Gilmer County Public Service District - waterline extension - Gilmer County, WV - *Project Engineer* - site condition survey, plans for the erection of water storage facilities.
Adrian Public Service District - four waterline extension projects - Adrian, WV - *Project Engineer* – site condition survey, conducting research for right-of-way acquisitions, calculating fire protection feasibility, determining waterline sizes, calculating booster pump station sizes, calculating storage tank capacity, developing plans for the erection of water storage facilities and booster pump stations
Huffman Industrial Park - potable water facilities and sanitary sewer - Bridgeport, WV - *Project Engineer* – fire protection and strategic placement of fire hydrants, designing grade and flow direction, manhole

Transportation

Star City Streetscapes – Star City, WV - *Project Manager* – Street Improvement, Sidewalks, Pavement Design, Drainage Design Systems, Construction Plans / Specs/ Bids
Town of Fairview- Sidewalk Improvement - Fairview, WV - *Project Engineer* – design, construction plans and specs



Gregory L. Foreman, P.E.

Project Engineer

Utility

Allegheny Energy Supply Albright Station – Albright, WV – *Project Manager* – Site Construction Master Plan
Grant Town Water Tank - Grant Town, WV - *Project Engineer* – Paint Investigation & Specs for repainting tank

Other

WYK Quiet Dale UM Church – Quiet Dale, WV - *Project Manager* - Site Development Plan

PROFESSIONAL AFFILIATIONS:

American Society of Civil Engineers
The GEO-Institute
Timber Framers Guild
Construction Institute (ASCE)

Expertise:

Mr. Moore has thirty years experience in design and construction in the fields of planning, civil engineering, structural engineering, general contracting, expert testimony, land development, surveying, landscape architecture, project and business management.

Presently Mr. Moore manages the civil engineering department of the CTL Engineering South Charleston WV office. This office performs consulting engineering in the fields of civil engineering, environmental engineering, geotechnical engineering and testing.

Prior to his current position Mr. Moore founded Alliance Consulting Engineers and Surveyors a consulting engineering firm with offices in Arvada and Longmont Colorado. Mr. Moore managed and directed multiple projects and employees in the fields of planning, civil engineering, structural engineering, marketing, business administration, land development, surveying, landscape architecture, water resources, design build and construction management.

During Mr. Moore's tenure with Jehn Engineering and Kidde Consultants he performed professional engineering duties encompassing civil and structural design, expert testimony, surveying, marketing, water resources, public presentations, project management, quality assurance and quality control. These professional engineering duties were performed for a diverse array of private and public clients and encompassed a broad spectrum of duties.

While employed by Fluor-Daniel Mr. Moore was a civil construction engineer on large power plant projects throughout the United States. Mr. Moore performed design-build civil engineering services on hydroelectric and gas plants in Virginia, Texas and Wyoming. These projects were in the hundreds of millions to billions of dollars in magnitude and were designed and built by Fluor-Daniel encompassing design, procurement, construction and implementation.

Education:

B.S., Civil Engineering
West Virginia University Institute of Technology, Montgomery WV 1974-1978

M.S., Civil Engineering
Colorado University, Boulder CO 1981-1983

Professional Registration:

Registered Professional Engineer, Maryland, # 15100; Nevada, # 19250; West Virginia; Wyoming, # 11010; Colorado # 22495; Alberta Canada # 98121

Career Experience:

CTL Experience – 1 year
Other – 29 years



Project Experience:

Residential Subdivisions and Commercial Sites

Mr. Moore has performed design, project management and construction management of numerous residential subdivisions and commercial sites in Maryland and Colorado. Residential subdivisions included small one to two lot subdivisions up to subdivisions with 400-500 lots. Commercial project experience includes banks, restaurants, multi-story commercial buildings, hotels, malls and car sale and maintenance facilities. These projects include annexation, zoning, planning, platting, road design, utility design, grading, drainage, storm water management, landscaping, development agreements, cost estimates, and construction.

Golf Courses

Mr. Moore was project manager, engineering designer and construction administrator for the City of Arvada West Woods Ranch public golf course encompassing an initial 18 holes and the later addition of nine more holes. This project also encompassed over 400 acres of residential development, design and construction of 1.5 miles of four-lane boulevard, major bridge design to pass 3500 cfs Ralston Creek, two miles of trail design, wetland mitigation, irrigation design pedestrian bridge and golf cart bridge designs.

Water Resources and Drainage Projects

Mr. Moore designed and performed construction administration on water resources and drainage projects for developers, builders, and municipalities, ditch companies and water districts. Practically every project requires a drainage report and plan encompassing storm water management, flood studies, Letters of Map Revisions (LOMAR's or CLOMAR's) or storm drain design. Several notable projects include the Ralston Creek/Croke Canal overpass, Church Ditch flow limiter, Farmers Highline Canal realignment, and various flood studies on creeks and rivers.

Landscape Architecture

Mr. Moore performed design of landscape plans on many residential and commercial projects including a design/build regional park for the Town of Erie, Colorado encompassing an all purpose athletic field, baseball field with bleachers, backstops and dugouts. Additional design build projects include Candlelight Ridge Estates (125 lots) and Ryan Ranch Subdivision (130 lots).

Colorado Department of Transportation Road Design

State road design projects include 2 miles of US 60 road design in Johnstown, Colorado; Platte River Bridge/Culvert replacement in Littleton, CO; US 119 road improvements in Black Hawk and Longmont Colorado and State Highway 52 road re-design in Boulder County, Colorado.

Seniors Housing

Design of senior housing projects include the Golden Pond Seniors Housing encompassing a campus of senior apartments, assisted living and Alzheimer's facilities in Golden, CO; Arvada Estates senior housing an 118 unit senior housing project in Arvada, CO; Broomfield Retirement an 118 unit senior housing project in Broomfield, CO and Orchard Gardens an 85 unit Alzheimer's facility in Arvada, CO.

Land Development

Mr. Moore has assisted many developers through the land development process as a consultant, owner and partner. Project experience includes preparation of feasibility studies, project proforma's, preparation of loan packages, negotiation of development agreements and construction administration. Notable projects include Ryan Ranch Subdivision in Jefferson County, Colorado; Candlelight Ridge in Erie, Colorado; Ridgeview Estates in Adams County, Colorado, and Legend Ridge in Niwot, Colorado.

Structural Engineering

Mr. Moore has performed structural design, inspections, retaining wall designs, and box culvert designs, on residential, commercial and public projects. Larger projects include the Ralston Creek Bridge, trail and equestrian underpass for the City of Arvada, CO; Platte Canyon Road box culvert replacement for the State of Colorado and the Sheridan Community College dormitory buildings in Sheridan, Wyoming.

Utility Projects and Pump Stations

Preparation of utility reports and design and construction of water and sewer transmission lines, holding ponds, buildings and pump station facilities for raw water, potable water and sewer for developers, utility districts and municipalities. Projects include the regional sewer pump station for the Clear View project in Johnstown, CO; the raw water reservoirs and pump station for the City of Arvada Church Ditch takeout project in Arvada, CO.

Power Projects

Mr. Moore was project civil/construction engineer on the 1.3 billion dollar Bath County Pumped Storage project for Virginia Electric and Power Company (VEPCO) and in Bath County, Virginia. This project involved two earthen dams of which one was the tallest earth fill dam in the world at that time, design and construction of the powerhouse, tunnels and related appurtenances. Mr. Moore was a civil/construction engineer on the Chevron Carter Creek Gas Project in Evanston, Wyoming. This project was a 500 million dollar gas purification facility that was designed and constructed to purify natural gas. On both projects Mr. Moore was in the field performing design, direction of field personnel, inspections, quality control, material and equipment procurement, and related civil engineering duties.

Professional Affiliations:

American Society of Civil Engineers
American Institute of Architects
Home Builders Association
Society of American Military Engineers

Expertise

Mr. Stanley is a Staff Engineer/CAD Designer in the Morgantown, WV office. His responsibilities include assisting in the planning and design of civil site design projects involving land planning and development aspects. He is familiar with various engineering software programs including AutoCad 2013 and AutoCad Land Desktop 2012, which provide support for the planning and design projects.

Education

A.S., Drafting and Design
Fairmont State College; Fairmont, West Virginia, 2001

Professional Registrations/ Certifications

Advanced GPS Training Course

9 Years with CTL Engineering Inc.

Experience

A partial listing of Mr. Stanley's relevant project experience includes:

ODNR and ODNR Emergency Programs

Staff Engineer and GPS Survey Operator for 3 ODNR Reclamation Projects and 3 ODNR Emergency Projects

Chaplin Hill Business Park, Morgantown, West Virginia

Staff Engineer responsible for conceptual layout and initial site design for the Monongalia County Economic Development Authority.

WVU Hospitals, Morgantown, WV

Staff Engineer performing layout and design support services in conjunction with WVDOH and WVU for a new access road and parking area design for surrounding hospital area.

Wharf District Revitalization Project, Morgantown, WV

Cadd Designer assisting in the design of site plans and conceptual design for sidewalks and parking areas for the Wharf District revitalization project.

West Virginia University

CAD Designer for the layout, design and storm water management of various parking areas for West Virginia University.

Pierpont Heights, Morgantown, WV

CAD Designer responsible for the design on this up-scale townhouse community. Services also included an internal roadway design and parking scheme, upgrading of a lengthy access road, utility planning including the design and permitting of a sanitary collection system and a sewage treatment plant facility. Construction stakeout and monitoring were also provided.

JOSEPH STANLEY

Staff Engineer

GPS Surveying, Various Locales

GPS Surveyor responsible for establishing survey control for various aerial mapping and cellular tower projects.

EA Morgantown, LLC, Morgantown, West Virginia

CAD Designer responsible for drafting and assisting engineer for the civil site design of a 900 bedroom student housing complex. Submitted permits to the WVDOH for a turning lane and entrances. Prepared sediment and erosion permits for the WVDEP. Also, prepared stream crossing permits and performed a 100 year Flood Study.

Expertise:

As the Construction Services Manager for CTL Engineering of West Virginia Inc., Mr. Gowarty is responsible for supervising field and laboratory technicians. He is also responsible for report writing for field and laboratory testing, project management, client contact, estimating, proposals and invoicing for Construction Services Department. Mr. Gowarty's experience also includes surveying, pre-mining and pre-blast surveys, field supervision of drilling crews, Phase I Environmental Site Assessments and radiation safety officer and corporate safety officer. In addition, Mr. Gowarty is the Construction Materials Testing Supervisor, providing concrete, compaction, and aggregate testing and has over twenty (20) years of experience with Nuclear Gauge Operation.

Mr. Gowarty has been CTL's Corporate Safety Officer since Fall 2008.
Mr. Gowarty is CTL's USNRC Safety Officer.

Education:

B.S., Civil Engineering Technology, 1990
Fairmont State College; Fairmont, West Virginia

A.S., Mechanical Engineering Technology, 1990
Fairmont State College; Fairmont, West Virginia

Professional Registrations/ Certifications:

Safety

Radiation Safety Training, CPN Corporation
Radiation Safety Officer Training, Troxler Electronics
Principals of Fire Protection, Fairmont State University
Certified Forklift Trainer, Brickstreet Insurance
Drug Free Workplace Employee Trainer, Working Partners
Drug Free Workplace Supervisor Trainer, Working Partners

Other

West Virginia DOT Certified Compaction Technician
West Virginia DOT Certified Bituminous Concrete Technician
West Virginia DOT Certified Portland Cement Concrete Technician
West Virginia DOT Certified Aggregate Sampler
NICET Level III Asphalt & Concrete
NICET Level II Soils
Certified Dipfloor Profiler Operator, Face Company

Career Experience:

CTL Experience – 21 years

Project Experience:



Power Facilities

Hatfield Power Station, Masontown, PA
Albright Power Station, Albright, WV
Pleasants Power Station Landfill, Willow Island, WV
Blackoak Substation, Allegany County, WV
Fort Martin Power Station, Morgantown, WV
Linden Substation, Front Royal, VA
Malden Substation, California, PA
Graymont Substation, Pleasant Gap, PA
Grable Substation, Washington, PA
Meadowbrook Substation, Stephens City, VA
Maidstone Substation, Berkeley County, WV
Lamberton Substation, Ellenboro, WV
Lake Lynn Power Station, Lake Lynn, PA
Mitchell Substation, Monongahela, WV
Fayette Energy Facility, Masontown, PA
Warrior Run Company, Generation Plant, Cumberland, MD
Harrison Power Station, Haywood, WV
John Amos Power Plant, Nitro, WV
Grant Town Power Plant, Marion County, WV

Transportation

Monongahela Blvd, Morgantown, WV
Route 7, Morgantown, WV
Various Projects for WVDOT, WV
Colonial Drive Roadway Evaluation, Waynesburg, PA
I-79 Paving, Morgantown, WV
Clarksburg Streetscape, Clarksburg, WV
High Street Streetscape, Morgantown, WV
Mont Chateau Road Paving, Cheat Lake, WV
Route 50 Paving, Preston County, WV
Route 72 Paving, Preston County, WV
WVU Research Park Roadway, Morgantown, WV
Route 250 Gradations, Fairmont, WV
Hunter Lane Paving Project, Morgantown, WV
WVU Route 705, Morgantown, WV
Route 20 Utility Compaction, Pineville, WV
Osage Bridge S331-19-01.98, Morgantown, WV
WVDOT Bridge Replacement, Grant Town, WV
Mon Fayette Expressway, Cheat Lake, WV
Morgantown Airport, Morgantown, WV
Marshall County Airport, Moundsville, WV
Blue Sulphur Bridge, Ona, West Virginia

Education

South Jefferson High School, Charles Town, WV
Waynesburg College Eberly Hall, Waynesburg, PA
Waynesburg College Benedum Hall, Waynesburg, PA
Petrograph West Taylor Elementary School, Flemington, WV
Clay Battelle School, Blacksville, WV
WVU Wise Library, Morgantown, WV
WVU Life Sciences Building, Morgantown, WV
WVU Student Recreation Facility, Morgantown, WV
Suncrest Junior High School Construction Project, Morgantown, West Virginia

Healthcare

Monongalia General Hospital, Pavement Investigation, Morgantown, WV
WVU Hospitals, Pt. Marion Road, Morgantown, WV

Building Development

Kohl's Shopping Center, Pavement Coring, Clarksburg, WV
Super Wal-Mart, Fairmont, WV
Eastpointe Commercial Development, Harrison County, WV
Avery Church, Morgantown, WV
Fairmont Federal Credit Union, Bridgeport, WV
Rite Aid, Westover, WV
FedEx Ground Facility, Clarksburg, WV
Centra Bank, Westover, WV
Bridgeport Development, Bridgeport, WV
Little Caesars, Washington, PA
GA Brown Hi Tech Building, Fairmont, WV
Super Wal-Mart, Kingwood, WV
Japanese Steakhouse, Morgantown, WV
United Federal Credit Union, Mount Pleasant, PA
Kroger, Suncrest Town Center, Morgantown, WV
Hampshire County Judicial Center, Romney, WV
Evergreen Technology Park, Waynesburg, PA
Beckley Federal Courthouse, Beckley, WV
Glenmark Centre, Morgantown, WV
Newpointe Center, Clarksburg, WV

Water/Wastewater Treatment Plants and Water Tanks

Cheat Lake Wastewater Treatment Plant Expansion, Morgantown, WV
Chaplin Hill Sewer and Water System Expansion, Morgantown, WV
Olive Water Tank, Harrison County, WV
Pine Grove Waterline, New Martinsville, WV

REAM REFUSE PILE DEP15004

REFUSE PILE REMEDIATION & DRAINAGE

McDowell County, West Virginia



CTL Engineering Inc.

CTL Professional Services

- **Surveying**
- **Geotechnical**
- **Civil Site Design**
- **Construction Documents**

Project Background

Project includes two refuse piles, one about 25 acres, brick building, concrete foundations, retaining walls, and coke ovens. One pile needed to be stabilized to keep from eroding into the creek.

Project Scope

CTL Engineering of West Virginia, Inc. was retained to provide the following design:

- Design grading plan for all refuse areas.
- Design drainage control channels, ditches and underdrains to carry water safely off site
- Provide plan to demolish and dispose of hazardous equipment and facilities.
- Provide plan for reclamation and revegetation of all disturbed areas

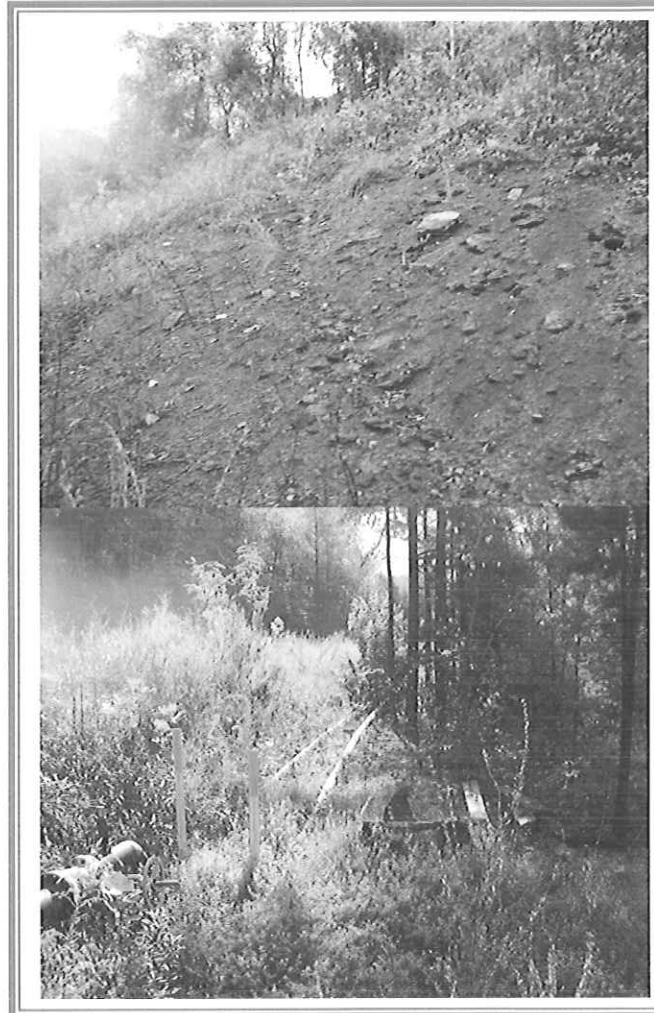

Client / Contact

**WV DEP-AML&R
601 57th Street
Charleston, WV 25304**

Design Completion Date

On-Going 2011

Estimated Construction Cost

\$400,000

PEE WEE HILL WATER SUPPLY WATER SYSTEM DESIGN AML PROGRAM



CTL Engineering Inc.

Kitzmilller, Garrett County, Maryland

CTL Professional Services

- **Cause & Need Evaluation**
- **Surveying**
- **Geotechnical**
- **Civil Site Design**
- **Construction Documents**

Project Background

The site consisted of 23 residences that had impaired water supply from existing wells and springs. The impairment was both quantity and quality based. Deep mines from early 1900s to the 1950s in multiple seams underlaid the entire project area. Several of the residences had lost well supply totally and many others had seasonal reductions in available water. Most of the residences displayed adverse water quality.

Project Scope

CTL Engineering of West Virginia, Inc. was retained to provide the following evaluation and design:

- Investigation of project area to determine if water supply had been effected by abandoned deep mines including well surge testing.
- Design full water supply and distribution system to 23 residences.
- Design included 5,900 LF of mainline supply, 7,100 LF of distribution lines with fire protection, 23 tap-in lines, 105,000 gallon supply tank, 60gpm booster pump station from existing system to new supply tank.
- Construction E&S control plans
- Construction drawings and specifications
- As-Built Drawings

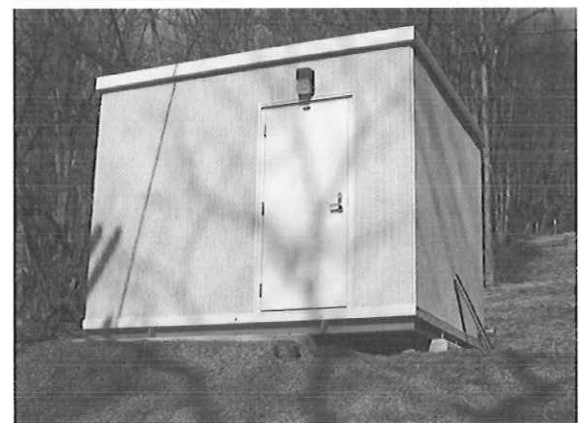

Client / Contact

**MDE-Land Management
AML Division
160 South Water Street
Frostburg, MD 21532**

Design Completion Date

May 2011

Estimated Project Cost

\$1,500,000

TERRA HAUTE REGIONAL AIRPORT

SUBSURFACE MINE

INVESTIGATION & STABILIZATION



CTL Engineering Inc.

Terra Haute, Indiana

CTL Professional Services

- Geotechnical Investigation
- Grout Stabilization Design
- Construction Observation

Project Background

The project consisted of an investigation into the presence or lack of mine voids beneath the Airport improved property (terminal, main runway, hangers and fire station). The investigation determined that the airport was above an area-wide abandoned deep mine that threatened the facility with potential subsidence stresses.

Project Scope

CTL Engineering Inc. performed a subsurface investigation including 58 test borings using 3.25 inch hollow stem augers and NQ size rock coring. The borings allowed for use of a down-hole camera system to inspect the mines, determine their condition and the current state of collapse. From this investigation, CTL designed a method to stabilize the underground mine voids beneath the airport through a systematic grout injection program of 60,000 cy of a cement / fly ash mix.

CTL provided construction observation to verify quantities, depths and pay items of the contractor.

This grouting project is currently the largest of its kind in the United States.

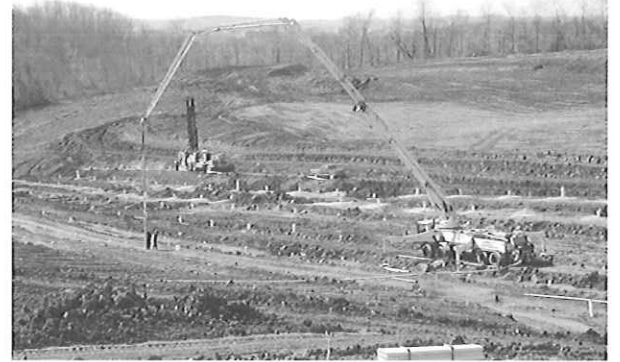

Client / Contact

Indiana DNR – AML Section
14619 West State Road 48
Jasonville, IN 47438

Owner 's Project Manager

Mr. Marvin Ellis
(812) 665-2207

Investigation / Design

Completion Date

2011

Estimated Construction Cost

\$6,700,000

MARYLAND DEEP MINE CLOSURES

DEEP MINE SEALS / BAT GATES & SITE RECLAMATION



CTL Engineering Inc.

Allegany & Garrett Counties, Maryland

CTL Professional Services

- **Surveying**
- **Geotechnical**
- **Civil Site Design**
- **Construction Documents**

Project Scope

CTL Engineering of West Virginia, Inc. was retained to provide the following:

Develop detailed engineering design plans and construction plans including; Cost Estimates, Bid Documents, Project Drawings, Maps, Plans & Specifications for the reclamation construction of multiple Mine Mouth Closures.

Design and Plans to include dry and wet mine seals, bat gates, regrading, drainage structures and site reclamation.

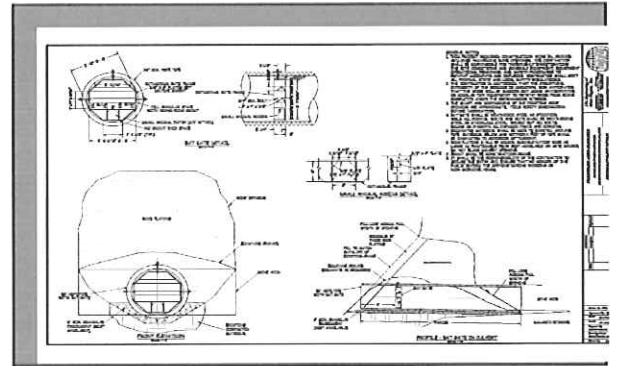

Client / Contact
MDE- AML Division
106 South Water Street
Frostburg, MD 21532
Design Completion Date
June 2010

PENINSULA HIGHWALL #1 & #2

DEP 14233

HIGHWALL & SUBSIDENCE RECLAMATION – MINE SEALS



Morgantown, Monongalia County, West Virginia

CTL Professional Services

- Surveying
- Geotechnical
- Civil Site Design
- Construction Documents

Project Background

This site contained 1,800 LF of vertical to sloughed highwalls 15 to 25 feet high, 7 partially of totally collapsed mine portals, 1 open mine portal, subsidence depressions behind the portals and water present at or flowing from the portals.

Project Scope

CTL Engineering of West Virginia, Inc. was retained to provide the following design:

- Access road into the site
- Wet seal 2 portals
- Regrade face of 2 portals
- Riprap channel and additional channel to carry water off site
- Backfill of highwalls and subsidence areas
- Restoration of golf path asphalt
- Conditioning and revegetation of all disturbed areas

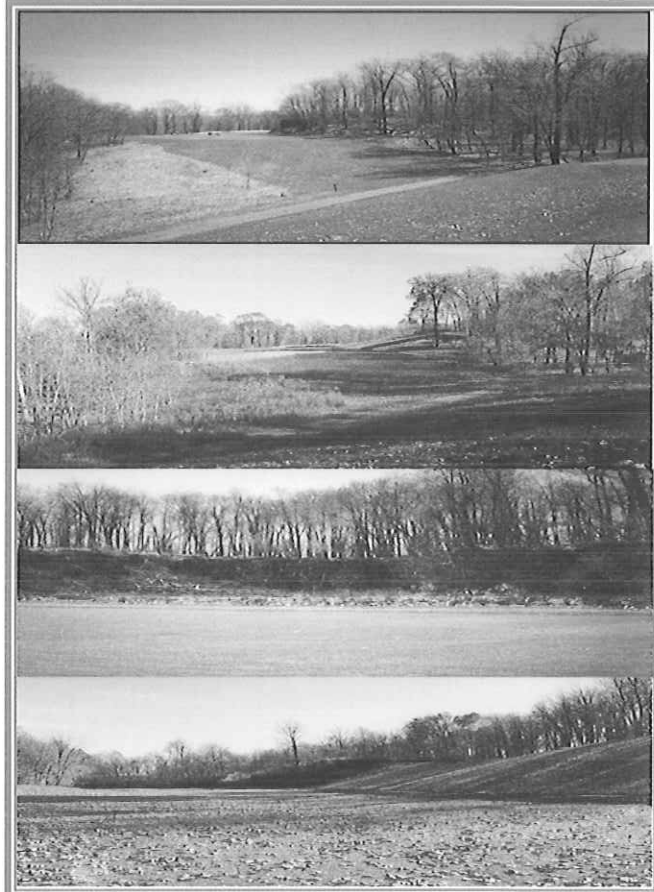

Client / Contact

**WV DEP-AML&R
601 57th Street
Charleston, WV 25304**

Design Completion Date

November 2009

Estimated Construction Cost

\$219,000

ST. CLAIR PORTALS DEP 14233



MINE PORTALS, COAL REFUSE, HIGHWALLS & MINE DRAINAGE

CTL Engineering Inc.

Morgantown, Monongalia County, West Virginia

CTL Professional Services

- **Surveying**
- **Geotechnical**
- **Civil Site Design**
- **Construction Documents**
- **Natural Stream Design**

Project Background

The site consisted of coal refuse, acid mine drainage with impounded water, collapsed mine portals and highwalls. 17 portals were found along the highwall bench. Three impoundments of approximately 70,000 sq.ft. had water flowing at 300 gpm with a pH value of 3.1 and iron >10 mg/l. A 35' to 45' high refuse pile was in the middle of the site as well as scattered refuse throughout the site.

Project Scope

CTL Engineering of West Virginia, Inc. was retained to provide the following design:

- Excavation and wet seal of at least 17 mine portals
- Dewater three impoundments
- 2000 LF of stream reconstruction
- Regrade and cover of coal refuse and spoil areas on mine bench
- Drainage control channels to carry water off site
- Backfill of highwalls using spoil material to original contour
- Conditioning and revegetation of all disturbed areas



Client / Contact

**WV DEP-AML&R
601 57th Street
Charleston, WV 25304**

Design Completion Date

March 2010

Estimated Project Cost

\$1,500,000

CHEAT NECK (LENHART) LANDSLIDE DEP14233

LANDSLIDE, MINE PORTALS & MINE DRAINAGE



CTL Engineering Inc.

Morgantown, Monongalia County West Virginia

CTL Professional Services

- Surveying
- Geotechnical
- Civil Site Design
- Construction Documents

Project Background

Drainage from two collapsed deep mine portals located behind the Lenhart residence created a small landslide. The slide measured about 50' wide and 80' long and the toe was within 20' of the residence and 10' of the LP gas tank.

Project Scope

CTL Engineering of West Virginia, Inc. was retained to provide the following design:

- Regrade and or removal of the slipping material
- Excavation, dewatering and wet seal of each deep mine portal
- Drainage control channels to carry water off site
- Conditioning and revegetation of all disturbed areas

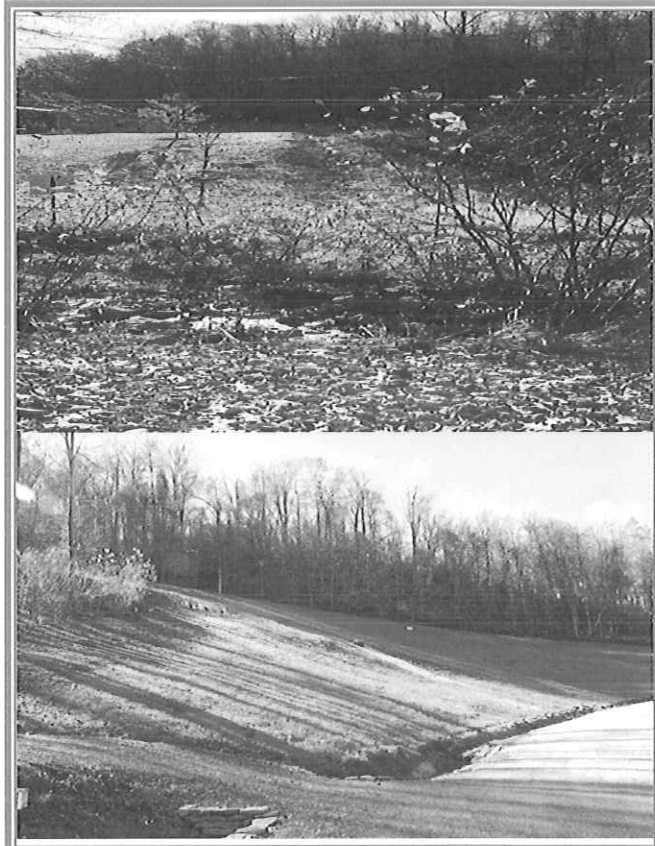

Client / Contact

**WV DEP-AML&R
601 57th Street
Charleston, WV 25304**

Design Completion Date

June 2009

Estimated Construction Cost

\$175,000

AARON'S RUN AMD PROJECT

ACID MINE DRAINAGE TREATMENT SYSTEM



CTL Engineering Inc.

Location: Garrett County, Maryland

CTL Professional Services

Site Review & Reconnaissance
Surveying & Mapping
Civil Site Design
Permitting including USACOE, MDE Wetland,
MDE S&E
Construction Specifications

Project Scope

CTL Engineering of West Virginia, Inc. was retained to provide the following design:

- Multiple AMD Treatment Systems
- 2 SAP Cells
- Slurry Doser
- Settling Ponds
- Natural Wetlands
- Full Site Grading Plans & Drainage Controls
- Access Road & Highway Rated Bridge
- All State & Federal Permitting
- Construction Specifications and Drawings

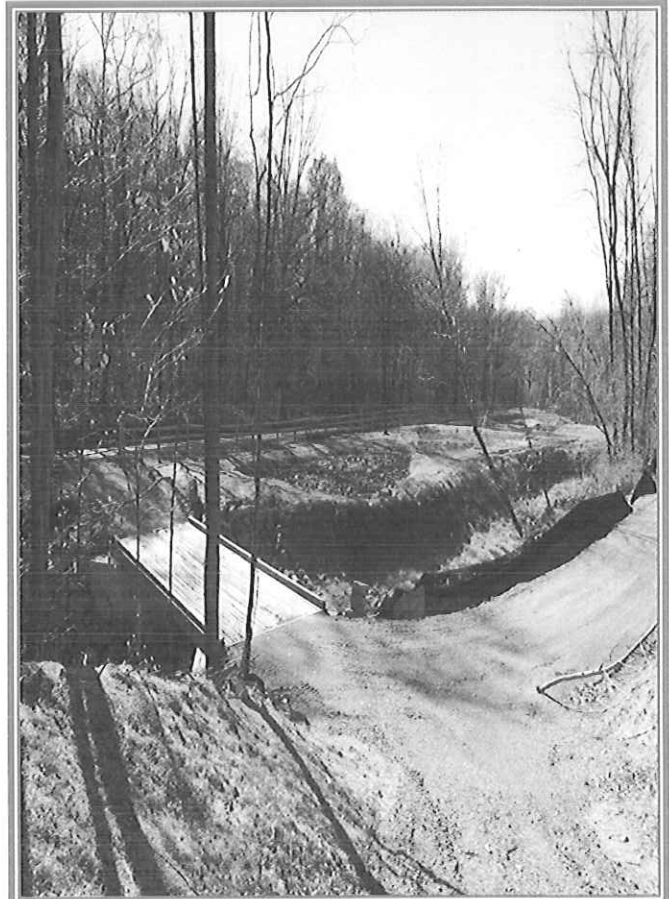

Client / Contact

**MDE AML Program
160 South Water Street
Frostburg, MD 21532**

Design Completion Date

October 2009

Estimated Construction Cost

\$ 450,000

LANDSLIDE STABILIZATION



CTL Engineering Inc.

**Location: Yellow Creek Twp., Columbiana County,
Ohio**

CTL Professional Services

**Site Review & Reconnaissance
Surveying & Mapping
Geotechnical Evaluation
Slope Stability
Civil Site Design
Construction Specifications**

Project Scope

CTL Engineering of West Virginia, Inc. was retained to provide the following design:

- Remediate existing landslide area by regarding slopes
- Toe Key Design
- Provide positive drainage from the site
- Provide multiple bonding benches
- Underdrain for site
- Temporary erosion and sedimentation control



Client / Contact

**ODNR - FORFEITURE
2050 East Wheeling Ave.
Cambridge, OH 43725**

Design Completion Date

November 2008

Estimated Construction Cost

\$ 101,700



Firm's Equipment

Geotechnical Equipment

CTL Engineering Inc.'s subsurface exploration equipment is adaptable for use of barges or all terrain vehicles (ATV's). CTL can mobilize special equipment or a fleet of drilling rigs to a particular project requiring multiple units. CTL Engineering owns and operates ten (10) drill rigs with a capacity of drilling to a depth of 300 feet. Other equipment includes large diameter soil and rock core sampling equipment, in-situ pressure meters and cone penetrometers.

CTL's drill rigs are rotary drilling rigs equipped to conduct standard split-spoon sampling with the use of hollow-stem augering, casing advancer or mud rotary. The rigs are also equipped with Moyno pumps, wire-line or standard coring equipment for proper and efficient execution of a subsurface investigation program

For field and laboratory materials analysis, CTL is equipped to conduct pressure meter tests, vane shear tests and cone penetrometers tests in the field. The laboratory is equipped with consolidometers, triaxial and direct shear apparatus, permeability devices and normal soils classification equipment.



CTL owns and operates a fleet of ten (10) drill rigs



CTL's ATV can drill in rough terrain

Chemistry Laboratory

The chemistry laboratory at CTL is equipped with Atomic Absorption equipment, spectrophotometers and gas chromatography equipment. CTL has the capability of and regularly performs both non-hazardous and hazardous waste tests.

CTL has established a quality control/ quality assurance plan, which is based on The American Council of Independent Laboratory Standards. CTL carries professional liability insurance coverage with a limit of \$1,000,00 per occurrence and aggregate.

Computer Resources

Operating efficiency may mean the difference between successful project completion and job overruns. At CTL Engineering, Inc., we effectively utilize computer software programs to assist in project and account management, resource allocation, data transfer, and preparation of plans and specifications. CTL's use of innovative technology sets us apart from the competition.

CADD Capabilities

Project designs and specifications are produced in our Computer Aided Drafting and Design (CADD) section using all releases of ACADD, including Release 2013. AutoCAD allows the user to interact with a wide variety of support software to modify project designs or perform different modeling functions. In addition, many public documents or plans are available in digitized form allowing CTL to directly download surveyed land plots or utility drawings. Successful use of CADD-based documents and/or plans has dramatically increased CTL's project efficiency and performance.

Geotechnical Software

CTL's Geotechnical Department utilizes a wide array of computer models to analyze deep foundation design, pavement design, slope stability, hydraulics, and flood hazard evaluation. Our experienced engineers use the following software to develop solutions:

- AASHTO** - Rigid and Flexible Pavement Design
- APILE** - Calculation of Load-Settlement
- COYLE** - Analysis of Axially Loaded Piles
- DSS** - Dimension Solution Software
- ELSYM5** - Elastic Layered System Pavement Design and Analysis
- GINT** - Boring Logs & Lab Testing
- HY8** - Culvert Analysis
- HY9** - Bridge Scour Analysis
- HWY** - Asphalt Institute Pavement Design
- LPILE** - Analysis of Laterally Loaded Piles
- NEWNEG** - Analysis of Piles Subjected to Negative Skin Friction
- RETWALL** - Design of Cantilever and Gravity Retaining Walls
- SCHMERT** - Analysis of Shallow Foundations in Sand
- SHAFT** - Analysis of Drilled Shafts (Caissons)
- STABL6** - Slope Stability Analysis
- WEAP** - Pile Driving Analysis
- WSPRO** - Water-surface Profile Computation Model



Civil Engineering Software

Eagle Point Watershed Modeling & Water Surface
Profiling
DCA Civil Engineering Design Software
Civilsoft
Groundwater for Windows
TR-55
Swamp
HEC 1 and 2
Survey 3.0

Hydrogeologic Studies

The backbone of many hydrogeologic studies is the determination of ground water properties, flow direction, and effects of local ground water pumping or injection. CTL is experienced in utilizing a wide variety of computer models to predict various properties of ground water and ground water flow to include:

MODFLOW - USGS Finite element ground water model
MODPATH - USGS Particle tracker package for MODFLOW
SURFER - Data contouring package
CAPZONE - Semi-analytical ground water mode
GWPATH - Flowpath tracker for ground water models
SLUGIX - Slug test analysis software
WHPA - Wellhead Protection area delineation

Remediation Models

CTL uses the latest in remediation technologies and computer models when preparing conceptual and full-scale remediation system designs. Today's programs allow our engineers to calculate engineering parameters (e.g., stripper efficiency, total dynamic head, air emissions, etc.) in minutes instead of several hours. This allows us to evaluate multiple technology applications operating at varying parameters. Some of the models CTL uses include:

ShallowTray - low profile aerator evaluation program
Stat - low profile aerator design
HyperVentilate - soil vapor extraction emission model
SoilVent - soil vapor extraction design model
Gast Blower Selection Program

Telemetry

CTL employees are experienced with a variety of remote data acquisition devices. These systems allow us to interface with the remediation systems and remotely operate, collect data, and troubleshoot potential operating problems. Auto dialers alert employees in the event of an emergency. Remote monitoring of the system minimizes system down time and ultimately saves the project money. CTL employees are experienced with:

Telmax II
RealFlex
SiteLink
SiteWindows

Accounting Software

CTL uses Wind2 accounting software for all of the services we provide. The project manager first constructs a budget from the information developed in the site-specific proposal. Critical pathways of construction are identified and individual tasks developed for implementing the proposed work. A project number is assigned and costs tracked to each phase, task, or subtask of the project. Monthly billing review reports are provided to the managers to control and assess the progress of the project.

General

CTL Engineering Inc. utilizes:

Windows based operating systems

Microsoft Office 2007 is used for word processing, spreadsheets creation, data processing, and presentation creation.

Alternative software including Corel Suite is available, if necessary.