



State of West Virginia
 Department of Administration
 Purchasing Division
 2019 Washington Street East
 Post Office Box 50130
 Charleston, WV 25305-0130

Solicitation

NUMBER
BCF13138

PAGE
1

ADDRESS CORRESPONDENCE TO ATTENTION OF:
ROBERTA WAGNER 304-558-0067

VENDOR
*709040519 304-343-7551 CAPITOL BUSINESS INTERIORS 711 INDIANA AVE CHARLESTON WV 25302

SHIP TO
HEALTH AND HUMAN RESOURCES VARIOUS LOCATIONS AS INDICATED BELOW

DATE PRINTED
05/21/2013

BID OPENING DATE: 06/13/2013 BID OPENING TIME 1:30PM

LINE	QUANTITY	UOP	CAT. NO.	ITEM NUMBER	UNIT PRICE	AMOUNT
REQUEST FOR QUOTATION (RFQ)						
THE WEST VIRGINIA STATE PURCHASING DIVISION FOR THE AGENCY, THE WEST VIRGINIA DEPARTMENT OF HEALTH AND HUMAN RESOURCES BUREAU OF CHILDREN AND FAMILIES, IS SOLICITING BIDS TO PROVIDE THE AGENCY WITH THE PURCHASE AND INSTALLATION OF MODULAR OFFICE FURNITURE IN THEIR BERKELEY COUNTY DHHR OFFICE LOCATED AT 433 MID-ATLANTIC PARK, MARTINSBURG, WV 25402 PER THE ATTACHED SPECIFICATIONS.						
0001	2	EA		425-94		
	SECTION 3.2.1 - PRIVATE OFFICES - RM 213 AND 210					
	30" X 72" SINGLE PEDESTAL DESK WITH B/B/F DRAWERS MUST BE FULL DEPTH AND FULL HEIGHT WITH FULL MODESTY.					
0002	2	EA		425-94		
	24"X42" BRIDGE WITH 24"H MODESTY PANEL					

06/13/13 09:25:50 AM
 West Virginia Purchasing Division

SIGNATURE <i>Kelli D. Bragg</i>	TELEPHONE 304-343-7551	DATE 6/13/13
TITLE <i>Sales Mgr</i>	FEIN 55-0422766	ADDRESS CHANGES TO BE NOTED ABOVE

WHEN RESPONDING TO SOLICITATION, INSERT NAME AND ADDRESS IN SPACE ABOVE LABELED 'VENDOR'



State of West Virginia
 Department of Administration
 Purchasing Division
 2019 Washington Street East
 Post Office Box 50130
 Charleston, WV 25305-0130

Solicitation

NUMBER
BCF13138

PAGE
24

ADDRESS CORRESPONDENCE TO ATTENTION OF:
ROBERTA WAGNER 304-558-0067

V E N D O R
*709040519 304-343-7551
CAPITOL BUSINESS INTERIORS
711 INDIANA AVE
CHARLESTON WV 25302

S H I P T O
HEALTH AND HUMAN RESOURCES
VARIOUS LOCATIONS
AS INDICATED BELOW

DATE PRINTED
05/21/2013

BID OPENING DATE: 06/13/2013 BID OPENING TIME 1:30PM

LINE	QUANTITY	UOP	CAT. NO.	ITEM NUMBER	UNIT PRICE	AMOUNT
0098	2	EA		425-94		
				SECTION 3.2.10 PRIVATE OFFICE ROOM 132		
				LATERAL FILES 4 HIGH, 30" W		
0099	1	EA		425-94		
				SECTION 3.2.11 PRIVATE OFFICE ROOM 133		
				LATERAL FILES 4 HIGH, 30" W		
***** THIS IS THE END OF RFQ BCF13138 ***** TOTAL:						<u>118,471.44</u>

SIGNATURE <i>Kevin D. Pruss</i>	TELEPHONE 304.343-7551	DATE 6/12/13.
TITLE Sales. Mgr.	FEIN 55-0422766	ADDRESS CHANGES TO BE NOTED ABOVE

WHEN RESPONDING TO SOLICITATION, INSERT NAME AND ADDRESS IN SPACE ABOVE LABELED 'VENDOR'



State of West Virginia
 Department of Administration
 Purchasing Division
 2019 Washington Street East
 Post Office Box 50130
 Charleston, WV 25305-0130

Solicitation

NUMBER
BCF13138

PAGE
1

ADDRESS CORRESPONDENCE TO ATTENTION OF:
ROBERTA WAGNER 304-558-0067

VENDOR

*709040519 304-343-7551
 CAPITOL BUSINESS INTERIORS
 711 INDIANA AVE
 CHARLESTON WV 25302

SHIP TO

HEALTH AND HUMAN RESOURCES
 VARIOUS LOCATIONS
 AS INDICATED BELOW

DATE PRINTED
06/04/2013

BID OPENING DATE: 06/13/2013 BID OPENING TIME 1:30PM

LINE	QUANTITY	UOP	CAT. NO.	ITEM NUMBER	UNIT PRICE	AMOUNT
				ADDENDUM NO. 1		
				ADDENDUM ISSUED:		
				1. TO PROVIDE ANSWER TO QUESTIONS REGARDING THE ORIGINAL SOLICITATION AND TO ADDRESS CHANGES MADE TO THE SPECIFICATIONS.		
				2. TO PROVIDE VENDORS A COPY OF THE MANDATORY PRE-BID MEETING SIGN-IN SHEET.		
				3. TO PROVIDE ADDENDUM ACKNOWLEDGEMENT. THIS DOCUMENT SHOULD BE SIGNED AND RETURNED WITH YOUR BID. FAILURE TO SIGN AND RETURN MAY RESULT IN THE DISQUALIFICATION OF YOUR BID.		
				***** END OF ADDENDUM NO. 1 *****		

SIGNATURE <i>Kelli D. Prange</i>	TELEPHONE 304-343-7551	DATE 6/12/13.
TITLE <i>Sales Mgr.</i>	FEIN 55-0422766	ADDRESS CHANGES TO BE NOTED ABOVE

WHEN RESPONDING TO SOLICITATION, INSERT NAME AND ADDRESS IN SPACE ABOVE LABELED 'VENDOR'

Guest chairs - metal frame w/arms, 4 legs without casters upholstered in fabric (2 per Carton)	2	United Chair	BR32	United Chair		213 & 210	\$299.85	\$ 599.70
							Subtotal	\$ 599.70

Miscellaneous Items

Description	QTY	MNFTR	Part No.	SWC Catalog#	Page	Location/Rooms	Unit Price	EXT. Price
Bookcase with 3 adjustable shelves 4 high x 36"w	2	Haworth	JBCS-0436	Haworth Steel Casegoods		213 & 210	\$276.67	\$ 553.34
Combination file 30"wx28"h, contains 2 box drawers, 1 file drawer, and 1 lateral file drawer.	2	Haworth	JCPT-0230-S1A	Haworth Steel Casegoods		213 & 210	\$491.11	\$ 982.22
Vertical Storage (hutch) with steel doors to span bridge and credenza must have closed doors that lock, 66"w	2	Haworth	JFUS-3366	Haworth Steel Casegoods		213 & 210	\$719.26	\$ 1,438.52
	1	Haworth	JABR-L	Haworth Steel Casegoods		213 & 210	\$98.52	\$ 98.52
	1	Haworth	JABR-R	Haworth Steel Casegoods		213 & 210	\$98.52	\$ 98.52
Lateral file 3 high, 30" w	2	Haworth	JLPD-0330-S1	Haworth Steel Casegoods		213 & 210	\$378.15	\$ 756.30
							Subtotal	\$ 3,927.42

Section 3.2.2 - Private Offices (Room 155)

Private Office

Description	QTY	MNFTR	Part No.	SWC Catalog#	Page	Location/Rooms	Unit Price	EXT. Price
30" x 72" single pedestal desk with b/b/f drawers must be full depth and full height with full modesty	1	Haworth	JFDL-3072-HRS13	Haworth Steel Casegoods		155	\$720.37	\$ 720.37
24"x42" bridge with 24" h modesty panel	1	Haworth	JFBL-2442-2	Haworth Steel Casegoods		155	\$212.59	\$ 212.59
24"x72" desk shell with full end panels and 24" modesty	1	Haworth	JFSL-2472-2	Haworth Steel Casegoods		155	\$454.82	\$ 454.82
54" task light	1	Haworth	LUTS-0054-16UEP	Haworth Steel Casegoods		155	\$80.37	\$ 80.37
	1	Haworth	JBBT-1	Haworth Steel Casegoods		155	\$5.93	\$ 5.93
Pencil drawer	1	Haworth	PPD-18	Haworth Steel Casegoods		155	\$31.11	\$ 31.11
Hanging Paper Management to include: In trays	1	Haworth	SGR-3016	Haworth Steel Casegoods		155	\$82.59	\$ 82.59
Out trays	1	Haworth	HGMB-0002	Haworth Steel Casegoods		155	\$31.25	\$ 31.25
8" storage bins, (4 per Carton) this will attach under the vertical storage unit.	1	Haworth	HGBN-0008	Haworth Steel Casegoods		155	\$42.75	\$ 42.75
							Subtotal	\$ 1,661.78

Seating

Description	QTY	MNFTR	Part No.	SWC Catalog#	Page	Location/Rooms	Unit Price	EXT. Price
Guest chairs - metal frame no castors, 4 legs with arms fully upholstered in fabric (2 per Carton)	1	United Chair	BR32	United Chair		155	\$299.85	\$ 299.85
							Subtotal	\$ 299.85

Miscellaneous Items

Description	QTY	MNFTR	Part No.	SWC Catalog#	Page	Location/Rooms	Unit Price	EXT. Price
Combination file 30"wx28"h, contains 2 box drawers, 1 file drawer, and 1 lateral file drawer.	1	Haworth	JCPT-0230-S1A	Haworth Steel Casegoods		155	\$491.11	\$ 491.11

								Subtotal	\$ 2,020.00
--	--	--	--	--	--	--	--	----------	-------------

Seating

Description	QTY	MNFTR	Part No.	SWC Catalog#	Page	Location/Rooms	Unit Price	EXT. Price	
Side Chairs: Molded poly shell, no upholstery, metal frame no arms, 4 legs, stationary (4 per Carton)	1	Hon	H4041	Hon		211 & 212	\$262.20	\$ 262.20	
								Subtotal	\$ 262.20

Miscellaneous Items

Description	QTY	MNFTR	Part No.	SWC Catalog#	Page	Location/Rooms	Unit Price	EXT. Price	
Lateral file 2 high, 30" w	2	Haworth	JLPD-0230-S1	Haworth Steel Caseloads		211 & 212	\$321.85	\$ 643.70	
								Subtotal	\$ 643.70

Section 3.2.6 - The Observation room will contain the following: (Room 208)

Private Offices

Description	QTY	MNFTR	Part No.	SWC Catalog#	Page	Location/Rooms	Unit Price	EXT. Price	
Single pedestal desk, free standing design, 24" w x 60" l single pedestal box/box/file full to the floor, finish to match private offices and interview rooms.	1	Haworth	JFDL-2460-HRS11	Haworth Steel Caseloads		208	\$576.67	\$ 576.67	
								Subtotal	\$ 576.67

Miscellaneous Items

Description	QTY	MNFTR	Part No.	SWC Catalog#	Page	Location/Rooms	Unit Price	EXT. Price	
Bookcase, 4 high x 36" w with 3 adjustable shelves in 1" increments.	1	Haworth	JBCS-0436	Haworth Steel Caseloads		208	\$276.67	\$ 276.67	
								Subtotal	\$ 276.67

Section 3.2.7 - Private Offices (Rooms 144 and 145)

Private Office

Description	QTY	MNFTR	Part No.	SWC Catalog#	Page	Location/Rooms	Unit Price	EXT. Price
30" x 60" single pedestal desk with b/b/f drawers must be full depth and full height with full modesty	1	Haworth	JFDL-3060-HLS13	Haworth Steel Caseloads		144 & 145	\$672.23	\$ 672.23
24"x42" return with no pedestal	1	Haworth	JFRL-2442-L2	Haworth Steel Caseloads		144 & 145	\$309.63	\$ 309.63
	1	Haworth	JFRL-2442-R2	Haworth Steel Caseloads		144 & 145	\$309.63	\$ 309.63

54" task light	2	Haworth	LUTS-0054-16UEP	Haworth Steel Caseloads		144 & 145	\$80.37	\$ 160.74	
	2	Haworth	JBBT-1	Haworth Steel Caseloads		144 & 145	\$5.93	\$ 11.86	
Hanging Paper Management to include:									
In trays	2	Haworth	SGR-3016	Haworth Steel Caseloads		144 & 145	\$82.59	\$ 165.18	
Out trays	2	Haworth	HGMB-0002	Haworth Steel Caseloads		144 & 145	\$31.25	\$ 62.50	
8" storage bins, (4 per Carton)	2	Haworth	HGBN-0008	Haworth Steel Caseloads		144 & 145	\$42.75	\$ 85.50	
this will attach under the vertical storage unit.									
								Subtotal	\$ 2,449.50

Seating

Description	QTY	MNFTR	Part No.	SWC Catalog#	Page	Location/Rooms	Unit Price	EXT. Price	
Guest chairs - metal frame no castors, 4 legs with arms fully upholstered in fabric (2 per Carton)	2	United Chair	BR32	United Chair		144 & 145	\$299.85	\$ 599.70	
								Subtotal	\$ 599.70

Miscellaneous Items

Description	QTY	MNFTR	Part No.	SWC Catalog#	Page	Location/Rooms	Unit Price	EXT. Price	
Bookcase with 3 adjustable shelves 4 high x 36"w	2	Haworth	JBCS-0436	Haworth Steel Caseloads		144 & 145	\$276.67	\$ 553.34	
Vertical Storage (hutch) with steel doors to span desk and return must have closed doors that lock, 72"w	2	Haworth	JFUS-3372	Haworth Steel Caseloads		144 & 145	\$774.82	\$ 1,549.64	
	1	Haworth	JABR-L	Haworth Steel Caseloads		144 & 145	\$98.52	\$ 98.52	
	1	Haworth	JABR-R	Haworth Steel Caseloads		144 & 145	\$98.52	\$ 98.52	
								Subtotal	\$ 2,300.02

Section 3.2.8 - Private Office (Room 202)

Private Office

Description	QTY	MNFTR	Part No.	SWC Catalog#	Page	Location/Rooms	Unit Price	EXT. Price
Curved wrap around left extended transition corner unit, full depth full height pedestal b/b/f (48x72x24d)	1	Haworth	JFAL-2346-HLS11	Haworth Steel Caseloads		202	\$808.15	\$ 808.15
Curved wrap around right extended transition corner unit, full depth full height pedestal b/b/f (48x72x24d)	1	Haworth	JFAL-2346-JRS11	Haworth Steel Caseloads		202	\$808.15	\$ 808.15
24"x48" bridge with 24" h modesty panel	1	Haworth	JFBL-2448-2	Haworth Steel Caseloads		202	\$230.00	\$ 230.00
24"x42" return with no pedestal	1	Haworth	JFRL-2442-L1	Haworth Steel Caseloads		202	\$290.00	\$ 290.00
24"x48" return with b/b/f pedestal full height, full depth with lock	1	Haworth	JFRL-2448-HRS11	Haworth Steel Caseloads		202	\$441.85	\$ 441.85
54" task lights	2	Haworth	LUTS-0054-16UEP	Haworth Steel Caseloads		202	\$80.37	\$ 160.74
	2	Haworth	JBBT-1	Haworth Steel Caseloads		202	\$5.93	\$ 11.86
Pencil drawer	1	Haworth	PPD-18	Haworth Steel Caseloads		202	\$31.11	\$ 31.11
Hanging paper management to include:								
In tray	1	Haworth	SGR-3016	Haworth Steel Caseloads		202	\$82.59	\$ 82.59
Out tray	1	Haworth	HGMB-0002	Haworth Steel Caseloads		202	\$31.25	\$ 31.25
8" storage bins, (4 per Carton)	1	Haworth	HGBN-0008	Haworth Steel Caseloads		202	\$42.75	\$ 42.75
this will attach under storage unit								

Tackboard 60"x33" to be wall hung with	1	Haworth	HTB-6033	Haworth Steel Casegoods		202	\$85.00	\$ 85.00
wall track	1	Haworth	WT-72	Haworth Steel Casegoods		202	\$35.00	\$ 35.00
							Subtotal	\$ 3,058.45

Miscellaneous Items

Description	QTY	MNFR	Part No.	SWC Catalog#	Page	Location/Rooms	Unit Price	EXT. Price
Combination file 30"w x 28"h, contains, 2 box drawers, 1 file drawer and 1 lateral file drawer.	1	Haworth	JCPT-0230-S1A	Haworth Steel Casegoods		202	\$491.11	\$ 491.11
Combination file 30"w x 28"h, contains, 2 box drawers, 1 file drawer and 1 right hand storage cabinet.	1	Haworth	JCPB-0230-SS1A	Haworth Steel Casegoods		202	\$573.34	\$ 573.34
Vertical Storage (hutch) with steel doors to span back 72" sides of corner units must have closed doors that lock	2	Haworth	JFUS-3372	Haworth Steel Casegoods		202	\$774.82	\$ 1,549.64
	1	Haworth	JABR-L	Haworth Steel Casegoods		202	\$98.52	\$ 98.52
	1	Haworth	JABR-R	Haworth Steel Casegoods		202	\$98.52	\$ 98.52
Lateral files 4 high, 30"w	2	Haworth	JLPD-0430-S1	Haworth Steel Casegoods		202	\$478.52	\$ 957.04
							Subtotal	\$ 3,768.17

Section 3.2.9 - Private Office: (Room 201)

Work Surfaces

Description	QTY	MNFR	Part No.	SWC Catalog#	Page	Location/Rooms	Unit Price	EXT. Price
Desk - General Specifications: Outside and surface panels are made from 1" thick 45 lbs. density particle board and covered on both sides with high performance thermally fused laminate. File drawers have full extension steel ball bearing slides, box drawers use 3/4 extension steel ball bearing slides. Drawers and end panels are edge banded on all four sides to protect clothing and the floor covering. locks are standard. Drawers are open with side pulls. Full leg end panels and modesty panel.								
Extended laminate corner "P" island with work surface on right, full end panel and post 36"d x72"w x29"h	1	Global	Z3672EPTR	Global Casegoods		201	\$316.73	\$ 316.73
Bridge 21"d x42"w x 29"h, laminate	1	Global	Z2142TRBL	Global Casegoods		201	\$142.59	\$ 142.59
Center drawer laminate 18"d x 20"w x 3"h	1	Global	CD20	Global Casegoods		201	\$64.81	\$ 64.81
Freestanding paper tray to include: Horizontal In tray	1	Haworth	DTLS-2	Haworth Steel Casegoods		201	\$13.50	\$ 13.50
Horizontal Out tray one divider to allow for 2 levels of storage								
Freestanding diagonal tray to consist of 3 slots	1	Haworth	DTPR-1	Haworth Steel Casegoods		201	\$9.00	\$ 9.00
Multi file unit containing 2 box drawers on right, 1 file drawer on left and one lateral file drawer on bottom 24"d x 36"w x 28"h, laminate	1	Global	Z36L2XSR	Global Casegoods		201	\$541.42	\$ 541.42

Subtotal \$ 3,473.75

Section 3.2.15 - Mail Room 130

Panels									
Description	QTY	MNFTR	Part No.	SWC Catalog#	Page	Location/Rooms	Unit Price	EXT. Price	
Powered accoustical panels 80" tall.	4	Haworth	EFN-280-B	Haworth Unigroup Too		130	\$268.50	\$ 1,074.00	
Panels on wings are non-powered.	1	Haworth	EFP-380-B	Haworth Unigroup Too		130	\$386.75	\$ 386.75	
Must include all covers on corners and straights.	3	Haworth	EFP-580-B	Haworth Unigroup Too		130	\$473.25	\$ 1,419.75	
	4	Haworth	FPPC-80-B	Haworth Unigroup Too		130	\$27.00	\$ 108.00	
	2	Haworth	BFM-1-B	Haworth Unigroup Too		130	\$47.00	\$ 94.00	
	1	Haworth	PRD-3-B	Haworth Unigroup Too		130	\$34.25	\$ 34.25	
Please see drawing that is attached for specifications regarding this room	4	Haworth	ZEBD-1600-PP	Haworth Unigroup Too		130	\$20.75	\$ 83.00	
								Subtotal	\$ 3,199.75

Work Surface

Description	QTY	MNFTR	Part No.	SWC Catalog#	Page	Location/Rooms	Unit Price	EXT. Price	
24"d x 60"w laminate work surfaces	2	Haworth	WURA-2460-LTSA	Haworth Unigroup Too		130	\$91.50	\$ 183.00	
24"d x 96"w laminate work surface	1	Haworth	WURA-2496-LTSA	Haworth Unigroup Too		130	\$131.25	\$ 131.25	
36" Paper Management Mounting bar	3	Haworth	KUTP-0036-E	Haworth Steel Casegoods		130	\$13.75	\$ 41.25	
60"w Paper Management mounting bar	9	Haworth	KUTP-0060-E	Haworth Steel Casegoods		130	\$17.25	\$ 155.25	
Paper Management 6"w vertical trays	90	Haworth	KUTV-0006-S	Haworth Steel Casegoods		130	\$9.00	\$ 810.00	
24"d x 84"w x 40"H table on casters	1	Haworth	45TC-2484-E7SC	Haworth Tables		130	\$416.50	\$ 416.50	
								Subtotal	\$ 1,737.25

Miscellaneous Items

Description	QTY	MNFTR	Part No.	SWC Catalog#	Page	Location/Rooms	Unit Price	EXT. Price	
Combination file 30"w x 28"h, contains 2 box drawers, 1 file drawer, and 1 lateral file drawer	5	Haworth	JCPT-0230-S1A	Haworth Steel Casegoods		130	\$491.11	\$ 2,455.55	
Lateral File 4 high, 36"w	3	Haworth	JLPD-0436-S1	Haworth Steel Casegoods		130	\$566.67	\$ 1,700.01	
5 high storage cabinet with lock, 36"w	4	Haworth	JSPY-0536-S1	Haworth Steel Casegoods		130	\$447.78	\$ 1,791.12	
								Subtotal	\$ 5,946.68

Section 3.2.16 - Kitchen Room 137

Tables								
Description	QTY	MNFTR	Part No.	SWC Catalog#	Page	Location/Rooms	Unit Price	EXT. Price
36" x 36" square table with a steel 29"h "X" base, laminate meduim gray to match Haworth Smoke finish or equal. Bases are meduim gray.	2	Haworth	TPPS-3636	Haworth Tables		137	\$159.75	\$ 319.50

X Series[®]
Casegoods

HAWORTH[®]



Impressively flexible. Exceedingly durable. Incredibly good looking. With an extensive offering, Haworth X Series steel casegoods support a wide variety of needs, budgets and styles. Use X Series casegoods to create complete office environments — with a broad selection of desks, credenzas, returns, bridges and a comprehensive range of storage solutions.

X Series crosses into a bold, new world of casegoods. You can integrate X Series easily into any environment, thanks to a generous selection of finishes, materials and pulls. Choose from natural and double-cut veneers, laminates, translucents and perforated metal — options that allow X Series casegoods to fit perfectly in executive offices, private spaces and open plan environments. Whatever your need, X Series casegoods support it.



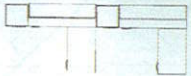

X Series Trim Plaster, Perforation Meteors, Wood Wenge, Tackboard Fabric Kio, Enclose® Moveable Walls Silver, Zody® Task Seating, Maharam, Dart, Fiesta, Mesh Gusto, LOOK® Side Chair Maharam, Quatrefoil Pink, BRAZO® light, Compose® table.

X Series casegoods offer tremendous performance in an attractive package. Its scalable design imparts planning flexibility, making X Series ideal for a broad range of applications. At the same time, the designed-in features of X Series provide unsurpassed strength, security and durability.

With endless configuration possibilities, X Series casegoods can adapt to any situation imaginable. Whether creating open plan environments, panel wrapped stations, freestanding offices or private spaces, the modular, scalable and readily integrated X Series naturally adapts. It also blends effortlessly with other Haworth products through shared finishes and materials.

Integrate easily and seamlessly. X Series casegoods blend effortlessly with a broad range of components, storage and even Enclose moveable walls. With a shared materials and finish strategy, you can create a unified space from walls to workspaces to storage.

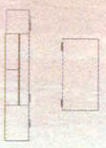

X Series Trim Plaster, Wood Wenge, Tackboard Fabric Kio, Smurf, Enclose Moveable Walls/Wall Hung Components Wood, Wenge, Wall Covering, Breeze, Zody Task Seating Maharam, Venn Thunder, Mesh Soothe, Hello® Side Chair Maharam, Venn Thunder, Wood Expresso.



X Series Trim Metallic Gunmetal, Wood Ebony, Tackboard Fabric Kio, Yppgi Kio, Planes® Table Wood, Ebony, Trim Silver, Enclose Moveable Walls Trim, Silver, X99® Task Seating, Maharam, Ledger, Stark, Hello Side Chair Maharam, Ledger, Stark, Wood Ebony.

X Series is a casegood chameleon — whether used holistically or blended with Planes Tables. From natural and double-cut veneers to perforated metal, X Series' finish options allow it to suit any style. Mix materials and finishes for completely individualized solutions. Select the precisely right pull option to heighten the effect. Go mobile with casters on storage. The result? A cohesive, yet distinctive, space that supports user needs and preferences while reflecting an organization's brand and culture.



X Series Trim: Cement, Laminator White Solid, Translucent Basic, White, Turquoise Fabric, Jib, Zesty Task, Graphing, Mooding, Terracotta, Mesh Reflects, Zesty Gamest Chair Moulding, Terracotta, ERAZO light

X Series stands up to daily demands through world-class strength and engineering. Features such as patented box-in-box construction, full drawer extensions and superior locks make X Series as rugged and secure as it is attractive. It's the durability you expect from Haworth, backed by a lifetime warranty.

X Series Casegoods Statement of Line

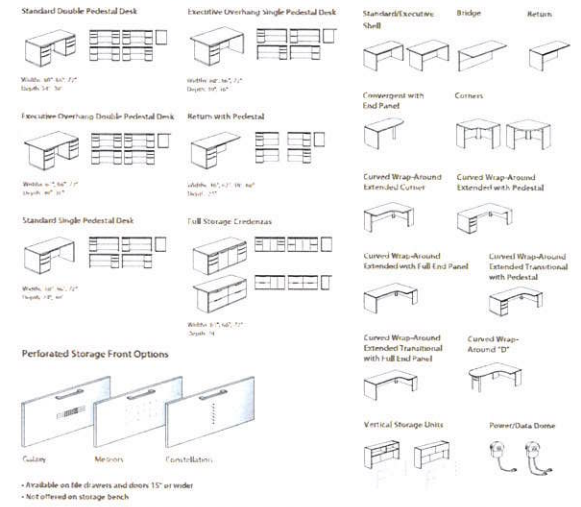

X Series Storage with J-Pull

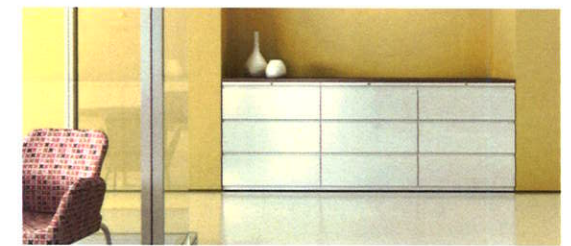

Drawer Pull Styles

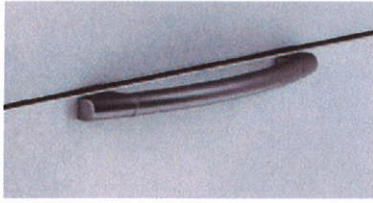

Radius

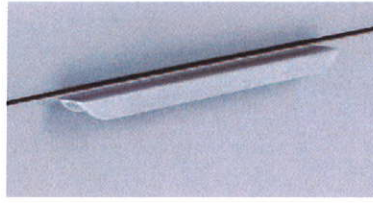

Taper

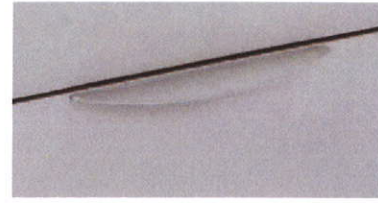

Ellipse



Crescent

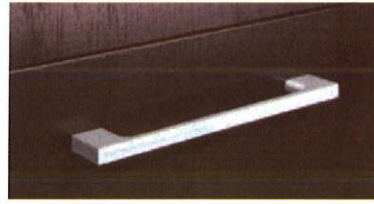

Linear

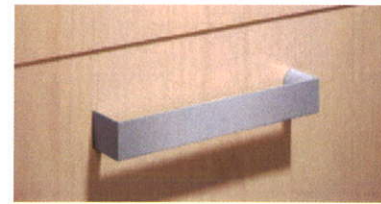

Classic



Wood J-Pull



Steel J-Pull

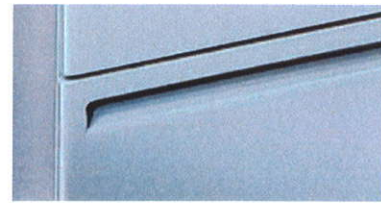

Integral

Finishes – Refer to surfaces.haworth.com to view all Haworth surface selections.

HAWORTH®

For more information call 800.344.2600 or 616.393.3000.
Download additional copies at haworth.com.

This brochure is printed on FSC Certified U2®:XG™ paper, manufactured with electricity in the form of renewable energy (wind, hydro, biogas) and contains a minimum of 30% post-consumer recovered fiber. FSC is the global benchmark for responsible forest management.



Haworth is a registered trademark of Haworth, Inc.
Printed in USA ©Haworth, Inc. 2010 05.10 Item #0146

haworth.com | haworth-europe.com | haworth-asia.com

CASTELLI
for Haworth

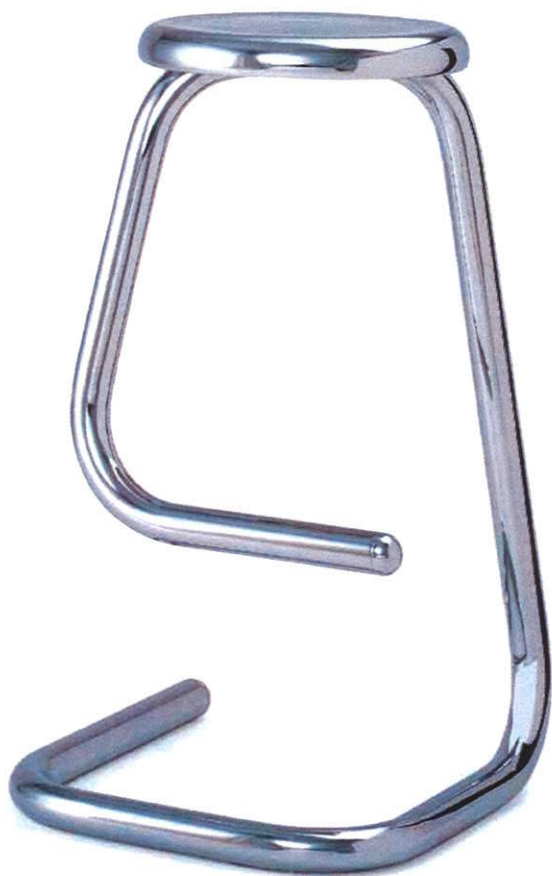

HAWORTH

For more information call 800.344.2600 or 616.393.3000.

Haworth is a registered trademark of Haworth, Inc.
Printed in USA ©Haworth, Inc. 2010 1.10 Item #0101
haworth.com|haworth-europe.com|haworth-asia.com

Printed on Finch Premium Blend which contains a
minimum of 30% post-consumer recovered fiber.

K700 | Castelli for Haworth



Over 25 years ago, this classic paperclip stool was brought to life. Its contours are both functional and distinct. The stool's tubular steel frame offers a clean design that adapts to applications that call for sturdy, impromptu seating. Available in three heights and two finishes.

Manufactured in the USA

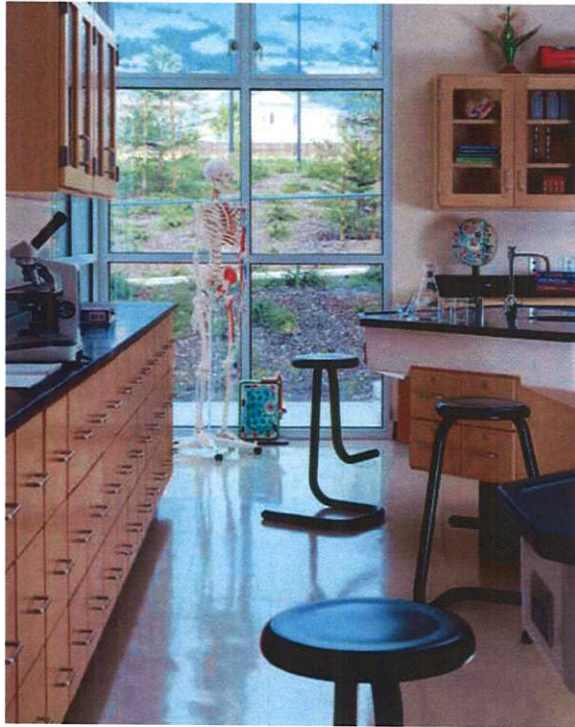

K700

The stool is available in three heights: 18, 24, and 28 inches. All three heights are available with polished chrome finish. Frame construction for all is 1 1/2-inch O.D. tubular steel with the seat welded to the frame.

An upholstered seat cap cover is available on all K700 series stools. The cap includes sewn-in-place foam, slips over the seat, and is held in place by elastic banding sewn into the outer edge of the upholstery.

K700

Dimensions:	With Footrest	Without Footrest
SH:	28.0 in	18.0 or 24.0 in
D:	17.0 in	17.0 in
W:	16.0 in	16.0 in



Haworth Design Studio, 1980

The Haworth Design Studio draws on the experience and knowledge of research and development teams from all over the world. We have internal Haworth teams providing their expertise in North America and Asia Pacific as well as Europe. Haworth is unique in offering this global perspective, as our teams from each region work together to create both global solutions and products that are localized for specific regional markets.

The European Haworth Design Studio is the union of Centro Studio Castelli, the Comforto Development Team, and Haworth's own research and development teams. The team prides itself on a long tradition of working in harmony with experienced designers to merge our knowledge and research with their innovation.

With designers, engineers, and product managers working together across three regions, the Haworth Design Studio is guaranteed to develop workspaces that meet the needs of users worldwide in form and function.

Improv[®] Side Chair

HAWORTH[®]



Elements of style, the height of versatility

With broad appeal and many options, the Improv Side Chair rounds out the Improv Seating Family. Perfectly at home in reception and teaming areas, as additional office seating, or in classrooms and lobbies, it represents the height of versatility.

Choose either sled-base or stackable leg-base chairs. Specify casters for added mobility or the wood back for a look of casual elegance. With its unique elliptical steel tubing and fluid design, the Improv Side Chair fits into a range of settings, from casual to upscale. Ganged seating, in-line seating, tablet arms, and occasional tables further enhance your options.



Wood-Back Side Chair Cherry, Tellure Black, Silver Trim. Stool Herringbone Field Lily, Silver Trim.



Stool shown with Upholstered Back



Leg-Base Stacking Chair shown with Polypropylene Back



Wood-Back



Sled-Base



Ganged Leg-Base Chair with 14" Tablet Arms provides enough room for a laptop. Tablet arms flip up for easier seating access and stackability.



In-Line Table



Occasional Tables

Improv Side Chairs:

Sled-Base Chairs



Overall Height: 32"
Overall Width: 22"
Overall Depth: 21.5"
Seat Height: 18"
Seat Width: 19"
Seat Depth: 18"

Leg-Base Stools



Overall Height: 41.25"
Overall Width: 22"
Overall Depth: 23"
Seat Height: 27.5"
Seat Width: 19"
Seat Depth: 18"

Leg-Base Stacking Chairs



Overall Height: 32"
Overall Width: 22"
Overall Depth: 21.5"
Seat Height: 18"
Seat Width: 19"
Seat Depth: 18"

Oval Occasional Table



Overall Height: 16", 20"
Overall Width: 48"
Overall Depth: 20"

Round Occasional Table



Overall Height: 16", 20"
Overall Width: 20"
Overall Depth: 20"

In-Line Table



Overall Height: 20"
Overall Width: 18.75"
Overall Depth: 20"

End-of-Run Table



Overall Height: 20"
Overall Width: 19.375"
Overall Depth: 20"

Book Rack



Attachable to an Improv Leg-Base or Sled-Base Side Chair (field attachable)

Chair-to-Chair Connector Bar



MPRV-Bars
Spaces Chairs 1.25" Apart

Ganging Device



Add "-5" To Catalog Number
Spaces Chair 1.5" Apart
(Cannot be field-installed)

Stacking Dolly



MPRV-Cart
Stacks Chairs 10 High

HAWORTH®

For more information call 800.344.2600 or 616.393.3000.
Download additional copies at haworth.com.

This brochure is printed on U2[®]:XG™, manufactured with electricity in the form of renewable energy (wind, hydro, biogas) and contains a minimum of 30% post-consumer recovered fiber. FSC is the global benchmark for responsible forest management.



Haworth is a registered trademark of Haworth, Inc.
Printed in USA ©Haworth, Inc. 2001 01.09 Item #2301

haworth.com | haworth-europe.com | haworth-asia.com



Zira™



Zira™



Zira™, a contemporary desking solution with extensive options to personalize your workspace.

Above: Zira teaming shown in Dark Espresso (DES) with frosted glazed doors / silver frames (Z1) and Silver HQ handles. Ride and Rest seating shown in Designtex Wire, Neutral Tint (W182). Cover: Zira shown in Dark Espresso (DES) and Brushed Cobalt (BRC). Triumph seating shown in Lynx, Raven (LX38).

Zira™

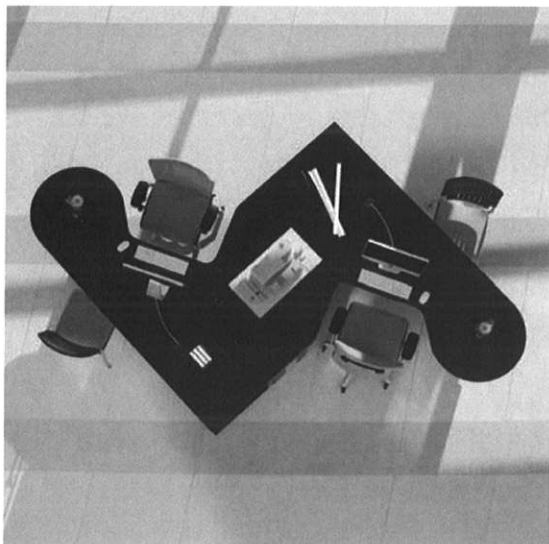

For the managerial application or executive offices, create a work environment that meets your worksurface needs and storage requirements. Select from hundreds of laminate finish combinations, storage components that can tower to 84" high, 9 handle options, 5 different choices for edge details, 4 glazing options on doors and modesty panels and 1" and 1 ½" thick top options.

Above, and left: Zira executive suite shown in Dark Espresso (DES) with frosted glazed doors / silver frames (Z1) and flared Silver HS handles. Aspen seating shown in CFStinson, Outta Sight, Silver Lining (YC93) with headrest in Volo, Parchment (VL61).

Zira™



Above: Zira shown in Willow Grey (WGY) / Tiger Maple (TMP) with Silver HS handles. Alero seating shown in Momentum GIG, Martini (GIG4).

Zira™



Whether a workspace is required for individual use, teaming or clusters, Zira offers hundreds of mix and match components to meet any design specification. Components can be freestanding for single workstation configurations, or joined together to form multiple work groups.

Above, and left: Zira teaming shown in Tiger Fruitwood (TFW) / Tiger Maple (TMP) with frosted glazed doors / Silver frames (Z1) and flared Silver HS handles. Alero and Caprice seating shown in Momentum, GIG Martini (GIG4). Note: Divide posts and transactions top not exactly as shown.

Zira™

Zira™ is the most functional solution to your work environment efficiency and organization.

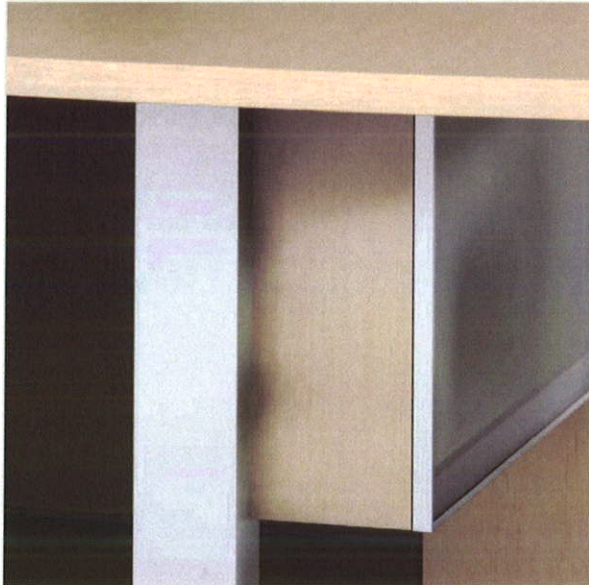

4" square monopost are available in Silver or Black finish. Optional 4" and 5" round are available at no extra charge.



Box drawers are mounted on $\frac{3}{4}$ " extension ball bearing slides.



Divide™ a modular desk-mounted panel system shown with glazed panels which vertically stack to provide privacy.



Hutch with glazed doors are available in 4 glazing options with Silver or Black frames. 9 handle options in Silver, Black, Nickel or Brass finishes.

Zira™



Zira™, ideal for shared teaming areas.

Components can be joined together to form multiple work groups or can be freestanding for single workstation configurations. With such an array of components and options, Zira can accommodate small spaces through tall spaces, and of course, everything in between.

Storage can be added where needed, whether attached to the workstation or designed elsewhere in the work environments. Select from hundreds of components for any size or shape office. Storage components can tower up to 84" high and are available in an array of laminate finishes and handle options in Silver, Black, Nickel or Brass finish.

Above, and left: Zira teaming show in Winter Cherry (WCR) / White (WHT). Graphic seating shown in Presidio, Persian (PR05).

Zira™



A beautiful productive office can also be a highly organized office.

Zira is designed with solid 1" and 1 ½" laminate tops. Select options such as edge details, pigeon hole storage, closed door hutches, open display shelves, collators and fabric tackboards to personalize your workspace and fulfill all your storage and organizational requirements.

Above, and left: Zira executive suite shown in Storm Grey (SOG) / Constellation Latte (CSL) with CF edging, frosted glazed doors / Silver frames (Z1) and square edge Silver HV handles. Global Accord seating shown in Softhide, White Sand (SO45).



Zira™



EDGE DETAILS



1" with 3mm edge (A3)



1" with bicut edge (AR)



1 ½" with 3mm edge (C3)



1 ½" with bicut edge (CR)



1 ½" with fluted edge (CF)

HANDLE OPTIONS



Square Edge Silver (HV)



Square Edge Black (HU)



Dimpled Nickel (HZ)



Flared Silver (HS)



Flared Black (HX)



Flared Brass (HW)



Bar Silver (HQ)



Bar Black (HR)



Crescent Black (HO)

Above: Zira shown in Dark Espresso (DES) and Willow Grey (WGY).



Global - Canada, The Global Group
1350 Flint Rd., Downsview ON Canada M3J 2J7
Sales & Marketing: Tel (1-877) 446-2251
Customer Service: Fax (800) 361-3182
Government Customer Service: Fax (416) 739-6319

Global - U.S.A.
17 West Stow Road P.O. Box 562
Marlton New Jersey U.S.A. 08053
Tel (856) 596-3390 (800) 220-1900
Fax (856) 596-5684

Global - International
560 Supertest Road Downsview
Ontario Canada M3J 2M6
Tel (416) 661-3660 (800) 668-5870
Fax (416) 667-1821

GGI Office Furniture (UK) Ltd.
Global Way Darwen
Lancashire UK BB3 0RW
Tel +44(0) 1254 778500
Fax +44(0) 1254 778519



Visit us on the World Wide Web at www.globaltotaloffice.com Offices throughout Canada, United States, United Kingdom, France, Australia and Brazil. Distribution around the world. A member of the Global Group. © 2011 ©™ Trade-Marks of GLOBAL TOTAL OFFICE. These products may be covered by one or more issued patents or pending patent applications in Canada, the U.S. and elsewhere. All intellectual property rights in applicable trademarks, patents and industrial designs are strictly reserved. Made in Canada. Specifications are correct at time of printing. Printed in Canada. Creative / Global Group Design Center 250311 10.0086



SAVOIR™

The tradition and warmth of wood



classic and
contemporary

WOOD ARMCHAIRS



Comet™

Contemporary reception seating



Versatile



2171
2172
2175
2178
2179

Comet™

Comet is a contemporary general use reception/meeting chair. Its powder coat epoxy finished tubular frame and padded seat cushions combine comfort with long lasting durability.

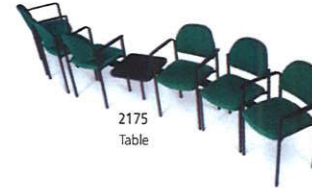

2175
Table



2171
Nesting Armchair

Specifications

DESCRIPTION

DIMENSIONS

SEAT HEIGHT

W	D	H		
IN	IN	IN	IN	IN
mm	mm	mm	mm	mm



Nesting Armchair
Comet™ 7
 2191 - As above, upholstered in Leather

23	22	32½	18½	
584	559	825	470	



Armless Nesting Chair
Comet™ 7
 2192 - As above, upholstered in Leather

19	22	32½	18½	
483	559	825	470	



Square Corner/Straight Table with Mono Leg
 2176 - Special ganging bracket to join armchairs, sidechairs and tables

18	18	17½		
457	457	445		



Radius Corner Table with Mono Leg

18	18	17½		
457	457	445		



Crescent Corner Table with Two Legs

30	30	17½		
762	762	445		

Global - Canada
 560 Superstest Road Downsview
 Ontario Canada M3J 2M6 Tel (416) 661-3660
 Dealer Customer Service: Fax (416) 736-6685
 Government Customer Service: Fax (416) 739-6319

Global - U.S.A.
 17 West Slow Road P.O. Box 562
 Marlton New Jersey U.S.A. 08053
 Tel (856) 596-3390 (800) 220-1900
 Fax (856) 596-5684

Global - International
 560 Superstest Road Downsview
 Ontario Canada M3J 2M6
 Tel (416) 661-3660
 Fax (416) 667-1821

G.G.I. Office Furniture (UK) Ltd.
 Global Way, Darwen,
 Lancashire BB3 0RW, UK
 Tel +44(0) 1254 778500
 Fax +44(0) 1254 778519

Visit us on the World Wide Web at www.globaltotaloffice.com

Offices throughout Canada, United States, United Kingdom, France and Australia. Distribution around the world. A member of the Global Group.

© 2006 B. *Trade Shows & Exhibitions: These products are not intended for use in any other country without the express permission of Global Total Office Furniture Ltd. All rights reserved. Printed in Canada. Global Total Office Furniture Ltd. 03/06/06

united chair[®]
A GROUPE LACASSE BRAND

Executive /
Management



Brylee

SINGULAR ELEGANCE.
UNIFIED DESIGN.
DISTINCTIVE FORM.





For the counter, the lab or the lounge, Brylee has a stool design featuring a 2:1 synchronous tilt control - 2° of back recline to a 1° of seat recline - for maximum user comfort.

Style & comfort combined with selection & value.

The proven ergonomic classic covers every office application.



BR32 - Momentum Max MX03 Coquilt ganged with BRT-AG connectors



BR32C - Momentum Max MX03 Coquilt



BR31 - SilverLex Vinyl SL12 Stunkel

The guest chair is as "comfortable" in the lobby as it is in a private office, conference setting or break room. Brylee guest seating can be stackable for storage in the wall saver leg version. A caster version to compliment your interior choices.

For further information, please visit:
www.grounelacasse.com



BR16 - Acella AE16 Cadet

A complete family of classic seating choices of extraordinary value. Choice of full size or compact models featuring a contoured lumbar support, comfort-sensitive synchro-tilt, two-position back lock and waterfall seat design.



BR32H - Maharam Medium MD003 Alloy

Café height stools deliver simple, uncluttered and contemporary style seating solutions. High seat with long and slim post legs along with an integrated footrest.

Brylee

Executive / Management

PROFILE

- / Management, guest and stool seating models
- / Fixed arms with upholstery and adjustment options. Armless option also available
- / Synchronous tilt seat mechanism for smooth ride
- / Contoured backrest features an integrated lumbar support
- / Plastic back panel or upholstered option available

- / Nylon, steel, or polished chrome base options
- / Guest wall saver leg model stacks 6 high. Available sled base or straight leg with casters
- / Stool features a 360 degree chrome footring and a variety of arm and upholstery options
- / Café height stools with or without arms are also available

	inches mm	SEAT			BACK		OVERALL			BETWEEN ARMS
		HEIGHT	WIDTH	DEPTH	HEIGHT	WIDTH	HEIGHT	WIDTH	DEPTH	
Management chair with arms	BR16	17 ¹ / ₂ - 22 ¹ / ₂ 444 - 571	20 ¹ / ₂ 521	16 ¹ / ₂ 419	19 ¹ / ₂ 495	19 ¹ / ₂ 495	36 ¹ / ₄ - 41 ¹ / ₄ 920 - 1047	25 635	25 635	21 ¹ / ₂ 546
Management chair without arms	BR15	17 ¹ / ₂ - 22 ¹ / ₂ 444 - 571	20 ¹ / ₂ 521	16 ¹ / ₂ 419	19 ¹ / ₂ 495	19 ¹ / ₂ 495	36 ¹ / ₄ - 41 ¹ / ₄ 920 - 1047	23 ¹ / ₂ 597	25 635	NA NA
Compact management chair with arms	BR11	17 ¹ / ₂ - 22 ¹ / ₂ 444 - 571	18 ¹ / ₂ 470	15 ¹ / ₂ 394	18 ¹ / ₂ 470	17 ¹ / ₂ 445	35 ¹ / ₄ - 40 ¹ / ₄ 895 - 1022	23 ¹ / ₂ 597	23 ¹ / ₂ 597	19 ¹ / ₂ 495
Compact management chair without arms	BR10	17 ¹ / ₂ - 22 ¹ / ₂ 444 - 571	18 ¹ / ₂ 470	15 ¹ / ₂ 394	18 ¹ / ₂ 470	17 ¹ / ₂ 445	35 ¹ / ₄ - 40 ¹ / ₄ 895 - 1022	23 ¹ / ₂ 597	23 ¹ / ₂ 597	NA NA
Wall saver guest chair with arms	BR32	17 ³ / ₄ 451	18 ¹ / ₂ 470	18 457	14 ¹ / ₂ 368	19 483	32 ³ / ₄ 832	24 ³ / ₄ 629	23 584	19 483
Wall saver guest chair without arms	BR31	17 ³ / ₄ 451	18 ¹ / ₂ 470	18 457	14 ¹ / ₂ 368	19 483	32 ³ / ₄ 832	21 553	23 584	NA NA
Guest chair with arms and casters	BR32C	17 ³ / ₄ 451	18 ¹ / ₂ 470	18 457	14 ¹ / ₂ 368	19 483	32 ³ / ₄ 832	24 ³ / ₄ 629	23 584	19 483
Sled base guest chair with arms	BR32S	18 ¹ / ₄ 464	18 ¹ / ₂ 470	18 457	14 ¹ / ₂ 368	19 483	33 ¹ / ₄ 845	24 ³ / ₄ 629	23 584	19 483
Sled base guest chair without arms	BR31S	18 ¹ / ₄ 464	18 ¹ / ₂ 470	18 457	14 ¹ / ₂ 368	19 483	33 ¹ / ₄ 845	21 533	23 584	NA NA
Stool with arms	BR51	23 ¹ / ₂ - 29 ¹ / ₂ 596 - 749	18 ¹ / ₂ 470	15 ¹ / ₂ 394	17 ¹ / ₂ 445	17 ¹ / ₂ 445	41 ¹ / ₄ - 46 ¹ / ₄ 1047 - 1174	23 ¹ / ₂ 597	23 ¹ / ₂ 597	19 ¹ / ₂ 495
Stool without arms	BR52	23 ¹ / ₂ - 29 ¹ / ₂ 596 - 749	18 ¹ / ₂ 470	15 ¹ / ₂ 394	17 ¹ / ₂ 445	17 ¹ / ₂ 445	41 ¹ / ₄ - 46 ¹ / ₄ 1047 - 1174	23 ¹ / ₂ 597	23 ¹ / ₂ 597	NA NA
Café height stool with arms	BR32H	31 ³ / ₄ 807	18 ¹ / ₂ 470	18 457	14 ¹ / ₂ 368	19 483	47 ³ / ₄ 1214	25 ¹ / ₄ 642	24 610	19 ¹ / ₄ 489
Café height stool without arms	BR31H	31 ³ / ₄ 807	18 ¹ / ₂ 470	18 457	14 ¹ / ₂ 368	19 483	47 ³ / ₄ 1214	21 533	24 610	NA NA



2:1 Synchronous tilt mechanism



Urethane arm



Optional chrome base



Printed in Canada



United Chair® products are GREENGUARD® Indoor Air Quality and Children and Schools certified. United Chair® products comply with ANSI/BIFMA X5.1-2002 and ISO 14001:1996 standards. Information contained herein is subject to change without notice.



UNITED CHAIR® IS A PROUD MEMBER OF GROUPE LACASSE

1.888.522.2773
www.groupelacasse.com

3610
U105-4
11/12
17M

HON®

H4041 High Density H4041FC Olson Stacker Technical Specifications

Polymer
Seat and Back,
7/16" Steel
Rod Frame,
Chrome Legs

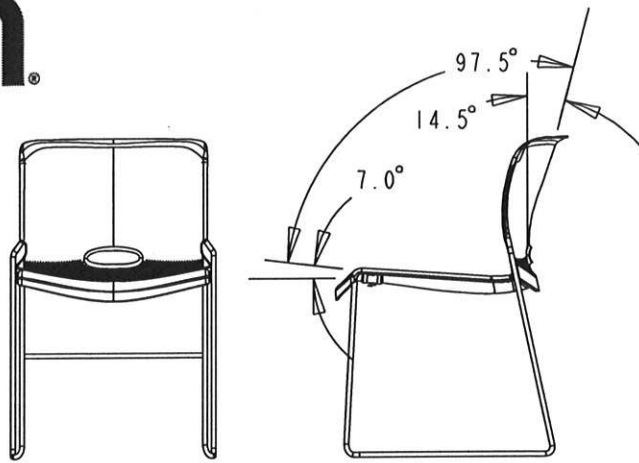

KEY DIMENSIONS

Max. Width.....	19-1/8"
Max. Depth.....	21-5/8"
Max. Height.....	30-5/8"
Seat Size	
Width.....	17-3/4"
Usable Depth.....	17"
Height from Floor.....	17-3/4"
Back Size	
Width.....	17-1/2"
Height from Seat.....	16-1/4"

Back Lumbar

Height.....	10-3/4"
Stack Size	
On Cart (H4043)	
Number of Chairs.....	40
On Floor	
Number of Chairs.....	12

CONSTRUCTION

Glide..... Frosted polycarbonate available in Glide packs Model H4048 Ganging and H4049 Non-ganging.

Frame..... Chrome 7/16" diameter steel wire.

Seat..... 1/8" thick texted polymer.

Back..... 1/8" thick texted polymer.

Chair Weight..... 12.5 pounds per chair.

Shipping Weight... 57 pounds. (4 pack)

Shipped..... Completely assembled, (4) per carton.

Shipping Size..... 26" wide x 20-1/2" deep x 34-1/2" high (10.6 cubic feet).

Flammability

Rating..... Furnished upon request by The HON Company Customer Service. Model H4041 meets the State of California Department of Consumer Affairs Technical Bulletin 117 requirements. Model H4041FC meets the State of California Department of Consumer Affairs Technical Bulletin 133 requirements.

Note..... All measurements are per BIFMA/CMD procedures.

©2011 The HON Company
H4010 (01/11)
HON is a registered trademark
of HNI Technologies, under license
to The HON Company.

HON®

The HON Company
200 Oak Street
Muscatine, IA 52761

customerservice@askhon.com
800-833-3964
www.hon.com

VENDOR PREFERENCE CERTIFICATE

Certification and application* is hereby made for Preference in accordance with **West Virginia Code**, §5A-3-37. (Does not apply to construction contracts). **West Virginia Code**, §5A-3-37, provides an opportunity for qualifying vendors to request (at the time of bid) preference for their residency status. Such preference is an evaluation method only and will be applied only to the cost bid in accordance with the **West Virginia Code**. This certificate for application is to be used to request such preference. The Purchasing Division will make the determination of the Resident Vendor Preference, if applicable.

1. Application is made for 2.5% resident vendor preference for the reason checked:

Bidder is an individual resident vendor and has resided continuously in West Virginia for four (4) years immediately preceding the date of this certification; **or**,

Bidder is a partnership, association or corporation resident vendor and has maintained its headquarters or principal place of business continuously in West Virginia for four (4) years immediately preceding the date of this certification; or 80% of the ownership interest of Bidder is held by another individual, partnership, association or corporation resident vendor who has maintained its headquarters or principal place of business continuously in West Virginia for four (4) years immediately preceding the date of this certification; **or**,

Bidder is a nonresident vendor which has an affiliate or subsidiary which employs a minimum of one hundred state residents and which has maintained its headquarters or principal place of business within West Virginia continuously for the four (4) years immediately preceding the date of this certification; **or**,

2. Application is made for 2.5% resident vendor preference for the reason checked:

Bidder is a resident vendor who certifies that, during the life of the contract, on average at least 75% of the employees working on the project being bid are residents of West Virginia who have resided in the state continuously for the two years immediately preceding submission of this bid; **or**,

3. Application is made for 2.5% resident vendor preference for the reason checked:

Bidder is a nonresident vendor employing a minimum of one hundred state residents or is a nonresident vendor with an affiliate or subsidiary which maintains its headquarters or principal place of business within West Virginia employing a minimum of one hundred state residents who certifies that, during the life of the contract, on average at least 75% of the employees or Bidder's affiliate's or subsidiary's employees are residents of West Virginia who have resided in the state continuously for the two years immediately preceding submission of this bid; **or**,

4. Application is made for 5% resident vendor preference for the reason checked:

Bidder meets either the requirement of both subdivisions (1) and (2) or subdivision (1) and (3) as stated above; **or**,

5. Application is made for 3.5% resident vendor preference who is a veteran for the reason checked:

Bidder is an individual resident vendor who is a veteran of the United States armed forces, the reserves or the National Guard and has resided in West Virginia continuously for the four years immediately preceding the date on which the bid is submitted; **or**,

6. Application is made for 3.5% resident vendor preference who is a veteran for the reason checked:

Bidder is a resident vendor who is a veteran of the United States armed forces, the reserves or the National Guard, if, for purposes of producing or distributing the commodities or completing the project which is the subject of the vendor's bid and continuously over the entire term of the project, on average at least seventy-five percent of the vendor's employees are residents of West Virginia who have resided in the state continuously for the two immediately preceding years.

7. Application is made for preference as a non-resident small, women- and minority-owned business, in accordance with West Virginia Code §5A-3-59 and West Virginia Code of State Rules.

Bidder has been or expects to be approved prior to contract award by the Purchasing Division as a certified small, women- and minority-owned business.

Bidder understands if the Secretary of Revenue determines that a Bidder receiving preference has failed to continue to meet the requirements for such preference, the Secretary may order the Director of Purchasing to: (a) reject the bid; or (b) assess a penalty against such Bidder in an amount not to exceed 5% of the bid amount and that such penalty will be paid to the contracting agency or deducted from any unpaid balance on the contract or purchase order.

By submission of this certificate, Bidder agrees to disclose any reasonably requested information to the Purchasing Division and authorizes the Department of Revenue to disclose to the Director of Purchasing appropriate information verifying that Bidder has paid the required business taxes, provided that such information does not contain the amounts of taxes paid nor any other information deemed by the Tax Commissioner to be confidential.

Under penalty of law for false swearing (West Virginia Code, §61-5-3), Bidder hereby certifies that this certificate is true and accurate in all respects; and that if a contract is issued to Bidder and if anything contained within this certificate changes during the term of the contract, Bidder will notify the Purchasing Division in writing immediately.

Bidder: Capital Business Int.

Signed: Kelli D. Prays

Date: 6/12/13

Title: Sales Mgr

RFQ No. BCF13138

STATE OF WEST VIRGINIA
Purchasing Division

PURCHASING AFFIDAVIT

MANDATE: Under W. Va. Code §5A-3-10a, no contract or renewal of any contract may be awarded by the state or any of its political subdivisions to any vendor or prospective vendor when the vendor or prospective vendor or a related party to the vendor or prospective vendor is a debtor and: (1) the debt owed is an amount greater than one thousand dollars in the aggregate; or (2) the debtor is in employer default.

EXCEPTION: The prohibition listed above does not apply where a vendor has contested any tax administered pursuant to chapter eleven of the W. Va. Code, workers' compensation premium, permit fee or environmental fee or assessment and the matter has not become final or where the vendor has entered into a payment plan or agreement and the vendor is not in default of any of the provisions of such plan or agreement.

DEFINITIONS:

"Debt" means any assessment, premium, penalty, fine, tax or other amount of money owed to the state or any of its political subdivisions because of a judgment, fine, permit violation, license assessment, defaulted workers' compensation premium, penalty or other assessment presently delinquent or due and required to be paid to the state or any of its political subdivisions, including any interest or additional penalties accrued thereon.

"Employer default" means having an outstanding balance or liability to the old fund or to the uninsured employers' fund or being in policy default, as defined in W. Va. Code § 23-2c-2, failure to maintain mandatory workers' compensation coverage, or failure to fully meet its obligations as a workers' compensation self-insured employer. An employer is not in employer default if it has entered into a repayment agreement with the Insurance Commissioner and remains in compliance with the obligations under the repayment agreement.

"Related party" means a party, whether an individual, corporation, partnership, association, limited liability company or any other form or business association or other entity whatsoever, related to any vendor by blood, marriage, ownership or contract through which the party has a relationship of ownership or other interest with the vendor so that the party will actually or by effect receive or control a portion of the benefit, profit or other consideration from performance of a vendor contract with the party receiving an amount that meets or exceeds five percent of the total contract amount.

AFFIRMATION: By signing this form, the vendor's authorized signer affirms and acknowledges under penalty of law for false swearing (W. Va. Code §61-5-3) that neither vendor nor any related party owe a debt as defined above and that neither vendor nor any related party are in employer default as defined above, unless the debt or employer default is permitted under the exception above.

WITNESS THE FOLLOWING SIGNATURE:

Vendor's Name: Capitol Business Interiors

Authorized Signature: [Signature] Date: 6/12/13

State of West Virginia

County of Kanawha, to-wit:

Taken, subscribed, and sworn to before me this 12th day of June, 2013.

My Commission expires August 11, 2019.

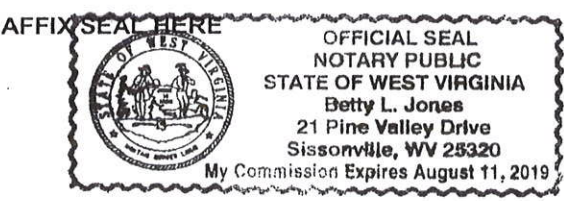

NOTARY PUBLIC [Signature]
Purchasing Affidavit (Revised 07/01/2012)

CERTIFICATION AND SIGNATURE PAGE

By signing below, I certify that I have reviewed this Solicitation in its entirety; understand the requirements, terms and conditions, and other information contained herein; that I am submitting this bid or proposal for review and consideration; that I am authorized by the bidder to execute this bid or any documents related thereto on bidder's behalf; that I am authorized to bind the bidder in a contractual relationship; and that to the best of my knowledge, the bidder has properly registered with any State agency that may require registration.

Capitol Business Interiors
 (Company)

Kelli D. Bragg
 (Authorized Signature)

Kelli Bragg, Capitol Business Interiors
 (Representative Name, Title)

304.343.7551 304.346.3350
 (Phone Number) (Fax Number)

6/12/13
 (Date)

ADDENDUM ACKNOWLEDGEMENT FORM
SOLICITATION NO.: BCF13138

Instructions: Please acknowledge receipt of all addenda issued with this solicitation by completing this addendum acknowledgment form. Check the box next to each addendum received and sign below. Failure to acknowledge addenda may result in bid disqualification.

Acknowledgment: I hereby acknowledge receipt of the following addenda and have made the necessary revisions to my proposal, plans and/or specification, etc.

Addendum Numbers Received:

(Check the box next to each addendum received)

- | | |
|--|--|
| <input checked="" type="checkbox"/> Addendum No. 1 | <input type="checkbox"/> Addendum No. 6 |
| <input type="checkbox"/> Addendum No. 2 | <input type="checkbox"/> Addendum No. 7 |
| <input type="checkbox"/> Addendum No. 3 | <input type="checkbox"/> Addendum No. 8 |
| <input type="checkbox"/> Addendum No. 4 | <input type="checkbox"/> Addendum No. 9 |
| <input type="checkbox"/> Addendum No. 5 | <input type="checkbox"/> Addendum No. 10 |

I understand that failure to confirm the receipt of addenda may be cause for rejection of this bid. I further understand that any verbal representation made or assumed to be made during any oral discussion held between Vendor's representatives and any state personnel is not binding. Only the information issued in writing and added to the specifications by an official addendum is binding.

Capitol Business Interiors
Company

Kelli D. Bragg
Authorized Signature

6/12/13
Date