



State of West Virginia
 Department of Administration
 Purchasing Division
 2019 Washington Street East
 Post Office Box 50130
 Charleston, WV 25305-0130

Solicitation

NUMBER
BCF13129

PAGE
1

ADDRESS CORRESPONDENCE TO ATTENTION OF
ROBERTA WAGNER 304-558-0067

VENDOR	*709040519 304-343-7551
	CAPITOL BUSINESS INTERIORS
	711 INDIANA AVE
	CHARLESTON WV 25302

SHIP TO	HEALTH AND HUMAN RESOURCES
	VARIOUS LOCATIONS
	AS INDICATED BELOW
	06/19/13 12:54:06 PM West Virginia Purchasing Division

DATE PRINTED
05/21/2013

BID OPENING DATE: 06/13/2013 BID OPENING TIME: 1:30PM

LINE	QUANTITY	UOP	CAT NO	ITEM NUMBER	UNIT PRICE	AMOUNT
0001	9	EA		425-94		56,098.54
<p>REQUEST FOR QUOTATION (RFQ)</p> <p>THE WEST VIRGINIA STATE PURCHASING DIVISION FOR THE AGENCY, THE WEST VIRGINIA DEPARTMENT OF HEALTH AND HUMAN RESOURCES BUREAU OF CHILDREN AND FAMILIES, IS SOLICITING BIDS TO PROVIDE THE AGENCY WITH THE PURCHASE AND INSTALLATION OF MODULAR OFFICE FURNITURE IN THEIR DODDRIDGE COUNTY DHHR OFFICE LOCATED AT 22 HERBERT AVENUE IN WEST UNION, WEST VIRGINIA PER THE ATTACHED SPECIFICATIONS.</p>						
<p>SECTION 3.2.1 - WORKSTATIONS (9)</p> <p>WORKSTATIONS 6'X7' 62"H (+/-5") ALL PANELS ARE ACOUSTICAL, MONOLITHIC, 2" THICKNESS AND SOLID CORE, NO FRAME OR TILE PANELS WILL BE ACCEPTED. ALL PANELS SHALL BE POWERED SO THAT EACH WORKSTATION HAS THREE (3) DUPLEX OUTLETS PER STATION, NO POWER STRIPS WILL BE ACCEPTED.</p> <p>*ELIMINATE TWO (2) PANELS ALONG SERVER ROOM 3 WALL*</p> <p>**PLEASE NOTE THE SERVICE WINDOW, ONE 60" PANEL WILL NEED TO BE 32" HIGH.**</p> <p>***ALL WORKSTATIONS SHOULD HAVE WING PANELS. SEE DRAWING FOR SIZE.***</p>						

SIGNATURE <i>Belli D. Mass</i>	TELEPHONE 304.343.7551	DATE 6/19/13
TITLE <i>Sales Mgr</i>	FEIN 55-0422766	ADDRESS CHANGES TO BE NOTED ABOVE

WHEN RESPONDING TO SOLICITATION, INSERT NAME AND ADDRESS IN SPACE ABOVE LABELED 'VENDOR'



State of West Virginia
 Department of Administration
 Purchasing Division
 2019 Washington Street East
 Post Office Box 50130
 Charleston, WV 25305-0130

Solicitation

NUMBER
BCF13129

PAGE
24

ADDRESS CORRESPONDENCE TO ATTENTION OF:
ROBERTA WAGNER 304-558-0067

VENDOR

*709040519 304-343-7551
 CAPITOL BUSINESS INTERIORS
 711 INDIANA AVE
 CHARLESTON WV 25302

SHIP TO

HEALTH AND HUMAN RESOURCES
 VARIOUS LOCATIONS
 AS INDICATED BELOW

DATE PRINTED
05/21/2013

BID OPENING DATE: 06/13/2013 BID OPENING TIME 1:30PM

LINE	QUANTITY	UOP	CAT. NO.	ITEM NUMBER	UNIT PRICE	AMOUNT
***** THIS IS THE END OF RFQ BCF13129 ***** TOTAL:						<u>54,098.54</u>

SIGNATURE <i>Kelli D. Mays</i>	TELEPHONE 304.343.7551	DATE 6/19/13
TITLE <i>Sales Mgr.</i>	FEIN 55-0422760	ADDRESS CHANGES TO BE NOTED ABOVE

WHEN RESPONDING TO SOLICITATION, INSERT NAME AND ADDRESS IN SPACE ABOVE LABELED 'VENDOR'

RFQ No. _____

STATE OF WEST VIRGINIA
Purchasing Division

PURCHASING AFFIDAVIT

MANDATE: Under W. Va. Code §5A-3-10a, no contract or renewal of any contract may be awarded by the state or any of its political subdivisions to any vendor or prospective vendor when the vendor or prospective vendor or a related party to the vendor or prospective vendor is a debtor and: (1) the debt owed is an amount greater than one thousand dollars in the aggregate; or (2) the debtor is in employer default.

EXCEPTION: The prohibition listed above does not apply where a vendor has contested any tax administered pursuant to chapter eleven of the W. Va. Code, workers' compensation premium, permit fee or environmental fee or assessment and the matter has not become final or where the vendor has entered into a payment plan or agreement and the vendor is not in default of any of the provisions of such plan or agreement.

DEFINITIONS:

"Debt" means any assessment, premium, penalty, fine, tax or other amount of money owed to the state or any of its political subdivisions because of a judgment, fine, permit violation, license assessment, defaulted workers' compensation premium, penalty or other assessment presently delinquent or due and required to be paid to the state or any of its political subdivisions, including any interest or additional penalties accrued thereon.

"Employer default" means having an outstanding balance or liability to the old fund or to the uninsured employers' fund or being in policy default, as defined in W. Va. Code § 23-2c-2, failure to maintain mandatory workers' compensation coverage, or failure to fully meet its obligations as a workers' compensation self-insured employer. An employer is not in employer default if it has entered into a repayment agreement with the Insurance Commissioner and remains in compliance with the obligations under the repayment agreement.

"Related party" means a party, whether an individual, corporation, partnership, association, limited liability company or any other form or business association or other entity whatsoever, related to any vendor by blood, marriage, ownership or contract through which the party has a relationship of ownership or other interest with the vendor so that the party will actually or by effect receive or control a portion of the benefit, profit or other consideration from performance of a vendor contract with the party receiving an amount that meets or exceeds five percent of the total contract amount.

AFFIRMATION: By signing this form, the vendor's authorized signer affirms and acknowledges under penalty of law for false swearing (W. Va. Code §61-5-3) that neither vendor nor any related party owe a debt as defined above and that neither vendor nor any related party are in employer default as defined above, unless the debt or employer default is permitted under the exception above.

WITNESS THE FOLLOWING SIGNATURE:

Vendor's Name: Capitol Business Interiors

Authorized Signature: Kelli D. Mass Date: 6/19/13

State of West Virginia

County of Kanawha, to-wit:

Taken, subscribed, and sworn to before me this 19 day of June, 2013.

My Commission expires August 11, 2019.

AFFIX SEAL HERE

NOTARY PUBLIC Betty L. Jones
Purchasing Affidavit (Revised 07/01/2012)



VENDOR PREFERENCE CERTIFICATE

Certification and application* is hereby made for Preference in accordance with *West Virginia Code*, §5A-3-37. (Does not apply to construction contracts). *West Virginia Code*, §5A-3-37, provides an opportunity for qualifying vendors to request (at the time of bid) preference for their residency status. Such preference is an evaluation method only and will be applied only to the cost bid in accordance with the *West Virginia Code*. This certificate for application is to be used to request such preference. The Purchasing Division will make the determination of the Resident Vendor Preference, if applicable.

1. Application is made for 2.5% resident vendor preference for the reason checked:

- Bidder is an individual resident vendor and has resided continuously in West Virginia for four (4) years immediately preceding the date of this certification; or,
- Bidder is a partnership, association or corporation resident vendor and has maintained its headquarters or principal place of business continuously in West Virginia for four (4) years immediately preceding the date of this certification; or 80% of the ownership interest of Bidder is held by another individual, partnership, association or corporation resident vendor who has maintained its headquarters or principal place of business continuously in West Virginia for four (4) years immediately preceding the date of this certification; or,
- Bidder is a nonresident vendor which has an affiliate or subsidiary which employs a minimum of one hundred state residents and which has maintained its headquarters or principal place of business within West Virginia continuously for the four (4) years immediately preceding the date of this certification; or,

2. Application is made for 2.5% resident vendor preference for the reason checked:

- Bidder is a resident vendor who certifies that, during the life of the contract, on average at least 75% of the employees working on the project being bid are residents of West Virginia who have resided in the state continuously for the two years immediately preceding submission of this bid; or,

3. Application is made for 2.5% resident vendor preference for the reason checked:

- Bidder is a nonresident vendor employing a minimum of one hundred state residents or is a nonresident vendor with an affiliate or subsidiary which maintains its headquarters or principal place of business within West Virginia employing a minimum of one hundred state residents who certifies that, during the life of the contract, on average at least 75% of the employees or Bidder's affiliate's or subsidiary's employees are residents of West Virginia who have resided in the state continuously for the two years immediately preceding submission of this bid; or,

Application is made for 5% resident vendor preference for the reason checked:

- Bidder meets either the requirement of both subdivisions (1) and (2) or subdivision (1) and (3) as stated above; or,

5. Application is made for 3.5% resident vendor preference who is a veteran for the reason checked:

- Bidder is an individual resident vendor who is a veteran of the United States armed forces, the reserves or the National Guard and has resided in West Virginia continuously for the four years immediately preceding the date on which the bid is submitted; or,

6. Application is made for 3.5% resident vendor preference who is a veteran for the reason checked:

- Bidder is a resident vendor who is a veteran of the United States armed forces, the reserves or the National Guard, if, for purposes of producing or distributing the commodities or completing the project which is the subject of the vendor's bid and continuously over the entire term of the project, on average at least seventy-five percent of the vendor's employees are residents of West Virginia who have resided in the state continuously for the two immediately preceding years.

7. Application is made for preference as a non-resident small, women- and minority-owned business, in accordance with *West Virginia Code* §5A-3-59 and *West Virginia Code of State Rules*.

- Bidder has been or expects to be approved prior to contract award by the Purchasing Division as a certified small, women- and minority-owned business.

Bidder understands if the Secretary of Revenue determines that a Bidder receiving preference has failed to continue to meet the requirements for such preference, the Secretary may order the Director of Purchasing to: (a) reject the bid; or (b) assess a penalty against such Bidder in an amount not to exceed 5% of the bid amount and that such penalty will be paid to the contracting agency or deducted from any unpaid balance on the contract or purchase order.

By submission of this certificate, Bidder agrees to disclose any reasonably requested information to the Purchasing Division and authorizes the Department of Revenue to disclose to the Director of Purchasing appropriate information verifying that Bidder has paid the required business taxes, provided that such information does not contain the amounts of taxes paid nor any other information deemed by the Tax Commissioner to be confidential.

Under penalty of law for false swearing (*West Virginia Code*, §61-5-3), Bidder hereby certifies that this certificate is true and accurate in all respects; and that if a contract is issued to Bidder and if anything contained within this certificate changes during the term of the contract, Bidder will notify the Purchasing Division in writing immediately.

Bidder: Capitol Business Interiors.

Signed: Kelli D. Prange

Date: 6/19/13.

Title: Sales Mgr.

CERTIFICATION AND SIGNATURE PAGE

By signing below, I certify that I have reviewed this Solicitation in its entirety; understand the requirements, terms and conditions, and other information contained herein; that I am submitting this bid or proposal for review and consideration; that I am authorized by the bidder to execute this bid or any documents related thereto on bidder's behalf; that I am authorized to bind the bidder in a contractual relationship; and that to the best of my knowledge, the bidder has properly registered with any State agency that may require registration.

Capitol Business Interiors
(Company)

Kelli D. Braga
(Authorized Signature)

Kelli Braga, Sales Mgr.
(Representative Name, Title)

304.343.7551 304.346.3350
(Phone Number) (Fax Number)

6/19/13.
(Date)



State of West Virginia
 Department of Administration
 Purchasing Division
 2019 Washington Street East
 Post Office Box 50130
 Charleston, WV 25305-0130

Solicitation

NUMBER
BCF13129

PAGE
1

ADDRESS CORRESPONDENCE TO ATTENTION OF:
ROBERTA WAGNER 304-558-0067

VENDOR

*709040519 304-343-7551
 CAPITOL BUSINESS INTERIORS
 711 INDIANA AVE
 CHARLESTON WV 25302

SHIP TO

HEALTH AND HUMAN RESOURCES
 VARIOUS LOCATIONS
 AS INDICATED BELOW

DATE PRINTED
06/04/2013

BID OPENING DATE: 06/13/2013 BID OPENING TIME 1:30PM

LINE	QUANTITY	UOP	CAT. NO.	ITEM NUMBER	UNIT PRICE	AMOUNT
ADDENDUM NO. 1						
ADDENDUM ISSUED:						
1. TO ADDRESS CHANGES MADE TO THE SPECIFICATIONS.						
2. TO PROVIDE VENDORS A COPY OF THE MANDATORY PRE-BID MEETING SIGN-IN SHEET. SPECIFICATION CHANGES AND PRE-BID SIGN-IN SHEETS ARE ATTACHED.						
3. TO PROVIDE ADDENDUM ACKNOWLEDGEMENT. THIS DOCUMENT SHOULD BE SIGNED AND RETURNED WITH YOUR BID. FAILURE TO SIGN AND RETURN MAY RESULT IN THE DISQUALIFICATION OF YOUR BID.						
***** END OF ADDENDUM NO. 1 *****						

SIGNATURE <i>Kelli D. Barnes</i>	TELEPHONE 304-343-7551	DATE 6/19/13
TITLE <i>Sales Mgr</i>	FEIN 55-0422766	ADDRESS CHANGES TO BE NOTED ABOVE

WHEN RESPONDING TO SOLICITATION, INSERT NAME AND ADDRESS IN SPACE ABOVE LABELED 'VENDOR'



State of West Virginia
 Department of Administration
 Purchasing Division
 2019 Washington Street East
 Post Office Box 50130
 Charleston, WV 25305-0130

Solicitation

NUMBER
BCF13129

PAGE
18

ADDRESS CORRESPONDENCE TO ATTENTION OF:
ROBERTA WAGNER 304-558-0067

VENDOR
*709040519 304-343-7551 CAPITOL BUSINESS INTERIORS 711 INDIANA AVE CHARLESTON WV 25302

SHIP TO
HEALTH AND HUMAN RESOURCES VARIOUS LOCATIONS AS INDICATED BELOW

DATE PRINTED
06/04/2013

BID OPENING DATE: 06/13/2013 BID OPENING TIME 1:30PM

LINE	QUANTITY	UOP	CAT. NO.	ITEM NUMBER	UNIT PRICE	AMOUNT
0081	1	EA		425-94 LOUNGE CHAIRS, NO MORE THAN 32"W, WITH ARMS		
0082	2	EA		425-94 CHAIRS; MOLDED POLY SHELL, NO UPHOLSTERY METAL		
0083	4	EA		425-94 SECTION 3.2.13 STORAGE ROOM TO CONTAIN - ROOM 5		
***** THIS IS THE END OF RFQ BCF13129 ***** TOTAL:						<u>56,098.54</u>

SIGNATURE <i>Kenn D. Magee</i>	TELEPHONE 304.343.7551	DATE 6/19/13
TITLE <i>Sales Mgr.</i>	FEIN 55-0422766	ADDRESS CHANGES TO BE NOTED ABOVE

WHEN RESPONDING TO SOLICITATION, INSERT NAME AND ADDRESS IN SPACE ABOVE LABELED 'VENDOR'

ADDENDUM ACKNOWLEDGEMENT FORM
SOLICITATION NO.: BCF13129

Instructions: Please acknowledge receipt of all addenda issued with this solicitation by completing this addendum acknowledgment form. Check the box next to each addendum received and sign below. Failure to acknowledge addenda may result in bid disqualification.

Acknowledgment: I hereby acknowledge receipt of the following addenda and have made the necessary revisions to my proposal, plans and/or specification, etc.

Addendum Numbers Received:

(Check the box next to each addendum received)

- | | |
|--|--|
| <input checked="" type="checkbox"/> Addendum No. 1 | <input type="checkbox"/> Addendum No. 6 |
| <input checked="" type="checkbox"/> Addendum No. 2 | <input type="checkbox"/> Addendum No. 7 |
| <input type="checkbox"/> Addendum No. 3 | <input type="checkbox"/> Addendum No. 8 |
| <input type="checkbox"/> Addendum No. 4 | <input type="checkbox"/> Addendum No. 9 |
| <input type="checkbox"/> Addendum No. 5 | <input type="checkbox"/> Addendum No. 10 |

I understand that failure to confirm the receipt of addenda may be cause for rejection of this bid. I further understand that any verbal representation made or assumed to be made during any oral discussion held between Vendor's representatives and any state personnel is not binding. Only the information issued in writing and added to the specifications by an official addendum is binding.

Capitol Business Interiors

Company

Kelli D. Payne

Authorized Signature

6/19/13

Date

NOTE: This addendum acknowledgement should be submitted with the bid to expedite document processing.
 Revised 6/8/2012



Department of Administration
 Purchasing Division
 2019 Washington Street East
 Post Office Box 50130
 Charleston, WV 25305-0130

WV PURCHASING AGENCY SECTION FAX 304-558-4115

Jun 11 2013 11:01am P001/022

BCF13129

1

ADDRESS CORRESPONDENCE TO ATTENTION OF:

ROBERTA WAGNER
 304-558-0067

VENDOR

RFQ COPY
 TYPE NAME/ADDRESS HERE

SHIP TO

HEALTH AND HUMAN RESOURCES
 VARIOUS LOCATIONS
 AS INDICATED BELOW

DATE PRINTED
 06/11/2013

BID OPENING DATE: 06/19/2013

BID OPENING TIME 1:30PM

LINE	QUANTITY	UOP	CAT. NO.	ITEM NUMBER	UNIT PRICE	AMOUNT
				ADDENDUM NO. 2		
				ADDENDUM IS ISSUED:		
				1. TO ADDRESS AND REMOVE SECTION 3.2 OF THE SPECIFICATION AS DEFINED IN THE ATTACHED DOCUMENTATION.		
				2. TO MOVE THE BID OPENING DATE;		
				FROM:		
				JUNE 13 2013 @ 1:30 P.M.		
				TO:		
				JUNE 19 2013 @ 1:30 P.M.		
				3. TO PROVIDE ADDENDUM ACKNOWLEDGEMENT THIS DOCUMENT SHOULD BE SIGNED AND RETURNED WITH YOUR BID. FAILURE TO SIGN AND RETURN MAY RESULT IN THE DISQUALIFICATION OF YOUR BID.		
				***** END OF ADDENDUM NO. 2 *****		

SIGNATURE: *Kelli D. Prange* TELEPHONE: 304.343.7531 DATE: 6/19/13
 TITLE: *Sales Mgr.* FEIN: 55-0422766 ADDRESS CHANGES TO BE NOTED ABOVE

WHEN RESPONDING TO SOLICITATION, INSERT NAME AND ADDRESS IN SPACE ABOVE LABELED 'VENDOR'



Department of Administration
 Purchasing Division
 2019 Washington Street East
 Post Office Box 50130
 Charleston, WV 25305-0130

WV PURCHASING ACA SECT Fax 304-558-4115

Jun 11 2013 11:04am P018/022

BCF13129

18

ADDRESS CORRESPONDENCE TO ATTENTION OF:

ROBERTA WAGNER
 304-558-0067

RFQ COPY

TYPE NAME/ADDRESS HERE

VENDOR

HEALTH AND HUMAN RESOURCES
 VARIOUS LOCATIONS
 AS INDICATED BELOW

SHIP TO

DATE PRINTED

06/11/2013

BID OPENING DATE:

06/19/2013

BID OPENING TIME

1:30PM

LINE	QUANTITY	UOP	CAT NO	ITEM NUMBER	UNIT PRICE	AMOUNT
0081	1	EA		425-94 LOUNGE CHAIRS, NO MORE THAN 32"W, WITH ARMS		
0082	2	EA		425-94 CHAIRS; MOLDED POLY SHELL, NO UPHOLSTERY METAL		
0083	4	EA		425-94 SECTION 3.2.13 STORAGE ROOM TO CONTAIN - ROOM 5		

***** THIS IS THE END OF RFQ BCF13129 ***** TOTAL: 56,098.94

SIGNATURE

Bill D. May

TELEPHONE

304.343.7551

DATE

6-19-13

TITLE

Sales Mgr

FEIN

55-0422766

ADDRESS CHANGES TO BE NOTED ABOVE

WHEN RESPONDING TO SOLICITATION, INSERT NAME AND ADDRESS IN SPACE ABOVE LABELED 'VENDOR'

BID SHEET

Release No.:

BCF13129

Project:

DHHR, Bureau for Children and Families, Doddridge County Office

Section:

Please complete the below pricing sheet to include with your bid. Vendors should complete a separate Bid Sheet for each Section defined in the Bid Request package. Vendors may add additional lines in each section as needed.

Please provide an electronic copy with your bid on a CD.
if you have any questions.

All items bid for this project MUST be a part of your bid response.

Section 3.2.1 - Workstations (9)

Workstations 6' x 7'

Description	QTY	MNFTR	Part No.	Catalog #	Page	Location/Rooms	Unit Price	EXT. Price
62" h (+/-5")	8	Haworth	E2MN-362-B	Haworth Unigroup Too		Workstations	\$166.05	\$ 1,328.40
All panels are acoustical, monolithic	9	Haworth	E2MN-462-B	Haworth Unigroup Too		Workstations	\$187.82	\$ 1,690.38
2" thickness and solid core,	23	Haworth	E2MP-362-B	Haworth Unigroup Too		Workstations	\$207.56	\$ 4,773.88
no frame or tile panels will be	1	Haworth	E2MP-462-B	Haworth Unigroup Too		Workstations	\$229.33	\$ 229.33
accepted. All panels shall be powered								
so that each workstation has 3 duplex outlets								
per station, no power strips will be accepted.								
Eliminate 2 panels along server room 3 wall								
***Please note the service window, one 60"								
panel will need to be 32" high.***								
***All workstations should have wing panels.								
See drawing for size.***								
Subtotal								\$ 8,021.99

Installation/Electrical Hardware/Misc for Panels

								Subtotal	\$ 1,906.47

Miscellaneous Items

Description	QTY	MNFTR	Part No.	Catalog #	Page	Location/Rooms	Unit Price	EXT. Price	
Coat hooks (Box of 8)	2	Haworth	E2CH-8	Haworth Unigroup Too		Workstations	\$21.52	\$ 43.04	
								Subtotal	\$ 43.04

Section 3.2.2 - Printer Station within Work Station Area

Workstation Area

Description	QTY	MNFTR	Part No.	Catalog #	Page	Location/Rooms	Unit Price	EXT. Price	
72" w x 24" d laminate work surfaces to span entire back of workstation where noted.	1	Haworth	WURA-2472-LTSA	Haworth Unigroup Too		Printer Station	\$113.15	\$ 113.15	
24" deep f/f pedestals must be full height to attach to work surface with lock.	2	Haworth	VPAJ-24-5	Haworth Unigroup Too		Printer Station	\$154.50	\$ 309.00	
Open shelves to match panel widths.	2	Haworth	UESN-0836-PM	Haworth Unigroup Too		Printer Station	\$55.43	\$ 110.86	
24" w x 62" h work station panels for end panels	2	Haworth	E2MN-262-B	Haworth Unigroup Too		Printer Station	\$134.16	\$ 268.32	
Duplex outlets (Box of 6)	1	Haworth	PRD-3-B	Haworth Unigroup Too		Printer Station	\$37.45	\$ 37.45	
Cantilever Bracket, Pair	1	Haworth	ZEBD-1600-PP	Haworth Unigroup Too		Printer Station	\$21.01	\$ 21.01	
All workstations should have wing panels. See drawing for size.									
								Subtotal	\$ 859.79

Section 3.2.3 - Copy/Mail Area (Rm 12)

Work Surfaces

Table

Description	QTY	MNFTR	Part No.	Catalog #	Page	Location/Rooms	Unit Price	EXT. Price	
30" d x 72" w x 36" h table laminate top with steel base and 4 legs on casters	1	Haworth	45TC-3072-E6SC	Haworth Tables		Mail Area	\$449.92	\$ 449.92	
								Subtotal	\$ 449.92

Seating

Description:	QTY	MNUF	Part No.	Catalog #	Page	Location/Rooms	Unit Price	Ext. Price
Stool with foot ring: standard pneumatic height, tilt,	1	Hon	H7805	Hon		Mail Area	\$248.36	\$ 248.36

thick 45 lbs. density particle board and covered on both sides with high performance thermally fused laminate. File drawers have full extension steel ball bearing slides, box drawers use 3/4 extension steel ball bearing slides. Drawers and end panels are edge banded on all four sides to protect clothing and the floor covering. locks are standard. Drawers are open with side pulls. Full leg end panels and modesty panel.								
36" x 72" d peninsula desk	2	Three H	RD7236-H	Three H		Room 21 & 22	\$368.72	\$ 737.44
48" w return with f/f full height pedestal	2	Three H	D4824SR-H	Three H		Room 21 & 22	\$183.87	\$ 367.74
	2	Three H	PC5102	Three H		Room 21 & 22	\$284.65	\$ 569.30
	4	Three H	CGR40	Three H		Room 21 & 22	\$16.72	\$ 66.88
48" w over the desk w/tack board	2	Three H	SH483814FF-12BD	Three H		Room 21 & 22	\$370.69	\$ 741.38
	2	Three H	TBSH4838FF-12	Three H		Room 21 & 22	\$133.23	\$ 266.46
36" w task light	2	Three H	TL36-S	Three H		Room 21 & 22	\$67.84	\$ 135.68
24" full height, laminate b/b/f pedestal mobile with casters.	2	Three H	MP5103	Three H		Room 21 & 22	\$337.75	\$ 675.50
Keyboard tray fully adjustable, with mouse pad that can be moved to either left or right side of keyboard tray, includes palm support, no knob or lever needed for height adjustment, 6" of height adjustment, negative and positive tilt with 360 degree swivel.	2	Right Angle	JVS17-S	Right Angle		Room 21 & 22	\$122.32	\$ 244.64
Freestanding paper tray to include:								
Horizontal In Tray	2	Haworth	DTLS-2	Haworth Unigroup Too		Room 21 & 22	\$25.82	\$ 51.64
Horizontal Out Tray								
Freestanding diagonal tray to consist of 3 slots	2	Haworth	DTPR-1	Haworth Unigroup Too		Room 21 & 22	\$17.21	\$ 34.42
							Subtotal	\$ 3,891.08

Seating

Description	QTY	MNFTR	Part No.	Catalog #	Page	Location/Rooms	Unit Price	EXT. Price
Task chairs: standard pneumatic height, tilt, swivel features metal frame with height adjustable arms, 5 star base casters, mid back design, adjustable lumbar, upholstered in fabric	2	Hon	HVL630	Hon		Room 21 & 22	\$211.83	\$ 423.66
Guest chairs - metal frame w/arms, 4 legs without casters upholstered in fabric	4	Global	2171	Global Seating		Room 21 & 22	\$95.38	\$ 381.52
							Subtotal	\$ 805.18

Miscellaneous Items

Description	QTY	MNFTR	Part No.	Catalog #	Page	Location/Rooms	Unit Price	EXT. Price
36" w x 4 high laminate lateral file w/lock	2	Three H	GSB355424D-A2	Three H		Room 21 & 22	\$968.50	\$ 1,937.00
	2	Three H	T88024D-SE	Three H		Room 21 & 22	\$42.28	\$ 84.56

Task chairs: standard pneumatic height, tilt, swivel features metal frame with height adjustable arms, 5 star base casters, mid back design, adjustable lumbar, upholstered in fabric	2	Hon	HVL630	Haworth Unigroup Too		Room 2	\$211.83	\$ 423.66
Guest chairs - metal frame with arms, 4 legs without casters upholstered in fabric	2	Global	2171	Global Seating		Room 2	\$95.38	\$ 190.76
							Subtotal	\$ 614.42

Miscellaneous Items

Description	QTY	MNFTR	Part No.	Catalog #	Page	Location/Rooms	Unit Price	EXT. Price
36" w x 4 high laminate lateral file w/lock	2	Three H	GSB355424D-A2	Three H		Room 2	\$968.50	\$ 1,937.00
	2	Three H	T176024D-SE	Three H		Room 2	\$98.32	\$ 196.64
							Subtotal	\$ 2,133.64

Section 3.2.8 - There is one conference room and the design options are as follows: (Room 4)

Tables

Description	QTY	MNFTR	Part No.	Catalog #	Page	Location/Rooms	Unit Price	EXT. Price
Conference table:								
30" d x 60" w laminate tops with steel base and 4 legs on casters	6	Three H	TMT-6030-1	Three H		Conference Room	\$98.32	\$ 589.92
	12	Three H	LGP1201.181-CS1	Three H		Conference Room	\$102.26	\$ 1,227.12
	8	Three H	TMT-J	Three H		Conference Room	\$11.31	\$ 90.48
							Subtotal	\$ 1,907.52

Seating

Description	QTY	MNFTR	Part No.	Catalog #	Page	Location/Rooms	Unit Price	EXT. Price
Stacking side chairs , 4 legs, without arms upholsteed in fabric. (2 Per Carton)	12	United Chair	ON34C	United Chair		Conference Room	\$349.60	\$ 4,195.20
							Subtotal	\$ 4,195.20

Miscellaneous Items

Description	QTY	MNFTR	Part No.	Catalog #	Page	Location/Rooms	Unit Price	EXT. Price
Marker board to consist of white board, two side opening doors, cork board on right side door and 50 sheet writing pad on left door. Marker board can also be used for projection. Set of 4 dry markers and eraser included with board.	1	Global	AVB4848	Global Casegoods		Conference Room	\$526.31	\$ 526.31
							Subtotal	\$ 526.31

(4 Chairs Per Carton - 2 Go to Lobby)									
								Subtotal	\$ 1,350.51

Section 3.2.13 - Storage Room to contain: (Room 5)

Miscellaneous Items

Description	QTY	MNFR	Part No.	Catalog #	Page	Location/Rooms	Unit Price	EXT. Price
Shelves								
6 high 36" w x 12" deep open style shelving heavy	2	Tennsco	Q06-3612A	Tennsco		Storage	\$100.79	\$ 201.58
duty, 20 gauge steel, 1000 lb. max load per shelf	2	Tennsco	Q06-3612S	Tennsco		Storage	\$104.25	\$ 208.50
							Subtotal	\$ 410.08

GRAND TOTAL	\$ 56,098.54
--------------------	---------------------

UniGroup[®] Too

HAWORTH[®]



What can you do with UniGroup Too?

Sure, underneath is one of the industry's most widely installed furniture systems, renowned for its durability and simplicity. But with squared top trim and tight tolerances, it's sleek and rectilinear, sophisticated and classic. Scalable panel and component options can meet your interior needs with ease.

UniGroup Too—a fresh look for the essential office.

Panel's *de Jû* and Maham Charikkin Promise
Trim Chalk Workspaces Espresso Walnut, Teign Island
Storage *A Series* in Espresso Walnut and
Mint Champagne Translucent with Taper Pulls
Task Seating *Xiro* in Ultra French Vanilla, Metallic Silver Trim
Lounge Seating *Hollo* in Maharam Regent Classic Sempolinda
and Maharam Strut Lumogreiss

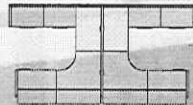



Panel: Shimmery Wet Glass, Landscape (solid) and
Trim: Shell, Worksurfaces: Espresso Walnut, Edge Band
Overhead Storage: Shell
Storage X: Panel in Shell
Seating: X52 in Shell, Lurech Vanilla, Matilla, Silver, Inis
Guest Seating: L007 in Shell, Finesse Vanilla, Metalar Silver Trim

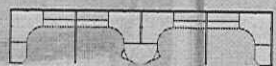

You can customize your space with monolithic or segmented panels. Select wood to contrast or complement the fabrics you choose.

Panel: Maharam Glim Ice
Table: Metallic Silver
Workspaces: Chalk Cascade
Storage: X Series in Metallic Silver with Matrix Perforated Metal with Radius Pull
Slat Pad: Metall: Silver with Jump Stuff Mini Shell in Chalk
Task Seating: X4 in Standard Pattern 270, Metallic Silver Trim
Lounge Seating: Hillo in Maharam Align Spring and Kvadrat Pouffe 770

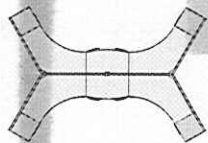

You can create task and open spaces with the same components. Pair shimmering fabrics with slat tiles and marvel at how rich and textured a panel can be. Slim, too, since rigid panel inserts create a flatter look. Segmented panels create an architectural look in a 120-degree layout. X Series® stationary and mobile storage help define workspace parameters and easily adapt to change.

Panela 100 R, 1000
Trim C, 100 Work Surface, 1000
Overhead Storage, 1000
Storage 20 Series, 1000
Tackboards, 1000
Seating 100, 1000

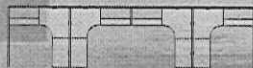

You can bring subtle sophistication to a basic application with work surfaces, file storage, and up-mount overhead storage units in soft chalk tones. And bring Power Base™, the industry's most intelligent power delivery system, plus unmatched data management that easily integrates tools and technology. A contrasting fabric on the tackboards adds interest to a shared workspace.

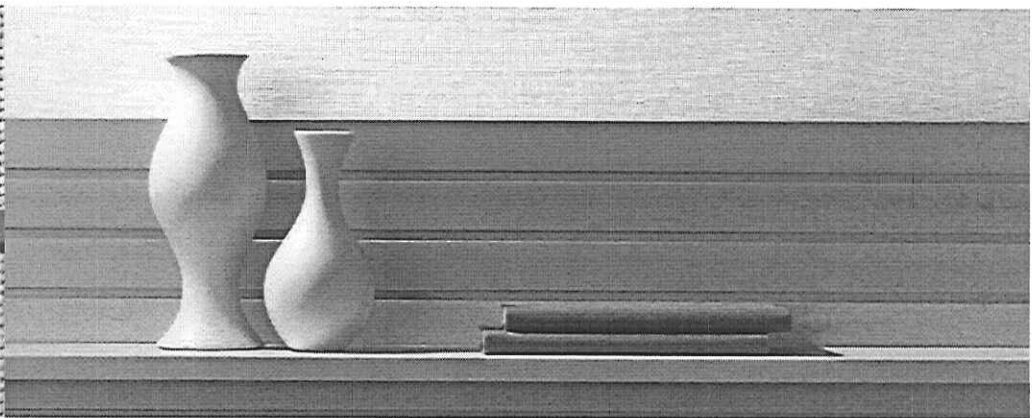
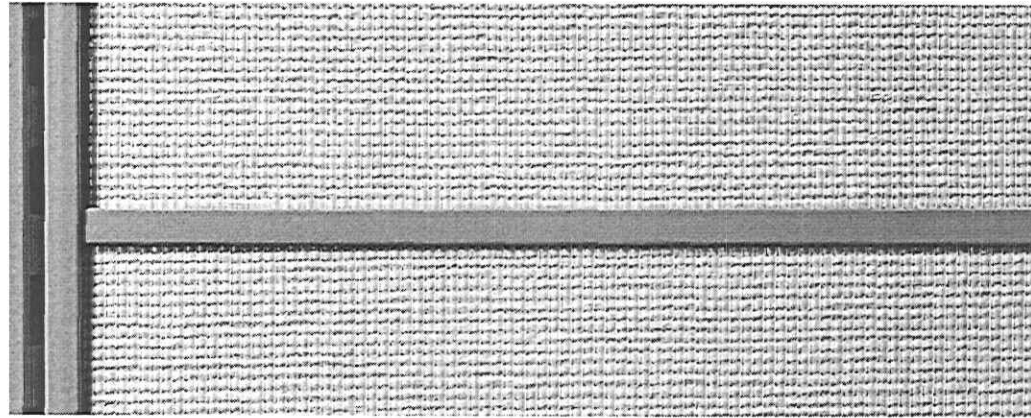

A fresh look for the essential office.

UniGroup Too brings a sleek look that's loaded with possibilities. There are segmented panels for an architectural look, up-mount storage units for landscaping, and slat pads or markerboards for personalization. Plus, UniGroup Too works brilliantly with Haworth seating and storage.

So, what else can you do with UniGroup Too?

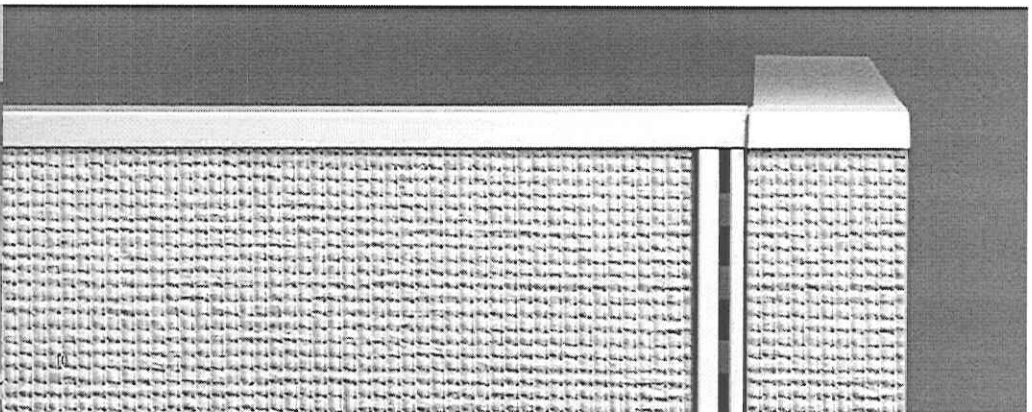
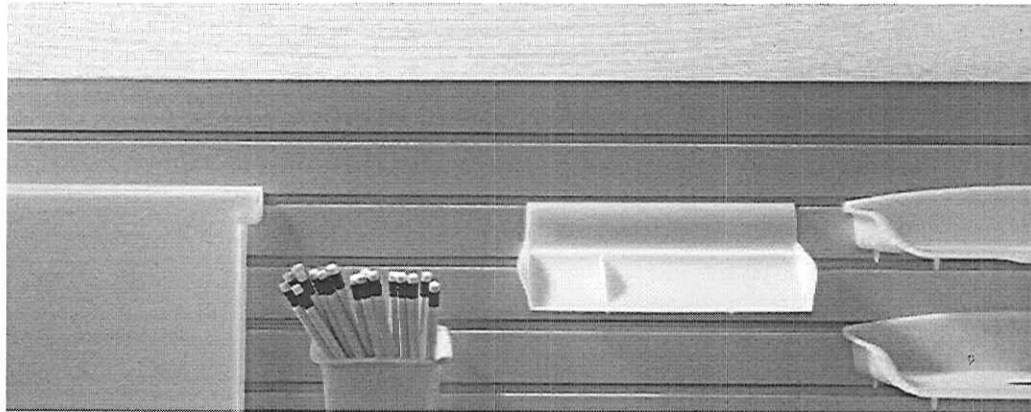
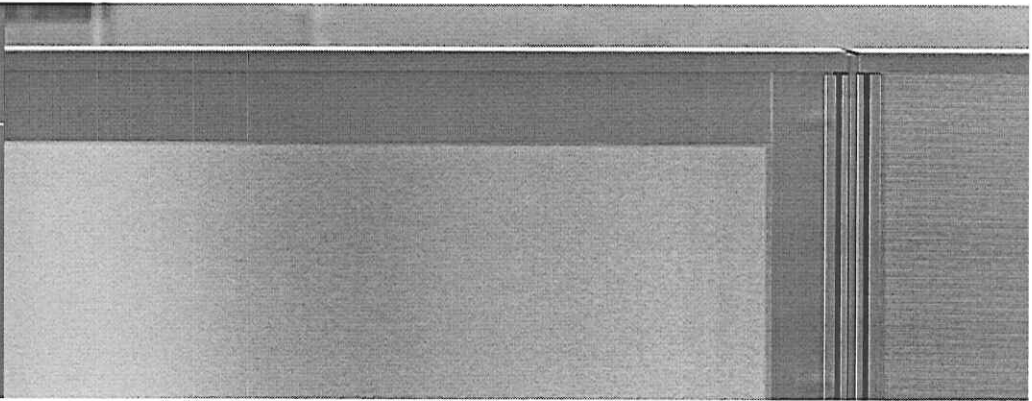

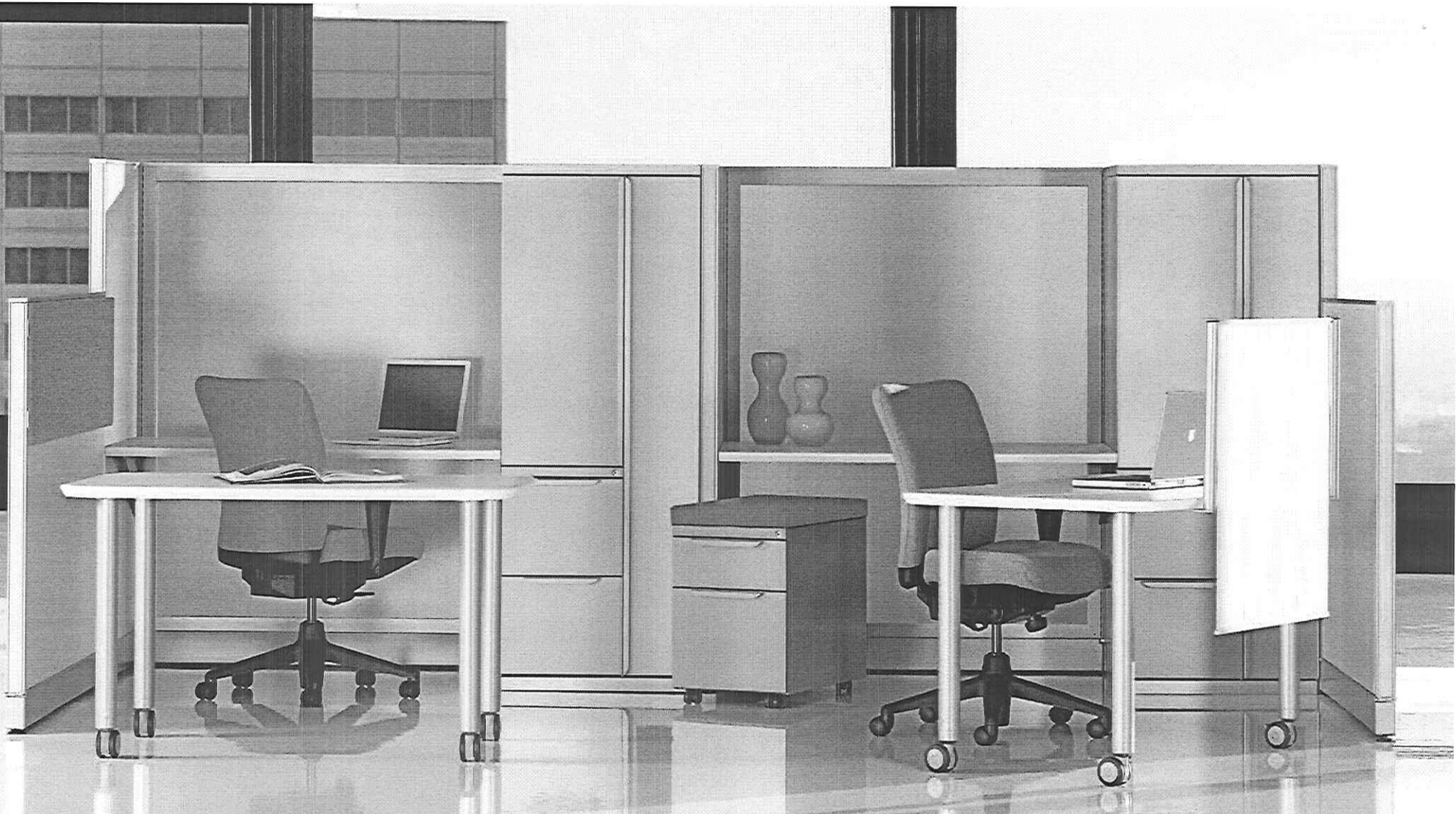

Panels Chalk Laminate
 Trim Metallic Silver Worksurfaces Chalk, Cassate
 Tackboard Kenyon Yendra 427
 Storage X Series In Metallic Silver with Taper Pulls and Bette White Translucent
 Seating LCNK in Kvadrat Tondo #27

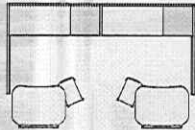

Add privacy with screens that attach directly to mobile tables and tie it all together for a clever impact with matching fabric on tackboards and mobile storage modules.

Panel: Mirage Dream
Trim: Platinum Worksurfaces: Platinum, Edge Sand
Taskboards: Kio Smart
Overhead Storage: Smoke and Basic White Translucent
Storage: V Series™ in Smoke, cabinet in Maharam Calyx Jungle
Seating: LOOK in Bribe Cambridge Blue

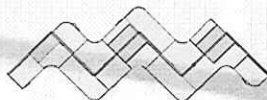

You can add variety to the landscape with up-mount overhead storage units, achieving added height and privacy without added costs. In fact, you could design this entire workspace quickly and on a tight budget because all components, including the V Series™ storage units, are readily available through Haworth's Start It Up Program.



Trim Metallic Silver **Worksurfaces** Espresso Walnut, Edge Band
Overhead Storage Espresso Walnut
Storage Espresso Walnut with Linear Brushed Nickel Pulls
Seating Hello with Backrest White Hello Swivel, Marillo, Silver Trim
Guest Seating Hello in Espresso Walnut with Manhattan Walnut Carlini

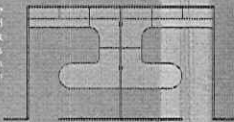

You can mix warm woods with cool metallic finishes to create private workspaces that welcome light through glass panels. Wood worksurfaces and overhead storage units complement X Series storage and Hello guest chairs.

You can do great things with a system this intuitive.

Durable

- UniGroup Too's monocoque construction integrates a rugged steel frame with a honeycomb core and a perforated steel skin. The unique universal hinge accommodates any panel angle and up to one million bends.

Simple

- Monolithic or segmented—you can mix and match and choose fabric, glass, or markerboard. Rigid panel inserts slide in and deliver a slimmer look than stretched fabric.
- Pre-finished trim rails eliminate the need for finish posts. Rails slide to offer easy access for panel removal—even at the center of a run.
- Power Base, the industry's most intelligent power delivery system, handles up to six circuits, 120 amps of power, and works with every building's wiring configuration.

- Built-in outlet covers slide to reveal powered panel outlets; they slide back if you need to configure for a non-powered panel.

Sustainable

UniGroup Too is GREENGUARD® certified.

UniGroup Too's standard panel has an average recycled content of 33% with 20% post-consumer content. Panels can be ordered with 100% recycled polyester fabrics.

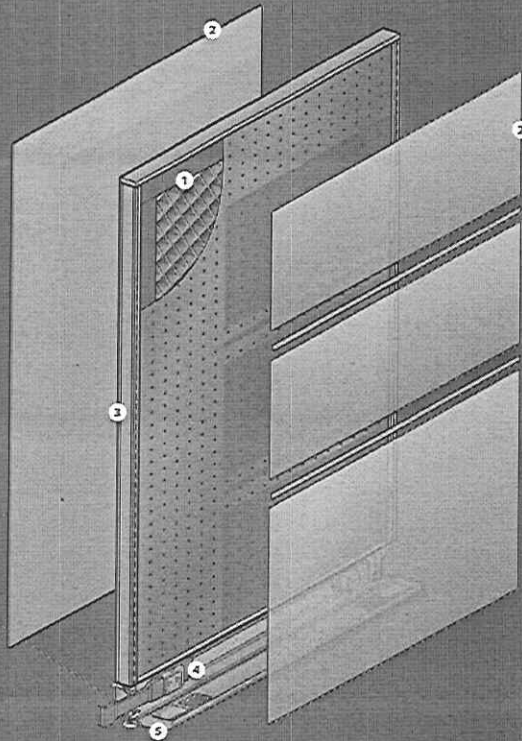

Worksurfaces

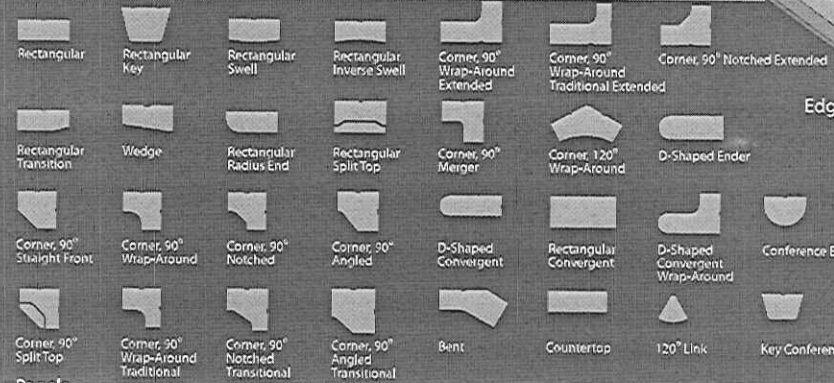

Edge Detail

Trimold
Edge Band
Cascade

Panels

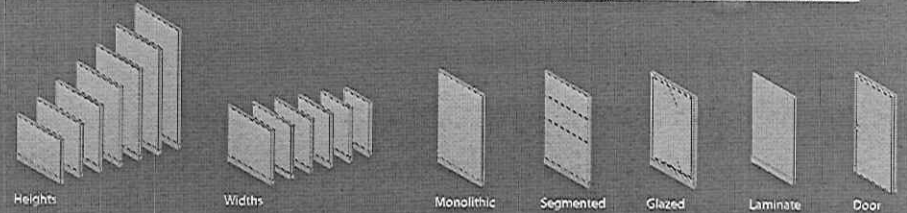

Inserts



Add-ons

Shelf

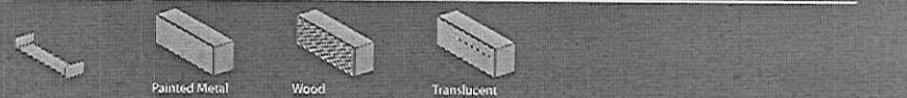

Overheads (Standard or Up-mount)

X Series Storage



V Series Storage

Jump Stuff Accessories



HAWORTH®

For more information call 800.344.2600 or 616.393.3000.
Download additional copies at haworth.com.

This brochure is printed on FSC certified U2®.XG™ paper, manufactured with electricity in the form of renewable energy (wind, hydro, biogas) and contains a minimum of 30% post-consumer recovered fiber. FSC is the global benchmark for responsible forest management.



Haworth is a registered trademark of Haworth, Inc.
Printed in USA ©Haworth, Inc. 2010 02.10 Item #1055

haworth.com | haworth-europe.com | haworth-asia.com

PRE- MIERE



Offices. Perfectly Tailored.™

It's more than an evolution in styling... It's advanced manufacturing and enhanced craftsmanship backed by renown and impeccable Three H customer service. For more than 25 years we've been quietly perfecting the private office. Now we're ready to launch a complete re-engineering of private office furniture for a more sophisticated world of higher expectations. Get ready to experience Three H like never before.

three-h.com/premiere

Introducing The Premiere Series™

The New Concept in Furniture: Ultimate, High-End Performance at an Affordable Price.

The newest Three H series comes out in style, with a fresh complement of enhancements and styling cues. There are more elegant lines and a smart appearance, highlighted by a unique mix of all the most modern and advanced materials made in North America. Including our well-regarded and admired laminate-surface collection, proprietary designs in crafted aluminum accents, limitless selection of painted glass, and unique integration of textiles components.

Designed and engineered by Jean Bourassa and Three H. Powered by RED.





New, slim-line metal-frame cabinet doors frame a striking array of clear, frosted or painted glass. A highly visual manifestation of enhanced and personalized design. The total effect is empowering. How about painted glass, available in many standard colors including white, graphite & black on metal or design your suite with classic laminate framed clear glass cabinet doors.

Design your own office at:
www.three-h.com/RED

With a Single Look, You'll Recognize the Difference

The eye-catching bold design matched with finessed trim accents including a wealth of fabric choices now also featured on the wall-mounted and under-surface modesty panels, enhances the design value of your suite. But the choices do not end there.... Consider new post-leg designs. Look deeper, there are now more changes beneath the surface. New disk and square steel post legs, in silver or black, follow styling cues of surface shapes. And the new laminate box leg is elegantly trimmed at the base for a finished look. Add color and texture with fabrics on tack boards... and now on modesty panels. Best of all, no matter how you build your office, your environment will acquire a personalized feel. Discover the combination that speaks to you.

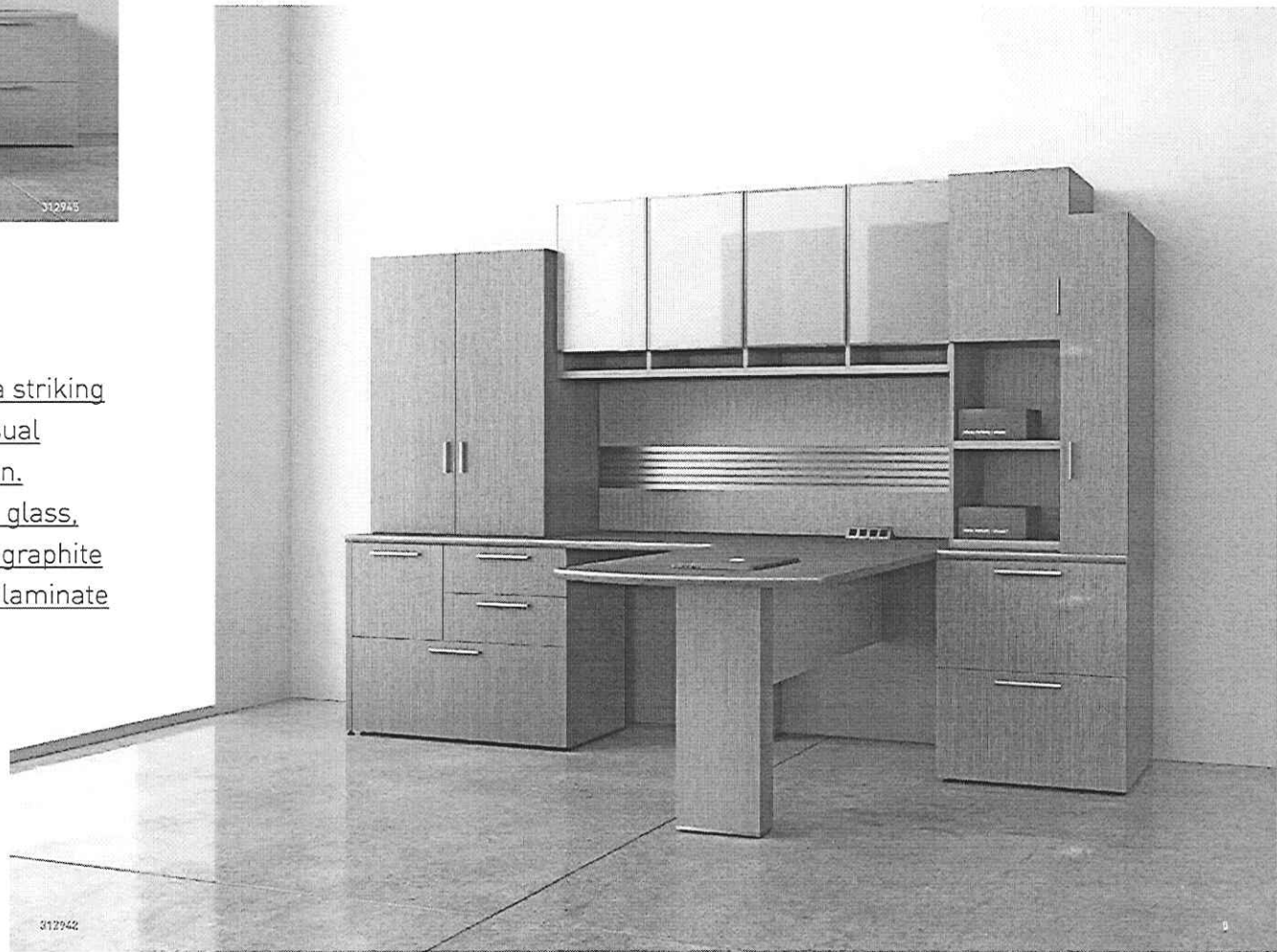

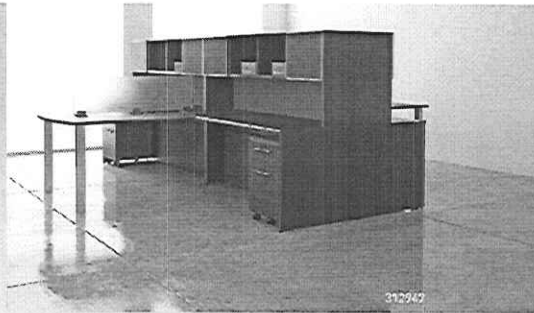

Advancing our Service Model – Yet Again

Our new engineering model ensures the smoothest, fastest transition from your ideas to the design, pricing, manufacture and delivery of your office.

Build and customize on your own with our RED software or with the assistance of our customer service team – who are standing by to do all the pricing and drawings for you, if you choose. Our RED technology is integrated directly into manufacturing. And with all standard materials pre-stocked in the factory, we can build and deliver in the extraordinary quickness that Three H is renown for.

See lots more Ideas at:
www.three-h.com/typicals

Every Inch of Each Suite is Designed to Please and Inspire

What you'll notice first is the clean lines and inherent harmony of the design: uncluttered, elegant cabinet fronts and neatly arranged pulls meet best-in-class material and top workmanship. The overall feeling is that you have arrived in the right office. Later you will notice that the design is not only attractive, it is also extremely functional: everything is designed for typical Three H high performance. The shared office should also be functional... but why not pleasing too.

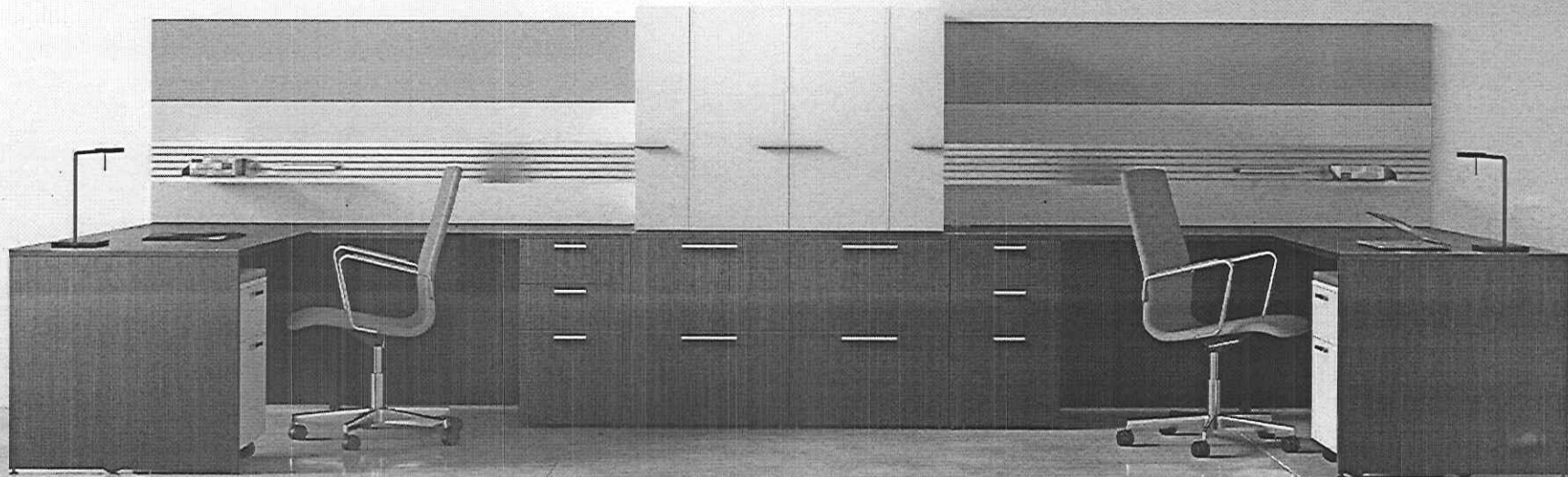

Introducing the new Wavecrest™ solid wood edge detail.
Joining a family of hand-stained and applied wood edge
trims for surfaces and tops of cabinets.

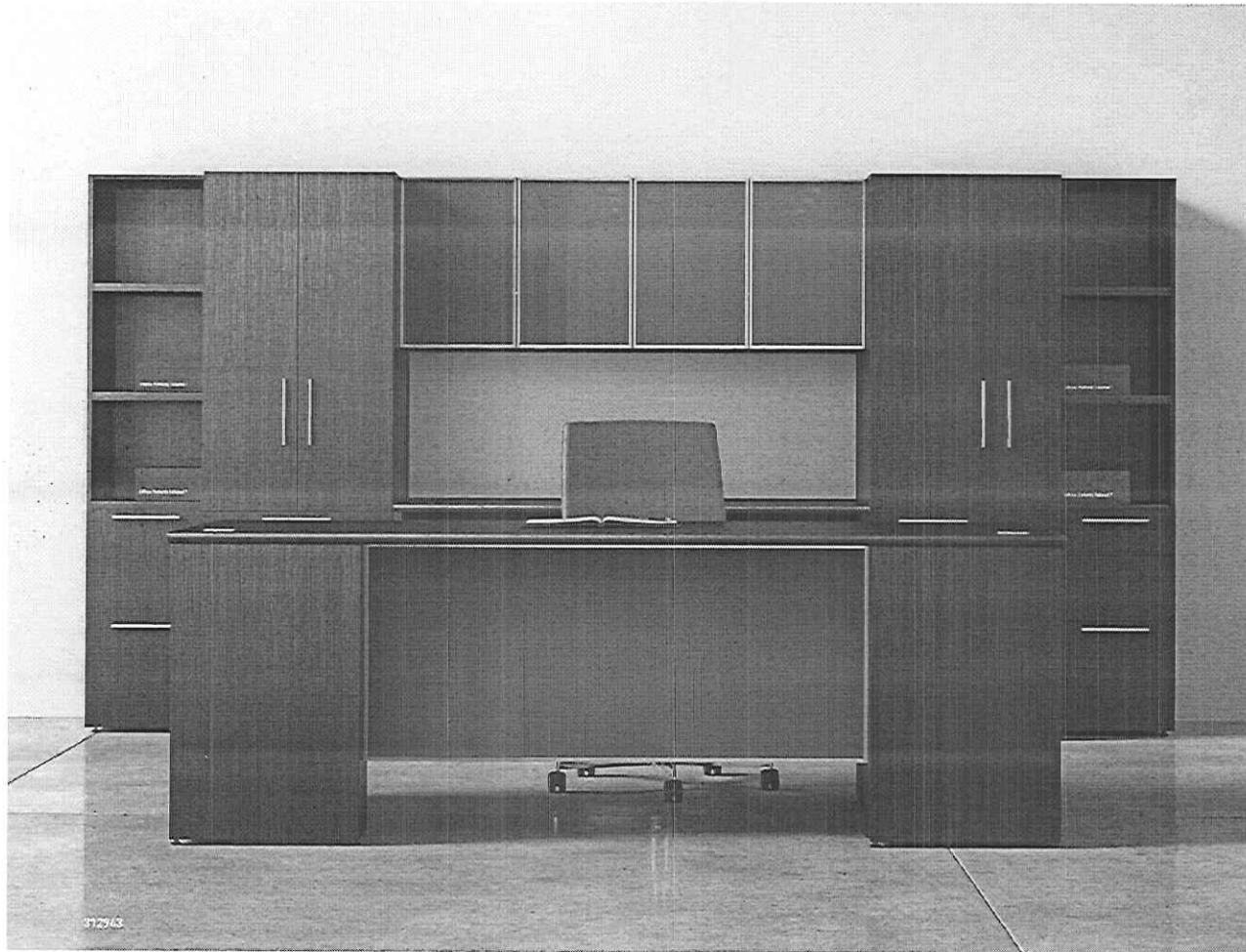

Visit:
www.three-h.com/typicals

Moving Forward is Very Satisfying

The North American executive office is still the home for richly appointed and empowering furniture...with hand-crafted, real wood trim, and elegantly designed pulls which translates to a more luxurious office suite. And in a noteworthy design feature and at the heart of Three H's reputation of detailed craftsmanship, a new wood trim design is being added to the collection of solid wood choices. Coupled with Three H sizing by the inch on work surfaces and hutches, there are extraordinary options for custom designs.

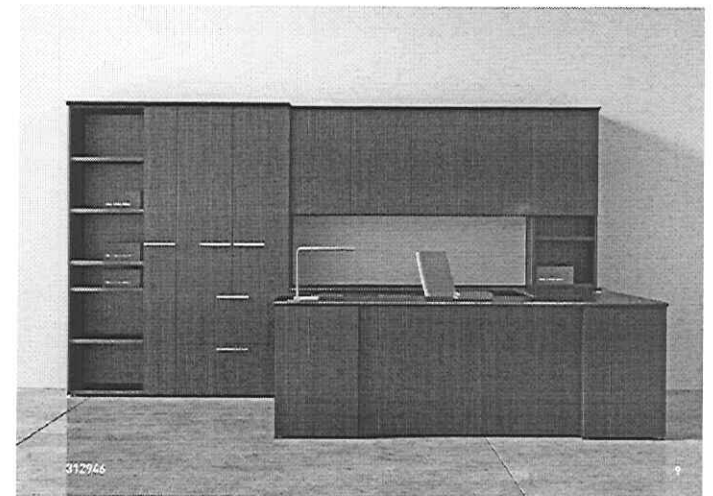

Personalized Styling: the Hallmark of Three H

By offering the exclusive detailing of high-end office furniture and creating a captivating and inventive design, Three H delivers a wealth of elegance and sophistication. And by introducing two more new wood-finish options Dark Suede and Sand Drift, The Premiere Series retains at the core the winning attributes of Three H: Over 30 carefully selected, in-stock wood and color finishes, New power/data channel under surface management is another new advancement. Sit behind the desk and be instantly impressed with how natural it feels. From the strategic location of pulls to the power/data options easily at hand, this furniture has been crafted with your needs foremost in mind. Wall mounted backboards and tackboards are new design features expanding the styling choices to all new heights.

Your choice at:
www.three-h.com/finishes

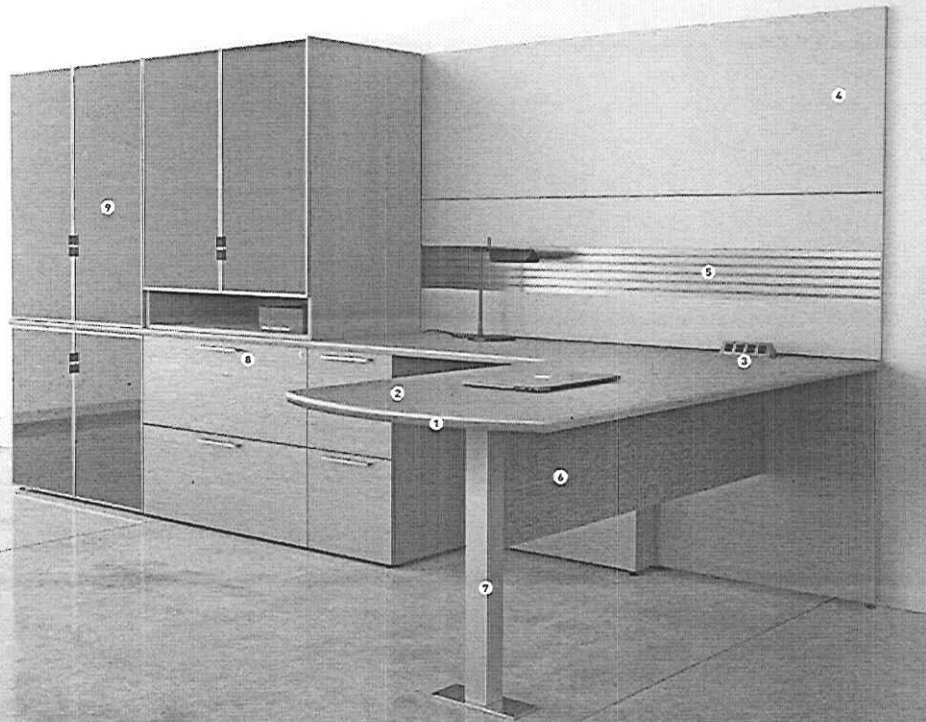

- 1 / Solid Wood Trim Shown in WaveCrest™, also available in Prestige, Bullnose and Self Edge
- 2 / Worksurfaces D-Top, P-Top, Rectangular, Arc, Corner Desk
- 3 / Power/Data Deluxe Cable Management (see details right side)
- 4 / Tackboards Optional wall mounted or hutch supported and over 47 standard fabrics
- 5 / Accessory Rail Multiple accessories available
- 6 / Modesty Panels Upholstered or Laminate
- 7 / Worksurface Bases: Metal Square & Round (with and without plate) & Laminate box
- 8 / Handles 11 different pulls available in various finishes
- 9 / Glass Doors Painted & Frosted Glass Options in thin Metal frame or Clear Glass in Laminate frame

419020

The new, optional Deluxe Cable Management under surface box channel is a case in point. In this you can see an innovative, functional and effective approach to the cable management needs of the private office.

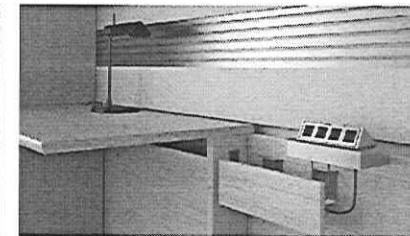
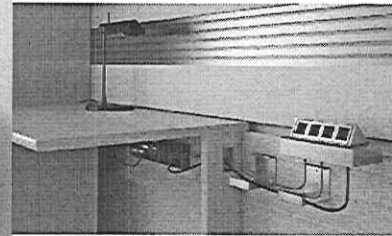

Make it Practical...Make it Beautiful

We've made the cabinet profiles even more emphatic. Their clean lines frame a more modern and upscale appearance. All curved surfaces and edge details are sharply defined to create an elegant and tailored finish. Proprietary designed anodized aluminum accessory rails paired with new leg designs will enhance and elevate the profile of office layouts. High quality office furniture can be very nicely priced too. New software, advanced engineering and manufacturing at Three H have made prices even better. Remember, we've been doing this for over 25 years and have the highest reputation as proof of our promise.

Our Customers speak for us at:
www.three-h.com/casestudies

Three H Loves Making Office Furniture, And You Can Tell.

It's how it's made, where it's made and who it's made for:
The customer who wants custom sizing, delivered quickly
by craftspeople in North America. Best of all, it's at a price
that will surprise and welcome you.



This Page 312940
Cover 312939

Designed, Developed and
Manufactured in North America

Printed in Canada, 7 PR13-06
©2013 Three H Furniture Systems Limited. All rights reserved

Images shown are representative of finishes,
and are not to be used as actual samples.



800.767.5374 www.three-h.com



Mixed Sources
Cert no. SW-COC-001731
© 1996 FSC



Comet™

Contemporary reception seating



Versatile



2171
2172
2175
2178
2179

Comet™

Comet is a contemporary general use reception/meeting chair. Its powder coat epoxy finished tubular frame and padded seat cushions combine comfort with long lasting durability.

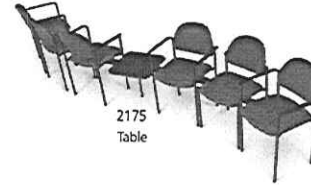

2175
Table



2171
Nesting Armchair

Specifications

DESCRIPTION

DIMENSIONS

SEAT HEIGHT

W	D	H	IN
mm	mm	mm	mm



Nesting Armchair

Comet™ 7

2191 – As above, upholstered in Leather

23	22	32½	18½
584	559	825	470



Armless Nesting Chair

Comet™ 7

2192 – As above, upholstered in Leather

19	22	32½	18½
483	559	825	470



Square Corner/Straight Table with Mono Leg

2176 - Special ganging bracket to join armchairs, sidechairs and tables

18	18	17½	
457	457	445	



Radius Corner Table with Mono Leg

18	18	17½	
457	457	445	



Crescent Corner Table with Two Legs

30	30	17½	
762	762	445	

Global - Canada
560 Superstest Road Downsview
Ontario Canada M3J 2M6 Tel (416) 667-7660
Dealer Customer Service: Fax (416) 736-6685
Government Customer Service: Fax (416) 739-6319

Global - U.S.A.
17 West Stow Road PO. Box 562
Milton New Jersey U.S.A. 08053
Tel (856) 596-1290 (800) 220-1900
Fax (856) 596-5684

Global - International
560 Superstest Road Downsview
Ontario Canada M3J 2M6
Tel (416) 667-1260
Fax (416) 667-1821

G.G.L. Office Furniture (UK) Ltd.
Global Way, Darwen,
Lancashire BB3 0KW, UK
Tel +44(0) 1254 778500
Fax +44(0) 1254 778519

Visit us on the World Wide Web at www.globaltotaloffice.com

Offices throughout Canada, United States, United Kingdom, France and Australia. Distribution around the world. A member of the Global Group.

united chair[®]
A GROUPE LACASSE BRAND

Executive /
Management /
Guest



Onyx

TAILORED DESIGN.
MAXIMUM COMFORT.
MULTIPLE APPLICATIONS.

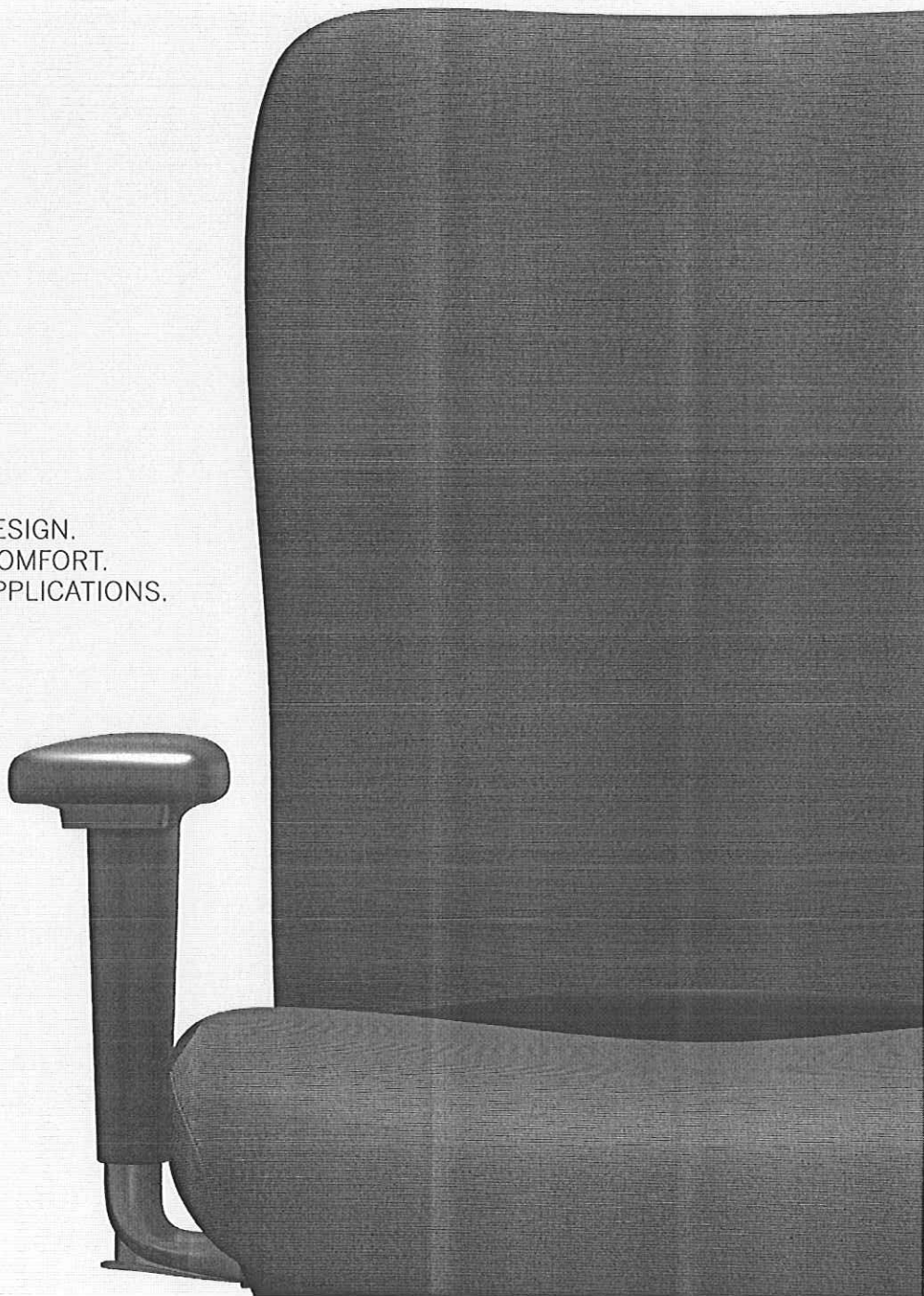



ON34C-DP - Maharam MG054 Lumine



ON31-EP - Maharam MG054 Lumine
& ONBK Polypropylene Back Shell



ON32C-DP - Maharam MG054 Lumine
& ONBK Polypropylene Back Shell



ON33-DP - Maharam MG054 Lumine

Onyx™ guest seating is available with an optional polypropylene back in a choice of three colors. And whether you prefer casters or glides, arms or armless versions, Onyx™ is a chair ready to meet a significant range of needs.



For further information, please visit:
www.groupelacasse.com/onyx



A finely tailored chair of classic design and function, Onyx incorporates simplified ergonomics for elevated comfort. This executive and management chair can be dressed in a variety of fabrics to suit the personality of your office - a perfect choice for dynamic and multipurpose environments.

Onyx™

Executive / Management / Guest

PROFILE

/ Executive, management models available in dual upholstery combination for seat and backrest

/ Ratchet back mechanism allows easy positioning of lumbar support up to 6 height positions

/ Molded back and seat foam provides great comfort and support

/ Synchronous-tilt mechanism for noticeable smoothness in movement

/ Standard seat sliding mechanism provides additional seat depth

/ Optional forward-tilt and 4-position back lock

/ Standard fixed arms, height adjustable or height, width and pivoting arms options

/ Waterfall seat design reduces pressure on thighs

/ Pneumatic seat height adjustment

/ Braille on stainless steel lever inserts

/ Standard nylon base, steel or polished chrome base options

/ Extensive choice of guest models with polypropylene back and upholstered seat or fully upholstered

	inches mm	SEAT			BACK		OVERALL			BETWEEN ARMS
		HEIGHT	WIDTH	DEPTH	HEIGHT	WIDTH	HEIGHT	WIDTH	DEPTH	
Management chair without arms Upholstered backrest/seat	ON10	16 ³ / ₈ - 20 ³ / ₄ 416 - 526	19 483	16 ³ / ₈ - 17 ¹ / ₂ 416 - 444	19 ⁷ / ₈ - 22 505 - 559	17 ³ / ₄ 451	33 ⁷ / ₈ - 41 ³ / ₈ 860 - 1051	23 ³ / ₄ 603	24 ¹ / ₂ 622	NA NA
Management chair with arms Upholstered backrest/seat	ON11	16 ³ / ₈ - 20 ³ / ₄ 416 - 526	19 483	16 ³ / ₈ - 17 ¹ / ₂ 416 - 444	19 ⁷ / ₈ - 22 505 - 559	17 ³ / ₄ 451	33 ⁷ / ₈ - 41 ³ / ₈ 860 - 1051	25 ¹ / ₂ 648	24 ¹ / ₂ 622	17 ¹ / ₈ 435
Executive chair without arms Upholstered backrest/seat	ON15	16 ³ / ₈ - 20 ³ / ₄ 416 - 526	19 483	16 ¹ / ₂ - 17 ³ / ₄ 418 - 451	22 ⁷ / ₈ - 24 583 - 610	18 457	37 ¹ / ₄ - 44 ³ / ₄ 946 - 1137	23 ³ / ₄ 603	24 ¹ / ₂ 622	NA NA
Executive chair with arms Upholstered backrest/seat	ON16	16 ³ / ₈ - 20 ³ / ₄ 416 - 526	19 483	16 ¹ / ₂ - 17 ³ / ₄ 418 - 451	22 ⁷ / ₈ - 24 583 - 610	18 457	37 ¹ / ₄ - 44 ³ / ₄ 946 - 1137	25 ¹ / ₂ 648	24 ¹ / ₂ 622	17 ¹ / ₈ 435
Guest chair without arms, on glides Polypropylene back shell/upholstered seat	ON31-DP	18 457	18 ³ / ₄ 476	18 ¹ / ₄ 463	15 ¹ / ₄ 387	17 432	32 819	20 ¹ / ₂ 517	24 ¹ / ₂ 622	NA NA
Guest chair without arms, on casters Polypropylene back shell/upholstered seat	ON31C-DP	18 457	18 ³ / ₄ 476	18 ¹ / ₄ 463	15 ¹ / ₄ 387	17 432	32 819	20 ¹ / ₂ 517	24 610	NA NA
Guest chair with arms, on glides Polypropylene back shell/upholstered seat	ON32-DP	18 457	18 ³ / ₄ 476	18 ¹ / ₄ 463	15 ¹ / ₄ 387	17 432	32 819	23 584	24 ¹ / ₂ 622	19 ¹ / ₂ 495
Guest chair with arms, on casters Polypropylene back shell/upholstered seat	ON32C-DP	18 457	18 ³ / ₄ 476	18 ¹ / ₄ 463	15 ¹ / ₄ 387	17 432	32 819	23 584	24 610	19 ¹ / ₂ 495
Guest chair without arms, on glides Upholstered backrest/seat	ON33-DP	18 457	18 ³ / ₄ 476	18 ¹ / ₄ 463	16 406	18 457	32 ³ / ₄ 857	20 ¹ / ₂ 517	24 ¹ / ₂ 622	NA NA
Guest chair without arms, on casters Upholstered backrest/seat	ON33C-DP	18 457	18 ³ / ₄ 476	18 ¹ / ₄ 463	16 406	18 457	32 ³ / ₄ 857	20 ¹ / ₂ 517	24 610	NA NA
Guest chair with arms, on glides Upholstered backrest/seat	ON34-DP	18 457	18 ³ / ₄ 476	18 ¹ / ₄ 463	16 406	18 457	32 ³ / ₄ 857	23 584	24 ¹ / ₂ 622	19 ¹ / ₂ 495
Guest chair with arms, on casters Upholstered backrest/seat	ON34C-DP	18 457	18 ³ / ₄ 476	18 ¹ / ₄ 463	16 406	18 457	32 ³ / ₄ 857	23 584	24 610	19 ¹ / ₂ 495

POLYPROPYLENE BACK SHELL COLOR CHOICES FOR GUEST CHAIRS



ONBK - Black

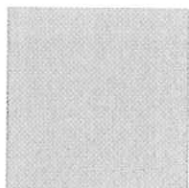

ONPT - Platinum

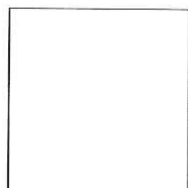

ONWH - White



RPA Arms - Optional height and width adjustable arms with pivoting armrests



SSP - Sliding seat mechanism

United Chair® products are GREENGUARD® Indoor Air Quality and Children and Schools certified. United Chair® products comply with ANSI/BIFMA X5.1-2002 and ISO 14001:1996 standards. Information contained herein is subject to change without notice.

UNITED CHAIR® IS A PROUD MEMBER OF GROUPE LACASSE

GROUPE
LACASSE

1.888.522.2773
www.grouperlacasse.com

3888
U334-1
3/09
15M

We're proud to provide products with 100% recycled content paper products.

Printed in Canada

HON.

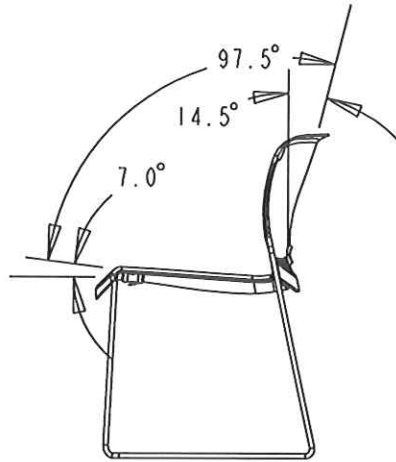
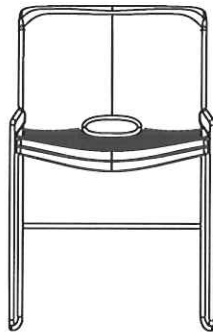

H4041 High Density H4041FC Olson Stacker Technical Specifications

Polymer
Seat and Back,
7/16" Steel
Rod Frame,
Chrome Legs

KEY DIMENSIONS

Max. Width..... 19-1/8"
Max. Depth..... 21-5/8"
Max. Height..... 30-5/8"
Seat Size
Width..... 17-3/4"
Usable Depth..... 17"
Height from Floor..... 17-3/4"
Back Size
Width..... 17-1/2"
Height from Seat..... 16-1/4"

Back Lumbar

Height..... 10-3/4"

Stack Size

On Cart (H4043)

Number of Chairs..... 40

On Floor

Number of Chairs..... 12

CONSTRUCTION

Glide..... Frosted polycarbonate available in Glide packs Model H4048 Ganging and H4049 Non-ganging.

Frame..... Chrome 7/16" diameter steel wire.

Seat..... 1/8" thick texted polymer.

Back..... 1/8" thick texted polymer.

Chair Weight..... 12.5 pounds per chair.

Shipping Weight... 57 pounds. (4 pack)

Shipped..... Completely assembled, (4) per carton.

Shipping Size..... 26" wide x 20-1/2" deep x 34-1/2" high (10.6 cubic feet).

Flammability

Rating..... Furnished upon request by The HON Company Customer Service. Model H4041 meets the State of California Department of Consumer Affairs Technical Bulletin 117 requirements. Model H4041FC meets the State of California Department of Consumer Affairs Technical Bulletin 133 requirements.

Note..... All measurements are per BIFMA/CMD procedures.

MODEL: HVL630XX

High-performance task, Swivel
Asynchronous control, Pneumatic,
Ratchet back height, Tilt,
Tilt tension, Adjustable height
and width arm

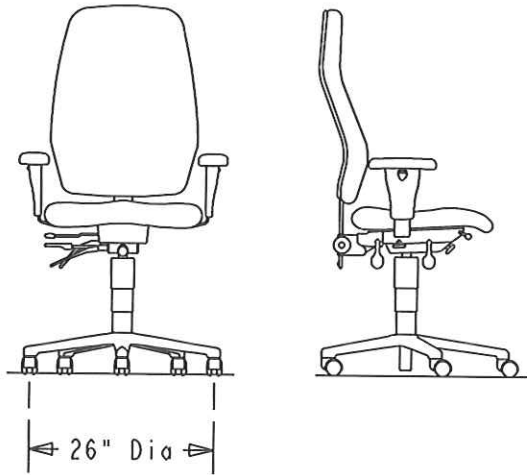

CHAIR SPECIFICATIONS

Max. Width.....	32-1/2
Max. Depth.....	25
Max. Height.....	45
Seat Size	
Width.....	20-1/2
Depth.....	20-1/2
Usable Depth.....	18-1/2
Height from Floor....	17-1/4 - 20-3/4
Back Size	
Width.....	20
Height from seat....	24-1/2 - 26-1/2
Arm Size	
Distance Between.....	18-1/8 - 21-3/8
Height from seat....	7 - 10

CONSTRUCTION

- Caster..... 2" diameter hooded dual wheel.
- Base..... Black plastic base.
- Control.....Black heavy gauge steel, asynchronous control, tilt, and tilt tension, 17-4 taper.
- Seat..... Upholstered in black, charcoal, burgundy, or navy fabric.
- Back.....Upholstered in black, charcoal, burgundy, or navy fabric.
- Arm..... Steel with plastic shell, height and width adjustments and urethane arm pad
- Chair Weight..... 45 pounds.
- Shipping Weight..... 51 pounds.
- Shipped..... Assembly required.
- Shipping Size..... 25-19/32" wide x 31-7/8" deep x 11-13/16" high
(5.58 cubic feet). UPSable
- Flammability Rating..... Furnished upon request by the HON Company Customer Service.
- Note..... All measurements are per BIFMA/CMD procedures.

Issue Date:	23-SEP-2010
Part Number:	53-9282

MODEL: HVL871

Leather Club Chair



CHAIR SPECIFICATIONS

Max. Width..... 33"
Max. Depth..... 28-3/4"
Max. Height..... 32"

Seat Size

Width..... 21-1/2"
Usable Depth..... 21"
Height from Floor.... 18-1/2"

Back Size

Width..... 30"
Height from seat..... 18-1/2"

Arm Size

Width.....
Distance Between
Arms..... 21-1/2"
Height from Seat.....
Height from Floor.... 25-1/4"

CONSTRUCTION

Frame..... Plywood

Seat.....

Back.....

Upholstery..... Leather Only.

Chair Weight.....

Shipping Weight..... 51 pounds.

Shipped..... Some Assembly Required. Not Shippable by Small Package Carrier.

Shipping Size..... (20.7 cubic feet).

Note..... All measurements are per ANSI/BIFMA procedures.

Issue Date:	21-SEP-2010
Part Number:	53-3044

MODEL: HVL873

Leather Sofa

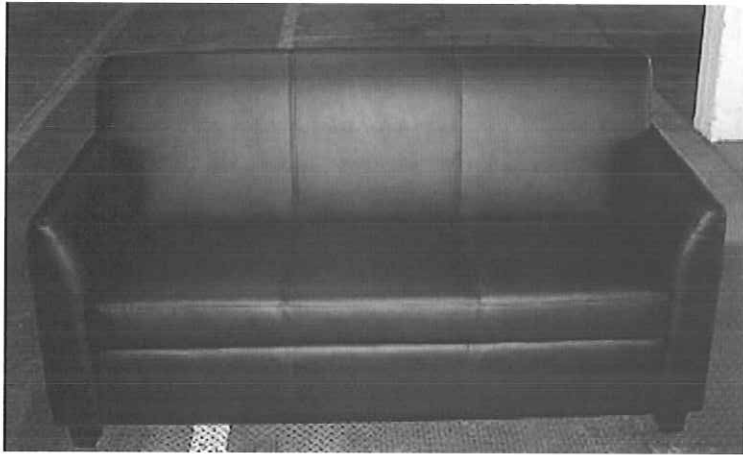

CHAIR SPECIFICATIONS

Max. Width..... 73"
Max. Depth..... 28-3/4"
Max. Height..... 32"

Seat Size

Width..... 61-1/2"
Usable Depth..... 21"
Height from Floor.... 18-1/2"

Back Size

Width..... 70"
Height from seat.... 18-1/2"

Arm Size

Width.....
Distance Between
Arms..... 61-1/2"
Height from Seat....
Height from Floor.... 25-1/4"

CONSTRUCTION

Frame..... Plywood

Seat.....

Back.....

Upholstery..... Leather Only.

Chair Weight.....

Shipping Weight..... 122 pounds.

Shipped..... Assembly Required. Not Shippable by Small Package Carrier.

Shipping Size..... (45.0 cubic feet).

Note..... All measurements are per ANSI/BIFMA procedures.

Issue Date:	21-SEP-2010
Part Number:	53-3046

HON.

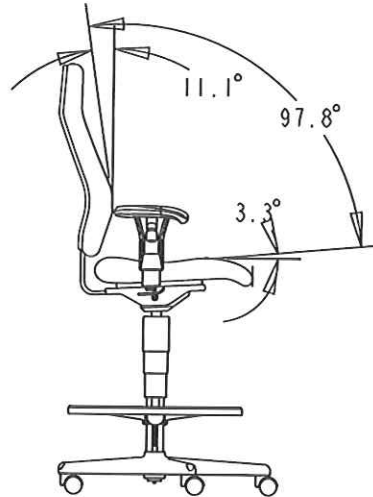
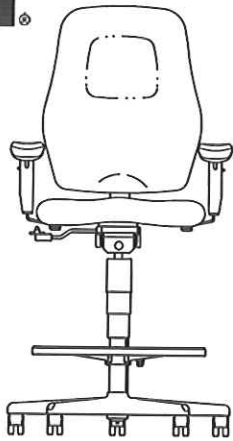

H7805 H7805FC Technical Specifications

Task, Stool, Pneumatic,
Swivel, Adjustable
Height Footring,
Height and Width
Adjustable Arms

KEY DIMENSIONS

Max. Width.....	30-1/2"
Max. Depth.....	28"
Max. Height.....	50"
Seat Size	
Width.....	21-1/2"
Usable Depth.....	18"
Height from Floor.....	23-1/4" - 33-1/4"
Back Size	
Width.....	19-3/4"
Height from Seat.....	23-7/8"

Back Lumbar

Height..... 7"

Arm Size

Distance between arms..... 18-5/8" - 21-5/8"
Height from floor..... 30-7/8" - 43-3/8"
Height from seat..... 8-1/4" - 11"
Width..... 3-3/4"
Length..... 10"
Arm Set-Back..... 6-3/8"

Footring

Size..... 20"
Height from Floor..... 7-1/8" - 12-1/4"

CONSTRUCTION

Caster..... 2" diameter hooded dual wheel.

Optional Caster... See Dealer Nrt Pricer

Base..... Black 5 legged nylon plastic base.

Control..... Black heavy gauge steel, swivel only, 17-4 taper.

Seat..... 5/8" thick, composite wood product, 2-1/2" thick molded urethane foam cushion.

Back..... 1/2" thick, 5-ply covered plywood, 3" thick urethane foam cushion.

Arm..... Steel with plastic shell, built in height and width adjustment and urethane arm pad.
Each arm is independently adjustable for height and width.

Upholstery..... See List Pricer. Customer own material (COM) required yardage per SKU = 2.0 yards.

Chair Weight..... 52 pounds.

Shipping Weight.. 62 pounds.

Shipped..... Completely assembled

Shipping Size..... 28.88" wide x 25.69" deep x 42.75" high (18.4 cubic feet)

Flammability

Rating..... Furnished upon request by The HON Company Customer Service. Model H7805 meets the State of California Department of Consumer Affairs Technical Bulletin 117 requirements.
Model H7805FC meets the State of California Department of Consumer Affairs Technical Bulletin 133 requirements.

Special Features... A pneumatic gas cylinder is used for height adjustment of chair.

Note..... All measurements are per BIFMA/CMD procedures.

Q Line Shelving • ESP Packaged Shelving



tennsco
SYSTEMS FOR SUCCESS

Q Line Packaged Shelving

Q Line Shelving is designed for those storage applications that demand strength and versatility.

Q Line's exclusive Box Beam construction and heavy reinforced steel shelves offer increased load bearing capacity for your heaviest storage needs.

Designed to handle up to 750 pounds, Q Line Packaged shelving is available in popular standard configurations.

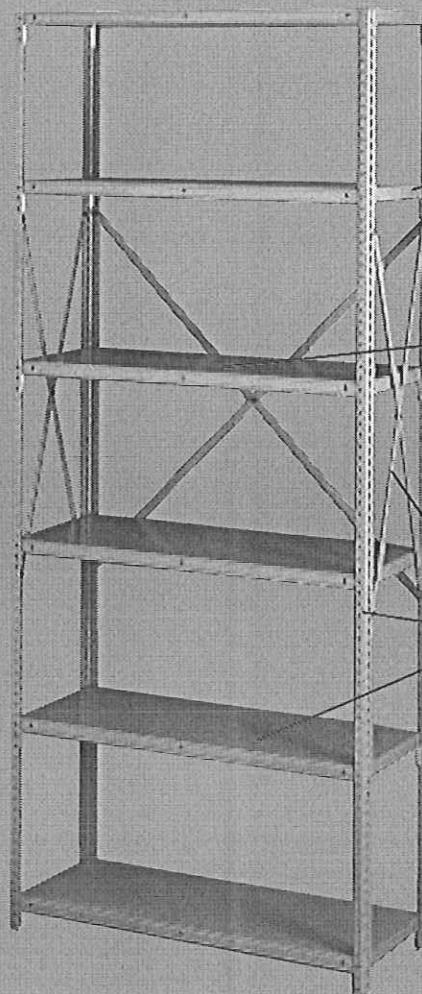

Heavy Duty

Shelf corners are fully lapped and welded for extra strength and durability.

Adjustable

Shelves can be adjusted quickly and easily in 1" increments.

Standard Configurations for Easy Ordering

Simply order a shelf kit consisting of six shelves in any one of four depths; then add a universal post and brace kit. Nothing could be easier!

Superior Strength

Q Line shelves use a structural box formation on the front and rear flanges. The face of the box is ribbed and the flange is welded every three inches. The shelf ends have three bends (competing shelves use only two) for added front to back strength. The net result is the strongest shelf in its class, with a load capacity up to 750 pounds!

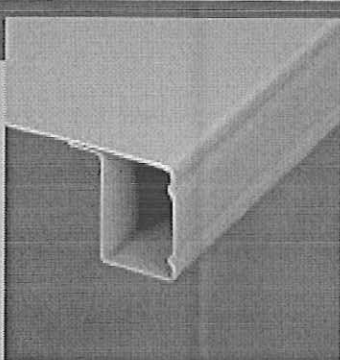

Boltless Shelf Installation

Compression clips make adding shelves a snap. Just clip on. No bolts or tools required.



ESP Shelving

Lightweight but durable packaged shelving offers multipurpose use at a reasonable price. ESP Shelving will deliver economical, dependable storage in office stockrooms and throughout your plant or warehouse.

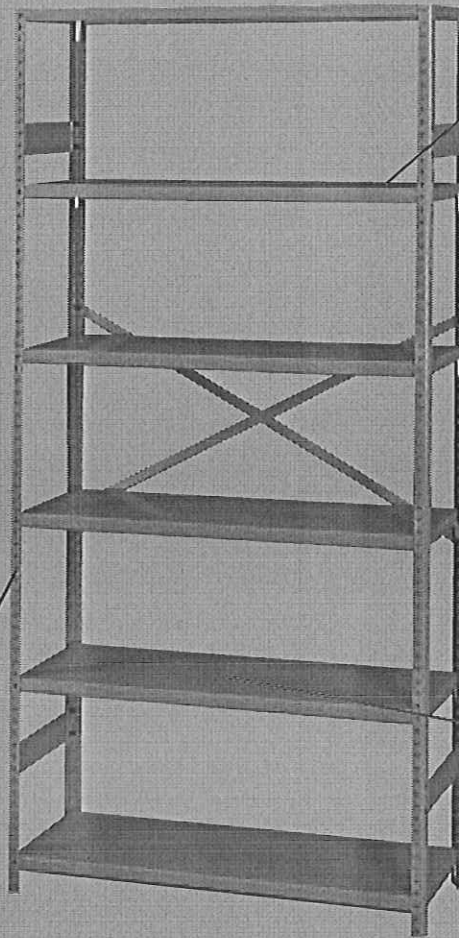

Standard Configurations

ESP shelving is available in a 75" height with either four or five openings. Extra shelves are also available.

Variety of Depths

Available in four depths to suit any application.

Quick Assembly

ESP shelving can be assembled quickly using the supplied nuts, bolts and shelf clips. All necessary components are in one box for easy ordering.

Adjustable

For maximum flexibility, shelves adjust in 1" increments to store a wide variety of items in different shapes, heights, and sizes.

Flanged for Extra Strength

All ESP shelves incorporate multiple-bend flanges with lapped and welded corners. The design permits loads up to 250 pounds per shelf!

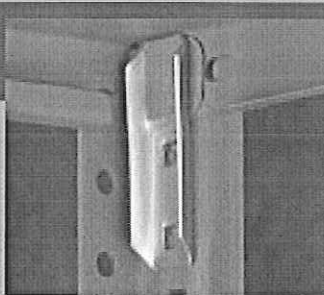

Enhanced Unit Integrity

ESP shelving comes complete with end plates and back braces to assure the unit's rigidity.

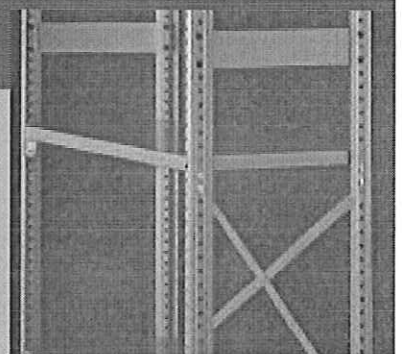

tennsco

SYSTEMS FOR SUCCESS

All Tennsco Q Line and ESP Packaged Shelving is painted with a tough, baked-on enamel finish to assure years of lasting beauty.



Medium
Grey

Finishes shown above are only representative of the actual finishes. If greater accuracy is required contact your local Tennsco dealer for additional information.

A WORD ABOUT TENNSCO

Tennsco Corp., headquartered in Dickson, Tennessee, began operations in 1962. Today, Tennsco is an industry leader with over 1 million square feet of manufacturing and warehouse space in six facilities. Tennsco offers a wide variety of filing and storage systems, steel office furniture, industrial and institutional shelving, lockers and shop equipment.

For additional information on other Tennsco products, contact:

tennsco

SYSTEMS FOR SUCCESS

201 Tennsco Drive

Dickson, TN 37056-1888

(615) 446-8000 (800) 251-8184

Facsimile (800) 722-0134