



State of West Virginia  
 Department of Administration  
 Purchasing Division  
 2019 Washington Street East  
 Post Office Box 50130  
 Charleston, WV 25305-0130

**Request for  
 Quotation**

RFQ NUMBER
PRI10863

PAGE
1

ADDRESS CORRESPONDENCE TO ATTENTION OF:
TARA LYLE 304-558-2544

VENDOR

RFQ COPY  
 TYPE NAME/ADDRESS HERE  
 Worldwide Equipment of WV  
 Charleston Division  
 PO Box 8557  
 South Charleston WV 25303

SHIP TO

WV PRISON INDUSTRIES  
 617 LEON SULLIVAN WAY  
 CHARLESTON, WV  
 25301 304-558-2945

DATE PRINTED	TERMS OF SALE	SHIP VIA	F.O.B.	FREIGHT TERMS
07/28/2011				

BID OPENING DATE: 08/31/2011 BID OPENING TIME 01:30PM

LINE	QUANTITY	UOP	CAT. NO.	ITEM NUMBER	UNIT PRICE	AMOUNT
0001	1	EA		070-53	87,779.00	87,779.00
DELIVERY TRUCK  THE WEST VIRGINIA PURCHASING DIVISION FOR THE AGENCY, WEST VIRGINIA CORRECTIONAL INDUSTRIES, IS SOLICITING BIDS FOR ONE (1) 2011 OR NEWER DELIVERY TRUCK, PER THE ATTACHED SPECIFICATIONS.  INQUIRIES:  WRITTEN QUESTIONS WILL BE ACCEPTED UNTIL CLOSE OF BUSINESS ON 08/15/2011. QUESTIONS MAY BE SENT VIA USPS, FAX, COURIER OR E-MAIL. IN ORDER TO ASSURE NO VENDOR RECEIVES AN UNFAIR ADVANTAGE, NO SUBSTANTIVE QUESTIONS WILL BE ANSWERED ORALLY. IF POSSIBLE, E-MAIL QUESTIONS ARE PREFERRED. ADDRESS INQUIRIES TO:  TARA LYLE DEPARTMENT OF ADMINISTRATION PURCHASING DIVISION 2019 WASHINGTON STREET, EAST CHARLESTON, WV 25305  FAX: 304-558-4115 EMAIL: TARA.L.LYLE@WV.GOV  CANCELLATION: THE DIRECTOR OF PURCHASING RESERVES THE RIGHT TO CANCEL THIS CONTRACT IMMEDIATELY UPON WRITTEN NOTICE TO THE VENDOR IF THE COMMODITIES AND/OR SERVICES SUPPLIED ARE OF AN INFERIOR QUALITY OR DO NOT CONFORM						

RECEIVED  
 2011 AUG 31 AM 11:15  
 WV PURCHASING  
 DIVISION

SEE REVERSE SIDE FOR TERMS AND CONDITIONS			
SIGNATURE	TELEPHONE	DATE	
<i>Jackie D. C...</i>	304-744-1321	8/30/2011	
TITLE	FEIN	ADDRESS CHANGES TO BE NOTED ABOVE	
Sales Consultant	451024981		

WHEN RESPONDING TO RFQ, INSERT NAME AND ADDRESS IN SPACE ABOVE LABELED 'VENDOR'

**GENERAL TERMS & CONDITIONS  
REQUEST FOR QUOTATION (RFQ) AND REQUEST FOR PROPOSAL (RFP)**

1. Awards will be made in the best interest of the State of West Virginia.
  2. The State may accept or reject in part, or in whole, any bid.
  3. Prior to any award, the apparent successful vendor must be properly registered with the Purchasing Division and have paid the required \$125 fee.
  4. All services performed or goods delivered under State Purchase Order/Contracts are to be continued for the term of the Purchase Order/Contracts, contingent upon funds being appropriated by the Legislature or otherwise being made available. In the event funds are not appropriated or otherwise available for these services or goods this Purchase Order/Contract becomes void and of no effect after June 30.
  5. Payment may only be made after the delivery and acceptance of goods or services.
  6. Interest may be paid for late payment in accordance with the *West Virginia Code*.
  7. Vendor preference will be granted upon written request in accordance with the *West Virginia Code*.
  8. The State of West Virginia is exempt from federal and state taxes and will not pay or reimburse such taxes.
  9. The Director of Purchasing may cancel any Purchase Order/Contract upon 30 days written notice to the seller.
  10. The laws of the State of West Virginia and the *Legislative Rules* of the Purchasing Division shall govern the purchasing process.
  11. Any reference to automatic renewal is hereby deleted. The Contract may be renewed only upon mutual written agreement of the parties.
  12. **BANKRUPTCY:** In the event the vendor/contractor files for bankruptcy protection, the State may deem this contract null and void, and terminate such contract without further order.
  13. **HIPAA BUSINESS ASSOCIATE ADDENDUM:** The West Virginia State Government HIPAA Business Associate Addendum (BAA), approved by the Attorney General, is available online at [www.state.wv.us/admin/purchase/vrc/hipaa.htm](http://www.state.wv.us/admin/purchase/vrc/hipaa.htm) and is hereby made part of the agreement. Provided that the Agency meets the definition of a Cover Entity (45 CFR §160.103) and will be disclosing Protected Health Information (45 CFR §160.103) to the vendor.
  14. **CONFIDENTIALITY:** The vendor agrees that he or she will not disclose to anyone, directly or indirectly, any such personally identifiable information or other confidential information gained from the agency, unless the individual who is the subject of the information consents to the disclosure in writing or the disclosure is made pursuant to the agency's policies, procedures, and rules. Vendor further agrees to comply with the Confidentiality Policies and Information Security Accountability Requirements, set forth in <http://www.state.wv.us/admin/purchase/privacy/noticeConfidentiality.pdf>.
  15. **LICENSING:** Vendors must be licensed and in good standing in accordance with any and all state and local laws and requirements by any state or local agency of West Virginia, including, but not limited to, the West Virginia Secretary of State's Office, the West Virginia Tax Department, and the West Virginia Insurance Commission. The vendor must provide all necessary releases to obtain information to enable the director or spending unit to verify that the vendor is licensed and in good standing with the above entities.
  16. **ANTITRUST:** In submitting a bid to any agency for the State of West Virginia, the bidder offers and agrees that if the bid is accepted the bidder will convey, sell, assign or transfer to the State of West Virginia all rights, title and interest in and to all causes of action it may now or hereafter acquire under the antitrust laws of the United States and the State of West Virginia for price fixing and/or unreasonable restraints of trade relating to the particular commodities or services purchased or acquired by the State of West Virginia. Such assignment shall be made and become effective at the time the purchasing agency tenders the initial payment to the bidder.
- I certify that this bid is made without prior understanding, agreement, or connection with any corporation, firm, limited liability company, partnership, or person or entity submitting a bid for the same material, supplies, equipment or services and is in all respects fair and without collusion or fraud. I further certify that I am authorized to sign the certification on behalf of the bidder or this bid.

**INSTRUCTIONS TO BIDDERS**

1. Use the quotation forms provided by the Purchasing Division. Complete all sections of the quotation form.
2. Items offered must be in compliance with the specifications. Any deviation from the specifications must be clearly indicated by the bidder. Alternates offered by the bidder as **EQUAL** to the specifications must be clearly defined. A bidder offering an alternate should attach complete specifications and literature to the bid. The Purchasing Division may waive minor deviations to specifications.
3. Unit prices shall prevail in case of discrepancy. All quotations are considered F.O.B. destination unless alternate shipping terms are clearly identified in the quotation.
4. All quotations must be delivered by the bidder to the office listed below prior to the date and time of the bid opening. Failure of the bidder to deliver the quotations on time will result in bid disqualifications: Department of Administration, Purchasing Division, 2019 Washington Street East, P.O. Box 50130, Charleston, WV 25305-0130
5. Communication during the solicitation, bid, evaluation or award periods, except through the Purchasing Division, is strictly prohibited (W.Va. C.S.R. §148-1-6.6).



State of West Virginia  
 Department of Administration  
 Purchasing Division  
 2019 Washington Street East  
 Post Office Box 50130  
 Charleston, WV 25305-0130

**Request for  
 Quotation**

RFQ NUMBER
PRI10863

PAGE
2

ADDRESS CORRESPONDENCE TO ATTENTION OF:
TARA LYLE 304-558-2544

VENDOR

RFQ COPY  
 TYPE NAME/ADDRESS HERE  
 Worldwide Equipment of WV  
 Charleston Division  
 PO Box 8557  
 South Charleston WV 25303

SHIP TO

WV PRISON INDUSTRIES  
 617 LEON SULLIVAN WAY  
 CHARLESTON, WV  
 25301 304-558-2945

DATE PRINTED	TERMS OF SALE	SHIP VIA	F.O.B.	FREIGHT TERMS
07/28/2011				

BID OPENING DATE: 08/31/2011 BID OPENING TIME 01:30PM

LINE	QUANTITY	UOP	CAT. NO.	ITEM NUMBER	UNIT PRICE	AMOUNT
<p>TO THE SPECIFICATIONS OF THE BID AND CONTRACT HEREIN.</p> <p>BANKRUPTCY: IN THE EVENT THE VENDOR/CONTRACTOR FILES FOR BANKRUPTCY PROTECTION, THE STATE MAY DEEM THE CONTRACT NULL AND VOID, AND TERMINATE SUCH CONTRACT WITHOUT FURTHER ORDER.</p> <p>THE MODEL/BRAND/SPECIFICATIONS NAMED HEREIN ESTABLISH THE ACCEPTABLE LEVEL OF QUALITY ONLY AND ARE NOT INTENDED TO REFLECT A PREFERENCE OR FAVOR ANY PARTICULAR BRAND OR VENDOR. VENDORS WHO ARE BIDDING ALTERNATES SHOULD SO STATE AND INCLUDE PERTINENT LITERATURE AND SPECIFICATIONS. FAILURE TO PROVIDE INFORMATION FOR ANY ALTERNATES MAY BE GROUNDS FOR REJECTION OF THE BID. THE STATE RESERVES THE RIGHT TO WAIVE MINOR IRREGULARITIES IN BIDS OR SPECIFICATIONS IN ACCORDANCE WITH SECTION 148-1-4(F) OF THE WEST VIRGINIA LEGISLATIVE RULES AND REGULATIONS.</p> <p>VENDOR PREFERENCE CERTIFICATE</p> <p>THIS TEAM EXHIBIT HAS BEEN REPLACED BY THE ONLINE VERSION WHICH IS AVAILABLE HERE:  <a href="http://www.state.wv.us/admin/purchase/vrc/venpref.pdf">HTTP://WWW.STATE.WV.US/ADMIN/PURCHASE/VRC/VENPREF.PDF</a></p> <p>NOTICE</p> <p>A SIGNED BID MUST BE SUBMITTED TO:</p> <p>DEPARTMENT OF ADMINISTRATION        PURCHASING DIVISION        BUILDING 15        2019 WASHINGTON STREET, EAST        CHARLESTON, WV 25305-0130</p>						

SEE REVERSE SIDE FOR TERMS AND CONDITIONS

SIGNATURE	TELEPHONE	DATE
<i>Jackie A. ...</i>	304-744-1321	8/30/2011
TITLE	FEIN	ADDRESS CHANGES TO BE NOTED ABOVE
Sales Consultant	4502498	

WHEN RESPONDING TO RFQ, INSERT NAME AND ADDRESS IN SPACE ABOVE LABELED 'VENDOR'



State of West Virginia  
 Department of Administration  
 Purchasing Division  
 2019 Washington Street East  
 Post Office Box 50130  
 Charleston, WV 25305-0130

# Request for Quotation

RFQ NUMBER  
**PRI10863**

PAGE  
**3**

ADDRESS CORRESPONDENCE TO ATTENTION OF:  
**TARA LYLE**  
**304-558-2544**

VENDOR

RFQ COPY  
 TYPE NAME/ADDRESS HERE  
**Worldwide Equipment of WV**  
**Charleston Division**  
**PO Box 8557**  
**South Charleston WV 25303**

SHIP TO

**WV PRISON INDUSTRIES**  
**617 LEON SULLIVAN WAY**  
**CHARLESTON, WV**  
**25301**                      **304-558-2945**

DATE PRINTED	TERMS OF SALE	SHIP VIA	F.O.B.	FREIGHT TERMS
07/28/2011				

BID OPENING DATE: **08/31/2011**                      BID OPENING TIME **01:30PM**

LINE	QUANTITY	UOP	CAT NO	ITEM NUMBER	UNIT PRICE	AMOUNT
<p>THE BID SHOULD CONTAIN THIS INFORMATION ON THE FACE OF THE ENVELOPE OR THE BID MAY NOT BE CONSIDERED:</p> <p>SEALED BID</p> <p>BUYER:-----TL/32-----</p> <p>RFQ. NO.:-----PRI10863-----</p> <p>BID OPENING DATE:-----08/31/2011-----</p> <p>BID OPENING TIME:-----1:30 PM-----</p> <p>PLEASE PROVIDE A FAX NUMBER IN CASE IT IS NECESSARY TO CONTACT YOU REGARDING YOUR BID:            -----304-744-7852-----</p> <p>CONTACT PERSON (PLEASE PRINT CLEARLY):            -----Jackie Cummings-----</p> <p>***** THIS IS THE END OF RFQ PRI10863 ***** TOTAL: <u>87,779.<sup>00</sup></u></p>						

SEE REVERSE SIDE FOR TERMS AND CONDITIONS

SIGNATURE Jackie Cummings                      TELEPHONE 304-744-1321                      DATE 8/30/2011

TITLE Sales Consultant                      FEIN 451024981                      ADDRESS CHANGES TO BE NOTED ABOVE

WHEN RESPONDING TO RFQ, INSERT NAME AND ADDRESS IN SPACE ABOVE LABELED 'VENDOR'





State of West Virginia  
 Department of Administration  
 Purchasing Division  
 2019 Washington Street East  
 Post Office Box 50130  
 Charleston, WV 25305-0130

**Request for  
 Quotation**

RFQ NUMBER  
 PRI10863

PAGE  
 1

ADDRESS CORRESPONDENCE TO ATTENTION OF  
 TARA LYLE  
 304-558-2544

RFQ COPY

TYPE NAME/ADDRESS HERE

Worldwide Equipment of WV  
 Charleston Division  
 P.O. Box 8557  
 South Charleston WV 25303

WV PRISON INDUSTRIES

617 LEON SULLIVAN WAY  
 CHARLESTON, WV  
 25301 304-558-2945

DATE PRINTED	TERMS OF SALE	SHIP VIA	FOB	FREIGHT TERMS
08/17/2011				

BID OPENING DATE: 08/31/2011 BID OPENING TIME 01:30PM

LINE	QUANTITY	UOP	CAT NO	ITEM NUMBER	UNIT PRICE	AMOUNT
ADDENDUM NO. 1						
1. QUESTIONS AND ANSWERS ARE ATTACHED.						
2. ADDENDUM ACKNOWLEDGEMENT IS ATTACHED. THIS DOCUMENT SHOULD BE SIGNED AND RETURNED WITH YOUR BID. FAILURE TO SIGN AND RETURN MAY RESULT IN DISQUALIFICATION OF YOUR BID.						
EXHIBIT 10						
REQUISITION NO.: PRI10863						
ADDENDUM ACKNOWLEDGEMENT						
I HEREBY ACKNOWLEDGE RECEIPT OF THE FOLLOWING CHECKED ADDENDUM(S) AND HAVE MADE THE NECESSARY REVISIONS TO MY PROPOSAL, PLANS AND/OR SPECIFICATION, ETC.						
ADDENDUM NO. S:						
NO. 1 .. ✓ .....						
NO. 2 .....						
NO. 3 .....						
NO. 4 .....						
NO. 5 .....						
I UNDERSTAND THAT FAILURE TO CONFIRM THE RECEIPT OF THE ADDENDUM(S) MAY BE CAUSE FOR REJECTION OF BIDS.						

SEE REVERSE SIDE FOR TERMS AND CONDITIONS

SIGNATURE <i>Jackie A. ...</i>	TELEPHONE 304-744-1321	DATE 8/30/2011
TITLE Sales Consultant	FEIN 451024981	ADDRESS CHANGES TO BE NOTED ABOVE

WHEN RESPONDING TO RFQ, INSERT NAME AND ADDRESS IN SPACE ABOVE LABELED 'VENDOR'

**GENERAL TERMS & CONDITIONS**  
**REQUEST FOR QUOTATION (RFQ) AND REQUEST FOR PROPOSAL (RFP)**

1. Awards will be made in the best interest of the State of West Virginia.
2. The State may accept or reject in part, or in whole, any bid.
3. Prior to any award, the apparent successful vendor must be properly registered with the Purchasing Division and have paid the required \$125 fee.
4. All services performed or goods delivered under State Purchase Order/Contracts are to be continued for the term of the Purchase Order/Contracts, contingent upon funds being appropriated by the Legislature or otherwise being made available. In the event funds are not appropriated or otherwise available for these services or goods this Purchase Order/Contract becomes void and of no effect after June 30.
5. Payment may only be made after the delivery and acceptance of goods or services.
6. Interest may be paid for late payment in accordance with the *West Virginia Code*.
7. Vendor preference will be granted upon written request in accordance with the *West Virginia Code*.
8. The State of West Virginia is exempt from federal and state taxes and will not pay or reimburse such taxes.
9. The Director of Purchasing may cancel any Purchase Order/Contract upon 30 days written notice to the seller.
10. The laws of the State of West Virginia and the *Legislative Rules* of the Purchasing Division shall govern the purchasing process.
11. Any reference to automatic renewal is hereby deleted. The Contract may be renewed only upon mutual written agreement of the parties.
12. **BANKRUPTCY:** In the event the vendor/contractor files for bankruptcy protection, the State may deem this contract null and void, and terminate such contract without further order.
13. **HIPAA BUSINESS ASSOCIATE ADDENDUM:** The West Virginia State Government HIPAA Business Associate Addendum (BAA), approved by the Attorney General, is available online at [www.state.wv.us/admin/purchase/vrc/hipaa.htm](http://www.state.wv.us/admin/purchase/vrc/hipaa.htm) and is hereby made part of the agreement. Provided that the Agency meets the definition of a Cover Entity (45 CFR §160.103) and will be disclosing Protected Health Information (45 CFR §160.103) to the vendor.
14. **CONFIDENTIALITY:** The vendor agrees that he or she will not disclose to anyone, directly or indirectly, any such personally identifiable information or other confidential information gained from the agency, unless the individual who is the subject of the information consents to the disclosure in writing or the disclosure is made pursuant to the agency's policies, procedures, and rules. Vendor further agrees to comply with the Confidentiality Policies and Information Security Accountability Requirements, set forth in <http://www.state.wv.us/admin/purchase/privacy/noticeConfidentiality.pdf>.
15. **LICENSING:** Vendors must be licensed and in good standing in accordance with any and all state and local laws and requirements by any state or local agency of West Virginia, including, but not limited to, the West Virginia Secretary of State's Office, the West Virginia Tax Department, and the West Virginia Insurance Commission. The vendor must provide all necessary releases to obtain information to enable the director or spending unit to verify that the vendor is licensed and in good standing with the above entities.
16. **ANTITRUST:** In submitting a bid to any agency for the State of West Virginia, the bidder offers and agrees that if the bid is accepted the bidder will convey, sell, assign or transfer to the State of West Virginia all rights, title and interest in and to all causes of action it may now or hereafter acquire under the antitrust laws of the United States and the State of West Virginia for price fixing and/or unreasonable restraints of trade relating to the particular commodities or services purchased or acquired by the State of West Virginia. Such assignment shall be made and become effective at the time the purchasing agency tenders the initial payment to the bidder.

I certify that this bid is made without prior understanding, agreement, or connection with any corporation, firm, limited liability company, partnership, or person or entity submitting a bid for the same material, supplies, equipment or services and is in all respects fair and without collusion or fraud. I further certify that I am authorized to sign the certification on behalf of the bidder or this bid.

**INSTRUCTIONS TO BIDDERS**

1. Use the quotation forms provided by the Purchasing Division. Complete all sections of the quotation form.
2. Items offered must be in compliance with the specifications. Any deviation from the specifications must be clearly indicated by the bidder. Alternates offered by the bidder as EQUAL to the specifications must be clearly defined. A bidder offering an alternate should attach complete specifications and literature to the bid. The Purchasing Division may waive minor deviations to specifications.
3. Unit prices shall prevail in case of discrepancy. All quotations are considered F.O.B. destination unless alternate shipping terms are clearly identified in the quotation.
4. All quotations must be delivered by the bidder to the office listed below prior to the date and time of the bid opening. Failure of the bidder to deliver the quotations on time will result in bid disqualifications: Department of Administration, Purchasing Division, 2019 Washington Street East, P.O. Box 50130, Charleston, WV 25305-0130
5. Communication during the solicitation, bid, evaluation or award periods, except through the Purchasing Division, is strictly prohibited (W.Va. C.S.R. §148-1-6.6).



State of West Virginia  
 Department of Administration  
 Purchasing Division  
 2019 Washington Street East  
 Post Office Box 50130  
 Charleston, WV 25305-0130

# Request for Quotation

RFQ NUMBER  
 PRI10863

PAGE  
 2

ADDRESS CORRESPONDENCE TO ATTENTION OF  
 TARA LYLE  
 304-558-2544

RFQ COPY  
 TYPE NAME/ADDRESS HERE

VENDOR

Worldwide Equipment of WV  
 Charleston Division  
 P.O. Box 8557  
 South Charleston, WV 25303

SHIP TO

WV PRISON INDUSTRIES  
 617 LEON SULLIVAN WAY  
 CHARLESTON, WV  
 25301 304-558-2945

DATE PRINTED:	TERMS OF SALE	SHIP VIA	FOB:	FREIGHT TERMS
08/17/2011				

BID OPENING DATE: 08/31/2011 BID OPENING TIME 01:30PM

LINE	QUANTITY	UOP	QAT NO.	ITEM NUMBER	UNIT PRICE	AMOUNT
<p>VENDOR MUST CLEARLY UNDERSTAND THAT ANY VERBAL REPRESENTATION MADE OR ASSUMED TO BE MADE DURING ANY ORAL DISCUSSION HELD BETWEEN VENDOR'S REPRESENTATIVES AND ANY STATE PERSONNEL IS NOT BINDING. ONLY THE INFORMATION ISSUED IN WRITING AND ADDED TO THE SPECIFICATIONS BY AN OFFICIAL ADDENDUM IS BINDING.</p> <p> <i>Jackie A. C...</i>            SIGNATURE            Worldwide Equipment of WV            COMPANY            8/30/2011            DATE         </p> <p>NOTE: THIS ADDENDUM ACKNOWLEDGEMENT SHOULD BE SUBMITTED WITH THE BID.            REV. 09/21/2009</p> <p>END OF ADDENDUM NO. 1</p>						
0001	1	EA		070-53	87,779. <sup>00</sup>	87,779. <sup>00</sup>
				DELIVERY TRUCK		

SEE REVERSE SIDE FOR TERMS AND CONDITIONS

SIGNATURE <i>Jackie A. C...</i>	TELEPHONE 304-744-1321	DATE 8/30/2011
TITLE Sales Consultant	FEIN 451024981	ADDRESS CHANGES TO BE NOTED ABOVE

WHEN RESPONDING TO RFQ, INSERT NAME AND ADDRESS IN SPACE ABOVE LABELED 'VENDOR'

PRI10863  
Addendum No. 1

Q1: Is this unit to have a manual or automatic transmission? Both are listed in the specs.

A1: Automatic.



PRI10863

Specifications for a 2011 or newer delivery truck:

GVWR 33,000#, minimum

Diesel engine shall be a minimum of 260 hp, 660 lb-ft 7.68L displacement. Must meet 2010 emissions without the use of credits.

Heated fuel/water separator

Minimum 12 volt 130 amp alternator

Minimum two batteries with no less than 1200 cca total

Minimum 12 volt 4.8KW starter

AM/FM radio

Air conditioned cab

Information display

Dual electric horn

Minimum 18,357 BTU/h Heater/Defroster

LED marker lamps, stop/tail lights, back up lights, side flasher lights

Transmission to be Allison 2500RDS or equal

Single horizontal- driver side mounted inside frame rail exhaust system

Pto- electronic activation switch (electric hand throttle)

Transmission shall be manual 6-speed direct drive eaton-fuller FS6406A minimum

Clutch 14" valeo-single plate self adjusting minimum

Front axle 12,000 lbs. Minimum

Front oil seals with clear caps

Front suspension minimum of 12,000 lbs tapered leaf

Front stabilizer bar

Front & rear wheels steel disc 22.5" x 8.25", minimum

Front tires 11r22.5g rated 12,350lbs. Premium highway tread, minimum

Rear tires 11r22.5g rated 23000 lbs. Highway traction, minimum

Single speed rear axle 21,000 lbs., minimum

Axle ratio 3.90:1 or equal

Rear suspension multi-leaf 23,500 lbs, minimum

Rear auxiliary springs single leaf

Bolted rear suspension

Wheelbase no less than 260"

Frame rail 120,000 psi rated

Inverted "I" frame reinforcement 120,000psi with total frame increased rbm to a minimum of 3,229,200

Nose cone on top of cab

Dual 75 gallon step fuel tanks

Dual ac/dc fuel tank heaters with manual switch to change from truck power to 110 ac power when plugged in via power cord

Abs-4- channel bendix air brake system 's' cam type

Rear dust shields

Minimum of 12.9 cfm water-cooled air compressor

Air intake compressor

Bumper front chromed steel thickness 5/32" minimum

Two front tow hooks

Hystec style cab to frame mounts

Dual electric horn

Single dual air horn mounted on roof

Tilt steering wheel

Cruise control

Interior roof lamp

Air conditioning

Am/fm stereo radio

Exterior mirrors shall be electric remote control, lighted, heated 102" wide load mirrors with built in 6"x7" convex section

Truck and body shall be painted white

Driver seat shall be air suspension, high – back cloth national 2000 series or equal with arm rest

Passenger seat shall be two man cloth

Frame mounted tool box 18"x18"x36", minimum

On-spot chains mounted

24' dry freight van body

Plywood lined 3/8" full, minimum

Inside height 97.12"

Roll up rear door 94" w x 91.25" h

Subframe 3" i-beam crossmembers on 12" centers with 4" longrail

4-extra crossmembers located at rear on 6" centers

1 1/8" hardwood floor, minimum

Threshold steel diamond plate 1/8" x 23"

Scuff-side galvanized steel 12 ga 16" high, minimum

Translucent roof

Two dome lights

Two rows e-track each side

3300lb. Cap. Tuc-a-way lift gate with 80"x48" aluminum Platform

Alum. Body sides

Fork lift package

½" plywood liner front, minimum

Scuff front galvanized steel 12ga. 16" high, minimum

Triangle kit & 5# fire exts

Side door, to be located on curb side of body

**Warranty:**

All bidders must provide a copy of the manufacturer's warranty.

**Delivery:**

Delivery cost should be included with your bid. The truck should be delivered to the agency within 60 days of award of the contract.

**Award:**

The contract will be awarded to one vendor with the lowest grand total meeting all of the specifications with the most complete bid.

RFQ No. PR110863

STATE OF WEST VIRGINIA  
Purchasing Division

**PURCHASING AFFIDAVIT**

West Virginia Code §5A-3-10a states: No contract or renewal of any contract may be awarded by the state or any of its political subdivisions to any vendor or prospective vendor when the vendor or prospective vendor or a related party to the vendor or prospective vendor is a debtor and the debt owed is an amount greater than one thousand dollars in the aggregate.

**DEFINITIONS:**

"Debt" means any assessment, premium, penalty, fine, tax or other amount of money owed to the state or any of its political subdivisions because of a judgment, fine, permit violation, license assessment, defaulted workers' compensation premium, penalty or other assessment presently delinquent or due and required to be paid to the state or any of its political subdivisions, including any interest or additional penalties accrued thereon.

"Debtor" means any individual, corporation, partnership, association, limited liability company or any other form or business association owing a debt to the state or any of its political subdivisions. "Political subdivision" means any county commission; municipality; county board of education; any instrumentality established by a county or municipality; any separate corporation or instrumentality established by one or more counties or municipalities, as permitted by law; or any public body charged by law with the performance of a government function or whose jurisdiction is coextensive with one or more counties or municipalities. "Related party" means a party, whether an individual, corporation, partnership, association, limited liability company or any other form or business association or other entity whatsoever, related to any vendor by blood, marriage, ownership or contract through which the party has a relationship of ownership or other interest with the vendor so that the party will actually or by effect receive or control a portion of the benefit, profit or other consideration from performance of a vendor contract with the party receiving an amount that meets or exceeds five percent of the total contract amount.

**EXCEPTION:** The prohibition of this section does not apply where a vendor has contested any tax administered pursuant to chapter eleven of this code, workers' compensation premium, permit fee or environmental fee or assessment and the matter has not become final or where the vendor has entered into a payment plan or agreement and the vendor is not in default of any of the provisions of such plan or agreement.

Under penalty of law for false swearing (*West Virginia Code §61-5-3*), it is hereby certified that the vendor affirms and acknowledges the information in this affidavit and is in compliance with the requirements as stated.

**WITNESS THE FOLLOWING SIGNATURE**

Vendor's Name: Worldwide Equipment of WV

Authorized Signature: [Signature] Date: 8/30/2011

State of West Virginia

County of Kanawha, to-wit:

Taken, subscribed, and sworn to before me this 30 day of Aug., 2011.

My Commission expires July 13, 2017.

AFFIX SEAL HERE

NOTARY PUBLIC [Signature]





# State of West Virginia VENDOR PREFERENCE CERTIFICATE

Certification and application\* is hereby made for Preference in accordance with *West Virginia Code*, §5A-3-37. (Does not apply to construction contracts). *West Virginia Code*, §5A-3-37, provides an opportunity for qualifying vendors to request (at the time of bid) preference for their residency status. Such preference is an evaluation method only and will be applied only to the cost bid in accordance with the *West Virginia Code*. This certificate for application is to be used to request such preference. The Purchasing Division will make the determination of the Resident Vendor Preference, if applicable.

- 1. **Application is made for 2.5% resident vendor preference for the reason checked:**  
 Bidder is an individual resident vendor and has resided continuously in West Virginia for four (4) years immediately preceding the date of this certification; or,  
 Bidder is a partnership, association or corporation resident vendor and has maintained its headquarters or principal place of business continuously in West Virginia for four (4) years immediately preceding the date of this certification; or 80% of the ownership interest of Bidder is held by another individual, partnership, association or corporation resident vendor who has maintained its headquarters or principal place of business continuously in West Virginia for four (4) years immediately preceding the date of this certification; or,  
 Bidder is a nonresident vendor which has an affiliate or subsidiary which employs a minimum of one hundred state residents and which has maintained its headquarters or principal place of business within West Virginia continuously for the four (4) years immediately preceding the date of this certification; or,
- 2. **Application is made for 2.5% resident vendor preference for the reason checked:**  
 Bidder is a resident vendor who certifies that, during the life of the contract, on average at least 75% of the employees working on the project being bid are residents of West Virginia who have resided in the state continuously for the two years immediately preceding submission of this bid; or,
- 3. **Application is made for 2.5% resident vendor preference for the reason checked:**  
 Bidder is a nonresident vendor employing a minimum of one hundred state residents or is a nonresident vendor with an affiliate or subsidiary which maintains its headquarters or principal place of business within West Virginia employing a minimum of one hundred state residents who certifies that, during the life of the contract, on average at least 75% of the employees or Bidder's affiliate's or subsidiary's employees are residents of West Virginia who have resided in the state continuously for the two years immediately preceding submission of this bid; or,
- 4. **Application is made for 5% resident vendor preference for the reason checked:**  
 Bidder meets either the requirement of both subdivisions (1) and (2) or subdivision (1) and (3) as stated above; or,
- 5. **Application is made for 3.5% resident vendor preference who is a veteran for the reason checked:**  
 Bidder is an individual resident vendor who is a veteran of the United States armed forces, the reserves or the National Guard and has resided in West Virginia continuously for the four years immediately preceding the date on which the bid is submitted; or,
- 6. **Application is made for 3.5% resident vendor preference who is a veteran for the reason checked:**  
 Bidder is a resident vendor who is a veteran of the United States armed forces, the reserves or the National Guard, if, for purposes of producing or distributing the commodities or completing the project which is the subject of the vendor's bid and continuously over the entire term of the project, on average at least seventy-five percent of the vendor's employees are residents of West Virginia who have resided in the state continuously for the two immediately preceding years.

Bidder understands if the Secretary of Revenue determines that a Bidder receiving preference has failed to continue to meet the requirements for such preference, the Secretary may order the Director of Purchasing to: (a) reject the bid; or (b) assess a penalty against such Bidder in an amount not to exceed 5% of the bid amount and that such penalty will be paid to the contracting agency or deducted from any unpaid balance on the contract or purchase order.

By submission of this certificate, Bidder agrees to disclose any reasonably requested information to the Purchasing Division and authorizes the Department of Revenue to disclose to the Director of Purchasing appropriate information verifying that Bidder has paid the required business taxes, provided that such information does not contain the amounts of taxes paid nor any other information deemed by the Tax Commissioner to be confidential.

Under penalty of law for false swearing (*West Virginia Code*, §61-5-3), Bidder hereby certifies that this certificate is true and accurate in all respects; and that if a contract is issued to Bidder and if anything contained within this certificate changes during the term of the contract, Bidder will notify the Purchasing Division in writing immediately.

Bidder: Worldwide Equipment of WV      Signed: *Jackie A. [Signature]*  
 Date: 8 / 30 / 2011      Title: Sales Consultant

\*Check any combination of preference consideration(s) indicated above, which you are entitled to receive.



**WORLDWIDE EQUIPMENT ENTERPRISES, INC.**  
CHARLESTON DIVISION

August 31, 2011

**WORLDWIDE EQUIPMENT  
DIVISIONS  
AND SUBSIDIARIES**

**Kentucky**

Lexington  
(859) 281-5152  
Middlesboro  
(606) 248-5100  
Prestonsburg  
(606) 874-2172  
Somerset  
(606) 679-4321

**West Virginia**

Charleston  
(304) 744-1321  
Huntington  
(304) 736-3401  
Jane Lew  
(304) 884-7815  
Princeton  
(304) 425-7511

**Virginia**

Abingdon  
(276) 628-8103

**Tennessee**

Chattanooga  
(423) 892-8524  
Knoxville  
(865) 688-4300  
Knoxville - Asheville Hwy  
(865) 637-4333

**Ohio**

Cincinnati  
(513) 563-6363  
Dayton  
(937) 278-5775

**Worldwide Equipment  
Leasing, Inc.**  
Lexington, KY  
(859) 233-3740

**Worldwide Fabricating  
and Manufacturing, Inc.**

Lowmansville, KY  
(606) 297-1200

State of West Virginia  
Department of Administration  
Purchasing Division  
State Capital Complex  
2019 Washington Street, East  
PO Box 50130  
Charleston, WV 25305-0130

RE: RFQ PRI10863 WV Prisons Industry Delivery Truck

Ms. Lyle,

Thank you for this opportunity to submit a proposal on your vehicle needs.

Please find attached the vehicle build summary for a 2012 Kenworth T370 with a 24' box and a 3,300 lb liftgate.

This unit meets or exceeds your requirements with the following exceptions:

**Chassis**

Diesel engine is a 6.7L displacement instead of 7.68.  
Electric horn is a single instead of a dual.  
Single horizontal exhaust system is on the passenger side instead of the driver side.  
Total RBM of frame is 2,925,000 instead of 3,229,200.  
Air horn is a single instead of a dual.  
On spots are not included in our pricing.  
Fuel tank heaters are not included in our pricing.

**Body**

Inside height is 96" not 97.12"  
Roll up rear door is 88" w x 90.5" h not 94" w x 91.25" h.

**Delivery**

We will need to order this unit. Delivery should be within 90 days ARO.

Thank you again for this opportunity.

  
Jack Cummings  
Sales Consultant



Worldwide Equipment of WV W019

State of WV Prison Industries

, United States

Phone:

Fax:

Email:

, Phone:

Fax:

Contact Email:

Prepared for:

### Vehicle Summary

	Unit	Chassis	
Model:	T300 Series Conventional.	Fr Axle Load (lbs):	12000
Type:	FULL TRUCK	Rr Axle Load (lbs)	21000
Description:	Kenworth	G.C.W. (lbs):	33000
	<b>Application</b>	Road Conditions:	
Intended Serv.:	Local pickup & delivery.	Class A (Highway)	90
	Vehicles which haul	Class B (Hwy/Mtn)	10
Commodity:	General freight	Class C (Off-Hwy)	00
	<b>Body</b>	Class D (Off-Road)	00
Type:	Van	Maximum Grade:	6
Length (ft):	24.0	Wheelbase (in):	260
Height (ft):	12.0	Fr Axle to BOC (in):	68
Max Laden Weight (lbs):	4000	Cab to Axle (in):	192
	<b>Trailer</b>	Cab to EOF (in):	300
No. of Trailer Axles:	0		
Type:			
Length (ft):	0.0	<b>Special Req.</b>	
Height (ft):	0.0	U.S. Domestic Registry, 50-State	
Kingpin Inset (in):	0		
Corner Radius (in):	0		
	<b>Restrictions</b>		
Length (ft):	120		
Width (in):	102		
Height (ft):	13.5		

Approved by: \_\_\_\_\_

Date: \_\_\_\_\_

**Note: All sales are F.O.B. designated plant of manufacture.**

<b>PACCAR FINANCIAL</b>	Ask your dealer for a quote today, or visit our website @ <a href="http://www.paccarfinancial.com">www.paccarfinancial.com</a> .
	PACCAR Financial offers innovative finance, lease and insurance programs customized to meet your needs.

Unpublished options may require review/approval.

Printed: 8/22/2011 10:29:38 AM **Complete** Model Number: T300 Series Conventional.  
 Effective Date: Jul 1, 2011 Quote/DTPO/CO: Q22801176  
 Prepared by: Administrator Version Number: 27.01



Worldwide Equipment of WV W019

State of WV Prison Industries

, United States  
 Phone:  
 Fax:  
 Email:

, Phone:  
 Fax:  
 Contact Email:  
 Prepared for:

Data	Code	Description	\$ List	Weight
<b>Model</b>				
0000310	O	<b>T300 Series Conventional.</b> Electric Door locks LH/RH; Ignition & doors keyed alike; Single electric horn; Single-piece windshield; Electric windshield wipers, 2-speed plus intermittent; Electric windshield washers; Steering wheel 18in. 4-spoke; Glovebox door with locking latch; Dash-mounted cruise control with switches; Turn signal switch with column-mounted dimmer; Standard dash panels include gray w/ burl wood accents; Slate Gray interior primary color; Dark Slate Gray seat color; Floor mat; Inside sunvisor, LH/RH; Door courtesy lights; Under-dash center console with 1 cup holder, 1 ashtray & 1 lighter.	72,408	9,759
0070006	O	<b>T370 Class 7: medium-duty Conventional.</b>	0	0
0080075	O	<b>Dealer/Customer declines engine w/CARB Idle Emissions Reduction Feature.</b>	0	0
0090015	O	<b>Medium-duty 4x2 automatic.</b>	0	0
0091090	O	<b>General freight</b>	0	0
0093005	O	<b>Local pickup &amp; delivery. Vehicles which haul freight, typically operating within a 100-mile radius, on public streets &amp; highways, &amp; other paved surfaces, including limited Class C roads. Includes package &amp; freight delivery, as well as fuel oil or petroleum distribution, etc. Road usage: minimum 3% Class B, do not code for Class D.</b>	0	0
0095120	O	<b>Van</b>	0	0
0098025	O	<b>U.S. Domestic Registry, 50-State</b>	0	0

**Engine & Equipment**

0120860	O	<b>PACCAR PX-6 260 2010 260@2400 250@2600 660@1600.</b> Includes turbo exhaust brake, no code is used. Diagnostic Plug for data link, Oil Cooler, Aluminum Flywheel Housing. N09020 P02 Yes...Cruise Control Auto Resume N09040 P04 No....Auto Engine Brake in Cruise N09060 P06 Yes...Gear Down Protection N09100 P11 No....Engine Protection Shtdwn N09120 P14 75....Max Vehicle Speed in Top Gea N09140 P19 70....Max Cruise Control Speed N09160 P26 1400..Max PTO Speed N09180 P10 Yes...Idle Shtdwn N09200 P32 5.....Idle Shtdwn Time N09220 P33 No....Idle Shtdwn Override	1,924	0
1000152	O	<b>Prospector version 27.0 supersedes previous version 26.1</b>	0	0
1002060	S	<b>Air compressor: Cummins 18.7 CFM, ISC, ISL, ISM &amp; ISX, PX-6, PX-8 &amp; Westport GX.</b>	0	0

Unpublished options may require review/approval.  
 Dimensional and performance data for unpublished options may vary from that displayed in PROSPECTOR.

Printed: 8/22/2011 10:29:38 AM **Complete** Model Number: T300 Series Conventional.  
 Effective Date: Jul 1, 2011 Quote/DTPO/CO: Q22801176  
 Prepared by: Administrator Version Number: 27.01



Data	Code	Description	\$ List	Weight
1031130	S	<b>Air Cleaner: Dry-type firewall mounted w/filter restriction indicator.</b>	0	0
1121200	S	<b>Cooling module: 1000 square inches T170/T270/T370/T470.</b>	0	0
1247135	S	<b>Horizontal series SCR for PX-6 w/ horizontal tailpipe below RH rail back of cab.</b>	0	-35
1323004	O	<b>Fuel filter heated PACCAR PX-6 engines only.</b>	46	2
1816161	O	<b>Alternator: Bosch 160 amp, brush type only.</b>	-48	0
1821225	O	<b>Batteries: 2 PACCAR GP31 threaded post (1000) 2000 CCA starting. 12-VOLT LIGHT SYSTEM W/CIRCUIT PROTECTION</b>	-25	-6
1836100	S	<b>Starter: PACCAR 12 volt electrical system. W/ centralized power distribution incorporating plug-in style relays. Circuit protection for serviceability, 12-volt light system w/circuit protection circuits number &amp; color coded.</b>	0	0
<b>Transmission &amp; Clutch</b>				
2010749	O	<b>Transmission: Allison 2500RDS 5-speed w/PTO drive gear. Includes heat exchanger. Rugged Duty Series for vocational applications. Transynd transmission fluid is standard on all Allison 1000, 2000, 3000 &amp; 4000 series transmissions.</b>	4,748	48
2401905	O	<b>Driveline: 3 standard-duty; 2 centerbearing.</b>	1,099	169
2410018	O	<b>Torque converter included w/Allison Transmission.</b>	0	0
<b>Front Axle &amp; Equipment</b>				
2502203	O	<b>Dana Spicer E-1202I Front Axle rated 12K 3-1/2in. drop.</b>	0	0
2603006	S	<b>Front brakes included w/ front hub package.</b>	0	0
2701000	S	<b>Air Brake: 14,600 lb. package includes 16-1/2 x5 brakes, cast drums, aluminum 10-bolt hub pilot LMS hubs, hubcaps, oil seals &amp; automatic slack adjusters. For use w/ 22-1/2in. wheels.</b>	0	0
2863015	O	<b>Front Springs: Taperleaf 12K w/ shock absorber for use on 2010+ chassis w/ 22.5in. wheels only.</b>	63	12
2893071	S	<b>Single power steering gear: 13.2K TRW THP60 for air brakes. Use only w/ 2010+ chassis.</b>	0	0
<b>Rear Axle &amp; Equipment</b>				
3031170	O	<b>Single Dana Spicer S21-170 single reduction rear axle. Single rear axle rated at 21K.</b>	690	182
3200391	O	<b>Rear Axle Ratio - 3.91.</b>	0	0
3300000	S	<b>Single rear brakes included w/rear hub package.</b>	0	0
3401001	S	<b>23K air brake package includes 16-1/2x7 in.</b>	0	0



brakes, cast drums, aluminum 10-bolt hub pilot LWS hubs, automatic slack adjusters and oil seals for use w/ 22.5 in. wheels.

3485009	S	<b>Spring Brake: 3030 high output single.</b>	0	0
3490047	O	<b>Dustshields for drum brakes: all rear axles.</b>	63	11

Unpublished options may require review/approval.  
Dimensional and performance data for unpublished options may vary from that displayed in PROSPECTOR.

Printed: 8/22/2011 10:29:38 AM **Complete** Model Number: T300 Series Conventional.  
Effective Date: Jul 1, 2011 Quote/DTPO/CO: Q22801176  
Prepared by: Administrator Version Number: 27.01



Data	Code	Description	\$ List	Weight
3495226	S	<b>Bendix 4S/4M anti-lock brake system.</b> Current generation ECU is Bendix ABS 6.	0	0
3646417	O	<b>Rear suspension: single Reyco 79KB 26K. Multileaf</b> helper spring medium-duty. Unladen Height: 11.3 in. Laden Height: 8.2 in.	477	119
3836315	O	<b>Heavy-duty rear suspension crossmembers for Reyco</b> 79KB replacing T3 standard.	74	41
<b>Tires &amp; Wheels</b>				
4079023	O	<b>Front tires: Bridgestone R250F 11R22.5 14PR.</b> 41.3 in. diameter, all position. F=side wall protector bar. For P&D & construction vocations. 19.3 in. SLR.	-112	4
4279023	O	<b>Rear tires: Bridgestone R250F 11R22.5 14PR.</b> 41.3 in diameter, all position. F=side wall protector bar. For P&D & construction vocations. 19.3 in. SLR. Code is priced per pair of tires.	-224	8
4900004	O	<b>Rear Tire Quantity: 4</b>	0	0
5042255	S	<b>Front wheel: Accuride 50487PW 22.5x8.25 steel</b> white e-coat, hub pilot mount. 7400lb. maximum rating. 5-hand hole.	0	0
5242255	S	<b>Rear wheel:Accuride 50487PW 22.5x8.25 steel</b> white e-coat, hub pilot mount. 7400 lb. maximum rating. 5-hand hole. Code is priced per pair of wheels.	0	0
5900004	O	<b>Rear Wheel/Rim Quantity: 4</b>	0	0
<b>Frame &amp; Equipment</b>				
6054630	O	<b>Frame Rails: 10-5/8 x 3-1/2 x 5/16 in. Steel to</b> 381 in. to 428 in. Truck frame weight is 2.91 lb.-in. per pair of rails. Section modulus is 14.80 cu.in., RBM is 1,776,000 in-lbs per rail. 120,000 PSI yield. Heat treated. Frame rail availability may be restricted based upon application, axle/suspension capacity, fifth wheel setting, or component/dimensional specifications. The results of the engineering review may result in a change to the requested frame rail. If a change is required Kenworth Application Engineering will advise the dealer of the appropriate material specification for a substitute rail.	697	489
6141650	O	<b>Full Steel Insert: for 10-5/8 in. or 10-3/4 in.</b> steel rail >348 - 480 in. Medium-duty. Adds 1,149,000 in-lb to main rail RBM. Truck insert weight is 2.05 lb.-in. per pair of rails. Full frame insert length is equal to wheelbase plus rear frame cutoff plus 20.7 in. forward of front axle.	1,979	754
6308715	O	<b>Bumper: Aerodynamic Chrome Requires a bumper</b> setting code.	257	0
6319409	S	<b>40.9 in. Bumper setting. Requires a bumper code.</b>	0	0
6321005	O	<b>Removable Front Tow Hooks: 2.</b>	125	15
6390103	S	<b>Front mudflaps.</b>	0	0

6400636	O	Battery box cantilever aluminum BOC w/ Fiberglass cover.	114	141
6409901	O	Battery box location: LH Side.	0	0
6741023	O	Square end-of-frame w/ bolted crossmember non-towing.	157	41

## Fuel Tanks & Equip

Unpublished options may require review/approval.  
Dimensional and performance data for unpublished options may vary from that displayed in PROSPECTOR.

Printed: 8/22/2011 10:29:38 AM **Complete** Model Number: T300 Series Conventional.  
Effective Date: Jul 1, 2011 Quote/DTPO/CO: Q22801176  
Prepared by: Administrator Version Number: 27.01



Data	Code	Description	\$ List	Weight
7010075	O	<b>Fuel Tank: 75 US gallon 22in. aluminum under</b> replace. Class 8 fuel tank includes an anti-siphon device on the filler neck.	181	-11
7012075	O	<b>Fuel Tank: 75 US gallon 22in. aluminum under add.</b> Class 8 fuel tank includes an anti-siphon device on the filler neck. Multiple tank installations include a fuel equalization system w/ dual draw and return lines with a splitter valve located within 6 inches behind the cab. Single draw and return is an option in some cases.	1,327	90
7722020	O	<b>Medium round DEF tank. 18 gallons</b> of useable volume. The tank will be located just rearward of the under cab component on the side you specified, but will not be displayed in the Prospector graphic. Required capacity is calculated by fuel capacity of the vehicle and is a minimum of 6% by volume. This capacity will accommodate two diesel re-fillings for every DEF re-filling.	319	32
7889603	O	<b>DEF tank location is on the RH.</b>	0	0
7910075	O	<b>Location: 75 gal fuel tank RH under cab</b>	0	0
7920075	O	<b>Location: 75 gal fuel tank LH under cab</b>	0	0

## Cab & Equipment

8024310	S	<b>Cab: Curved Glass Conventional.</b> Cab Includes aluminum & fiberglass fully hucked cab w/ all aluminum bulkhead doors & continuous stainless steel piano-style door hinges. Single electric horn standard. Incandescent exterior lights include diagnosable bulb detection and warning. Trailer cable on tractors includes integrity detection. Standard features include multiplex wiring for interior lights, automated pre-trip inspection, short and open check diagnostics, and programmable daytime running lights. Warning alarm will sound when lights are left on.	0	0
8090310	S	<b>Hood: Sloped aerodynamic hood includes</b> grill & separate bumper.	0	0
8108010	S	<b>Cab heater: W/integral defrosters &amp; A/C 45,000</b> btu cab heater. No sleeper heater/AC. Includes 5 mode rotary control. T660 include filter media.	0	0
8201200	O	<b>Adjustable telescoping tilt steering column.</b>	376	8
8205045	O	<b>Flip valve: On dash for single speed PTO.</b> Customer-installed. Includes indicator light & piping.	143	2
8205093	O	<b>Information for customer-installed PTO Chelsea</b> 880 8-bolt.	0	0
8282009	S	<b>Instrument package: Includes speedometer,</b> tachometer, fuel gauge, engine coolant temperature gauge, engine oil	0	0

pressure, voltmeter. Class 0 also includes primary & secondary air reservoir gauges & an air application gauge. DEF level gauge and warning lamp are included with 2010 engines. Engine hour meter and outside air temperature readouts are standard. Primary read out will be MPH. Add 8240620 to switch primary scale to KPH in Canada.

8330003	S	<b>Cab interior: Pinnacle. Includes vinyl headliner</b> & cab back panel, slate gray interior, dark slate gray seats, floormats, LH/RH inside sunvisor & door courtesy lights.	0	0
---------	---	---	---	---

Unpublished options may require review/approval.  
Dimensional and performance data for unpublished options may vary from that displayed in PROSPECTOR.

Printed:	8/22/2011 10:29:38 AM	<b>Complete</b>	Model Number:	T300 Series Conventional.
Effective Date:	Jul 1, 2011		Quote/DTPO/CO:	Q22801176
Prepared by:	Administrator		Version Number:	27.01



Data	Code	Description	\$ List	Weight
8410092	O	<b>Driver seat: Kenworth Air cushion Premium Plus HB</b> cloth. Standard features includes 7 in. fore and aft slide adjustment w/isolator, 6-58 degree recline, air suspension w/ cover, dual armrests, and triple chamber air lumbar support. Cushion and back include air adjustment. Seat cushion is 20 inches wide w/ 2-position tilt and 6-position front cushion support. Seat material has a horizontal stitch pattern and is 2-tone in color. Standard storage includes a side bolster pocket and a hanging pocket. Seat back is carpeted, and high back seats include a storage pocket. Seat is manufactured by National. Includes inside visor and retractable 3-point matching seat belts. Black seat belts for T700, gray on all other models.	292	0
8480060	O	<b>Rider seat: 2 man bench cloth.</b> Standard features include 34.5 in. wide 2-tone seat cushion w/ fixed base. Armrests are not available. Seat back is carpeted. Includes inside visor and retractable 3-point matching seat belts. Black seat belts for T700, gray on all other models.	475	61
8601406	O	<b>Kenworth radio: AM/FM/weather band. W/LED</b> lighting.	253	4
8700144	O	<b>Dome lamp over driver door.</b>	17	0
8700154	O	<b>Self cancelling turn signal: W/head light dimmer</b> switch .	15	0
8800200	S	<b>Cab access contoured grabhandles, LH/RH.</b>	0	0
8832112	S	<b>Daylite doors, includes RH peeper window.</b> Ignition and doors are keyed alike. Electric locks are standard on both cab doors.	0	0
8841303	O	<b>Single rectangular air horn 23 in. LH top of roof</b> Includes air horn cover.	118	6
8850210	S	<b>Dual convex mirrors 7-1/2 in. w/ offset mounting.</b>	0	0
8850300	S	<b>Single convex mirror 8-1/2 in. x 4-7/16 in.</b> located on rider side.	0	0
8867202	O	<b>Mirror: Dual Moto heated mirrors 7 in. x 16 in.</b> LH & RH remote controlled. Switch located on door pad.	402	4
8869005	S	<b>Mirror brackets 8-1/2 ft load width.</b>	0	0
8871438	S	<b>Rear cab stationary window 17 in. x 36 in.</b>	0	0

8879200	S	<b>Manual LH &amp; electric-powered RH door window.</b> Switch located on door.	0	0
---------	---	--	---	---

**Lights & Instruments**

9010801	S	<b>Headlamps: Low beam dual complex reflector,</b> high beam halogen.	0	0
9022137	O	<b>Marker Lights: Five, rectangular, LED</b>	88	0
9030010	S	<b>Turn Signal Lights: Mounted on fender</b>	0	0
9070012	O	<b>LED Stop/Turn/Tail - Flange Mounted</b> with two LED backup lights	78	0
9090312	O	<b>Body Builder Harness: Provides harness to extend</b> tail, turn, stop & marker light circuits from standard body builder connector BOC to the end-of-frame. There is a plug on the chassis end & the opposite end is just wires.	74	0

**Air Equipment**

Unpublished options may require review/approval.  
Dimensional and performance data for unpublished options may vary from that displayed in PROSPECTOR.

Printed:	8/22/2011 10:29:38 AM	<b>Complete</b>	Model Number:	T300 Series Conventional.
Effective Date:	Jul 1, 2011		Quote/DTPO/CO:	Q22801176
Prepared by:	Administrator		Version Number:	27.01



Data	Code	Description	\$ List	Weight
9101210	S	<b>Air Dryer: Bendix AD-IS heated.</b>	0	0

**Extended Warranty**

9200022	S	<b>Medium-duty Warranty: 1-year/unlimited mi.</b>	0	0
9210211	O	<b>2010 EPA medium duty Surcharge \$7000.</b>	7,000	0

**Miscellaneous**

9490003	O	<b>Additional lead time required for off highway &amp;</b> /or speciality component truck.	0	0
9490206	O	<b>Triangle reflector kit. Kit consists of 3</b> triangles in plastic carrying case.	25	4
9490404	O	<b>One 5 lb. dry chemical type fire extinguisher</b> mounted outboard of driver seat.	93	11

**Paint**

9700000	O	<b>Paint color number.</b> N97020 A - L0006EB WHITE B/C N97200 FRAME N0001EA BLACK	0	0
9943119	S	<b>Imron solid 1 color non-sleeper Spec A.</b>	0	0
9965510	S	<b>Base coat/clear coat.</b> The Kenworth Color Selector contains additional instructions, as well as information on Kenworth paint guidelines and surface finish applications. Kenworth is standard with Dupont Imron Elite paint.	0	0

Total Adjusted Price (W/O Freight & Warranty & Surcharges)	\$88,788
Freight Charge	\$1,875
Options Not Subject to Discount	\$0
2010 EPA Engine Surcharge Not subject to Discount	\$7,000
Total Weight	11965

---

Unpublished options may require review/approval.  
Dimensional and performance data for unpublished options may vary from that displayed in PROSPECTOR.

---

Printed:	8/22/2011 10:29:38 AM	<b>Complete</b>	Model Number:	T300 Series Conventional.
Effective Date:	Jul 1, 2011		Quote/DTPO/CO:	Q22801176
Prepared by:	Administrator		Version Number:	27.01



# *ALUMINUM VAN BODY QUOTATION*

**LENGTH: 24' I.D.**

**WIDTH: 96" O.D.**

**HEIGHT: 96" I.D.**

<b>Construction:</b>	(.040) Pre-painted white aluminum panels with high strength extruded aluminum (not steel) "Z" posts on 16" centers. Seven front wall posts (not five) for added strength and durability. Extruded aluminum front corner radius posts, (not roll formed) for maximum strength.
<b>Roof:</b>	(.060) translucent roof panel with anti-snag roof bows on 24" centers, "Zephyr" 12" fuel saving roof radius design with heavy-duty cast aluminum (not plastic) corner castings.
<b>Rear Frame:</b>	11 Ga. Galvaneal steel, internally and externally reinforced, and gusseted at all stress points, painted to match.
<b>Side Door(s):</b>	45" x 76" DuraPlate single panel construction at standard location on <i>curbside</i> with heavy duty extruded aluminum hinges, exclusive internal bar lock, stirrup step below.
<b>Rear Door:</b>	Standard plastic covered ¾" plywood roll up, 88" wide x 90.5" high clear opening. Stainless steel rivets and "E" coated hardware.
<b>Rear:</b>	Interlift ILP-33 tuck under liftgate, 3300 lb. capacity, 80" x 48" aluminum platform, level ride operation, HD dock bumper, rubber bumper blocks, cab cut off switch
<b>Grab Handle(s):</b>	Curb side and road side on rear frame.
<b>Rear Lighting:</b>	Use OEM tail lights.
<b>Floor:</b>	1-1/8" high quality domestic laminated hardwood. 24" x 1/8" steel threshold plate at rear, with front edge routed into flooring.
<b>Cross members:</b>	3" steel I-Beam cross members on 12" centers with full steel wheel pan support over wheel area.
<b>Interior Sides:</b>	Sides - 3/8" full height premium plywood.
<b>Interior Front:</b>	Front - 1/2" full height premium plywood.
<b>Interior Ties:</b>	Sides - Two (2) row(s) recessed "E" Track @ ___ & ___" on center. Front - None.
<b>Scuff Plate:</b>	Sides - 16" x 12 Ga. smooth steel. Front - 16" x 12 Ga. smooth steel extending below floor, welded to front understructure for maximum front wall strength.
<b>Lights:</b>	Interior - Two (2) dome light(s) with switch at rear, inside door on curbside. <i>Note: When switch is supplied by chassis OEM, dome light will be wired to factory switch in cab.</i> Exterior - per FMVSS - 108 with reflectors.
<b>Undercoating:</b>	Petroleum base undercoating applied, (not paint) full understructure.
<b>Mounting:</b>	Hardwood isolator with 5/8" zinc plated U-bolts installed through custom cut steel crush pipes between chassis frame. Structural steel channel anti-shift "side standards" welded to structural steel long sills. Complete factory mounting on drop shipped chassis with "U.S. Truck Body" or customer supplied mud flaps.
<b>Understructure:</b>	Unless noted below in ADDITIONAL FEATURES, this body is quoted and built for a single axle chassis. Tandem axle chassis require the <i>additional cost option</i> for our <i>Tandem Axle Reinforcement Package</i> .

**ADDITIONAL FEATURES INCLUDED:**

1. Four extra cross members at rear on 6" centers.
2. 4" long sills.
3. One Day Mount with liftgate.

# ILP PALLET PRO

2500 and 3300 lbs. Capacity

**MBB PALFINGER**

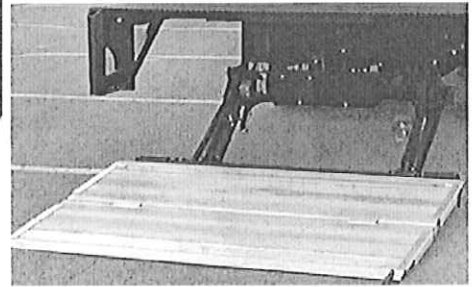
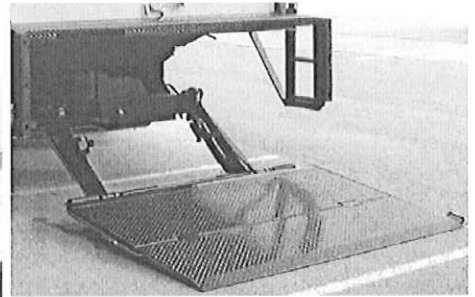
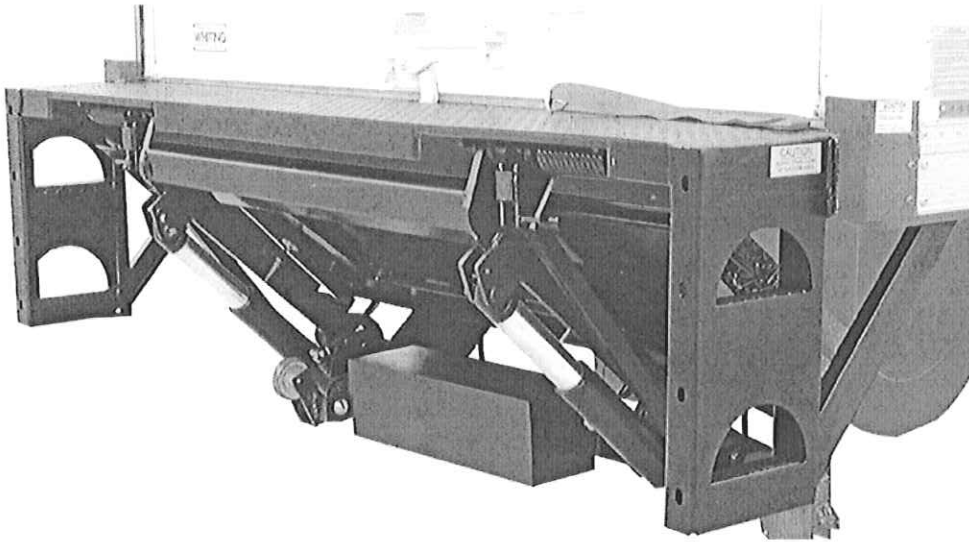

**—OPTIMIZED—**  
FLEXIBILITY  
DURABILITY  
PROFITABILITY

The ILP Pallet Pro provides a lot of value for a small premium. Level ride platforms available in a variety of sizes from 48", 54", 60" x 80". Units are available in several steel and aluminum combinations.

**LARGE Platform Lift! SMALL Platform Price!**

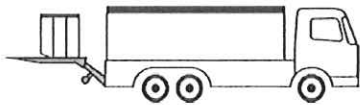

## HEAVY DUTY CONSTRUCTION

- Bushings & zerks at all pivot points
- Heat treated pins
- Wide lift arm:
  - Provides added stability
  - Accepts a fixed hitch
- Thermo protected powerpack
- Increases life of components
- 150 AMP circuit breaker

## BUILT IN STANDARD/ SAFETY FEATURES

- Dual cylinder stability
- Cab shut off switch
- Hydraulic cylinder locks on cylinder ports
- Adjustable roller and dual torsion assist offer minimum effort for platform folding
- Level ride platform
- Wide bed height range:
  - The 48" platform unit can be installed on as low as 38" laden bed height/up to 53" unladen

The MBB PALFINGER Pallet Pro, offering a platform size, level ride and lift capacity to handle many palletized or carted freight safely at a budget price.

MBB PALFINGER liftgates are pre-filled with aerospace hydraulic fluid. Our standard hydraulic cylinder lock provides added stability, better user control and improved safety.

The two cylinder mid arm design can accommodate a fixed receiver hitch. The platform rotates on an adjustable roller to adapt for different bed height installations.

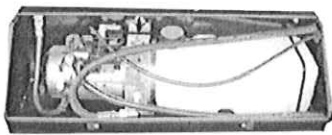

The thermo protected PowerPack is fully enclosed in a H/D powder coated steel box for protection and easy inspection. By using over sized quality components, we minimize maintenance and downtime.



The ILP incorporates our double torsions on both the main and folded section. The unique leveling joint on the ILP does not rotate on the ground. This makes the ILP an exceptionally smooth operating lift.

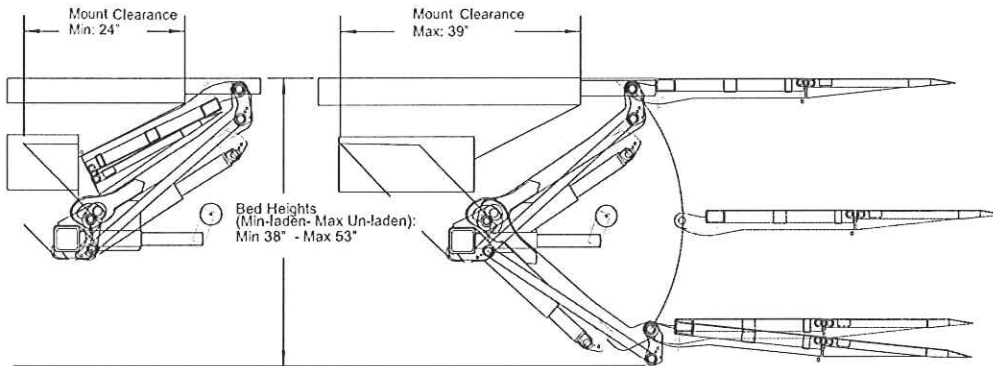

**LIFTGATE OPTIONS:**

- Auxiliary truck and trailer kits
- Dock bumpers
- Rubber pads
- Cart stops
- DOT rear impact guard
- Extra heavy duty trailer dock bumpers
- Hand held remote
- Aluminum tip sections
- All aluminum platforms
- Wireless remote
- 2" Receiver hitch

Model	Lifting Capacity (lbs)	Platform Length (inches)	Platform Width (inches)	Bed Height (inches)	Approx. Weight (lbs)	Mount Clearance (inches)
ILP 25	2500	48	80	38 - 53	750	21 - 30
ILP 33	3300	48	80	38 - 53	840	21 - 30
ILP 33	3300	54	80	45 - 55	900	24 - 34
ILP 33	3300	60	80	45 - 55	930	24 - 34