



State of West Virginia
 Department of Administration
 Purchasing Division
 2019 Washington Street East
 Post Office Box 50130
 Charleston, WV 25305-0130

Request for Quotation

RFQ NUMBER
DNRB11212

PAGE
1

ADDRESS CORRESPONDENCE TO ATTENTION OF
**FRANK WHITTAKER
 304-558-2316**

VENDOR

RFQ COPY
 TYPE NAME/ADDRESS HERE
**GRAYBAR ELECTRIC
 1010 YOUNG STREET
 CHARLESTON, WV 25301**

SHIP TO

**DIVISION OF NATURAL RESOURCES
 VARIOUS LOCALES AS INDICATED
 BY ORDER**

DATE PRINTED	TERMS OF SALE	SHIP VIA	FOB	FREIGHT TERMS
06/16/2011				

BID OPENING DATE: **07/20/2011** BID OPENING TIME **01:30PM**

LINE	QUANTITY	UOP	CAT NO	ITEM NUMBER	UNIT PRICE	AMOUNT
0001	1	LS		840-60		\$167,750.00
<p>FLAT SCREEN TELEVISIONS</p> <p>THE WEST VIRGINIA PURCHASING DIVISION, FOR THE AGENCY, THE WEST VIRGINIA DIVISION OF NATURAL RESOURCES IS SOLICITING BIDS FOR FLAT SCREEN TELEVISIONS AND MOUNTING HARDWARE FOR SEVERAL STATE PARKS, PER THE ATTACHED SPECIFICATIONS.</p> <p>ALL TECHNICAL QUESTIONS MUST BE SUBMITTED IN WRITING TO FRANK WHITTAKER IN THE WV PURCHASING DIVISION VIA EMAIL AT FRANK.M.WHITTAKER@WV.GOV OR VIA FAX AT 304-558-4115. DEADLINE FOR TECHNICAL QUESTIONS IS 06/28/2011 AT 4:00 PM. ALL TECHNICAL QUESTIONS WILL BE ADDRESSED BY ADDENDUM AFTER THE DEADLINE.</p> <p>EXHIBIT 4</p> <p>LOCAL GOVERNMENT BODIES: UNLESS THE VENDOR INDICATES IN THE BID HIS REFUSAL TO EXTEND THE PRICES, TERMS, AND CONDITIONS OF THE BID TO COUNTY, SCHOOL, MUNICIPAL AND OTHER LOCAL GOVERNMENT BODIES, THE BID SHALL EXTEND TO POLITICAL SUBDIVISIONS OF THE STATE OF WEST VIRGINIA. IF THE VENDOR DOES NOT WISH TO EXTEND THE PRICES, TERMS, AND CONDITIONS OF THE BID TO ALL POLITICAL SUBDIVISIONS OF THE STATE, THE VENDOR MUST CLEARLY INDICATE SUCH REFUSAL IN HIS BID. SUCH REFUSA</p>						



SEE REVERSE SIDE FOR TERMS AND CONDITIONS

SIGNATURE: *Kenneth Hupp* TELEPHONE: **304-344-2371** DATE: **7-20-11**

TITLE: **SALES REP** FEIN: **130794380001** ADDRESS CHANGES TO BE NOTED ABOVE

WHEN RESPONDING TO RFQ, INSERT NAME AND ADDRESS IN SPACE ABOVE LABELED 'VENDOR'

GENERAL TERMS & CONDITIONS REQUEST FOR QUOTATION (RFQ) AND REQUEST FOR PROPOSAL (RFP)

1. Awards will be made in the best interest of the State of West Virginia.
2. The State may accept or reject in part, or in whole, any bid.
3. Prior to any award, the apparent successful vendor must be properly registered with the Purchasing Division and have paid the required \$125 fee.
4. All services performed or goods delivered under State Purchase Order/Contracts are to be continued for the term of the Purchase Order/Contracts, contingent upon funds being appropriated by the Legislature or otherwise being made available. In the event funds are not appropriated or otherwise available for these services or goods this Purchase Order/Contract becomes void and of no effect after June 30.
5. Payment may only be made after the delivery and acceptance of goods or services.
6. Interest may be paid for late payment in accordance with the *West Virginia Code*.
7. Vendor preference will be granted upon written request in accordance with the *West Virginia Code*.
8. The State of West Virginia is exempt from federal and state taxes and will not pay or reimburse such taxes.
9. The Director of Purchasing may cancel any Purchase Order/Contract upon 30 days written notice to the seller.
10. The laws of the State of West Virginia and the *Legislative Rules* of the Purchasing Division shall govern the purchasing process.
11. Any reference to automatic renewal is hereby deleted. The Contract may be renewed only upon mutual written agreement of the parties.
12. **BANKRUPTCY:** In the event the vendor/contractor files for bankruptcy protection, the State may deem this contract null and void, and terminate such contract without further order.
13. **HIPAA BUSINESS ASSOCIATE ADDENDUM:** The West Virginia State Government HIPAA Business Associate Addendum (BAA), approved by the Attorney General, is available online at www.state.wv.us/admin/purchase/vrc/hipaa.htm and is hereby made part of the agreement. Provided that the Agency meets the definition of a Cover Entity (45 CFR §160.103) and will be disclosing Protected Health Information (45 CFR §160.103) to the vendor.
14. **CONFIDENTIALITY:** The vendor agrees that he or she will not disclose to anyone, directly or indirectly, any such personally identifiable information or other confidential information gained from the agency, unless the individual who is the subject of the information consents to the disclosure in writing or the disclosure is made pursuant to the agency's policies, procedures, and rules. Vendor further agrees to comply with the Confidentiality Policies and Information Security Accountability Requirements, set forth in <http://www.state.wv.us/admin/purchase/privacy/noticeConfidentiality.pdf>.
15. **LICENSING:** Vendors must be licensed and in good standing in accordance with any and all state and local laws and requirements by any state or local agency of West Virginia, including, but not limited to, the West Virginia Secretary of State's Office, the West Virginia Tax Department, and the West Virginia Insurance Commission. The vendor must provide all necessary releases to obtain information to enable the director or spending unit to verify that the vendor is licensed and in good standing with the above entities.
16. **ANTITRUST:** In submitting a bid to any agency for the State of West Virginia, the bidder offers and agrees that if the bid is accepted the bidder will convey, sell, assign or transfer to the State of West Virginia all rights, title and interest in and to all causes of action it may now or hereafter acquire under the antitrust laws of the United States and the State of West Virginia for price fixing and/or unreasonable restraints of trade relating to the particular commodities or services purchased or acquired by the State of West Virginia. Such assignment shall be made and become effective at the time the purchasing agency tenders the initial payment to the bidder.

I certify that this bid is made without prior understanding, agreement, or connection with any corporation, firm, limited liability company, partnership, or person or entity submitting a bid for the same material, supplies, equipment or services and is in all respects fair and without collusion or fraud. I further certify that I am authorized to sign the certification on behalf of the bidder or this bid.

INSTRUCTIONS TO BIDDERS

1. Use the quotation forms provided by the Purchasing Division. Complete all sections of the quotation form.
2. Items offered must be in compliance with the specifications. Any deviation from the specifications must be clearly indicated by the bidder. Alternates offered by the bidder as **EQUAL** to the specifications must be clearly defined. A bidder offering an alternate should attach complete specifications and literature to the bid. The Purchasing Division may waive minor deviations to specifications.
3. Unit prices shall prevail in case of discrepancy. All quotations are considered F.O.B. destination unless alternate shipping terms are clearly identified in the quotation.
4. All quotations must be delivered by the bidder to the office listed below prior to the date and time of the bid opening. Failure of the bidder to deliver the quotations on time will result in bid disqualifications: Department of Administration, Purchasing Division, 2019 Washington Street East, P.O. Box 50130, Charleston, WV-25305-0130
5. Communication during the solicitation, bid, evaluation or award periods, except through the Purchasing Division, is strictly prohibited (W.Va. C.S.R. §148-1-6.6).



State of West Virginia
 Department of Administration
 Purchasing Division
 2019 Washington Street East
 Post Office Box 50130
 Charleston, WV 25305-0130

Request for Quotation

RFQ NUMBER
DNRB11212

PAGE
2

ADDRESS CORRESPONDENCE TO ATTENTION OF
FRANK WHITTAKER
304-558-2316

VENDOR

RFQ COPY
 TYPE NAME/ADDRESS HERE

SHIP TO

DIVISION OF NATURAL RESOURCES
 VARIOUS LOCALES AS INDICATED
 BY ORDER

DATE PRINTED	TERMS OF SALE	SHIP VIA	FOB	FREIGHT TERMS
06/16/2011				
BID OPENING DATE: 07/20/2011		BID OPENING TIME 01:30PM		

LINE	QUANTITY	UOP	CAT. NO.	ITEM NUMBER	UNIT PRICE	AMOUNT
<p>SHALL NOT PREJUDICE THE AWARD OF THIS CONTRACT IN ANY MANNER.</p> <p>REV. 3/88 EXHIBIT 3</p> <p>LIFE OF CONTRACT: THIS CONTRACT BECOMES EFFECTIVE ON AND EXTENDS FOR A PERIOD OF ONE (1) YEAR OR UNTIL SUCH "REASONABLE TIME" THEREAFTER AS IS NECESSARY TO OBTAIN A NEW CONTRACT OR RENEW THE ORIGINAL CONTRACT. THE "REASONABLE TIME" PERIOD SHALL NOT EXCEED TWELVE (12) MONTHS. DURING THIS "REASONABLE TIME" THE VENDOR MAY TERMINATE THIS CONTRACT FOR ANY REASON UPON GIVING THE DIRECTOR OF PURCHASING 30 DAYS WRITTEN NOTICE.</p> <p>UNLESS SPECIFIC PROVISIONS ARE STIPULATED ELSEWHERE IN THIS CONTRACT DOCUMENT, THE TERMS, CONDITIONS AND PRICING SET HEREIN ARE FIRM FOR THE LIFE OF THE CONTRACT.</p> <p>RENEWAL: THIS CONTRACT MAY BE RENEWED UPON THE MUTUAL WRITTEN CONSENT OF THE SPENDING UNIT AND VENDOR, SUBMITTED TO THE DIRECTOR OF PURCHASING THIRTY (30) DAYS PRIOR TO THE EXPIRATION DATE. SUCH RENEWAL SHALL BE IN ACCORDANCE WITH THE TERMS AND CONDITIONS OF THE ORIGINAL CONTRACT AND SHALL BE LIMITED TO TWO (2) ONE (1) YEAR PERIODS.</p> <p>CANCELLATION: THE DIRECTOR OF PURCHASING RESERVES THE RIGHT TO CANCEL THIS CONTRACT IMMEDIATELY UPON WRITTEN NOTICE TO THE VENDOR IF THE COMMODITIES AND/OR SERVICES SUPPLIED ARE OF AN INFERIOR QUALITY OR DO NOT CONFORM TO THE SPECIFICATIONS OF THE BID AND CONTRACT HEREIN.</p> <p>OPEN MARKET CLAUSE: THE DIRECTOR OF PURCHASING MAY</p>						
SEE REVERSE SIDE FOR TERMS AND CONDITIONS						

SIGNATURE		TELEPHONE		DATE
TITLE	FEIN	ADDRESS CHANGES TO BE NOTED ABOVE		

WHEN RESPONDING TO RFQ, INSERT NAME AND ADDRESS IN SPACE ABOVE LABELED 'VENDOR'



State of West Virginia
 Department of Administration
 Purchasing Division
 2019 Washington Street East
 Post Office Box 50130
 Charleston, WV 25305-0130

Request for Quotation

RFQ NUMBER
DNRB11212

PAGE
3

ADDRESS CORRESPONDENCE TO ATTENTION OF
FRANK WHITTAKER
304-558-2316

SUBJECT

RFQ COPY
TYPE NAME/ADDRESS HERE

SHIP TO

DIVISION OF NATURAL RESOURCES
VARIOUS LOCALES AS INDICATED
BY ORDER

DATE PRINTED	TERMS OF SALE	SHIP VIA	FOB	FREIGHT TERMS
06/16/2011				

BID OPENING DATE: **07/20/2011** BID OPENING TIME **01:30PM**

LINE	QUANTITY	UOP	CAT NO	ITEM NUMBER	UNIT PRICE	AMOUNT
<p>AUTHORIZE A SPENDING UNIT TO PURCHASE ON THE OPEN MARKET, WITHOUT THE FILING OF A REQUISITION OR COST ESTIMATE, ITEMS SPECIFIED ON THIS CONTRACT FOR IMMEDIATE DELIVERY IN EMERGENCIES DUE TO UNFORESEEN CAUSES (INCLUDING BUT NOT LIMITED TO DELAYS IN TRANSPORTATION OR AN UNANTICIPATED INCREASE IN THE VOLUME OF WORK.)</p> <p>QUANTITIES: QUANTITIES LISTED IN THE REQUISITION ARE APPROXIMATIONS ONLY, BASED ON ESTIMATES SUPPLIED BY THE STATE SPENDING UNIT. IT IS UNDERSTOOD AND AGREED THAT THE CONTRACT SHALL COVER THE QUANTITIES ACTUALLY ORDERED FOR DELIVERY DURING THE TERM OF THE CONTRACT, WHETHER MORE OR LESS THAN THE QUANTITIES SHOWN.</p> <p>ORDERING PROCEDURE: SPENDING UNIT(S) SHALL ISSUE A WRITTEN STATE CONTRACT ORDER (FORM NUMBER WV-39) TO THE VENDOR FOR COMMODITIES COVERED BY THIS CONTRACT. THE ORIGINAL COPY OF THE WV-39 SHALL BE MAILED TO THE VENDOR AS AUTHORIZATION FOR SHIPMENT, A SECOND COPY MAILED TO THE PURCHASING DIVISION, AND A THIRD COPY RETAINED BY THE SPENDING UNIT.</p> <p>BANKRUPTCY: IN THE EVENT THE VENDOR/CONTRACTOR FILES FOR BANKRUPTCY PROTECTION, THE STATE MAY DEEM THE CONTRACT NULL AND VOID, AND TERMINATE SUCH CONTRACT WITHOUT FURTHER ORDER.</p> <p>THE TERMS AND CONDITIONS CONTAINED IN THIS CONTRACT SHALL SUPERSEDE ANY AND ALL SUBSEQUENT TERMS AND CONDITIONS WHICH MAY APPEAR ON ANY ATTACHED PRINTED DOCUMENTS SUCH AS PRICE LISTS, ORDER FORMS, SALES AGREEMENTS OR MAINTENANCE AGREEMENTS, INCLUDING ANY ELECTRONIC MEDIUM SUCH AS CD-ROM.</p> <p>REV. 05/26/2009</p>						

SEE REVERSE SIDE FOR TERMS AND CONDITIONS

SIGNATURE	TELEPHONE	DATE
TITLE	FEIN	ADDRESS CHANGES TO BE NOTED ABOVE

WHEN RESPONDING TO RFQ, INSERT NAME AND ADDRESS IN SPACE ABOVE LABELED 'VENDOR'



State of West Virginia
 Department of Administration
 Purchasing Division
 2019 Washington Street East
 Post Office Box 50130
 Charleston, WV 25305-0130

Request for Quotation

RFQ NUMBER:
DNRB11212

PAGE
4

ADDRESS CORRESPONDENCE TO ATTENTION OF:
**FRANK WHITTAKER
 304-558-2316**

VENDOR

RFQ COPY
 TYPE NAME/ADDRESS HERE

SHIP TO

DIVISION OF NATURAL RESOURCES
 VARIOUS LOCALES AS INDICATED
 BY ORDER

DATE PRINTED	TERMS OF SALE	SHIP VIA	F.O.B.	FREIGHT TERMS
06/16/2011				

BID OPENING DATE: **07/20/2011** BID OPENING TIME **01:30PM**

LINE	QUANTITY	UOP	CAT NO	ITEM NUMBER	UNIT PRICE	AMOUNT
<p>NOTICE</p> <p>A SIGNED BID MUST BE SUBMITTED TO:</p> <p>DEPARTMENT OF ADMINISTRATION PURCHASING DIVISION BUILDING 15 2019 WASHINGTON STREET, EAST CHARLESTON, WV 25305-0130</p> <p>THE BID SHOULD CONTAIN THIS INFORMATION ON THE FACE OF THE ENVELOPE OR THE BID MAY NOT BE CONSIDERED:</p> <p>SEALED BID</p> <p>BUYER: 44</p> <p>RFQ. NO.: DNRB11212</p> <p>BID OPENING DATE: 7/20/2011</p> <p>BID OPENING TIME: 1:30 PM</p> <p>PLEASE PROVIDE A FAX NUMBER IN CASE IT IS NECESSARY TO CONTACT YOU REGARDING YOUR BID: ----- 304-344-0324 -----</p> <p>CONTACT PERSON (PLEASE PRINT CLEARLY):</p>						

SEE REVERSE SIDE FOR TERMS AND CONDITIONS

SIGNATURE	TELEPHONE	DATE
TITLE	FEIN	ADDRESS CHANGES TO BE NOTED ABOVE

WHEN RESPONDING TO RFQ, INSERT NAME AND ADDRESS IN SPACE ABOVE LABELED 'VENDOR'



State of West Virginia
 Department of Administration
 Purchasing Division
 2019 Washington Street East
 Post Office Box 50130
 Charleston, WV 25305-0130

Request for Quotation

RFQ NUMBER
DNRB11212

PAGE
5

ADDRESS CORRESPONDENCE TO ATTENTION OF
**FRANK WHITTAKER
 304-558-2316**

RFQ COPY
 TYPE NAME/ADDRESS HERE

DIVISION OF NATURAL RESOURCES
 VARIOUS LOCALES AS INDICATED
 BY ORDER

PHOTO

SHIP TO

DATE PRINTED	TERMS OF SALE	SHIP VIA	FOB	FREIGHT TERMS
06/16/2011				

BID OPENING DATE: **07/20/2011** BID OPENING TIME **01:30PM**

LINE	QUANTITY	UOP	CAT NO	ITEM NUMBER	UNIT PRICE	AMOUNT
----- KEVIN HYPES -----						
***** THIS IS THE END OF RFQ DNRB11212 ***** TOTAL:						<u>\$167,750.00</u>

SEE REVERSE SIDE FOR TERMS AND CONDITIONS

SIGNATURE <i>Kevin Hypes</i>	TELEPHONE <i>304-344-2311</i>	DATE <i>7/10/11</i>
TITLE <i>Sales Rep</i>	FEIN <i>136794380601</i>	ADDRESS CHANGES TO BE NOTED ABOVE

WHEN RESPONDING TO RFQ, INSERT NAME AND ADDRESS IN SPACE ABOVE LABELED 'VENDOR'

OPEN END AGENCY CONTRACT Televisions

The West Virginia Division of Natural Resources is requesting Bids for an open ended contract for the purchase of flat screen televisions to be utilized for upgrades and redecoration of parks in various locations. All items are to be shipped FOB Destination. Vendor shall be required to submit a Bill of Lading for all material and items shipped that clearly show actual shipping costs.

General Specifications:

All items must be new, and must be Energy Star qualified. Televisions must be flat screen, and must have the availability to be mounted securely on the wall with appropriate wall mounting systems.

Basis of Award:

This contract is split into three separate bids based upon the location of the park where these items will be initially purchased. The three locations are Blackwater Falls State Park, Davis, WV, Pipestem Resort State Park, Pipestem, WV and Tygart Lake State Park, Grafton, WV.

Vendors may bid on any or all locations.

The television package will be awarded to the lowest qualified Bidder submitting the lowest Bid for all televisions and mounting hardware at each location, as stipulated on the Bid schedule and in complete accordance with all specifications stipulated herein. Partial or conditional bids will not be considered.

Coordination:

Vendor must coordinate shipping and receiving with each park. All items must be received within thirty days of the issuance of a purchase order.

Delivery, Storage and Handling:

The successful Vendor must deliver and handle all items according to Manufacturer's recommendations, including means and methods that will prevent damage, deterioration, and loss. Goods must be delivered in the Manufacturer's original sealed containers complete with labels and instructions for handling, storage, unpacking, protecting, and installing. The Division will supply labor to inspect the goods upon delivery, to ensure compliance with the purchase order, and to ensure all items are undamaged and protected against damage. All items must be delivered according to Manufacturer's recommendations and in an order that will facilitate inspection and measurement of quantity. All items must be delivered using means and methods that will prevent damage, deterioration, theft, or other loss. All items are to be shipped FOB Destination. Vendor shall be required to submit a Bill of Lading for all material and items shipped that clearly show actual shipping costs.

Locations:
BLACKWATER FALLS STATE PARK
(Tucker County)
RR 29 Drawer 490
Davis, WV 26260-0490

PIPESTEM RESORT STATE PARK
(Summers County)
RR 20 Box 150
Pipestem, WV 25979-0150

TYGART LAKE STATE PARK
(Taylor County)
RR 1 Box 260
Grafton, WV 26354-9741

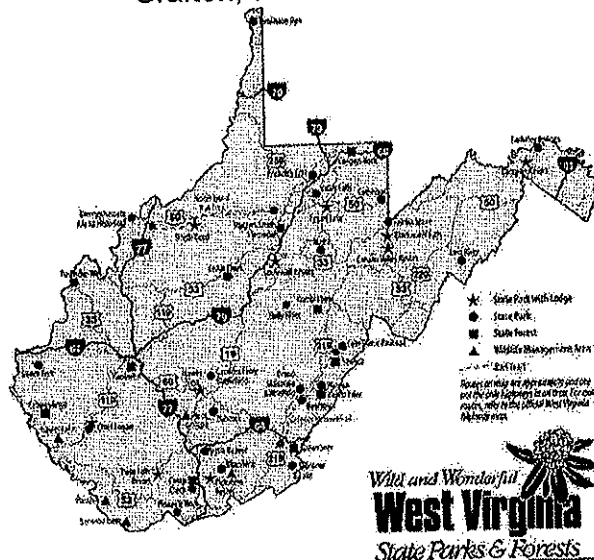

Damaged Items:

All items will be inspected by the Division at time of delivery to ensure that each item is not damaged or defective. Damaged or defective items will be rejected, and must be removed, and replaced at no additional expense to the Division.

Project Closeout:

Vendor must provide an inventory list of all items received and accepted. Vendor must provide the manufacturers recommendations for maintenance and cleaning.

Applications for Payment:

Vendor must submit Applications for Payment upon completion of delivery for all items delivered and accepted and upon completion of project closeout requirements.

Warranty:

The Vendor must warranty products to be free of defects in materials and Workmanship for a minimum period of one (1) year after date of acceptance or through manufacturer's provided warranty, whichever is greater. Vendor must repair or replace at its discretion, free of charge, any product that proves to be defective during the warranty period.

Estimated Quantities:

The quantities listed in this bid form are for bid evaluation purposes only – Actual quantities ordered may differ.

Television Specifications:

All items must meet the minimum specifications as detailed herein.
All items are to be shipped FOB Destination. Vendor shall be required to submit a Bill of Lading for all material and items shipped that clearly show actual shipping costs.

BLACKWATER FALLS STATE PARK

TELEVISION

Panasonic 42" Class 1080p LCD Model TH-42LRU30, or equal

- Must be minimum 42" Diagonal
- Minimum dimensions must be 25.1"x40.2"x4.2"
- Must be VESA mount compliant
- Must be LCD
- Must come with standard remote control
- Must have minimum contrast ratio of 20,000:1
- Must be model year 2010 or greater
- Minimum native resolution must be (1920 x 1080)
- Must have minimum 2 surround sound, full-range speakers
- Must have built in close caption decoder
- Must have sleep-off-timers and programmable timer
- Must be Energy Star® qualified

UNIVERSAL MOUNT WITH TILT

OmniMount 2N1-L, or equal

- Must be compatible with LCD Television provided under this contract
- Must fit a minimum of 37" – maximum 63" flat panel televisions
- Must support a minimum of 175 lbs
- Maximum tilt 15°
- Minimum mounting profile must be 2.7"
- Must be VESA compliant W200xH200

UNIVERSAL MOUNT WITH TILT / SWIVEL

OmniMount UCL-L, or equal

- Must be compatible with LCD Television provided under this contract
- Must fit a minimum of 37" – maximum 52" flat panel televisions
- Must support a minimum of 125 lbs.

OPEN END CONTRACT TELEVISIONS

- Must provide a minimum tilt -5° to a maximum tilt of 15°
- Minimum mounting profile must be 4.69"
- Maximum extension must be 26.8"
- Must be VESA compliant W200xH200

PIPESTEM RESORT STATE PARK

TELEVISION

LG 32" LCD TELEVISION 32LK330, or equal

- Must be minimum 31.5" Diagonal
- Must be LED
- Must have minimum contrast ratio of 70,000:1
- Minimum dimensions must be 31.5 X 22.2 X 8.1" (with stand)
- Must come with minimum 20° / 20° swivel stand
- Must come with standard remote control
- Must be model year 2010 or greater
- Minimum native resolution must be (1366x768)
- Must be Energy Star® qualified

TYGART LAKE STATE PARK

TELEVISION

LG 37" LED TELEVISION 37LV3500, or equal

- Must be minimum 37" Diagonal
- Must be LED
- Must have minimum contrast ratio of 3,000,000:1
- Minimum dimensions must be 24.9x20.9x1.6"
- Must be VESA mount compliant
- Must come with standard remote control
- Must be model year 2010 or greater
- Minimum native resolution must be (1920x1080)
- Must be Energy Star® qualified

TELEVISION

LG 55" LED TELEVISION 55LV5500, or equal

- Must be minimum 54.6" Diagonal
- Must be LED
- Must have minimum contrast ratio of 5,000,000:1
- Minimum dimensions must be 51.1"x30.6"x1.2"
- Must be VESA mount compliant
- Must come with standard remote control
- Must be model year 2010 or greater
- Minimum native resolution must be (1920x1080)
- Must be Energy Star® qualified

UNIVERSAL MOUNT WITH TILT

Omnimount 2N1-L, or equal

- Must be compatible with LED Television provided under this contract
- Must fit a minimum of 37" – maximum 63" flat panel televisions
- Must support a minimum of 175 lbs

OPEN END CONTRACT TELEVISIONS

- Maximum tilt 15°
- Minimum mounting profile must be 2.7"
- Must be VESA compliant

UNIVERSAL MOUNT WITH TILT / SWIVEL

OmniMount LEDP75, or equal

- Must be compatible with LED Television provided under this contract
- Must fit a minimum of 23" – maximum 60" flat panel televisions
- Must support a minimum of 75 lbs
- Minimum tilt -10° to maximum tilt 10°
- Minimum mounting profile: 0.6" in-wall; 2.23" on-wall
- Minimum lateral shift 11.35"
- Must be VESA compliant

BID FORM - TELEVISIONS
PIPESTEM RESORT STATE PARK

Item No.	Description	ESTIMATED QUANTITY	UNIT PRICE	EXTENDED PRICE
1	32" LCD TELEVISION	132	\$ 550.00	\$ 72,600
TOTAL BID				\$ 72,600

All items are to be shipped FOB Destination. Vendor shall be required to submit a Bill of Lading for all material and items shipped that clearly show actual shipping costs.

THE QUANTITIES LISTED ABOVE ARE FOR BID EVALUATION PURPOSES ONLY. ACTUAL QUANTITIES MAY DIFFER

**BID FORM - TELEVISIONS
BLACKWATER FALLS STATE PARK**

Item No.	Description	ESTIMATED QUANTITY	UNIT PRICE	EXTENDED PRICE
1	42" LCD TELEVISION	74	\$ 795.00	\$ 58,830.00
2	UNIVERSAL MOUNT WITH TILT	70	\$ 80.00	\$ 5,600.00
3	UNIVERSAL MOUNT WITH TILT / SWIVEL	4	\$ 125.00	\$ 500.00
TOTAL BID				\$ 64,930.00

All items are to be shipped FOB Destination. Vendor shall be required to submit a Bill of Lading for all material and items shipped that clearly show actual shipping costs.

THE QUANTITIES LISTED ABOVE ARE FOR BID EVALUATION PURPOSES ONLY. ACTUAL QUANTITIES MAY DIFFER.

BID FORM - TELEVISIONS
TYGART LAKE STATE PARK

Item No.	Description	ESTIMATED QUANTITY	UNIT PRICE	EXTENDED PRICE
1	37" LED TELEVISION	21	\$ 1,150.00	\$ 24,150.00
2	55" LED TELEVISION	2	\$ 1,995.00	\$ 3,990.00
3	UNIVERSAL MOUNT WITH TILT	21	\$ 80.00	\$ 1,680.00
4	UNIVERSAL MOUNT WITH TILT / SWIVEL	2	\$ 200.00	\$ 400.00
TOTAL BID				\$ 30,220.00

All items are to be shipped FOB Destination. Vendor shall be required to submit a Bill of Lading for all material and items shipped that clearly show actual shipping costs.

THE QUANTITIES LISTED ABOVE ARE FOR BID EVALUATION PURPOSES ONLY. ACTUAL QUANTITIES MAY DIFFER

MANUFACTURER SHEET - TELEVISIONS
PIPESTEM RESORT STATE PARK

Item No.	Description	Manufacturer
1	32" LCD TELEVISION	LG MODEL # 32LD452C

MANUFACTURER SHEET - TELEVISIONS
BLACKWATER FALLS STATE PARK

Item No.	Description	Manufacturer
1	42" LCD TELEVISION	LG MODEL # 42LD452C
2	UNIVERSAL MOUNT WITH TILT	VIDEO MOUNT PRODUCT MODEL # FP-LDSB
3	UNIVERSAL MOUNT WITH TILT / SWIVEL	VIDEO MOUNT PRODUCT MODEL # FP-XMWAE

MANUFACTURER SHEET - TELEVISIONS
TYGART LAKE STATE PARK

Item No.	Description	Manufacturer
1	37" LED TELEVISION	LG MODEL # 42LE530C
2	55" LED TELEVISION	LG MODEL # 55LE530C
3	UNIVERSAL MOUNT WITH TILT	VIDEO MOUNT PRODUCT MODEL # FP-LDSB
4	UNIVERSAL MOUNT WITH TILT / SWIVEL	VIDEO MOUNT PRODUCT MODEL # PDS-LWAB

State of West Virginia VENDOR PREFERENCE CERTIFICATE

Certification and application* is hereby made for Preference in accordance with *West Virginia Code*, §5A-3-37. (Does not apply to construction contracts). *West Virginia Code*, §5A-3-37, provides an opportunity for qualifying vendors to request (at the time of bid) preference for their residency status. Such preference is an evaluation method only and will be applied only to the cost bid in accordance with the *West Virginia Code*. This certificate for application is to be used to request such preference. The Purchasing Division will make the determination of the Resident Vendor Preference, if applicable.

1. Application is made for 2.5% resident vendor preference for the reason checked:

- Bidder is an individual resident vendor and has resided continuously in West Virginia for four (4) years immediately preceding the date of this certification; **or,**
- Bidder is a partnership, association or corporation resident vendor and has maintained its headquarters or principal place of business continuously in West Virginia for four (4) years immediately preceding the date of this certification; **or** 80% of the ownership interest of Bidder is held by another individual, partnership, association or corporation resident vendor who has maintained its headquarters or principal place of business continuously in West Virginia for four (4) years immediately preceding the date of this certification; **or,**
- Bidder is a nonresident vendor which has an affiliate or subsidiary which employs a minimum of one hundred state residents and which has maintained its headquarters or principal place of business within West Virginia continuously for the four (4) years immediately preceding the date of this certification; **or,**

2. Application is made for 2.5% resident vendor preference for the reason checked:

- Bidder is a resident vendor who certifies that, during the life of the contract, on average at least 75% of the employees working on the project being bid are residents of West Virginia who have resided in the state continuously for the two years immediately preceding submission of this bid; **or,**

3. Application is made for 2.5% resident vendor preference for the reason checked:

- Bidder is a nonresident vendor employing a minimum of one hundred state residents or is a nonresident vendor with an affiliate or subsidiary which maintains its headquarters or principal place of business within West Virginia employing a minimum of one hundred state residents who certifies that, during the life of the contract, on average at least 75% of the employees or Bidder's affiliate's or subsidiary's employees are residents of West Virginia who have resided in the state continuously for the two years immediately preceding submission of this bid; **or,**

4. Application is made for 5% resident vendor preference for the reason checked:

- Bidder meets either the requirement of both subdivisions (1) and (2) or subdivision (1) and (3) as stated above; **or,**

5. Application is made for 3.5% resident vendor preference who is a veteran for the reason checked:

- Bidder is an individual resident vendor who is a veteran of the United States armed forces, the reserves or the National Guard and has resided in West Virginia continuously for the four years immediately preceding the date on which the bid is submitted; **or,**

6. Application is made for 3.5% resident vendor preference who is a veteran for the reason checked:

- Bidder is a resident vendor who is a veteran of the United States armed forces, the reserves or the National Guard, if, for purposes of producing or distributing the commodities or completing the project which is the subject of the vendor's bid and continuously over the entire term of the project, on average at least seventy-five percent of the vendor's employees are residents of West Virginia who have resided in the state continuously for the two immediately preceding years.

Bidder understands if the Secretary of Revenue determines that a Bidder receiving preference has failed to continue to meet the requirements for such preference, the Secretary may order the Director of Purchasing to: (a) reject the bid; or (b) assess a penalty against such Bidder in an amount not to exceed 5% of the bid amount and that such penalty will be paid to the contracting agency or deducted from any unpaid balance on the contract or purchase order.

By submission of this certificate, Bidder agrees to disclose any reasonably requested information to the Purchasing Division and authorizes the Department of Revenue to disclose to the Director of Purchasing appropriate information verifying that Bidder has paid the required business taxes, provided that such information does not contain the amounts of taxes paid nor any other information deemed by the Tax Commissioner to be confidential.

Under penalty of law for false swearing (*West Virginia Code*, §61-5-3), Bidder hereby certifies that this certificate is true and accurate in all respects; and that if a contract is issued to Bidder and if anything contained within this certificate changes during the term of the contract, Bidder will notify the Purchasing Division in writing immediately.

Bidder: GRAYBAR ELECTRIC

Signed: *Ken Hays*

Date: 7-20-11

Title: Sales Rep

*Check any combination of preference consideration(s) indicated above, which you are entitled to receive.

STATE OF WEST VIRGINIA
Purchasing Division

PURCHASING AFFIDAVIT

West Virginia Code §5A-3-10a states: No contract or renewal of any contract may be awarded by the state or any of its political subdivisions to any vendor or prospective vendor when the vendor or prospective vendor or a related party to the vendor or prospective vendor is a debtor and the debt owed is an amount greater than one thousand dollars in the aggregate.

DEFINITIONS:

"Debt" means any assessment, premium, penalty, fine, tax or other amount of money owed to the state or any of its political subdivisions because of a judgment, fine, permit violation, license assessment, defaulted workers' compensation premium, penalty or other assessment presently delinquent or due and required to be paid to the state or any of its political subdivisions, including any interest or additional penalties accrued thereon.

"Debtor" means any individual, corporation, partnership, association, limited liability company or any other form or business association owing a debt to the state or any of its political subdivisions. "Political subdivision" means any county commission; municipality; county board of education; any instrumentality established by a county or municipality; any separate corporation or instrumentality established by one or more counties or municipalities, as permitted by law; or any public body charged by law with the performance of a government function or whose jurisdiction is coextensive with one or more counties or municipalities. "Related party" means a party, whether an individual, corporation, partnership, association, limited liability company or any other form or business association or other entity whatsoever, related to any vendor by blood, marriage, ownership or contract through which the party has a relationship of ownership or other interest with the vendor so that the party will actually or by effect receive or control a portion of the benefit, profit or other consideration from performance of a vendor contract with the party receiving an amount that meets or exceeds five percent of the total contract amount.

EXCEPTION: The prohibition of this section does not apply where a vendor has contested any tax administered pursuant to chapter eleven of this code, workers' compensation premium, permit fee or environmental fee or assessment and the matter has not become final or where the vendor has entered into a payment plan or agreement and the vendor is not in default of any of the provisions of such plan or agreement.

Under penalty of law for false swearing (*West Virginia Code §61-5-3*), it is hereby certified that the vendor affirms and acknowledges the information in this affidavit and is in compliance with the requirements as stated.

WITNESS THE FOLLOWING SIGNATURE

Vendor's Name: GRANBA ELECTRIC

Authorized Signature: [Signature] Date: 7-20-11

State of WV

County of KANAWHA, to-wit:

Taken, subscribed, and sworn to before me this 20 day of July, 2011.

My Commission expires JANUARY 16, 2019.

AFFIX SEAL HERE

NOTARY PUBLIC [Signature]

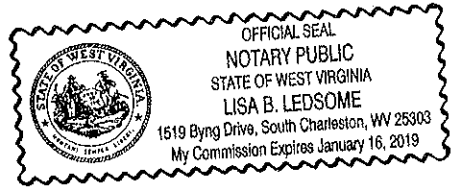

47" CLASS (47.0" MEASURED DIAGONALLY)
42" CLASS (42.0" MEASURED DIAGONALLY)
37" CLASS (37.0" MEASURED DIAGONALLY)
32" CLASS (31.5" MEASURED DIAGONALLY)

47LD452C
42LD452C
37LD452C
32LD452C

LCD TV

LCD Commercial Widescreen Integrated HDTV

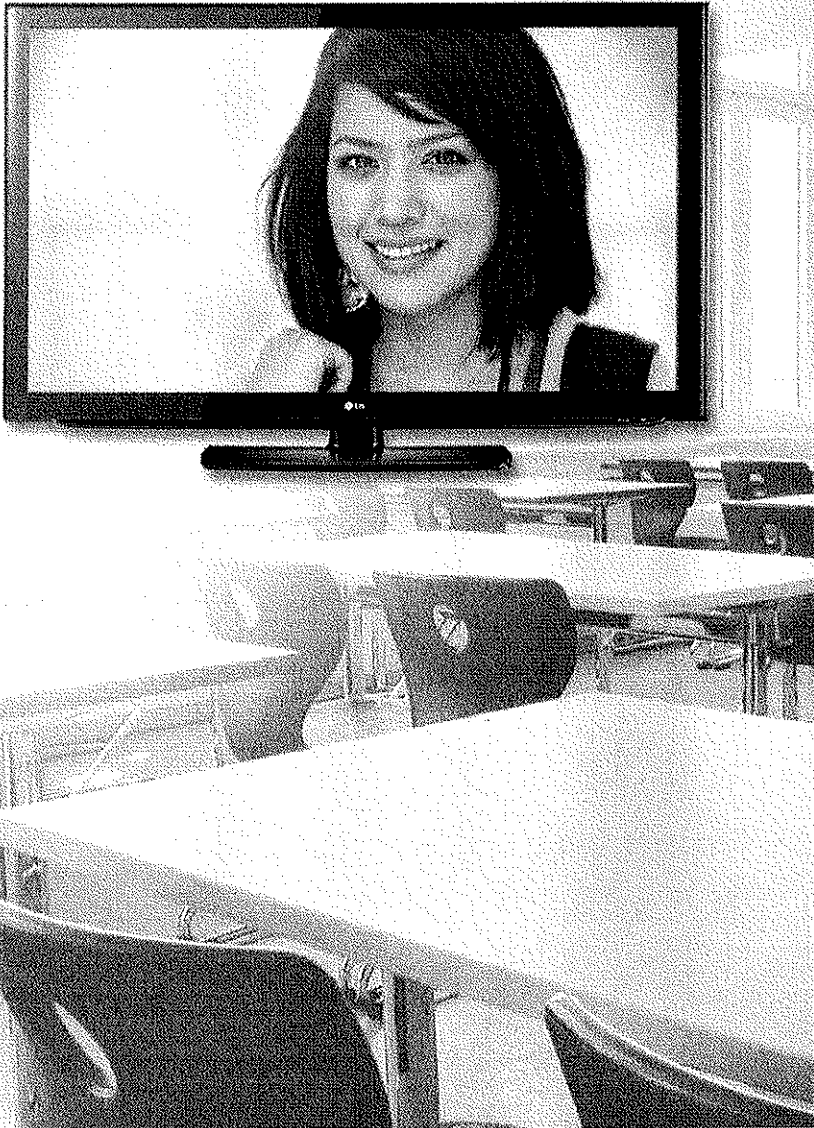

PUBLIC DISPLAY SETTINGS - CLOTHING CAPABLE

 EcoSmart™
Energy Saving Levels

 ENERGY STAR® 4.1 AND RoHS COMPLIANT

AUTO SENSING REMOTE JACK PACK (RJP) COMPATIBLE*

DYNAMIC CONTRAST RATIO
60,000:1

NATIVE DISPLAY RESOLUTION
1920 x 1080 full HD 1080p (37"/42"/47" class)
1366 x 768 (32" class)

BUILT-IN ATSC/NTSC/QAM CLEAR TUNER

MPEG-2/MPEG-4 H.264 DECODING

INVISIBLE SPEAKER SYSTEM
Hidden speaker grilles

LG'S EXCLUSIVE XD ENGINE®

MULTI REMOTE IR CODE

USB 2.0 MEDIA HOST FOR PHOTOS AND MUSIC

USB CLONING

CLEAR VOICE II

REAL CINEMA™

2 HDMI™ INPUTS WITH HDCP
V.1.3 with deep color

2 YEAR LIMITED WARRANTY
(parts and labor)

*NOTE: Contact your LG Sales representative on the RJPs that are compatible with the LD452C series.

**ENERGY
GUIDE** ↓

The estimated annual energy cost determined in accordance with 16 CFR Part 305.5 for models 47LD452C, 42LD452C, 37LD452C, & 32LD452C are \$26, \$20, \$16, & \$15, respectively.

"Your energy cost depends on your utility rates and use. The estimated cost is based on 11 cents per kWh and 5 hours of use per day. For more information, visit www.ftc.gov/energy."¹

¹FTC Television labeling rule (18 CFR Part 305, as added by 76 Fed. Reg. 1038 (Jan 6, 2011)).

www.LGolutions.com

 **LG**
Life's Good



Green LIFE'S GOOD...

WHEN IT'S GREEN.

LG is committed to improving product development, manufacturing and usage to meet the demand for environmentally friendlier products. Our LD452C televisions have technologies to reduce power consumption and in return increase cost savings per room. We've also placed limits in the amounts of harmful materials used in these televisions.

- **EcoSmart**
Energy Saving Levels - Manually select your choice for the brightness level for the television.
- **RoHS Compliant** - Meets directive on restriction of hazardous substances.
- **Energy Star 4.1 Qualified** - Meets current reduction requirements of energy consumption.

FEATURES



LG's newest core technology, Picture Wizard, enables easy self-calibration by providing on-screen reference points for key picture quality elements such as black level, color, tint, sharpness and backlight levels. By using this easy-to-use calibration process, the picture setting can be set to better fit the type of room application.

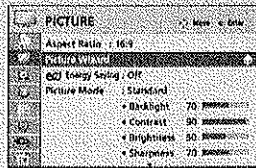

Dramatizations

ENERGY SAVING LEVELS

Manually select your choice for the brightness level for the television. By selecting Minimum, Medium, or Maximum, the power consumption will be reduced and an increase in energy savings can be achieved. (Note: Selecting minimum level may slightly increase power consumption on some models)

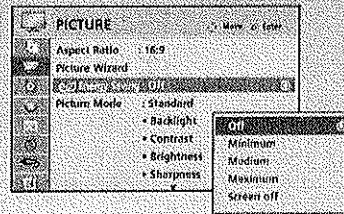

BED 1/2/3/4 REMOTE CONTROLABILITY

LG TVs with Bed 1/2/3/4 function eliminates the remote control signal interference between TVs in multiple dwelling rooms. This system will work using the same LG TV model.

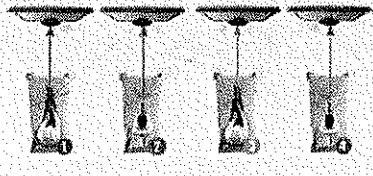

CONNECTIVITY

As a versatile addition to the TV viewing experience, LG's optional auto-sensing Remote Jack Packs (RJP)*, can serve as a multimedia hub that can be installed conveniently on a table or in a wall. Connect portable devices such as a laptop, mp3 player, or a digital camera to display images, play video or music from the set.



USB 2.0 MEDIA HOST

USB 2.0 will support JPG and MP3 files from a USB storage device.

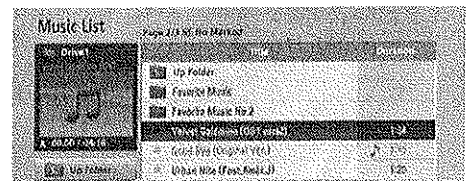
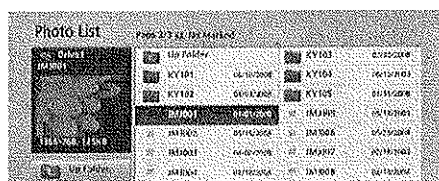

PUBLIC DISPLAY SETTINGS

When used in public areas, these HDTVs can be easily programmed by the installer to have the TV turn on at a specified channel/volume level, set the minimum/ maximum volume, lock out the control panel/remote, set the aspect ratio, and return to a factory reset. By using Power Management, these displays can be programmed to turn off if there has been no activity (remote or control panel buttons) for a preset time (1-7) hours.

Public Display Mode	No
Start Channel	No
Ch. Type	TV
Major	2
Minor	0
Minimum Volume	0
Maximum Volume	100
Start Volume	No
Level	20
Power Management	No
Setting	1
Key Management	0
Factory Reset	0
Aspect Ratio	0

USB CLONING

USB cloning will allow for easy transfer of Public Display Settings from the "Master TV" to an unlimited number of same type televisions.

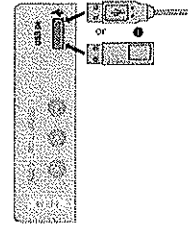

DIMENSIONS

invisible SPEAKER

SOUND IS HEARD, NOT SEEN

Enjoy a combination of smart technology and stylish design with the invisible speaker system custom tuned by audio expert Mr. Mark Levinson. This unique system provides a clean, polished look and an enhanced auditory experience by increasing the sweet spot and providing a wider sound field.

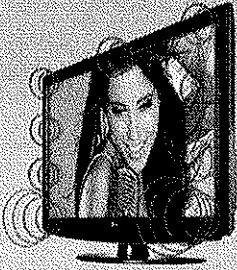

47LD452C
42LD452C

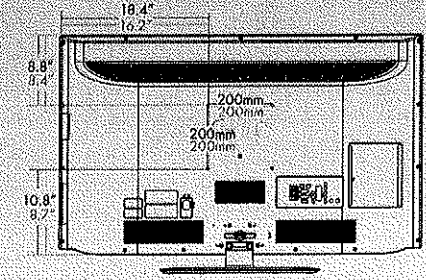
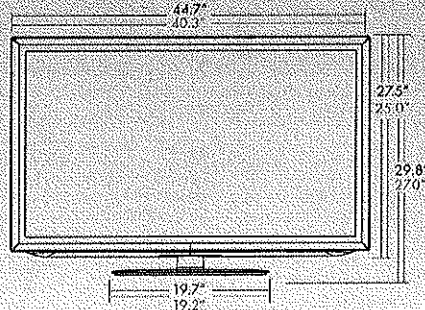

37LD452C
32LD452C

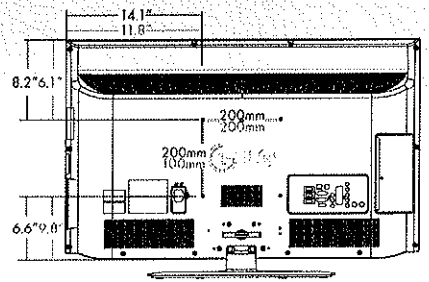
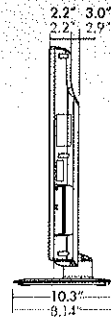
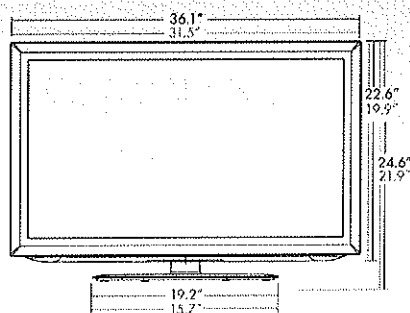

MOUNTING HOLES ON STAND

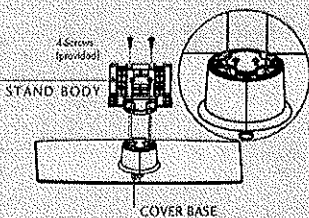

REAR

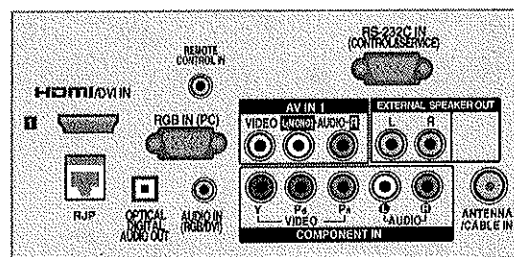

SIDE



47LD452C	47" CLASS (47.0" MEASURED DIAGONALLY)
42LD452C	42" CLASS (42.0" MEASURED DIAGONALLY)
37LD452C	37" CLASS (37.0" MEASURED DIAGONALLY)
32LD452C	32" CLASS (31.5" MEASURED DIAGONALLY)

SPECIFICATIONS

LCD SPECIFICATION	
Screen Size (Class)	47" class (47.0" measured diagonally) 42" class (42.0" measured diagonally) 37" class (37.0" measured diagonally) 32" class (31.5" measured diagonally)
Native Display Resolution	1920 x 1080 (32" class) 1366 x 768 (32" class)
Dynamic Contrast Ratio	60,000:1
Viewing Angle	178°/178°
Color Reproduction	10 Bit
Response Time [G to G]	4ms
True Viewing Angle	Yes
Life Span (Typical)	60,000 hrs
BROADCASTING SYSTEM	
Analog	Yes
ATSC/NTSC/Clear QAM	Yes
Video Codec: MPEG2/4	Yes
VIDEO	
Aspect Ratio	16:9
Aspect Ratio Correction	6 Modes (16:9/Just scan/Set by program / 4:3/Zoom/Cinema Zoom)
Color Temperature Control	3 Modes (Cool/Medium/Warm)
Picture Status Mode	7 Modes (Vivid/Standard/Cinema/Sport/ Game/Expert 1/Expert 2)
Just Scan (0% over scan)	Yes
HDMI	1080i/1080p/720p
Component	1080i/1080p/720p
RF/DTV	1080i/720p
24p Real Cinema (24p 5.5/2:2 Pull down)	Yes
Eye Care (Anti-Dezzling)	Yes
Fresh White	Yes
Expert Mode/ ISF Ready	Yes
Picture Wizard	Yes
AV Macro (Cinema/Game/Sport)	Yes
xvcc	Yes
DTV Signal Strength	Yes
AUDIO	
Audio Output	10W x 2
Invisible Speaker System Details	1 Way 2 Speaker
Dolby Digital 5.1 Decoder	Yes
Surround System Type	Infinite Sound
Bass/Treble/Balance Controls	Yes
Auto Volume Leveler	Yes
EZ Sound Mode/SSM	5 Modes
Clear Voice II	Yes
SPECIAL FEATURES	
XD Engine	Yes
Energy Saving Modes	Yes (Backlight Control, Video Mute)
EPG(SI)	Yes (Pre-Centric)
1080p Source Input	Yes HDMI/Component (60/30/24p), RGB (WXGA)
A/V Input Navigation	Yes
Input Labeling/Sub-title	Yes
LG SIMPLINK™ (HDMI CEC)	Yes
Parental Control w/V-Chip	Yes
Key Lock/Child Lock	Yes
Customizable Closed Caption/Sub-title	Yes
Splash Image - Logo (on start up)	Yes
Multi Remote IR code (Bed 1/2/3/4)	Yes
Auto-Sensing RJP compatible	Yes (with select RJP versions)
Bed 1/Bed 2/Bed 3/Bed 4 Control	Yes
Picture Wizard	Yes
TVLink Protocol (Timer, loader)	Yes
USB Cloning (USB link loader)	Yes
1080p Source Input	HDMI 60p/30p/24p Component 60p/30p/24p RGB WXGA
Quick View (Flashback)	Yes
e-Sireamer	Yes (for shop mode)
OSD Language	4 (English/Spanish/French/Korean)
Quick Menu (Round Type-8 menus selectable)	Yes (Aspect Ratio/SAP/Picture Mode/Sound Mode/Audio/Sleep Timer/Ch Add/USB Eject)

Alvin UI	Yes
Function Menu	Yes
Installation Menu	Yes (+2.6)
CONVENIENCE FEATURES	
Auto Tuning/Programming	Yes
Channel Add/Delete	Yes
Favourite Channel Programming	Yes
Auto/Manual Clock	Yes
On/Off Timer	Yes
Sleep Timer	Yes
Auto Off/Auto Sleep (When no video is present)	Yes
AUDIO/VIDEO INPUTS/OUTPUTS	
RF In (Antenna/Cable)	1
L/R Audio/Composite Video In	1 (rear), 1 (side)
HD Component Video In (Y, Pb, Pr) + L/R Audio	1
Digital Audio Out (Optical)	1
HDMI/HDCP Input (V1.3 with Deep Color)	1 (side), 1 (rear)
RGB In (D-Sub 15pin) - PC	1 (1920 x 1080)
PC Audio Input	1
RS-232c In (Control/Service)	1
USB 2.0 Input	1 (side) Media Host (JPEG, MP3), Cloning, and Service
Remote Control Port In	1
RJ45 (for RJP interface - non PIP)	1
CABINET/ACCESSORIES	
Cabinet Color	Glossy Black
Swivel Stand (degrees)	+20°/-20°
Top Side Mounting Screw	Yes
TORX Security Screw (2 each)	Yes
Power Indicator	Yes (on/off)
Fire Retardant Cabinet Material	Yes
Kensington Security System Slot	Yes
VESA® Mount Compatible	Yes
Remote Control	Yes
POWER	
Voltage, Hz	100V - 240V, 50/60 Hz
Stand-by Mode (typ.)	0.2W (EPA 4.0)
Power Consumption Max	180W (32" class), 200W (37" class), 260W (42" class), 330W (47" class)
Power Consumption Typical	78W (32" class), 95W (37" class), 115W (42" class), 138W (47" class)
Dynamic Power Savings	Yes
Static Power Savings	Yes
REQUIRED APPROVALS	
ENERGY STAR® 4.1 Qualified	Yes
RoHS Compliant	Yes
UL, cUL, NOM	Yes
DIMENSIONS & WEIGHT	
TV without stand (WxHxD)	31.5" x 19.9" x 2.9" (32" class) 36.1" x 22.6" x 3.0" (37" class) 40.3" x 25.0" x 3.0" (42" class) 44.7" x 27.5" x 3.0" (47" class)
TV with stand (WxHxD)	31.5" x 21.9" x 8.1" (32" class) 36.1" x 24.6" x 10.3" (37" class) 40.3" x 27.0" x 10.3" (42" class) 44.7" x 29.8" x 10.6" (47" class)
Shipping Dimensions (WxHxD)	38.0" x 23.2" x 7.5" (32" class) 39.2" x 26.0" x 9.0" (37" class) 43.6" x 30.3" x 9.0" (42" class) 48.8" x 31.6" x 10.0" (47" class)
TV without stand weight	17.9 lbs (32" class) 23.8 lbs (37" class) 29.8 lbs (42" class) 38.6 lbs (47" class)
TV with stand weight	20.1 lbs (32" class) 27.6 lbs (37" class) 33.3 lbs (42" class) 43.0 lbs (47" class)
Shipping Weight	24.9 lbs (32" class) 35.1 lbs (37" class) 41.7 lbs (42" class) 52.7 lbs (47" class)
SERVICE/LIMITED WARRANTY	
UPC CODE	
32LD452C	7 19192 90204 6
37LD452C	7 19192 90205 3
42LD452C	7 19192 90206 0
47LD452C	7 19192 90207 7

www.LG.com

LG Electronics U.S.A., Inc.
Commercial Displays
2000 Millbrook Drive
Lincolnshire, IL 60069

Customer Service: 888.865.3026
www.LG.com/support

Contact your LG Regional Sales Representative
Vertical Markets: 800.897.8788
Channel: 800.897.8871
Hospitality: 800.228.1236
E-mail: info@LG.com



All screen images are simulated. Dimensions and weights are approximate. Design, features and specifications subject to change without notice.

© Copyright 2011 LG Electronics USA, Inc. All Rights Reserved. "LG Life's Good" is a registered trademark of LG Corp. XD Engine is a registered trademark of LG Electronics, Inc. HealthView and EcoSmart are trademarks of LG Corp. Dolby and the double-D symbol are registered trademarks of Dolby Laboratories, SRS and the SRS logo, TruSound XT and WOW are trademarks or registered trademarks of SRS Labs, Inc. VESA is a trademark of Video Electronics Standards Association. All other product and brand names are trademarks or registered trademarks of their respective companies.



FP-LDSB

Large Flat Panel Digital Signage Mount

Product Features:

Holds most 32" – 63" flat panels in portrait or landscape

Maximum flat panel hole pattern – 810mm x 530mm
(810mm x 810mm with extensions)

Adjustable tilt -5° to +15° lockable at 5° increments

Sectional wall plate which can be integrated with
multiple FP-LDSB's to create a video wall

Distance from wall to back of the flat panel – 2.5" (2.6" w/ extensions)

Load capacity – 180 lbs

Black powder coat finish

Product Specifications:

(for Architects & Engineers)

The wall flush with tilt mount for large digital signage flat panels shall be the Video Mount Products (VMP) FP-LDSB. The mount shall be designed to attach to at least 2 studs up to 16" apart or other suitable support surface. The mount shall be designed with a section wall plate that can have additional sections (VMP model DS-BP) added to extend the length. The mount shall be constructed primarily of formed steel. The mount shall be capable of tilting from -5° to +15° and the tilt shall be lockable at 5° increments. The adjustable mounting rails shall be capable of accommodating a maximum hole pattern of 810 mm wide and 530 mm tall without extensions and with the rail extensions included with the unit capable of reach a maximum hole pattern height of 810 mm tall. The mount shall be capable of adjusting to accommodate a wide variety of flat panels ranging in size from 32" to 63" and not necessarily be model specific. The load capacity shall be 180 lbs.

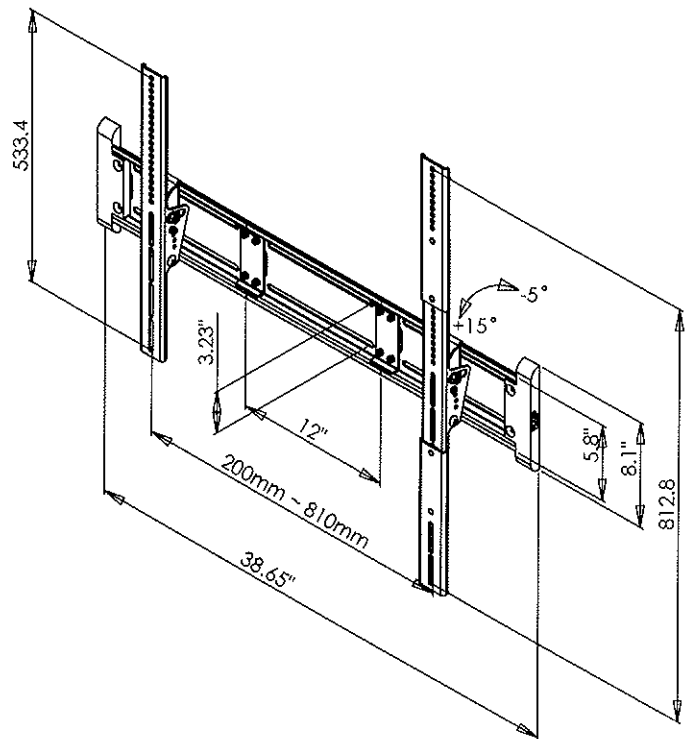
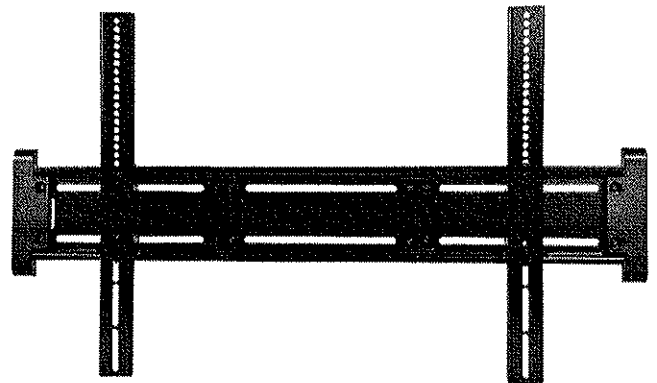

Video Mount Products

345 Log Canoe Circle

Stevensville, MD 21666

Toll Free: 877.281.2169

Telephone: 410.643.6390

Facsimile: 410.643.6615

www.videomount.com



VIDEO MOUNT PRODUCTS

PDS-LWA

Large Flat Panel Flush Mount With Tilt

Product Features:

Holds most 42"–63" flat panels

Maximum flat panel hole pattern – 950mm x 530mm

Rotates 45° and has adjustable -5° to +15° tilt

Depth 4.3" (arms fully collapsed)

Depth 24" (arms fully extended)

Includes cable management covers

Load capacity - 180 lbs

Silver powder coat finish

Also available in black (PDS-LWAB)

Product Specifications:

(for Architects & Engineers)

The articulating wall mount for the large flat panel display shall be the Video Mount Products (VMP) PDS-LWA. The mount shall be designed to attach to 2 studs up to 24" apart or other suitable support surface. The mount shall be constructed primarily of formed steel and aluminum and shall incorporate arc welds. The mount shall be a universal style mount capable of adjusting to the dimensions of a variety of popular 42" to 63" flat panel displays and not necessarily be model specific. The adjustable mounting rails shall be capable of accommodating a maximum hole pattern of 950 mm wide and 530 mm tall. The mount shall be capable of tilting from -5° to +15°. The load capacity shall be 180 lbs.

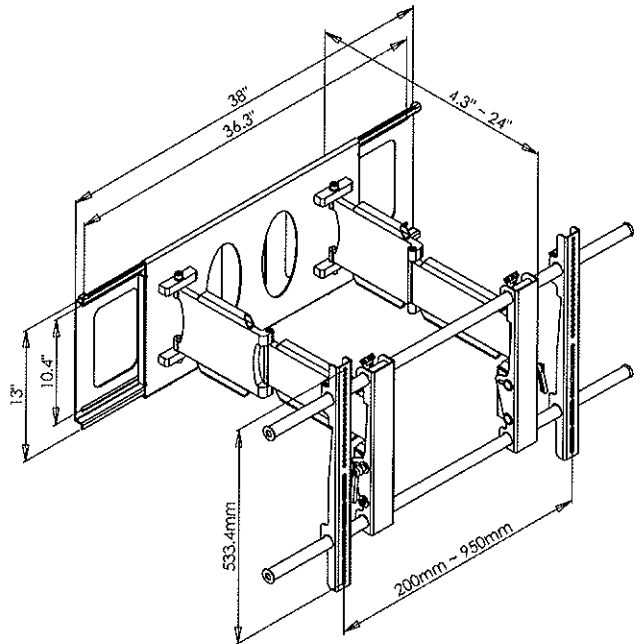
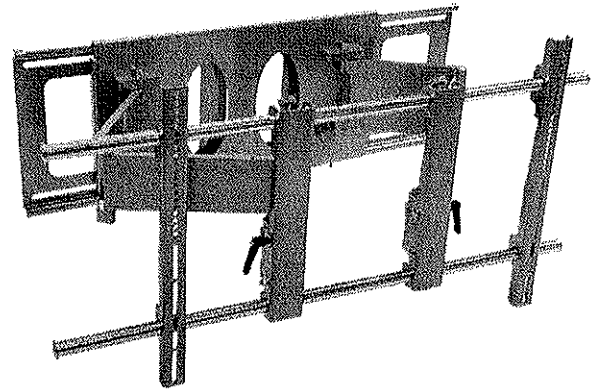

Video Mount Products

345 Log Canoe Circle

Stevensville, MD 21666

Toll Free: 877.281.2169

Telephone: 410.643.6390

Facsimile: 410.643.6615

www.videomount.com



VIDEO MOUNT PRODUCTS