

Varian Inc.
2700 Mitchell Drive
Walnut Creek, Ca 94598
Phone: 925.939.2400
Fax: 925.945.2360
<http://www.varianinc.com>



VARIAN

July 13, 2010

Ms. Roberta Wagner
State of West Virginia
Department of Administration
Purchasing Division, Building 15
2019 Washington Street East
PO Box 50130
Charleston, WV 25305-0130

RE: RFQ-LBS11009
Liquid Chromatograph/Mass Spectrometer/Mass

Dear Ms. Wagner,

Varian is pleased to be considered for the above referenced Bid. Varian's proposal and proposed price is predicated upon Varian Analytical Instruments Terms and Conditions which are included in our response. Varian is happy to discuss any questions or concerns the State of West Virginia may have to work toward mutually agreeable contract terms.

Included in our response are the following:

Request for Quotation #30230201439
Specifications and Requirements
Varian's Quote
Varian Analytical Instruments Terms and Conditions of Sale

If awarded the contract, Varian, Inc. will be happy to provide a notarized copy of the Purchasing Affidavit. Thank you again for giving us the opportunity to provide a solution. If further information is required, please contact Varian's sales representative Don Harrington at 925-393-2400 Ext. 3014. If you have any questions of a contractual nature, please do not hesitate to contact me at 925-939-2400 Ext. 6857 or via email at andrea.shipp@varianinc.com.

Sincerely,

Andrea Shipp
Contracts Manager

Enc.

RECEIVED

2010 JUL 14 P 2: 53

PURCHASING DIVISION
STATE OF WV



State of West Virginia
 Department of Administration
 Purchasing Division
 2019 Washington Street East
 Post Office Box 50130
 Charleston, WV 25305-0130

Request for Quotation

RFO NUMBER
 LBS11009

PAGE
 1

ADDRESS CORRESPONDENCE TO ATTENTION OF:
 ROBERTA WAGNER
 304-558-0067

VENDOR

*709065825 800-926-3000
 VARIAN INC
 2700 MITCHELL DRIVE
 WALNUT CREEK CA 94598

SHIP TO

HEALTH AND HUMAN RESOURCES
 ENVIRONMENTAL CHEMISTRY LAB
 4710 CHIMNEY DRIVE
 CHARLESTON, WV
 25302 304-558-3530

DATE PRINTED	TERMS OF SALE	SHIP VIA	FOB	FREIGHT TERMS
06/10/2010				

BID OPENING DATE: 07/15/2010 BID OPENING TIME 01:30PM

LINE	QUANTITY	UOP	CAT NO	ITEM NUMBER	UNIT PRICE	AMOUNT
0001	1	EA		490-55	225,110. ⁰⁰	225,110. ⁰⁰
LIQUID CHROMATOGRAPH/MASS SPECTROMETER/MASS SPECTROMETER (LC/MS/MS) INSTRUMENT TO MEET THE REQUIREMENTS OF THE PUBLIC HEALTH EMERGENCY PREPAREDNESS COOPERATIVE AGREEMENT WITH THE CENTER FOR DISEASE CONTROL AND PREVENTION (CDC). THE TECHNOLOGY OF THE LC/MS/MS MUST BE CONFIGURED SPECIFICALLY FOR THE STATE DEPARTMENT OF HEALTH LABORATORIES WHO ARE MEMBER OF THE US CENTERS FOR DISEASE CONTROL LRN-C PROGRAM. THE RESOLUTION AND SENSITIVITY CAPABILITY MUST BE ABLE TO MEET OR EXCEED THE LIMITS OF DETECTION AND MINIMUM REPORTING LEVELS REQUIRED FOR THESE AGENTS AS STIPULATED UNDER THE CENTER FOR DISEASE CONTROL OFFICE OF QUALITY CONTROL, QUALITY ASSURANCE PROGRAM, VALIDATION GUIDELINES. THIS INSTRUMENT IS TO BE INSTALLED FOR USE BY THE OFFICE OF LABORATORY SERVICES, CHEMICAL THREAT LABORATORY AT 4710 CHIMNEY DRIVE, SUITE G, CHARLESTON, WV 25302, PER THE ATTACHED DETAILED SPECIFICATIONS.						
>> PLEASE SEE ATTACHED SPECIFICATIONS/COST SHEET. <<						
CANCELLATION THE DIRECTOR OF PURCHASING RESERVES THE RIGHT TO CANCEL THIS CONTRACT IMMEDIATELY UPON WRITTEN NOTICE TO THE VENDOR IF THE COMMODITIES AND/OR SERVICES SUPPLIED ARE OF AN INFERIOR QUALITY OR DO NOT CONFORM TO THE SPECIFICATIONS OF THE BID AND CONTRACT HEREIN.						

SEE REVERSE SIDE FOR TERMS AND CONDITIONS

SIGNATURE: *Andrew Slupp* TELEPHONE: 925-939-2400 DATE: 7/13/10
 TITLE: Contracts Mgr FEIN: 077 0501995 ADDRESS CHANGES TO BE NOTED ABOVE

WHEN RESPONDING TO RFO, INSERT NAME AND ADDRESS IN SPACE ABOVE LABELED 'VENDOR'

** except as noted on the attached cover letter*

**GENERAL TERMS & CONDITIONS
REQUEST FOR QUOTATION (RFQ) AND REQUEST FOR PROPOSAL (RFP)**

1. Awards will be made in the best interest of the State of West Virginia.
2. The State may accept or reject in part, or in whole, any bid.
3. Prior to any award, the apparent successful vendor must be properly registered with the Purchasing Division and have paid the required \$125 fee.
4. All services performed or goods delivered under State Purchase Order/Contracts are to be continued for the term of the Purchase Order/Contracts, contingent upon funds being appropriated by the Legislature or otherwise being made available. In the event funds are not appropriated or otherwise available for these services or goods this Purchase Order/Contract becomes void and of no effect after June 30.
5. Payment may only be made after the delivery and acceptance of goods or services.
6. Interest may be paid for late payment in accordance with the *West Virginia Code*.
7. Vendor preference will be granted upon written request in accordance with the *West Virginia Code*.
8. The State of West Virginia is exempt from federal and state taxes and will not pay or reimburse such taxes.
9. The Director of Purchasing may cancel any Purchase Order/Contract upon 30 days written notice to the seller.
10. The laws of the State of West Virginia and the *Legislative Rules* of the Purchasing Division shall govern the purchasing process.
11. Any reference to automatic renewal is hereby deleted. The Contract may be renewed only upon mutual written agreement of the parties.
12. **BANKRUPTCY:** In the event the vendor/contractor files for bankruptcy protection, the State may deem this contract null and void, and terminate such contract without further order.
13. **HIPAA BUSINESS ASSOCIATE ADDENDUM:** The West Virginia State Government HIPAA Business Associate Addendum (BAA), approved by the Attorney General, is available online at www.state.wv.us/admin/purchase/vrc/hipaa.htm and is hereby made part of the agreement. Provided that the Agency meets the definition of a Cover Entity (45 CFR §160.103) and will be disclosing Protected Health Information (45 CFR §160.103) to the vendor.
14. **CONFIDENTIALITY:** The vendor agrees that he or she will not disclose to anyone, directly or indirectly, any such personally identifiable information or other confidential information gained from the agency, unless the individual who is the subject of the information consents to the disclosure in writing or the disclosure is made pursuant to the agency's policies, procedures, and rules. Vendor further agrees to comply with the Confidentiality Policies and Information Security Accountability Requirements, set forth in <http://www.state.wv.us/admin/purchase/privacy/noticeConfidentiality.pdf>.
15. **LICENSING:** Vendors must be licensed and in good standing in accordance with any and all state and local laws and requirements by any state or local agency of West Virginia, including, but not limited to, the West Virginia Secretary of State's Office, the West Virginia Tax Department, and the West Virginia Insurance Commission. The vendor must provide all necessary releases to obtain information to enable the director or spending unit to verify that the vendor is licensed and in good standing with the above entities.

~~16. **ANTITRUST:** In submitting a bid to any agency for the State of West Virginia, the bidder offers and agrees that if the bid is accepted the bidder will convey, sell, assign or transfer to the State of West Virginia all rights, title and interest in and to all causes of action it may now or hereafter acquire under the antitrust laws of the United States and the State of West Virginia for price fixing and/or unreasonable restraints of trade relating to the particular commodities or services purchased or acquired by the State of West Virginia. Such assignment shall be made and become effective at the time the purchasing agency tenders the initial payment to the bidder.~~

I certify that this bid is made without prior understanding, agreement, or connection with any corporation, firm, limited liability company, partnership, or person or entity submitting a bid for the same material, supplies, equipment or services and is in all respects fair and without collusion or fraud. I further certify that I am authorized to sign the certification on behalf of the bidder or this bid.

INSTRUCTIONS TO BIDDERS

1. Use the quotation forms provided by the Purchasing Division. Complete all sections of the quotation form.
2. Items offered must be in compliance with the specifications. Any deviation from the specifications must be clearly indicated by the bidder. Alternates offered by the bidder as **EQUAL** to the specifications must be clearly defined. A bidder offering an alternate should attach complete specifications and literature to the bid. The Purchasing Division may waive minor deviations to specifications.
3. Unit prices shall prevail in case of discrepancy. All quotations are considered F.O.B. destination unless alternate shipping terms are clearly identified in the quotation.
4. All quotations must be delivered by the bidder to the office listed below prior to the date and time of the bid opening. Failure of the bidder to deliver the quotations on time will result in bid disqualifications: Department of Administration, Purchasing Division, 2019 Washington Street East, P.O. Box 50130, Charleston, WV 25305-0130
5. Communication during the solicitation, bid, evaluation or award periods, except through the Purchasing Division, is strictly prohibited (W.Va. C.S.R. §148-1-6.6).



State of West Virginia
 Department of Administration
 Purchasing Division
 2019 Washington Street East
 Post Office Box 50130
 Charleston, WV 25305-0130

Request for Quotation

RFQ NUMBER
 LBS11009

PAGE
 2

ADDRESS CORRESPONDENCE TO ATTENTION OF
 ROBERTA WAGNER
 304-558-0067

*709065825 800-926-3000
 VARIAN INC
 2700 MITCHELL DRIVE
 WALNUT CREEK CA 94598

SHIP TO
 HEALTH AND HUMAN RESOURCES
 ENVIRONMENTAL CHEMISTRY LAB
 4710 CHIMNEY DRIVE
 CHARLESTON, WV
 25302 304-558-3530

DATE PRINTED	TERMS OF SALE	SHIP VIA	FOB	FREIGHT TERMS
06/10/2010				
BID OPENING DATE: 07/15/2010		BID OPENING TIME 01:30PM		

LINE	QUANTITY	UOP	CAT NO	ITEM NUMBER	UNIT PRICE	AMOUNT
<p>BANKRUPTCY: IN THE EVENT THE VENDOR/CONTRACTOR FILES FOR BANKRUPTCY PROTECTION, THE STATE MAY DEEM THE CONTRACT NULL AND VOID AND TERMINATE SUCH CONTRACT WITHOUT FURTHER ORDER.</p> <p>INQUIRIES: WRITTEN QUESTIONS SHALL BE ACCEPTED THROUGH CLOSE OF BUSINESS ON 6/29/2010. QUESTIONS MAY BE SENT VIA USPS, FAX, COURIER OR E-MAIL. IN ORDER TO ASSURE NO VENDOR RECEIVES AN UNFAIR ADVANTAGE, NO SUBSTANTIVE QUESTIONS WILL BE ANSWERED ORALLY. IF POSSIBLE, E-MAIL QUESTIONS ARE PREFERRED. ADDRESS INQUIRIES TO:</p> <p>ROBERTA WAGNER DEPARTMENT OF ADMINISTRATION PURCHASING DIVISION 2019 WASHINGTON STREET EAST CHARLESTON, WV 25311</p> <p>FAX: 304-558-4115 E-MAIL: ROBERTA.A.WAGNER@WV.GOV</p> <p>THE MODEL/BRAND/SPECIFICATIONS NAMED HEREIN ESTABLISH THE ACCEPTABLE LEVEL OF QUALITY ONLY AND ARE NOT INTENDED TO REFLECT A PREFERENCE OR FAVOR ANY PARTICULAR BRAND OR VENDOR. VENDORS WHO ARE BIDDING ALTERNATES SHOULD SO STATE AND INCLUDE PERTINENT LITERATURE AND SPECIFICATIONS. FAILURE TO PROVIDE INFORMATION FOR ANY ALTERNATES MAY BE GROUNDS FOR REJECTION OF THE BID. THE STATE RESERVES THE RIGHT TO WAIVE MINOR IRREGULARITIES IN BIDS OR SPECIFICATION</p>						

SEE REVERSE SIDE FOR TERMS AND CONDITIONS

SIGNATURE	TELEPHONE 925 939-2400	DATE 7/13/10
TITLE	FEIN 77-0501995	ADDRESS CHANGES TO BE NOTED ABOVE

WHEN RESPONDING TO RFQ, INSERT NAME AND ADDRESS IN SPACE ABOVE LABELED 'VENDOR'

**GENERAL TERMS & CONDITIONS
REQUEST FOR QUOTATION (RFQ) AND REQUEST FOR PROPOSAL (RFP)**

1. Awards will be made in the best interest of the State of West Virginia.
2. The State may accept or reject in part, or in whole, any bid.
3. Prior to any award, the apparent successful vendor must be properly registered with the Purchasing Division and have paid the required \$125 fee.
4. All services performed or goods delivered under State Purchase Order/Contracts are to be continued for the term of the Purchase Order/Contracts, contingent upon funds being appropriated by the Legislature or otherwise being made available. In the event funds are not appropriated or otherwise available for these services or goods this Purchase Order/Contract becomes void and of no effect after June 30.
5. Payment may only be made after the delivery and acceptance of goods or services.
6. Interest may be paid for late payment in accordance with the *West Virginia Code*.
7. Vendor preference will be granted upon written request in accordance with the *West Virginia Code*.
8. The State of West Virginia is exempt from federal and state taxes and will not pay or reimburse such taxes.
9. The Director of Purchasing may cancel any Purchase Order/Contract upon 30 days written notice to the seller.
10. The laws of the State of West Virginia and the *Legislative Rules* of the Purchasing Division shall govern the purchasing process.
11. Any reference to automatic renewal is hereby deleted. The Contract may be renewed only upon mutual written agreement of the parties.
12. **BANKRUPTCY:** In the event the vendor/contractor files for bankruptcy protection, the State may deem this contract null and void, and terminate such contract without further order.
13. **HIPAA BUSINESS ASSOCIATE ADDENDUM:** The West Virginia State Government HIPAA Business Associate Addendum (BAA), approved by the Attorney General, is available online at www.state.wv.us/admin/purchase/vrc/hipaa.htm and is hereby made part of the agreement. Provided that the Agency meets the definition of a Cover Entity (45 CFR §160.103) and will be disclosing Protected Health Information (45 CFR §160.103) to the vendor.
14. **CONFIDENTIALITY:** The vendor agrees that he or she will not disclose to anyone, directly or indirectly, any such personally identifiable information or other confidential information gained from the agency, unless the individual who is the subject of the information consents to the disclosure in writing or the disclosure is made pursuant to the agency's policies, procedures, and rules. Vendor further agrees to comply with the Confidentiality Policies and Information Security Accountability Requirements, set forth in <http://www.state.wv.us/admin/purchase/privacy/noticeConfidentiality.pdf>.
15. **LICENSING:** Vendors must be licensed and in good standing in accordance with any and all state and local laws and requirements by any state or local agency of West Virginia, including, but not limited to, the West Virginia Secretary of State's Office, the West Virginia Tax Department, and the West Virginia Insurance Commission. The vendor must provide all necessary releases to obtain information to enable the director or spending unit to verify that the vendor is licensed and in good standing with the above entities.
16. **ANTITRUST:** ~~In submitting a bid to any agency for the State of West Virginia, the bidder offers and agrees that if the bid is accepted the bidder will convey, sell, assign or transfer to the State of West Virginia all rights, title and interest in and to all causes of action it may now or hereafter acquire under the antitrust laws of the United States and the State of West Virginia for price fixing and/or unreasonable restraints of trade relating to the particular commodities or services purchased or acquired by the State of West Virginia. Such assignment shall be made and become effective at the time the purchasing agency tenders the initial payment to the bidder.~~

I certify that this bid is made without prior understanding, agreement, or connection with any corporation, firm, limited liability company, partnership, or person or entity submitting a bid for the same material, supplies, equipment or services and is in all respects fair and without collusion or fraud. I further certify that I am authorized to sign the certification on behalf of the bidder or this bid.

INSTRUCTIONS TO BIDDERS

1. Use the quotation forms provided by the Purchasing Division. Complete all sections of the quotation form.
2. Items offered must be in compliance with the specifications. Any deviation from the specifications must be clearly indicated by the bidder. Alternates offered by the bidder as **EQUAL** to the specifications must be clearly defined. A bidder offering an alternate should attach complete specifications and literature to the bid. The Purchasing Division may waive minor deviations to specifications.
3. Unit prices shall prevail in case of discrepancy. All quotations are considered F.O.B. destination unless alternate shipping terms are clearly identified in the quotation.
4. All quotations must be delivered by the bidder to the office listed below prior to the date and time of the bid opening. Failure of the bidder to deliver the quotations on time will result in bid disqualifications: Department of Administration, Purchasing Division, 2019 Washington Street East, P.O. Box 50130, Charleston, WV 25305-0130
5. Communication during the solicitation, bid, evaluation or award periods, except through the Purchasing Division, is strictly prohibited (W.Va. C.S.R. §148-1-6.6).



State of West Virginia
 Department of Administration
 Purchasing Division
 2019 Washington Street East
 Post Office Box 50130
 Charleston, WV 25305-0130

Request for Quotation

RFQ NUMBER
LBS11009

PAGE
3

ADDRESS CORRESPONDENCE TO ATTENTION OF
ROBERTA WAGNER
304-558-0067

*709065825 800-926-3000
VARIAN INC
2700 MITCHELL DRIVE
WALNUT CREEK CA 94598

HEALTH AND HUMAN RESOURCES
ENVIRONMENTAL CHEMISTRY LAB
4710 CHIMNEY DRIVE
CHARLESTON, WV
25302 304-558-3530

DATE PRINTED	TERMS OF SALE	SHIP VIA	F.O.B.	FREIGHT TERMS
06/10/2010				

BID OPENING DATE: **07/15/2010** BID OPENING TIME **01:30PM**

LINE	QUANTITY	UOP	CAT. NO.	ITEM NUMBER	UNIT PRICE	AMOUNT
<p>IN ACCORDANCE WITH SECTION 148-1-4 (F) OF THE WEST VIRGINIA LEGISLATIVE RULES AND REGULATIONS. VENDOR PREFERENCE CERTIFICATE</p> <p>THIS TEAM EXHIBIT HAS BEEN REPLACED BY THE ONLINE VERSION WHICH IS AVAILABLE HERE: HTTP://WWW.STATE.WV.US/ADMIN/PURCHASE/VRC/VENPREF.PDF</p> <p>NOTICE</p> <p>A SIGNED BID MUST BE SUBMITTED TO:</p> <p>DEPARTMENT OF ADMINISTRATION PURCHASING DIVISION BUILDING 15 2019 WASHINGTON STREET, EAST CHARLESTON, WV 25305-0130</p> <p>PLEASE NOTE: A CONVENIENCE COPY WOULD BE APPRECIATED.</p> <p>THE BID SHOULD CONTAIN THIS INFORMATION ON THE FACE OF THE ENVELOPE OR THE BID MAY NOT BE CONSIDERED:</p> <p>SEALED BID</p> <p>BUYER: -----RW/FILE 22-----</p> <p>RFQ. NO.: -----LBS11009-----</p> <p>BID OPENING DATE: ---7/15/2010---</p> <p>BID OPENING TIME: ---1:30 PM-----</p>						

SEE REVERSE SIDE FOR TERMS AND CONDITIONS

SIGNATURE	TELEPHONE	DATE
	925 939-2400	7/13/10
TITLE	ADDRESS CHANGES TO BE NOTED ABOVE	
770501995		

WHEN RESPONDING TO RFQ, INSERT NAME AND ADDRESS IN SPACE ABOVE LABELED 'VENDOR'

**GENERAL TERMS & CONDITIONS
REQUEST FOR QUOTATION (RFQ) AND REQUEST FOR PROPOSAL (RFP)**

1. Awards will be made in the best interest of the State of West Virginia.
2. The State may accept or reject in part, or in whole, any bid.
3. Prior to any award, the apparent successful vendor must be properly registered with the Purchasing Division and have paid the required \$125 fee.
4. All services performed or goods delivered under State Purchase Order/Contracts are to be continued for the term of the Purchase Order/Contracts, contingent upon funds being appropriated by the Legislature or otherwise being made available. In the event funds are not appropriated or otherwise available for these services or goods this Purchase Order/Contract becomes void and of no effect after June 30.
5. Payment may only be made after the delivery and acceptance of goods or services.
6. Interest may be paid for late payment in accordance with the *West Virginia Code*.
7. Vendor preference will be granted upon written request in accordance with the *West Virginia Code*.
8. The State of West Virginia is exempt from federal and state taxes and will not pay or reimburse such taxes.
9. The Director of Purchasing may cancel any Purchase Order/Contract upon 30 days written notice to the seller.
10. The laws of the State of West Virginia and the *Legislative Rules* of the Purchasing Division shall govern the purchasing process.
11. Any reference to automatic renewal is hereby deleted. The Contract may be renewed only upon mutual written agreement of the parties.
12. **BANKRUPTCY:** In the event the vendor/contractor files for bankruptcy protection, the State may deem this contract null and void, and terminate such contract without further order.
13. **HIPAA BUSINESS ASSOCIATE ADDENDUM:** The West Virginia State Government HIPAA Business Associate Addendum (BAA), approved by the Attorney General, is available online at www.state.wv.us/admin/purchase/vrc/hipaa.htm and is hereby made part of the agreement. Provided that the Agency meets the definition of a Cover Entity (45 CFR §160.103) and will be disclosing Protected Health Information (45 CFR §160.103) to the vendor.
14. **CONFIDENTIALITY:** The vendor agrees that he or she will not disclose to anyone, directly or indirectly, any such personally identifiable information or other confidential information gained from the agency, unless the individual who is the subject of the information consents to the disclosure in writing or the disclosure is made pursuant to the agency's policies, procedures, and rules. Vendor further agrees to comply with the Confidentiality Policies and Information Security Accountability Requirements, set forth in <http://www.state.wv.us/admin/purchase/privacy/noticeConfidentiality.pdf>.
15. **LICENSING:** Vendors must be licensed and in good standing in accordance with any and all state and local laws and requirements by any state or local agency of West Virginia, including, but not limited to, the West Virginia Secretary of State's Office, the West Virginia Tax Department, and the West Virginia Insurance Commission. The vendor must provide all necessary releases to obtain information to enable the director or spending unit to verify that the vendor is licensed and in good standing with the above entities.

~~16. **ANTITRUST:** In submitting a bid to any agency for the State of West Virginia, the bidder offers and agrees that if the bid is accepted the bidder will convey, sell, assign or transfer to the State of West Virginia all rights, title and interest in and to all causes of action it may now or hereafter acquire under the antitrust laws of the United States and the State of West Virginia for price fixing and/or unreasonable restraints of trade relating to the particular commodities or services purchased or acquired by the State of West Virginia. Such assignment shall be made and become effective at the time the purchasing agency tenders the initial payment to the bidder.~~

I certify that this bid is made without prior understanding, agreement, or connection with any corporation, firm, limited liability company, partnership, or person or entity submitting a bid for the same material, supplies, equipment or services and is in all respects fair and without collusion or fraud. I further certify that I am authorized to sign the certification on behalf of the bidder or this bid.

INSTRUCTIONS TO BIDDERS

1. Use the quotation forms provided by the Purchasing Division. Complete all sections of the quotation form.
2. Items offered must be in compliance with the specifications. Any deviation from the specifications must be clearly indicated by the bidder. Alternates offered by the bidder as **EQUAL** to the specifications must be clearly defined. A bidder offering an alternate should attach complete specifications and literature to the bid. The Purchasing Division may waive minor deviations to specifications.
3. Unit prices shall prevail in case of discrepancy. All quotations are considered F.O.B. destination unless alternate shipping terms are clearly identified in the quotation.
4. All quotations must be delivered by the bidder to the office listed below prior to the date and time of the bid opening. Failure of the bidder to deliver the quotations on time will result in bid disqualifications: Department of Administration, Purchasing Division, 2019 Washington Street East, P.O. Box 50130, Charleston, WV 25305-0130
5. Communication during the solicitation, bid, evaluation or award periods, except through the Purchasing Division, is strictly prohibited (W.Va. C.S.R. §148-1-6.6).



State of West Virginia
 Department of Administration
 Purchasing Division
 2019 Washington Street East
 Post Office Box 50130
 Charleston, WV 25305-0130

Request for Quotation

RFQ NUMBER:
LBS11009

PAGE:
4

ADDRESS CORRESPONDENCE TO ATTENTION OF:
**ROBERTA WAGNER
 304-558-0067**

*709065825 800-926-3000
VARIAN INC
2700 MITCHELL DRIVE
WALNUT CREEK CA 94598

SHIP TO
HEALTH AND HUMAN RESOURCES
ENVIRONMENTAL CHEMISTRY LAB
4710 CHIMNEY DRIVE
CHARLESTON, WV
25302 304-558-3530

DATE PRINTED	TERMS OF SALE	SHIP VIA	FOB	FREIGHT TERMS
06/10/2010				

BID OPENING DATE: **07/15/2010** BID OPENING TIME: **01:30PM**

LINE	QUANTITY	UOP	CAT. NO.	ITEM NUMBER	UNIT PRICE	AMOUNT
PLEASE PROVIDE A FAX NUMBER IN CASE IT IS NECESSARY TO CONTACT YOU REGARDING YOUR BID: <p style="text-align: center;">925 945-2360</p> CONTACT PERSON (PLEASE PRINT CLEARLY): <p style="text-align: center;">Don Harrington</p>						
***** THIS IS THE END OF RFQ LBS11009 ***** TOTAL:						* 225,110.⁰⁰

SEE REVERSE SIDE FOR TERMS AND CONDITIONS

SIGNATURE: **Andrew Slupp** TELEPHONE: **925 939-2400** DATE: _____
 TITLE: **Contracts manager** FEIN: **77-0501995** ADDRESS CHANGES TO BE NOTED ABOVE

WHEN RESPONDING TO RFQ, INSERT NAME AND ADDRESS IN SPACE ABOVE LABELED 'VENDOR'

* Except as noted in attached cover letter.

**GENERAL TERMS & CONDITIONS
REQUEST FOR QUOTATION (RFQ) AND REQUEST FOR PROPOSAL (RFP)**

1. Awards will be made in the best interest of the State of West Virginia.
2. The State may accept or reject in part, or in whole, any bid.
3. Prior to any award, the apparent successful vendor must be properly registered with the Purchasing Division and have paid the required \$125 fee.
4. All services performed or goods delivered under State Purchase Order/Contracts are to be continued for the term of the Purchase Order/Contracts, contingent upon funds being appropriated by the Legislature or otherwise being made available. In the event funds are not appropriated or otherwise available for these services or goods this Purchase Order/Contract becomes void and of no effect after June 30.
5. Payment may only be made after the delivery and acceptance of goods or services.
6. Interest may be paid for late payment in accordance with the *West Virginia Code*.
7. Vendor preference will be granted upon written request in accordance with the *West Virginia Code*.
8. The State of West Virginia is exempt from federal and state taxes and will not pay or reimburse such taxes.
9. The Director of Purchasing may cancel any Purchase Order/Contract upon 30 days written notice to the seller.
10. The laws of the State of West Virginia and the *Legislative Rules* of the Purchasing Division shall govern the purchasing process.
11. Any reference to automatic renewal is hereby deleted. The Contract may be renewed only upon mutual written agreement of the parties.
12. **BANKRUPTCY:** In the event the vendor/contractor files for bankruptcy protection, the State may deem this contract null and void, and terminate such contract without further order.
13. **HIPAA BUSINESS ASSOCIATE ADDENDUM:** The West Virginia State Government HIPAA Business Associate Addendum (BAA), approved by the Attorney General, is available online at www.state.wv.us/admin/purchase/vrc/hipaa.htm and is hereby made part of the agreement. Provided that the Agency meets the definition of a Cover Entity (45 CFR §160.103) and will be disclosing Protected Health Information (45 CFR §160.103) to the vendor.
14. **CONFIDENTIALITY:** The vendor agrees that he or she will not disclose to anyone, directly or indirectly, any such personally identifiable information or other confidential information gained from the agency, unless the individual who is the subject of the information consents to the disclosure in writing or the disclosure is made pursuant to the agency's policies, procedures, and rules. Vendor further agrees to comply with the Confidentiality Policies and Information Security Accountability Requirements, set forth in <http://www.state.wv.us/admin/purchase/privacy/noticeConfidentiality.pdf>.
15. **LICENSING:** Vendors must be licensed and in good standing in accordance with any and all state and local laws and requirements by any state or local agency of West Virginia, including, but not limited to, the West Virginia Secretary of State's Office, the West Virginia Tax Department, and the West Virginia Insurance Commission. The vendor must provide all necessary releases to obtain information to enable the director or spending unit to verify that the vendor is licensed and in good standing with the above entities.
16. ~~**ANTITRUST:** In submitting a bid to any agency for the State of West Virginia, the bidder offers and agrees that if the bid is accepted the bidder will convey, sell, assign or transfer to the State of West Virginia all rights, title and interest in and to all causes of action it may now or hereafter acquire under the antitrust laws of the United States and the State of West Virginia for price fixing and/or unreasonable restraints of trade relating to the particular commodities or services purchased or acquired by the State of West Virginia. Such assignment shall be made and become effective at the time the purchasing agency tenders the initial payment to the bidder.~~

I certify that this bid is made without prior understanding, agreement, or connection with any corporation, firm, limited liability company, partnership, or person or entity submitting a bid for the same material, supplies, equipment or services and is in all respects fair and without collusion or fraud. I further certify that I am authorized to sign the certification on behalf of the bidder or this bid.

INSTRUCTIONS TO BIDDERS

1. Use the quotation forms provided by the Purchasing Division. Complete all sections of the quotation form.
2. Items offered must be in compliance with the specifications. Any deviation from the specifications must be clearly indicated by the bidder. Alternates offered by the bidder as EQUAL to the specifications must be clearly defined. A bidder offering an alternate should attach complete specifications and literature to the bid. The Purchasing Division may waive minor deviations to specifications.
3. Unit prices shall prevail in case of discrepancy. All quotations are considered F.O.B. destination unless alternate shipping terms are clearly identified in the quotation.
4. All quotations must be delivered by the bidder to the office listed below prior to the date and time of the bid opening. Failure of the bidder to deliver the quotations on time will result in bid disqualifications: Department of Administration, Purchasing Division, 2019 Washington Street East, P.O. Box 50130, Charleston, WV 25305-0130
5. Communication during the solicitation, bid, evaluation or award periods, except through the Purchasing Division, is strictly prohibited (W.Va. C.S.R. §148-1-6.6).

SPECIFICATIONS AND REQUIREMENTS

The Threat Preparedness and Response Section, Chemical Threats, of the Office of Laboratory Services (CT) is requesting to purchase a Liquid Chromatograph/Mass Spectrometer/Mass Spectrometer (LC/MS/MS).

1. A LC/MS/MS instrument is needed by CT to meet the requirements of the Public Health Emergency Preparedness cooperative agreement with the Center for Disease Control and Prevention (CDC), Atlanta, Georgia.
2. The technology of this LC/MS/MS instrument must be configured specifically for the State Department of Health laboratories who are members of the US Centers for Disease Control LRN-C Program (Laboratory Response Network – Chemical). The resolution and sensitivity capability must be able to meet or exceed the limits of detection and minimum reporting levels required for these agents as stipulated under the Center for Disease Control Office of Quality Control, Quality Assurance Program, Validation Guidelines.
3. The LC/MS/MS instrument must come equipped with a triple quadrupole mass spectrometer, workstation PC and printer, software with 2 data analysis licenses, installation, and familiarization training.
4. The LC/MS/MS instrument must have an atmospheric pressure chemical ionization (APCI) source with spray chamber, corona discharge needle, nebulizer, APCI vaporizer, and test calibration kit.
5. The LC/MS/MS instrument must come equipped with LC/MS rough pumps compatible with BOC Edwards pumps, or equivalent.
6. The LC/MS/MS instrument must have a nitrogen gas generator and a maintenance kit.
7. The LC/MS/MS instrument must have a binary pump system with solvent cabinet, 2 solvent bottles, connecting capillaries, and CAN cable (cable wire that connects the pump system to the computer). It must also contain a maintenance kit, active seal option, and solvent selection valve option.

8. The LC/MS/MS instrument system package must have a micro degasser which includes a 4-channel micro-vacuum, degasser, remote control cable, and connecting tubing.
9. The LC/MS/MS instrument must be fully compatible with a system controlled auto sampler with a 100uL injection loop, tray for two well plates, 10x 2mL vials, 2x54- vial plates, Rheodyne injection valve (600 bar), and 05 m CAN cable.
10. The LC/MS/MS instrument system must have a Peltier (generic term for any device that uses the Peltier effect to heat or cool materials) type device to control the temperature of the auto samplers/fraction collectors.
11. For rapid resolution LC, the column compartment temperature must maximize to 100°C and pressures up to 600 bar.
12. The LC/MS/MS instrument must come with a high pressure liquid chromatography (HPLC) column oven with a temperature tolerance of +/- 2°C.
13. The LC/MS/MS instrument must come with a column Atlantis HILIC Silica, 2.1 x 50 mm 3µm particles, or equivalent for the Ortho-Phosphate Nerve Agents (OPNA) method.
14. The LC/MS/MS instrument system must include a diode array detector with radio-frequency identification (RFID) tracking technology for flow cells and ultra violet (UV) lamp with one standard flow cell.
15. The LC/MS/MS instrument system must contain a SB-C18, 2.1x100mm, 1.8µm, 600 bar, or equivalent column.
16. Consumables to be included with the LC/MS/MS instrument: finger tight polyketone fittings 1/16" in a 10 pack with the maximum pressure capability of 600 bar, rapid resolution liquid chromatography (RRLC) in-line filter, 2 mm, 0.2 um filter with the maximum 600 bar with 3 frits and 70x0.12 mm connecting capillary, and replacement frits, 2mm, 0.2um in a 10 pack what are stainless steel, PEEK encapsulated for use with RRLC in-line filter.
17. The LC/MS/MS instrument must be fully automated for analysis with a system controller that is loaded with the necessary software. System

controller software must be able to export data to the existing Laboratory Information Management System (LIMS), STARLIMS Sunrise version 9, resides on a Microsoft Windows Server 2003 file server. The ability for the equipment to place a results data file into a shared folder on the LIMS server in a format that can be imported is required.

18. The LC/MS/MS instrument system controller software must be able to fulfill all of the analytical and quality control requirements stated in the CDC Office of Quality Control, Quality Assurance Program, Validation Guidelines. The LRN-C validation guidelines as published by the CDC on the LRN-C, the information is not for public distribution and is considered "sensitive" to the point that we are forbidden to pass on uncontrolled copies.

Installation Requirements:

1. Vendor must install the LC/MS/MS instrument system in the Threat Preparedness Laboratory in the Elk Office Center building at 4710 Chimney Drive, Suite G, Charleston, WV, 25302.
2. Vendor must provide to the Threat Preparedness (TP) Program Manager all relevant information concerning the installation in a documented form at least 2 weeks prior to the scheduled installation.
3. At the time of the LC/MS/MS instrument installation, Vendor must provide to the TP Program Manager: All relevant system manuals for hardware components: system and application software documentation: and a parts, supplies, and accessories catalog.
4. Vendor must include all necessary cables and fittings and other costs for installation in the submitted bid price.
5. Installation and on-site training must be completed within 90 days of delivery date.

Training Requirements

1. Vendor must provide, upon completion of installation, two days of on-site training for the Threat Preparedness personnel on the operation and user maintenance requirements of the LC/MS/MS instrument system.

2. All costs incurred by the Vendor including travel, lodging, and living expenses necessary to provide this basic training shall be included in the bid price.

Warranty Requirements

1. Vendor must include in the total price of the equipment at least a one-year factory warranty covering all system components.
2. Software support must be included as part of the one-year warranty.
3. Warranty must include on-site service including labor, travel time, and expenses with a 72-hour on-site response time at no extra cost to maintain the specifications listed in the bid and the Vendor's product specifications. (Vendor should include a copy of the warranty).
4. Warranty must begin upon acceptance of the completed installation and training.

Delivery Requirements

1. The LC/MS/MS instrument and its components must be shipped for "inside delivery" by a freight delivery company and must be delivered within 90 days of receipt of order.
2. The LC/MS/MS instrument and its components must be shipped "F.O.B. Destination" unless otherwise stated in quote by Vendor. Any shipping and handling requirements must be stated in Vendor's quote.

RFQ COST SHEET

Bidders shall provide a cost for the following:

Liquid Chromatograph/Mass Spectrometer/Mass Spectrometer
(LC/MS/MS)

\$ 225,110.⁰⁰

On-Site User Training (at installation of equipment)

\$ included

Freight/Shipping Charge

\$ included

Total Cost \$ 225,110.⁰⁰

The award will be made to the vendor with the lowest overall total cost of the equipment which meets all requested specifications and requirements. Payment will be made in arrears.

Andrew Shygo
Vendor Signature

7/13/10
Date

RFQ No. LBS11009

STATE OF WEST VIRGINIA
Purchasing Division

PURCHASING AFFIDAVIT

West Virginia Code §5A-3-10a states: No contract or renewal of any contract may be awarded by the state or any of its political subdivisions to any vendor or prospective vendor when the vendor or prospective vendor or a related party to the vendor or prospective vendor is a debtor and the debt owed is an amount greater than one thousand dollars in the aggregate.

DEFINITIONS:

"Debt" means any assessment, premium, penalty, fine, tax or other amount of money owed to the state or any of its political subdivisions because of a judgment, fine, permit violation, license assessment, defaulted workers' compensation premium, penalty or other assessment presently delinquent or due and required to be paid to the state or any of its political subdivisions, including any interest or additional penalties accrued thereon.

"Debtor" means any individual, corporation, partnership, association, limited liability company or any other form or business association owing a debt to the state or any of its political subdivisions. "Political subdivision" means any county commission; municipality; county board of education; any instrumentality established by a county or municipality; any separate corporation or instrumentality established by one or more counties or municipalities, as permitted by law; or any public body charged by law with the performance of a government function or whose jurisdiction is coextensive with one or more counties or municipalities. "Related party" means a party, whether an individual, corporation, partnership, association, limited liability company or any other form or business association or other entity whatsoever, related to any vendor by blood, marriage, ownership or contract through which the party has a relationship of ownership or other interest with the vendor so that the party will actually or by effect receive or control a portion of the benefit, profit or other consideration from performance of a vendor contract with the party receiving an amount that meets or exceeds five percent of the total contract amount.

EXCEPTION: The prohibition of this section does not apply where a vendor has contested any tax administered pursuant to chapter eleven of this code, workers' compensation premium, permit fee or environmental fee or assessment and the matter has not become final or where the vendor has entered into a payment plan or agreement and the vendor is not in default of any of the provisions of such plan or agreement.

Under penalty of law for false swearing (*West Virginia Code* §61-5-3), it is hereby certified that the vendor affirms and acknowledges the information in this affidavit and is in compliance with the requirements as stated.

WITNESS THE FOLLOWING SIGNATURE

Vendor's Name: _____

Authorized Signature: _____ Date: _____

State of _____

County of _____, to-wit:

Taken, subscribed, and sworn to before me this ____ day of _____, 20 ____.

My Commission expires _____, 20 ____.

AFFIX SEAL HERE

NOTARY PUBLIC _____

State of West Virginia

VENDOR PREFERENCE CERTIFICATE

Certification and application* is hereby made for Preference in accordance with West Virginia Code, §5A-3-37. (Does not apply to construction contracts). West Virginia Code, §5A-3-37, provides an opportunity for qualifying vendors to request (at the time of bid) preference for their residency status. Such preference is an evaluation method only and will be applied only to the cost bid in accordance with the West Virginia Code. This certificate for application is to be used to request such preference. The Purchasing Division will make the determination of the Resident Vendor Preference, if applicable.

1. Application is made for 2.5% resident vendor preference for the reason checked:

----- Bidder is an individual resident vendor and has resided continuously in West Virginia for four (4) years immediately preceding the date of this certification; or,

----- Bidder is a partnership, association or corporation resident vendor and has maintained its headquarters or principal place of business continuously in West Virginia for four (4) years immediately preceding the date of this certification; or 80% of the ownership interest of Bidder is held by another individual, partnership, association or corporation resident vendor who has maintained its headquarters or principal place of business continuously in West Virginia for four (4) years immediately preceding the date of this certification; or,

----- Bidder is a nonresident vendor which has an affiliate or subsidiary which employs a minimum of one hundred state residents and which has maintained its headquarters or principal place of business within West Virginia continuously for the four (4) years immediately preceding the date of this certification; or,

2. Application is made for 2.5% resident vendor preference for the reason checked:

----- Bidder is a resident vendor who certifies that, during the life of the contract, on average at least 75% of the employees working on the project being bid are residents of West Virginia who have resided in the state continuously for the two years immediately preceding submission of this bid; or,

3. Application is made for 2.5% resident vendor preference for the reason checked:

----- Bidder is a nonresident vendor employing a minimum of one hundred state residents or is a nonresident vendor with an affiliate or subsidiary which maintains its headquarters or principal place of business within West Virginia employing a minimum of one hundred state residents who certifies that, during the life of the contract, on average at least 75% of the employees or Bidder's affiliate's or subsidiary's employees are residents of West Virginia who have resided in the state continuously for the two years immediately preceding submission of this bid; or,

4. Application is made for 5% resident vendor preference for the reason checked:

----- Bidder meets either the requirement of both subdivisions (1) and (2) or subdivision (1) and (3) as stated above; or,

5. Application is made for 3.5% resident vendor preference who is a veteran for the reason checked:

----- Bidder is an individual resident vendor who is a veteran of the United States armed forces, the reserves or the National Guard and has resided in West Virginia continuously for the four years immediately preceding the date on which the bid is submitted; or,

6. Application is made for 3.5% resident vendor preference who is a veteran for the reason checked:

----- Bidder is a resident vendor who is a veteran of the United States armed forces, the reserves or the National Guard, if, for purposes of producing or distributing the commodities or completing the project which is the subject of the vendor's bid and continuously over the entire term of the project, on average at least seventy-five percent of the vendor's employees are residents of West Virginia who have resided in the state continuously for the two immediately preceding years.

Bidder understands if the Secretary of Revenue determines that a Bidder receiving preference has failed to continue to meet the requirements for such preference, the Secretary may order the Director of Purchasing to: (a) reject the bid; or (b) assess a penalty against such Bidder in an amount not to exceed 5% of the bid amount and that such penalty will be paid to the contracting agency or deducted from any unpaid balance on the contract or purchase order.

By submission of this certificate, Bidder agrees to disclose any reasonably requested information to the Purchasing Division and authorizes the Department of Revenue to disclose to the Director of Purchasing appropriate information verifying that Bidder has paid the required business taxes, provided that such information does not contain the amounts of taxes paid nor any other information deemed by the Tax Commissioner to be confidential.

Under penalty of law for false swearing (West Virginia Code, §61-5-3), Bidder hereby certifies that this certificate is true and accurate in all respects; and that if a contract is issued to Bidder and if anything contained within this certificate changes during the term of the contract, Bidder will notify the Purchasing Division in writing immediately.

Bidder: _____ Signed: _____

Date: _____ Title: _____

*Check any combination of preference consideration(s) indicated above, which you are entitled to receive.

WV-96
Rev. 10/07

AGREEMENT ADDENDUM

In the event of conflict between this addendum and the agreement, this addendum shall control:

1. DISPUTES - Any references in the agreement to arbitration or to the jurisdiction of any court are hereby deleted. Disputes arising out of the agreement shall be presented to the West Virginia Court of Claims.
2. HOLD HARMLESS - Any clause requiring the Agency to indemnify or hold harmless any party is hereby deleted in its entirety.
3. GOVERNING LAW - The agreement shall be governed by the laws of the State of West Virginia. This provision replaces any references to any other State's governing law.
4. TAXES - Provisions in the agreement requiring the Agency to pay taxes are deleted. As a State entity, the Agency is exempt from Federal, State, and local taxes and will not pay taxes for any Vendor including individuals, nor will the Agency file any tax returns or reports on behalf of Vendor or any other party.
5. PAYMENT - Any references to prepayment are deleted. Payment will be in arrears.
6. INTEREST - Should the agreement include a provision for interest on late payments, the Agency agrees to pay the maximum legal rate under West Virginia law. All other references to interest or late charges are deleted.
7. RECOUPMENT - Any language in the agreement waiving the Agency's right to set-off, counterclaim, recoupment, or other defense is hereby deleted.
8. FISCAL YEAR FUNDING - Service performed under the agreement may be continued in succeeding fiscal years for the term of the agreement, contingent upon funds being appropriated by the Legislature or otherwise being available for this service. In the event funds are not appropriated or otherwise available for this service, the agreement shall terminate without penalty on June 30. After that date, the agreement becomes of no effect and is null and void. However, the Agency agrees to use its best efforts to have the amounts contemplated under the agreement included in its budget. Non-appropriation or non-funding shall not be considered an event of default.
9. STATUTE OF LIMITATION - Any clauses limiting the time in which the Agency may bring suit against the Vendor, lessor, individual, or any other party are deleted.
10. SIMILAR SERVICES - Any provisions limiting the Agency's right to obtain similar services or equipment in the event of default or non-funding during the term of the agreement are hereby deleted.
11. ATTORNEY FEES - The Agency recognizes an obligation to pay attorney's fees or costs only when assessed by a court of competent jurisdiction. Any other provision is invalid and considered null and void.
12. ASSIGNMENT - Notwithstanding any clause to the contrary, the Agency reserves the right to assign the agreement to another State of West Virginia agency, board or commission upon thirty (30) days written notice to the Vendor and Vendor shall obtain the written consent of Agency prior to assigning the agreement.
13. LIMITATION OF LIABILITY - The Agency, as a State entity, cannot agree to assume the potential liability of a Vendor. Accordingly, any provision limiting the Vendor's liability for direct damages to a certain dollar amount or to the amount of the agreement is hereby deleted. Limitations on special, incidental or consequential damages are acceptable. In addition, any limitation is null and void to the extent that it precludes any action for injury to persons or for damages to personal property.
14. RIGHT TO TERMINATE - Agency shall have the right to terminate the agreement upon thirty (30) days written notice to Vendor. Agency agrees to pay Vendor for services rendered or goods received prior to the effective date of termination.
15. TERMINATION CHARGES - Any provision requiring the Agency to pay a fixed amount or liquidated damages upon termination of the agreement is hereby deleted. The Agency may only agree to reimburse a Vendor for actual costs incurred or losses sustained during the current fiscal year due to wrongful termination by the Agency prior to the end of any current agreement term.
16. RENEWAL - Any reference to automatic renewal is hereby deleted. The agreement may be renewed only upon mutual written agreement of the parties.
17. INSURANCE - Any provision requiring the Agency to insure equipment or property of any kind and name the Vendor as beneficiary or as an additional insured is hereby deleted.
18. RIGHT TO NOTICE - Any provision for repossession of equipment without notice is hereby deleted. However, the Agency does recognize a right of repossession with notice.
19. ACCELERATION - Any reference to acceleration of payments in the event of default or non-funding is hereby deleted.
20. CONFIDENTIALITY: -Any provision regarding confidentiality of the terms and conditions of the agreement is hereby deleted. State contracts are public records under the West Virginia Freedom of Information Act.
21. AMENDMENTS - All amendments, modifications, alterations or changes to the agreement shall be in writing and signed by both parties. No amendment, modification, alteration or change may be made to this addendum without the express written approval of the Purchasing Division and the Attorney General.

ACCEPTED BY:

STATE OF WEST VIRGINIA

Spending Unit: _____

Signed: _____

Title: _____

Date: _____

VENDOR

Company Name: Varian, Inc.

Signed: Andrea Shipp

Title: Contracts manager

Date: 7/13/10

ATTACHMENT
P.O.# LBS11009

This agreement constitutes the entire agreement between the parties, and there are no other terms and conditions applicable to the licenses granted hereunder.

Agreed

Signature Date

Title

Company Name

Signature Date

Title

Agency/Division

See letter dated 7/15/10



Quotation

30230201439

07/09/2010

Page: 1

VARIAN

Varian Inc.
 2700 Mitchell Drive
 Walnut Creek, CA 94598
 www.varianinc.com
 Phone: (800) 926-3000 Fax: (925) 945-2360
 Email: csb-salesupport@varianinc.com

Quotation For:

Patrick Marchio
 West Virginia Dept. of Health
 Environmental Chemistry Lab
 4710 Chimney Drive, Suite G
 Charleston, WV 25302
 (304) 965 - 2694 [2235] FAX: (304) 558 - 4143

<i>Your Inquiry:</i>	Varian Standard Terms & Conditions apply (see attached)
<i>Payment Terms:</i>	<i>Quotation Expires:</i> August 8, 2010
<i>Shipping Method:</i> Best Way, Prepaid & Add	<i>Delivery Lead Time:</i> TBD
<i>FOB:</i> ORIGIN	<i>Unit Price Basis:</i> USD

 All applicable taxes, freight
 insurance, and/or other
 handling charges
 will be added at invoicing.

Submitted by:

4E5

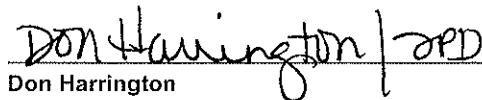
 Don Harrington

For Order Placement:

Please reference Quotation Number on all purchase orders.
 Please forward all Purchase Orders and Correspondence to:
 Varian Inc.
 2700 Mitchell Drive
 Walnut Creek, CA 94598
 (800) 926-3000 Fax (925) 945-2360



VARIAN

Quotation

30230201439

07/09/2010

Page: 2

West Virginia Dept. of Health, Charleston, WV

Item	Qty	Part Number	Product Description	Unit Price	Discount	Amount
------	-----	-------------	---------------------	------------	----------	--------

Section 1						
------------------	--	--	--	--	--	--

1.01	1	T9300010000	325-MS TRIPLE QUAD LCMS/MS W/ ESI & TRNG 325-MS Triple Quadrupole LC/MS, vESI, 230V, with Training	204,000.00	20.00%	163,200.00
------	---	-------------	--	------------	--------	------------

INCLUDES: 325-MS LC/MS triple quadrupole system with built-in syringe pump and 6-port valve, API module and vESI housing, control software, PC (no monitor), 2 MS40+ foreline pumps, installation and 1-year warranty.

NOT INCLUDED with system: HPLC pumps, autosamplers, computer monitor, printer.

NOTE: The system CANNOT be upgraded with a GC interface for a GC/MS configuration.

LC Interface:

Ionization modes includes Vortex Electrospray Ionization (vESI). vESI allows full X-Y adjustment of the spray needle relative to the capillary inlet and fine adjustment of inner needle position and operates over flow range of 50 to 2000 µL/min. vESI and optional ESI/APCI spray chambers are hinged for easily and rapid switch between ionization techniques. Dual off-axis, capillary interface operates in positive or negative ionization mode. Includes a six port LC valve that can be configured as a diverter valve or injector valve. Includes a built-in syringe for mass calibration, method development, or analysis.

MS Features:

325-MS modes includes full scan, Selected Ion Monitoring (SIM), Precursor (Parent) scan, Product (Daughter) scan, Neutral Loss scan, Single Reaction Monitoring (SRM), and Multiple Reaction Monitoring (MRM) with an upper operating m/z of 2000. High efficiency quadrupole mass filters (Q1 and Q3) incorporates pre- and post-filters. 180 degree path of Q2 places multiplier in true off-axis position from the source and provides a long (185 mm) collision path for efficient CID of precursor ions. Multiplier employs +/- 5kV post acceleration voltage for optimal ion collection. New extended dynamic range (EDR). Fast polarity switching. Dual stage, 301/401 L/sec turbo molecular pump provides differential pumping for the source and analyzer compartments. Electronic Pressure Control (EPC) for all API and CID gases. Dual foreline pumps. SelecTemp programmable temperature control delivers optimum drying gas temperatures at every point in a complex analysis. The API interface with SelecTemp allows simplified setup, greater throughput, reduced contamination and improves detection of labile compounds. SelecFlow, a programmable pressure control system, allows accurate control of gas flows by time segment to provide better sensitivity and area reproducibility for specific compounds. Both SelecTemp and SelecFlow parameters can be automatically recorded for GLP purposes.

Workstation Features:

The Varian MS Workstation software controls all MS functions and allows fully automated quantitative and qualitative analyses with standard and optional Custom Reports. The workstation also controls all HPLC options to include Varian autosamplers, pumps, and detectors.

Additional Software Available



VARIAN

Quotation

30230201439

07/09/2010

Page: 3

West Virginia Dept. of Health, Charleston, WV

Item	Qty	Part Number	Product Description	Unit Price	Discount	Amount						
			<ul style="list-style-type: none"> • MassID – Spectral deconvolution of multiply charged species • QuickAccess – Network access and functionality for multiple MS WorkStation systems for high-throughput analysis by expert or novice users. <p>OptiPlex 960 MiniTower Computer Base: Intel® Core 2 Duo E8400, 3.0 GHz, 6MB L2 cache, 1333MHz FSB Memory: 2GB (2 x 1GB) DDR2 Non-ECC SDRAM, 800MHz, (filling 2 of 4 slots; expandable to 8GB) Video: Video card in PCIe bus with 1 DVI (digital) 1920x1200 max. output Sound: Integrated sound card and chassis mounted speaker Network: Integrated Intel NIC (10/100/1000 Ethernet (Intel WG82567LM LOM)) Hard Drive: SATA 250GB,3.0GB/s, 7200 RPM with 8 MB buffer (NTFS format) Removable Media Storage Device: 16X DVD+/-RW SATA Drive with Roxio Creator (Dell edition) Floppy Drive: 1.44MB 3.5 Inch Floppy Drive Card Slots: 4 PCI full height slots (2 standard PCI, 1 PCIe x16 graphics, 1 PCIe x1) Ports: 1 VGA; 1 serial port; 2 PS2; RJ-45 network port; 10 USB 2.0 ports (2 in front, 6 in rear) Keyboard & Mouse: Dell USB enhanced multimedia keyboard & USB premium optical 5-button scroll mouse Operating System: Microsoft® Windows® XP Professional, SP2 Hardware Support Services: 3 Year Limited Warranty (Next Business Day On-Site Service) Resource CD: Resources CD contains Diagnostics and Driver for Dell OptiPlex Systems NOTE: Minitower dimensions: H:16.10 in. x W:7.32 in.; D:16.97 in. RoHS Compliant Lead Free Chassis and Motherboard. Monitor or printer NOT included.</p> <p>LC/MS/MS Performance Specifications</p> <table border="1"> <thead> <tr> <th>Mode</th> <th>Test Standard</th> <th>S/N*</th> </tr> </thead> <tbody> <tr> <td>+ESI MRM</td> <td>500 fg Reserpine</td> <td>800:1</td> </tr> </tbody> </table> <p>*Based on RMS noise; 0.7 PWHM res</p> <p>System with training (for U.S. customers only): ^ The T... PNs include includes installation and onsite training (2 days) covering theory, operation, and maintenance. Onsite training is available only in the U.S. Pricing is for zone 1(<100 miles). Additional charges may apply if outside of zone 1.</p>	Mode	Test Standard	S/N*	+ESI MRM	500 fg Reserpine	800:1			
Mode	Test Standard	S/N*										
+ESI MRM	500 fg Reserpine	800:1										
1.02	1	0190067100	<p>PC MONITOR, 22-in WIDESCREEN</p> <p>Flat panel LCD monitor with adjustable height stand and 4 built in USB 2.0 ports. Contrast ratio of 500:1 with responses of 8 MS typical. Pixel pitch is 0.264 mm. Optimal resolution 1280 X 1024 at 60 HZ. Includes limited 3 year warranty.</p>	604.00	20.00%	483.00						
1.03	1	0190020400	<p>HP Deskjet Color Printer 120V (With Cable)</p> <p>Includes: 10' USB cable. 4-color ink (6-color ink option); 1200 dpi x 1200 dpi black resolution; 4800 dpi x 1200 dpi color resolution; legal & A4 paper size; 100-sheet capacity; up to 30 ppm (mono) / up to 23 ppm (color) print speed; USB 2.0 interface; 120/230 VAC.</p>	276.00	20.00%	221.00						
Section Total \$						163,904.00						

This document is confidential and intended solely for the information and benefit of the immediate recipient and Varian



Quotation

30230201439

07/09/2010

Page: 4

VARIAN

West Virginia Dept. of Health, Charleston, WV

Item	Qty	Part Number	Product Description	Unit Price	Discount	Amount
------	-----	-------------	---------------------	------------	----------	--------

Section 2

2.01	1	DHUHPLCMS12W	NITROGEN GAS GENERATOR w/ DOMNICK-HUNTER MODEL G4-510W.	10,700.00	20.00%	8,560.00
------	---	--------------	--	-----------	--------	----------

Nitrogen Generator w/ Built-in Air Compressor, 115V. Produces 12L/min of 99.5% nitrogen at 100 psig.

Domnick Hunter LC/MS nitrogen generators are specifically designed to meet the gas flow, purity and pressure requirements of the latest generation of LC/MS instruments. Utilizing the pressure swing adsorption (PSA) technique, the generators provide a continuous stream of clean, dry nitrogen without the need for secondary purification and are fully compatible with all known APCI and ESI interfaces. This model features an integral oil-free compressor, giving increased security of supply, completely removing the reliance on external air supplies.

Features:

- Suitable for nebulizing, sheath and drying gas
- Integral oil-free compressor
- Fully regenerative, proven durability PSA technology
- Phthalate-free
- Soundproofed compressor box
- Digital interface
- CE, UL and CRN approved
- Global manufacturing support

Benefits:

- Improved instrument performance - Guaranteed consistent nitrogen purity improves stability and ensures greater reproducibility of results
- Low and stable gas supply costs - Payback in less than 18 months
- Security of supply - Integral oil-free compressors removes the reliance on dedicated compressed air supplies
- Reduced Health and Safety risks - No manual handling or high pressure gas storage
- Peace of mind - Service contracts and extended warranty available
- Effortless operation - Gas at the push of a button
- Space saving - Fits under bench
- Expert advice - Domnick Hunter has over 20 years experience of with PSA system designs

Section Total \$	8,560.00
-------------------------	-----------------

Section 3



VARIAN

Quotation

30230201439

07/09/2010

Page: 5

West Virginia Dept. of Health, Charleston, WV

Item	Qty	Part Number	Product Description	Unit Price	Discount	Amount
3.01	1	0391180001	SYSTEM, MODEL 212 BINARY SOLVENT The Varian 212-LC chromatography pump is engineered to be the most stable and reliable analytical LC/MS pump in the laboratory today. This binary pumping system is the ideal liquid chromatography solution for environmental samples, small molecule pharmaceuticals and various industrial process samples. The pumping system features: - Patented self-aligning pump seal design for long seal life - Self priming design for reliability and ease-of-use - Rugged, stackable metal boxes for small lab bench footprint - Controlled by MS Workstation Software (version 6.6 or higher) for full integration with Varian MS units, complete GLP-type run logs, and optional full Audit Trail (21CFR11) The pumping system performance: - Settable gradient flow rate range: 100 µL/min to 2.0 mL/min (0.001 mL/min increments) - Settable isocratic flow rate range: 0.001 mL/min to 2.0 mL/min (0.001 mL/min increments) - Maximum pressure: 400 Bar (6000 psi) - Flow precision: ±1.5 % - Flow accuracy: ± 1 % or ± 1 µL/min, whichever is greater - Gradient composition accuracy: < ±1% absolute (10% step test, water @ 200 µL/min 2000 psi) - Gradient compositional precision: < ±1% absolute (10% step test, water @ 200 µL/min 2000 psi) - Pressure pulsation: <1.0% ? P/P (200 µL/min, 2000 psi) Note: Unless otherwise indicated specified values apply from 100 to 400 µL/min. The 212-LC system includes: 2 Dual piston pumps, 150µL mixer, damper, 10µ inlet filters, communication cables, and connecting tubing. Required accessory (not included): Degasser	18,900.00	20.00%	15,120.00

Section Total \$ 15,120.00

Section 4

4.01	1	AL590500	SOLVENT DEGASSER, 2-CHANNEL, 1ML/MIN 2-Channel In-Line Solvent Degasser; 1 mL/min. Recommended for 212-LC pumps for flow rates up to 1 mL/min. Degasser has Teflon® AF degassing membrane for 50x more efficient degassing than competitive PTFE membranes. Channel volumes are 10x smaller and equilibrate 4x faster. Degasser is equipped with a continuous-run vacuum pump, which delivers a steady baseline, and not a fluctuating baseline found with other	3,440.00	20.00%	2,752.00
------	---	----------	--	----------	--------	----------



VARIAN

Quotation

30230201439

07/09/2010

Page: 6

West Virginia Dept. of Health, Charleston, WV

Item	Qty	Part Number	Product Description	Unit Price	Discount	Amount
degassers due to the on/off cycle of the vacuum pump.						
Section Total \$						2,752.00

Section 5

5.01	1	9300014802	460-LC A/S, w/ Cool<(>&<)>Heating,95-240V	19,450.00	20.00%	15,560.00
------	---	------------	---	-----------	--------	-----------

Varian 460-LC AutoSampler with Heating & Cooling, 90-240V
 Includes: 84+3 sample tray; RS-422 cable; USA and Euro power cables, etc. Cools and heats samples to 4 to 40 degrees C with forced air Peltier cooling and heating.

The 460-LC AutoSampler for LC-MS systems offers many features for maximum laboratory productivity.

- Handles a variety of well plates and sample vials, open or sealed
- Thorough sample cooling and heating - available as an option
- Efficient needle wash for low carry-over

The compact, stackable design and its economic pricing make this the ideal autosampler for many laboratories!

The 460-LC AutoSampler offers the best of both worlds. It is intelligent for research applications yet rugged enough for routine quality control work. With Pressure Assisted Sampling Aspiration (PASATM), the 460-LC AutoSampler applies pressure within the vial while the sample is withdrawn by a high resolution syringe. Air bubbles and in-vial vacuum problems are eliminated resulting in excellent reproducibility.

Flexible and Reliable

The 460-LC AutoSampler's three injection modes combine flexibility, available sample volume, and precision.

Choose from:

Full Loop - overfills the sample loop for maximum precision.

Partial Loop - program variable injection volumes easily.

Microliter Pickup - withdraws the exact amount to be injected without sample loss (with "84+3" standard sample tray).

Compact and Easy-to-Use

The stackable design and compact design saves bench space. Access to the syringe, injector, and needle is easy with the lift-up front panel and removable top cover.

Interchangeable Sample Trays

The "84+3" sample tray holds 84 vials 2 mL vials + 3 vials 10 mL and is the standard autosampler tray. It is a double-wide tray and cannot be used with other trays. Other optional trays include: 48 Vials (2 mL), 12 Vials (10 mL), 96 High or Low Well Plates, and 384 Low Well Plates. The autosampler holds two sample trays (but is limited to one "84+3" tray).

Auto Mix Sample Preparation

Internal standard addition, sample dilution, or derivatization steps are easily programmed to reduce sample preparation time and errors associated with manual



VARIAN

Quotation

30230201439

07/09/2010

Page: 7

West Virginia Dept. of Health, Charleston, WV

Item	Qty	Part Number	Product Description	Unit Price	Discount	Amount
			procedures when used in conjunction with the Adapter tray. Using vial-to-vial transfers or dedicated large volume reagent vials, the 460-LC AutoSampler accomplishes many types of sample preparation routines. The standard "84+3" sample tray accommodates both sample vials and reagent vials in one tray set.			
Section Total \$						15,560.00

Section 6

6.01	1	0393580001	ProStar 500 Column Heater Assmby (120V)	1,510.00	20.00%	1,208.00
6.02	1	A2005050X020	Polaris Si-A 3u 50 x 2.0mm *****	397.00	20.00%	318.00
6.03	1	A7501100X020	Pursuit XRs Ultra 2.8 C18 100 x 2.0mm *****	457.00	20.00%	366.00
Section Total \$						1,892.00

Section 7

7.01	1	0010083800	ProStar 335 DAD, Microbore to Analytical The ProStar 335 Diode Array Detector Wavelength range: 190 to 950 nm, accuracy: ± 1 nm, 656 D2 line, verified with the 486 D2 line Light Source: D2 and Quartz Halogen The polychromator uses dual 1024 diode arrays for sample and reference channel (analytical to preparative) to give full dual cell path extended dynamic range capability. (For single array mode, two photodiodes, one centered at 250 and one centered at 500 nm, correct for variations in light output). Second order stray light is suppressed by Varian's patented Seamless Spectral Coverage Technology formed on the array windows. Noise at ± 1.0 x 10 ⁻⁵ AU. Drift: 1x10 ⁻³ AU/hr. Linearity range: ± 5% to 2 AU, > 2.5 AU upper limit. Programmable slit widths (1, 2, 4, 8, 16 nm) for optimizing noise or optical resolution. Digital resolution: 1 nm. Sensitivity setting range: 1 µAU to 100 AU with software. Filter setting range: via software. Diode width: <1 nm. The 335 features an easy access flow cell and lamp design that allows removal and installation of both the cell and lamps from the front of the instrument without the need for tools. Four flow cells are available: 1 Microbore, Single Path, 4mm, 1.5 µL 2 Analytical, Single Path, 9 mm, 15 µL	16,250.00	20.00%	13,000.00
------	---	------------	---	-----------	--------	-----------



VARIAN

Quotation

30230201439

07/09/2010

Page: 8

West Virginia Dept. of Health, Charleston, WV

Item	Qty	Part Number	Product Description	Unit Price	Discount	Amount
			3 Preparative, Dual Path, 9mm and 1mm, (Dual array only)			
			4 Super Preparative, Dual Path, 4mm and 0.15mm, (Dual array only)			
			Dual focusing lenses in the flow cells minimize refractive index effects of flowing liquid.			
			The functions of the ProStar 335 are controlled by Galaxie CDS/WS or Star WorkStation through Ethernet. Peak Purity Parameter calculations, Multicomponent Analysis (MCA), and Spectral Library searches in Star Workstation are performed with the use of PolyView2000 spectral processing software. Peak Purity and Spectral Library searches in Galaxie CDS/WS.			
Section Total \$						13,000.00

Section 8

8.01	1	9300015400	Prep Kit, 460-LC, Field Installation Kit Includes: 2.5 mL syringe, Prep valve, 10 mL Prep Kit, Field Installable For Varian 460-LC Autosampler. Includes: 2.5 mL syringe, Prep valve, 10 mL sample loop, LSV needle and one 12 x 10 mL vial sample tray.	3,120.00	20.00%	2,496.00
8.02	1	8950010500	1L BOTTLE W/GRAD/TEF CAP HPLC Solvent Reservoir Bottle, 1 L, Clear Borosilicate Glass Bottle has volume graduations and a size 38-430 screw cap. Requires 2 for 212-LC system (1 per pump).	22.00	20.00%	18.00
8.03	1	0390563890	RESERVOIR SCREW CAP KIT HPLC Solvent Reservoir Cap Kit Cap, 38-430 size, with 2 holes. Includes: 50 in. x 1/8 in. OD TFE tubing and 3 in. vent line. Requires 2 for 212-LC system (1 per pump).	58.00	20.00%	46.00
8.04	1	ASA5001133	INLET / OUTLET CV CRTDG, 212-LC 2ml HEAD	271.00	20.00%	217.00
8.05	1	ASA5001133			20.00%	Included
8.06	1	ASA5001033K	2ml WASH SEAL KIT, 212LC GRADIENT	634.00	20.00%	507.00
8.07	1	SH0045131	Sample Tray for 48x2mL vials; 460-LC; Stainless	152.00	20.00%	122.00
8.08	1	0210181800	Flow Cell for ProStar 325/335 9x0 (analytical) 15 uL, 100 mL/min flow rate max, 1000 psi	1,145.00	20.00%	916.00
Section Total \$						4,322.00
Quotation Total \$						225,110.00



VARIAN

Quotation

30230201439

07/09/2010

Page: 9

West Virginia Dept. of Health, Charleston, WV

Item	Qty	Part Number	Product Description	Unit Price	Discount	Amount
------	-----	-------------	---------------------	------------	----------	--------

THIS IS NOT AN INVOICE

Terms & Conditions of Sale

This offer is subject to credit approval and is exclusive of any applicable sales taxes or duties.



Financing Alternatives

Varian is pleased to present an alternative finance package for your consideration in acquisition of this instrumentation. You may not be aware that leasing offers 100% financing including installation and taxes. We can also let your organization realize some important additional benefits such as improved cash flow, flexibility to expand or upgrade your system, as well as fixed rate financing with protection against inflation.

Below are estimated monthly payments for different leasing options based on Quotation: 30230201439

10% Purchase Options

36 Months	48 Months	60 Months
\$6,514	\$5,069	\$4,216

\$1.00 Purchase Options

36 Months	48 Months	60 Months
\$7,068	\$5,470	\$4,524

10% Purchase Option: Also known as a tax or operating lease, the intent is not necessarily to own, but to gain the benefits of the equipment in exchange for the low monthly payment. At the end of the lease term, your company has the option to purchase the equipment for 10% of the original finance amount. In addition, your company may expense 100% of each monthly payment off its pre-tax income, reducing tax liability.

\$1.00 Purchase Option: Also known as a capital lease, the intent is to own the equipment at the end of the lease term. The equipment is depreciated and your company owns it with the last monthly payment.

Additional Benefits

- Stay within your budget
- Conserve cash
- Finance 100% -including service, installation and taxes
- Quick and easy application process

If your organization is interested in these or other finance programs, contact the following:

Ameritech Leasing, Inc.
Bill Scopp
913-381-3344 x202

De Lage Landen Financial Services
Jeff Smith
845-897-2272

Lease World Corp.
Manny Licker
954-969-1965

Trinity Vendor Finance
Craig de Koning
800-841-4433 x177

WB Financial LLC
Bob Fode
714-915-9444

JB2 Funding Corp.
Jacob White
877-386-3522 x 333

**VARIAN ANALYTICAL INSTRUMENTS
TERMS AND CONDITIONS OF SALE**

1. GOVERNING TERMS. These Terms and Conditions of Sale ("Terms") shall apply to the sale by Varian, Inc. or its affiliated company ("Varian") of the products and/or services ("Products") described in the Quotation, Sales Order, Acknowledgment, Purchase Order, web page or other contract documentation to which these Terms are attached, incorporated by reference and made an integral part (the "Contract Documents"). Except as expressly agreed by authorized representatives of both parties in writing, no other terms and conditions, including any terms and conditions attached to Buyer's request for quotation, acknowledgment, purchase order or other contract documentation, shall apply to Varian's sale of the Products. Varian's shipment of any Product or performance of any purchase order or contract is expressly conditioned on Buyer's acceptance of these Terms. As used herein, "Contract" refers to the applicable order pursuant to which Varian is selling the Products to Buyer.

2. PRICE AND PAYMENT. Except as otherwise specified in the Contract Documents, Varian's prices exclude and Buyer is responsible for all sales, use, excise, value-added or other taxes and duties. Buyer's late payment shall constitute a fundamental breach of the Contract, shall result in a service charge against Buyer of the lesser of 2% per month of the Contract amount or the maximum amount permitted by law, and shall entitle Varian to cancel or delay performance under the Contract. Varian shall retain a purchase money security interest or similar lien or right of repossession in all Products shipped to Buyer under the Contract until paid in full. Buyer shall execute documents and make filings or recordings as requested by Varian for the perfection or other protection of such security interest. Buyer shall be responsible for any costs of collection incurred by Varian hereunder, including reasonable attorneys' fees.

3. DELIVERY. Unless otherwise specified in the Contract Documents, Buyer shall take title and risk of loss of the Products at point of delivery for Products shipped by Varian, Inc. to a non-U.S. destination and at point of shipment in all other cases. Training, if included in Products, must be taken by Buyer within one year following shipment of system.

4. INSTALLATION. If installation is included in Products, Buyer shall provide any necessary permits, facilities, and utilities, ensure compliance with regulatory requirements, and comply with Varian's reasonable pre-installation instructions in a timely fashion.

5. INFRINGEMENT INDEMNITY. Varian shall defend and indemnify Buyer from all third party claims alleging that Varian's design or manufacture of any Product infringes any third party patent or other intellectual property right, except to the extent such claims arise from or relate to (a) any Product or component thereof designed by Buyer, (b) modification of any Product without Varian's express written consent, (c) use of any Product in combination with any product, process, application, or material or system not designed or manufactured by Varian, or (d) products manufactured by Buyer using any Product.

6. SOFTWARE LICENSE. Title to all software provided as separate modules or embedded in the Products ("Software") shall remain the property of Varian or Varian's licensors. Varian grants to Buyer a non-exclusive, limited license to use the Software together with the Products. Buyer shall not decompile, disassemble or otherwise reverse engineer the Software, and may create derivative works only to the extent permitted by Varian. Buyer shall not sublicense, assign, copy, distribute or disclose any portion of the Software to a third party without the express written consent of Varian. Buyer may transfer or sell the Software only together with the Products. This license shall terminate when Buyer discontinues use of the Software.

7. WARRANTY. Varian warrants consumable laboratory supplies and Software sold under these Terms to be free from defects in material and workmanship and in substantial conformance with Varian's

published specifications for a period beginning upon delivery and ending fourteen (14) days thereafter, subject to any applicable license agreement. Varian warrants services sold under these Terms to be performed in a good and workmanlike manner for a period beginning upon performance and ending thirty (30) days thereafter. Varian warrants all other Products sold under these Terms to be free from defects in material and workmanship and in substantial conformance with Varian's published specifications for a period beginning upon delivery and ending ninety (90) days thereafter. Varian does not warrant the operation of any Software to be uninterrupted or error-free. The foregoing warranty periods shall be deemed extended to the extent required by any mandatory, non-waivable provision of applicable law. The foregoing warranties are void in the event of Product abuse, alteration, misuse, improper operation or maintenance, use in an unsuitable physical environment, or use with inadequate facilities or utilities, and these warranties do not cover products, components, or services warranted by another party. Buyer's sole and exclusive remedy for any defective or non-conforming Product after its warranty period begins shall be repair, replacement with either a new or refurbished Product, or credit, at Varian's sole option, and such remedy shall be available only during the applicable warranty period. Repaired or replaced Products shall be subject to the original warranty period, which shall not be extended due to such repair or replacement, except to the extent required by any mandatory, non-waivable provision of applicable law. **THE FOREGOING WARRANTIES ARE EXCLUSIVE AND IN LIEU OF ALL OTHER EXPRESS OR IMPLIED WARRANTIES, INCLUDING BUT NOT LIMITED TO ANY WARRANTY OF MERCHANTABILITY OR FITNESS FOR A PARTICULAR PURPOSE.**

8. DAMAGES. In no event shall Varian or Buyer be liable to the other or their respective affiliates for incidental, consequential, indirect, punitive, or special loss or damages of any kind, including but not limited to lost revenues, lost profits, loss of goodwill or lost production, however caused, whether based on contract, tort (including negligence) or any other legal theory. Varian's total liability in damages or otherwise to Buyer and its affiliates shall not exceed payments received by Varian for the unit of Product furnished or to be furnished resulting in the loss or damage claimed.

9. FORCE MAJEURE. Neither Varian, nor Buyer shall be liable to the another for failure to perform any obligation under the Contract to the extent such failure to perform is due to labor unrest, riot, war, fire, accident, weather or other natural disasters, lack of energy supplies, supplier delays, compliance with law, failure to obtain all necessary licenses, permits or approvals after reasonable efforts, or any unforeseen circumstances or other causes beyond such party's reasonable control.

10. SOLE TERMS. These Terms and the Contract Documents of which they are a part set forth the entire agreement between Varian and Buyer with respect to their subject matter and supersede all previous written or oral agreements and understandings between Varian and Buyer. These Terms and the Contract Documents may not be amended nor may compliance with any provision herein or therein be waived, except by a written document duly and validly executed by both Varian and Buyer, or in the case of a waiver, the party waiving compliance. Any part of these Terms held to be void, invalid or unenforceable shall be treated as severable, leaving valid the remaining Terms.

11. GOVERNING LAW; DISPUTES. If this Contract concerns the sale of Products to be delivered to U.S. destinations, it shall be governed by the laws of the State of California, U.S.A. (excluding choice of law rules and the provisions of the Convention for the International Sale of Goods (CISG)). Any dispute or claim arising out, relating to or in connection with such a Contract shall be resolved exclusively by final, binding arbitration pursuant to the American Arbitration Association, provided that, Varian may seek injunctive or other relief in any court of law in order to prevent any unauthorized copying, disclosure, use, retention or distribution of its intellectual property. If this Contract concerns the sale of Products to be delivered to non-U.S. destinations, it shall be governed by CISG and (for issues not addressed by CISG) by local law applied pursuant to choice of law rules or mutual agreement of the parties and any disputes or claims may be resolved in any court of competent jurisdiction.

VARIAN, INC

325-MS

TRIPLE QUADRUPOLE MASS SPECTROMETER

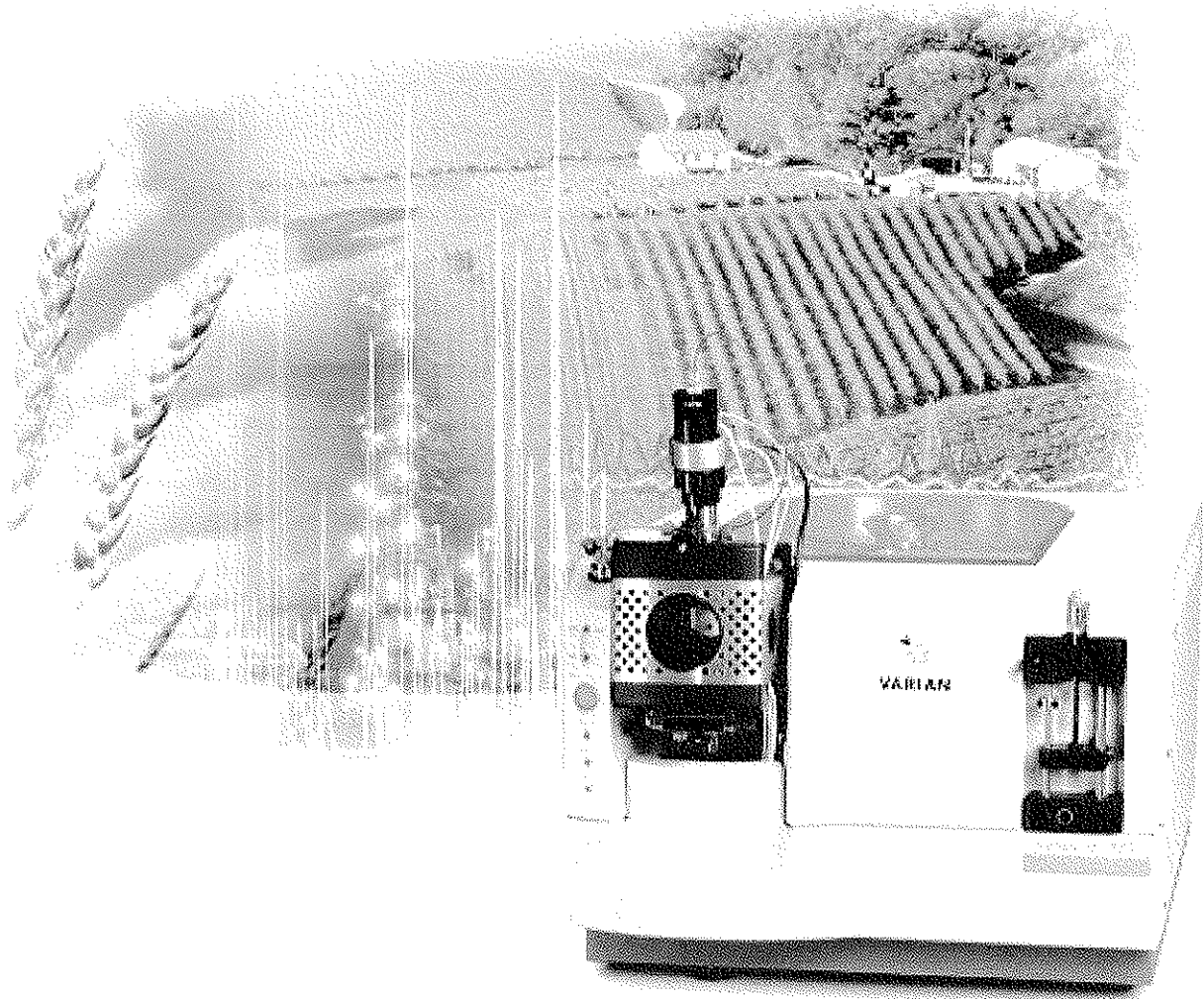

www.varianinc.com



VARIAN

Small Molecules – Big Challenges

Your samples are precious and turnaround times are critical to the success of your organization. A rugged instrument that provides day-in, day-out performance is a cornerstone to your workflow.

The Varian 325-MS is a robust, reliable option for many applications, including: environmental, food safety, clinical research and forensics. Designed to handle difficult small molecule analyses, it offers a choice of ionization modes and scanning techniques to ensure you obtain the information you are looking for.

The Varian 325-MS innovative technologies facilitate increased productivity in a high throughput environment.

It features Varian's patent pending vESI™ ion source, a vortex API, and patent pending Gold Guard™ ion optics that jointly enhance sensitivity, ruggedness and throughput. The higher sensitivity means you can analyze more compounds in a single run. The more rugged design means less downtime for cleaning the source. That adds up to an extremely productive solution.

The Varian 325-MS Provides:

- Accurate and reproducible results in difficult matrices
- Highest sensitivity among comparable triple quadrupole instruments
- Easy-to-use vESI interface
- Increased number of target analytes possible in multi-residue methods
- Reduced need for front-end maintenance

For more than 40 years, Varian has provided high quality instrumentation to the scientific community. We are committed to providing high performance and reliable analytical instruments. Our main objectives are to satisfy your current needs and future workflow requirements.

Tap into Varian's expertise throughout the lifetime of your instrument. Our network of expert engineers and application specialists are ready to assist you from system installation to method development, all geared towards improving your productivity and lowering your overall cost of ownership.

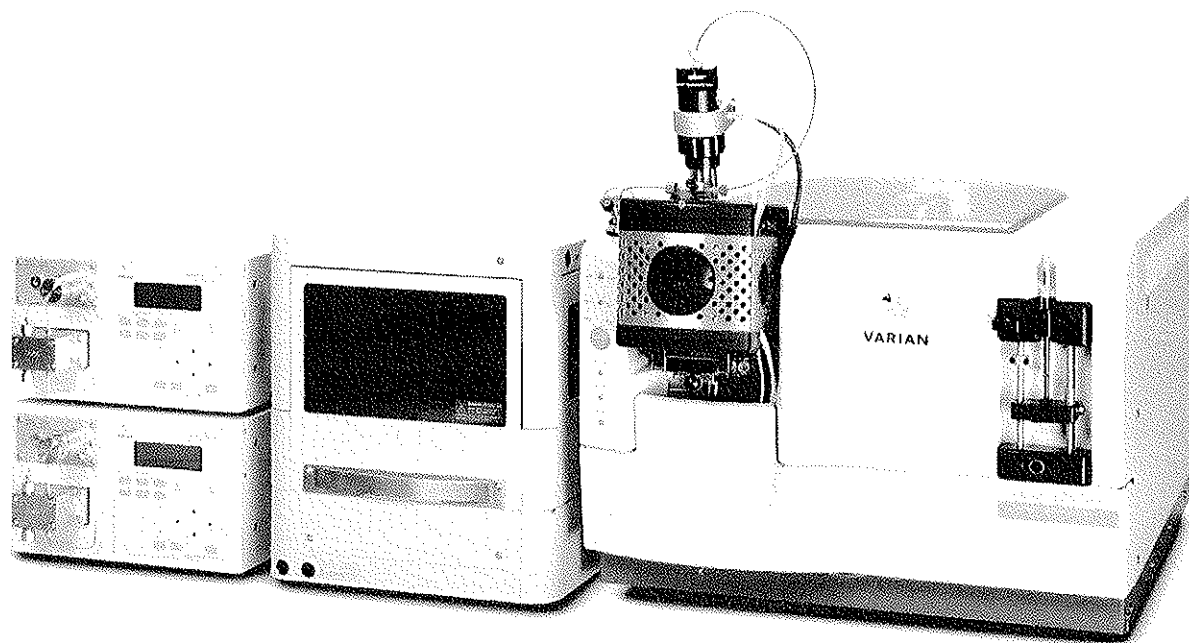

The standard configuration contains: 325-MS with vESI interface, 212-IC pumps and choice of autosampler (shown here with the 460-IC autosampler).

Redefining Benchtop LC/MS/MS Performance

Features of the 325-MS

vESI™ Ion Source

The patent pending vESI ion source employs a novel vortex mechanism for improved heat transfer and greater desolvation efficiency of sample droplets. More ions and less matrix are transferred into the mass spectrometer, increasing sensitivity and reducing contamination.

Gold Guard™ Ion Optics

The most robust ion optics system currently available, Gold Guard is engineered to withstand repeated analyses in complex matrices without a loss of signal, resulting in less maintenance and greater uptime.

Skimmer Cone and Q0 Assemblies

The redesigned skimmer cone and ion guide increase ion sampling and transmission efficiency, resulting in improved gas conductance, lower ion guide pressure and increased signal.

180° Collision Cell

A 180° lens-less assembly with square geometry reduces nodding and increases ion transmission for enhanced sensitivity. A long collision cell path length provides for a wide CID energy range. The geometry of the assembly removes the line-of-sight path to the detector for neutrals, photons and meta-stable ions, reducing noise.

On-Axis Detector

An on-axis detector (with respect to Q3) at ± 5 kV avoids poor sensitivity for negative ions and inherent noise in conversion dynode systems.

Dual-Stage Turbomolecular Pump

The single pump design efficiently evacuates the source and analyzer regions for simplicity and lower cost. The Varian-designed and manufactured pump allows for high foreline tolerances and sustainable throughput with lower operating temperatures.

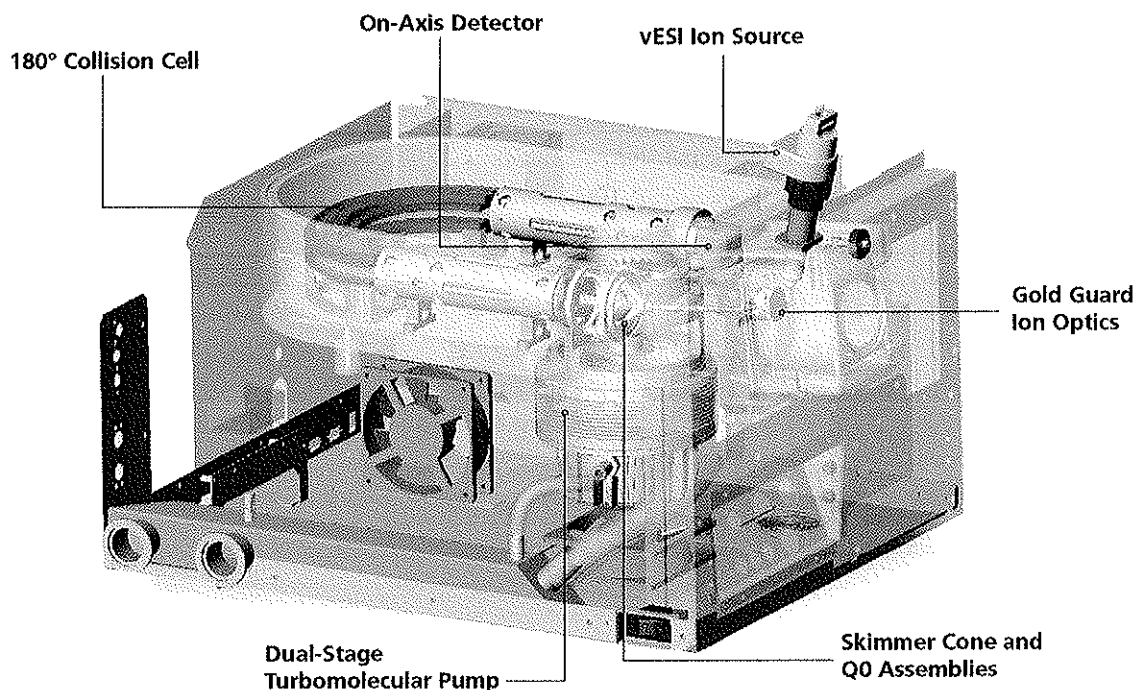

vESI™ Ion Source: Increased Sensitivity

Novel API Design Features a Highly Efficient Vortex Electropray Ionization (vESI) Interface

The vESI source for the 325-MS system maximizes ionization efficiency by application of a heated auxiliary gas rotating with respect to the nebulizing gas flow; it is used to accelerate evaporation of the liquid droplets. The droplet stream, nebulizing gas and circular gas form a vortex, which enhances heat exchange between liquid droplets and hot gas. The increased ion yield in the gas phase equates to greater sensitivity (10x) and reduced noise.

The vESI source provides greater efficiency in ionization over a wide range of liquid flow rates and mobile phase combinations routinely used in food safety, forensic, toxicology, environmental and drug discovery applications.

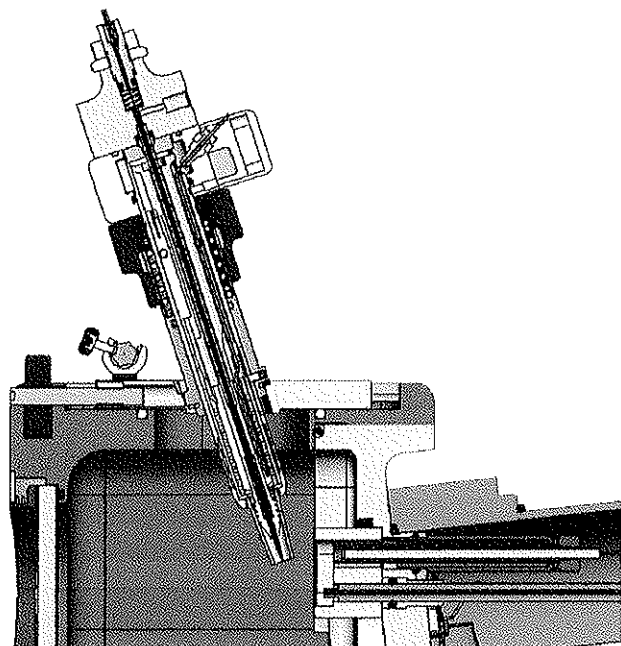

The vESI source delivers improved heat transfer and desolvation of sample droplets, over a wide range of mobile phase flow rates and compositions. More ions are transferred into the mass spectrometer, increasing sensitivity and reducing noise.

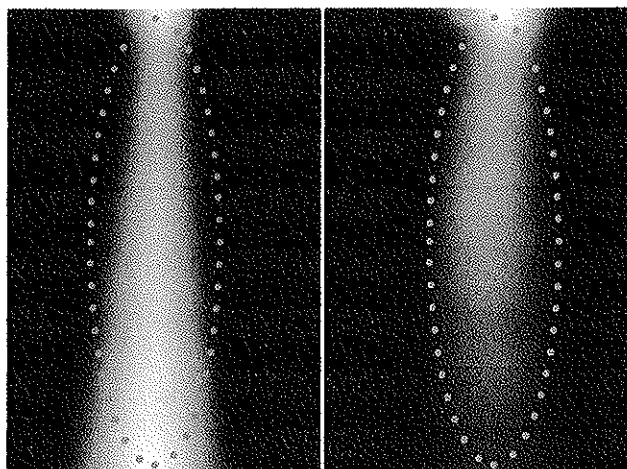

vESI gas off

vESI gas on

Photos of light scattered by liquid droplets within the vESI ion source with the vortex gas off (left) and on (right). With the vortex gas on, less light is scattered due to faster evaporation, demonstrating greater desolvation efficiency. This leads to increased sensitivity.

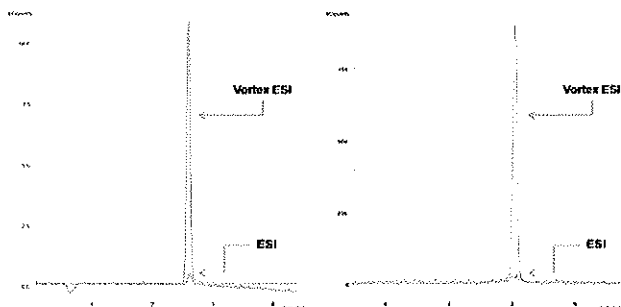

Caffeine and carbamazepine were separated on-column using a gradient elution. Representative chromatograms of caffeine and carbamazepine show improvement with the vESI source, when compared to standard ESI operation. Conditions used for both methods were fully optimized.

Gold Guard™ Ion Optics: Ultimate Resistance Against Contamination

Effectively Limit Front-End Contamination

The patent pending Gold Guard ion optics provide enhanced contamination resistance when analyzing compounds, particularly those derived from complex matrices. After repeated injections of analytes suspended in a complex matrix, the 325-MS requires little-to-no cleaning to maintain a high level of reproducibility and accuracy. The resistance against contamination provided by the Gold Guard ion optics means that downtime for cleaning and servicing the API interface and front-end ion optics is greatly reduced.

As a test of system robustness, a carrot mixture was extracted using the QuEChERS approach, without any cleanup. Flow injections of chlorpheniramine were made directly into the vESI™ source with no observable changes in signal intensity or precision of the measurements. After the injections were complete, the spray shield was noticeably fouled but the contamination did not affect instrument performance, due to the protection provided by the Gold Guard ion optics.

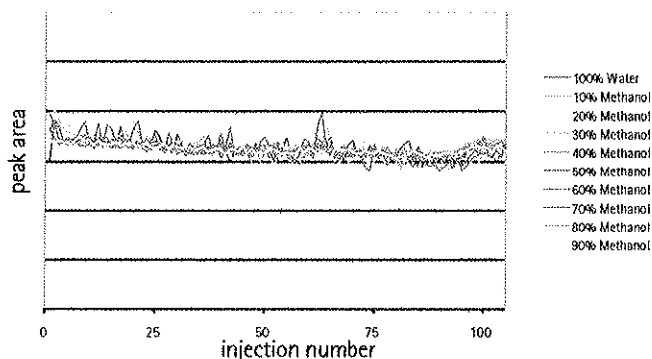

1,050 total flow injections (105 injections at each of 10 mobile phase conditions) of chlorpheniramine in a QuEChERS carrot extract, RSD=5.31%. The data were collected with a gradient method that performed 10 flow-injection events (evenly spaced) that progressed from 100% water to 100% methanol.

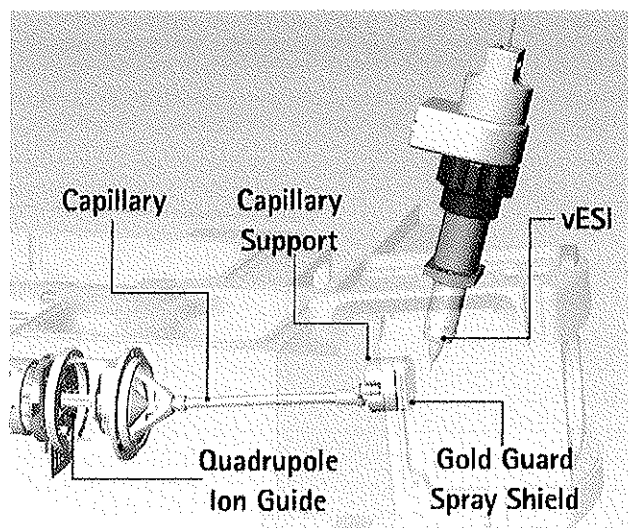

The Gold Guard and patented off-axis angle of the capillary combine to reduce noise and matrix contamination.

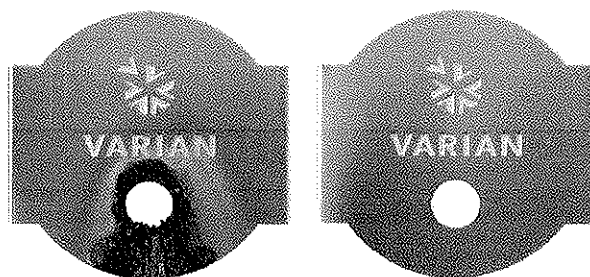

The complex, dirty matrix that accumulates on the spray shield (left) is easily removed. Cleaning the Gold Guard with a moist wipe restores the chemically resistant shield to its original condition (right).

Ease of Use

Increase Productivity

The Varian 325-MS system provides cost-effective, rapid and confident sample analysis for a variety of analytical applications. The easy-to-use vESI ion source requires practically no user intervention or optimization, facilitating data acquisition over a wide range of flow rates with no flow split. Furthermore, the vESI ion source delivers unprecedented robustness for demanding analytical applications, while maintaining a high level of reproducibility and accuracy.

One of the major problems faced by ESI is rapidly delivering thermal energy into liquid droplets in order to quickly desolvate the solvent-solute clusters. The problem is exacerbated with higher liquid flows and/or higher fractions of hydrophilic solvents. The graph below represents flow injections of rhodamine 6G, ephedrine, chlorpheniramine, phenylpropanolamine and creatinine at a linear velocity of 400 $\mu\text{L}/\text{min}$ in 75% H_2O : 25% acetonitrile, while adjusting the vESI gas temperature. Even at a flow rate of 400 $\mu\text{L}/\text{min}$ in predominantly aqueous solvent, the analyte signal intensity continues to maintain a steady response, representing a broad optimization range.

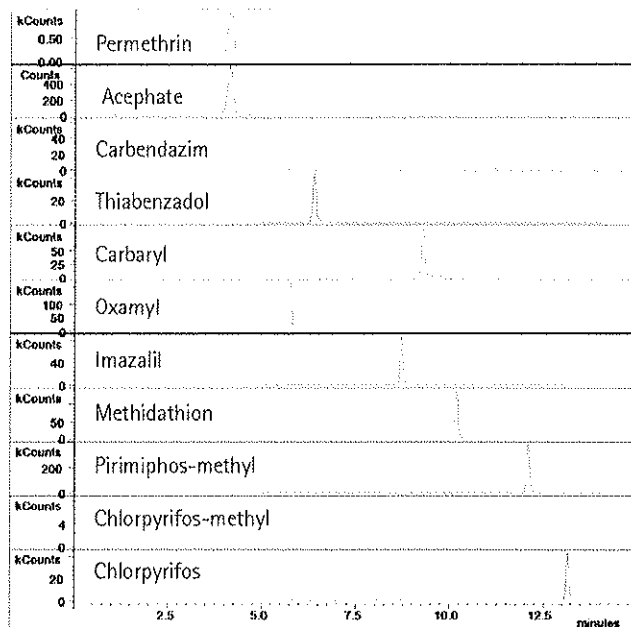
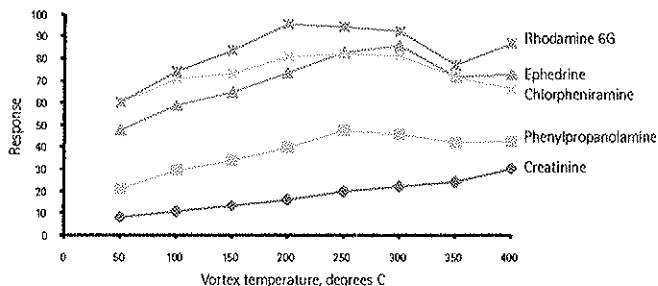

Methods can be developed to allow one set of vESI source conditions to be used throughout a method. The MRM chromatograms above depict the detection of 11 compounds in a 15-minute run. The method contains over 25 MRM transitions containing both positive and negative ions, but only one set of vESI conditions for this diverse compound set. For very labile compounds or unusually large changes in mobile phase composition, the temperature can be adjusted if needed. The 325-MS is equipped with SelectTemp™ control, which affords changing the drying gas and vESI gas temperatures throughout an analytical run.

Setup, Acquire, Analyze and Report

The Complete Solution...

The vast majority of mass spectrometry-based methods require various forms of sample preparation and chromatographic techniques prior to mass analysis. Varian can offer this exact blend of sample preparation, chromatography systems, HPLC columns, software and support required to meet the rigorous needs of your application.

MS Workstation Software

Instrument control and data processing are simple with Varian MS Workstation software.

- Complete single-point control of pumps, autosamplers and other accessories
- Fully automated tuning and calibration
- Superior data transfer rate with dual processors
- Simple navigation for reviewing and processing result
- Full featured network compatibility for file management, printing and remote access
- Extensive reporting for complete analyses
- Automated MS/MS optimization

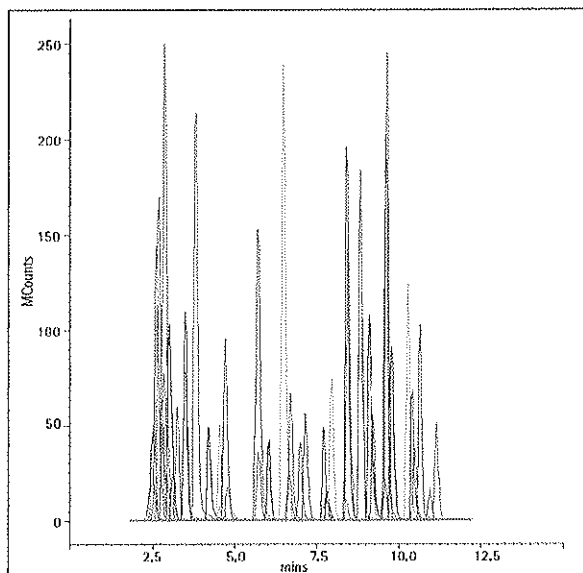

Varian 325-MS LC/MS with SRM transitions offers high quality quantification with more than 10 data points per peak and an analysis of 48 pesticides in less than 11 minutes.

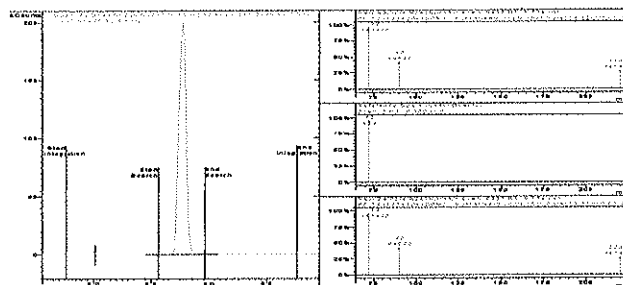

HPLC Pumps

212-LC pumps deliver pulse-free flow at low flow rates, ideal for analyzing limited amounts of sample on a small (2 mm) diameter column. The low flow rates reduce maintenance on the spectrometer and increase the sensitivity for analyses of small samples.

Autosamplers

HTS PAL™ is a low loss, high speed, high capacity, robust autosampler offering outstanding flexibility and productivity.

The 460-LC handles well plates and sample vials, open or sealed. Internal standard addition, sample dilution or derivatization steps are easily programmed to reduce sample preparation time and errors associated with manual procedures.

HPLC Columns

Pursuit™ columns are available in a variety of phases and deliver faster separations without sacrificing resolution. Pursuit Diphenyl offers unique pi-pi selectivity for aromatic and double bond containing analytes and improved LC/MS sensitivity. Pursuit PFP delivers optimal separation of polar analytes under high aqueous conditions.

Polaris™ columns provide unique bonded phases that maximize polar retention and selectivity, while virtually eliminating silanol activity. Polar-modified chemistries of this class are very effective for separations that are difficult on conventional alkyl-bonded phases, and they are stable in all commonly used HPLC and LC/MS eluents from pH 1.5 to 10.0.

Varian 325-MS

TRIPLE QUADRUPOLE MASS SPECTROMETER

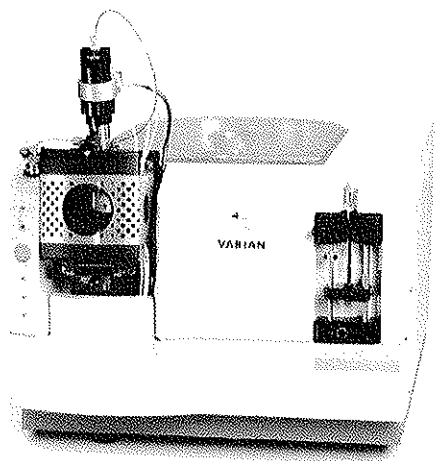

The Varian 325-MS is a rugged, reliable option for many applications. It features a "vortex" electrospray interface (vESI™) and Gold Guard™ ion optics that jointly enhance sensitivity, ruggedness and throughput.

The higher sensitivity means you can analyze more compounds in a single run. The more rugged design means less downtime spent cleaning the source. It all adds up to an extremely productive solution.

Triple-Stage Quadrupole

- Dual-quadrupole mass filters, with pre- and post-filters (ion guides)
- 180°, lensless collision-cell system with square geometry improves ion transmission and reduces nodding for increased sensitivity
- Mass range: 10–2000 m/z
- Mass resolution: unit mass (0.7 amu, fwhm) over the entire mass range
- Mass axis stability: ± 0.1 amu over 24 hours
- Scan rates: up to 6000 amu/sec
- Adjustable dwell times: 2–14,000 ms (software defined per transition)
- Software control and automated optimization of collision energy and gas pressure
- Automated algorithms for system calibration, tuning, and compound optimization
- Collision gas: greater than 99% argon at 20 psi

API Interfaces

- Spray chamber temperature: up to 65° C
- Quadrupole ion guide: off-axis (6°) with respect to capillary guide
- Capillary voltage: up to 300 V (compound dependent)
- Nebulizing/drying/vortex gases: require 99% N_2 at 80 psi with < 0.1 ppm of hydrocarbons and < 1% of O_2 ; also requires clean, dry air at 80 psi with < 0.1 ppm of hydrocarbon for negative ionization mode

• Vortex Electrospray (vESI)

- LC flows: 50 to 2000 $\mu L/min$
- vESI voltage: 500 V to 6 kV
- Spray shield: up to 800 V
- vESI probe position: y-z positioning and independent adjustment of the vESI needle
- Maximum drying and vortex gas consumption: 10 L/min each
- Maximum drying and vortex gas temperatures: 400° C each

• Atmospheric Chemical Ionization (APCI)

- LC flows: 100 to 2000 $\mu L/min$
- APCI current: up to 15 μA
- Spray shield: up to 800 V
- APCI probe position: y positioning and independent adjustment of the corona discharge needle
- Maximum drying and auxiliary gas consumption: 10 L/min and 5 L/min
- Maximum drying and auxiliary gas temperatures: 400° C and 550° C

Vacuum System

- Superior two-stage turbomolecular pump for API and analyzer regions, 310/400 L/sec, air-cooled; MacroTorr™ stages at exit for higher foreline pressures
- Foreline pumps: (2) Varian MS40+ pumps with integrated oil mist eliminator and oil return kit; 3-phase motor with low startup current (<10 A) does not require a special breaker or 3-phase AC mains supply



VARIAN