



**CARL BELT, INC.**

*General Contractors*

11521 Milnor Avenue P.O. Box 1210 Cumberland, MD 21501-1210

**F A X T R A N S M I S S I O N**

**Date:** February 16, 2011

**To:** Department of Administration  
Purchasing Division  
(304) 558-3970

**From:** Kistion Mauzy

**Number of Pages:** Twenty-Three -(23)

**SEALED BID**

**Buyer:** Sherri Slone -- File 33

**Req. No.:** 05110326

**Bid Opening Date:** 02/16/2011

**Bid Opening Time:** 1:30 P.M.

RECEIVED  
 2011 FEB 16 P 1:03  
 PURCHASING DIVISION  
 STATE OF WV

If there are any problems with this transmission, please call immediately!

**Fax Number: (301) 729-0163 ♦ Phone Number: (301) 729-8900**



State of West Virginia  
 Department of Administration  
 Purchasing Division  
 2019 Washington Street East  
 Post Office Box 50130  
 Charleston, WV 25305-0130

**Request for Quotation**

RFQ NUMBER  
 05110326

PAGE  
 1

ADDRESS CORRESPONDENCE TO ATTENTION OF  
 BUYER 33  
 304-558-2402

RFQ COPY  
 TYPE NAME/ADDRESS HERE

VENDOR  
 Carl Belt, Inc.  
 P.O. Box 1210  
 Cumberland, MD 21501-1210

SHIPTO  
 DIVISION OF HIGHWAYS  
 DISTRICT FIVE

RT US 50, P.O. BOX 99  
 BURLINGTON, WV  
 26710-0099 304-289-3521

|                            |               |          |       |               |
|----------------------------|---------------|----------|-------|---------------|
| DATE PRINTED<br>01/12/2011 | TERMS OF SALE | SHIP VIA | EX.B. | FREIGHT TERMS |
|----------------------------|---------------|----------|-------|---------------|

BID OPENING DATE: 02/16/2011 BID OPENING TIME 01:30PM

| LINE   | QUANTITY | UOP | CAT NO | ITEM NUMBER | UNIT PRICE | AMOUNT |
|--|----------|-----|--------|-------------|------------|--------|
| 0001   | 1        | EA  |        | 750-30      |            |        |
| FORMS AND POUR CONCRETE WALL   |          |     |        |             |            |        |
| REQUEST FOR QUOTATION (RFQ)  |          |     |        |             |            |        |
| THE WEST VIRGINIA STATE PURCHASING DIVISION FOR THE AGENCY, THE WEST VIRGINIA DIVISION OF HIGHWAYS, IS SOLICITING BIDS FOR A CONTRACT TO PROVIDE FORMS AND POUR CONCRETE WALL PER THE ATTACHED SPECIFICATIONS.   |          |     |        |             |            |        |
| TECHNICAL QUESTIONS CONCERNING THIS SOLICITATION MUST BE SUBMITTED IN WRITING TO SHERI SLONE IN THE WEST VIRGINIA STATE PURCHASING DIVISION VIA MAIL AT THE ADDRESS SHOWN IN THE BODY OF THIS RFQ, VIA FAX AT 304-558-4115, OR VIA EMAIL AT SHERI.D.SLONE@WV.GOV. DEADLINE FOR TECHNICAL QUESTIONS IS 02/03/2011 AT THE CLOSE OF BUSINESS. ANY TECHNICAL QUESTIONS RECEIVED WILL BE ANSWERED BY FORMAL ADDENDUM TO BE ISSUED BY THE PURCHASING DIVISION AFTER THE DEADLINE HAS LAPSED. |          |     |        |             |            |        |
| VENDORS WISHING TO SCHEDULE A SITE VISIT MAY DO SO BY CONTACTING:<br>BARRY KNOTTS, MAINTENANCE ENGINEER, WVD0H AT 304-289-2208 - OFFICE PHONE, OR 304-813-2596 CELL PHONE  |          |     |        |             |            |        |
| ANY TECHNICAL QUESTIONS ARISING FROM SITE VISITS MUST BE SUBMITTED IN ACCORDANCE WITH THE PROVISIONS OF THE ORIGINAL REQUEST FOR QUOTATION NO. 05110326 AND MUST   |          |     |        |             |            |        |

SEE REVERSE SIDE FOR TERMS AND CONDITIONS

|                                    |                   |                                   |                    |
|------------------------------------|-------------------|-----------------------------------|--------------------|
| SIGNATURE<br><i>Mark A. Farris</i> | Mark A. Farris    | TELEPHONE<br>(301) 729-8900       | DATE<br>02/16/2011 |
| TITLE<br>V.P. & General Counsel    | FAX<br>52-0747947 | ADDRESS CHANGES TO BE NOTED ABOVE |                    |

WHEN RESPONDING TO RFQ, INSERT NAME AND ADDRESS IN SPACE ABOVE LABELED 'VENDOR'



State of West Virginia  
 Department of Administration  
 Purchasing Division  
 2019 Washington Street East  
 Post Office Box 50130  
 Charleston, WV 25305-0130

**Request for Quotation**

RFQ NUMBER  
 05110326

PAGE  
 2

ADDRESS CORRESPONDENCE TO ATTENTION OF  
 BUYER 33  
 304-558-2402

RFQ COPY  
 TYPE NAME/ADDRESS HERE

Carl Belt, Inc.  
 P.O. Box 1210  
 Cumberland, MD 21501-1210

DIVISION OF HIGHWAYS  
 DISTRICT FIVE

RT US 50, P.O. BOX 99  
 BURLINGTON, WV  
 26710-0099 304-289-3521

|                            |               |           |     |               |
|----------------------------|---------------|-----------|-----|---------------|
| DATE PRINTED<br>01/12/2011 | FORM OR SALES | EMERGENCY | FAX | FREIGHT TERMS |
|----------------------------|---------------|-----------|-----|---------------|

BID OPENING DATE: 02/16/2011 BID OPENING TIME 01:30PM

| LINE  | QUANTITY | UOP | CAT. NO. | ITEM NUMBER | UNIT PRICE | AMOUNT |
|---|----------|-----|----------|-------------|------------|--------|
| <p>BE WITHIN THE ALLOTTED TIMEFRAME. NO VERBAL REPRESENTATIONS SHALL BE BINDING UNTIL SUCH TIME AS IT IS ISSUED BY FORMAL WRITTEN ADDENDUM TO BE ISSUED BY THE PURCHASING DIVISION AFTER THE DEADLINE FOR TECHNICAL QUESTIONS HAS LAPSED.</p> <p>EXHIBIT 5</p> <p>WEST VIRGINIA CODE 21-ID-5 PROVIDES THAT: ANY SOLICITATION FOR A PUBLIC IMPROVEMENT CONSTRUCTION CONTRACT REQUIRES EACH VENDOR THAT SUBMITS A BID FOR THE WORK TO SUBMIT AT THE SAME TIME AN AFFIDAVIT OF COMPLIANCE WITH THE BID. THE ENCLOSED DRUG-FREE WORKPLACE AFFIDAVIT MUST BE SIGNED AND SUBMITTED WITH THE BID AS EVIDENCE OF THE VENDOR'S COMPLIANCE WITH THE PROVISIONS OF ARTICLE 1D, CHAPTER 21 OF THE WEST VIRGINIA CODE. FAILURE TO SUBMIT THE SIGNED DRUG-FREE WORKPLACE AFFIDAVIT WITH THE BID SHALL RESULT IN DISQUALIFICATION OF SUCH BID.</p> <p>NOTICE TO PROCEED: THIS CONTRACT IS TO BE PERFORMED WITHIN 120 CALENDAR DAYS AFTER THE NOTICE TO PROCEED IS RECEIVED. UNLESS OTHERWISE SPECIFIED, THE FULLY EXECUTED PURCHASE ORDER WILL BE CONSIDERED NOTICE TO PROCEED.</p> <p>CANCELLATION: THE DIRECTOR OF PURCHASING RESERVES THE RIGHT TO CANCEL THIS CONTRACT IMMEDIATELY UPON WRITTEN NOTICE TO THE VENDOR IF THE MATERIALS OR WORKMANSHIP SUPPLIED ARE OF AN INFERIOR QUALITY OR DO NOT CONFORM WITH THE SPECIFICATIONS OF THE BID AND CONTRACT HERE IN.</p> <p>WAGE RATES: THE CONTRACTOR OR SUBCONTRACTOR SHALL PAY THE HIGHER OF THE U.S. DEPARTMENT OF LABOR MINIMUM WAGE RATES AS ESTABLISHED FOR GRANT COUNTY, PURSUANT</p> |          |     |          |             |            |        |

SEE REVERSE SIDE FOR TERMS AND CONDITIONS

SIGNATURE: *Mark A. Farris* Mark A. Farris TELEPHONE: (301) 729-8900 DATE: 02/16/2011

TITLE: V.P. & General Counsel FEIN: 52-0747947 ADDRESS CHANGES TO BE NOTED ABOVE

WHEN RESPONDING TO RFQ, INSERT NAME AND ADDRESS IN SPACE ABOVE LABELED 'VENDOR'



State of West Virginia  
 Department of Administration  
 Purchasing Division  
 2019 Washington Street East  
 Post Office Box 50130  
 Charleston, WV 25306-0130

**Request for  
 Quotation**

|            |
|------------|
| RFQ NUMBER |
| 05110326   |

|      |
|------|
| PAGE |
| 3    |

|  |
|--|
| ADDRESS CORRESPONDENCE TO ATTENTION OF |
| BUYER 33<br>304-558-2402               |

VENDOR

RFQ COPY  
 TYPE NAME/ADDRESS HERE

Carl Belt, Inc.  
 P.O. Box 1210  
 Cumberland, MD 21501-1210

SHIP TO

DIVISION OF HIGHWAYS  
 DISTRICT FIVE  
 RT US 50, P.O. BOX 99  
 BURLINGTON, WV  
 26710-0099 304-289-3521

|              |               |          |        |               |
|--------------|---------------|----------|--------|---------------|
| DATE PRINTED | TERMS OF SALE | SHIP VIA | F.O.B. | FREIGHT TERMS |
| 01/12/2011   |               |          |        |               |

BID OPENING DATE: **02/16/2011** BID OPENING TIME **01:30PM**

| LINE   | QUANTITY | UOP | CAT NO | ITEM NUMBER | UNIT PRICE | AMOUNT |
|--|----------|-----|--------|-------------|------------|--------|
|  |          |     |        |             |            |        |
| TO WEST VIRGINIA CODE 21-5A, ET, SEQ. (PREVAILING WAGE RATES APPLY TO THIS PROJECT)<br><br>ARBITRATION: ANY REFERENCES MADE TO ARBITRATION OR INTEREST FOR PAYMENTS DUE (EXCEPT FOR ANY INTEREST REQUIRED BY STATE LAW) CONTAINED IN THIS CONTRACT OR IN ANY AMERICAN INSTITUTE OF ARCHITECTS DOCUMENTS PERTAINING TO THIS CONTRACT ARE HEREBY DELETED.<br><br>WORKERS' COMPENSATION: VENDOR IS REQUIRED TO PROVIDE A CERTIFICATE FROM WORKERS' COMPENSATION IF SUCCESSFUL.<br><br>ALL OF THE ITEMS CHECKED BELOW WILL BE A REQUIREMENT OF THIS CONTRACT:<br><br>(XX) INSURANCE: SUCCESSFUL VENDOR SHALL FURNISH PROOF OF COMMERCIAL GENERAL LIABILITY INSURANCE PRIOR TO ISSUANCE OF CONTRACT. UNLESS OTHERWISE SPECIFIED IN THE BID DOCUMENTS, THE MINIMUM AMOUNT OF INSURANCE COVERAGE REQUIRED IS \$250,000.<br><br>( ) BUILDERS RISK INSURANCE: SUCCESSFUL VENDOR SHALL FURNISH PROOF OF BUILDERS RISK - ALL RISK INSURANCE IN AN AMOUNT EQUAL TO 100% OF THE AMOUNT OF THE CONTRACT.<br><br>(XX) BONDS: FIVE PERCENT (5%) OF THE TOTAL AMOUNT OF THE BID PAYABLE TO THE STATE OF WEST VIRGINIA, SHALL BE SUBMITTED WITH EACH BID AS A BID BOND. THE SUCCESSFUL BIDDER SHALL ALSO FURNISH A PERFORMANCE BOND AND LABOR/MATERIAL BOND FOR 100% OF THE AMOUNT OF THE CONTRACT. BONDS MAY BE PROVIDED IN THE FORM OF A CERTIFIED CHECK, IRREVOCABLE LETTER OF CREDIT, OR BOND FURNISHED BY A SOLVENT SURETY COMPANY AUTHORIZED TO DO BUSINESS IN THE STATE OF WEST VIRGINIA. A LETTER OF CREDIT SUBMITTED IN LIEU OF A BOND WILL ONLY BE ALLOWED FOR PROJECTS UNDER \$100,000. PERSONAL OR BUSINESS CHECKS ARE NOT |          |     |        |             |            |        |

|   |                |                                   |            |
|---|----------------|-----------------------------------|------------|
| SEE REVERSE SIDE FOR TERMS AND CONDITIONS |                |                                   |            |
| SIGNATURE                                 | NAME           | TELEPHONE                         | DATE       |
| <i>Mark A. Farris</i>                     | Mark A. Farris | (301) 729-8900                    | 02/16/2011 |
| TITLE                                     | FAX            | ADDRESS CHANGES TO BE NOTED ABOVE |            |
| V.P. & General Counsel                    | 52-0747947     |                                   |            |

WHEN RESPONDING TO RFQ, INSERT NAME AND ADDRESS IN SPACE ABOVE LABELED 'VENDOR'



State of West Virginia  
 Department of Administration  
 Purchasing Division  
 2019 Washington Street East  
 Post Office Box 50130  
 Charleston, WV 25305-0130

**Request for Quotation**

|            |
|------------|
| RFO NUMBER |
| 05110326   |

|      |
|------|
| PAGE |
| 4    |

|  |
|--|
| ADDRESS CORRESPONDENCE TO ATTENTION OF |
| BUYER 33<br>304-558-2402               |

RFQ COPY  
 TYPE NAME/ADDRESS HERE

Carl Belt, Inc.  
 P.O. Box 1210  
 Cumberland, MD 21501-1210

DIVISION OF HIGHWAYS  
 DISTRICT FIVE

RT US 50, P.O. BOX 99  
 BURLINGTON, WV  
 26710-0099 304-289-3521

|              |               |          |        |               |
|--------------|---------------|----------|--------|---------------|
| DATE PRINTED | TERMS OF SALE | SHIP VIA | P.O.B. | FREIGHT TERMS |
| 01/12/2011   |               |          |        |               |

BID OPENING DATE: **02/16/2011** BID OPENING TIME **01:30PM**

| LINE   | QUANTITY | UOP | CAT NO. | ITEM NUMBER | UNIT PRICE | AMOUNT |
|--|----------|-----|---------|-------------|------------|--------|
|  |          |     |         |             |            |        |
| ACCEPTABLE IN LIEU OF THE 5% BID BOND, PERFORMANCE BOND, OR LABOR AND MATERIAL BOND.<br><br>( ) MAINTENANCE BOND: A TWO (2) YEAR MAINTENANCE BOND COVERING THE ROOFING SYSTEM WILL BE A REQUIREMENT OF THE SUCCESSFUL VENDOR.<br><br>REV. 11/00<br><br>EXHIBIT 7<br><br>DOMESTIC ALUMINUM, GLASS & STEEL IN PUBLIC WORKS PROJECTS<br><br>IN ACCORDANCE WITH WEST VIRGINIA CODE 5-19-1 ET., SEQ., EVERY CONTRACT FOR CONSTRUCTION, RECONSTRUCTION, ALTERATION, REPAIR, IMPROVEMENT OR MAINTENANCE OF PUBLIC WORKS, WHERE THE COST IS MORE THAN \$50,000 AND, IN THE CASE OF STEEL ONLY, WHERE THE COST OF STEEL IS MORE THAN \$50,000 OR WHERE MORE THAN 10,000 POUNDS OF STEEL ARE REQUIRED, THE STATE WILL ACCEPT ONLY ALUMINUM GLASS, OR STEEL PRODUCTS PRODUCED IN THE UNITED STATES. IN ADDITION, ITEMS OF MACHINERY OR EQUIPMENT PURCHASED FOR USE AT THE SITE OF PUBLIC WORKS SHALL BE MADE OF DOMESTIC ALUMINUM, GLASS OR STEEL, UNLESS THE COST OF THE PRODUCT IS LESS THAN \$50,000 OR LESS THAN 10,000 POUNDS OF STEEL ARE USED IN PUBLIC WORKS PROJECTS.<br><br>FOREIGN MADE ALUMINUM, GLASS OR STEEL PRODUCTS MAY BE ACCEPTED ONLY IF THE COST OF DOMESTIC PRODUCTS IS FOUND TO BE UNREASONABLE. SUCH COST IS UNREASONABLE IF IT IS 20% OR MORE HIGHER THAN THE BID PRICE FOR FOREIGN MADE PRODUCTS. IF THE DOMESTIC ALUMINUM, GLASS OR STEEL PRODUCTS TO BE SUPPLIED OR PRODUCED IN A "SUBSTANTIAL LABOR SURPLUS AREA", AS DEFINED BY THE UNITED STATES |          |     |         |             |            |        |

|   |                |                                   |            |
|---|----------------|-----------------------------------|------------|
| SEE REVERSE SIDE FOR TERMS AND CONDITIONS |                |                                   |            |
| SIGNATURE                                 | MARK A. FARRIS | TELEPHONE                         | DATE       |
| <i>Mark A. Farris</i>                     | Mark A. Farris | (301) 729-8900                    | 02/16/2011 |
| TITLE                                     | FEIN           | ADDRESS CHANGES TO BE NOTED ABOVE |            |
| V.P. & General Counsel                    | 52-0747947     |                                   |            |

WHEN RESPONDING TO RFQ, INSERT NAME AND ADDRESS IN SPACE ABOVE LABELED 'VENDOR'



State of West Virginia  
 Department of Administration  
 Purchasing Division  
 2019 Washington Street East  
 Post Office Box 50130  
 Charleston, WV 25305-0130

### Request for Quotation

RFQ NUMBER  
 05110326

PAGE  
 5

ADDRESS CORRESPONDENCE TO ATTENTION OF  
 BUYER 33  
 304-558-2402

RFQ COPY  
 TYPE NAME/ADDRESS HERE

Carl Belt, Inc.  
 P.O. Box 1210  
 Cumberland, MD 21501-1210

DIVISION OF HIGHWAYS  
 DISTRICT FIVE

RT US 50, P.O. BOX 99  
 BURLINGTON, WV  
 26710-0099 304-289-3521

|                            |               |          |     |               |
|----------------------------|---------------|----------|-----|---------------|
| DATE PRINTED<br>01/12/2011 | TERMS OF SALE | SHIP VIA | FOB | FREIGHT TERMS |
|----------------------------|---------------|----------|-----|---------------|

BID OPENING DATE: 02/16/2011 BID OPENING TIME 01:30PM

| LINE   | QUANTITY | UOP | CAT NO | ITEM NUMBER | UNIT PRICE | AMOUNT |
|--|----------|-----|--------|-------------|------------|--------|
| <p>DEPARTMENT OF LABOR, FOREIGN PRODUCTS MAY BE SUPPLIED ONLY IF DOMESTIC PRODUCTS ARE 30% OR MORE HIGHER IN PRICE THAN THE FOREIGN MADE PRODUCTS.</p> <p>IF, PRIOR TO THE AWARD OF A CONTRACT UNDER THE ABOVE PROVISIONS, THE SPENDING OFFICER OF THE SPENDING UNIT DETERMINES THAT THERE EXISTS A BID FOR LIKE FOREIGN ALUMINUM, GLASS OR STEEL THAT IS REASONABLE AND LOWER THAN THE LOWEST BID DOMESTIC PRODUCTS, THE SPENDING OFFICE MAY REQUEST, IN WRITING, A REEVALUATION AND REDUCTION IN THE LOWEST BID FOR SUCH DOMESTIC PRODUCTS. ALL VENDORS MUST INDICATE IN THEIR BID IF THEY ARE SUPPLYING FOREIGN ALUMINUM, GLASS OR STEEL.</p> <p>REV. 3/88</p> <p>EXHIBIT 9</p> <p>NOTICE FOR ISSUANCE &amp; ACKNOWLEDGEMENT OF CONSTRUCTION PROJECT ADDENDA</p> <p>THE ARCHITECT/ENGINEER AND/OR AGENCY SHALL BE REQUIRED TO ABIDE BY THE FOLLOWING SCHEDULE IN ISSUING CONSTRUCTION PROJECT ADDENDA FOR STATE AGENCIES:</p> <p>(1) THE ARCHITECT/ENGINEER SHALL PREPARE THE ADDENDUM AND A LIST OF ALL PARTIES THAT HAVE PROCURED DRAWINGS AND SPECIFICATIONS FOR THE PROJECT. THE ADDENDUM AND LIST SHALL BE FORWARDED TO THE BUYER IN THE STATE PURCHASING DIVISION. THE ARCHITECT/ENGINEER SHALL ALSO SEND A COPY OF THE ADDENDUM TO THE STATE AGENCY FOR WHICH THE CONTRACT IS ISSUED.</p> <p>(2) THE BUYER SHALL SEND THE ADDENDUM TO ALL INTERESTED PARTIES AND, IF NECESSARY, EXTEND THE BID</p> |          |     |        |             |            |        |

SEE REVERSE SIDE FOR TERMS AND CONDITIONS

SIGNATURE *Mark A. Farris* Mark A. Farris TELEPHONE (301) 729-8900 DATE 02/16/2011

TITLE V.P. & General Counsel FEIN 52-0747947 ADDRESS CHANGES TO BE NOTED ABOVE

WHEN RESPONDING TO RFQ, INSERT NAME AND ADDRESS IN SPACE ABOVE LABELED 'VENDOR'



State of West Virginia  
 Department of Administration  
 Purchasing Division  
 2019 Washington Street East  
 Post Office Box 50130  
 Charleston, WV 25305-0130

### Request for Quotation

RFQ NUMBER  
 05110326

PAGE  
 6

ADDRESS CORRESPONDENCE TO ATTENTION OF:  
 BUYER 33  
 304-558-2402

RFQ COPY  
 TYPE NAME/ADDRESS HERE

Carl Belt, Inc.  
 P.O. Box 1210  
 Cumberland, MD 21501-1210

DIVISION OF HIGHWAYS  
 DISTRICT FIVE

RT US 50, P.O. BOX 99  
 BURLINGTON, WV  
 26710-0099 304-289-3521

|              |               |          |        |               |
|--------------|---------------|----------|--------|---------------|
| DATE PRINTED | TERMS OF SALE | SHIP VIA | F.O.B. | FREIGHT TERMS |
| 01/12/2011   |               |          |        |               |

BID OPENING DATE: 02/16/2011 BID OPENING TIME 01:30PM

| LINE   | QUANTITY | UOP | CAT NO | ITEM NUMBER | UNIT PRICE | AMOUNT |
|--|----------|-----|--------|-------------|------------|--------|
| <p>OPENING DATE. ANY ADDENDUM SHOULD BE RECEIVED BY THE BUYER WITHIN FOURTEEN (14) DAYS PRIOR TO THE BID OPENING DATE.</p> <p>(3) ALL ADDENDA SHOULD BE FORMALLY ACKNOWLEDGED BY ALL BIDDERS AND SUBMITTED TO THE STATE PURCHASING DIVISION. THE SAME RULES AND REGULATIONS THAT APPLY TO THE ORIGINAL BIDDING DOCUMENT SHALL ALSO APPLY TO AN ADDENDUM DOCUMENT. THE ONLY EXCEPTION MAY BE FOR AN ADDENDUM THAT IS ISSUED FOR THE SOLE PURPOSE OF CHANGING A BID OPENING TIME AND/OR DATE.</p> <p>REV. 11/96</p> <p>EXHIBIT 10</p> <p>ADDENDUM ACKNOWLEDGEMENT</p> <p>I HEREBY ACKNOWLEDGE RECEIPT OF THE FOLLOWING CHECKED ADDENDUM(S) AND HAVE MADE THE NECESSARY REVISIONS TO MY PROPOSAL, PLANS AND/OR SPECIFICATION, ETC.</p> <p>ADDENDUM NOS.:</p> <p>NO. 1 .....</p> <p>NO. 2 .....</p> <p>NO. 3 .....</p> <p>NO. 4 .....</p> <p>NO. 5 .....</p> |          |     |        |             |            |        |

|   |                 |                                   |                 |
|---|-----------------|-----------------------------------|-----------------|
| SEE REVERSE SIDE FOR TERMS AND CONDITIONS |                 |                                   |                 |
| SIGNATURE <i>Mark A. Farris</i>           | Mark A. Farris  | TELEPHONE (301) 729-8900          | DATE 02/16/2011 |
| TITLE V.P. & General Counsel              | FEIN 52-0747947 | ADDRESS CHANGES TO BE NOTED ABOVE |                 |

WHEN RESPONDING TO RFQ, INSERT NAME AND ADDRESS IN SPACE ABOVE LABELED 'VENDOR'



State of West Virginia  
Department of Administration  
Purchasing Division  
2019 Washington Street East  
Post Office Box 50130  
Charleston, WV 25305-0130

# Request for Quotation

RFQ NUMBER  
05110326

PAGE  
7

ADDRESS CORRESPONDENCE TO ATTENTION OF  
BUYER 33  
304-558-2402

RFQ COPY  
TYPE NAME/ADDRESS HERE

Carl Belt, Inc.  
P.O. Box 1210  
Cumberland, MD 21501-1210

DIVISION OF HIGHWAYS  
DISTRICT FIVE  
RT US 50, P.O. BOX 99  
BURLINGTON, WV  
26710-0099 304-289-3521

| DATE PRINTED | TERMS OF SALE | SHIP VIA | F.O.B. | PREIGHT TERMS |
|--------------|---------------|----------|--------|---------------|
| 01/12/2011   |               |          |        |               |

BID OPENING DATE: 02/16/2011 BID OPENING TIME 01:30PM

| LINE   | QUANTITY | UOP | CAT NO | ITEM NUMBER | UNIT PRICE | AMOUNT |
|--|----------|-----|--------|-------------|------------|--------|
| <p>I UNDERSTAND THAT FAILURE TO CONFIRM THE RECEIPT OF THE ADDENDUM(S) MAY BE CAUSE FOR REJECTION OF THE BIDS.</p> <p>VENDOR MUST CLEARLY UNDERSTAND THAT ANY VERBAL REPRESENTATION MADE OR ASSUMED TO BE MADE DURING ANY ORAL DISCUSSION HELD BETWEEN VENDOR'S REPRESENTATIVES AND ANY STATE PERSONNEL IS NOT BINDING. ONLY THE INFORMATION ISSUED IN WRITING AND ADDED TO THE SPECIFICATIONS BY AN OFFICIAL ADDENDUM IS BINDING.</p> <p>.....<br/> <i>Mark A. Farris</i>.....SIGNATURE<br/>           Carl Belt, Inc.....COMPANY<br/>           February 16, 2011.....DATE</p> <p>REV. 11/96</p> <p>CONTRACTORS LICENSE</p> <p>WEST VIRGINIA STATE CODE 21-11-2 REQUIRES THAT ALL PERSONS DESIRING TO PERFORM CONTRACTING WORK IN THIS STATE MUST BE LICENSED. THE WEST VIRGINIA CONTRACTORS LICENSING BOARD IS EMPOWERED TO ISSUE THE CONTRACTORS LICENSE. APPLICATIONS FOR A CONTRACTORS LICENSE MAY BE MADE BY CONTACTING THE WEST VIRGINIA DIVISION OF LABOR CAPITOL COMPLEX, BUILDING 3, ROOM 319, CHARLESTON, WV 25305. TELEPHONE: (304) 558-7890.</p> <p>WEST VIRGINIA STATE CODE 21-11-11 REQUIRES ANY PROSPECTIVE BIDDER TO INCLUDE THE CONTRACTORS LICENSE NUMBER ON THEIR BID.</p> <p>BIDDER TO COMPLETE:</p> |          |     |        |             |            |        |

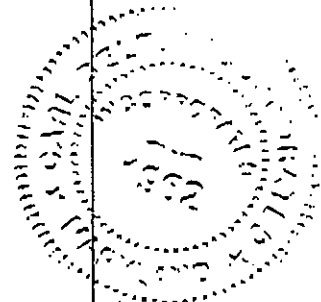

|   |                        |                                   |                    |
|---|------------------------|-----------------------------------|--------------------|
| SEE REVERSE SIDE FOR TERMS AND CONDITIONS |                        |                                   |                    |
| SIGNATURE<br><i>Mark A. Farris</i>        | NAME<br>Mark A. Farris | TELEPHONE<br>(301) 729-8900       | DATE<br>02/16/2011 |
| TITLE<br>V.P. & General Counsel           | FEIN<br>52-0747947     | ADDRESS CHANGES TO BE NOTED ABOVE |                    |

WHEN RESPONDING TO RFQ, INSERT NAME AND ADDRESS IN SPACE ABOVE LABELED 'VENDOR'





State of West Virginia  
 Department of Administration  
 Purchasing Division  
 2019 Washington Street East  
 Post Office Box 50130  
 Charleston, WV 25305-0130

### Request for Quotation

RFQ NUMBER  
 05110326

PAGE  
 8

ADDRESS CORRESPONDENCE TO ATTENTION OF  
 BUYER 33  
 304-558-2402

RFQ COPY  
 TYPE NAME/ADDRESS HERE

Carl Belt, Inc.  
 P.O. Box 1210  
 Cumberland, MD 21501-1210

DIVISION OF HIGHWAYS  
 DISTRICT FIVE  
 RT US 50, P.O. BOX 99  
 BURLINGTON, WV  
 26710-0099 304-289-3521

|                            |               |          |     |               |
|----------------------------|---------------|----------|-----|---------------|
| DATE PRINTED<br>01/12/2011 | TERMS OF SALE | SHIP VIA | FOB | FREIGHT TERMS |
|----------------------------|---------------|----------|-----|---------------|

BID OPENING DATE: 02/16/2011 BID OPENING TIME 01:30PM

| LINE   | QUANTITY | UOP | CAT. NO. | ITEM NUMBER | UNIT PRICE | AMOUNT |
|--|----------|-----|----------|-------------|------------|--------|
| <p>CONTRACTORS NAME: Carl Belt, Inc.</p> <p>CONTRACTORS LICENSE NO.: WV000355</p> <p>THE SUCCESSFUL BIDDER WILL BE REQUIRED TO FURNISH A COPY OF THEIR CONTRACTORS LICENSE PRIOR TO ISSUANCE OF A PURCHASE ORDER/CONTRACT</p> <p>APPLICABLE LAW</p> <p>THE WEST VIRGINIA STATE CODE, PURCHASING DIVISION RULE AND REGULATIONS, AND THE INFORMATION PROVIDED IN THE "REQUEST FOR QUOTATION" ISSUED BY THE PURCHASING DIVISION IS THE SOLE AUTHORITY GOVERNING THIS PROCUREMENT.</p> <p>ANY INFORMATION PROVIDED IN SPECIFICATION MANUALS, OR ANY OTHER SOURCE, VERBAL OR WRITTEN, WHICH CONTRADICTS OR ALTERS THE INFORMATION PROVIDED FROM THE SOURCES AS DESCRIBED IN THE ABOVE PARAGRAPH IS VOID AND OF NO EFFECT.</p> <p>BANKRUPTCY: IN THE EVENT THE VENDOR/CONTRACTOR FILES FOR BANKRUPTCY PROTECTION, THE STATE MAY DEEM THE CONTRACT NULL AND VOID, AND TERMINATE SUCH CONTRACT WITHOUT FURTHER ORDER.</p> <p>REV. 5/2009</p> <p>NOTICE</p> <p>A SIGNED BID MUST BE SUBMITTED TO:<br/>                 DEPARTMENT OF ADMINISTRATION</p> |          |     |          |             |            |        |

|   |                    |                                   |                    |
|---|--------------------|-----------------------------------|--------------------|
| SEE REVERSE SIDE FOR TERMS AND CONDITIONS |                    |                                   |                    |
| SIGNATURE<br><i>Mark A. Farris</i>        | Mark A. Farris     | TELEPHONE<br>(301) 729-8900       | DATE<br>02/16/2011 |
| TITLE<br>V.P. & General Counsel           | FEIN<br>52-0747947 | ADDRESS CHANGES TO BE NOTED ABOVE |                    |

WHEN RESPONDING TO RFQ, INSERT NAME AND ADDRESS IN SPACE ABOVE LABELED 'VENDOR'



State of West Virginia  
 Department of Administration  
 Purchasing Division  
 2019 Washington Street East  
 Post Office Box 50130  
 Charleston, WV 25305-0130

# Request for Quotation

RFQ NUMBER  
**05110326**

PAGE  
**9**

ADDRESS CORRESPONDENCE TO ATTENTION OF  
**BUYER 33**  
**304-558-2402**

RFQ COPY  
 TYPE NAME/ADDRESS HERE

Carl Belt, Inc.  
 P.O. Box 1210  
 Cumberland, MD 21501-1210

DIVISION OF HIGHWAYS  
 DISTRICT FIVE  
 RT US 50, P.O. BOX 99  
 BURLINGTON, WV  
 26710-0099 304-289-3521

|                                   |               |          |     |               |
|-----------------------------------|---------------|----------|-----|---------------|
| DATE PRINTED<br><b>01/12/2011</b> | TERMS OF SALE | SHIP VIA | FOB | FREIGHT TERMS |
|-----------------------------------|---------------|----------|-----|---------------|

BID OPENING DATE: **02/16/2011** BID OPENING TIME **01:30PM**

| LINE   | QUANTITY | UOP | CAT NO. | ITEM NUMBER | UNIT PRICE | AMOUNT |
|--|----------|-----|---------|-------------|------------|--------|
| PURCHASING DIVISION<br>BUILDING 15<br>2019 WASHINGTON STREET, EAST<br>CHARLESTON, WV 25305-0130  |          |     |         |             |            |        |
| THE BID SHOULD CONTAIN THIS INFORMATION ON THE FACE OF THE ENVELOPE OR THE BID MAY NOT BE CONSIDERED:<br>SEALED BID<br>BUYER: SHERI SLONE - FILE 33<br>REQ. NO.: 05110326<br>BID OPENING DATE: 02/16/2011<br>BID OPENING TIME: 1:30 PM<br>PLEASE PROVIDE A FAX NUMBER IN CASE IT IS NECESSARY TO CONTACT YOU REGARDING YOUR BID:<br>(301) 729-0163 |          |     |         |             |            |        |
| PLEASE PRINT OR TYPE NAME OF PERSON TO CONTACT CONCERNING THIS QUOTE:<br>Jeremy Irons  |          |     |         |             |            |        |

SEE REVERSE SIDE FOR TERMS AND CONDITIONS

SIGNATURE *Mark A. Farris* Mark A. Farris TELEPHONE (301) 729-8900 DATE 02/16/2011

TITLE V.P. & General Counsel FEIN 52-0747947 ADDRESS CHANGES TO BE NOTED ABOVE

WHEN RESPONDING TO RFQ, INSERT NAME AND ADDRESS IN SPACE ABOVE LABELED 'VENDOR'



State of West Virginia  
Department of Administration  
Purchasing Division  
2019 Washington Street East  
Post Office Box 50130  
Charleston, WV 25305-0130

# Request for Quotation

RFQ NUMBER  
**05110326**

PAGE  
**10**

ADDRESS CORRESPONDENCE TO ATTENTION OF  
**BUYER 33  
304-558-2402**

RFQ COPY  
TYPE NAME/ADDRESS HERE

Carl Belt, Inc.  
P.O. Box 1210  
Cumberland, MD 21501-1210

DIVISION OF HIGHWAYS  
DISTRICT FIVE

RT US 50, P.O. BOX 99  
BURLINGTON, WV  
26710-0099 304-289-3521

|              |               |          |     |               |
|--------------|---------------|----------|-----|---------------|
| DATE PRINTED | TERMS OF SALE | SHIP VIA | FOB | FREIGHT TERMS |
| 01/12/2011   |               |          |     |               |

BID OPENING DATE: **02/16/2011** BID OPENING TIME **01:30PM**

| LINE   | QUANTITY | UOP | CAT NO | ITEM NUMBER | UNIT PRICE | AMOUNT     |
|--|----------|-----|--------|-------------|------------|------------|
| ***** THIS IS THE END OF RFQ 05110326 ***** TOTAL: |          |     |        |             |            | 109,250.00 |

SEE REVERSE SIDE FOR TERMS AND CONDITIONS

|                                 |                 |                                   |                 |
|---------------------------------|-----------------|-----------------------------------|-----------------|
| SIGNATURE <i>Mark A. Farris</i> | Mark A. Farris  | TELEPHONE (301) 729-8900          | DATE 02/16/2011 |
| TITLE V.P. & General Counsel    | FEIN 52-0747947 | ADDRESS CHANGES TO BE NOTED ABOVE |                 |

WHEN RESPONDING TO RFQ, INSERT NAME AND ADDRESS IN SPACE ABOVE LABELED 'VENDOR'

**Bid to Provide Forms and Pour Concrete Wall  
WVDOH Corridor H Salt Shed at Knobley Road  
Grant County, West Virginia**

11

**Description**

This bid is for construction of reinforced concrete walls for the WVDOH Corridor H salt shed located at the intersection of Corridor H and Knobley Road (County Route 3) in Grant County, West Virginia (see attached map).

Finish shall be plain, rubbed finish or have a simulated brick pattern. Walls are to be constructed in accordance with the attached plans on concrete footings previously constructed by the WVDOH.

**Contractor shall provide:**

- Form panels and all form hardware, including all necessary ties and bracing.
- All labor to set and brace forms.
- All labor to install and tie reinforcing steel.
- All labor to pour and consolidate concrete.
- All labor to strip forms, repair voids, and finish concrete as needed.
- Concrete pump to place concrete.
- Insulating blankets as required.

**WVDOH shall provide:**

- WVDOH Class B concrete
- Reinforcing steel bars and tie wire.
- Epoxy bonding agent as needed.

- Notes:
1. WVDOH shall cut reinforcing steel to length as needed.
  2. Vertical reinforcing steel bars shall be 12'-6" long and will be either one piece or lap spliced from two 7'-6" long pieces.
  3. Minimum lap splice length for #5 horizontal bars is 19".

**Suggested Vendors:**

- North Star Foundations, 5920 Frederick Crossing Lane, Frederick, MD 21704
- Lang Poured Walls, 19371 State Route 60, Beverly, OH 45715
- Shiley Construction, 1446 Nadenbousch Lane, Inwood, WV 25428

|    |    |    |    |    |
|----|----|----|----|----|
| 1  | 2  | 3  | 4  | 5  |
| 6  | 7  | 8  | 9  | 10 |
| 11 | 12 | 13 | 14 | 15 |
| 16 | 17 | 18 | 19 | 20 |

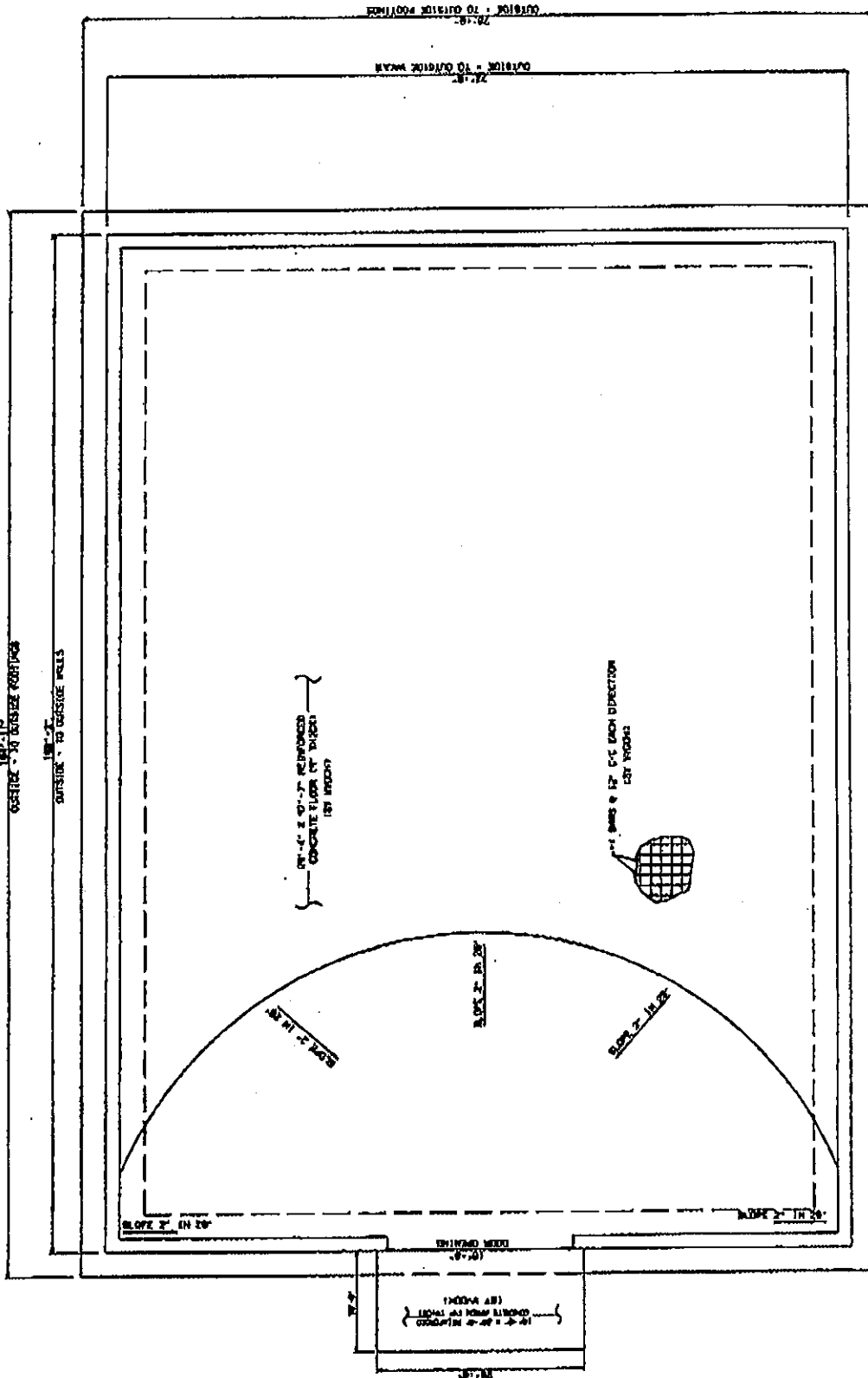

THE WEST VIRGINIA DEPARTMENT OF TRANSPORTATION  
DIVISION OF HIGHWAYS  
CORRIDOR H-KNOBLEY SALT SHED

NO SCALE

|     |      |    |     |
|-----|------|----|-----|
| REV | DATE | BY | CHK |
|     |      |    |     |

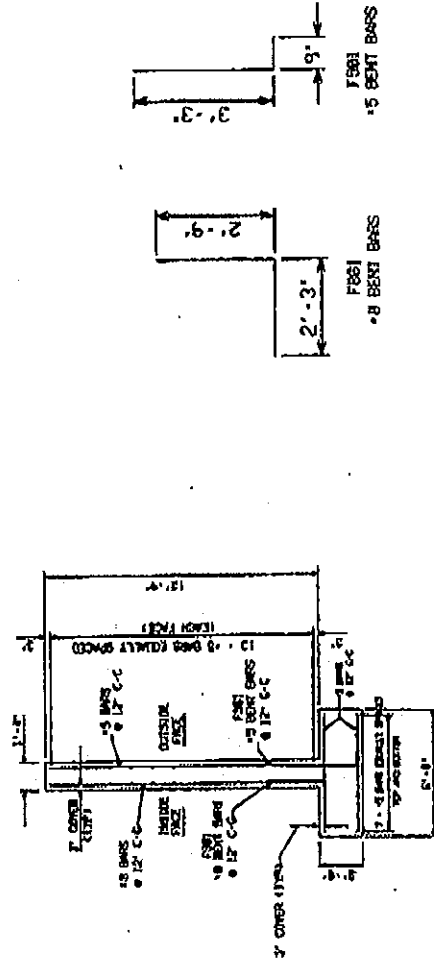
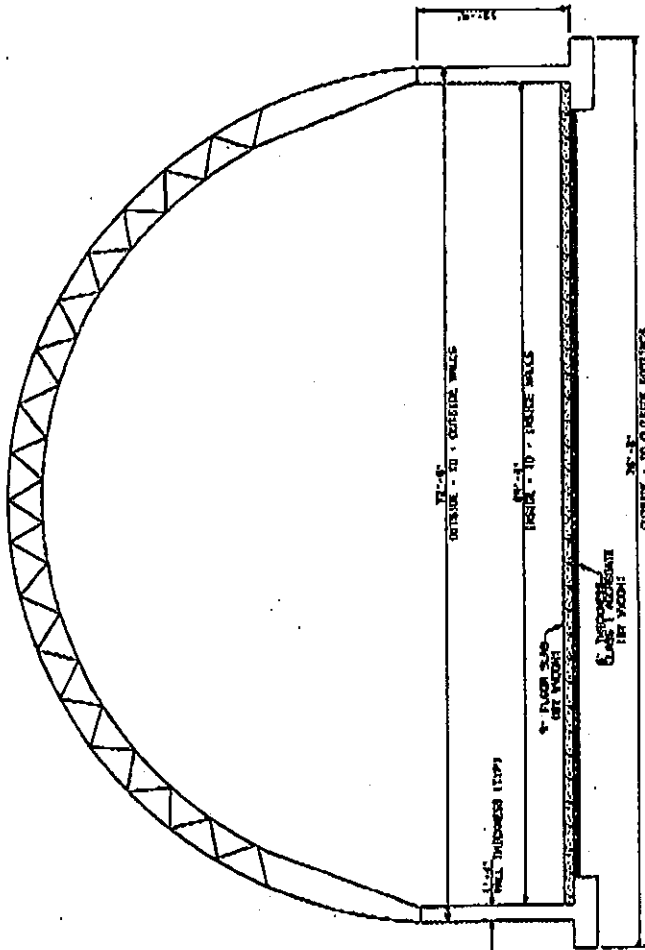

THE WEST VIRGINIA DEPARTMENT OF TRANSPORTATION  
 DIVISION OF HIGHWAYS  
 CORRIDOR H-KNOBLEY SALT SHEI

NO SCALE

Z.J. NUNN (SJD)  
 EXTENDING DESIGN

|   |   |   |   |   |   |   |   |   |    |    |    |
|---|---|---|---|---|---|---|---|---|----|----|----|
| 1 | 2 | 3 | 4 | 5 | 6 | 7 | 8 | 9 | 10 | 11 | 12 |
|---|---|---|---|---|---|---|---|---|----|----|----|

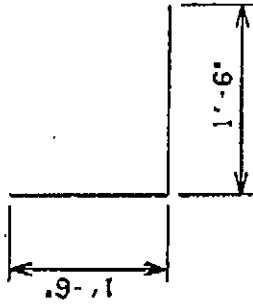

W501 - #5 BENT BARS

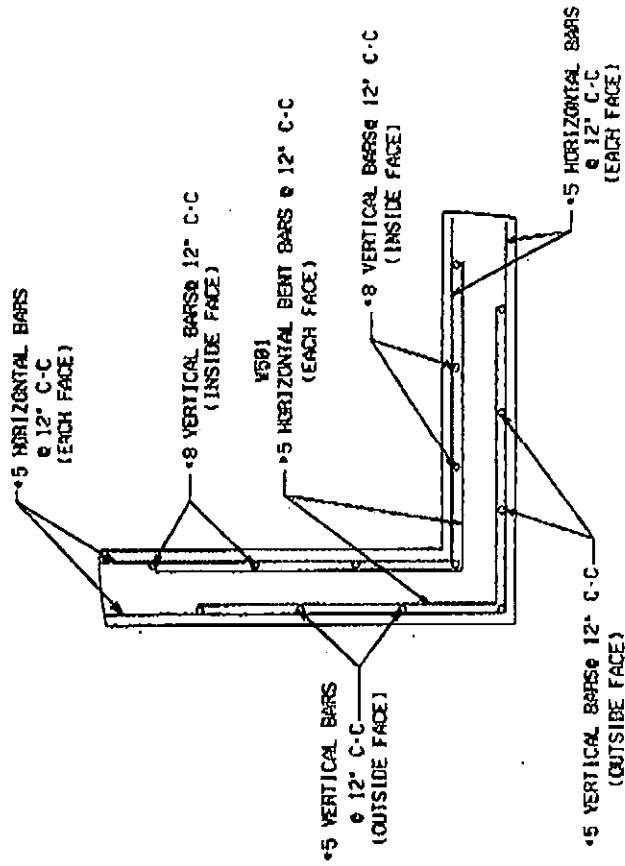

WALL CORNER DETAIL

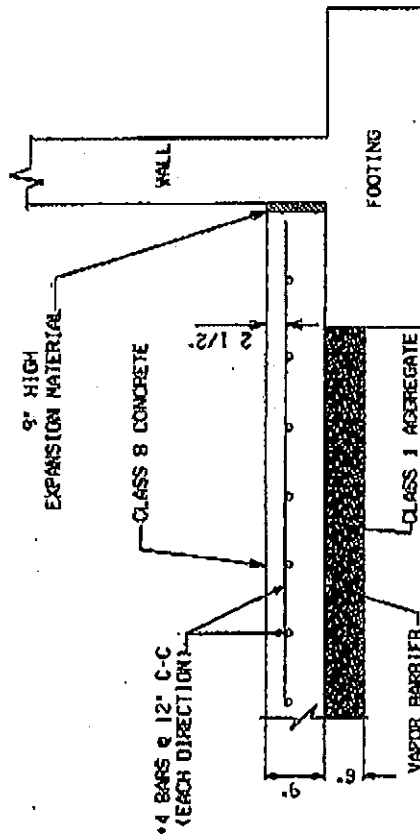

9" CONCRETE FLOOR SLAB DETAIL

(BY WYDOH)

NO SCALE

THE MISSOURI DEPARTMENT OF TRANSPORTATION  
DIVISION OF HIGHWAYS  
CORRIDOR H-KNOBLEY SALT SHED

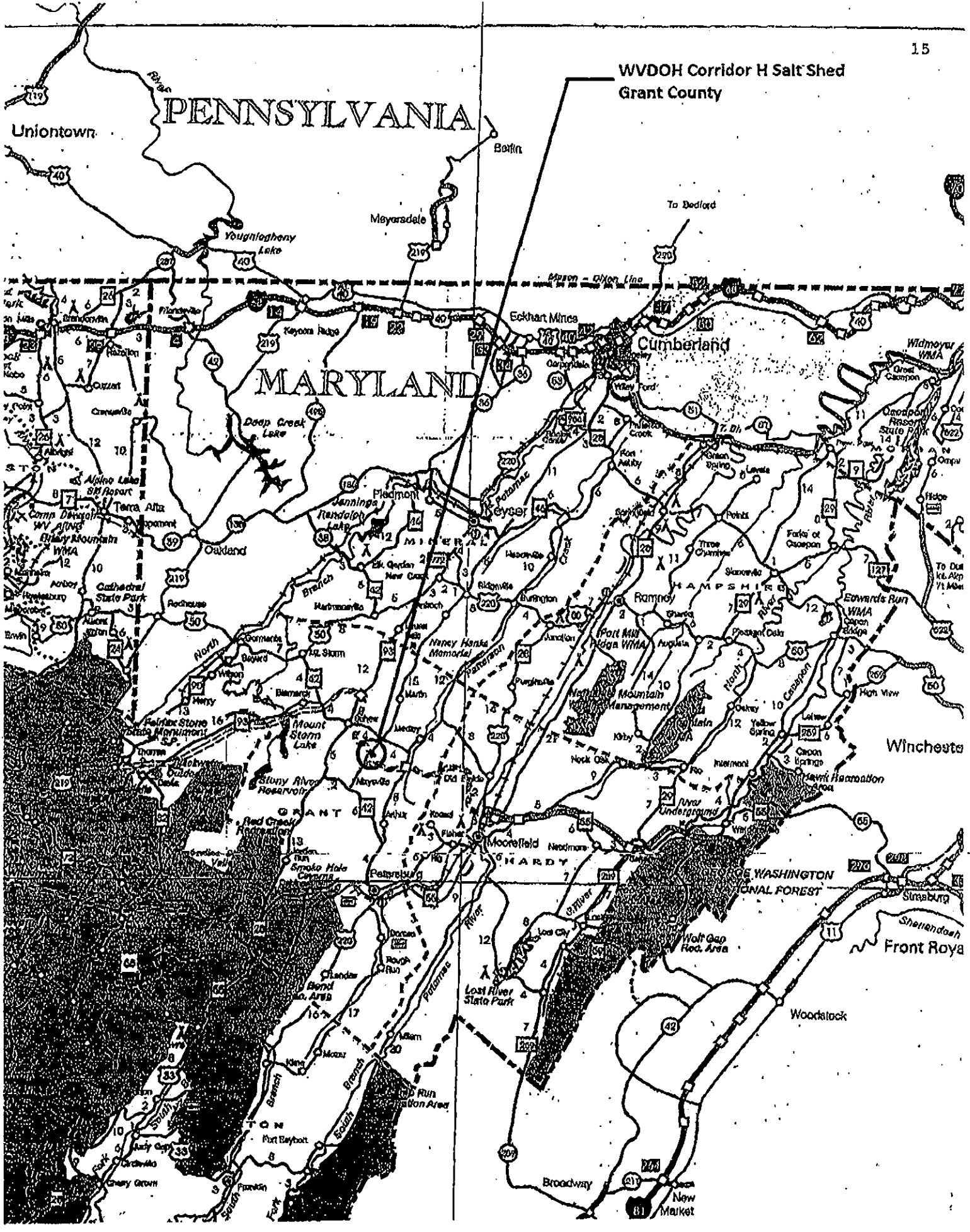

WVDOH Corridor H Salt Shed  
Grant County

PENNSYLVANIA

MARYLAND

Uniontown

Boffin

Mayersdale

Youghusband Lake

To Bedford

Mason - Dixon Line

Eckhart Mines

Cumberland

Widewater WMA

Deep Creek Lake

Jennings

Reynolds

Point

Unadilla State Park

Alpha Lake Ski Resort

Cathedral State Park

Branch

Wiley

Three Chimneys

High View

North

Stony River Reservoir

Moorefield

Intermont

Edwards Run WMA

Wilson

Stony River Reservoir

Moorefield

Intermont

Winchester

Wilson

Stony River Reservoir

Moorefield

Intermont

Edwards Run WMA

Wilson

Stony River Reservoir

Moorefield

Intermont

Edwards Run WMA

Wilson

Stony River Reservoir

Moorefield

Intermont

Edwards Run WMA

Wilson

Stony River Reservoir

Moorefield

Intermont

Edwards Run WMA

Wilson

Stony River Reservoir

Moorefield

Intermont

Edwards Run WMA

Wilson

Stony River Reservoir

Moorefield

Intermont

Edwards Run WMA

Wilson

Stony River Reservoir

Moorefield

Intermont

Edwards Run WMA

Wilson

Stony River Reservoir

Moorefield

Intermont

Edwards Run WMA

Wilson

Stony River Reservoir

Moorefield

Intermont

Edwards Run WMA

Wilson

Stony River Reservoir

Moorefield

Intermont

Edwards Run WMA

Wilson

Stony River Reservoir

Moorefield

Intermont

Edwards Run WMA

Wilson

Stony River Reservoir

Moorefield

Intermont

Edwards Run WMA

Wilson

Stony River Reservoir

Moorefield

Intermont



BID BOND PREPARATION INSTRUCTIONS

AGENCY (A)
RFQ/RFP# (B)

Bid Bond

- (A) WV State Agency (Stated on Page 1 "Spending Unit") Request for Quotation Number (upper right corner of page #1)
(C) Your Company Name
(D) City, Location of your Company
(E) State, Location of your Company
(F) Surety Corporate Name
(G) City, Location of Surety
(H) State, Location of Surety
(I) State of Surety Incorporation
(J) City of Surety Incorporation
(K) Minimum amount of acceptable bid bond is 5% of total bid. You may state "5% of bid" or a specific amount on this line in words.
(L) Amount of bond in figures
(M) Brief Description of scope of work
(N) Day of the month
(O) Month
(P) Year
(Q) Name of Corporation
(R) Raised Corporate Seal of Principal
(S) Signature of President or Vice President
(T) Title of person signing
(U) Raised Corporate Seal of Surety
(V) Corporate Name of Surety
(W) Signature of Attorney in Fact of the Surety

NOTE: Dated, Power of Attorney with Raised Surety Seal must accompany this bid bond.

KNOW ALL MEN BY THESE PRESENTS, That we, the undersigned, (C) of (D), (E) as Principal, and (F) of (G), (H), a corporation organized and existing under the laws of the State of (I) with its principal office in the City of (J), as Surety, are hold and firmly bound unto The State of West Virginia, as Obligee, in the penal sum of (K) (\$ (L)) for the payment of which, well and truly to be made, we jointly and severally bind ourselves, our heirs, administrators, executors, successors and assigns.

The Condition of the above obligation is such that whereas the Principal has submitted to the Purchasing Section of the Department of Administration a certain bid or proposal, attached hereto and made a part hereof to enter into a contract in writing for (M)

NOW THEREFORE.

- (a) If said bid shall be rejected, or
(b) If said bid shall be accepted and the Principal shall enter into a contract in accordance with the bid or proposal attached hereto and shall furnish any other bonds and insurance required by the bid or proposal, and shall in all other respects perform the agreement created by the acceptance of said bid then this obligation shall be null and void, otherwise this obligation shall remain in full force and effect. It is expressly understood and agreed that the liability of the Surety for any and all claims hereunder shall, in no event, exceed the penal amount of this obligation as herein stated

The Surety for value received, hereby stipulates and agrees that the obligations of said Surety and its bond shall be in no way impaired or affected by any extension of time within which the Obligee may accept such bid: and said Surety does hereby waive notice of any such extension.

IN WITNESS WHEREOF, Principal and Surety have hereunto set their hands and seals, and such of them as are corporations have caused their corporate seals to be affixed hereto and these presents to be signed by their proper officers, this (N) day of (O), 20 (P)

Principal Corporate Seal (R) (Q) (Name of Principal)
By (S) (Must be President or Vice President)
(T) Title
(U) Surety Corporate Seal (V) (Name of Surety)
(W) Attorney-in-Fact

IMPORTANT - Surety executing bonds must be licensed in West Virginia to transact surety insurance. Raised Corporate Seals must be affixed and a Power of Attorney must be attached.

WV Division  
Agency of Highways  
REQ. P.O.# 05110326

**BID BOND**

KNOW ALL MEN BY THESE PRESENTS, That we, the undersigned, Carl Belt, Inc.  
of Cumberland Maryland, as Principal, and Fidelity and Deposit Company of  
Maryland of 1400 American Lane, Schaumburg, IL 60196, a corporation organized and existing under the laws of the State of  
Maryland with its principal office in the City of Hunt Valley, MD, as Surety, are held and firmly bound unto the State  
of West Virginia, as Obligee, in the penal sum of 5% of the Total Bid Amount (\$ 5% of total bid ) for the payment of which,  
well and truly to be made, we jointly and severally bind ourselves, our heirs, administrators, executors, successors and assigns.

The Condition of the above obligation is such that whereas the Principal has submitted to the Purchasing Section of the  
Department of Administration a certain bid or proposal, attached hereto and made a part hereof, to enter into a contract in writing for

Form and Pour Concrete Wall for Corridor H Salt Shed at Knobley Road, Grant County

**NOW THEREFORE,**

- (a) If said bid shall be rejected, or
- (b) If said bid shall be accepted and the Principal shall enter into a contract in accordance with the bid or proposal attached hereto and shall furnish any other bonds and insurance required by the bid or proposal, and shall in all other respects perform the agreement created by the acceptance of said bid, then this obligation shall be null and void, otherwise this obligation shall remain in full force and effect. It is expressly understood and agreed that the liability of the Surety for any and all claims hereunder shall, in no event, exceed the penal amount of this obligation as herein stated.

The Surety, for the value received, hereby stipulates and agrees that the obligations of said Surety and its bond shall be in no way impaired or affected by any extension of the time within which the Obligee may accept such bid, and said Surety does hereby waive notice of any such extension.

IN WITNESS WHEREOF, Principal and Surety have hereunto set their hands and seals, and such of them as are corporations have caused their corporate seals to be affixed hereunto and these presents to be signed by their proper officers, this  
16th day of February, 20 11.



Carl Belt, Inc.  
(Name of Principal)  
By Mark A. Farris  
(Must be President or Vice President)  
Mark A. Farris  
Vice President & General Counsel  
(Title)

Fidelity and Deposit Company of Maryland  
(Name of Surety)  
Page T. Shanklin  
Attorney-in-Fact  
Page T. Shanklin

Holly Kidwell  
WV Countersignature Holly Kidwell

**IMPORTANT - Surety executing bonds must be licensed in West Virginia to transact surety insurance. Raised corporate seals must be affixed, a power of attorney must be attached.**

### Power of Attorney FIDELITY AND DEPOSIT COMPANY OF MARYLAND

KNOW ALL MEN BY THESE PRESENTS: That the FIDELITY AND DEPOSIT COMPANY OF MARYLAND, a corporation of the State of Maryland, by WILLIAM J. MILLS, Vice President, and GERALD F. HALEY, Assistant Secretary, in pursuance of authority granted by Article VI, Section 2, of the By-Laws of said Company, which are set forth on the reverse side hereof and are hereby certified to be in full force and effect on the date hereof does hereby nominate, constitute and appoint Page T. SHANKLIN, H. Glenn TWIGG, Craig E. WENGERD, Jay A. BATESON and Michael FETCHERO, all of Cumberland, Maryland, EACH its true and lawful agent and Attorney-in-Fact, to make, execute, seal and deliver, for, and on its behalf as surety, and as its act and deed any and all bonds and undertakings, and the execution of such bonds or undertakings in pursuance of these presents shall be as binding upon said Company, as fully and amply, to all intents and purposes, as if they had been duly executed and acknowledged by the regularly elected officers of the Company at its office in Baltimore, Md., in their own proper persons. This power of attorney revokes that issued on behalf of Page T. SHANKLIN, H. Glenn TWIGG, Craig E. WENGERD, Jay A. BATESON, dated February 14, 2007.

The said Assistant Secretary does hereby certify that the extract set forth on the reverse side hereof is a true copy of Article VI, Section 2, of the By-Laws of said Company, and is now in force.

IN WITNESS WHEREOF, the said Vice-President and Assistant Secretary have hereunto subscribed their names and affixed the Corporate Seal of the said FIDELITY AND DEPOSIT COMPANY OF MARYLAND, this 6th day of September, A.D. 2007.

ATTEST:

FIDELITY AND DEPOSIT COMPANY OF MARYLAND



*Gerald F. Haley*

Gerald F. Haley Assistant Secretary

*William J. Mills*

By:

William J. Mills

Vice President

State of Maryland }  
City of Baltimore } ss:

On this 6th day of September, A.D. 2007, before the subscriber, a Notary Public of the State of Maryland, duly commissioned and qualified, came WILLIAM J. MILLS, Vice President, and GERALD F. HALEY, Assistant Secretary of the FIDELITY AND DEPOSIT COMPANY OF MARYLAND, to me personally known to be the individuals and officers described in and who executed the preceding instrument, and they each acknowledged the execution of the same, and being by me duly sworn, severally and each for himself depose and saith, that they are the said officers of the Company aforesaid, and that the seal affixed to the preceding instrument is the Corporate Seal of said Company, and that the said Corporate Seal and their signatures as such officers were duly affixed and subscribed to the said instrument by the authority and direction of the said Corporation.

IN TESTIMONY WHEREOF, I have hereunto set my hand and affixed my Official Seal the day and year first above written.



*Maria D. Adamski*

Maria D. Adamski

Notary Public

My Commission Expires: July 8, 2011

**EXTRACT FROM BY-LAWS OF FIDELITY AND DEPOSIT COMPANY OF MARYLAND**

"Article VI, Section 2. The Chairman of the Board, or the President, or any Executive Vice-President, or any of the Senior Vice-Presidents or Vice-Presidents specially authorized so to do by the Board of Directors or by the Executive Committee, shall have power, by and with the concurrence of the Secretary or any one of the Assistant Secretaries, to appoint Resident Vice-Presidents, Assistant Vice-Presidents and Attorneys-in-Fact as the business of the Company may require, or to authorize any person or persons to execute on behalf of the Company any bonds, undertakings, recognizances, stipulations, policies, contracts, agreements, deeds, and releases and assignments of judgements, decrees, mortgages and instruments in the nature of mortgages,...and to affix the seal of the Company thereto."

**CERTIFICATE**

I, the undersigned, Assistant Secretary of the FIDELITY AND DEPOSIT COMPANY OF MARYLAND, do hereby certify that the foregoing Power of Attorney is still in full force and effect on the date of this certificate; and I do further certify that the Vice-President who executed the said Power of Attorney was one of the additional Vice-Presidents specially authorized by the Board of Directors to appoint any Attorney-in-Fact as provided in Article VI, Section 2, of the By-Laws of the FIDELITY AND DEPOSIT COMPANY OF MARYLAND.

This Power of Attorney and Certificate may be signed by facsimile under and by authority of the following resolution of the Board of Directors of the FIDELITY AND DEPOSIT COMPANY OF MARYLAND at a meeting duly called and held on the 10th day of May, 1990.

RESOLVED: "That the facsimile or mechanically reproduced seal of the company and facsimile or mechanically reproduced signature of any Vice-President, Secretary, or Assistant Secretary of the Company, whether made heretofore or hereafter, wherever appearing upon a certified copy of any power of attorney issued by the Company, shall be valid and binding upon the Company with the same force and effect as though manually affixed."

IN TESTIMONY WHEREOF, I have hereunto subscribed my name and affixed the corporate seal of the said Company,

this 16th day of February, 2011

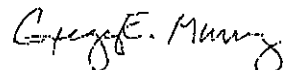

*Assistant Secretary*

# CONTRACTOR LICENSE

Authorized by the

## West Virginia Contractor Licensing Board

**Number:** WV000355

**Classification:**

- GENERAL BUILDING
- GENERAL ENGINEERING
- MULTIFAMILY
- MASONRY
- ROOFING

CARL BELT INC  
 DBA BELT CONSTRUCTION  
 PO BOX 1210  
 CUMBERLAND, MD 21501-1210

**Date Issued**

**Expiration Date**

|                |                |
|----------------|----------------|
| AUGUST 02 2010 | AUGUST 02 2011 |
|----------------|----------------|

*Thomas R. Wolf*

Authorized Company Signature

*Michael A. Carl*

Chair, West Virginia Contractor Licensing Board

**WEST VIRGINIA  
 CONTRACTOR  
 LICENSING  
 BOARD**

This license, or a copy thereof, must be posted in a conspicuous place at every construction site where work is being performed. This license number must appear in all advertisements, on all bid submissions and on all fully executed and binding contracts. This license cannot be assigned or transferred by licensee. Issued under provisions of West Virginia Code, Chapter 21, Article 11.



RFQ No. 05110326

STATE OF WEST VIRGINIA  
Purchasing Division

**PURCHASING AFFIDAVIT**

West Virginia Code §5A-3-10a states: No contract or renewal of any contract may be awarded by the state or any of its political subdivisions to any vendor or prospective vendor when the vendor or prospective vendor or a related party to the vendor or prospective vendor is a debtor and the debt owed is an amount greater than one thousand dollars in the aggregate.

**DEFINITIONS:**

"Debt" means any assessment, premium, penalty, fine, tax or other amount of money owed to the state or any of its political subdivisions because of a judgment, fine, permit violation, license assessment, defaulted workers' compensation premium, penalty or other assessment presently delinquent or due and required to be paid to the state or any of its political subdivisions, including any interest or additional penalties accrued thereon.

"Debtor" means any individual, corporation, partnership, association, limited liability company or any other form or business association owing a debt to the state or any of its political subdivisions. "Political subdivision" means any county commission; municipality; county board of education; any instrumentality established by a county or municipality; any separate corporation or instrumentality established by one or more counties or municipalities, as permitted by law; or any public body charged by law with the performance of a government function or whose jurisdiction is coextensive with one or more counties or municipalities. "Related party" means a party, whether an individual, corporation, partnership, association, limited liability company or any other form or business association or other entity whatsoever, related to any vendor by blood, marriage, ownership or contract through which the party has a relationship of ownership or other interest with the vendor so that the party will actually or by effect receive or control a portion of the benefit, profit or other consideration from performance of a vendor contract with the party receiving an amount that meets or exceeds five percent of the total contract amount.

**EXCEPTION:** The prohibition of this section does not apply where a vendor has contested any tax administered pursuant to chapter eleven of this code, workers' compensation premium, permit fee or environmental fee or assessment and the matter has not become final or where the vendor has entered into a payment plan or agreement and the vendor is not in default of any of the provisions of such plan or agreement.

Under penalty of law for false swearing (*West Virginia Code* §61-5-3), it is hereby certified that the vendor affirms and acknowledges the information in this affidavit and is in compliance with the requirements as stated.

**WITNESS THE FOLLOWING SIGNATURE**

Vendor's Name: Carl Belt, Inc.

Authorized Signature: *Mark A. Farris* Date: 02/16/2011  
Mark A. Farris

State of Maryland

County of Allegany, to-wit:

Taken, subscribed, and sworn to before me this 16 day of February, 2011.

My Commission expires June 7, 2011.

AFFIX SEAL

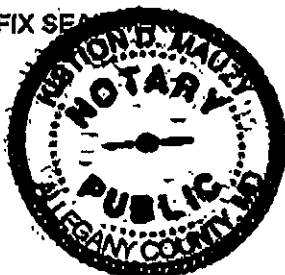

NOTARY PUBLIC

*Kistion D. Mauzy*  
Kistion D. Mauzy



State of West Virginia
DRUG FREE WORKPLACE CONFORMANCE AFFIDAVIT
West Virginia Code §21-1D-5

STATE OF Maryland

COUNTY OF Allegany, TO-WIT:

I, Mark A. Farris; after being first duly sworn, depose and state as follows:

- 1. I am an employee of Carl Belt, Inc.; and,
2. I do hereby attest that Carl Belt, Inc.

maintains a valid written drug free workplace policy and that such policy is in compliance with West Virginia Code §21-1D-5.

The above statements are sworn to under the penalty of perjury.

Carl Belt, Inc.
(Company Name)

By: Mark A. Farris

Title: Mark A. Farris, Vice President & General Counsel

Date: February 16, 2011

Taken, subscribed and sworn to before me this 16th day of February 2011.

My commission expires June 7, 2011



Kistion D. Mauzy
(Notary Public)

THIS AFFIDAVIT MUST BE SUBMITTED WITH THE BID IN ORDER TO COMPLY WITH WV CODE PROVISIONS. FAILURE TO INCLUDE THE AFFIDAVIT WITH THE BID SHALL RESULT IN DISQUALIFICATION OF THE BID.