



State of West Virginia
Department of Administration

**Request for
Quotation**

RFQ NUMBER
GSD106457

PAGE
1

Ron VanBibber
Core Commercial Account Executive
Vertical Market A.E.

ADT Security Services
2800 7th Avenue
Suite 100
Charleston, WV 25312

Tel: 304 206 3051
Cell: 304 533 9990
rvanbibber@adt.com
www.adt.com

A Tyco International Company



ADDRESS CORRESPONDENCE TO ATTENTION OF
KRISTA FERRELL 304-558-2596

DEPARTMENT OF ADMINISTRATION
GENERAL SERVICES DIVISION
BUILDING 84 CORNERSTONE
1409 GREENBRIER ST
CHARLESTON WV
25311
304-558-2317

SHIP TO

DATE PRINTED	TERMS OF SALE	SHIP VIA	FOB	FREIGHT TERMS
04/14/2010				
BID OPENING DATE: 05/13/2010		BID OPENING TIME 01:30PM		

LINE	QUANTITY	UOP	CAT NO	ITEM NUMBER	UNIT PRICE	AMOUNT
0001	1	LS		936-73	TOTAL SYSTEM CORNERSTONE	19,102.84
<p>SECURITY SYSTEM INSTALLATION, BLDG#84, REQUEST FOR QUOTATION (RFQ)</p> <p>THE WEST VIRGINIA DIVISION OF PURCHASING FOR THE AGENC THE WEST VIRGINIA DIVISION OF GENERAL SERVICES, IS SOLICITING BIDS TO PROVIDE THE AGENCY WITH ALL LABOR AND MATERIALS FOR THE INSTALLATION OF A NEW SECURITY SYSTEM FOR BUILDING #84 (CORNERSTONE) LOCATED AT 1409 GREENBRIER STREET IN CHARLESTON, WEST VIRGINIA PER THE ATTACHED SPECIFICATIONS.</p> <p>A MANDATORY PRE-BID WILL BE HELD ON APRIL 29, 2010 @ 10:00PM ON SITE. VENDORS ARE TO MEET IN THE LOBBY. ALL INTERESTED PARTIES ARE REQUIRED TO ATTEND THIS MEETING. FAILURE TO ATTEND THE MANDATORY PRE-BID SHALL RESULT IN DISQUALIFICATION OF THE BID. NO ONE PERSON MAY REPRESENT MORE THAN ONE BIDDER.</p> <p>AN ATTENDANCE SHEET WILL BE MADE AVAILABLE FOR ALL POTENTIAL BIDDERS TO COMPLETE. THIS WILL SERVE AS THE OFFICIAL DOCUMENT VERIFYING ATTENDANCE AT THE MANDATORY PRE-BID. FAILURE TO PROVIDE YOUR COMPANY AND REPRESENTATIVE NAME ON THE ATTENDANCE SHEET WILL RESU IN DISQUALIFICATION OF THE BID. THE STATE WILL NOT ACCEPT ANY OTHER DOCUMENTATION TO VERIFY ATTENDANCE. THE BIDDER IS RESPONSIBLE FOR ENSURING THEY HAVE COMPLETED THE INFORMATION REQUIRED ON THE ATTENDANCE SHEET. THE PURCHASING DIVISION AND THE STATE AGENCY</p>						

RECEIVED
2010 MAY 13 PM 1:15
WV PURCHASING
DIVISION

SIGNATURE	SEE REVERSE SIDE FOR TERMS AND CONDITIONS	TELEPHONE	DATE
<i>[Signature]</i>		304 533-9990	4/30/2010
TITLE	FEIN	ADDRESS CHANGES TO BE NOTED ABOVE	
Govmnt Rep	0-58-1814102		

WHEN RESPONDING TO RFQ, INSERT NAME AND ADDRESS IN SPACE ABOVE LABELED 'VENDOR'

GENERAL TERMS & CONDITIONS
REQUEST FOR QUOTATION (RFQ) AND REQUEST FOR PROPOSAL (RFP)

1. Awards will be made in the best interest of the State of West Virginia
2. The State may accept or reject in part, or in whole, any bid.
3. Prior to any award, the apparent successful vendor must be properly registered with the Purchasing Division and have paid the required \$125 fee.
4. All services performed or goods delivered under State Purchase Order/Contracts are to be continued for the term of the Purchase Order/Contracts, contingent upon funds being appropriated by the Legislature or otherwise being made available. In the event funds are not appropriated or otherwise available for these services or goods this Purchase Order/Contract becomes void and of no effect after June 30.
5. Payment may only be made after the delivery and acceptance of goods or services.
6. Interest may be paid for late payment in accordance with the *West Virginia Code*.
7. Vendor preference will be granted upon written request in accordance with the *West Virginia Code*.
8. The State of West Virginia is exempt from federal and state taxes and will not pay or reimburse such taxes.
9. The Director of Purchasing may cancel any Purchase Order/Contract upon 30 days written notice to the seller
10. The laws of the State of West Virginia and the *Legislative Rules* of the Purchasing Division shall govern the purchasing process
11. Any reference to automatic renewal is hereby deleted. The Contract may be renewed only upon mutual written agreement of the parties.
12. **BANKRUPTCY:** In the event the vendor/contractor files for bankruptcy protection, the State may deem this contract null and void, and terminate such contract without further order.
13. **HIPAA BUSINESS ASSOCIATE ADDENDUM:** The West Virginia State Government HIPAA Business Associate Addendum (BAA), approved by the Attorney General, is available online at www.state.wv.us/admin/purchase/vrc/hipaa.htm and is hereby made part of the agreement. Provided that the Agency meets the definition of a Cover Entity (45 CFR §160.103) and will be disclosing Protected Health Information (45 CFR §160.103) to the vendor.
14. **CONFIDENTIALITY:** The vendor agrees that he or she will not disclose to anyone, directly or indirectly, any such personally identifiable information or other confidential information gained from the agency, unless the individual who is the subject of the information consents to the disclosure in writing or the disclosure is made pursuant to the agency's policies, procedures, and rules. Vendor further agrees to comply with the Confidentiality Policies and Information Security Accountability Requirements, set forth in <http://www.state.wv.us/admin/purchase/privacy/noticeConfidentiality.pdf>.
15. **LICENSING:** Vendors must be licensed and in good standing in accordance with any and all state and local laws and requirements by any state or local agency of West Virginia, including, but not limited to, the West Virginia Secretary of State's Office, the West Virginia Tax Department, and the West Virginia Insurance Commission. The vendor must provide all necessary releases to obtain information to enable the director or spending unit to verify that the vendor is licensed and in good standing with the above entities.
16. **ANTITRUST:** In submitting a bid to any agency for the State of West Virginia, the bidder offers and agrees that if the bid is accepted the bidder will convey, sell, assign or transfer to the State of West Virginia all rights, title and interest in and to all causes of action it may now or hereafter acquire under the antitrust laws of the United States and the State of West Virginia for price fixing and/or unreasonable restraints of trade relating to the particular commodities or services purchased or acquired by the State of West Virginia. Such assignment shall be made and become effective at the time the purchasing agency tenders the initial payment to the bidder.

I certify that this bid is made without prior understanding, agreement, or connection with any corporation, firm, limited liability company, partnership, or person or entity submitting a bid for the same material, supplies, equipment or services and is in all respects fair and without collusion or fraud. I further certify that I am authorized to sign the certification on behalf of the bidder or this bid.

INSTRUCTIONS TO BIDDERS

1. Use the quotation forms provided by the Purchasing Division. Complete all sections of the quotation form.
2. Items offered must be in compliance with the specifications. Any deviation from the specifications must be clearly indicated by the bidder. Alternates offered by the bidder as **EQUAL** to the specifications must be clearly defined. A bidder offering an alternate should attach complete specifications and literature to the bid. The Purchasing Division may waive minor deviations to specifications.
3. Unit prices shall prevail in case of discrepancy. All quotations are considered F.O.B. destination unless alternate shipping terms are clearly identified in the quotation.
4. All quotations must be delivered by the bidder to the office listed below prior to the date and time of the bid opening. Failure of the bidder to deliver the quotations on time will result in bid disqualifications: Department of Administration, Purchasing Division, 2019 Washington Street East, P.O. Box 50130, Charleston, WV 25305-0130
5. Communication during the solicitation, bid, evaluation or award periods, except through the Purchasing Division, is strictly prohibited (W.Va. C.S.R. §148-1-6.6).



State of West Virginia
 Department of Administration
 Purchasing Division
 2019 Washington Street East
 Post Office Box 50130
 Charleston, WV 25305-0130

Request for Quotation

RFQ NUMBER
GSD106457

PAGE
2

ADDRESS CORRESPONDENCE TO ATTENTION OF
**KRISTA FERRELL
 304-558-2596**

RFQ COPY
 TYPE NAME/ADDRESS HERE

VENDOR

SHIP TO

DEPARTMENT OF ADMINISTRATION
 GENERAL SERVICES DIVISION
 BUILDING 84 CORNERSTONE
 1409 GREENBRIER ST
 CHARLESTON WV
 25311 304-558-2317

DATE PRINTED	TERMS OF SALE	SHIP VIA	F.O.B.	FREIGHT TERMS
04/14/2010				

BID OPENING DATE: **05/13/2010** BID OPENING TIME **01:30PM**

LINE	QUANTITY	UQP	QAT NO	ITEM NUMBER	UNIT PRICE	AMOUNT
<p>WILL NOT ASSUME ANY RESPONSIBILITY FOR A BIDDER-S FAILURE TO COMPLETE THE PRE-BID ATTENDANCE SHEET. IN ADDITION, WE REQUEST THAT ALL POTENTIAL BIDDERS INCLUDE THEIR E-MAIL ADDRESS AND FAX NUMBER.</p> <p>ALL POTENTIAL BIDDERS ARE REQUESTED TO ARRIVE PRIOR TO THE STARTING TIME FOR THE PRE-BID. BIDDERS WHO ARRIVE LATE, BUT PRIOR TO THE DISMISSAL OF THE TECHNICAL PORTION OF THE PRE-BID WILL BE PERMITTED TO SIGN IN. BIDDERS WHO ARRIVE AFTER CONCLUSION OF THE TECHNICAL PORTION OF THE PRE-BID, BUT DURING ANY SUBSEQUENT PART OF THE PRE-BID WILL NOT BE PERMITTED TO SIGN THE ATTENDANCE SHEET.</p> <p>TECHNICAL QUESTIONS CONCERNING THIS PROJECT MSUT BE SUBMITTED IN WRITING TO KRISTA FERRELL IN THE WEST VIRGINIA PURCHASING DIVISION VIA MAIL AT THE ADDRESS SHOWN IN THE BODY OF THIS RFQ, VIA FAX AT 304-558 4115, OR VIA EMAIL AT KRISTA.S.FERRELL@WV.GOV. DEADLINE FOR ALL TECHNICAL QUESTIONS IS MONDAY, MAY 4, 2009 AT THE CLOSE OF BUSINESS. ALL TECHNICAL QUESTIONS RECEIVED, IF ANY, WILL BE ADDRESSED BY ADDENDUM AFTER THE DEADLINE HAS LAPSED.</p> <p>QUESTIONS CONCERNING THE PROCESS BY WHICH A VENDOR MAY SUBMIT A BID TO THE STATE OF WEST VIRGINIA AREA NOT CONSIDERED TO BE TECHNICAL QUESTIONS AND MAY BE SUBMITTED ANY ANY TIME PRIOR TO THE BID OPENING AND IN ANY FORMAT.</p> <p>THE MODEL/BRAND/SPECIFICATIONS NAMED HEREIN ESTABLISH THE ACCEPTABLE LEVEL OF QUALITY ONLY AND ARE NOT INTENDED TO REFLECT A PREFERENCE OR FAVOR ANY PARTICULAR BRAND OR VENDOR. VENDORS WHO ARE BIDDING ALTERNATES SHOULD SO STATE AND INCLUDE PERTINENT LITERATURE AND SPECIFICATIONS. FAILURE TO PROVIDE</p>						

SEE REVERSE SIDE FOR TERMS AND CONDITIONS

SIGNATURE <i>[Signature]</i>	TELEPHONE 3045339990	DATE 4-30-2010
TITLE County Rep	FEIN 58-1814103	ADDRESS CHANGES TO BE NOTED ABOVE

WHEN RESPONDING TO RFQ, INSERT NAME AND ADDRESS IN SPACE ABOVE LABELED 'VENDOR'



State of West Virginia
 Department of Administration
 Purchasing Division
 2019 Washington Street East
 Post Office Box 50130
 Charleston, WV 25305-0130

Request for Quotation

RFQ NUMBER
GSD106457

PAGE
3

ADDRESS CORRESPONDENCE TO ATTENTION OF
**KRISTA FERRELL
 304-558-2596**

RFQ COPY
 TYPE NAME/ADDRESS HERE

VENDOR

SHIP TO

DEPARTMENT OF ADMINISTRATION
 GENERAL SERVICES DIVISION
 BUILDING 84 CORNERSTONE
 1409 GREENBRIER ST
 CHARLESTON WV
 25311 304-558-2317

DATE PRINTED	TERMS OF SALE	SHIP VIA	F.O.B.	FREIGHT TERMS
04/14/2010				

BID OPENING DATE: **05/13/2010** BID OPENING TIME **01:30PM**

LINE	QUANTITY	UOP	CAT NO	ITEM NUMBER	UNIT PRICE	AMOUNT
<p>INFORMATION FOR ANY ALTERNATES MAY BE GROUNDS FOR REJECTION OF THE BID. THE STATE RESERVES THE RIGHT TO WAIVE MINOR IRREGULARITIES IN BIDS OR SPECIFICATIONS IN ACCORDANCE WITH SECTION 148-1-4(F) OF THE WEST VIRGINIA LEGISLATIVE RULES AND REGULATIONS.</p> <p>EXHIBIT 5</p> <p>WEST VIRGINIA CODE 21-1D-5 PROVIDES THAT: ANY SOLICITATION FOR A PUBLIC IMPROVEMENT CONSTRUCTION CONTRACT REQUIRES EACH VENDOR THAT SUBMITS A BID FOR THE WORK TO SUBMIT AT THE SAME TIME AN AFFIDAVIT OF COMPLIANCE WITH THE BID. THE ENCLOSED DRUG-FREE WORKPLACE AFFIDAVIT MUST BE SIGNED AND SUBMITTED WITH THE BID AS EVIDENCE OF THE VENDOR'S COMPLIANCE WITH THE PROVISIONS OF ARTICLE 1D, CHAPTER 21 OF THE WEST VIRGINIA CODE. FAILURE TO SUBMIT THE SIGNED DRUG-FREE WORKPLACE AFFIDAVIT WITH THE BID SHALL RESULT IN DISQUALIFICATION OF SUCH BID.</p> <p>NOTICE TO PROCEED: THIS CONTRACT IS TO BE PERFORMED WITHIN 30 CALENDAR DAYS AFTER THE NOTICE TO PROCEED IS RECEIVED. THE AGENCY WILL ISSUE A WRITTEN NOTICE TO PROCEED TO THE SUCCESSFUL VENDOR.</p> <p>CANCELLATION: THE DIRECTOR OF PURCHASING RESERVES THE RIGHT TO CANCEL THIS CONTRACT IMMEDIATELY UPON WRITTEN NOTICE TO THE VENDOR IF THE MATERIALS OR WORKMANSHIP SUPPLIED ARE OF AN INFERIOR QUALITY OR DO NOT CONFORM WITH THE SPECIFICATIONS OF THE BID AND CONTRACT HERE IN.</p> <p>WAGE RATES: THE CONTRACTOR OR SUBCONTRACTOR SHALL PAY THE HIGHER OF THE U.S. DEPARTMENT OF LABOR MINIMUM WAGE RATES AS ESTABLISHED FOR KANAWHA COUNTY, PURSUANT TO WEST VIRGINIA CODE 21-5A, ET, SEQ. (PREVAILING WAGE RATES APPLY TO THIS PROJECT)</p>						

SEE REVERSE SIDE FOR TERMS AND CONDITIONS

SIGNATURE <i>[Signature]</i>	TELEPHONE 304553-9990	DATE 4-30-2010
TITLE Govmt Rep	FEIN 58-1814102	ADDRESS CHANGES TO BE NOTED ABOVE

WHEN RESPONDING TO RFQ, INSERT NAME AND ADDRESS IN SPACE ABOVE LABELED 'VENDOR'



State of West Virginia
 Department of Administration
 Purchasing Division
 2019 Washington Street East
 Post Office Box 50130
 Charleston, WV 25305-0130

Request for Quotation

RFQ NUMBER
GSD106457

PAGE
4

ADDRESS CORRESPONDENCE TO ATTENTION OF
**KRISTA FERRELL
 304-558-2596**

RFQ COPY
 TYPE NAME/ADDRESS HERE

VENDOR

SHIP TO

DEPARTMENT OF ADMINISTRATION
 GENERAL SERVICES DIVISION
 BUILDING 84 CORNERSTONE
 1409 GREENBRIER ST
 CHARLESTON WV
 25311 304-558-2317

DATE PRINTED	TERMS OF SALE	SHIP VIA	F.O.B.	FREIGHT TERMS
04/14/2010				

BID OPENING DATE: **05/13/2010** BID OPENING TIME **01:30PM**

LINE	QUANTITY	UOP	CAT NO.	ITEM NUMBER	UNIT PRICE	AMOUNT
<p>ARBITRATION: ANY REFERENCES MADE TO ARBITRATION OR INTEREST FOR PAYMENTS DUE (EXCEPT FOR ANY INTEREST REQUIRED BY STATE LAW) CONTAINED IN THIS CONTRACT OR IN ANY AMERICAN INSTITUTE OF ARCHITECTS DOCUMENTS PERTAINING TO THIS CONTRACT ARE HEREBY DELETED.</p> <p>WORKERS' COMPENSATION: VENDOR IS REQUIRED TO PROVIDE A CERTIFICATE FROM WORKERS' COMPENSATION IF SUCCESSFUL.</p> <p>ALL OF THE ITEMS CHECKED BELOW WILL BE A REQUIREMENT OF THIS CONTRACT:</p> <p>(XX) INSURANCE: SUCCESSFUL VENDOR SHALL FURNISH PROOF OF COMMERCIAL GENERAL LIABILITY INSURANCE PRIOR TO ISSUANCE OF CONTRACT. UNLESS OTHERWISE SPECIFIED IN THE BID DOCUMENTS, THE MINIMUM AMOUNT OF INSURANCE COVERAGE REQUIRED IS \$1,000,000.00.</p> <p>() BUILDERS RISK INSURANCE: SUCCESSFUL VENDOR SHALL FURNISH PROOF OF BUILDERS RISK - ALL RISK INSURANCE IN AN AMOUNT EQUAL TO 100% OF THE AMOUNT OF THE CONTRACT.</p> <p>(XX) BONDS: FIVE PERCENT (5%) OF THE TOTAL AMOUNT OF THE BID PAYABLE TO THE STATE OF WEST VIRGINIA, SHALL BE SUBMITTED WITH EACH BID AS A BID BOND. THE SUCCESSFUL BIDDER SHALL ALSO FURNISH A PERFORMANCE BOND AND LABOR/MATERIAL BOND FOR 100% OF THE AMOUNT OF THE CONTRACT. BONDS MAY BE PROVIDED IN THE FORM OF A CERTIFIED CHECK, IRREVOCABLE LETTER OF CREDIT, OR BOND FURNISHED BY A SOLVENT SURETY COMPANY AUTHORIZED TO DO BUSINESS IN THE STATE OF WEST VIRGINIA. A LETTER OF CREDIT SUBMITTED IN LIEU OF A BOND WILL ONLY BE ALLOWED FOR PROJECTS UNDER \$100,000. PERSONAL OR BUSINESS CHECKS ARE NOT ACCEPCTABLE IN LIEU OF THE 5% BID BOND, PERFORMANCE BOND, OR LABOR AND MATERIAL BOND.</p>						

SEE REVERSE SIDE FOR TERMS AND CONDITIONS

SIGNATURE <i>[Signature]</i>	TELEPHONE 304 533-9990	DATE 4-30-2010
TITLE Govt Rep	FEIN 58-1814102	ADDRESS CHANGES TO BE NOTED ABOVE

WHEN RESPONDING TO RFQ, INSERT NAME AND ADDRESS IN SPACE ABOVE LABELED 'VENDOR'



State of West Virginia
 Department of Administration
 Purchasing Division
 2019 Washington Street East
 Post Office Box 50130
 Charleston, WV 25305-0130

Request for Quotation

RFQ NUMBER
GSD106457

PAGE
5

ADDRESS CORRESPONDENCE TO ATTENTION OF
**KRISTA FERRELL
 304-558-2596**

VENDOR

RFQ COPY
 TYPE NAME/ADDRESS HERE

SHIP TO

DEPARTMENT OF ADMINISTRATION
 GENERAL SERVICES DIVISION
 BUILDING 84 CORNERSTONE
 1409 GREENBRIER ST
 CHARLESTON WV
 25311 304-558-2317

DATE PRINTED	TERMS OF SALE	SHIP VIA	F.O.B.	FREIGHT TERMS
04/14/2010				

BID OPENING DATE: **05/13/2010** BID OPENING TIME **01:30PM**

LINE	QUANTITY	UOP	CAT NO	ITEM NUMBER	UNIT PRICE	AMOUNT
<p>() MAINTENANCE BOND: A TWO (2) YEAR MAINTENANCE BOND COVERING THE ROOFING SYSTEM WILL BE A REQUIREMENT OF THE SUCCESSFUL VENDOR.</p> <p>REV. 11/00</p> <p>EXHIBIT 7</p> <p>DOMESTIC ALUMINUM, GLASS & STEEL IN PUBLIC WORKS PROJECTS</p> <p>IN ACCORDANCE WITH WEST VIRGINIA CODE 5-19-1 ET., SEQ., EVERY CONTRACT FOR CONSTRUCTION, RECONSTRUCTION, ALTERATION, REPAIR, IMPROVEMENT OR MAINTENANCE OF PUBLIC WORKS, WHERE THE COST IS MORE THAN \$50,000 AND, IN THE CASE OF STEEL ONLY, WHERE THE COST OF STEEL IS MORE THAN \$50,000 OR WHERE MORE THAN 10,000 POUNDS OF STEEL ARE REQUIRED, THE STATE WILL ACCEPT ONLY ALUMINUM GLASS, OR STEEL PRODUCTS PRODUCED IN THE UNITED STATES. IN ADDITION, ITEMS OF MACHINERY OR EQUIPMENT PURCHASED FOR USE AT THE SITE OF PUBLIC WORKS SHALL BE MADE OF DOMESTIC ALUMINUM, GLASS OR STEEL, UNLESS THE COST OF THE PRODUCT IS LESS THAN \$50,000 OR LESS THAN 10,000 POUNDS OF STEEL ARE USED IN PUBLIC WORKS PROJECTS.</p> <p>FOREIGN MADE ALUMINUM, GLASS OR STEEL PRODUCTS MAY BE ACCEPTED ONLY IF THE COST OF DOMESTIC PRODUCTS IS FOUND TO BE UNREASONABLE. SUCH COST IS UNREASONABLE IF IT IS 20% OR MORE HIGHER THAN THE BID PRICE FOR FOREIGN MADE PRODUCTS. IF THE DOMESTIC ALUMINUM, GLASS OR STEEL PRODUCTS TO BE SUPPLIED OR PRODUCED IN A "SUBSTANTIAL LABOR SURPLUS AREA", AS DEFINED BY THE UNITED STATES DEPARTMENT OF LABOR, FOREIGN PRODUCTS MAY BE SUPPLIED ONLY IF DOMESTIC PRODUCTS ARE 30% OR MORE HIGHER IN</p>						

SEE REVERSE SIDE FOR TERMS AND CONDITIONS

SIGNATURE	TELEPHONE	DATE
<i>[Signature]</i>	304-533-9990	4-30-2010
TITLE	FEIN	ADDRESS CHANGES TO BE NOTED ABOVE
Govmt Rep	58-1814102	

WHEN RESPONDING TO RFQ, INSERT NAME AND ADDRESS IN SPACE ABOVE LABELED 'VENDOR'



State of West Virginia
 Department of Administration
 Purchasing Division
 2019 Washington Street East
 Post Office Box 50130
 Charleston, WV 25305-0130

Request for Quotation

RFO NUMBER
GSD106457

PAGE
6

ADDRESS CORRESPONDENCE TO ATTENTION OF:
**KRISTA FERRELL
 304-558-2596**

RFQ COPY
 TYPE NAME/ADDRESS HERE

SUPPORT

SHIP TO

DEPARTMENT OF ADMINISTRATION
 GENERAL SERVICES DIVISION
 BUILDING 84 CORNERSTONE
 1409 GREENBRIER ST
 CHARLESTON WV
 25311 304-558-2317

DATE PRINTED	TERMS OF SALE	SHIP VIA	FOB	FREIGHT TERMS
04/14/2010				

BID OPENING DATE: **05/13/2010** BID OPENING TIME **01:30PM**

LINE	QUANTITY	UOP	CAT NO	ITEM NUMBER	UNIT PRICE	AMOUNT
<p>PRICE THAN THE FOREIGN MADE PRODUCTS.</p> <p>IF, PRIOR TO THE AWARD OF A CONTRACT UNDER THE ABOVE PROVISIONS, THE SPENDING OFFICER OF THE SPENDING UNIT DETERMINES THAT THERE EXISTS A BID FOR LIKE FOREIGN ALUMINUM, GLASS OR STEEL THAT IS REASONABLE AND LOWER THAN THE LOWEST BID DOMESTIC PRODUCTS, THE SPENDING OFFICE MAY REQUEST, IN WRITING, A REEVALUATION AND REDUCTION IN THE LOWEST BID FOR SUCH DOMESTIC PRODUCTS. ALL VENDORS MUST INDICATE IN THEIR BID IF THEY ARE SUPPLYING FOREIGN ALUMINUM, GLASS OR STEEL.</p> <p>REV. 3/88</p> <p>EXHIBIT 9</p> <p>NOTICE FOR ISSUANCE & ACKNOWLEDGEMENT OF CONSTRUCTION PROJECT ADDENDA</p> <p>THE ARCHITECT/ENGINEER AND/OR AGENCY SHALL BE REQUIRED TO ABIDE BY THE FOLLOWING SCHEDULE IN ISSUING CONSTRUCTION PROJECT ADDENDA FOR STATE AGENCIES:</p> <p>(1) THE ARCHITECT/ENGINEER SHALL PREPARE THE ADDENDUM AND A LIST OF ALL PARTIES THAT HAVE PROCURED DRAWINGS AND SPECIFICATIONS FOR THE PROJECT. THE ADDENDUM AND LIST SHALL BE FORWARDED TO THE BUYER IN THE STATE PURCHASING DIVISION. THE ARCHITECT/ENGINEER SHALL ALSO SEND A COPY OF THE ADDENDUM TO THE STATE AGENCY FOR WHICH THE CONTRACT IS ISSUED.</p> <p>(2) THE BUYER SHALL SEND THE ADDENDUM TO ALL INTERESTED PARTIES AND, IF NECESSARY, EXTEND THE BID OPENING DATE. ANY ADDENDUM SHOULD BE RECEIVED BY THE BUYER WITHIN FOURTEEN (14) DAYS PRIOR TO THE BID</p>						

SEE REVERSE SIDE FOR TERMS AND CONDITIONS

SIGNATURE: *[Signature]* TELEPHONE: **304 533-9990** DATE: **4-30-2010**

TITLE: **Govmt Rep** FEIN: **581814108** ADDRESS CHANGES TO BE NOTED ABOVE

WHEN RESPONDING TO RFQ, INSERT NAME AND ADDRESS IN SPACE ABOVE LABELED 'VENDOR'



State of West Virginia
 Department of Administration
 Purchasing Division
 2019 Washington Street East
 Post Office Box 50130
 Charleston, WV 25305-0130

Request for Quotation

RFO NUMBER
GSD106457

PAGE
7

ADDRESS CORRESPONDENCE TO ATTENTION OF
**KRISTA FERRELL
 304-558-2596**

RFQ COPY
 TYPE NAME/ADDRESS HERE

DEPARTMENT OF ADMINISTRATION
 GENERAL SERVICES DIVISION
 BUILDING 84 CORNERSTONE
 1409 GREENBRIER ST
 CHARLESTON WV
 25311 304-558-2317

DATE PRINTED	TERMS OF SALE	SHIP VIA	F.O.B.	FREIGHT TERMS
04/14/2010				

BID OPENING DATE: **05/13/2010** BID OPENING TIME **01:30PM**

LINE	QUANTITY	UOP	CAT NO	ITEM NUMBER	UNIT PRICE	AMOUNT
	<p>OPENING DATE.</p> <p>(3) ALL ADDENDA SHOULD BE FORMALLY ACKNOWLEDGED BY ALL BIDDERS AND SUBMITTED TO THE STATE PURCHASING DIVISION. THE SAME RULES AND REGULATIONS THAT APPLY TO THE ORIGINAL BIDDING DOCUMENT SHALL ALSO APPLY TO AN ADDENDUM DOCUMENT. THE ONLY EXCEPTION MAY BE FOR AN ADDENDUM THAT IS ISSUED FOR THE SOLE PURPOSE OF CHANGING A BID OPENING TIME AND/OR DATE.</p> <p>REV. 11/96</p> <p>EXHIBIT 10</p> <p>ADDENDUM ACKNOWLEDGEMENT</p> <p>I HEREBY ACKNOWLEDGE RECEIPT OF THE FOLLOWING CHECKED ADDENDUM(S) AND HAVE MADE THE NECESSARY REVISIONS TO MY PROPOSAL, PLANS AND/OR SPECIFICATION, ETC.</p> <p>ADDENDUM NOS.:</p> <p>NO. 1</p> <p>NO. 2</p> <p>NO. 3</p> <p>NO. 4</p> <p>NO. 5</p> <p>I UNDERSTAND THAT FAILURE TO CONFIRM THE RECEIPT OF THE ADDENDUM(S) MAY BE CAUSE FOR REJECTION OF THE BIDS.</p>					

SEE REVERSE SIDE FOR TERMS AND CONDITIONS

SIGNATURE: *[Signature]* TELEPHONE: 304-533-9990 DATE: 4/30/2010

TITLE: Govt Rep FEIN: 58-1814102 ADDRESS CHANGES TO BE NOTED ABOVE

WHEN RESPONDING TO RFQ, INSERT NAME AND ADDRESS IN SPACE ABOVE LABELED 'VENDOR'



State of West Virginia
 Department of Administration
 Purchasing Division
 2019 Washington Street East
 Post Office Box 50130
 Charleston, WV 25305-0130

Request for Quotation

RFQ NUMBER
GSD106457

PAGE
8

ADDRESS CORRESPONDENCE TO ATTENTION OF
**KRISTA FERRELL
 304-558-2596**

RFQ COPY
 TYPE NAME/ADDRESS HERE

VENDOR

SHIP TO

DEPARTMENT OF ADMINISTRATION
 GENERAL SERVICES DIVISION
 BUILDING 84 CORNERSTONE
 1409 GREENBRIER ST
 CHARLESTON WV
 25311 304-558-2317

DATE PRINTED	TERMS OF SALE	SHIP VIA	F.O.B.	FREIGHT TERMS
04/14/2010				

BID OPENING DATE: **05/13/2010** BID OPENING TIME **01:30PM**

LINE	QUANTITY	UQP	CAT. NO.	ITEM NUMBER	UNIT PRICE	AMOUNT
<p>VENDOR MUST CLEARLY UNDERSTAND THAT ANY VERBAL REPRESENTATION MADE OR ASSUMED TO BE MADE DURING ANY ORAL DISCUSSION HELD BETWEEN VENDOR'S REPRESENTATIVES AND ANY STATE PERSONNEL IS NOT BINDING. ONLY THE INFORMATION ISSUED IN WRITING AND ADDED TO THE SPECIFICATIONS BY AN OFFICIAL ADDENDUM IS BINDING.</p> <p><i>Ronnie J. Beller</i> SIGNATURE <i>ADT SECURITY SERVICES</i> COMPANY <i>4-30-2010</i> DATE</p> <p>REV. 11/96</p> <p>CONTRACTORS LICENSE</p> <p>WEST VIRGINIA STATE CODE 21-11-2 REQUIRES THAT ALL PERSONS DESIRING TO PERFORM CONTRACTING WORK IN THIS STATE MUST BE LICENSED. THE WEST VIRGINIA CONTRACTORS LICENSING BOARD IS EMPOWERED TO ISSUE THE CONTRACTORS LICENSE. APPLICATIONS FOR A CONTRACTORS LICENSE MAY BE MADE BY CONTACTING THE WEST VIRGINIA DIVISION OF LABOR CAPITOL COMPLEX, BUILDING 3, ROOM 319, CHARLESTON, WV 25305. TELEPHONE: (304) 558-7890.</p> <p>WEST VIRGINIA STATE CODE 21-11-11 REQUIRES ANY PROSPECTIVE BIDDER TO INCLUDE THE CONTRACTORS LICENSE NUMBER ON THEIR BID.</p> <p>BIDDER TO COMPLETE: CONTRACTORS NAME: ... <i>ADT SECURITY SERVICES</i></p>						

SEE REVERSE SIDE FOR TERMS AND CONDITIONS			
SIGNATURE <i>[Signature]</i>	TELEPHONE <i>304 533 9990</i>	DATE <i>4-30-2010</i>	
TITLE <i>Govmt. Rep.</i>	FEIN <i>581814102</i>	ADDRESS CHANGES TO BE NOTED ABOVE	

WHEN RESPONDING TO RFQ, INSERT NAME AND ADDRESS IN SPACE ABOVE LABELED 'VENDOR'



State of West Virginia
 Department of Administration
 Purchasing Division
 2019 Washington Street East
 Post Office Box 50130
 Charleston, WV 25305-0130

Request for Quotation

RFC NUMBER
GSD106457

PAGE
9

ADDRESS CORRESPONDENCE TO ATTENTION OF
**KRISTA FERRELL
 304-558-2596**

RFQ COPY
 TYPE NAME/ADDRESS HERE

V
E
N
D
O
R

S
U
P
P
L
I
E
R

DEPARTMENT OF ADMINISTRATION
 GENERAL SERVICES DIVISION
 BUILDING 84 CORNERSTONE
 1409 GREENBRIER ST
 CHARLESTON WV
 25311 304-558-2317

DATE PRINTED	TERMS OF SALE	SHIP VIA	FOB	FREIGHT TERMS
04/14/2010				

BID OPENING DATE: **05/13/2010** BID OPENING TIME **01:30PM**

LINE	QUANTITY	UOP	CAT NO	ITEM NUMBER	UNIT PRICE	AMOUNT
(X)				WV 014142		
<p>CONTRACTORS LICENSE NO.:</p> <p>THE SUCCESSFUL BIDDER WILL BE REQUIRED TO FURNISH A COPY OF THEIR CONTRACTORS LICENSE PRIOR TO ISSUANCE OF A PURCHASE ORDER/CONTRACT</p> <p>APPLICABLE LAW</p> <p>THE WEST VIRGINIA STATE CODE, PURCHASING DIVISION RULES AND REGULATIONS, AND THE INFORMATION PROVIDED IN THE "REQUEST FOR QUOTATION" ISSUED BY THE PURCHASING DIVISION IS THE SOLE AUTHORITY GOVERNING THIS PROCUREMENT.</p> <p>ANY INFORMATION PROVIDED IN SPECIFICATION MANUALS, OR ANY OTHER SOURCE, VERBAL OR WRITTEN, WHICH CONTRADICTS OR ALTERS THE INFORMATION PROVIDED FROM THE SOURCES AS DESCRIBED IN THE ABOVE PARAGRAPH IS VOID AND OF NO EFFECT.</p> <p>BANKRUPTCY: IN THE EVENT THE VENDOR/CONTRACTOR FILES FOR BANKRUPTCY PROTECTION, THE STATE MAY DEEM THE CONTRACT NULL AND VOID, AND TERMINATE SUCH CONTRACT WITHOUT FURTHER ORDER.</p> <p>REV. 5/2009</p> <p>NOTICE</p> <p>A SIGNED BID MUST BE SUBMITTED TO:</p> <p>DEPARTMENT OF ADMINISTRATION PURCHASING DIVISION BUILDING 15</p>						

SEE REVERSE SIDE FOR TERMS AND CONDITIONS

SIGNATURE <i>[Signature]</i>	TELEPHONE 304-533-9990	DATE 4-30-2010
TITLE Govmt Rep	FEIN 581814102	ADDRESS CHANGES TO BE NOTED ABOVE

WHEN RESPONDING TO RFQ, INSERT NAME AND ADDRESS IN SPACE ABOVE LABELED 'VENDOR'



State of West Virginia
 Department of Administration
 Purchasing Division
 2019 Washington Street East
 Post Office Box 50130
 Charleston, WV 25305-0130

Request for Quotation

RFQ NUMBER
GSD106457

PAGE
1

ADDRESS CORRESPONDENCE TO ATTENTION OF
**KRISTA FERRELL
 304-558-2596**

VENDOR

***709062556 01 304-206-3051
 ADT SECURITY SYSTEMS INC
 2800 7TH AVE STE 100
 CHARLESTON WV 25312**

SHIP TO

**DEPARTMENT OF ADMINISTRATION
 GENERAL SERVICES DIVISION
 BUILDING 84 CORNERSTONE
 1409 GREENBRIER ST
 CHARLESTON WV
 25311 304-558-2317**

DATE PRINTED	TERMS OF SALE	SHIP VIA	F.O.B.	FREIGHT TERMS
05/06/2010				

BID OPENING DATE: **05/13/2010** BID OPENING TIME **01:30PM**

LINE	QUANTITY	UOP	CAT NO	ITEM NUMBER	UNIT PRICE	AMOUNT
<p>ADDENDUM NO. 3</p> <p>THIS ADDENDUM IS ISSUED TO ANSWER THE TECHNICAL QUESTIONS PER THE ATTACHED.</p> <p>BID OPENING DATE REMAINS: 05/13/2010 BID OPENING TIME REMAINS: 1:30 PM</p> <p>***** END ADDENDUM NO. 3 *****</p>						
0001	1	LS		936-73		19,102.84
<p>SECURITY SYSTEM INSTALLATION, BLDG#84, CORNERSTONE</p>						
<p>***** THIS IS THE END OF RFQ GSD106457 ***** TOTAL:</p>						19,102.84

SEE REVERSE SIDE FOR TERMS AND CONDITIONS

SIGNATURE  TELEPHONE **304 533-9990** DATE **4.30.2010**

TITLE **Government Rep** FEIN **58-1814102** ADDRESS CHANGES TO BE NOTED ABOVE

WHEN RESPONDING TO RFQ, INSERT NAME AND ADDRESS IN SPACE ABOVE LABELED 'VENDOR'



State of West Virginia
 Department of Administration
 Purchasing Division
 2019 Washington Street East
 Post Office Box 50130
 Charleston, WV 25305-0130

WV PURCHASING AGENCY SECTION Fax 304-558-4115

Apr 30 2010 11:53am P001/002

request for
Quotation

RFQ NUMBER
GSD106457

PAGE
1

ADDRESS CORRESPONDENCE TO ATTENTION OF
**KRISTA FERRELL
 304-558-2596**

RFQ COPY
 TYPE NAME/ADDRESS HERE

RFQ COPY

RFQ COPY

DEPARTMENT OF ADMINISTRATION
 GENERAL SERVICES DIVISION
 BUILDING 84 CORNERSTONE
 1409 GREENBRIER ST
 CHARLESTON WV
 25311 304-558-2317

DATE PRINTED	TERMS OF SALE	SHIP VIA	FOB	FREIGHT TERMS
04/30/2010				

BID OPENING DATE: **05/13/2010** BID OPENING TIME **01:30PM**

LINE	QUANTITY	UOP	CAT NO	ITEM NUMBER	UNIT PRICE	AMOUNT
				ADDENDUM NO. 2		
				THIS ADDENDUM IS ISSUED TO:		
				1.) PROVIDE A COPY OF THE MANDATORY PRE-BID ATTENDEE LIST AND		
				2.) TO CLARIFY THE DATE FOR THE DEADLINE FOR TECHNICAL QUESTIONS AND THE BID OPENING DATE		
				DEADLINE FOR TECHNICAL QUESTIONS IS MAY 4, 2010 AT THE CLOSE OF BUSINESS		
				BID OPENING DATE IS MAY 13, 2010 AT 1:30 PM		
				***** END ADDENDUM NO. 2 *****		
0001	1	LS		936-73		
				SECURITY SYSTEM INSTALLATION, BLDG#84, CORNERSTONE		

SEE REVERSE SIDE FOR TERMS AND CONDITIONS			
SIGNATURE <i>Ron VanSibber</i>	TITLE Govt Rep	TELEPHONE 304-533-9990	DATE 4.30.2010
FEIN 58-1814102	ADDRESS CHANGES TO BE NOTED ABOVE		

WHEN RESPONDING TO RFQ, INSERT NAME AND ADDRESS IN SPACE ABOVE LABELED 'VENDOR'



State of West Virginia
 Department of Administration
 Purchasing Division
 2019 Washington Street East
 Post Office Box 50130
 Charleston, WV 25305-0130

Request for Quotation

RFQ NUMBER
GSD106457

PAGE
10

ADDRESS CORRESPONDENCE TO ATTENTION OF:
**KRISTA FERRELL
 304-558-2596**

RFQ COPY
 TYPE NAME/ADDRESS HERE

VENDOR

SHIP TO

DEPARTMENT OF ADMINISTRATION
 GENERAL SERVICES DIVISION
 BUILDING 84 CORNERSTONE
 1409 GREENBRIER ST
 CHARLESTON WV
 25311 304-558-2317

DATE PRINTED 04/14/2010	TERMS OF SALE	SHIP VIA	FOB	FREIGHT TERMS
BID OPENING DATE: 05/13/2010 BID OPENING TIME 01:30PM				

LINE	QUANTITY	UOP	CAT NO	ITEM NUMBER	UNIT PRICE	AMOUNT
				2019 WASHINGTON STREET, EAST CHARLESTON, WV 25305-0130		
				THE BID SHOULD CONTAIN THIS INFORMATION ON THE FACE OF THE ENVELOPE OR THE BID MAY NOT BE CONSIDERED: SEALED BID BUYER: KRISTA FERRELL-FILE 21 REQ. NO.: GSD106457 BID OPENING DATE: 05/13/2009 BID OPENING TIME: 1:30 PM PLEASE PROVIDE A FAX NUMBER IN CASE IT IS NECESSARY TO CONTACT YOU REGARDING YOUR BID: ----- PLEASE PRINT OR TYPE NAME OF PERSON TO CONTACT CONCERNING THIS QUOTE: <i>RON VANBIBBER 304-558-5339</i> -----		
				***** THIS IS THE END OF RFQ GSD106457 ***** TOTAL:		

SEE REVERSE SIDE FOR TERMS AND CONDITIONS

SIGNATURE *[Signature]* TELEPHONE **304 533-9980** DATE **4-30-2010**
 TITLE **Govmt Rep.** FEIN **58 1814102** ADDRESS CHANGES TO BE NOTED ABOVE

WHEN RESPONDING TO RFQ, INSERT NAME AND ADDRESS IN SPACE ABOVE LABELED 'VENDOR'

ADT SECURITY SERVICES, INC.
FACT SHEET UPDATED AS OF NOVEMBER 2, 2007

Incorporated: Wilmington, Delaware (New Castle County) on October 20, 1988 under the name of ADT Security Systems, Mid-South, Inc. which was changed to ADT Security Services, Inc. [See Former Names below]

Corporate Headquarters: One Town Center Road, Boca Raton, FL 33486-1010
PO Box 5035, Boca Raton, FL 33486-5035
Phone: (561) 988-3600; Fax: (561) 988-3892

Description of Business: Provider of electronic security services since 1874.

Taxpayer ID: 58-1814102

North American Industry Classification System ("NAICS") * Replaces "SIC": 561621 Security Alarm Systems → sales, installation, monitoring, maintenance.
561612 Security Guard/Patrol Services

D&B #: 19-657-8736

Customers: More than 6,000,000 customers in North America.
Employees: Approximately 21,000 in the United States of America.

Former Names: **ADT Security Systems, Mid South, Inc. name was changed to ADT Security Systems, Inc. on 6/09/1995 – then name changed to ADT Security Services, Inc. on 12/18/1996**
The following represent some of the larger acquisitions and/or mergers made by ADT:
* Sensormatic Electronics Corporation (integration of sales and service business effective 12/31/01)
* Edison Select (merger effective 10/31/2001)
* SecurityLink, Inc. (merger effective 12/21/2001)
* Holmes Protection Group, Inc. (merger effective 03/22/1999)
* Wells Fargo Alarm Services, Inc. (merger effective 02/18/1999)
* ADT Limited merged with Tyco International Ltd (07/02/1997)
* The Alert Centre, Inc. (merger effective 12/18/1996)
* ADT Security Systems, Mountain West, Inc., ... Northeast, Inc., ... Southwest, Inc., ... Mid-South, Inc. (merger effective 06/09/1995)

Key Officers: John B. Koch, President
Mark N. Edoff, Vice President
John S. Jenkins, Jr., Secretary
Kevin MacKay, Treasurer
N. David Bleisch, Vice President and Assistant Secretary

Directors: Bruce Ramo, Director
John B. Koch, Director
N. David Bleisch, Director

Insurance Company: J. H., Marsh McClennan
1166 Avenue of the Americas, New York, NY 10036

Bonding Company: Willis of New York, Inc., One World Financial Center, 200 Liberty
Street 6th Floor, New York, NY 10281
Representative: Patricia O'Connell; Telephone: 212-915-8072; Fax: 212-
519-5443
Bonding Limit: Single Project \$100,000,000 – Aggregate \$275,000,000
Bond Rating: A++

Parent: ADT General Holdings, Inc.
Incorporated in Delaware on 12/21/1989; D&B #: 618399778
Tax Payer ID #: 13-3554684

Registered Agent: C T Corporation System (nationwide)

Business Licenses: A list of licenses held for a specific region is available upon request.

Professional Memberships: National Fire Protection Association
National Association of Security & Investigative Regulators
National Burglar and Fire Alarm Association
Security Industry Association
Central Station Alarm Association (CSAA)

Address for Payment: ADT Security Services, Inc., Shared Accounts Services, 14200 E.
Exposition Avenue, Aurora, CO 80012

Stock: ADT Security Services, Inc. is a wholly owned subsidiary of its ultimate
indirect parent, Tyco International, Ltd., a publicly held corporation
formed in Bermuda trading on the Bermuda, London and New York
Stock Exchanges. At record date August 9, 2005 there were
2,022,625,736 and 2,009,867,009 shares of Tyco common stock
outstanding, net of 4,152,563 and 12,864,837 shares owned by
subsidiaries, respectively (see SEC Form 10-Q for quarter ended
08/09/05).

Financial Statements: Tyco International Ltd. files consolidated financial statements for its
operations. Therefore, a separate financial statement is not available for
any of its subsidiaries.



State of West Virginia
DRUG FREE WORKPLACE CONFORMANCE AFFIDAVIT
West Virginia Code §21-1D-5

STATE OF West Virginia

COUNTY OF KANAWHA, TO-WIT:

I, Steven Bethel, after being first duly sworn, depose and state as follows:

1. I am an employee of ADT Security Services; and,
(Company Name)

2. I do hereby attest that ADT Security Services
(Company Name)

maintains a valid written drug free workplace policy and that such policy is in compliance with **West Virginia Code §21-1D-5**.

The above statements are sworn to under the penalty of perjury.

ADT Security Services
(Company Name)

By: Steven Bethel

Title: Commercial Sales Manager

Date: 4-24-2010

Taken, subscribed and sworn to before me this 24 day of APRIL.

By Commission expires February 13, 2012

(Seal)

Emilie Cook
(Notary Public)

THIS AFFIDAVIT MUST BE SUBMITTED WITH THE BID IN ORDER TO COMPLY WITH WV CODE PROVISIONS. FAILURE TO INCLUDE THE AFFIDAVIT WITH THE BID SHALL RESULT IN DISQUALIFICATION OF THE BID.

RFQ No. GSD 106457

STATE OF WEST VIRGINIA
Purchasing Division

PURCHASING AFFIDAVIT

West Virginia Code §5A-3-10a states: No contract or renewal of any contract may be awarded by the state or any of its political subdivisions to any vendor or prospective vendor when the vendor or prospective vendor or a related party to the vendor or prospective vendor is a debtor and the debt owned is an amount greater than one thousand dollars in the aggregate

DEFINITIONS:

"Debt" means any assessment, premium, penalty, fine, tax or other amount of money owed to the state or any of its political subdivisions because of a judgment, fine, permit violation, license assessment, defaulted workers' compensation premium, penalty or other assessment presently delinquent or due and required to be paid to the state or any of its political subdivisions, including any interest or additional penalties accrued thereon.

"Debtor" means any individual, corporation, partnership, association, Limited Liability Company or any other form or business association owing a debt to the state or any of its political subdivisions. "Political subdivision" means any county commission; municipality; county board of education; any instrumentality established by a county or municipality; any separate corporation or instrumentality established by one or more counties or municipalities, as permitted by law; or any public body charged by law with the performance of a government function or whose jurisdiction is coextensive with one or more counties or municipalities. "Related party" means a party, whether an individual, corporation, partnership, association, limited liability company or any other form or business association or other entity whatsoever, related to any vendor by blood, marriage, ownership or contract through which the party has a relationship of ownership or other interest with the vendor so that the party will actually or by effect receive or control a portion of the benefit, profit or other consideration from performance of a vendor contract with the party receiving an amount that meets or exceeds five percent of the total contract amount.

EXCEPTION: The prohibition of this section does not apply where a vendor has contested any tax administered pursuant to chapter eleven of this code, workers' compensation premium, permit fee or environmental fee or assessment and the matter has not become final or where the vendor has entered into a payment plan or agreement and the vendor is not in default of any of the provisions of such plan or agreement.

Under penalty of law for false swearing (*West Virginia Code §61-5-3*), it is hereby certified that the vendor affirms and acknowledges the information in this affidavit and is in compliance with the requirements as stated.

WITNESS THE FOLLOWING SIGNATURE

Vendor's Name: ADT Security Services

Authorized Signature: [Signature] Date: 4-24-2010

State of West Virginia

County of Kanawha, to-wit:

Taken, subscribed, and sworn to before me this 14 day of APRIL, 2010.

My Commission expires February 13, 2012.

AFFIX SEAL HERE

NOTARY PUBLIC [Signature]

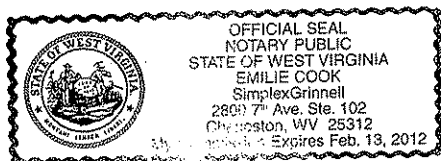

**REQUEST FOR QUOTATIONS
#GSD106457
SECURITY SYSTEM INSTALLATION
WV Department of Administration
Building #84 – Cornerstone Building**

ADDENDUM #3

TECHNICAL QUESTIONS & ANSWERS

Question #1: What is the scope of services required for this RFP (sic)? Install, maintenance, management, etc.

Answer#1: To provide and install the specified equipment. No maintenance or management is required; the required warranty is specified in the RFQ.

Question#2: How many cameras? IP cameras? PTZ cameras? Fixed cameras? HD cameras?

Answer#2: Only one (1) fixed camera, installed above call station in vestibule for wide angle viewing by release station monitors at the four (4) designated locations. Camera shall be able to allow viewing of entire vestibule without manipulating its motion.

Question#3: Are the cameras inside the building? And outside the building?

Answer#3: See RFQ and Question/Answer#2. The single camera to be installed is located **inside** the vestibule as indicated.

Question#4: Is there any current video system in place?

Answer#4: No.

Question#5: Based on the when the addendum will be released can the due date be changed?

Answer#5: This addendum does not change the bid opening date. It remains May 13, 2010 at 1:30pm

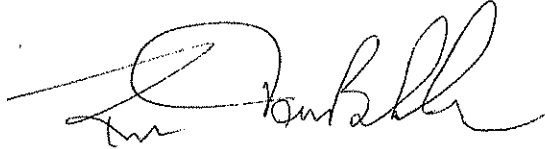
Revel

**RFQ#: GSD106457
Equipment List**

Please complete the below information concerning the brand(s) of equipment being bid in relation to this project. If bidding "equal" products, please attach manufacturer's literature (in the form of technical specification cut sheets) documenting the adherence to the mandatory requirements stated in the specifications. When applicable, please attach documentation of integration capability with Software Facility Commander WNX Version 7.0.

Equipment	Manufacturer	Model	Literature Attached
Access Card Readers (interior)	GE	7100	Yes
Access Card Reader (exterior)	GE	7100	Yes
Magnetic Locking Devices	SECURITRON	M-32	Yes
ADA Compliant Paddle Button	MEDICAL CLUM	4495 SFRQ	Yes
ADA Compliant Automatic Door Opener	MEDICAL CLUM	4300	Yes
Mechanical Combination Locks	TRILOG4	DL 2700	Yes
GB Ultraview Traditional Box Interior Fixed Cameras (Or Equal)	MATRIX	CD528/2	Yes
Video and Voice Communications Stations	AIRPHONE	GH1KD	Yes
CAMERA AVAILABLE AS A BOX OR DOME, Dome & Spec is Attached,			

Overview

The DirecDoor™ controller from GE Security is the industry's only 2-reader and 2-door Power over Ethernet (PoE) IP-connected access controller. DirecDoor integrates with GE's Facility Commander™ WNX, Secure Perfect®, and Picture Perfect™ access control and integrated security management software. It can utilize PoE or can be powered by a local power supply. It can even power the lock hardware in its PoE configuration. Its simple plug-in installation significantly reduces labor costs and allows new doors to be efficiently controlled using on-line access systems.

The DirecDoor controller is located on the secure side of the door, thereby providing a much better IP solution than an IP reader. Unlike a less secure IP reader solution, whose Ethernet port, card database and access to the door strike relay lie outside the protected area, the DirecDoor controller significantly reduces the possibility that security could be compromised.

Standard Features

- On board 2-readers with 2 door lock relays
 - Low cost and easy installation
- Support for Weigand and Supervised F/2F
 - Flexibility to use GE Security and other readers
- Intelligence at the edge of the network
 - Database, network connections and lock control connections at the secure side of the door
- PoE and local power supply support for controller and locks
 - Requires fewer terminations resulting in time savings, lower product and installation cost; back-up power for network also backs up controller and locks
- Fire panel alarm connection
 - For additional safety, the DirecDoor controller can be hard-wire connected to the fire alarm system to release door strikes
- Integrated configuration tool based on Web server
 - Remote configuration and ease of set up
- Lower total cost of ownership in low density door environment
 - Allows new doors to be controlled in a cost effective manner.
- Integrates with Facility Commander Wnx, Secure Perfect and Picture Perfect software.

DirecDoor

Power over Ethernet Enabled
Door Controller

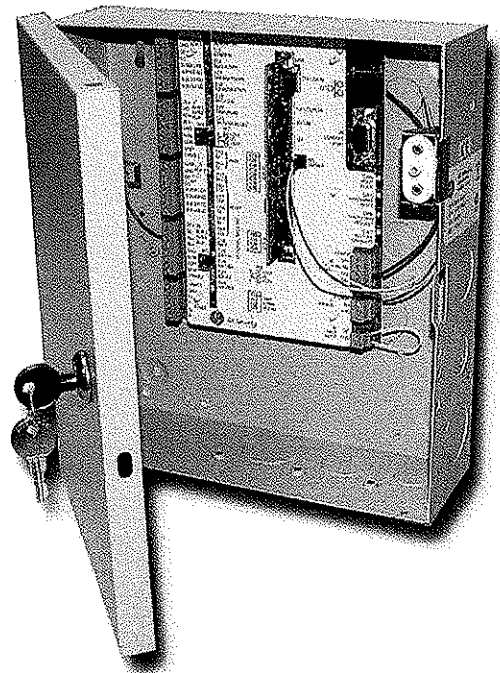

Application

The DirecDoor controller is a full-featured access controller with the feature set defined by the software platform. Up to two doors may be independently controlled. The DirecDoor controller provides connections for two readers (Weigand or Supervised F/2F), two door contacts, two Request-to-Exit (REX) devices and a total of two of either door-strike relays or magnetic lock(s) for a complete installation without the need for any additional expansion hardware.

DirecDoor is equally suitable for new construction or existing installations. On new installations, all doors requiring access control only need to be Ethernet wired. The reader wiring terminates at the door junction box which also functions as the controller. It is therefore only necessary to terminate the wiring once, as opposed to twice, as is required with most other access control systems.

DirecDoor is listed under UL 294, UL 1076, CE and FCC Part 15 Class A.

Associated Equipment*

The DirecDoor controller requires the following associated equipment (one or two of each depending on the number of doors to be controlled): Weigand or Supervised F/2F reader(s), door contact(s), REX device(s), door-strike(s) or magnetic lock(s).

Operation

The DirecDoor controller communicates via TCP/IP network to the host system. Backup communications can be implemented via plug-in dial-up modem. The DirecDoor controller is a fully intelligent controller. Badge database and configuration data is stored in non-volatile memory so the controller can lose power or Ethernet connection temporarily and still retain its database memory. The DirecDoor controller makes real-time access decisions and monitors for alarms.

Dimensions

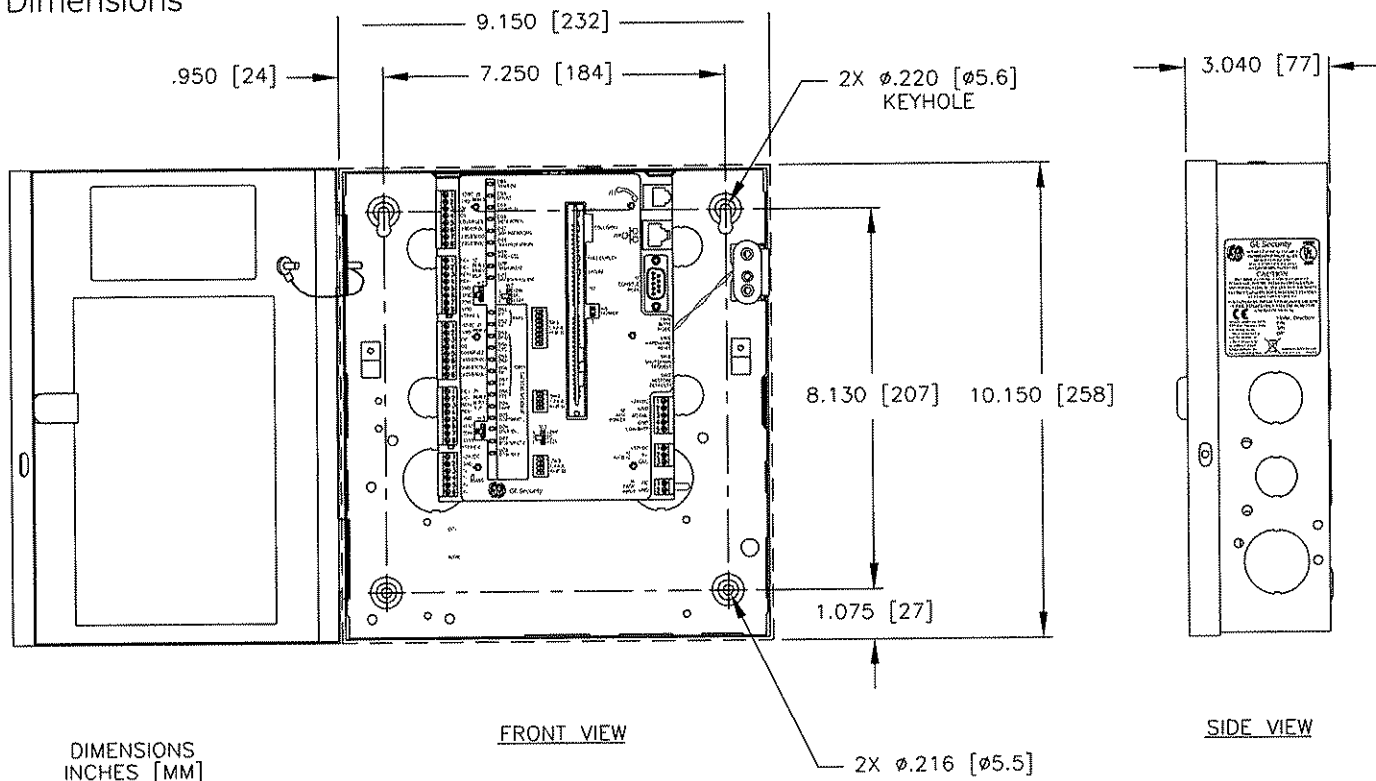

* Note: See power budget guidelines for other device capabilities. GE Security can provide a Power Budget Worksheet that can assist in determining if a PoE power supply or local 24 VDC power supply will be needed to power all the desired equipment.

Installation

Traditional Method

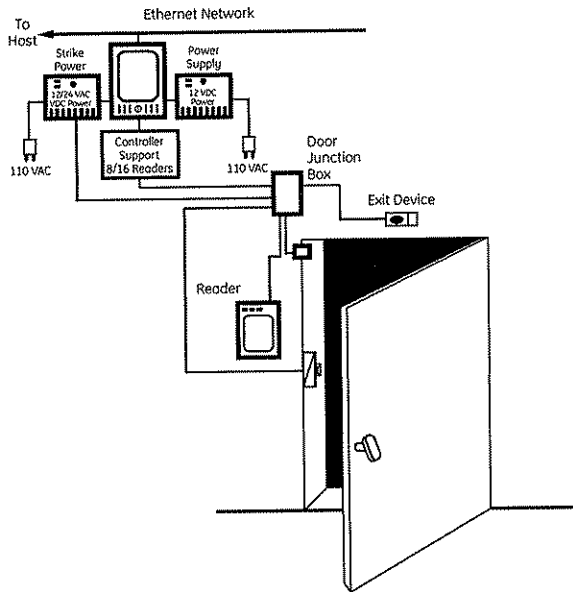

New Method

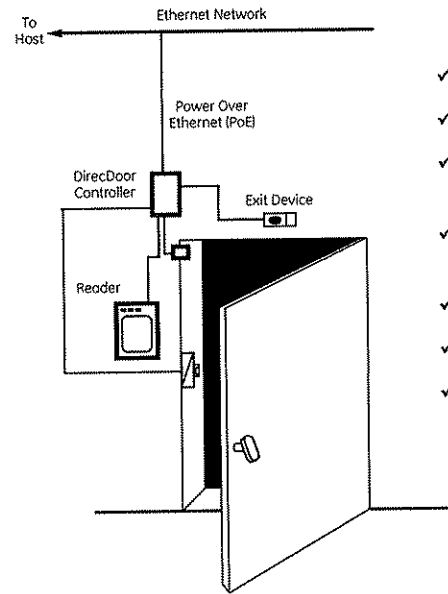

- ✓ Less equipment
- ✓ Fewer terminations
- ✓ Terminate devices once
- ✓ Less wiring (CAT-5 based)
- ✓ Edge of network
- ✓ Full intelligence
- ✓ PoE

Wiegand Wiring - 4 State

(for 2 State omit 1K resistors)

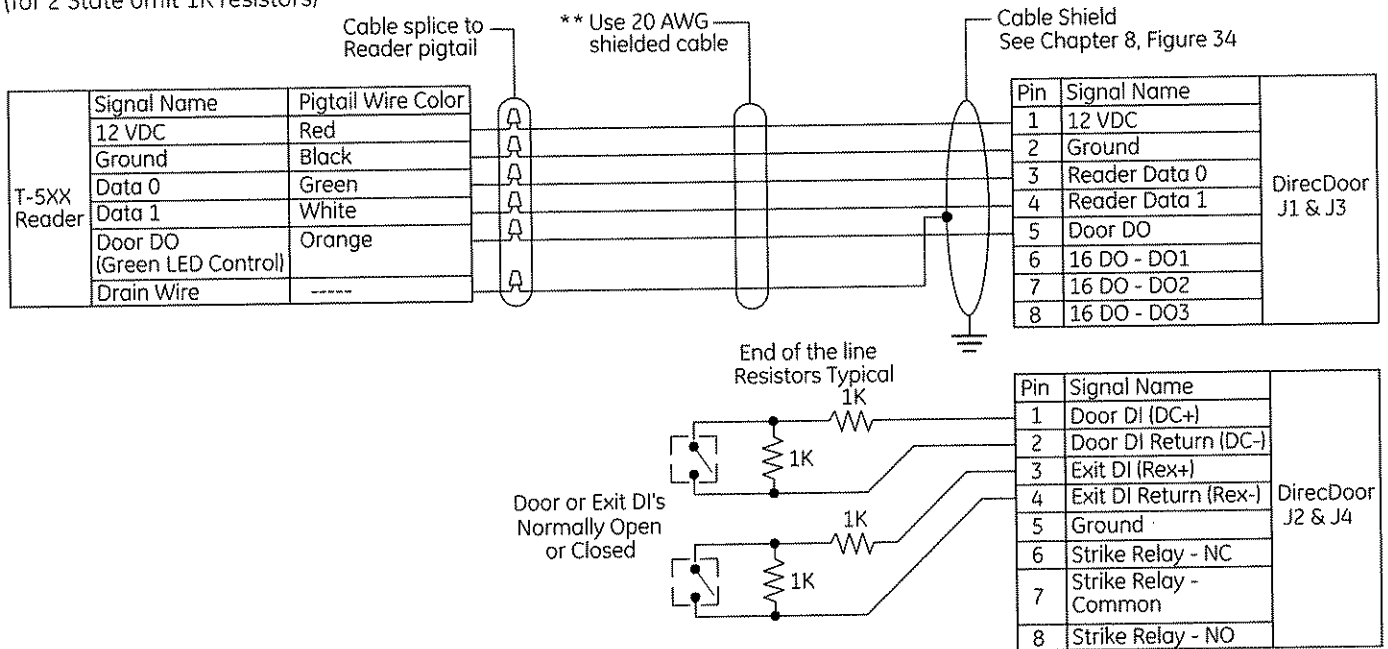

** Use plenum rated cable for applications where cable is to be run above the false (suspended ceiling) in the air circulation space.

GE Security

North America
T (561) 998-6100
T 888-GE-SECURITY
888-(437-3287)
F 561 998 6224
E rs-bctinfo@ge.com

Asia
T 852-2907-8108
F 852-2142-5063

Australia
T 61-3-9259-4700
F 61-3-9259-4799

Europe
T 32-2-725-11-20
F 32-2-721-40-47

Latin America
T 305-593-4301
F 305-593-4300

www.gesecurity.com

Specifications subject to change without notice.

©2007 General Electric Company
All Rights Reserved

Specifications

Enclosure Specifications	
Physical Dimensions (H X W X D)	10.15"x 9.15"x 3.04" (258mm x 232mm x 77mm)
Operating Environment	+35F to 122F, +2C to 50C
Humidity Range	5% to 95% non-condensing
Thermal air cooling	At least 6" (15.2cm) of clearance is required on all four sides
Field Configurable Options	Optional plug in modem as back-up communication via POTS line
Mounting	Screw mounts to wall

Communications Interfaces	
Network	10/100 MB Ethernet, on-board RJ-45 connection, TCP/IP, Supports Static IP or DNS and DHCP
Dial-up (fallback)	Plug-in modem card

CPU Specifications	
Operating System	uClinux
Processor	Xlinux
RAM	32 MB
Flash memory	8 MB

Applications supported and capacities	
Facility Commander Wnx v7.0 or later AND Secure Perfect v6.1.1 or later	
Badge capacity	100,000
Offline badge history capacity	8,192
Offline alarm history	8,192
Picture Perfect 4.x	
Badge capacity	145,000
Offline badge history	5,000***
Offline alarm history	2,000***
Picture Perfect 2.x	
Badge capacity	200,000
Offline badge history	5,000***
Offline alarm history	2,000***

*** This is default allocation. The capacity can be re-allocated using the Integrated Configuration Tool

Ordering Information

Part Number	Description
DD1FC	DirecDoor Controller, Facility Commander Wnx & Secure Perfect
DD1PP	DirecDoor Controller, Picture Perfect
521247001	Modem, daughter board plug-in, PXNplus CPU & DirecDoor. Field installation required.



imagination at work

GE Security

North America
T (561) 998-6100
T 888-GE-SECURITY
888-(437-3287)
F 561 998 6224
E rs-bctinfo@ge.com

Asia
T 852-2907-8108
F 852-2142-5063

Australia
T 61-3-9259-4700
F 61-3-9259-4799

Europe
T 32-2-725-11-20
F 32-2-721-40-47

Latin America
T 305-593-4301
F 305-593-4300

www.gesecurity.com

Specifications subject to change without notice.

© 2007 General Electric Company
All Rights Reserved

Dimensions

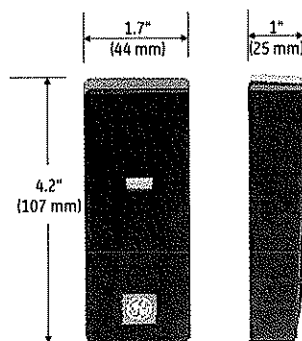

Intelligent Supervision

A Wiegand Interface Unit (WIU-2 or WIU-4) must be used if the Mini-Mullion readers are to be connected to an 8RP board or an M2000 controller. The Interface Units convert the reader's Wiegand data to supervised F/2F data format, and allows door contact and Request-to-Exit (REX) state changes to be communicated over the same four-conductor Belden 8723 type wire. This significantly reduces wiring requirements and allows continuously-monitored communication.

Specifications

	T-100	T-200
Frequency	125 kHz	13.56 MHz
Current Draw	Average 55 mA DC, Peak 167 mA DC	Average 55 mA DC, Peak 80 mA DC
Maximum Read Range	125 kHz = up to 3" (762 mm)*	13.56 MHz = up to 3" (762 mm)*
Compatibility	GE Security ProxLite, Entrée Prox, HID Proximity	ISO 15693: HID iClass, Inside Contactless PicoTag, ST Microelectronics, Texas Instruments Tag-IT, Phillips iCode ISO 14443A: Mifare, DESFIRE
Weight	0.55 lbs	0.50 lbs
Listings	UL 294, FCC, CE	
Physical Dimensions	1.72" (44 mm) W x 4.2" (107 mm) H x 1.0" (25.4 mm) D	
Temperature Range	-31° to +149° F (-35° to +65° C)	
Material	PBT Polymer GE Valox 364	
Color Options	Light Gray, Charcoal, or Black	
Input Power Range	5-16 VDC	
LEDs	Single, MultiColor	
Cabling Distance	Wiegand Output - 18 AWG: 500 ft (152 m); 22 AWG: 200 ft (60 m) Extended cable distance up to 3000' when using WIU-4 or WIU-2	
Recommended Cable	Minimum 22 AWG (18 AWG preferred) with 5 conductors, shielded	

*Maximum read range depends on credential type/form factor and installation conditions.

Ordering Information

Part Number	Description	Ship Wt.
430222001	Reader, T-100, Transition Series, Mini-Mullion, 125 kHz, Light Gray	0.55 lbs
430222002	Reader, T-100, Transition Series, Mini-Mullion, 125 kHz, Charcoal	0.55 lbs
430222003	Reader, T-100, Transition Series, Mini-Mullion, 125 kHz, Black	0.55 lbs
430223001	Reader, T-200, Transition Series, Mini-Mullion, 13.56 MHz, Light Gray	0.50 lbs
430223002	Reader, T-200, Transition Series, Mini-Mullion, 13.56 MHz, Charcoal	0.50 lbs
430223003	Reader, T-200, Transition Series, Mini-Mullion, 13.56 MHz, Black	0.50 lbs

Wiegand Interface Units

430187001	Wiegand Interface Unit: Two-State (WIU-2) Card
430160001	Wiegand Interface Unit: Four-State (WIU-4) Card



imagination at work

Overview

GE Transition™ Series Mini-Mullion readers offer the advantage of contactless technology in an extremely compact design. Their small size enables flexible, easy installation on walls, and mullions.

Mini-Mullion readers feature simultaneous compatibility with multi-vendor credential technologies. Two models are available:

- **Model 100** reads 125 kHz GE and HID proximity credentials, and outputs the badge encoded number
- **Model 200** reads 13.56 MHz Mifare and Vicinity credentials and outputs the card serial number

Both models communicate with the access control panel via the Wiegand data protocol. A tri-color LED indicates device is powered on or if a valid or invalid credential has been processed.

Standard Features

- High-reliability, consistent read-range performance, and low power consumption
- Proximity and Mifare/Vicinity compatible models available
- Compact design ideal for door frames and mullions, and installs on both metal and non-metal surfaces
- Sealed weather-resistant unit does not require a back box and is suitable for indoor or outdoor applications
- Tri-color LEDs and audible indication for status, alarm and tamper conditions

Application

With an optimization technology that adjusts to a wide range of installation environments, Transition Series Mini-Mullion readers are adaptable to any application. The reader's design accommodates both metal and non-metal environments, ensuring card-holders experience consistent read-range performance for all types of installations.

Mini-Mullion readers feature a compact design that makes them ideal for mounting on door frames and mullions. Their "potted" housings require no back box, and make them suitable for indoor and outdoor installation.

Model 100 provides reliable performance in applications using standard proximity technology, while Model 200 offers a direct migration path to Mifare and Vicinity smart card technologies.

Mini-Mullion Card Readers

Transition Series

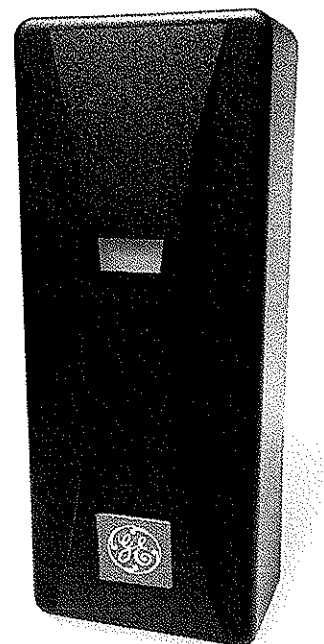

Home » Products » Cameras » A-CD5D2812UWCU; A-CDF5D2812UWC

Product Information

A-CD5 Series
A-CD5D2812UWCU; A-CDF5D2812UWC

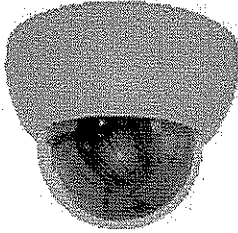

Product Literature

Spec Sheet



Manual



Description

The Super High Resolution A-CD5D and A-CV5D Day/Night camera series is the newest family of performance based digital color dome cameras featuring the ADT brand.

The A-CD5 and A-CV5 Day/Night series employs a 1/3-inch SONY Super HAD CCD for superior picture quality with 540 TV Lines of resolution. This SONY based CCD camera features excellent low light sensitivity of 0.5 lux (color) and 0.01 lux (black/white) with digital Day/Night capability.

The A-CD5T and A-CV5T TRUE Day/Night series employs a 1/3-inch SONY Super HAD Double-Scan CCD for superior picture quality with 580 TV Lines of resolution. This SONY based CCD camera features excellent low light sensitivity of 0.5 lux (color) and 0.04 lux (black/white) and 0.001 lux shutter) with TRUE Day/Night and Wide Dynamic Range capability.

The A-CD5 series is a compact interior vandal dome camera offered with a 2.8-12mm VF AI lens aesthetically pleasing high-impact white plastic case, with clear bubble for loss-less video imaging. Flush Mount (**CDF5D2812UWC**) or UTP (**CD5D2812UWCU**) (unshielded twisted pair) video transmission models are available.

The A-CV5 is a rugged exterior vandal dome camera offered with a 2.8-12mm VF AI lens in aesthetically pleasing white vandal resistant cast aluminum housing, with clear bubble for loss-less video imaging. Flush Mount, UTP (unshielded twisted pair) video transmission or TRUE D/N mode available and each exterior vandal dome camera includes a built-in 20W (24VAC) heater. The UTP cameras support the Network Video Technologies (NVT) protocol. TRUE D/N operation is accomplished using an optical IR block filter removal circuit.

The camera series offers an easy On Screen Display (OSD) for camera set up and programming, Digital Noise Reduction (DNR) which provides a clean video signal for digital video recording and more storage capacity, and Back-Light Compensation (BLC) adjustment.

The camera series is offered in surface and flush mount configurations determined by the actual number. The optional VDMWC mount is a versatile mount designed for ceiling and wall mount applications. The mount features an adjustable swivel head for camera positioning and a cable feed through hole to conceal the video and power cabling. The straight pendent drop down length is 10.2" The 90° pendent wall mount total drop down length is 10.2" with a wall offset of 8". The FDCAP is a back shell of the VDMWC. The FDCAP may be installed separately using customer supplied 1" NP or 3/4" EMT conduit with a 1" to 3/4" adapter.

Features

- 540TVL or 580TVL High Resolution CCD
- 2.8 - 12mm Day/Night AI Varifocal Lens
- Composite & UTP Video Outputs
- Low-Lux Operation

- ☑ Digital and TRUE Day/Night Models
- ☑ Wide Dynamic Range (TRUE D/N models)
- ☑ Wide Auto White Balance mode (TRUE D/N models)
- ☑ Digital Noise Reduction Function
- ☑ 4-Point Privacy Zone Masking
- ☑ Sense Up (2X – 32X) for extreme low light image capture
- ☑ Video Motion Detection (VMD)
- ☑ RS485 for remote operation
- ☑ 12VDC / 24VAC
- ☑ Test Monitor Output
- ☑ Interior Vandal or Exterior Vandal Housing
- ☑ 3-Axis Gimbal, Optional Wall, Pendent and Back-shell only Mounts
- ☑ Exterior Housing with Built-in Heater

Specifications

Video	
Image Sensor (D/N models)	1/3" SONY Super HAD CCD
Image Sensor (TRUE D/N models)	1/3" SONY Super HAD Double Scan CCD
Total Pixels	811 (H) x 508 (V)
Scanning System	2:1
Scanning Frequency	15.73KHz (H), 59.94Hz (V)
Sync. System	Internal / Line Lock
Electronic Shutter	1/60 ~ 1/120,000
Resolution (D/N models)	540TVL
Resolution (TRUE D/N models)	580TVL
Minimum Illumination (D/N models)	0.5 lux (color), 0.01 lux (B/W) @ F1.2, 50 IRE
Minimum Illumination (TRUE D/N models)	0.001 lux (slow shutter) @ F1.2, 50 IRE
Video Output	1.0Vp-p (75-ohm, composite)
S/N Ratio	> 50dB (AGC off)
Camera Control	Tactile Switch or A/D Key (TRUE D/N only)
Functions	
DNR	On
Auto Exposure	Auto / Flickerless / Manual
Shutter Speed	1/60 ~ 1/10,000 (1/100,000 TDN)
Lens	DC / ELC
Back Light Compensation (BLC) (D/N models)	On / Off
Back Light Compensation (BLC) (TRUE D/N models)	Top / Bottom / Center / Right / Left / Off
Auto Gain Control (AGC) (D/N models)	Off / Low / Middle / High
Auto Gain Control (AGC) (TRUE D/N models)	Auto
Sense Up	Off / x2 / x4 / x8 / x16 / x32
White Balance (WB) (D/N models)	ATW / AWC / Manual
White Balance (WB) (TRUE D/N models)	AWB / Indoor / Outdoor / Manual / WAWB
Day / Night	Auto / Day / Night
Video Motion Detection (VMD)	Off / On (Sensitivity & Alarm Time Selective)
Privacy Zone	Off / On (4 Point)
Display Title	Off / On (DISP 0 / DISP 1)
Video Picture	Positive / Negative
Brightness	0 ~ 60 (D/N), 0 ~ 255 (TDN)
Sharpness	0 ~ 15
Slow Shutter (TDN models)	X2 ~ x256 (13 steps)
Mirror (TDN models)	Normal / Mirror / Vertical / Rotate
Effects (TDN models)	V-Flip, Rotation, Mirror, D&N, D-Zoom, Negative/Positive B&W, Freeze, Privacy Zone, Motion Detection
Wide Dynamic Range	X128
D-Zoom	Off / On (x8) / Pan-Tilt (x2)
Sync	Internal / Auto
Preset	Initial / Exit (Auto Save) / Return
Connectors / Mechanical	

Power Input	2-pin Terminal Block
UTP Video Output	2 or 4-pin Terminal Block
Composite Video Output	BNC
Lens Mount	Fixed
Lens	2.8-12mm, F1.4 Varifocal, DC Auto Iris
Environmental	
Operating Temperature w/heater On	14°F ~ 122°F (-10°C ~ 50°C) -22°F (-30°C)
Operating Humidity	0~96% (non-condensing)
Heater Operation	On 41°F, Off 59°F (5°C, 15°C)
General	
Dimensions (Diameter x H)	
Interior Housing	Ø5.73 x 4.44 (H) in., Ø145.61 x 113 (H) mm
Vandal Housing	Ø5.76 x 4.47 (H) in, Ø146.31 x 113.7 (H) mm
Window (bubble)	0.1" (2.5mm) Impact-Resistant P.C. (Lexan) 3.93" (10cm diameter)
Cable Entry	1, 1", rear mount
Weight	
Interior Housing	0.88 lbs. (0.4kg)
Vandal Housing	1.54 lbs. (0.7kg)
Power	50W (12VDC, 4.2A)
Voltage	12VDC/24VAC
Power	3.5W, TRUE D/N 7.0W
Heater	20W (24VAC)
Approval	UL, CE, FCC, RoHS
Specifications are subject to change without notice.	

Accessories

Part Number	Description
DYK4500	4-channel Digital Video Recorder, 120-ips, USB archiving, mouse, IR
A-SDR402E	4-channel Digital Video Recorder, 120-ips, USB archiving, mouse
A-ADT800E	8-channel Digital Video Recorder, 120-ips, CDRW, USB archiving
A-ADT1600E	16-channel Digital Video Recorder, 120-ips, CDRW, USB archiving
A-XDP16E	16-channel Digital Video Recorder, 240-ips, DVDRW, USB archiving
ML757	17" LCD VGA-only, 1280 x 1024, black plastic case
ML970W	19" Wide LCD VGA-only, 1440 x 900, black plastic case
ML2200W	22" Wide LCD VGA-only, 1680 x 1050, black plastic case
M170CP2	17" LCD, VGA, BNC, SVHS, 1280 x 1024, black plastic case
M170CP2D	17" LCD, VGA, BNC, SVHS, 1280 x 1024, black plastic case
M190CP2	19" LCD, VGA, BNC, SVHS, 1280 x 1024, black plastic case
M190CP2D	19" LCD, VGA, BNC, SVHS, 1280 x 1024, black plastic case
A-MC1574FN	15" Color CRT, 500 TVL, 2-ch A/W, BNC, SVHS

GH-1KD / GH-1KDS**Audio/Video Tenant Station for the GH Series**

GH-1KD

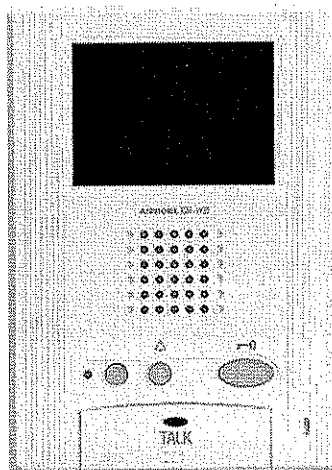

GH-1KDS

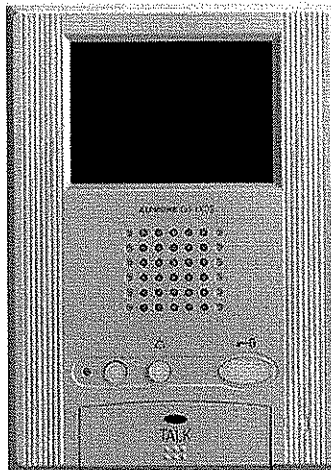
**DESCRIPTION:**

The GH-1KD(S) is an audio/video tenant station for the GH series Multi-Unit entry system. It is equipped with a Talk, Door Release, and optional service button. When a visitor calls, the tenant stations rings and video is present. The call is answered by one touch of the Talk button.

The GH-1KD(S) also has the capability of calling the Concierge/Security Guard stations(s), turning on a light while speaking with a visitor at the entrance, receiving an emergency tone from a panic call station, and releasing a door.

The GH-1KD(S) is designed to be surface mounted and has a slim, streamlined design. Up to four units can be used in the same tenant location (2 audio/video and 2 audio only).

Communication is hands-free at the entrance station when a tenant answers the call, and is either VOX hands-free or push-to-talk at the tenant station when speaking with the visitor.

FEATURES:

- Hands-free audio communication
- Door release to the door where communication is established
- Call to Security Guard / Concierge station
- Optional individual doorbell rings unique tone, notifying resident that someone is at their door.
- Optional activation of outside light while talking to entrance station
- Optional connection of panic call station (GFK-PS), alerting with tone and call to Concierge
- Entrance monitoring
- Separate volume controls for call tone and communication
- Optional handset for privacy for GH-1K D only (GH-HS)
- Simple 2 separate pair common bus wiring (2 conductor for audio, 2 conductor for video)
- Surface mounts to wall on 1-gang box or ring
- ABS plastic construction

GH-1KD / GH-1KDS

Audio/Video Tenant Station for GH Series

FEATURE CALL-OUTS:

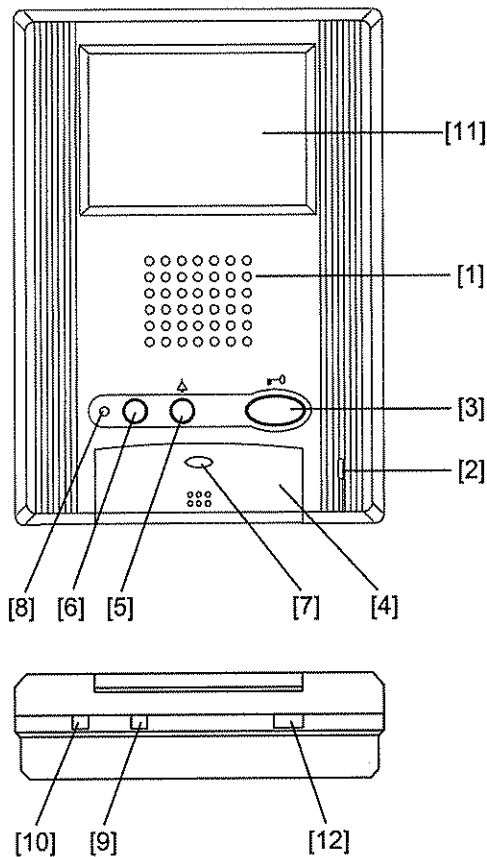

GH-1KD with optional desk stand:
Model MCW-S/A (adjustable to 45° or 60° angle)

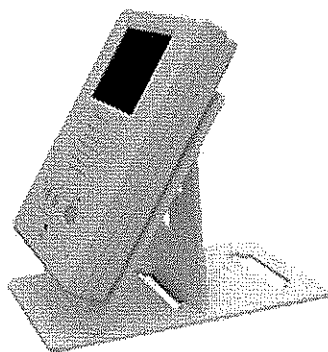

FEATURE CALL-OUT DEFINITIONS:

- [1] Speaker
- [2] Microphone
- [3] Door release button
- [4] Talk button
- [5] Light button / Security guard station call button
- [6] Service button (option)
The service button is standard equipment with the GH-1AD-SB.
- [7] Talk LED
- [8] Call tone off LED
- [9] Receive volume control
- [10] Call tone volume control
- [11] Video monitor 3.5 inch color LCD
- [12] Monitor brightness control

SPECIFICATIONS:

- Power Source: Supplied by system
- Call: Varying ring tones from entrance panel, concierge, or doorbell
- Communication: Hands-free (VOX) after TALK button is pressed once, or push-to-talk
- Capacity: Max. 4 tenant stations per resident location (2 Audio/Video, 2 audio only)
- Wire: Two 2-conductor cables, PE insulation, common bus
Audio Wire: Aiphone #872002
Video Wire: Aiphone #871802
- Wiring Distance: GH-VBC to farthest Tenant (Video line): 500' with 18AWG
- Talk Path: Single channel with privacy
- Color: GH-1KD - White
GH-1KDS - Silver
- Operating Temp: 32 – 104° F (0 ~ 40° C)
- Dimensions (HxWxD): 6-7/8" x 4-15/16" x 1-1/4"
(175 x 125 x 32 mm)
- Weight: 0.9 lbs (400g)

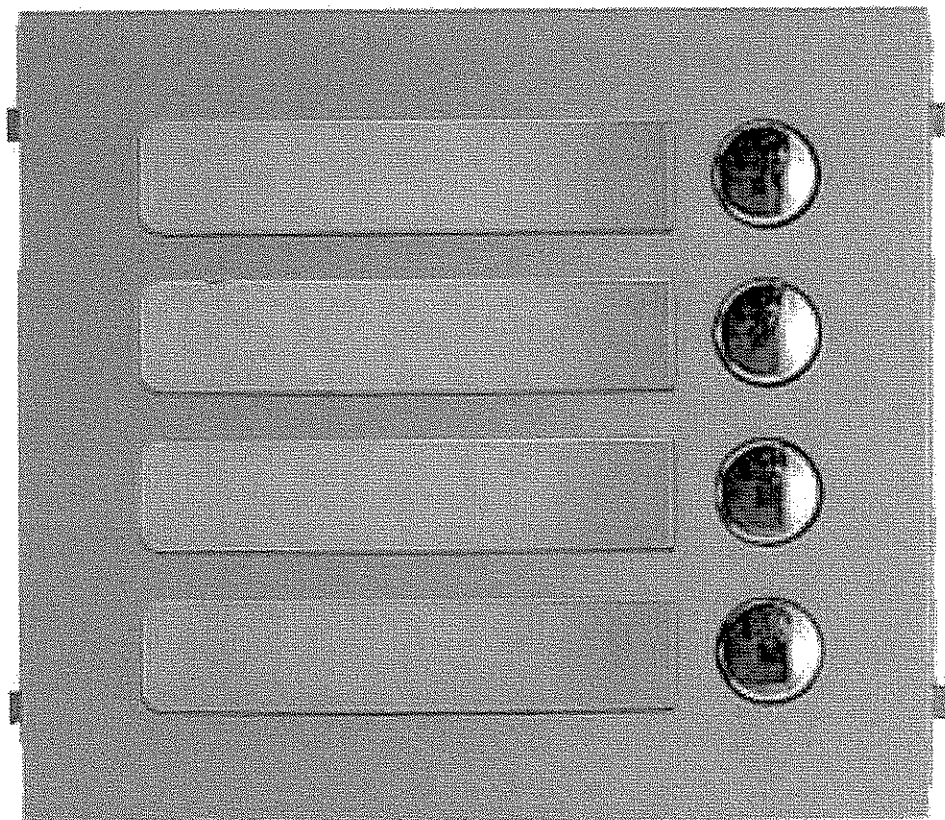

M32 Series

600 lbs. Holding Force Magnalock®

600 lbs. holding force Magnalock with automatic dual voltage. Recommended for applications where physical assault on the door is not expected, like access controlled interior rooms and secure areas within buildings.

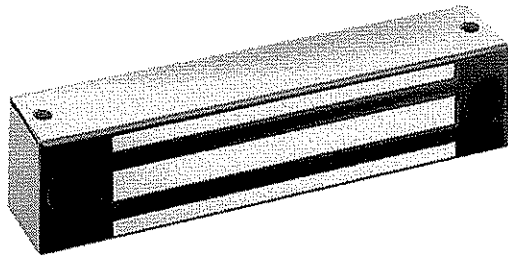

Features & Benefits

- Patented instant release circuit - no residual magnetism
- Surface mounts easily with a minimum of tools
- Fully sealed electronics - tamper proof and weatherproof
- Mounted using steel machine screws into blind finishing nuts
- Architectural brushed stainless steel finish (US32D/630)
- All ferrous metal surfaces plated to MIL specification
- Hardware accessories available to configure any opening type include mounting brackets, housings and dress covers
- Ten feet [3.05m] of jacketed, stranded conductor
- Lock options include BondSTAT magnetic bond sensor and integrated door position switch
- UL Listed

Specification Data

Holding Force: 600 lbs. [272 Kg.]
 Current Draw and Voltage: 300mA at 12VDC; 150mA at 24VDC
 Operating Temperature: -40 to +140F [-40 to +60C]
 Shipping Weight: 6 lbs.
 Warranty: MagnaCare Lifetime Replacement Warranty

How To Order

Part #	Description
M32	Magnalock Model 32
M32F	M32, Face Mount
M32FB	M32, Face Mount, Mag Bond Sensor
M32FBD	M32, Face Mount, Mag Bond Sensor, Door Position Switch
M32FD	M32, Face Mount, Door Position Switch
M32B	M32, Mag Bond Sensor
M32BD	M32, Mag Bond Sensor, Door Position Switch
M32D	M32, Door Position Switch

Optional M32 Brackets & Accessories

Prefix	Description
ASB	Aluminum Shim Bracket
SFP	Stop Filler Plate
CWB	Concrete Wood Bracket
UHB	Universal Header Bracket
HEB	Header Extension Bracket
GDB	Glass Door Bracket
ZA	Adjustable Z-Bracket Kit
DC	Dress Cover

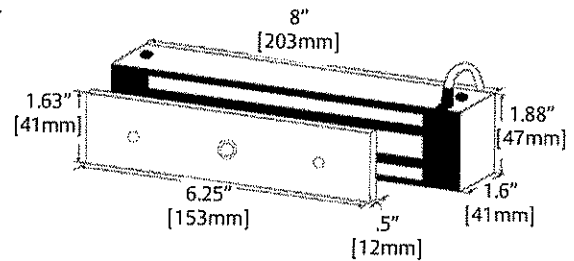
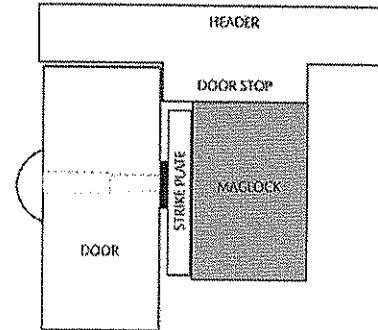

The M32 requires 2.25 inches of flat mounting space

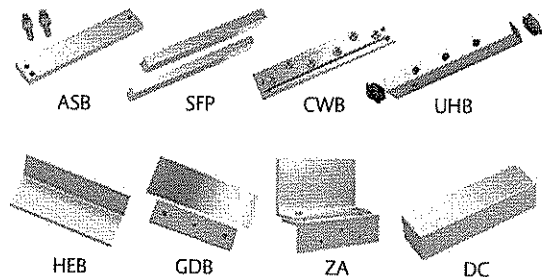

Brackets and Accessories for the M32 begin on page 15

Trilogy: DL2700



hospital



schools



airport



retail



pharmacy



office

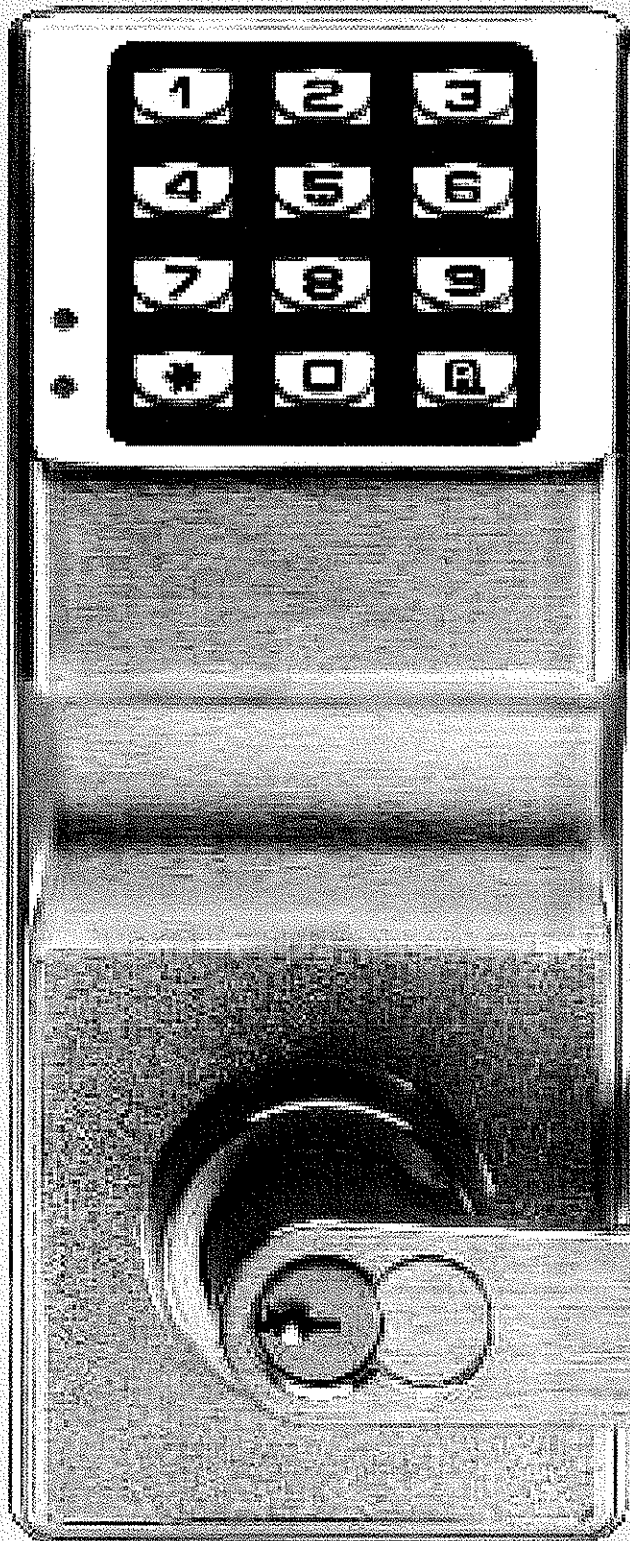

Our most popular standalone pushbutton cylindrical lock

Durable electronic digital locks available
in indoor and outdoor models

- **Grade 1 Durability.** Dependable lockset with rugged clutch mechanism, plus vandal-proof all metal keypad.
- **Multi-level user codes:** Master, 10 managers, 90 users, 3 service codes
- **Up to 100 different user codes** (3-5 digits)
- **100% keypad programmable** with a fingertip
- **Individual, group or total user lockout codes**
- **Easy passage mode** by manager and/or master
- **Easy to install in about an hour,** retrofits cylindrical knobsets and digital locks using slightly modified ANSI A115 Series Prep
- **Standalone battery operated;** uses 5 AA batteries
- **Key override.** All IC Core models include a large format key in knob cylinder, supporting Best, Falcon, Arrow and KSP. Other interchangeable core preps available: Yale, Medeco, Sargent, Corbin/Ruswin, Schlage
- **Non-handed** for easy installation and versatility
- **2-wire remote override** or key bypass capability
- **Visual and audible entry indicators**
- **WP Models for weatherproof performance,** water-sealed for use inside and out, with operational temperature range of +151°F to -31°F (+66°C to -35°C)

(Note: all Trilogy models are available in WP weatherproof and non-WP standard models for interior doors.)

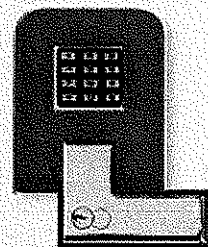

ALARM LOCK

OPERATION: Clutch mechanism permits turning lever without retracting latch and reduces stress on lock bodies and spindle. Outside lever free turning in locked position. Entering access code, key bypass, or remote bypass will allow lever to retract latch. Inside lever always instant egress.

DOOR THICKNESS: 1 5/8" to 1 7/8." Other thicknesses. Please consult Alarm Lock.

BACKSET: 2 3/4" Standard. 2 3/8" backset also available.

KEYPAD: All metal, 12 button programmable for multi-level access functions including group or individual user codes, master and management codes, passage and emergency or service code, lockout and remote override capability and allowable entry time from 5 to 20 seconds. 4 Different keypad tones and keypad may be silenced.

STANDARD KEY OVERRIDE CYLINDERS:

Solid brass 6 pin tumbler cylinder pinned 5, SC1 keyway, furnished in all locks. Additional tailpieces included: HW580 fits Schlage, Corbin/Ruswin CL, Sargent 480 Series, ASSA65-611. Model HW620 fits Ilco and Lori cylinders.

INTERCHANGEABLE CORE MODELS: Accepts 6 & 7 Pin Cylinders from: Best, Arrow, KSP, Medeco Keymark & Kaba Peaks. Also available IC Core models for Yale, Medeco, Sargent, Corbin/Ruswin CL and Schlage. Alarm Lock Tailpiece is supplied; IC Core is not included.

LATCHBOLT: UL Listed, fire rated, 3 hours, 1/2" throw, solid brass, deadlocking. Reversible. Adjustable front for flat or beveled doors.

STRIKE: 1 1/8" x 2 3/4" T strike & 1 1/4" x 4 7/8" ASA strike included. With screws for wood or metal jambs.

LATCH FRONT: 1 1/8" x 2 1/4" wrought brass or stainless steel.

HANDING: Non-handed.

FINISHES: US3 polished brass, US26D satin chrome, US26 polished chrome, US5 antique brass, 10B Duronodic.

POWER: 5 AA alkaline batteries are now rated at 120,000 cycles, supplied. Audible low battery alert, visual and audible entry indicators, unique Flex Drive® motor.

DOOR PREP: Standard ANSI A115 Series Prep, modified by adding additional through-bolt holes.

COMPLIANCES: Grade I, heavy duty cylindrical lockset, UL listed and FCC certified. ADA compliant leversets.

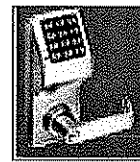
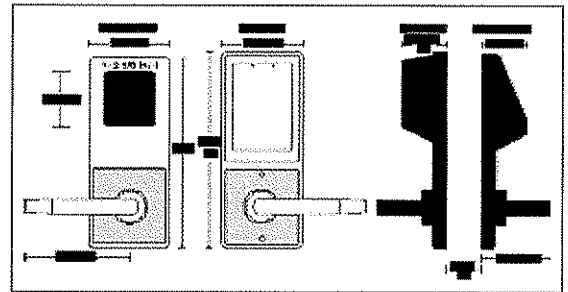

Lever set in US3 DL2700/3

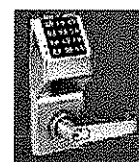

With IC Core in 26D DL2700IC/26D

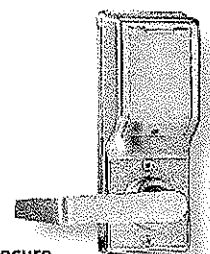

Secure battery compartment on inside door

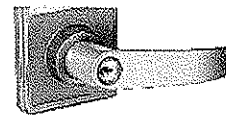

DL2775/26D



FREE step-by-step online Trilogy installation seminar available 24/7 (broadband & dial-up versions).

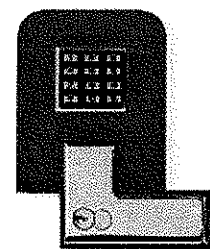

ALARM LOCK

345 Bayview Ave, Amityville, New York 11701
1-800-ALA-LOCK • Fax 631-789-3383

www.alarmlock.com

Trilogy is a trademark of Alarm Lock. © NAPCO 7/2005
Patents and Patents Pending ALA129F



DL 27 00 WP IC /26D -Y

Model & Series:

DL27 = Trilogy T2 Series

Trim:

00 = Lever

50 = Knob

75 = Regal Trim Lever

Exterior / Interior Use:

WP = Weatherproof for exterior use

(Note: No "WP" indicates standard, interior use.)

Cylinder:

IC = Standard Interchangeable Core

Prep for Best, Falcon, Arrow, KSP

(Note: No "IC" indicates standard

K.O. cylinder.)

Finish:

/3 = US3 Polished Brass

/26 = US26 Polished Chrome

/26D = US26D Satin Chrome

/5 = US5 Antique Brass

/10B = Duronodic

Special Order IC Prep:

-Y = Yale

-M = Medeco

-R = Sargent

-C = Corbin/Ruswin

-S = Schlage (requires Regal Trim 75)



Open Doors for Everyone

Almost Anywhere

2300

**Residential
Automatic
Door Opener**

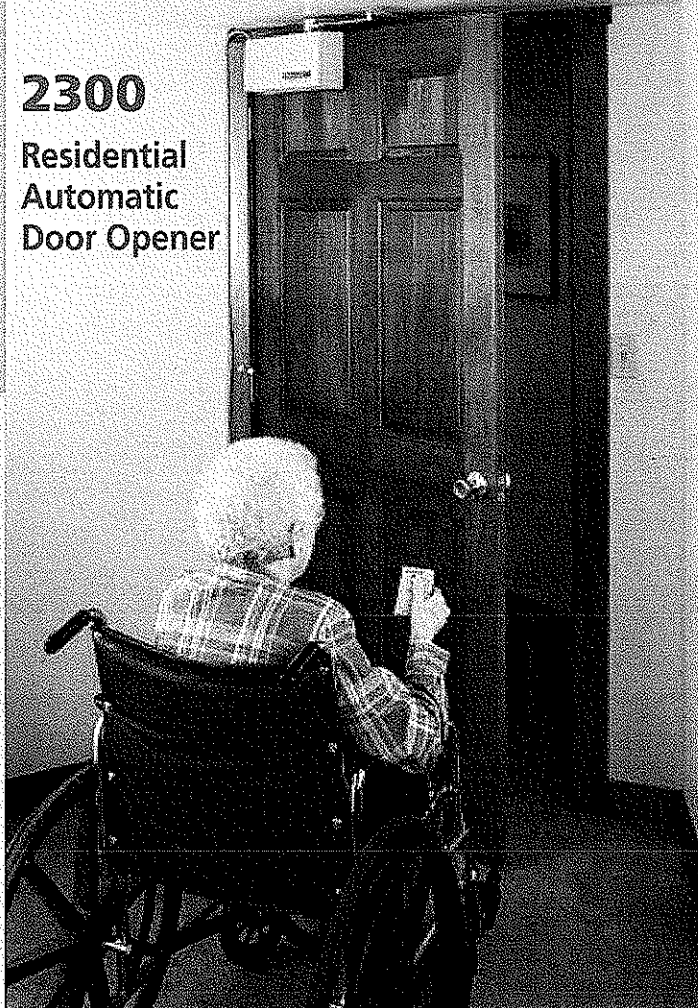

Power Access automatic door openers go almost anywhere. Now, the 2300 residential door opener is available for homes, condominiums, apartments or nearly any non-commercial environment where an inside or outside door should open automatically. The 2300 unit is easy to retrofit. It is one-third less than the installed cost and half the size & weight of the 4300 unit.

4300

**Commercial
Automatic
Door Opener**

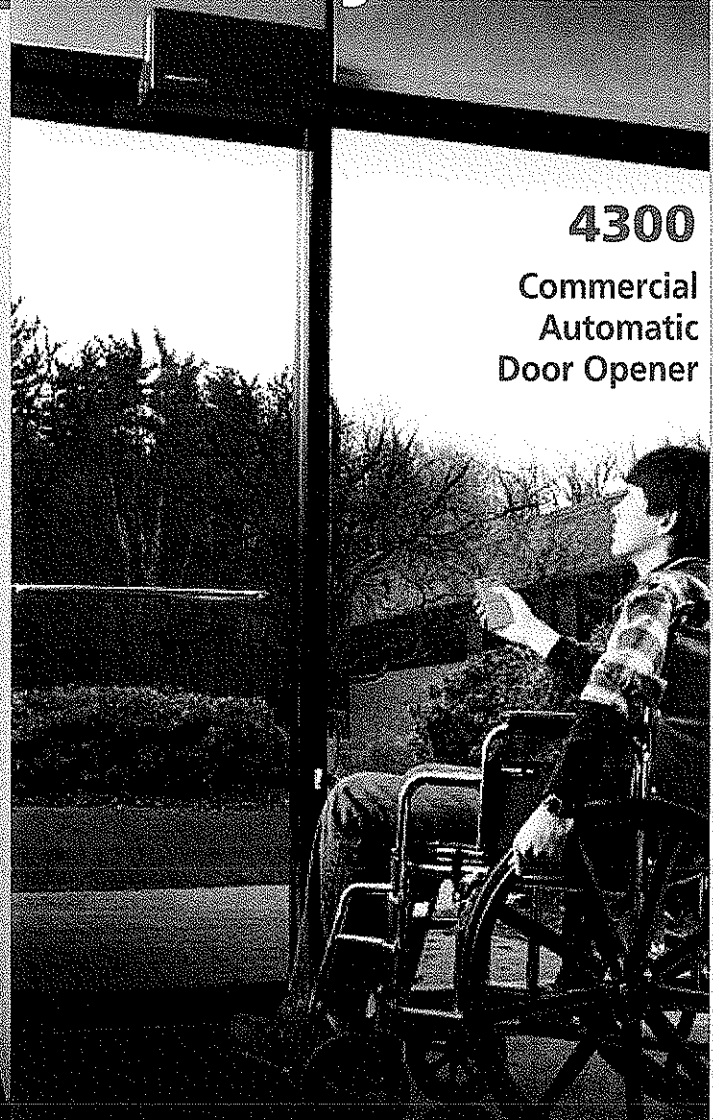

Power Access has offered its model 4300 for four decades. Both models are especially easy to retrofit on existing doors. Power Access opens doors with its 4300 commercial door opener in colleges, libraries, offices, industry, apartment houses, clinics, hospitals, hotels, special and extended care facilities, laboratories and government buildings.

The Medical CLUB^{COM}

*Your Source for Medical, Home Health,
and Independent Living Products*

1-800-993-1250

www.themedicalclub.com

Power Access door operators are simple to install.

No modification of the door or jambs is required for either unit. The 4300 and the 2300 plug directly into a standard wall outlet. Complete instructions are packed with every unit.

Designed for versatility, these openers fit most interior and exterior doors. Left and right hand units are available, in jamb or door mount. If there isn't enough room above the door, low profile designs may also accommodate.

Power Access door openers are activated by a remote wired or wireless signal. For your convenience, we've developed an array of controls adapted for special needs. Choose from push button or push plate wall styles, and wireless coded radio-controlled switches or specialty sip or puff controls for both 4300 and 2300 models.

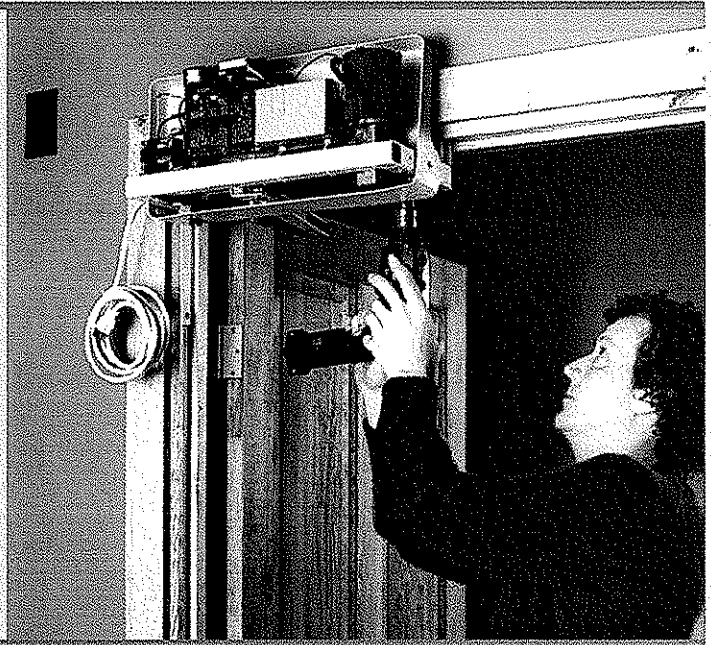

FEATURES

- Economy
- Manual or automatic operation
- Easy installation
- Nationwide dealer network
- Low maintenance
- Built-in safety
- Rugged construction
- Solid state circuitry
- One year limited warranty

Power Access automatic door operators have important, built-in, mechanical and electrical safety features:

The **4300** permits manual door operation because the wheeled arm does not attach to the door and the door closer will shut the door. On a powered opening, if the door meets an obstruction, a built-in load sensing circuit automatically stops the opener, times out and closes the door.

The **2300** also permits manual door operation, even though the arm to close the door is attached to either the frame or the door. The high gear ratio facilitates manual opening and closing of the door. On a powered opening or closing, if the door meets an obstruction the slip clutch reduces the pressure and the motor will time out and stop.

Both units have an adjustable, timed, hold-open feature of 0-30 seconds, as well as a signal to open and a signal to close.

Power Access automatic door operators are low-cost and virtually maintenance free.

COMPANION CONTROLS

Easy to Choose and Use

Power Access companion controls offer a variety of choices: select from wireless or wired, surface or flush wall-mounted, keyless wall-mounted and hand-held devices. Radio controls are easily adjusted to a personal code. Also available, but not shown, are sip or puff controls. Units can also interface with electric door strikes (locks) for door security.

Call us to discuss your particular requirements.

Toll-Free: 800-993-1250

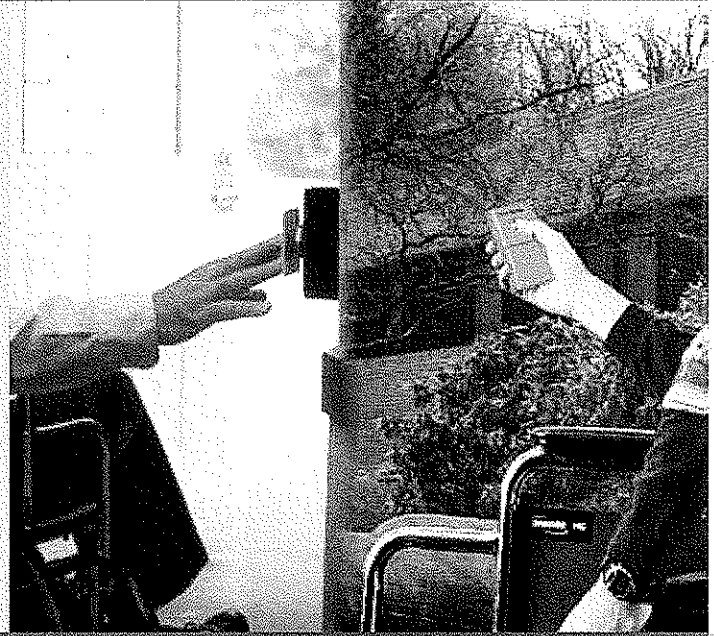

Wall Switches

Most controls are available for surface or flush mount, either wireless or wired.



4495 SQ

4-1/2" square plate on brown surface mount box.
4-1/2" x 4-1/2" x 2-1/4" depth



4495 SFBQ

4-1/2" square plate on brown formed box.
6-1/4" x 6-1/4" x 2" depth



4495 SFN

4-1/2" square plate on brown N-AMBLE box.
5-1/2" x 5-1/2" x 2-1/2" depth

4496 SR

6" round plate on brown surface mount box.
4-1/2" x 4-1/2" x 2-1/2" depth



4496 SFBR

6" round plate on brown formed box.
6-1/4" x 6-1/4" x 2" Depth



4466 SQ

2-3/4" square push plate on brown surface mount box.
4-1/2" x 2-3/2" x 1-5/8" depth



4466 SB

(as shown) push button on brown surface mount box (flush mount available)
4-1/2" x 2-3/4" x 1-5/8" Depth

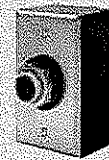

Radio Controls

Automatic door operation with 1,024 possible wireless codes eliminates signal duplication and frequency overlap. Transmitters available with 1, 2 or 4 buttons. Can be used to limit individuals' access to multiple, specified areas. Transmitters require a receiver inside the operator to actuate opening cycle. Special transmitters also available.

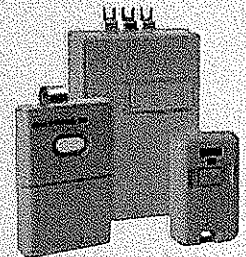

Keypad Entry Systems

Access codes for specified individuals. Available as coded wireless or wired type switches.



Electric Door Lock

Permits door to be secured when closed, but releases automatically when opener receives signal. Can be unlocked and opened manually with a key. Silently operated models for metal or wooden jambs.



4300 Heavy-duty Commercial Grade Door Opener

ARCHITECTURAL SPECIFICATION

Automatic door operator shall be electro-mechanical, self-contained, jamb mounted unit. The operator arm shall not be attached to the door, so that the door may be used in the full manual mode as required. The unit shall have an external on/off switch and an adjustable timed hold-open feature from 0 to 30 seconds. Operator shall have a painted, welded steel frame, Acrylic/PCV housing (meets UL 94V-O) and shall require 115Vac receptacle for 9' power cord supplied with each unit.

The operator shall be mounted according to drawings and instructions provided with each unit, and used in conjunction with a conventional manual door closer either of the surface-mounted or concealed type. The unit shall stop if it meets an obstruction during an operating cycle. It shall have an externally accessible circuit breaker to allow resetting in the event of an overload surge. It shall have a built-in line filter to suppress ac line transients and RFI.

Operation: Electro-mechanical. Works against a standard closer. Seven second cycle time. Adjustable Timed Hold Open feature for 0 to 30 seconds, or a hold open that requires a signal to close.

Power: Requires 115Vac 60Hz service to standard receptacle box.

Motor: 115Vac 60Hz permanent split capacitor, thermally protected.

Dimensions: 18 1/2" x 8 1/2" x 7"

Weight: 19 pounds

Material/Finish: Painted welded steel frame, ABS plastic housing.

Physical

Application: Jamb-mount, deep reveal or inverted mount; no physical attachment of arm on push side of door. Door mount; attached to door on pull side with arm pushing against door frame header. Requires door closer to shut the door.

Activation: Touch plate, push button, push plate, radio transmitter, mats, or any momentary dry contact signal.

2300 Low-cost, Lightweight Slim Line Residential Door Opener

ARCHITECTURAL SPECIFICATION

Unit meets a side hinged door mount application, or a jamb mount application on the push side of the door. Field changing from mode to mode or hand to hand can be done in the field in minutes. Door arm to attach to the door or jamb as the application requires. Unit shall have a cycle time from seven to eight seconds to open and seven to eight seconds to close. An adjustable timed hold-open feature will be user-programmable from 0 to 30 seconds. Friction clutch arm and special gear motor must permit safe door operation in both automatic and manual modes.

Operation: Electro-mechanical. Opens and closes the door. Seven second cycle time. Adjustable Timed Hold Open feature for 0 to 30 seconds, or a hold open that requires a signal to close.

Power: Requires 115Vac 60Hz standard outlet (9 foot power cord supplied).

Motor: 115Vac 60Hz gear motor

Dimensions: 12 3/4" W x 6" H x 3 1/2" D

Weight: 10 lbs.

Material/Finish: Cover Gray ABS Plastic.

Physical

Application: For residential side hinged doors. Door mount on pull side (needs 3 1/2" back clearance) - 3" above top of door needed for arm hub. Jamb mount on top of push side. Avoid out-swinging exterior door.

Activation: Dry contact momentary signal, wired or wireless.

WARRANTY

The Power Access Operator and controls are covered by a one year limited warranty on materials and workmanship. In addition, Power Access offers a nationwide network of service technicians who are continually updated on our products and service techniques.

SUPPORT

We have an "Open Door Policy" with all of our customers, dealers, and potential customers. If you've used a Power Access door operator, we'd like to know how you like it. Call or write your dealer, or let us hear from you directly at the factory. We're in northwestern Connecticut, which is noted for metalworking and engineering ingenuity. Our assembly techniques assure top quality and dependability. We're a small company, with a big dealer network.

The Medical CLUB^{COM}
Your Source for Medical, Home Health,
and Independent Living Products

1-800-993-1250
www.themedicalclub.com

Vendor Bid Form

**Provide and install integrated security system, as defined herein, for Building #84,
Cornerstone Building, 1409 Greenbrier Street, Charleston, WV**

Bid: All labor, materials, and associated costs to perform work as described herein.

Your bid for the work as described herein is: \$ 19,102.84

Contractor Name ADT SECURITY SERVICES
 Contractor Address 2800 7th AVE
CHARLESTON WV 25312
 Contractor Contact Name RON VanBibber
 Contractor Phone Number 304 533-9996
 Contractor Fax Number 304 206 3076
 Contractor Email Address rvanbibber@adt.com

Solely for the purpose of potential change orders, please include the following unit prices (these unit prices are NOT factored into the base, lump-sum bid, but will only be used as the basis for change orders, if they occur):

Card Reader (Exterior)	\$ <u>382.00</u>
Card Reader (Interior)	\$ <u>382.00</u>
Magnetic Door Lock	\$ <u>210.00</u>
Voice/Video Communications Station	\$ <u>297.50</u>

Unit price bids are not to include the cost of installation. Instead, bidders should submit their hourly rate for any additional work requested and approved by formal change order:

Hourly Rate \$ 55.00

Negotiated change orders will use the bid unit price for materials and labor rates as the basis from which to formulate the change order request. The successful bidder will be allowed to also include associated costs in the change order request.

**BID CLARIFICATIONS LETTER
ADT SECURITY SERVICES, INC.
COMMENTS AND REQUEST FOR CLARIFICATIONS**

PROJECT: SECURITY SYSTEM INSTALLATION – BUILDING 84

CUSTOMER: STATE OF WEST VIRGINIA – DEPARTMENT OF
ADMINISTRATION (the “State” or “Customer”)

PROPOSER: ADT SECURITY SERVICES, INC. (“ADT”)

PROJECT NO: GSD106457

DUE DATE: MAY 13, 2010 –THURSDAY – 1:30 PM

As part of its Proposal, ADT respectfully requests that the parties enter into the attached ADT agreement, or modify the State’s contract (the “Contract”) to include contract terms consistent with customary commercial practice in the electronic security services industry, such as those explained below, and as may be further amended by the parties. The reasons for this request are also set forth below:

1. **SAFETY Act.** Under the authority of the “Support Anti-Terrorism by Fostering Effective Technologies Act of 2002” and the regulations implementing the SAFETY Act, ADT has been designated as a provider of “Qualified Anti-Terrorism Technology” (“QATT”) by the U.S. Department of Homeland Security and has also received a Certificate of Conformance certifying that its Electronic Security Services qualify as QATT and have been placed on the “Approved Products List for Homeland Security.” Any contract between ADT and Customer should contain the mutual SAFETY Act waiver. Under the SAFETY Act, ADT and the Customer will receive significant tort liability protections against claims that ADT’s QATT failed to prevent a certified “Act of Terrorism”, as defined by the SAFETY Act, including: limitations on liability against third party claims, no joint and several liability, exclusive Federal Court jurisdiction for third party claims, no punitive damages allowed (if QATT is deployed), no non-compensatory damages and no pre-judgment interest. Additional information may be found at the Department of Homeland Security website: www.safetyact.gov.
2. **Risk Allocation.** While security systems attempt to detect, capture, record and provide notice of high risk and liability events such as unauthorized access, burglaries and fires, they do not cause and cannot prevent or control such events or the intervening actions that do cause them. ADT is not an insurer and does not insure against losses or injuries from such events. ADT’s competitive pricing reflects this fact. Accordingly, ADT seeks to clarify or delineate the circumstances under and the extent to which indemnification obligations arise, as well as to include commercially appropriate, reasonable and mutual limitations on liability and clarify any insurance requirements. Please note that ADT has attached evidence of insurance representing the insurance ADT will provide should the bid be awarded to ADT.
3. **Warranty.** ADT seeks to include standard terms and conditions of ADT’s warranty for equipment and services, including the scope under which its warranty applies and commercially appropriate and reasonable limitations and disclaimers.

ADT's Proposal constitutes a firm offer regarding ADT's prices for equipment and services. Any business relationship between the Customer and ADT shall otherwise be subject in all respects to the negotiation and execution of a mutually acceptable contract. Please do not hesitate to contact us if you have any questions concerning these comments. We thank you for the opportunity to submit our Proposal.

Respectfully submitted by ADT Security Services, Inc., on this 11th day of May, 2010



Authorized DOA Manager's Signature

Steven N. Bethel

Print Manager's Name

BID BOND

KNOW ALL MEN BY THESE PRESENTS, That we, the undersigned, ADT Security Services, Inc.
of Charleston, West Virginia, as Principal, and Federal Insurance Company
of Warren, New Jersey, a corporation organized and existing under the laws of the State of _____
IN with its principal office in the City of Warren, as Surety, are held and firmly bound unto the State
of West Virginia, as Obligees, in the penal sum of Five Percent of * (\$ 5%) for the payment of which,
well and truly to be made, we jointly and severally bind ourselves, our heirs, administrators, executors, successors and assigns

The Condition of the above obligation is such that whereas the Principal has submitted to the Purchasing Section of the
Department of Administration a certain bid or proposal, attached hereto and made a part hereof, to enter into a contract in writing for
Install AIPhone and access system

NOW THEREFORE,

- (a) If said bid shall be rejected, or
- (b) If said bid shall be accepted and the Principal shall enter into a contract in accordance with the bid or proposal attached hereto and shall furnish any other bonds and insurance required by the bid or proposal, and shall in all other respects perform the agreement created by the acceptance of said bid, then this obligation shall be null and void, otherwise this obligation shall remain in full force and effect. It is expressly understood and agreed that the liability of the Surety for any and all claims hereunder shall, in no event, exceed the penal amount of this obligation as herein stated.

The Surety, for the value received, hereby stipulates and agrees that the obligations of said Surety and its bond shall be in no way impaired or affected by any extension of the time within which the Obligees may accept such bid, and said Surety does hereby waive notice of any such extension.

IN WITNESS WHEREOF, Principal and Surety have hereunto set their hands and seals, and such of them as are corporations have caused their corporate seals to be affixed hereunto and these presents to be signed by their proper officers, this
13th day of May, 2010.

Principal Corporate Seal

ADT Security Services, Inc.
(Name of Principal)
By [Signature]
(Must be President or Vice President)

*Per 4-30-2010 Delegation of Authority from
N. David Bleisch, VP and General Counsel*

Surety Corporate Seal

Federal Insurance Company
(Name of Surety)

[Signature]
Stacy Rivera, Attorney-in-Fact

IMPORTANT -- Surety executing bonds must be licensed in West Virginia to transact surety insurance. Raised corporate seals must be affixed, a power of attorney must be attached.

*Amount Bid



Chubb
Surety

POWER
OF
ATTORNEY

Federal Insurance Company
Vigilant Insurance Company
Pacific Indemnity Company

Attn: Surety Department
15 Mountain View Road
Warren, NJ 07059

Know All by These Presents, That FEDERAL INSURANCE COMPANY, an Indiana corporation, VIGILANT INSURANCE COMPANY, a New York corporation, and PACIFIC INDEMNITY COMPANY, a Wisconsin corporation, do each hereby constitute and appoint Jeannette Porrini and Stacy Rivera of Farmington, Connecticut

each as their true and lawful Attorney-in-Fact to execute under such designation in their names and to affix their corporate seals to and deliver for and on their behalf as surety thereon or otherwise, bonds and undertakings and other writings obligatory in the nature thereof (other than bail bonds) given or executed in the course of business, and any instruments amending or altering the same, and consents to the modification or alteration of any instrument referred to in said bonds or obligations.

In Witness Whereof, said FEDERAL INSURANCE COMPANY, VIGILANT INSURANCE COMPANY, and PACIFIC INDEMNITY COMPANY have each executed and attested these presents and affixed their corporate seals on this 9th day of October, 2009

Kenneth C. Wendel, Assistant Secretary

David B. Norris, Jr., Vice President

STATE OF NEW JERSEY
County of Somerset ss.

On this 9th day of October, 2009

before me, a Notary Public of New Jersey, personally came Kenneth C. Wendel, to me known to be Assistant Secretary of FEDERAL INSURANCE COMPANY, VIGILANT INSURANCE COMPANY, and PACIFIC INDEMNITY COMPANY, the companies which executed the foregoing Power of Attorney, and the said Kenneth C. Wendel, being by me duly sworn, did depose and say that he is Assistant Secretary of FEDERAL INSURANCE COMPANY, VIGILANT INSURANCE COMPANY, and PACIFIC INDEMNITY COMPANY and knows the corporate seals thereof, that the seals affixed to the foregoing Power of Attorney are such corporate seals and were thereto affixed by authority of the By-Laws of said Companies; and that he signed said Power of Attorney as Assistant Secretary of said Companies by like authority, and that he is acquainted with David B. Norris, Jr., and knows him to be Vice President of said Companies; and that the signature of David B. Norris, Jr., subscribed to said Power of Attorney is in the genuine handwriting of David B. Norris, Jr., and was thereto subscribed by authority of said By-Laws and in deponent's presence.

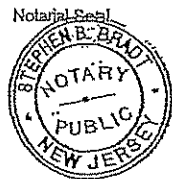

STEPHEN B. BRADT
Notary Public, State of New Jersey
No. 2321097
Commission Expires Oct. 25, 2014

Notary Public

CERTIFICATION

Extract from the By-Laws of FEDERAL INSURANCE COMPANY, VIGILANT INSURANCE COMPANY, and PACIFIC INDEMNITY COMPANY:

"All powers of attorney for and on behalf of the Company may and shall be executed in the name and on behalf of the Company, either by the Chairman or the President or a Vice President or an Assistant Vice President, jointly with the Secretary or an Assistant Secretary, under their respective designations. The signature of such officers may be engraved, printed or lithographed. The signature of each of the following officers: Chairman, President, any Vice President, any Assistant Vice President, any Secretary, any Assistant Secretary and the seal of the Company may be affixed by facsimile to any power of attorney or to any certificate relating thereto appointing Assistant Secretaries or Attorneys-In-Fact for purposes only of executing and attesting bonds and undertakings and other writings obligatory in the nature thereof, and any such power of attorney or certificate bearing such facsimile signature or facsimile seal shall be valid and binding upon the Company and any such power so executed and certified by such facsimile signature and facsimile seal shall be valid and binding upon the Company with respect to any bond or undertaking to which it is attached."

I, Kenneth C. Wendel, Assistant Secretary of FEDERAL INSURANCE COMPANY, VIGILANT INSURANCE COMPANY, and PACIFIC INDEMNITY COMPANY (the "Companies") do hereby certify that

- (i) the foregoing extract of the By-Laws of the Companies is true and correct,
- (ii) the Companies are duly licensed and authorized to transact surety business in all 50 of the United States of America and the District of Columbia and are authorized by the U.S. Treasury Department; further, Federal and Vigilant are licensed in Puerto Rico and the U.S. Virgin Islands, and Federal is licensed in American Samoa, Guam, and each of the Provinces of Canada except Prince Edward Island; and
- (iii) the foregoing Power of Attorney is true, correct and in full force and effect.

Given under my hand and seals of said Companies at Warren, NJ this 5/13/2010



Kenneth C. Wendel, Assistant Secretary

IN THE EVENT YOU WISH TO NOTIFY US OF A CLAIM, VERIFY THE AUTHENTICITY OF THIS BOND OR NOTIFY US OF ANY OTHER MATTER, PLEASE CONTACT US AT ADDRESS LISTED ABOVE, OR BY Telephone (908) 903-3493 Fax (908) 903-3656 e-mail: surety@chubb.com

FEDERAL INSURANCE COMPANY

STATEMENT OF ASSETS, LIABILITIES AND SURPLUS TO POLICYHOLDERS

Statutory Basis

DECEMBER 31, 2009

(in thousands of dollars)

<i>ASSETS</i>		<i>LIABILITIES AND SURPLUS TO POLICYHOLDERS</i>	
Cash and Short Term Investments.....	\$ 257,630	Outstanding Losses and Loss Expenses	\$ 11,900,150
United States Government, State and Municipal Bonds.....	11,077,454	Unearned Premiums.....	3,345,760
Other Bonds.....	4,042,056	Reinsurance Premiums Payable.....	322,875
Stocks.....	778,949	Provision for Reinsurance.....	79,993
Other Invested Assets.....	<u>1,758,696</u>	Other Liabilities.....	<u>717,789</u>
TOTAL INVESTMENTS.....	<u>17,914,785</u>	TOTAL LIABILITIES	<u>16,366,567</u>
Investments in Affiliates:		Special Surplus Funds.....	176,031
Chubb Investment Holdings, Inc.....	2,881,003	Capital Stock	20,980
Pacific Indemnity Company.....	2,200,172	Paid-In Surplus.....	3,106,809
Chubb Insurance Investment Holdings Ltd... ..	1,539,334	Unassigned Funds.....	<u>11,017,701</u>
Executive Risk Indemnity Inc.....	1,078,688		
CC Canada Holdings Ltd.....	607,555	SURPLUS TO POLICYHOLDERS.....	<u>14,321,521</u>
Great Northern Insurance Company	453,227		
Chubb European Investment Holdings SLP .	271,092		
Chubb Insurance Company of Australia ...	255,177		
Vigilant Insurance Company.....	176,625		
Other Affiliates	349,088		
Premiums Receivable	1,458,416	TOTAL LIABILITIES AND SURPLUS	
Other Assets	<u>1,502,926</u>	TO POLICYHOLDERS.....	<u>\$ 30,688,088</u>
TOTAL ADMITTED ASSETS	<u>\$ 30,688,088</u>		

Investments are valued in accordance with requirements of the National Association of Insurance Commissioners.
Investments valued at \$448,814,488 are deposited with government authorities as required by law.

State, County & City of New York, — ss:

Yvonne Baker, Assistant Secretary _____ of the Federal Insurance Company

being duly sworn, deposes and says that the foregoing Statement of Assets, Liabilities and Surplus to Policyholders of said Federal Insurance Company on December 31, 2009 is true and correct and is a true abstract of the Annual Statement of said Company as filed with the Secretary of the Treasury of the United States for the 12 months ending December 31, 2009.

Subscribed and sworn to before me
this

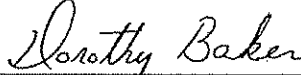

Notary Public

DOROTHY M. BAKER
Notary Public, State of New York
No. 31-4904994
Qualified in New York County
Commission Expires Sept. 14, 2013

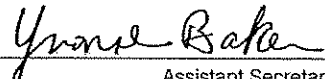

Assistant Secretary