



State of West Virginia  
 Department of Administration  
 Purchasing Division  
 2019 Washington Street East  
 Post Office Box 50130  
 Charleston, WV 25305-0130

# Request for Quotation

RFQ NUMBER  
**AGR1012**

PAGE  
**1**

ADDRESS CORRESPONDENCE TO ATTENTION OF  
**RON PRICE**  
**304-558-0492**

**VENDOR**  
 \*422150004      304-760-6018  
**J M STEORTS & ASSOCIATES LLC**  
**206 CHASE DR**  
**HURRICANE WV 25526-8938**

**SHIP TO**  
**DEPARTMENT OF AGRICULTURE**  
**MOOREFIELD FIELD OFFICE**  
**BOX 302**  
**RR 1**  
**MOOREFIELD, WV**  
**26836-0302      304-558-2222**

DATE PRINTED	TERMS OF SALE	SHIP VIA	F.O.B.	FREIGHT TERMS
02/10/2010				

BID OPENING DATE: **02/23/2010**      BID OPENING TIME **01:30PM**

LINE	QUANTITY	UOP	CAT. NO.	ITEM NUMBER	UNIT PRICE	AMOUNT
<b>ADDENDUM NO. 2</b>						
TO CHANGE THE BID OPENING DATE FROM 2/18/10 TO 2/23/10 1:30 PM AND TO RESPOND TO QUESTIONS FROM VENDORS WHICH ARE ATTACHED.						
0001	1	LS		971-08		
						POST FRAME BUILDING
***** THIS IS THE END OF RFQ      AGR1012 ***** TOTAL:						<b># 79,800.<sup>00</sup></b>
<b>SEVENTY NINE THOUSAND, EIGHT HUNDRED DOLLARS</b>						<b>✓ /100</b>
<b>RECEIVED</b> <b>2010 FEB 23 PM 1:02</b> <b>WV PURCHASING DIVISION</b>						
<b>RECEIVED FEB 12 2010</b>						

SEE REVERSE SIDE FOR TERMS AND CONDITIONS

SIGNATURE 	TELEPHONE <b>304-760-6020</b>	DATE <b>2-23-10</b>
TITLE <b>OWNER</b>	FEIN <b>26-1556382</b>	ADDRESS CHANGES TO BE NOTED ABOVE

WHEN RESPONDING TO RFQ, INSERT NAME AND ADDRESS IN SPACE ABOVE LABELED 'VENDOR'



State of West Virginia  
 Department of Administration  
 Purchasing Division  
 2019 Washington Street East  
 Post Office Box 50130  
 Charleston, WV 25305-0130

# Request for Quotation

RFO NUMBER:  
**AGR1012**

PAGE:  
**1**

ADDRESS CORRESPONDENCE TO ATTENTION OF:  
**RON PRICE  
 304-558-0492**

VENDOR

RFQ COPY  
 TYPE NAME/ADDRESS HERE  
**J. M. STEORTS & ASSOCIATES**

SHIP TO

DEPARTMENT OF AGRICULTURE  
 MOOREFIELD FIELD OFFICE  
 BOX 302  
 RR 1  
 MOOREFIELD, WV  
 26836-0302 304-558-2222

DATE PRINTED	TERMS OF SALE	SHIP VIA	FOB	FREIGHT TERMS
01/21/2010				

BID OPENING DATE: **02/18/2010** BID OPENING TIME **01:30PM**

LINE	QUANTITY	UOP	CAT. NO.	ITEM NUMBER	UNIT PRICE	AMOUNT
0001	1	LS		971-08		
<p><b>POST FRAME BUILDING</b></p> <p>A CONTRACT TO PROVIDE ALL LABOR AND MATERIALS REQUIRED TO CONSTRUCT A PRE-ENGINEERED POST FRAME BUILDING ON THE MOOREFIELD AGRICULTURAL COMPLEX AT 60B MOOREFIELD INDUSTRIAL PARK ROAD, MOOREFIELD, WV.</p> <p><b>MANDATORY PRE-BID</b></p> <p>A MANDATORY PRE-BID WILL BE HELD ON FEBRUARY 4, 2010 AT 10:00 AM IN MOOREFIELD, WV. ALL INTERESTED PARTIES ARE REQUIRED TO ATTEND THIS MEETING. FAILURE TO ATTEND THE MANDATORY PRE-BID SHALL RESULT IN DISQUALIFICATION OF THE BID. NO ONE PERSON MAY REPRESENT MORE THAN ONE BIDDER.</p> <p>AN ATTENDANCE SHEET WILL BE MADE AVAILABLE FOR ALL POTENTIAL BIDDERS TO COMPLETE. THIS WILL SERVE AS THE OFFICIAL DOCUMENT VERIFYING ATTENDANCE AT THE MANDATORY PRE-BID. FAILURE TO PROVIDE YOUR COMPANY AND REPRESENTATIVE NAME ON THE ATTENDANCE SHEET WILL RESULT IN DISQUALIFICATION OF THE BID. THE STATE WILL NOT ACCEPT ANY OTHER DOCUMENTATION TO VERIFY ATTENDANCE. THE BIDDER IS RESPONSIBLE FOR ENSURING THEY HAVE COMPLETED THE INFORMATION REQUIRED ON THE ATTENDANCE SHEET. THE PURCHASING DIVISION AND THE STATE AGENCY WILL NOT ASSUME ANY RESPONSIBILITY FOR A BIDDER'S FAILURE TO COMPLETE THE PRE-BID ATTENDANCE SHEET. IN ADDITION, WE REQUEST THAT ALL POTENTIAL BIDDERS INCLUDE THEIR E-MAIL ADDRESS AND FAX NUMBER.</p> <p>ALL POTENTIAL BIDDERS ARE REQUESTED TO ARRIVE PRIOR TO</p>						

SEE REVERSE SIDE FOR TERMS AND CONDITIONS

SIGNATURE 	TELEPHONE <b>304-760-6020</b>	DATE <b>2-23-10</b>
TITLE <b>OWNER</b>	FEIN <b>26-1556382</b>	ADDRESS CHANGES TO BE NOTED ABOVE

WHEN RESPONDING TO RFQ, INSERT NAME AND ADDRESS IN SPACE ABOVE LABELED 'VENDOR'

## GENERAL TERMS & CONDITIONS REQUEST FOR QUOTATION (RFQ) AND REQUEST FOR PROPOSAL (RFP)

1. Awards will be made in the best interest of the State of West Virginia.
2. The State may accept or reject in part, or in whole, any bid.
3. Prior to any award, the apparent successful vendor must be properly registered with the Purchasing Division and have paid the required \$125 fee.
4. All services performed or goods delivered under State Purchase Order/Contracts are to be continued for the term of the Purchase Order/Contracts, contingent upon funds being appropriated by the Legislature or otherwise being made available. In the event funds are not appropriated or otherwise available for these services or goods this Purchase Order/Contract becomes void and of no effect after June 30.
5. Payment may only be made after the delivery and acceptance of goods or services.
6. Interest may be paid for late payment in accordance with the *West Virginia Code*.
7. Vendor preference will be granted upon written request in accordance with the *West Virginia Code*.
8. The State of West Virginia is exempt from federal and state taxes and will not pay or reimburse such taxes.
9. The Director of Purchasing may cancel any Purchase Order/Contract upon 30 days written notice to the seller.
10. The laws of the State of West Virginia and the *Legislative Rules* of the Purchasing Division shall govern the purchasing process.
11. Any reference to automatic renewal is hereby deleted. The Contract may be renewed only upon mutual written agreement of the parties.
12. **BANKRUPTCY:** In the event the vendor/contractor files for bankruptcy protection, the State may deem this contract null and void, and terminate such contract without further order.
13. **HIPAA BUSINESS ASSOCIATE ADDENDUM:** The West Virginia State Government HIPAA Business Associate Addendum (BAA), approved by the Attorney General, is available online at [www.state.wv.us/admin/purchase/rc/hipaa.htm](http://www.state.wv.us/admin/purchase/rc/hipaa.htm) and is hereby made part of the agreement. Provided that the Agency meets the definition of a Cover Entity (45 CFR §160.103) and will be disclosing Protected Health Information (45 CFR §160.103) to the vendor.
14. **CONFIDENTIALITY:** The vendor agrees that he or she will not disclose to anyone, directly or indirectly, any such personally identifiable information or other confidential information gained from the agency, unless the individual who is the subject of the information consents to the disclosure in writing or the disclosure is made pursuant to the agency's policies, procedures, and rules. Vendor further agrees to comply with the Confidentiality Policies and Information Security Accountability Requirements, set forth in <http://www.state.wv.us/admin/purchase/privacy/noticeConfidentiality.pdf>.
15. **LICENSING:** Vendors must be licensed and in good standing in accordance with any and all state and local laws and requirements by any state or local agency of West Virginia, including, but not limited to, the West Virginia Secretary of State's Office, the West Virginia Tax Department, and the West Virginia Insurance Commission. The vendor must provide all necessary releases to obtain information to enable the director or spending unit to verify that the vendor is licensed and in good standing with the above entities.
16. **ANTITRUST:** In submitting a bid to any agency for the State of West Virginia, the bidder offers and agrees that if the bid is accepted the bidder will convey, sell, assign or transfer to the State of West Virginia all rights, title and interest in and to all causes of action it may now or hereafter acquire under the antitrust laws of the United States and the State of West Virginia for price fixing and/or unreasonable restraints of trade relating to the particular commodities or services purchased or acquired by the State of West Virginia. Such assignment shall be made and become effective at the time the purchasing agency tenders the initial payment to the bidder.

I certify that this bid is made without prior understanding, agreement, or connection with any corporation, firm, limited liability company, partnership, or person or entity submitting a bid for the same material, supplies, equipment or services and is in all respects fair and without collusion or fraud. I further certify that I am authorized to sign the certification on behalf of the bidder or this bid.

### INSTRUCTIONS TO BIDDERS

1. Use the quotation forms provided by the Purchasing Division. Complete all sections of the quotation form.
2. Items offered must be in compliance with the specifications. Any deviation from the specifications must be clearly indicated by the bidder. Alternates offered by the bidder as **EQUAL** to the specifications must be clearly defined. A bidder offering an alternate should attach complete specifications and literature to the bid. The Purchasing Division may waive minor deviations to specifications.
3. Unit prices shall prevail in case of discrepancy. All quotations are considered F.O.B. destination unless alternate shipping terms are clearly identified in the quotation.
4. All quotations must be delivered by the bidder to the office listed below prior to the date and time of the bid opening. Failure of the bidder to deliver the quotations on time will result in bid disqualifications: Department of Administration, Purchasing Division, 2019 Washington Street East, P.O. Box 50130, Charleston, WV 25305-0130
5. Communication during the solicitation, bid, evaluation or award periods, except through the Purchasing Division, is strictly prohibited (W.Va. C.S.R. §148-1-6.6).



State of West Virginia  
 Department of Administration  
 Purchasing Division  
 2019 Washington Street East  
 Post Office Box 50130  
 Charleston, WV 25305-0130

# Request for Quotation

RFQ NUMBER  
**AGR1012**

PAGE  
**2**

ADDRESS CORRESPONDENCE TO ATTENTION OF  
**RON PRICE  
 304-558-0492**

VENDOR

RFQ COPY  
 TYPE NAME/ADDRESS HERE  
**J.M. STEORTS & ASSOCS.**

SHIP TO

DEPARTMENT OF AGRICULTURE  
 MOOREFIELD FIELD OFFICE  
 BOX 302  
 RR 1  
 MOOREFIELD, WV  
 26836-0302 304-558-2222

DATE PRINTED <b>01/21/2010</b>	TERMS OF SALE	SHIP VIA	FOB	FREIGHT TERMS
-----------------------------------	---------------	----------	-----	---------------

BID OPENING DATE: **02/18/2010** BID OPENING TIME **01:30PM**

LINE	QUANTITY	UOP	CAT NO	ITEM NUMBER	UNIT PRICE	AMOUNT
<p>THE STARTING TIME FOR THE PRE-BID. BIDDERS WHO ARRIVE LATE, BUT PRIOR TO THE DISMISSAL OF THE TECHNICAL PORTION OF THE PRE-BID WILL BE PERMITTED TO SIGN IN. BIDDERS WHO ARRIVE AFTER CONCLUSION OF THE TECHNICAL PORTION OF THE PRE-BID, BUT DURING ANY SUBSEQUENT PART OF THE PRE-BID WILL NOT BE PERMITTED TO SIGN THE ATTENDANCE SHEET.</p> <p>WRITTEN QUESTIONS CONCERNING THIS PROJECT WILL BE RECEIVED UNTIL 4:30 PM ON FEBRUARY 1, 2010. THEY SHOULD BE SUBMITTED TO:</p> <p>RON PRICE            PURCHASING DIVISION            2019 WASHINGTON STREET, EAST            CHARLESTON, WV 25305            FAX: 304-558-4115            EMAIL: RON.N.PRICE@WV.GOV</p> <p>PREFERENCE FOR USE OF DOMESTIC STEEL PRODUCTS</p> <p>1. EXCEPT WHEN AUTHORIZED BY THE DIRECTOR OF THE PURCHASING DIVISION PURSUANT TO SUBSECTION 2 BELOW, NO CONTRACTOR MAY USE OR SUPPLY STEEL PRODUCTS FOR A STATE CONTRACT PROJECT OTHER THAN THOSE STEEL PRODUCTS MADE IN THE UNITED STATES. AS USED IN THIS CONTRACT,</p> <p>A. "STATE CONTRACT PROJECT" MEANS ANY ERECTION OR CONSTRUCTION OF, OR ANY ADDITION TO, ALTERATION OF OR OTHER IMPROVEMENT TO ANY BUILDING OR STRUCTURE, INCLUDING, BUT NOT LIMITED TO, ROADS OR HIGHWAYS, OR THE INSTALLATION OF ANY HEATING OR COOLING OR VENTILATING PLANTS OR OTHER</p>						

SEE REVERSE SIDE FOR TERMS AND CONDITIONS

SIGNATURE 	TELEPHONE <b>304-760-6020</b>	DATE <b>2-23-10</b>
TITLE <b>OWNER</b>	FEIN <b>26-1556382</b>	ADDRESS CHANGES TO BE NOTED ABOVE

WHEN RESPONDING TO RFQ, INSERT NAME AND ADDRESS IN SPACE ABOVE LABELED 'VENDOR'



State of West Virginia  
 Department of Administration  
 Purchasing Division  
 2019 Washington Street East  
 Post Office Box 50130  
 Charleston, WV 25305-0130

# Request for Quotation

RFQ NUMBER  
**AGR1012**

PAGE  
**3**

ADDRESS CORRESPONDENCE TO ATTENTION OF  
**RON PRICE**  
**304-558-0492**

P.O. BOX 50130

RFQ COPY  
 TYPE NAME/ADDRESS HERE  
**J.M. STEORTS & ASSOCS.**

SHIP TO

DEPARTMENT OF AGRICULTURE  
 MOOREFIELD FIELD OFFICE  
 BOX 302  
 RR 1  
 MOOREFIELD, WV  
 26836-0302 304-558-2222

DATE PRINTED	TERMS OF SALE	SHIP VIA	P.O.B.	FREIGHT TERMS
01/21/2010				
BID OPENING DATE: 02/18/2010		BID OPENING TIME 01:30PM		

LINE	QUANTITY	UOP	CAT. NO.	ITEM NUMBER	UNIT PRICE	AMOUNT
				EQUIPMENT, OR THE SUPPLY OF AND MATERIALS FOR SUCH PROJECTS, PURSUANT TO A CONTRACT WITH THE STATE OF WEST VIRGINIA FOR WHICH BIDS WERE SOLICITED ON OR AFTER JUNE 6, 2001.		
				B. "STEEL PRODUCTS" MEANS PRODUCTS ROLLED, FORMED SHAPED, DRAWN, EXTRUDED, FORGED, CAST, FABRICATED OR OTHERWISE SIMILARLY PROCESSED, OR PROCESSED BY A COMBINATION OF TWO OR MORE OF SUCH OPERATIONS, FROM STEEL MADE BY THE OPEN HEARTH, BASIC OXYGEN, ELECTRIC FURNACE, BESSEMER OR OTHER STEEL MAKING PROCESS.		
				C. "UNITED STATES" MEANS THE UNITED STATES OF AMERICA AND INCLUDES ALL TERRITORY, CONTINENTAL OR INSULAR, SUBJECT TO THE JURISDICTION OF THE UNITED STATES.		
				2. THE DIRECTOR OF THE PURCHASING DIVISION MAY, IN WRITING, AUTHORIZE THE USE OF FOREIGN STEEL PRODUCTS IF:		
				A. THE COST FOR EACH CONTRACT ITEM USED DOES NOT EXCEED ONE TENTH OF ONE PERCENT (.1%) OF THE TOTAL CONTRACT COST OR TWO THOUSAND FIVE HUNDRED DOLLARS (2,500.00), WHICHEVER IS GREATER. FOR THE PURPOSES OF THIS SECTION, THE COST IS THE VALUE OF THE STEEL PRODUCT AS DELIVERED TO THE PROJECT OR,		
				B. THE DIRECTOR OF THE PURCHASING DIVISION DETERMINES THAT SPECIFIED STEEL MATERIALS ARE NOT PRODUCED IN THE UNITED STATES IN SUFFICIENT QUANTITY OR OTHERWISE ARE NOT REASONABLY AVAILABLE TO MEET CONTRACT REQUIREMENTS.		

SEE REVERSE SIDE FOR TERMS AND CONDITIONS

SIGNATURE: 

TITLE: **OWNER**

FEIN: **26-1553682**

TELEPHONE: **304-760-6020**

DATE: **2-23-10**

ADDRESS CHANGES TO BE NOTED ABOVE

WHEN RESPONDING TO RFQ, INSERT NAME AND ADDRESS IN SPACE ABOVE LABELED 'VENDOR'



State of West Virginia  
 Department of Administration  
 Purchasing Division  
 2019 Washington Street East  
 Post Office Box 50130  
 Charleston, WV 25305-0130

**Request for  
 Quotation**

RFQ NUMBER
AGR1012

PAGE
4

ADDRESS CORRESPONDENCE TO ATTENTION OF
RDN PRICE 304-558-0492

RFQ COPY

TYPE NAME/ADDRESS HERE

*J.M. STEORTS & ASSOCS.*

DEPARTMENT OF AGRICULTURE  
 MOOREFIELD FIELD OFFICE  
 BOX 302  
 RR 1  
 MOOREFIELD, WV  
 26836-0302 304-558-2222

DATE PRINTED	TERMS OF SALE	SHIP VIA	F.O.B.	FREIGHT TERMS
01/21/2010				

BID OPENING DATE: 02/18/2010 BID OPENING TIME 01:30PM

LINE	QUANTITY	UOP	CAT NO.	ITEM NUMBER	UNIT PRICE	AMOUNT
3.						
<p>A CONTRACTOR WHO USES STEEL PRODUCTS IN VIOLATION OF THIS SECTION MAY BE SUBJECT TO CIVIL PENALTIES PURSUANT TO WV CODE SECTION 5A-3-56.</p> <p>REV. 10/01/01</p> <p>EXHIBIT 5</p> <p>WEST VIRGINIA CODE 21-1D-5 PROVIDES THAT: ANY SOLICITATION FOR A PUBLIC IMPROVEMENT CONSTRUCTION CONTRACT REQUIRES EACH VENDOR THAT SUBMITS A BID FOR THE WORK TO SUBMIT AT THE SAME TIME AN AFFIDAVIT OF COMPLIANCE WITH THE BID. THE ENCLOSED DRUG-FREE WORKPLACE AFFIDAVIT MUST BE SIGNED AND SUBMITTED WITH THE BID AS EVIDENCE OF THE VENDOR'S COMPLIANCE WITH THE PROVISIONS OF ARTICLE 1D, CHAPTER 21 OF THE WEST VIRGINIA CODE. FAILURE TO SUBMIT THE SIGNED DRUG-FREE WORKPLACE AFFIDAVIT WITH THE BID SHALL RESULT IN DISQUALIFICATION OF SUCH BID.</p> <p>NOTICE TO PROCEED: THIS CONTRACT IS TO BE PERFORMED BY MAY 31, 2010. UNLESS OTHERWISE SPECIFIED, THE FULLY EXECUTED PURCHASE ORDER WILL BE CONSIDERED NOTICE TO PROCEED.</p> <p>CANCELLATION: THE DIRECTOR OF PURCHASING RESERVES THE RIGHT TO CANCEL THIS CONTRACT IMMEDIATELY UPON WRITTEN NOTICE TO THE VENDOR IF THE MATERIALS OR WORKMANSHIP SUPPLIED ARE OF AN INFERIOR QUALITY OR DO NOT CONFORM WITH THE SPECIFICATIONS OF THE BID AND CONTRACT HERE IN.</p> <p>WAGE RATES: THE CONTRACTOR OR SUBCONTRACTOR SHALL PAY</p>						

SEE REVERSE SIDE FOR TERMS AND CONDITIONS

SIGNATURE	TELEPHONE	DATE
<i>[Signature]</i>	304-760-6020	2-23-10
TITLE	FEIN	ADDRESS CHANGES TO BE NOTED ABOVE
OWNER	26-1556382	

WHEN RESPONDING TO RFQ, INSERT NAME AND ADDRESS IN SPACE ABOVE LABELED 'VENDOR'



State of West Virginia  
 Department of Administration  
 Purchasing Division  
 2019 Washington Street East  
 Post Office Box 50130  
 Charleston, WV 25305-0130

# Request for Quotation

RFQ NUMBER  
**AGR1012**

PAGE  
**5**

ADDRESS CORRESPONDENCE TO ATTENTION OF  
**RON PRICE  
 304-558-0492**

PURCHASER

RFQ COPY  
 TYPE NAME/ADDRESS HERE  
**J.M. STEORTS & ASSOCS.**

SHIP TO

DEPARTMENT OF AGRICULTURE  
 MOOREFIELD FIELD OFFICE  
 BOX 302  
 RR 1  
 MOOREFIELD, WV  
 26836-0302 304-558-2222

DATE PRINTED	TERMS OF SALE	SHIP VIA	F.O.B.	FREIGHT TERMS
01/21/2010				
BID OPENING DATE: 02/18/2010		BID OPENING TIME 01:30PM		

LINE	QUANTITY	UQP	CAT NO.	ITEM NUMBER	UNIT PRICE	AMOUNT
<p>THE HIGHER OF THE U.S. DEPARTMENT OF LABOR MINIMUM WAGE RATES AS ESTABLISHED FOR HARDY COUNTY, PURSUANT TO WEST VIRGINIA CODE 21-5A, ET, SEQ. (PREVAILING WAGE RATES APPLY TO THIS PROJECT)</p> <p>ARBITRATION: ANY REFERENCES MADE TO ARBITRATION OR INTEREST FOR PAYMENTS DUE (EXCEPT FOR ANY INTEREST REQUIRED BY STATE LAW) CONTAINED IN THIS CONTRACT OR IN ANY AMERICAN INSTITUTE OF ARCHITECTS DOCUMENTS PERTAINING TO THIS CONTRACT ARE HEREBY DELETED.</p> <p>WORKERS' COMPENSATION: VENDOR IS REQUIRED TO PROVIDE A CERTIFICATE FROM WORKERS' COMPENSATION IF SUCCESSFUL.</p> <p>ALL OF THE ITEMS CHECKED BELOW WILL BE A REQUIREMENT OF THIS CONTRACT:</p> <p>(XX) INSURANCE: SUCCESSFUL VENDOR SHALL FURNISH PROOF OF COMMERCIAL GENERAL LIABILITY INSURANCE PRIOR TO ISSUANCE OF CONTRACT. UNLESS OTHERWISE SPECIFIED IN THE BID DOCUMENTS, THE MINIMUM AMOUNT OF INSURANCE COVERAGE REQUIRED IS \$250,000.</p> <p>( ) BUILDERS RISK INSURANCE: SUCCESSFUL VENDOR SHALL FURNISH PROOF OF BUILDERS RISK - ALL RISK INSURANCE IN AN AMOUNT EQUAL TO 100% OF THE AMOUNT OF THE CONTRACT.</p> <p>(XX) BONDS: FIVE PERCENT (5%) OF THE TOTAL AMOUNT OF THE BID PAYABLE TO THE STATE OF WEST VIRGINIA, SHALL BE SUBMITTED WITH EACH BID AS A BID BOND. THE SUCCESSFUL BIDDER SHALL ALSO FURNISH A PERFORMANCE BOND AND LABOR/MATERIAL BOND FOR 100% OF THE AMOUNT OF THE CONTRACT. BONDS MAY BE PROVIDED IN THE FORM OF A CERTIFIED CHECK, IRREVOCABLE LETTER OF CREDIT, OR BOND FURNISHED BY A SOLVENT SURETY COMPANY AUTHORIZED TO DO BUSINESS IN THE STATE OF WEST VIRGINIA. A LETTER OF CREDIT SUBMITTED</p>						

SEE REVERSE SIDE FOR TERMS AND CONDITIONS

SIGNATURE: TELEPHONE: 304-760-6020 DATE: 2-23-10  
 TITLE: OWNER FEIN: 26-1556382 ADDRESS CHANGES TO BE NOTED ABOVE

WHEN RESPONDING TO RFQ, INSERT NAME AND ADDRESS IN SPACE ABOVE LABELED 'VENDOR'



State of West Virginia  
 Department of Administration  
 Purchasing Division  
 2019 Washington Street East  
 Post Office Box 50130  
 Charleston, WV 25305-0130

# Request for Quotation

RFQ NUMBER  
**AGR1012**

PAGE  
**6**

ADDRESS CORRESPONDENCE TO ATTENTION OF  
**RON PRICE**  
**304-558-0492**

VENDOR

RFQ COPY  
 TYPE NAME/ADDRESS HERE  
**J.M. STEORTS & ASSOCS.**

SHIP TO

DEPARTMENT OF AGRICULTURE  
 MOOREFIELD FIELD OFFICE  
 BOX 302  
 RR 1  
 MOOREFIELD, WV  
 26836-0302 304-558-2222

DATE PRINTED	TERMS OF SALE	SHIP VIA	F.O.B.	FREIGHT TERMS
01/21/2010				

BID OPENING DATE: **02/18/2010** BID OPENING TIME **01:30PM**

LINE	QUANTITY	UOP	CAT NO.	ITEM NUMBER	UNIT PRICE	AMOUNT
<p>IN LIEU OF A BOND WILL ONLY BE ALLOWED FOR PROJECTS UNDER \$100,000. PERSONAL OR BUSINESS CHECKS ARE NOT ACCEPTABLE IN LIEU OF THE 5% BID BOND, PERFORMANCE BOND, OR LABOR AND MATERIAL BOND.</p> <p>REV. 11/00</p> <p>EXHIBIT 7</p> <p>DOMESTIC ALUMINUM, GLASS &amp; STEEL IN PUBLIC WORKS PROJECTS</p> <p>IN ACCORDANCE WITH WEST VIRGINIA CODE 5-19-1 ET., SEQ., EVERY CONTRACT FOR CONSTRUCTION, RECONSTRUCTION, ALTERATION, REPAIR, IMPROVEMENT OR MAINTENANCE OF PUBLIC WORKS, WHERE THE COST IS MORE THAN \$50,000 AND, IN THE CASE OF STEEL ONLY, WHERE THE COST OF STEEL IS MORE THAN \$50,000 OR WHERE MORE THAN 10,000 POUNDS OF STEEL ARE REQUIRED, THE STATE WILL ACCEPT ONLY ALUMINUM GLASS, OR STEEL PRODUCTS PRODUCED IN THE UNITED STATES. IN ADDITION, ITEMS OF MACHINERY OR EQUIPMENT PURCHASED FOR USE AT THE SITE OF PUBLIC WORKS SHALL BE MADE OF DOMESTIC ALUMINUM, GLASS OR STEEL, UNLESS THE COST OF THE PRODUCT IS LESS THAN \$50,000 OR LESS THAN 10,000 POUNDS OF STEEL ARE USED IN PUBLIC WORKS PROJECTS.</p> <p>FOREIGN MADE ALUMINUM, GLASS OR STEEL PRODUCTS MAY BE ACCEPTED ONLY IF THE COST OF DOMESTIC PRODUCTS IS FOUND TO BE UNREASONABLE. SUCH COST IS UNREASONABLE IF IT IS 20% OR MORE HIGHER THAN THE BID PRICE FOR FOREIGN MADE PRODUCTS. IF THE DOMESTIC ALUMINUM, GLASS OR STEEL PRODUCTS TO BE SUPPLIED OR PRODUCED IN A "SUBSTANTIAL LABOR SURPLUS AREA", AS DEFINED BY THE UNITED STATES DEPARTMENT OF LABOR, FOREIGN PRODUCTS MAY BE SUPPLIED</p>						

SEE REVERSE SIDE FOR TERMS AND CONDITIONS

SIGNATURE 	TELEPHONE <b>304-760-6020</b>	DATE <b>2-23-10</b>
TITLE <b>OWNER</b>	FEIN <b>26-1556382</b>	ADDRESS CHANGES TO BE NOTED ABOVE

WHEN RESPONDING TO RFQ, INSERT NAME AND ADDRESS IN SPACE ABOVE LABELED 'VENDOR'





State of West Virginia  
 Department of Administration  
 Purchasing Division  
 2019 Washington Street East  
 Post Office Box 50130  
 Charleston, WV 25305-0130

# Request for Quotation

RFQ NUMBER  
**AGR1012**

PAGE  
**7**

ADDRESS CORRESPONDENCE TO ATTENTION OF  
**RON PRICE**  
**304-558-0492**

VENDOR

RFQ COPY  
 TYPE NAME/ADDRESS HERE

**J.M. STEORTS & ASSOCS.**

SHIP TO

DEPARTMENT OF AGRICULTURE  
 MOOREFIELD FIELD OFFICE  
 BOX 302  
 RR 1  
 MOOREFIELD, WV  
 26836-0302 304-558-2222

DATE PRINTED	TERMS OF SALE	SHIP VIA	F.O.B.	FREIGHT TERMS
01/21/2010				
BID OPENING DATE: 02/18/2010		BID OPENING TIME 01:30PM		

LINE	QUANTITY	UOP	CAT NO.	ITEM NUMBER	UNIT PRICE	AMOUNT
<p>ONLY IF DOMESTIC PRODUCTS ARE 30% OR MORE HIGHER IN PRICE THAN THE FOREIGN MADE PRODUCTS.</p> <p>IF, PRIOR TO THE AWARD OF A CONTRACT UNDER THE ABOVE PROVISIONS, THE SPENDING OFFICER OF THE SPENDING UNIT DETERMINES THAT THERE EXISTS A BID FOR LIKE FOREIGN ALUMINUM, GLASS OR STEEL THAT IS REASONABLE AND LOWER THAN THE LOWEST BID DOMESTIC PRODUCTS, THE SPENDING OFFICE MAY REQUEST, IN WRITING, A REEVALUATION AND REDUCTION IN THE LOWEST BID FOR SUCH DOMESTIC PRODUCTS. ALL VENDORS MUST INDICATE IN THEIR BID IF THEY ARE SUPPLYING FOREIGN ALUMINUM, GLASS OR STEEL.</p> <p>REV. 3/88</p> <p>EXHIBIT 9</p> <p>NOTICE FOR ISSUANCE &amp; ACKNOWLEDGEMENT OF CONSTRUCTION PROJECT ADDENDA</p> <p>THE ARCHITECT/ENGINEER AND/OR AGENCY SHALL BE REQUIRED TO ABIDE BY THE FOLLOWING SCHEDULE IN ISSUING CONSTRUCTION PROJECT ADDENDA FOR STATE AGENCIES:</p> <p>(1) THE ARCHITECT/ENGINEER SHALL PREPARE THE ADDENDUM AND A LIST OF ALL PARTIES THAT HAVE PROCURED DRAWINGS AND SPECIFICATIONS FOR THE PROJECT. THE ADDENDUM AND LIST SHALL BE FORWARDED TO THE BUYER IN THE STATE PURCHASING DIVISION. THE ARCHITECT/ENGINEER SHALL ALSO SEND A COPY OF THE ADDENDUM TO THE STATE AGENCY FOR WHICH THE CONTRACT IS ISSUED.</p> <p>(2) THE BUYER SHALL SEND THE ADDENDUM TO ALL INTERESTED PARTIES AND, IF NECESSARY, EXTEND THE BID OPENING DATE. ANY ADDENDUM SHOULD BE RECEIVED BY THE</p>						

SEE REVERSE SIDE FOR TERMS AND CONDITIONS

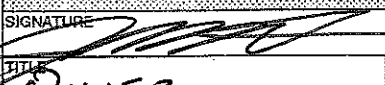
SIGNATURE:  TELEPHONE: **304-760-6020** DATE: **2-23-10**

TITLE: **OWNER** FEIN: **26-1556382** ADDRESS CHANGES TO BE NOTED ABOVE

WHEN RESPONDING TO RFQ, INSERT NAME AND ADDRESS IN SPACE ABOVE LABELED 'VENDOR'



State of West Virginia  
 Department of Administration  
 Purchasing Division  
 2019 Washington Street East  
 Post Office Box 50130  
 Charleston, WV 25305-0130

# Request for Quotation

RFQ NUMBER  
**AGR1012**

PAGE  
**8**

ADDRESS CORRESPONDENCE TO ATTENTION OF:  
 RDN PRICE  
 304-558-0492

VENDOR

RFQ COPY  
 TYPE NAME/ADDRESS HERE  
**J.M. STEORTS & ASSOCS.**

SHIP TO

DEPARTMENT OF AGRICULTURE  
 MOOREFIELD FIELD OFFICE  
 BOX 302  
 RR 1  
 MOOREFIELD, WV  
 26836-0302      304-558-2222

DATE PRINTED	TERMS OF SALE	SHIP VIA	F.O.B.	FREIGHT TERMS
01/21/2010				

BID OPENING DATE: **02/18/2010**      BID OPENING TIME **01:30PM**

LINE	QUANTITY	UQP	CAT NO.	ITEM NUMBER	UNIT PRICE	AMOUNT
<p>BUYER WITHIN FOURTEEN (14) DAYS PRIOR TO THE BID OPENING DATE.</p> <p>(3) ALL ADDENDA SHOULD BE FORMALLY ACKNOWLEDGED BY ALL BIDDERS AND SUBMITTED TO THE STATE PURCHASING DIVISION. THE SAME RULES AND REGULATIONS THAT APPLY TO THE ORIGINAL BIDDING DOCUMENT SHALL ALSO APPLY TO AN ADDENDUM DOCUMENT. THE ONLY EXCEPTION MAY BE FOR AN ADDENDUM THAT IS ISSUED FOR THE SOLE PURPOSE OF CHANGING A BID OPENING TIME AND/OR DATE.</p> <p>REV. 11/96</p> <p>EXHIBIT 10</p> <p>ADDENDUM ACKNOWLEDGEMENT</p> <p>I HEREBY ACKNOWLEDGE RECEIPT OF THE FOLLOWING CHECKED ADDENDUM(S) AND HAVE MADE THE NECESSARY REVISIONS TO MY PROPOSAL, PLANS AND/OR SPECIFICATION, ETC.</p> <p>ADDENDUM NOS.:</p> <p>NO. 1      <i>2-5-10</i>.....</p> <p>NO. 2      <i>2-10-10</i>.....</p> <p>NO. 3      .....            NO. 4      .....            NO. 5      .....</p> <p>I UNDERSTAND THAT FAILURE TO CONFIRM THE RECEIPT OF TH</p>						

SEE REVERSE SIDE FOR TERMS AND CONDITIONS

SIGNATURE 	TELEPHONE <b>304-760-6020</b>	DATE <b>2-23-10</b>
TITLE <b>OWNER</b>	FEIN <b>26-1556382</b>	ADDRESS CHANGES TO BE NOTED ABOVE

WHEN RESPONDING TO RFQ, INSERT NAME AND ADDRESS IN SPACE ABOVE LABELED 'VENDOR'



State of West Virginia  
 Department of Administration  
 Purchasing Division  
 2019 Washington Street East  
 Post Office Box 50130  
 Charleston, WV 25305-0130

# Request for Quotation

RFQ NUMBER  
**AGR1012**

PAGE  
**9**

ADDRESS CORRESPONDENCE TO ATTENTION OF  
**RON PRICE**  
**304-558-0492**

PURCHASING

RFQ COPY

J M Steorts and Associates, LLC  
 206 Chase Drive  
 Hurricane, WV 25526

SHIP TO

DEPARTMENT OF AGRICULTURE  
 MOOREFIELD FIELD OFFICE  
 BOX 302  
 RR 1  
 MOOREFIELD, WV  
 26836-0302 304-558-2222

DATE PRINTED <b>01/21/2010</b>	TERMS OF SALE	SHIP VIA	F.O.B.	FREIGHT TERMS
-----------------------------------	---------------	----------	--------	---------------

BID OPENING DATE: **02/18/2010** BID OPENING TIME **01:30PM**

LINE	QUANTITY	UOP	CAT. NO.	ITEM NUMBER	UNIT PRICE	AMOUNT
<p>ADDENDUM(S) MAY BE CAUSE FOR REJECTION OF THE BIDS.</p> <p>VENDOR MUST CLEARLY UNDERSTAND THAT ANY VERBAL REPRESENTATION MADE OR ASSUMED TO BE MADE DURING ANY ORAL DISCUSSION HELD BETWEEN VENDOR'S REPRESENTATIVES AND ANY STATE PERSONNEL IS NOT BINDING. ONLY THE INFORMATION ISSUED IN WRITING AND ADDED TO THE SPECIFICATIONS BY AN OFFICIAL ADDENDUM IS BINDING.</p> <p><i>[Signature]</i>.....SIGNATURE  <i>J.M. STEORTS &amp; ASSOCIATES</i>.....COMPANY  <i>2-23-10</i>.....DATE</p> <p>REV. 11/96</p> <p>CONTRACTORS LICENSE</p> <p>WEST VIRGINIA STATE CODE 21-11-2 REQUIRES THAT ALL PERSONS DESIRING TO PERFORM CONTRACTING WORK IN THIS STATE MUST BE LICENSED. THE WEST VIRGINIA CONTRACTORS LICENSING BOARD IS EMPOWERED TO ISSUE THE CONTRACTORS LICENSE. APPLICATIONS FOR A CONTRACTORS LICENSE MAY BE MADE BY CONTACTING THE WEST VIRGINIA DIVISION OF LABOR CAPITOL COMPLEX, BUILDING 3, ROOM 319, CHARLESTON, WV 25305. TELEPHONE: (304) 558-7890.</p> <p>WEST VIRGINIA STATE CODE 21-11-11 REQUIRES ANY PROSPECTIVE BIDDER TO INCLUDE THE CONTRACTORS LICENSE NUMBER ON THEIR BID.</p> <p>BIDDER TO COMPLETE:</p>						

SEE REVERSE SIDE FOR TERMS AND CONDITIONS

SIGNATURE *[Signature]* TELEPHONE **304-760-6020** DATE **2-23-10**

TITLE **OWNER** FEIN **26-1556382** ADDRESS CHANGES TO BE NOTED ABOVE

WHEN RESPONDING TO RFQ, INSERT NAME AND ADDRESS IN SPACE ABOVE LABELED 'VENDOR'



State of West Virginia  
 Department of Administration  
 Purchasing Division  
 2019 Washington Street East  
 Post Office Box 50130  
 Charleston, WV 25305-0130

# Request for Quotation

RFQ NUMBER  
**AGR1012**

PAGE  
**10**

ADDRESS CORRESPONDENCE TO ATTENTION OF:  
**RON PRICE**  
**304-558-0492**

VENDOR

RFQ COPY  
 TYPE NAME/ADDRESS HERE

**J.M. STEORTS & ASSOCS.**

SHIP TO

DEPARTMENT OF AGRICULTURE  
 MOOREFIELD FIELD OFFICE  
 BOX 302  
 RR 1  
 MOOREFIELD, WV  
 26836-0302 304-558-2222

DATE PRINTED	TERMS OF SALE	SHIP VIA	F.O.B.	FREIGHT TERMS
01/21/2010				

BID OPENING DATE: **02/18/2010** BID OPENING TIME **01:30PM**

LINE	QUANTITY	UOP	CAT NO	ITEM NUMBER	UNIT PRICE	AMOUNT
<p>CONTRACTORS NAME: <b>J.M. STEORTS &amp; ASSOCIATES.</b></p> <p>CONTRACTORS LICENSE NO.: <b>..WV.043449.....</b></p> <p>THE SUCCESSFUL BIDDER WILL BE REQUIRED TO FURNISH A COPY OF THEIR CONTRACTORS LICENSE PRIOR TO ISSUANCE OF A PURCHASE ORDER/CONTRACT</p> <p>APPLICABLE LAW</p> <p>THE WEST VIRGINIA STATE CODE, PURCHASING DIVISION RULES AND REGULATIONS, AND THE INFORMATION PROVIDED IN THE "REQUEST FOR QUOTATION" ISSUED BY THE PURCHASING DIVISION IS THE SOLE AUTHORITY GOVERNING THIS PROCUREMENT.</p> <p>ANY INFORMATION PROVIDED IN SPECIFICATION MANUALS, OR ANY OTHER SOURCE, VERBAL OR WRITTEN, WHICH CONTRADICTS OR ALTERS THE INFORMATION PROVIDED FROM THE SOURCES AS DESCRIBED IN THE ABOVE PARAGRAPH IS VOID AND OF NO EFFECT.</p> <p>BANKRUPTCY: IN THE EVENT THE VENDOR/CONTRACTOR FILES FOR BANKRUPTCY PROTECTION, THE STATE MAY DEEM THE CONTRACT NULL AND VOID, AND TERMINATE SUCH CONTRACT WITHOUT FURTHER ORDER.</p> <p>REV. 5/2009</p> <p>NOTICE</p> <p>A SIGNED BID MUST BE SUBMITTED TO:</p> <p>DEPARTMENT OF ADMINISTRATION          PURCHASING DIVISION</p>						

SEE REVERSE SIDE FOR TERMS AND CONDITIONS

SIGNATURE 	TELEPHONE <b>304-760-6020</b>	DATE <b>2-23-10</b>
TITLE <b>OWNER</b>	FEIN <b>26-1556382</b>	ADDRESS CHANGES TO BE NOTED ABOVE

WHEN RESPONDING TO RFQ, INSERT NAME AND ADDRESS IN SPACE ABOVE LABELED 'VENDOR'



State of West Virginia  
 Department of Administration  
 Purchasing Division  
 2019 Washington Street East  
 Post Office Box 50130  
 Charleston, WV 25305-0130

# Request for Quotation

RFQ NUMBER  
**AGR1012**

PAGE  
**11**

ADDRESS CORRESPONDENCE TO ATTENTION OF  
**RON PRICE**  
**304-558-0492**

RFQ COPY

TYPE NAME/ADDRESS HERE  
**J.M. STEORTS & ASSOC.**

SHIP TO

DEPARTMENT OF AGRICULTURE  
 MOOREFIELD FIELD OFFICE  
 BOX 302  
 RR 1  
 MOOREFIELD, WV  
 26836-0302 304-558-2222

DATE PRINTED	TERMS OF SALE	SHIP VIA	FOB	FREIGHT TERMS
01/21/2010				

BID OPENING DATE: **02/18/2010** BID OPENING TIME: **01:30PM**

LINE	QUANTITY	UOP	CAT NO	ITEM NUMBER	UNIT PRICE	AMOUNT
<p><b>BUILDING 15</b>  <b>2019 WASHINGTON STREET, EAST</b>  <b>CHARLESTON, WV 25305-0130</b></p> <p>THE BID SHOULD CONTAIN THIS INFORMATION ON THE FACE OF THE ENVELOPE OR THE BID MAY NOT BE CONSIDERED:</p> <p>SEALED BID</p> <p>BUYER: RP-41</p> <p>REQ. NO.: AGR1012</p> <p>BID OPENING DATE: 02/18/10</p> <p>BID OPENING TIME: 1:30 PM</p> <p>PLEASE PROVIDE A FAX NUMBER IN CASE IT IS NECESSARY TO CONTACT YOU REGARDING YOUR BID:  <b>304-760-6019</b></p> <p>PLEASE PRINT OR TYPE NAME OF PERSON TO CONTACT CONCERNING THIS QUOTE:  <b>MARK TURLEY OR</b>  <b>JASON STEORTS</b></p>						

SEE REVERSE SIDE FOR TERMS AND CONDITIONS

SIGNATURE 	TELEPHONE <b>304-760-6020</b>	DATE <b>2-23-10</b>
TITLE <b>OWNER</b>	FEIN <b>26-1556382</b>	ADDRESS CHANGES TO BE NOTED ABOVE

WHEN RESPONDING TO RFQ, INSERT NAME AND ADDRESS IN SPACE ABOVE LABELED 'VENDOR'

West Virginia Department of Agriculture      Administrative Service Division, Building & Grounds  
Moorefield Agricultural Complex / Post Frame Building

WEST VIRGINIA DEPARTMENT OF AGRICULTURE  
ADMINISTRATIVE SERVICES DIVISION, BUILDING & GROUNDS  
MOOREFIELD AGRICULTURAL COMPLEX / POST FRAME BUILDING

Location:      Moorefield Agricultural Complex  
60B Moorefield Industrial Park Road  
Moorefield, WV 26836

For:            West Virginia Department of Agriculture  
Administrative Services Division, Building & Grounds  
1900 Kanawha Boulevard East  
Charleston WV 25305

All inquiries for specification clarification shall be addressed to:

Michael E. Steadman, Assistant Director  
Administrative Services Division, Building & Grounds  
1900 Kanawha Boulevard East  
Charleston WV 25305  
Phone: (304) 558-4058  
Fax: (304) 558-2417  
[msteadman@ag.state.wv.us](mailto:msteadman@ag.state.wv.us)

The Department of Agriculture, Administrative Services Division / Building & Grounds Section, is requesting quotations to provide all labor and materials required to construct a pre-engineered post frame building on the Moorefield Agricultural Complex at 60B Moorefield Industrial Park Road, Moorefield, WV 26836.

**Pre Bid Meeting:**

A mandatory pre-bid meeting for this project will be scheduled. Bidders attending the meeting shall assemble in the Moorefield Agricultural Complex Office Building's Conference Room. All interested parties are required to attend this meeting. Failure to attend the mandatory pre-bid shall result in disqualification of the bid. No one person may represent more than one bidder. An attendance sheet will be made available for all attendees for the official document verifying attendance.

A site visit shall immediately follow the mandatory pre-bid meeting.

No work on this project prior to receipt of the signed purchase order and written notice-to-proceed letter.

Bidder's formal questions must be submitted in writing to Purchasing Division.

Successful Bidder must complete all work and submit a final invoice before May 31, 2010.

**SCOPE OF WORK:**

The work covered under this section of the RFQ specifications consists of furnishing all the labor and materials required to construct a pre-engineered post frame building on the Moorefield Agricultural Complex, as described herein and on any referenced documents and drawings. This building shall be sized at twenty-four (24) foot wide, by eighty (80) foot long, by eighteen (18) foot eave height. Width and length dimensions are outside to outside of secondary wall framing. Height dimensions are from top of finished floor to underside of bottom cord of roof truss.

The east side-wall of this building shall be sheeted solid with one 5' x 7' framed opening centered over the sidewalk. The west side-wall of the building shall be open with columns exposed to a height of twelve (12) foot for seventy (70) feet in length beginning on the northwest corner and extending within ten (10) feet of the southwest corner. The remaining ten (10) feet shall be sheeted solid. Both end-walls of the building shall be sheeted; the north end-wall shall have twelve a (12) foot wide by sixteen (16) foot high framed opening off centered as showed in the WVDA drawings; the south end-wall shall have a five (5) foot wide by seven (7) foot high opening centered over the sidewalk. North and South end-wall roof overhangs are not required. East and West side-wall roof overhangs shall be thirty-six (36) inches wide utilizing gutter, downspout and connected to the existing in-ground drainage.

Work will commence on existing grade.

**GENERAL CONDITIONS:**

**I. BID SUBMITTALS and CONTRACTORS QUALIFICATIONS**

- A. Submit a letter from the building's manufacturer certifying that the building design will meet the criteria of the 2006 International Building Code and other applicable codes required for the State of West Virginia.
- B. The successful bidder must submit Construction Shop Drawings stamped and signed by a professional engineer licensed by the State of West Virginia to the owner for project verification
- C. The Contractor will procure all necessary permits and licenses to comply with all applicable laws, Federal, State or municipal, along with all regulations and ordinances of any regulating body.
- D. Contractor will be responsible for parts and materials as follows:
  1. Contractor will supply all tools, tool accessories, personal safety equipment, and supplies necessary to execute the responsibilities of this Contract. Contractor will be responsible for the removal of all waste and debris on a daily basis, as a result of performing this contract.
  2. Contractor will be responsible for all mileage and travel costs, including travel time, associated with the performance of this contract.

- E. Any and all work to be performed to successfully execute the terms of this Contract by a third party or sub-contractor must be pre-approved by the Owner or their Representative. All such work, after Owner's approval, will remain the sole responsibility of the successful Bidder/Contractor with regard to all labor, materials, fees associated with the sub-contracting and any/all associated responsibilities. Under no circumstances will the Contractor transfer responsibility for any work as described herein by a third party or sub-contractor.
- F. Contractor will furnish any incidental work, materials, labor and equipment that are necessary to complete the project, even if such incidental works are not explicitly included in the contract documents.

## II. MATERIAL/PROJECT SPECIFICATIONS

### A. Building Design

- ✓ 1. 2006 IBC
- ✓ 2. 35-pound roof snow load
- 3. 90MPH wind load, exposure B
- 4. 4-pound roof dead load
- ✓ 5. 5-pound ceiling dead load

### B. Foundations for Embedded Columns

1. The foundations for embedded columns shall be either pre-cast or poured-in-place concrete pads. Footing requirements shall be shown on the construction drawings. Column embedment depth and footing design shall be by the building's manufacturer. Footing concrete shall be a minimum of 4000psi for pre-cast concrete and 3000psi for poured-in-place concrete. Columns shall be installed per the design of the building manufacturer.

### C. Primary Framing

1. Columns shall be No. 1 or better Southern Yellow Pine, pressure treated full-length members with Chromated Copper Arsenate, Type III, to a retention of 0.6pcf and kiln dried after treating to 19 percent maximum moisture content. Columns shall be multiple-pieces of dimensional lumber. Column design and fabrications shall be by the building's manufacturer. Column embedment method shall be the design of the building manufacturer.
2. Roof trusses shall comply with TPI design specifications for Metal Plate Connected Wood Roof Trusses and Quality Standard for Metal Plate Connected Wood Roof Trusses. Truss manufacturer shall have a third party inspection program to verify compliance with requirements of TPI.
3. Trusses shall be stamped with inspection agency identification.
4. Trusses shall be installed per the design of the building's manufacturer.

### D. Secondary Framing

1. Roof purlins and wall girts shall be No. 2 and better, dimension lumber kiln dried to 19 percent maximum moisture content.
2. Girts shall be sized and spaced to meet wind and deflection criteria.
3. Girts shall be face-mounted to exterior side of column.



West Virginia Department of Agriculture      Administrative Service Division, Building & Grounds  
Moorefield Agricultural Complex / Post Frame Building

4. Purlins shall be precision cut to fit between trusses and set flush with the top of the top chord.
  5. Purlins shall set in 20-gauge saddle hangars, attached to the trusses per the building manufacturer's design.
  6. Splashplank shall be No. 2 or better Southern Yellow Pine preservative treated to retention of 0.6pcf of copper naphthenate.
  7. All permanent bracing shall be No. 2 or better dimension lumber.
  8. All secondary framing, purlins, girts and permanent bracing shall be installed per the design of the building manufacturer.
- E. Metal Roofing, Siding, Trims and Flashing
1. 29-gauge, ASTM A 653, Grade 80, galvanized steel with G60 zinc coating both sides.
  2. Exterior surface finish shall be baked on primer and Valspar Weather-X (silicone polyester) finish coat.
  3. Panels shall be roll-formed, 36 inches wide, installed continuously with no end-lap to lengths up to 35 feet.
  4. Panels shall have four major corrugations 0.875 inches high, spaced on 12 inch centers, with three minor corrugations 0.125 high spaced 3 inches on center between each major corrugation.
  5. Panels shall have a support leg with a continuous anti-siphon drain channel on the under lapping corrugation.
  6. Panels shall attach to secondary framing with color-coated #10 piercing screws with 0.25-inch hex head preassembled to 0.5 inch O.D. dome seal or bond seal galvanized steel and APDM washers.
  7. All trims and flashings shall be of the same material and finish outlined for roofing and siding.
  8. All roofing, siding, trims and flashings shall be furnished in a standard color chosen by the owner, from the building manufacturer's standard color chart.
  9. All roofing, siding, trims and flashings shall be installed per the building manufacturer's instructions.
  10. Insulated roof with two (2) inch R6 PF5K faced fiberglass insulation.
  11. Snow retention system shall be installed in accordance to the manufacturer's instructions.
- F. Gutter and Downspouts
1. Gutter shall be continuous 6-inch, K style, 0.032 aluminum gutter, attached to building with the manufacturer's concealed bracket and screw hangars.
  2. 3 inch x 4 inch, 0.024 aluminum downspouts connected to in-ground building drainage with required adaptor. Downspout spacing shall allow for the proper drainage of the gutter.
  3. Gutter and downspout colors shall be chosen by the owner from the manufacturer's standard color chart.
- G. Concrete Construction: Sidewalk
1. Concrete work shall include installation of sidewalks, as shown on the WVDA drawings.
  2. Sidewalk concrete shall be 4 inches thick and shall be broom finished.

**H. Concrete Construction: Mobile Lab Pads**

1. Concrete work shall include installation of four (4) support pads for the Mobile Lab, as shown in the WVDA drawings.
2. The contractor shall furnish and install crushed stone as necessary to allow a 4-inch thick, compacted stone base for each pad.
3. Concrete pad construction shall consist of furnishing and installing a minimum 30 inch x 30 inch pad on grade, 24 inches deep, 4,000 psi concrete, two rebar mats; consisting of #4 rebar spaced on 6-inch centers, placed a minimum of 6 inches from the top and 6 inches from the bottom of each pad.

**I. Roof Overhang**

1. The south sidewall of the building shall have a 36-inch roof overhang, with pre-finished 29-gauge steel fascia. The underside of the overhang shall have no soffit and remain open. Sidewall roof overhang shall be installed the full length of building.

**J. Ridge Vent**

1. The ridgeline of building shall be vented for 70 feet of the buildings' length. Vents shall be 10 foot long and installed continuously, starting 5 foot from end of building. Vents shall be a low profile style with a throat of at least 3-1/2 inches and a free air area of at least 36 square inches per lineal foot. Ridge vents shall be furnished pre-finished in a color to match the roof panels.

**K. Building egress openings**

1. A framed opening in the west-end wall shall be twelve (12) foot wide by sixteen (16) foot high, installed to accommodate a future sectional overhead door; this door shall be furnished and installed by others. The jambs and header of the framed opening shall be suitable for the attachment of this future overhead door. The opening shall be trimmed with 29-gauge pre-finished flashing, leaving no wood frame exposed to the outside.
2. Two framed openings located on the east end-wall and north side-wall shall both be five (5) foot wide by seven (7) foot high, centered on the sidewalks, as indicated on the WVDA drawings, and installed to accommodate a future entry door; these doors shall be furnished and installed by others. The openings shall be trimmed with 29-gauge pre-finished flashing, leaving no wood frame exposed to the outside.

**L. Use of property**

1. Sanitary facilities will not be available. The building contractor will be responsible for the provision and maintenance of portable toilets or their equal.
2. A trailer or temporary storage building may be set on the site by the contractor for all equipment and tools. The location must be approved by the WVDA contact. The Contractor is responsible for his tools, equipment and materials.
3. Access to the work site will generally be Monday thru Friday, between 6:00 a.m. and 5:00 p.m. No holiday or weekend work permitted without prior approval by the WVDA contact.

### III. Warranty

- A. Structural Design – Fifty (50) years: The manufacturer shall warrant that the building will not experience an occurrence of structural failure or damage due to improper design.
- B. Preservative treated lumber – Fifty (50) years: The manufacturer shall warranty against failures due to fungal decay and termite infestation.
- C. Roofing and siding – Forty (40) years: The manufacturer shall warrant the roofing and siding from the date of shipment.
- D. Roof leaks – Five (5) years: the contractor shall warrant the cost to correct any roof leaks.
- E. All other workmanship and materials shall be warranted for two (2) years upon completion of this project.
- F. Warranty documents shall be completed and submitted prior to final invoicing.

### This RFQ also incorporates the following documents:

- Project drawings – Plot (D1), Layout (D2), End Wall (D3) & Concrete (D4)

PLOT (D1)

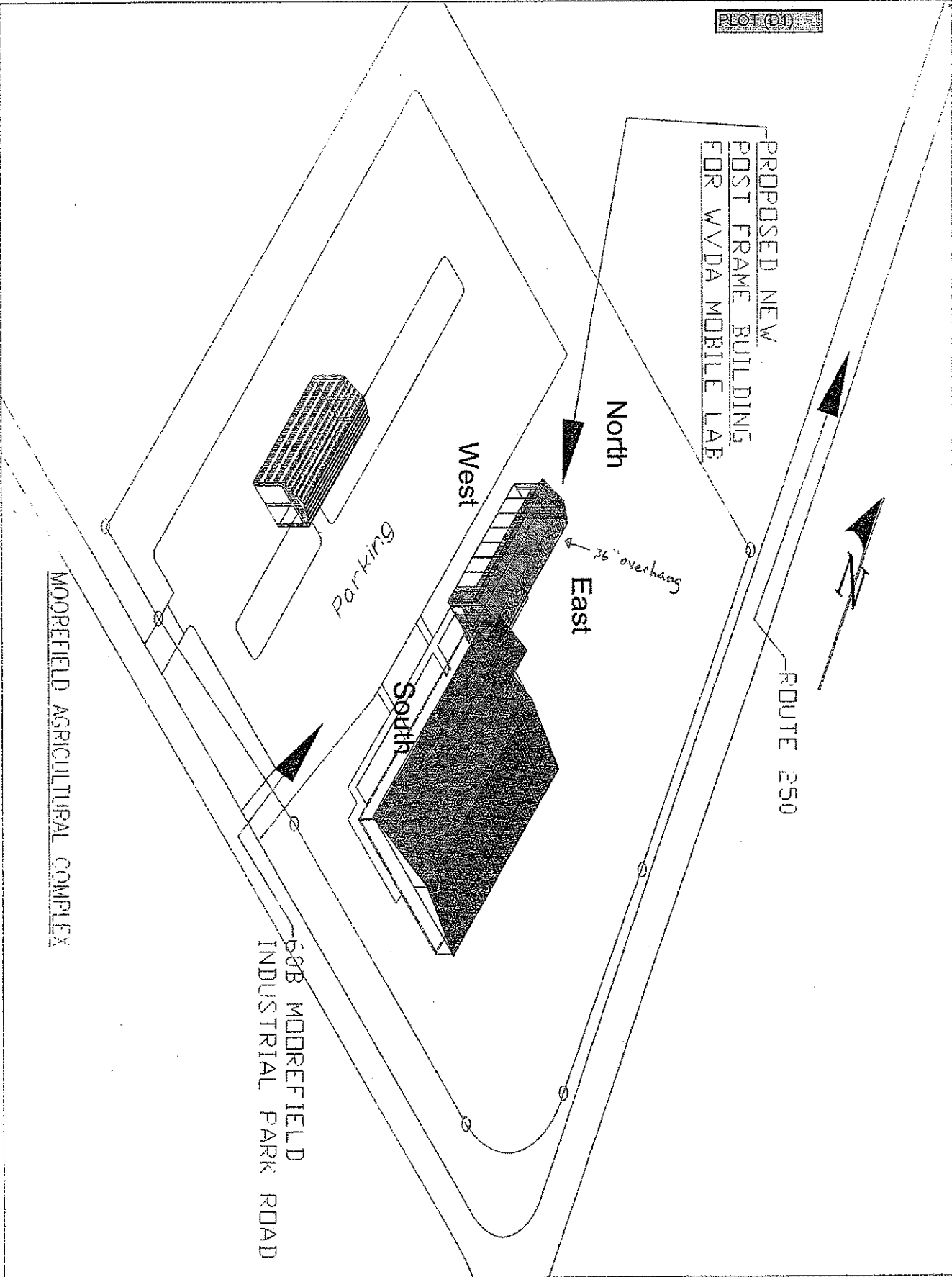

Mobile Lab Storage Building		West Virginia Department of Agriculture	Moorefield Field Office 507 Moorefield Industrial Park Road Moorefield, WV 26033	DATE		SCALE	
Plot Layout				1/24/74	1/24/74	1/24/74	1/24/74

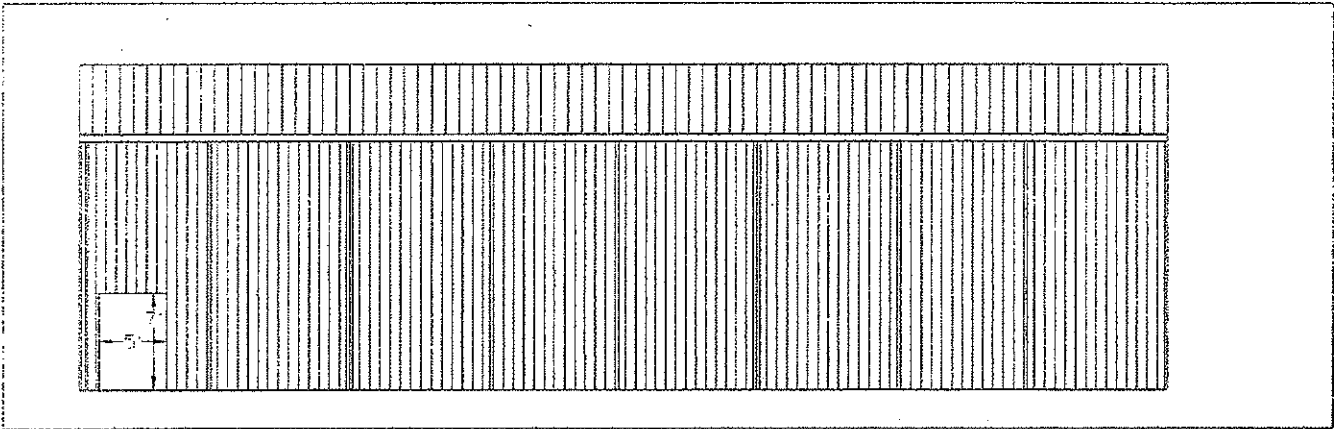

EAST SIDE WALL

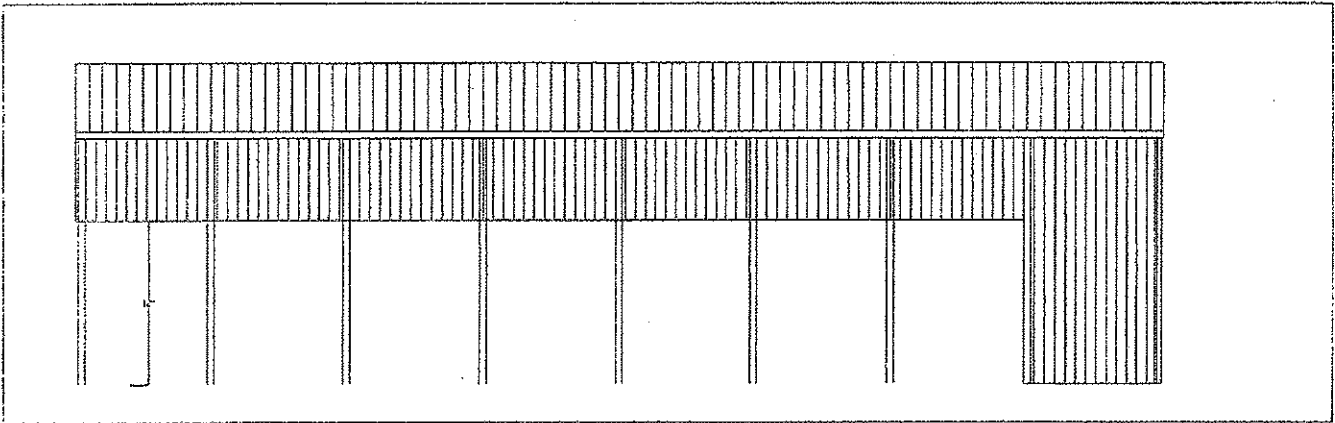

WEST SIDE WALL

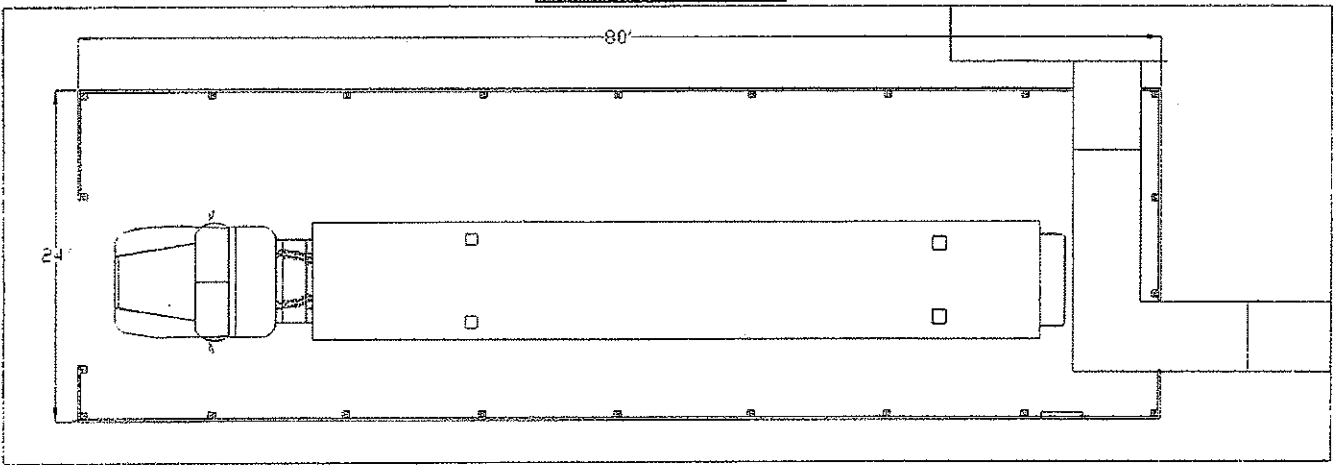

FLOOR PLAN

Mobile Lab Storage Building  
Basic Layout  
West Virginia Department of Agriculture  
609 MacArthur Park Road  
Martinsburg, WV 25404

Microflight Field Office  
609 MacArthur Park Road  
Martinsburg, WV 25404

DATE	BY	APP'D	SCALE

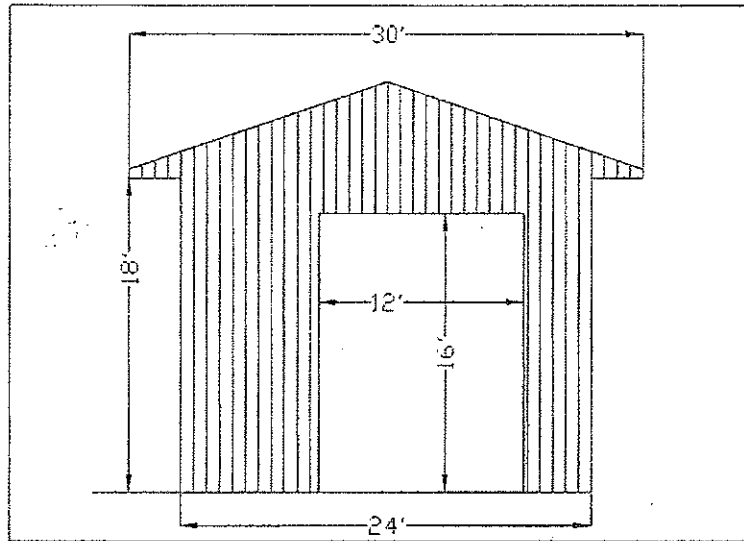

NORTH END WALL

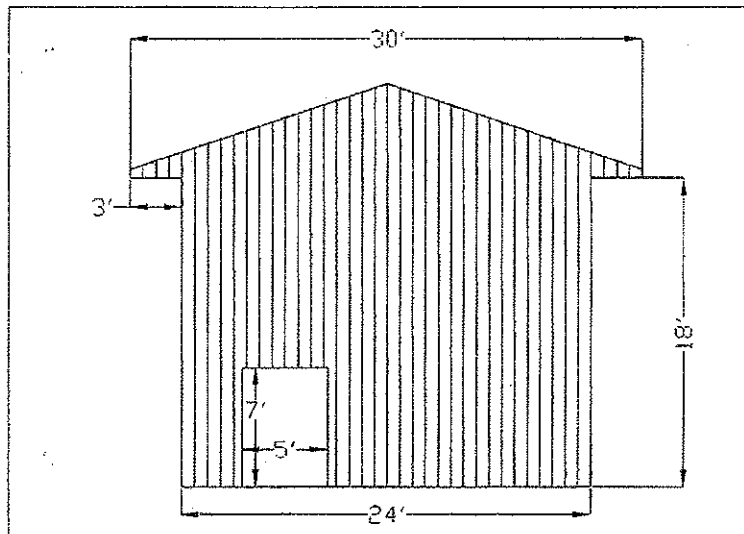

SOUTH END WALL

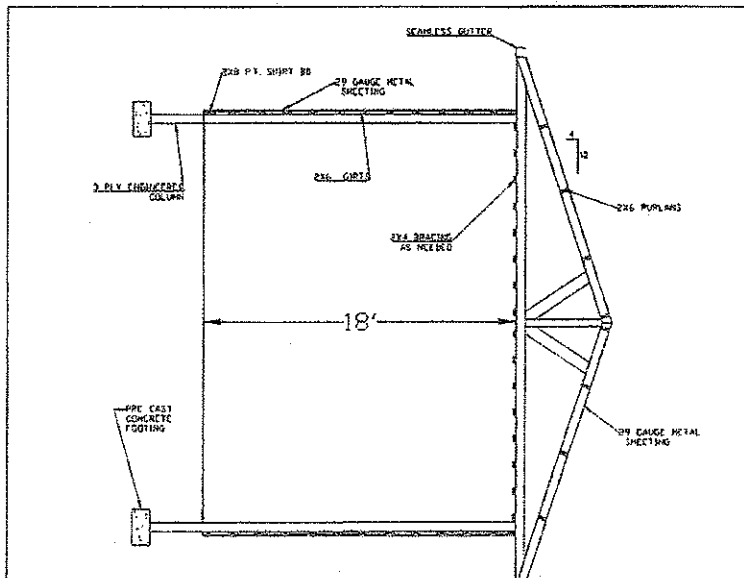

CROSS SECTION

MOOREFIELD FIELD OFFICE 658 Moorefield Industrial Park Road Moorefield, WY 28835		MOOREFIELD FIELD OFFICE 658 Moorefield Industrial Park Road Moorefield, WY 28835	
West Virginia Department of Agriculture		West Virginia Department of Agriculture	
Mobile Lab Storage Building		Mobile Lab Storage Building	
End Wall		End Wall	
DATE: 3/10/6		DATE: 3/10/6	
DRAWN: [blank]		DRAWN: [blank]	
CHECK: [blank]		CHECK: [blank]	
SCALE: [blank]		SCALE: [blank]	

CONCRETE D4

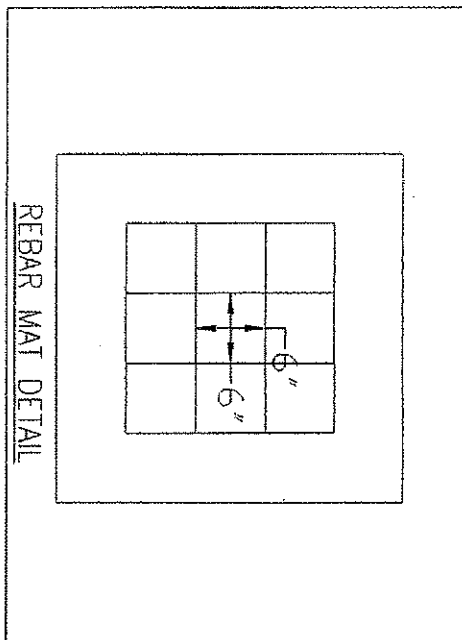
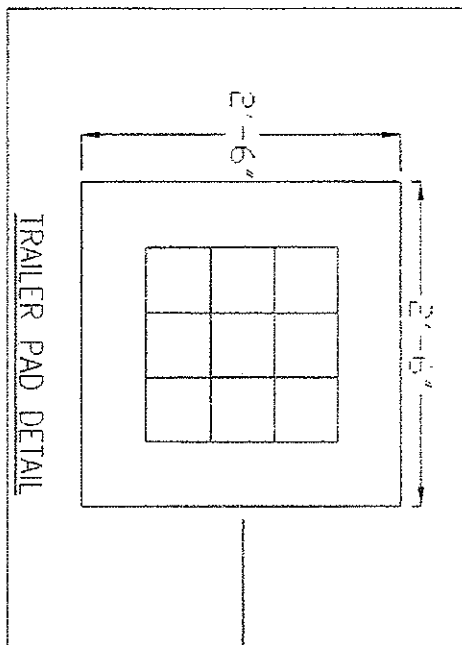
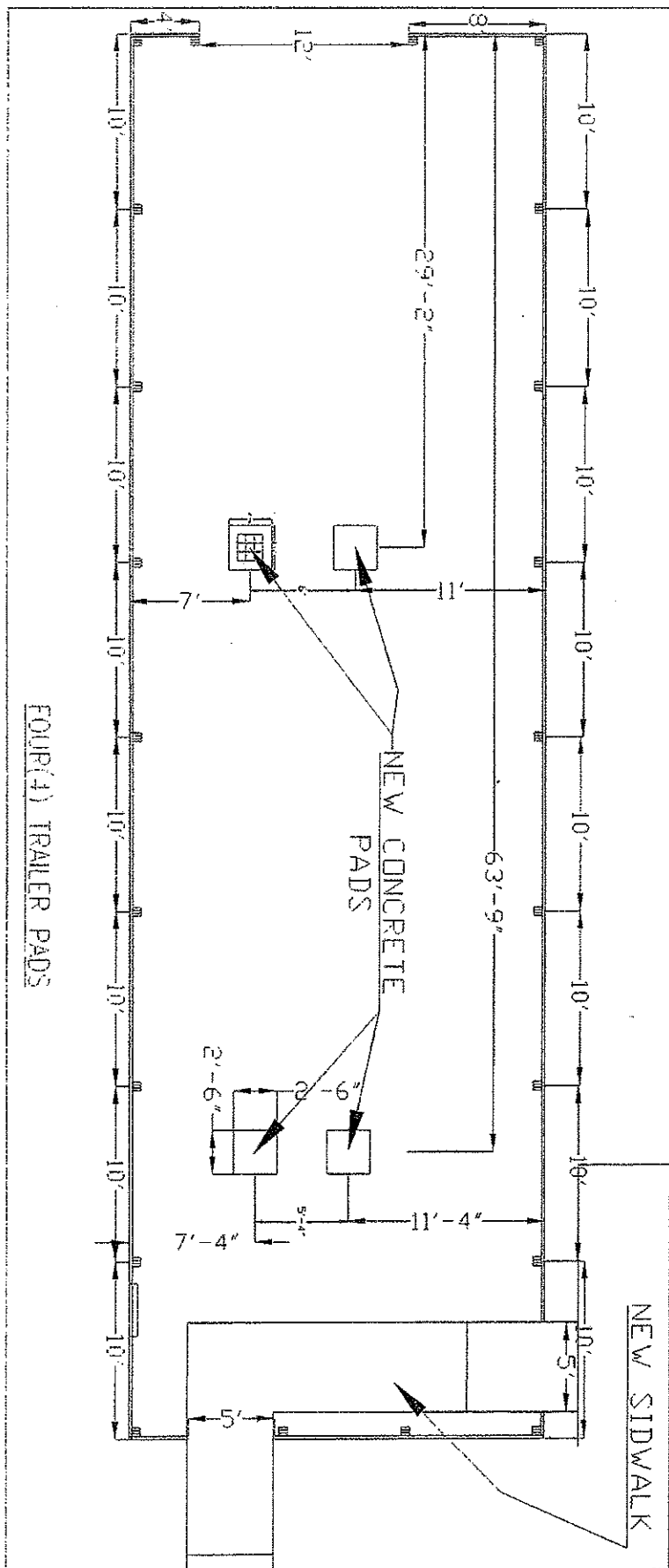



**This is Hansen Pole Buildings. The world's largest online source for pole buildings, DIY steel buildings and shed units, garages and garage kits, convenient barns and more!**



Experience the convenience and ease of a Hansen Pole Building. Our pole buildings are designed to fit your specific plans, wishes and dreams. You pick the size, colors and features of your new building - and we put together quality components - at the best possible price. From our steel buildings like garages and shed units to our pole barn and riding arena, Hansen is

committed to providing you only the highest quality products with impeccable customer service. Whether you're in the market for your own horse arena and horse barn or a pole barn and pole barn building accessories, we've got what you need at competitive prices with 24/7 email support.

What are you going to put in your new building? One of our garage kits is a great investment to protect those valuable "toys". And won't your horses live more

comfortably in a new riding arena or spacious pole barn-Our barns and DIY horse arena and horse barn kits can provide you and your horses or animals with a spacious and cozy living and working environment. We even have a selection of pole barn building accessories for beautifying your new pole building: from stall kits to cupolas, Dutch doors and more.



When it comes to a versatile pole barn, building a Hansen pole barn is the fastest, most reliable route. From our garages and garage kits, to our steel buildings, outdoor shed units and barns, we're the nation's proven leader in pole buildings. From the simplest horse barn to your own affordable riding arena and horse arena, we've got what you're looking for. So step inside and

take a look at our buildings, our customer testimonials and our ease of use. Your search for convenient, attractive and durable structures has ended. Welcome to Hansen Pole Buildings.

For the fastest building quote, click on **FREE QUOTE** to submit your pole building needs. Or, call (866) 200-9657 toll free, 24 hours a day, seven days a week, to leave your information. Most quotes are completed in 24 to 48 hours.

**Free Brochure**  
Click Here to Download



28 Information-Packed Pages  
Download Now!

**Paint Your Building**

Choose from our many colors and see what your building will look like instantly with our paint your building simulator. [Click Here](#)



Powered by dB Masters Multimedia  
FormM@ller



Contact Us | Privacy Policy | Warranty  
Copyright © 2004- 2010 Hansen Pole Buildings, LLC. All rights reserved.

J M Steorts and Associates, LLC  
206 Chase Drive  
Hurricane, WV 25526





**Home**

**Plan Your Building**

**Free Quote**

**Success Stories**

**Photo Gallery**

**Financing**

**FAQs**

**Glossary of Terms**

**About Us**

**Contact Us**

**Customer Login**

**What's New!**

**Free Brochure**  
Click Here



Call Toll Free **1-866-200-9657**

From hay storage to metal garages, convenient prefab sheds to horse barns, even some pole houses. See what customers have done with their versatile Hansen Pole Buildings!!

Hansen Pole Buildings are as diverse as their owners. Here we showcase just a few of the many uses customers have found for our dynamic products. From the simple beauty of horse barns to the adaptability of our metal garages. Each customer has their turn to shine, to show everyone what they've done and how easy it was! Whether a pole barn garage, a versatile steel building or even an arena, people just like you want to see our buildings in action. They want to see you building our pole houses and homes or farm buildings with our cutting edge materials and comprehensive directions. Or, just send us some shots of your garage storage being built. Many of our buildings can be seen in action right here in the photo gallery. Hansen Pole Buildings showcases nearly everything, from hay storage to prefab sheds.



Agricultural



Commercial



Residential

Farm buildings and metal garages have a number of potential uses, many of them on display here. Prefab sheds and pole houses show the real versatility of pole building packages. You will see nearly everything you need to know about a Hansen Pole Buildings pole barn building, from our insulated reflective vapor barrier to the easy to apply steel siding. All of these easy to use steel building products are made to last, whether you're building hay storage, an arena, new horse barns or garage storage. Here are the pictures to prove it! Your pole barn garage could be next!

Once you have your Hansen Pole Buildings pole barn or pole barn garage, send us pictures of you, your family and friends (or your contractor) participating in the fun and excitement of your pole building project. From one of our pole steel building kits for farm buildings, to prefab sheds and garage storage, even all-purpose horse barns or an arena, the Hansen Pole Buildings gallery showcase is a testament to our commitment to quality!



Powered by dB Masters Multimedia  
FormM@iler



Contact Us | Privacy Policy | Warranty  
Copyright © 2004- 2010 Hansen Pole Buildings, LLC. All rights reserved.

BID BOND

KNOW ALL MEN BY THESE PRESENTS, That we, the undersigned, J. M. Steorts & Associates, LLC  
of Hurricane, WV, as Principal, and United States Surety Company  
of Timonium, MD, a corporation organized and existing under the laws of the State of  
MD with its principal office in the City of Timonium, as Surety, are held and firmly bound unto the State  
of West Virginia, as Obligee, in the penal sum of Five Percent of Amount Bid (\$ 5%) for the payment of which,  
well and truly to be made, we jointly and severally bind ourselves, our heirs, administrators, executors, successors and assigns.

The Condition of the above obligation is such that whereas the Principal has submitted to the Purchasing Section of the  
Department of Administration a certain bid or proposal, attached hereto and made a part hereof, to enter into a contract in writing for  
RFQ #AGR1012 - Construction of a Pre-Engineered Post-Frame Building in Moorefield - According to Plans &  
Specifications

NOW THEREFORE,

(a) If said bid shall be rejected, or  
(b) If said bid shall be accepted and the Principal shall enter into a contract in accordance with the bid or proposal attached  
hereto and shall furnish any other bonds and insurance required by the bid or proposal, and shall in all other respects perform the  
agreement created by the acceptance of said bid, then this obligation shall be null and void, otherwise this obligation shall remain in full  
force and effect. It is expressly understood and agreed that the liability of the Surety for any and all claims hereunder shall, in no event,  
exceed the penal amount of this obligation as herein stated.

The Surety, for the value received, hereby stipulates and agrees that the obligations of said Surety and its bond shall be in no  
way impaired or affected by any extension of the time within which the Obligee may accept such bid, and said Surety does hereby  
waive notice of any such extension.

IN WITNESS WHEREOF, Principal and Surety have hereunto set their hands and seals, and such of them as are corporations  
have caused their corporate seals to be affixed hereunto and these presents to be signed by their proper officers, this  
18th day of February, 2010.

Principal Corporate Seal

J. M. Steorts & Associates, LLC  
(Name of Principal)

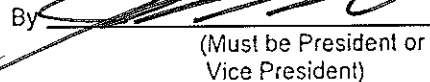
By:   
(Must be President or  
Vice President)

Jason M. Steorts Managing Member  
(Title)

Surety Corporate Seal

United States Surety Company  
(Name of Surety)

By:   
Patricia A. Moye, WV Resident Agent Attorney-in-Fact

IMPORTANT – Surety executing bonds must be licensed in West Virginia to transact surety insurance. Corporate seals must be affixed,  
and a power of attorney must be attached.

**VOID**  
**POWER OF ATTORNEY**

AMERICAN CONTRACTORS INDEMNITY COMPANY UNITED STATES SURETY COMPANY U.S. SPECIALTY INSURANCE COMPANY

KNOW ALL MEN BY THESE PRESENTS: That American Contractors Indemnity Company, a California corporation, United States Surety Company, a Maryland corporation, and U.S. Specialty Insurance Company, a Texas corporation (collectively, the "Companies"), do by these presents make, constitute and appoint: **Gregory T. Gordon, Larry D. Kerr, Allan L. McVey, Patricia A. Moye, Kimberly J. Wilkinson**

its true and lawful Attorney(s)-in-fact, each in their separate capacity if more than one is named above, with full power and authority hereby conferred in its name, place and stead, to execute, acknowledge and deliver any and all bonds, recognizances, undertakings or other instruments or contracts of suretyship to include riders, amendments, and consents of surety. This Power of Attorney is granted under and by authority of the following resolutions adopted by the Boards of Directors of the Companies:

Be it Resolved, that the President, any Vice-President, any Assistant Vice-President, any Secretary or any Assistant Secretary shall be and is hereby vested with full power and authority to appoint any one or more suitable persons as Attorney(s)-in-Fact to represent and act for and on behalf of the Company subject to the following provisions:

Attorney-in-fact may be given full power and authority for and in the name of and on behalf of the Company, to execute, acknowledge and deliver, any and all bonds, recognizances, contracts, agreements or indemnity and other conditional or obligatory undertakings and any and all notices and documents canceling or terminating the Company's liability thereunder, and any such instruments so executed by any such Attorney-in-Fact shall be binding upon the Company as if signed by the President and sealed and effected by the Corporate Secretary.

Be it Resolved, that the signature of any authorized officer and seal of the Company heretofore or hereafter affixed to any power of attorney or any certificate relating thereto by facsimile, and any power of attorney or certificate bearing facsimile signature or facsimile seal shall be valid and binding upon the Company with respect to any bond or undertaking to which it is attached.

IN WITNESS WHEREOF, the Companies have caused this instrument to be signed and their corporate seals to be hereto affixed, this 25<sup>th</sup> day of July, 2008.

AMERICAN CONTRACTORS INDEMNITY COMPANY UNITED STATES SURETY COMPANY U.S. SPECIALTY INSURANCE COMPANY  
Corporate Seals



By:

  
Peter W. Carman, Vice President

State of Maryland  
County of Baltimore SS:

On this 4th day of December, 2008, before me, Jean Grzymala, a notary public, personally appeared Peter W. Carman, Vice President of American Contractors Indemnity Company, United States Surety Company and U.S. Specialty Insurance Company who proved to me on the basis of satisfactory evidence to be the person whose name is subscribed to the within instrument and acknowledged to me that he executed the same in his authorized capacity, and that by his signature on the instrument the person(s), or the entity upon behalf of which the person(s) acted, executed the instrument.

I certify under PENALTY OF PERJURY under the laws of the State of Maryland that the foregoing paragraph is true and correct. WITNESS my hand and official seal.

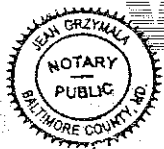

Signature

  
My commission expires the 15<sup>th</sup> day of December, 2012

I, Carol T. Nevin, Assistant Secretary of American Contractors Indemnity Company, United States Surety Company and U.S. Specialty Insurance Company, do hereby certify that the above and foregoing is a true and correct copy of a Power of Attorney, executed by said Companies, which is still in full force and effect; furthermore, the resolutions of the Boards of Directors, set out in the Power of Attorney are in full force and effect.

In Witness Whereof, I have hereunto set my hand and affixed the seals of said Companies at Baltimore, Maryland this 18<sup>th</sup> day of February, 2010

Corporate Seals

  
Carol T. Nevin, Assistant Secretary





State of West Virginia  
DRUG FREE WORKPLACE CONFORMANCE AFFIDAVIT  
West Virginia Code §21-1D-5

STATE OF WEST VIRGINIA

COUNTY OF PUTNAM, TO-WIT:

I, JASON STEORTS, after being first duly sworn, depose and state as follows:

- 1. I am an employee of J.M. STEORTS & ASSOCS.; and,  
(Company Name)
- 2. I do hereby attest that J.M. STEORTS & ASSOCIATES  
(Company Name)

maintains a valid written drug free workplace policy and that such policy is in compliance with **West Virginia Code** §21-1D-5.

The above statements are sworn to under the penalty of perjury.

J.M. STEORTS & ASSOCIATES  
(Company Name)

By: [Signature]

Title: OWNER

Date: 2-23-10

Taken, subscribed and sworn to before me this 23 day of February, 2010

By Commission expires July 24, 2018

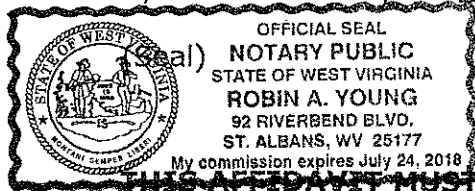

[Signature]  
(Notary Public)

**THIS AFFIDAVIT MUST BE SUBMITTED WITH THE BID IN ORDER TO COMPLY WITH WV CODE PROVISIONS. FAILURE TO INCLUDE THE AFFIDAVIT WITH THE BID SHALL RESULT IN DISQUALIFICATION OF THE BID.**

STATE OF WEST VIRGINIA  
Purchasing Division

**PURCHASING AFFIDAVIT**

West Virginia Code §5A-3-10a states: No contract or renewal of any contract may be awarded by the state or any of its political subdivisions to any vendor or prospective vendor when the vendor or prospective vendor or a related party to the vendor or prospective vendor is a debtor and the debt owed is an amount greater than one thousand dollars in the aggregate.

**DEFINITIONS:**

"Debt" means any assessment, premium, penalty, fine, tax or other amount of money owed to the state or any of its political subdivisions because of a judgment, fine, permit violation, license assessment, defaulted workers' compensation premium, penalty or other assessment presently delinquent or due and required to be paid to the state or any of its political subdivisions, including any interest or additional penalties accrued thereon.

"Debtor" means any individual, corporation, partnership, association, limited liability company or any other form or business association owing a debt to the state or any of its political subdivisions. "Political subdivision" means any county commission; municipality; county board of education; any instrumentality established by a county or municipality; any separate corporation or instrumentality established by one or more counties or municipalities, as permitted by law; or any public body charged by law with the performance of a government function or whose jurisdiction is coextensive with one or more counties or municipalities. "Related party" means a party, whether an individual, corporation, partnership, association, limited liability company or any other form or business association or other entity whatsoever, related to any vendor by blood, marriage, ownership or contract through which the party has a relationship of ownership or other interest with the vendor so that the party will actually or by effect receive or control a portion of the benefit, profit or other consideration from performance of a vendor contract with the party receiving an amount that meets or exceeds five percent of the total contract amount.

**EXCEPTION:** The prohibition of this section does not apply where a vendor has contested any tax administered pursuant to chapter eleven of this code, workers' compensation premium, permit fee or environmental fee or assessment and the matter has not become final or where the vendor has entered into a payment plan or agreement and the vendor is not in default of any of the provisions of such plan or agreement.

Under penalty of law for false swearing (*West Virginia Code §61-5-3*), it is hereby certified that the vendor affirms and acknowledges the information in this affidavit and is in compliance with the requirements as stated.

**WITNESS THE FOLLOWING SIGNATURE**

Vendor's Name: J.M. STEORTS & ASSOCIATES

Authorized Signature: [Signature] Date: 2-22-10

State of W.V.

County of PUTNAM, to-wit:

Taken, subscribed, and sworn to before me this 23 day of February, 2010.

My Commission expires July 24, 2018.

AFFIX SEAL HERE

NOTARY PUBLIC [Signature]

