

Window Based
Bid Schedule / Cost Proposal

Quantity	Description	Price for Each	Extended Amount
8 each	Digital Video Recorders per specifications	\$ <u>4649.63</u>	\$ <u>37197.00</u>
8 each	Uninterruptible Power Supply	\$ <u>150.00</u>	\$ <u>1,200.00</u>
8 each	16 channel Power Supply	\$ <u>129.38</u>	\$ <u>1,035.00</u>
53 each	Sony SPE-110 (or equal) vandal proof dome camera with 3.5-8mm auto focusing lens for indoor use	\$ <u>152.50</u>	\$ <u>8,082.50</u>
10 each	License Plate Recognition Ultra Sensitivity Color CCD (SPE-LP50) camera (or equal) with 5 - 50 mm varifocal lens for outdoor use	\$ <u>250.00</u>	\$ <u>2,500.00</u>
1 job	Mounting brackets, cable and cable terminations with a minimum of 3' length, conduit and junction boxes, other miscellaneous hardware and network equipment.	\$ _____	\$ <u>8337.96</u>
1 job	Required software for security system	\$ _____	\$ <u>Ø</u>
1 job	Labor costs	\$ _____	\$ <u>22,500.00</u>
	All other costs (please specify)	\$ _____	\$ _____
	Grand Total	\$ _____	\$ <u>80,852.46</u>



State of West Virginia
 Department of Administration
 Purchasing Division
 2019 Washington Street East
 Post Office Box 50130
 Charleston, WV 25305-0130

Request for Quotation

RFQ NUMBER
 PSH90063

PAGE
 1

ADDRESS CORRESPONDENCE TO: ATTENTION OF:
 ROBERTA WAGNER
 304-558-0067

VENDOR

Longs' Security Camera Systems MS
 LLC
 102 38th Street SE
 Charleston, WV 25304

SHIP TO

HEALTH AND HUMAN RESOURCES
 PINECREST HOSPITAL
 105 SOUTH EISENHOWER DRIVE
 BECKLEY, WV 25801
 304-256-6614

DATE PRINTED	TERMS OF SALE	SHIP VIA	F.O.B.	FREIGHT TERMS
11/25/2008				

OPENING DATE	BID OPENING TIME			01:30 PM
01/08/2009				

LINE	QUANTITY	UOP	CAT NO	ITEM NUMBER	UNIT PRICE	AMOUNT
0001	8	EA		936-73		
DIGITAL VIDEO RECORDERS PER SPECIFICATIONS INQUIRIES: WRITTEN QUESTIONS SHALL BE ACCEPTED THROUGH CLOSE OF BUSINESS ON 12/18/2008. QUESTIONS MAY BE SENT VIA USPS, FAX, COURIER OR E-MAIL. IN ORDER TO ASSURE NO VENDOR RECEIVES AN UNFAIR ADVANTAGE, NO SUBSTANTIVE QUESTIONS WILL BE ANSWERED ORALLY. IF POSSIBLE, E-MAIL QUESTIONS ARE PREFERRED. ADDRESS INQUIRIES TO: ROBERTA WAGNER DEPARTMENT OF ADMINISTRATION PURCHASING DIVISION 2019 WASHINGTON STREET EAST CHARLESTON, WV 25311 FAX: 304-558-4112 E-MAIL: ROBERTA.A.WAGNER@WV.GOV						

 BID BOND AND PURCHASING AFFIDAVIT REQUIRED WITH BID SUBMISSION.

 MANDATORY PRE-BID MEETING ON 12/16/2008 AT 10:00 AM IN ROOM #B109 AT PINECREST HOSPITAL LOCATED AT 105 E. EISENHOWER DRIVE, BECKLEY, WV 25801.

RECEIVED
 2009 JAN 15 PM 1:07
 WV PURCHASING DIVISION

SEE REVERSE SIDE FOR TERMS AND CONDITIONS

SIGNATURE: *Robert A. Wagner* TITLE: President FEIN: 203881880

TELEPHONE: 304-925-0330 DATE: 1-15-09

ADDRESS CHANGES TO BE NOTED ABOVE

PRINT NAME AND ADDRESS IN SPACE ABOVE LABELED 'VENDOR'

GENERAL TERMS & CONDITIONS
REQUEST FOR QUOTATION (RFQ) AND REQUEST FOR PROPOSAL (RFP)

1. Awards will be made in the best interest of the State of West Virginia.
2. The State may accept or reject in part, or in whole, any bid.
3. All quotations are governed by the *West Virginia Code* and the *Legislative Rules* of the Purchasing Division.
4. Prior to any award, the apparent successful vendor must be properly registered with the Purchasing Division and have paid the required \$125 fee.
5. All services performed or goods delivered under State Purchase Order/Contracts are to be continued for the term of the Purchase Order/Contracts, contingent upon funds being appropriated by the Legislature or otherwise being made available. In the event funds are not appropriated or otherwise available for these services or goods, this Purchase Order/Contract becomes void and of no effect after June 30.
6. Payment may only be made after the delivery and acceptance of goods or services.
7. Interest may be paid for late payment in accordance with the *West Virginia Code*.
8. Vendor preference will be granted upon written request in accordance with the *West Virginia Code*.
9. The State of West Virginia is exempt from federal and state taxes and will not pay or reimburse such taxes.
10. The Director of Purchasing may cancel any Purchase Order/Contract upon 30 days written notice to the seller.
11. The laws of the State of West Virginia and the *Legislative Rules* of the Purchasing Division shall govern all rights and duties under the Contract, including without limitation the validity of this Purchase Order/Contract.
12. Any reference to automatic renewal is hereby deleted. The Contract may be renewed only upon mutual written agreement of the parties.
13. **BANKRUPTCY:** In the event the vendor/contractor files for bankruptcy protection, this Contract may be deemed null and void, and terminated without further order.
14. **HIPAA BUSINESS ASSOCIATE ADDENDUM:** The West Virginia State Government HIPAA Business Associate Addendum (BAA), approved by the Attorney General, and available online at the Purchasing Division's web site (<http://www.state.wv.us/admin/purchase/vrc/hipaa.htm>) is hereby made part of the agreement. Provided that, the Agency meets the definition of a Cover Entity (45 CFR §160.103) and will be disclosing Protected Health Information (45 CFR §160.103) to the vendor.
15. **WEST VIRGINIA ALCOHOL & DRUG-FREE WORKPLACE ACT:** If this Contract constitutes a public improvement construction contract as set forth in Article 1D, Chapter 21 of the West Virginia Code ("The West Virginia Alcohol and Drug-Free Workplace Act"), then the following language shall hereby become part of this Contract: "The contractor and its subcontractors shall implement and maintain a written drug-free workplace policy in compliance with the West Virginia Alcohol and Drug-Free Workplace Act, as set forth in Article 1D, Chapter 21 of the West Virginia Code. The contractor and its subcontractors shall provide a sworn statement in writing, under the penalties of perjury, that they maintain a valid drug-free work place policy in compliance with the West Virginia and Drug-Free Workplace Act. It is understood and agreed that this Contract shall be cancelled by the awarding authority if the Contractor: 1) Fails to implement its drug-free workplace policy; 2) Fails to provide information regarding implementation of the contractor's drug-free workplace policy at the request of the public authority; or 3) Provides to the public authority false information regarding the contractor's drug-free workplace policy."

INSTRUCTIONS TO BIDDERS

1. Use the quotation forms provided by the Purchasing Division.
2. **SPECIFICATIONS:** Items offered must be in compliance with the specifications. Any deviation from the specifications must be clearly indicated by the bidder. Alternates offered by the bidder as **EQUAL** to the specifications must be clearly defined. A bidder offering an alternate should attach complete specifications and literature to the bid. The Purchasing Division may waive minor deviations to specifications.
3. Complete all sections of the quotation form.
4. Unit prices shall prevail in case of discrepancy.
5. All quotations are considered F.O.B. destination unless alternate shipping terms are clearly identified in the quotation.
6. **BID SUBMISSION:** All quotations must be delivered by the bidder to the office listed below prior to the date and time of the bid opening. Failure of the bidder to deliver the quotations on time will result in bid disqualifications: Department of Administration, Purchasing Division, 2019 Washington Street East, P.O. Box 50130, Charleston, WV 25305-0130



State of West Virginia
 Department of Administration
 Purchasing Division
 2019 Washington Street East
 Post Office Box 50130
 Charleston, WV 25305-0130

Request for Quotation

RFO NUMBER
 PSH90063

PAGE
 2

ADDRESS CORRESPONDENCE TO ATTENTION OF:
 ROBERTA WAGNER
 804-558-0067

SHIP TO

HEALTH AND HUMAN RESOURCES
 PINECREST HOSPITAL
 105 SOUTH EISENHOWER DRIVE
 BECKLEY, WV 25801
 304-256-6614

VENDOR

*119161134 304-925-0338
 LONGS SECURITY CAMERA SYSTEMS
 102 38TH ST SE
 CHARLESTON WV 25304

DATE PRINTED	TERMS OF SALE	SHIP VIA	F.O.B.	FREIGHT TERMS
11/25/2008				
OPENING DATE:	01/08/2009	BID OPENING TIME 01:30PM		

LINE	QUANTITY	UOP	CAT NO.	ITEM NUMBER	UNIT PRICE	AMOUNT
<p>THE MODEL/BRAND/SPECIFICATIONS NAMED HEREIN ESTABLISH THE ACCEPTABLE LEVEL OF QUALITY ONLY AND ARE NOT INTENDED TO REFLECT A PREFERENCE OR FAVOR ANY PARTICULAR BRAND OR VENDOR. VENDORS WHO ARE BIDDING ALTERNATES SHOULD SO STATE AND INCLUDE PERTINENT LITERATURE AND SPECIFICATIONS. FAILURE TO PROVIDE INFORMATION FOR ANY ALTERNATES MAY BE GROUNDS FOR REJECTION OF THE BID. THE STATE RESERVES THE RIGHT TO WAIVE MINOR IRREGULARITIES IN BIDS OR SPECIFICATIONS IN ACCORDANCE WITH SECTION 148-1-4(F) OF THE WEST VIRGINIA LEGISLATIVE RULES AND REGULATIONS. EXHIBIT 5</p> <p>WEST VIRGINIA CODE 21-1D-5 PROVIDES THAT: ANY SOLICITATION FOR A PUBLIC IMPROVEMENT CONSTRUCTION CONTRACT REQUIRES EACH VENDOR THAT SUBMITS A BID FOR THE WORK TO SUBMIT AT THE SAME TIME AN AFFIDAVIT OF COMPLIANCE WITH THE BID. THE ENCLOSED PURCHASING AFFIDAVIT MUST BE SIGNED AND SUBMITTED WITH THE BID AS EVIDENCE OF THE VENDOR'S COMPLIANCE WITH THE PROVISIONS OF ARTICLE 1D, CHAPTER 21 OF THE WEST VIRGINIA CODE. FAILURE TO SUBMIT THE SIGNED PURCHASING AFFIDAVIT WITH THE BID SHALL RESULT IN DISQUALIFICATION OF SUCH BID.</p> <p>NOTICE TO PROCEED: THIS CONTRACT IS TO BE PERFORMED WITHIN 60 CALENDAR DAYS AFTER THE NOTICE TO PROCEED IS RECEIVED. UNLESS OTHERWISE SPECIFIED, THE FULLY EXECUTED PURCHASE ORDER WILL BE CONSIDERED NOTICE TO PROCEED.</p> <p>CANCELLATION: THE DIRECTOR OF PURCHASING RESERVES THE</p>						

SIGNATURE _____ TELEPHONE _____ DATE _____
 FEIN _____
 ADDRESS CHANGES TO BE NOTED ABOVE
 VENDOR NAME AND ADDRESS IN SPACE ABOVE LABELED 'VENDOR'



State of West Virginia
 Department of Administration
 Purchasing Division
 2019 Washington Street East
 Post Office Box 50130
 Charleston, WV 25305-0130

Request for Quotation

RFQ NUMBER
 PSH90063

PAGE
 3

ADDRESS CORRESPONDENCE TO ATTENTION OF:
 ROBERTA WAGNER
 304-558-0067

VENDOR

*119161134 304-925-0338
 LONGS SECURITY CAMERA SYSTEMS
 102 38TH ST SE
 CHARLESTON WV 25304

SHIP TO

HEALTH AND HUMAN RESOURCES
 PINECREST HOSPITAL
 105 SOUTH EISENHOWER DRIVE
 BECKLEY, WV 25801 304-256-6614

DATE PRINTED	TERMS OF SALE	SHIP VIA	F.O.B.	FREIGHT TERMS
--------------	---------------	----------	--------	---------------

BID OPENING DATE: 11/25/2008	BID OPENING TIME: 01:30PM
------------------------------	---------------------------

LINE	QUANTITY	UOP	CAT NO	ITEM NUMBER	UNIT PRICE	AMOUNT
<p>RIGHT TO CANCEL THIS CONTRACT IMMEDIATELY UPON WRITTEN NOTICE TO THE VENDOR IF THE MATERIALS OR WORKMANSHIP SUPPLIED ARE OF AN INFERIOR QUALITY OR DO NOT CONFORM WITH THE SPECIFICATIONS OF THE BID AND CONTRACT HERE IN.</p> <p>WAGE RATES: THE CONTRACTOR OR SUBCONTRACTOR SHALL PAY THE HIGHER OF THE U.S. DEPARTMENT OF LABOR MINIMUM WAGE RATES AS ESTABLISHED FOR RALEIGH COUNTY, PURSUANT TO WEST VIRGINIA CODE 21-5A, ET, SEQ. (PREVAILING WAGE RATES APPLY TO THIS PROJECT)</p> <p>ARBITRATION: ANY REFERENCES MADE TO ARBITRATION OR INTEREST FOR PAYMENTS DUE (EXCEPT FOR ANY INTEREST REQUIRED BY STATE LAW) CONTAINED IN THIS CONTRACT OR IN ANY AMERICAN INSTITUTE OF ARCHITECTS DOCUMENTS PERTAINING TO THIS CONTRACT ARE HEREBY DELETED.</p> <p>WORKERS' COMPENSATION: VENDOR IS REQUIRED TO PROVIDE A CERTIFICATE FROM WORKERS' COMPENSATION IF SUCCESSFUL.</p> <p>ALL OF THE ITEMS CHECKED BELOW WILL BE A REQUIREMENT OF THIS CONTRACT:</p> <p><input checked="" type="checkbox"/> INSURANCE: SUCCESSFUL VENDOR SHALL FURNISH PROOF OF COMMERCIAL GENERAL LIABILITY INSURANCE PRIOR TO ISSUANCE OF CONTRACT. UNLESS OTHERWISE SPECIFIED IN THE BID DOCUMENTS, THE MINIMUM AMOUNT OF INSURANCE COVERAGE REQUIRED IS \$250,000.</p> <p><input type="checkbox"/> BUILDERS RISK INSURANCE: SUCCESSFUL VENDOR SHALL FURNISH PROOF OF BUILDERS RISK - ALL RISK INSURANCE IN AN AMOUNT EQUAL TO 100% OF THE AMOUNT OF THE CONTRACT.</p> <p><input checked="" type="checkbox"/> BONDS: FIVE PERCENT (5%) OF THE TOTAL AMOUNT OF THE BID PAYABLE TO THE STATE OF WEST VIRGINIA, SHALL BE</p>						

SIGNATURE _____ TITLE _____ FEIN _____ TELEPHONE _____ DATE _____

SEE REVERSE SIDE FOR TERMS AND CONDITIONS

ADDRESS CHANGES TO BE NOTED ABOVE

INSERT NAME AND ADDRESS IN SPACE ABOVE LABELED 'VENDOR'



State of West Virginia
 Department of Administration
 Purchasing Division
 2019 Washington Street East
 Post Office Box 50130
 Charleston, WV 25305-0130

Request for Quotation

RFO NUMBER
 PSH90063

PAGE
 4

ADDRESS CORRESPONDENCE TO ATTENTION OF:
 ROBERTA WAGNER
 304-558-0067

*119161134 304-925-0338
 LONGS SECURITY CAMERA SYSTEMS
 102 38TH ST SE
 CHARLESTON WV 25304

SHIP TO
 HEALTH AND HUMAN RESOURCES
 PINECREST HOSPITAL
 105 SOUTH EISENHOWER DRIVE
 BECKLEY, WV 25801 304-256-6614

DATE PRINTED	TERMS OF SALE	SHIP VIA	F.O.B.	FREIGHT TERMS
11/25/2008				

BID OPENING DATE:	BID OPENING TIME
01/08/2009	01:30PM

LINE	QUANTITY	UOP	CAT NO.	ITEM NUMBER	UNIT PRICE	AMOUNT
<p>SUBMITTED WITH EACH BID AS A BID BOND. THE SUCCESSFUL BIDDER SHALL ALSO FURNISH A PERFORMANCE BOND AND LABOR/MATERIAL BOND FOR 100% OF THE AMOUNT OF THE CONTRACT. BONDS MAY BE PROVIDED IN THE FORM OF A CERTIFIED CHECK, IRREVOCABLE LETTER OF CREDIT, OR BOND FURNISHED BY A SOLVENT SURETY COMPANY AUTHORIZED TO DO BUSINESS IN THE STATE OF WEST VIRGINIA. A LETTER OF CREDIT SUBMITTED IN LIEU OF A BOND WILL ONLY BE ALLOWED FOR PROJECTS UNDER \$100,000. PERSONAL OR BUSINESS CHECKS ARE NOT ACCEPTABLE IN LIEU OF THE 5% BID BOND. PERFORMANCE BOND, OR LABOR AND MATERIAL BOND.</p> <p>() MAINTENANCE BOND: A TWO (2) YEAR MAINTENANCE BOND COVERING THE ROOFING SYSTEM WILL BE A REQUIREMENT OF THE SUCCESSFUL VENDOR.</p> <p>REV 11/00</p> <p>EXHIBIT 7</p> <p>DOMESTIC ALUMINUM GLASS & STEEL IN PUBLIC WORKS PROJECTS</p> <p>IN ACCORDANCE WITH WEST VIRGINIA CODE §-19-1 ET. SEQ., EVERY CONTRACT FOR CONSTRUCTION, RECONSTRUCTION, ALTERATION, REPAIR, IMPROVEMENT OR MAINTENANCE OF PUBLIC WORKS WHERE THE COST IS MORE THAN \$50,000 AND, IN THE CASE OF STEEL ONLY, WHERE THE COST OF STEEL IS MORE THAN \$50,000 OR WHERE MORE THAN 10,000 POUNDS OF STEEL ARE REQUIRED, THE STATE WILL ACCEPT ONLY ALUMINUM GLASS, OR STEEL PRODUCTS PRODUCED IN THE UNITED STATES. IN ADDITION, ITEMS OF MACHINERY OR EQUIPMENT PURCHASED FOR USE AT THE SITE OF PUBLIC WORKS SHALL BE MADE OF DOMESTIC ALUMINUM GLASS OR STEEL, UNLESS THE COST OF THE PRODUCT IS LESS THAN \$50,000 OR LESS THAN 10,000</p>						

SEE REVERSE SIDE FOR TERMS AND CONDITIONS

SIGNATURE _____ TELEPHONE _____ DATE _____

TITLE _____

ADDRESS CHANGES TO BE NOTED ABOVE

INSERT NAME AND ADDRESS IN SPACE ABOVE LABELED 'VENDOR'



State of West Virginia
 Department of Administration
 Purchasing Division
 2019 Washington Street East
 Post Office Box 50130
 Charleston, WV 25305-0130

Request for Quotation

RFQ NUMBER
 PSH90063

PAGE
 5

ADDRESS CORRESPONDENCE TO ATTENTION OF:
 ROBERTA WAGNER
 304-558-0067

VENDOR

*119161134 304-925-0338
 LONGS SECURITY CAMERA SYSTEMS
 102 38TH ST SE
 CHARLESTON WV 25304

SHIP TO

HEALTH AND HUMAN RESOURCES
 PINECREST HOSPITAL
 105 SOUTH EISENHOWER DRIVE
 BECKLEY, WV 25801
 304-256-6614

DATE PRINTED	TERMS OF SALE	SHIP VIA	F.O.B.	FREIGHT TERMS
11/25/2008	01/08/2009			

BID OPENING DATE:	BID OPENING TIME	AMOUNT
11/25/2008	01:30 PM	

LINE	QUANTITY	UOP	CAT NO.	ITEM NUMBER	UNIT PRICE	AMOUNT
<p>POUNDS OF STEEL ARE USED IN PUBLIC WORKS PROJECTS.</p> <p>FOREIGN MADE ALUMINUM, GLASS OR STEEL PRODUCTS MAY BE ACCEPTED ONLY IF THE COST OF DOMESTIC PRODUCTS IS FOUND TO BE UNREASONABLE. SUCH COST IS UNREASONABLE IF IT IS 20% OR MORE HIGHER THAN THE BID PRICE FOR FOREIGN MADE PRODUCTS. IF THE DOMESTIC ALUMINUM, GLASS OR STEEL PRODUCTS TO BE SUPPLIED OR PRODUCED IN A "SUBSTANTIAL LABOR SURPLUS AREA", AS DEFINED BY THE UNITED STATES DEPARTMENT OF LABOR, FOREIGN PRODUCTS MAY BE SUPPLIED ONLY IF DOMESTIC PRODUCTS ARE 30% OR MORE HIGHER IN PRICE THAN THE FOREIGN MADE PRODUCTS.</p> <p>IF, PRIOR TO THE AWARD OF A CONTRACT UNDER THE ABOVE PROVISIONS, THE SPENDING OFFICER OF THE SPENDING UNIT DETERMINES THAT THERE EXISTS A BID FOR LIKE FOREIGN ALUMINUM, GLASS OR STEEL THAT IS REASONABLE AND LOWER THAN THE LOWEST BID DOMESTIC PRODUCTS, THE SPENDING OFFICE MAY REQUEST, IN WRITING, A REEVALUATION AND REDUCTION IN THE LOWEST BID FOR SUCH DOMESTIC PRODUCTS. ALL VENDORS MUST INDICATE IN THEIR BID IF THEY ARE SUPPLYING FOREIGN ALUMINUM, GLASS OR STEEL.</p> <p>REV 3/88</p> <p>EXHIBIT 9</p> <p>NOTICE FOR ISSUANCE & ACKNOWLEDGEMENT OF CONSTRUCTION PROJECT ADDENDA</p> <p>THE ARCHITECT/ENGINEER AND/OR AGENCY SHALL BE REQUIRED TO ABIDE BY THE FOLLOWING SCHEDULE IN ISSUING CONSTRUCTION PROJECT ADDENDA FOR STATE AGENCIES:</p> <p>(1) THE ARCHITECT/ENGINEER SHALL PREPARE THE ADDENDUM</p>						

SEE REVERSE SIDE FOR TERMS AND CONDITIONS

SIGNATURE _____ TELEPHONE _____ DATE _____

TITLE _____ FEIN _____

ADDRESS CHANGES TO BE NOTED ABOVE

REPORT NAME AND ADDRESS IN SPACE ABOVE LABELED 'VENDOR'



State of West Virginia
 Department of Administration
 Purchasing Division
 2019 Washington Street East
 Post Office Box 50130
 Charleston, WV 25305-0130

Request for Quotation

RFO NUMBER
 PSH90063

PAGE
 6

ADDRESS CORRESPONDENCE TO ATTENTION OF:
 ROBERTA WAGNER
 304-558-0067

*119161134 304-925-0338
 LONGS SECURITY CAMERA SYSTEMS
 102 38TH ST SE
 CHARLESTON WV 25304

SHIP TO

HEALTH AND HUMAN RESOURCES
 PINECREST HOSPITAL
 105 SOUTH EISENHOWER DRIVE
 BECKLEY, WV 25801
 304-256-6614

VENDOR

DATE PRINTED	TERMS OF SALE	SHIP VIA	F.O.B.	FREIGHT TERMS
11/25/2008				

BID OPENING DATE:	01/08/2009	BID OPENING TIME	01:30PM
-------------------	------------	------------------	---------

LINE	QUANTITY	UOP	CAT NO.	ITEM NUMBER	UNIT PRICE	AMOUNT
<p>AND A LIST OF ALL PARTIES THAT HAVE PROCURED DRAWINGS AND SPECIFICATIONS FOR THE PROJECT. THE ADDENDUM AND LIST SHALL BE FORWARDED TO THE BUYER IN THE STATE PURCHASING DIVISION. THE ARCHITECT/ENGINEER SHALL ALSO SEND A COPY OF THE ADDENDUM TO THE STATE AGENCY FOR WHICH THE CONTRACT IS ISSUED.</p> <p>(2) THE BUYER SHALL SEND THE ADDENDUM TO ALL INTERESTED PARTIES AND IF NECESSARY, EXTEND THE BID OPENING DATE ANY ADDENDUM SHOULD BE RECEIVED BY THE BUYER WITHIN FOURTEEN (14) DAYS PRIOR TO THE BID OPENING DATE.</p> <p>(3) ALL ADDENDA SHOULD BE FORMALLY ACKNOWLEDGED BY ALL BIDDERS AND SUBMITTED TO THE STATE PURCHASING DIVISION. THE SAME RULES AND REGULATIONS THAT APPLY TO THE ORIGINAL BIDDING DOCUMENT SHALL ALSO APPLY TO AN ADDENDUM DOCUMENT. THE ONLY EXCEPTION MAY BE FOR AN ADDENDUM THAT IS ISSUED FOR THE SOLE PURPOSE OF CHANGING A BID OPENING TIME AND/OR DATE.</p> <p>REV. 11/96</p> <p>EXHIBIT 10</p> <p>ADDENDUM ACKNOWLEDGEMENT</p> <p>I HEREBY ACKNOWLEDGE RECEIPT OF THE FOLLOWING CHECKED ADDENDUM(S) AND HAVE MADE THE NECESSARY REVISIONS TO MY PROPOSAL, PLANS AND/OR SPECIFICATION, ETC.</p> <p>ADDENDUM NOS :</p> <p>NO. 1 <i>Yes</i></p>						

SEE REVERSE SIDE FOR TERMS AND CONDITIONS

SIGNATURE _____ TELEPHONE _____ DATE _____

TITLE _____

ADDRESS CHANGES TO BE NOTED ABOVE

INSERT NAME AND ADDRESS IN SPACE ABOVE LABELED 'VENDOR'



State of West Virginia
 Department of Administration
 Purchasing Division
 2019 Washington Street East
 Post Office Box 50130
 Charleston, WV 25305-0130

Request for Quotation

RFQ NUMBER
 PSH90063

PAGE
 7

ADDRESS CORRESPONDENCE TO ATTENTION OF:
 ROBERTA WAGNER
 304-558-0067

VENDOR

*119161134 304-925-0338
 LONGS SECURITY CAMERA SYSTEMS
 102 38TH ST SE
 CHARLESTON WV 25304

SHIP TO

HEALTH AND HUMAN RESOURCES
 PINECREST HOSPITAL
 105 SOUTH EISENHOWER DRIVE
 BECKLEY, WV 25801 304-256-6614

DATE PRINTED	TERMS OF SALE	SHIP VIA	F.O.B.	FREIGHT TERMS
11/25/2008				

BID OPENING DATE:	BID OPENING TIME	AMOUNT
01/08/2009	01:30PM	

LINE	QUANTITY	UOP	CAT NO.	ITEM NUMBER	UNIT PRICE	AMOUNT
NO. 2						
NO. 3						
NO. 4						
NO. 5						

I UNDERSTAND THAT FAILURE TO CONFIRM THE RECEIPT OF THE ADDENDUM(S) MAY BE CAUSE FOR REJECTION OF THE BIDS.

VENDOR MUST CLEARLY UNDERSTAND THAT ANY VERBAL REPRESENTATION MADE OR ASSUMED TO BE MADE DURING ANY ORAL DISCUSSION HELD BETWEEN VENDOR'S REPRESENTATIVES AND ANY STATE PERSONNEL IS NOT BINDING ONLY THE INFORMATION ISSUED IN WRITING AND ADDED TO THE SPECIFICATIONS BY AN OFFICIAL ADDENDUM IS BINDING.

Alm E. Long
 Longs Security Camera Systems LLC
 1-15-09

SIGNATURE

COMPANY

DATE

REV. 11/96

CONTRACTORS LICENSE

WEST VIRGINIA STATE CODE 21-11-2 REQUIRES THAT ALL PERSONS DESIRING TO PERFORM CONTRACTING WORK IN THIS STATE MUST BE LICENSED. THE WEST VIRGINIA CONTRACTORS LICENSING BOARD IS EMPOWERED TO ISSUE THE CONTRACTORS LICENSE. APPLICATIONS FOR A CONTRACTORS LICENSE MAY B

SEE REVERSE SIDE FOR TERMS AND CONDITIONS

SIGNATURE _____ TITLE _____ FEIN _____ TELEPHONE _____ DATE _____ ADDRESS CHANGES TO BE NOTED ABOVE INSERT NAME AND ADDRESS IN SPACE ABOVE LABELED 'VENDOR'



State of West Virginia
 Department of Administration
 Purchasing Division
 2019 Washington Street East
 Post Office Box 50130
 Charleston, WV 25305-0130

Request for Quotation

RFQ NUMBER	PAGE
PSH90063	8
ADDRESS CORRESPONDENCE TO ATTENTION OF:	
ROBERTA WAGNER	
304-558-0067	

VENDOR

*119161134 304-925-0338
 LONGS SECURITY CAMERA SYSTEMS
 102 38TH ST SE
 CHARLESTON WV 25304

SHIP TO

HEALTH AND HUMAN RESOURCES
 PINECREST HOSPITAL
 105 SOUTH EISENHOWER DRIVE
 BECKLEY, WV 25801 304-256-6614

DATE PRINTED	TERMS OF SALE	SHIP VIA	F.O.B.	FREIGHT TERMS
11/25/2008	01/08/2009			
BID OPENING DATE	BID OPENING TIME			AMOUNT
	01:30PM			

LINE	QUANTITY	UOP	CAT NO.	ITEM NUMBER	UNIT PRICE	AMOUNT
<p>MADE BY CONTACTING THE WEST VIRGINIA DIVISION OF LABOR CAPITOL COMPLEX, BUILDING 3, ROOM 319, CHARLESTON, WV 25305. TELEPHONE: (304) 558-7890.</p> <p>WEST VIRGINIA STATE CODE 21-11-11 REQUIRES ANY PROSPECTIVE BIDDER TO INCLUDE THE CONTRACTORS LICENSE NUMBER ON THEIR BID.</p> <p>BIDDER TO COMPLETE: CONTRACTORS NAME: <i>Longs Security Camera Systems LLC</i> CONTRACTORS LICENSE NO.: <i>WV040102</i></p> <p>THE SUCCESSFUL BIDDER WILL BE REQUIRED TO FURNISH A COPY OF THEIR CONTRACTORS LICENSE PRIOR TO ISSUANCE OF A PURCHASE ORDER/CONTRACT</p> <p>APPLICABLE LAW</p> <p>THE WEST VIRGINIA STATE CODE, PURCHASING DIVISION RULES AND REGULATIONS, AND THE INFORMATION PROVIDED IN THE "REQUEST FOR QUOTATION" ISSUED BY THE PURCHASING DIVISION IS THE SOLE AUTHORITY GOVERNING THIS PROCUREMENT.</p> <p>ANY INFORMATION PROVIDED IN SPECIFICATION MANUALS, OR ANY OTHER SOURCE, VERBAL OR WRITTEN, WHICH CONTRADICTS OR ALTERS THE INFORMATION PROVIDED FROM THE SOURCES AS DESCRIBED IN THE ABOVE PARAGRAPH IS VOID AND OF NO EFFECT.</p> <p>BANKRUPTCY: IN THE EVENT THE VENDOR/CONTRACTOR FILES FOR BANKRUPTCY PROTECTION, THIS CONTRACT IS AUTOMATI- CALLY NULL AND VOID, AND IS TERMINATED WITHOUT FURTHER ORDER.</p>						

SIGNATURE	SEE REVERSE SIDE FOR TERMS AND CONDITIONS	TELEPHONE	DATE
TITLE	FEIN	ADDRESS CHANGES TO BE NOTED ABOVE	
BEST NAME AND ADDRESS IN SPACE ABOVE LABELED 'VENDOR'			



State of West Virginia
 Department of Administration
 Purchasing Division
 2019 Washington Street East
 Post Office Box 50130
 Charleston, WV 25305-0130

Request for Quotation

RFQ NUMBER
 PSH90063

PAGE
 9

ADDRESS CORRESPONDENCE TO ATTENTION OF:
 ROBERTA WAGNER
 304-558-0067

VENDOR

*119161134 304-925-0338
 LONGS SECURITY CAMERA SYSTEMS
 102 38TH ST SE
 CHARLESTON WV 25304

SHIP TO

HEALTH AND HUMAN RESOURCES
 PINECREST HOSPITAL
 105 SOUTH EISENHOWER DRIVE
 BECKLEY, WV 25801
 304-256-6614

DATE PRINTED 11/25/2008	TERMS OF SALE 01/08/2009	SHIP VIA	F.O.B.	FREIGHT TERMS
BID OPENING DATE	BID OPENING TIME		01:30PM	
LINE	QUANTITY	UOP	CAT NO.	ITEM NUMBER
				UNIT PRICE
				AMOUNT

REV. 1/2005

NOTICE

A SIGNED BID MUST BE SUBMITTED TO:
 DEPARTMENT OF ADMINISTRATION
 PURCHASING DIVISION
 BUILDING 15
 2019 WASHINGTON STREET, EAST
 CHARLESTON, WV 25305-0130

PLEASE NOTE: A CONVENIENCE COPY WOULD BE APPRECIATED.
 THE BID SHOULD CONTAIN THIS INFORMATION ON THE FACE OF
 THE ENVELOPE OR THE BID MAY NOT BE CONSIDERED:

SEALED BID

BUYER: -----RW/FILE 22-----

REQ. NO.: -----PSH90063-----

BID OPENING DATE: -----1/8/2009-----

BID OPENING TIME: -----1:30 PM-----

PLEASE PROVIDE A FAX NUMBER IN CASE IT IS NECESSARY
 TO CONTACT YOU REGARDING YOUR BID:
 304-925-0338

PLEASE PRINT OR TYPE NAME OF PERSON TO CONTACT
 CONCERNING THIS QUOTE: **ALAN E LONG**

SEE REVERSE SIDE FOR TERMS AND CONDITIONS

SIGNATURE _____ TELEPHONE _____ DATE _____
 TITLE _____ FEIN _____
 ADDRESS CHANGES TO BE NOTED ABOVE
 NAME AND ADDRESS IN SPACE ABOVE LABELED 'VENDOR'



State of West Virginia
 Department of Administration
 Purchasing Division
 2019 Washington Street East
 Post Office Box 50130
 Charleston, WV 25305-0130

Request for Quotation

RFQ NUMBER
 PSH90063

PAGE
 10

ADDRESS CORRESPONDENCE TO ATTENTION OF:
 ROBERTA WAGNER
 304-558-0067

VENDOR ROOM

*119161134 304-925-0338
 LONGS SECURITY CAMERA SYSTEMS
 102 38TH ST SE
 CHARLESTON WV 25304

SHIP TO

HEALTH AND HUMAN RESOURCES
 PINECREST HOSPITAL
 105 SOUTH EISENHOWER DRIVE
 BECKLEY, WV 25801
 304-256-6614

DATE PRINTED 11/25/2008	TERMS OF SALE	SHIP VIA	F.O.B.	FREIGHT TERMS
BID OPENING DATE: 11/25/2008	01/08/2009			BID OPENING TIME 01:30PM

LINE	QUANTITY	UOP	CAT NO.	ITEM NUMBER	UNIT PRICE	AMOUNT
<i>Please see attached Bid Schedule</i>						
0002	8	EA		936-73 UNINTERRUPTIBLE POWER SUPPLY		
0003	8	EA		936-73 16 CHANNEL POWER SUPPLY		
0004	53	EA		936-73 SONY SPE-110, OR EQUAL, VANDAL PROOF DOME CAMERA		
0005	10	EA		936-73 LICENSE PLATE RECOGNITION ULTRA SENSITIVITY COLOR		

SEE REVERSE SIDE FOR TERMS AND CONDITIONS

SIGNATURE _____ TELEPHONE _____ DATE _____
 TITLE _____ FEIN _____
 ADDRESS CHANGES TO BE NOTED ABOVE
 INSERT NAME AND ADDRESS IN SPACE ABOVE LABELED 'VENDOR'



State of West Virginia
 Department of Administration
 Purchasing Division
 2019 Washington Street East
 Post Office Box 50130
 Charleston, WV 25305-0130

Request for Quotation

RFQ NUMBER
 PSH90063

PAGE
 11

ADDRESS CORRESPONDENCE TO ATTENTION OF:
 ROBERTA WAGNER
 304-558-0067

VENDOR

*119161134 304-925-0338
 LONGS SECURITY CAMERA SYSTEMS
 102 38TH ST SE
 CHARLESTON WV 25304

SHIP TO

HEALTH AND HUMAN RESOURCES
 PINECREST HOSPITAL
 105 SOUTH EISENHOWER DRIVE
 BECKLEY, WV 25801 304-256-6614

DATE PRINTED	TERMS OF SALE	SHIP VIA	F.O.B.	FREIGHT TERMS
11/25/2008				

BID OPENING DATE:	BID OPENING TIME
01/08/2009	01:30PM

LINE	QUANTITY	UOP	CAT NO.	ITEM NUMBER	UNIT PRICE	AMOUNT
0006	1	JB		936-73		
MOUNTING BRACKETS, CABLE AND CABLE TERMINATIONS WITH						
0007	1	JB		936-73		
REQUIRED SOFTWARE FOR SECURITY SYSTEM						
0008	1	JB		936-73		
LABOR COSTS						
0009	1	LS		936-73		
MISCELLANEOUS COSTS						

Please see attached Bid Schedule

***** THIS IS THE END OF RFQ PSH90063 ***** TOTAL: _____

SEE REVERSE SIDE FOR TERMS AND CONDITIONS

SIGNATURE _____ TELEPHONE _____ DATE _____

TITLE _____ FEIN _____

ADDRESS CHANGES TO BE NOTED ABOVE

SEE INSERT NAME AND ADDRESS IN SPACE ABOVE LABELED 'VENDOR'



State of West Virginia
 Department of Administration
 Purchasing Division
 2019 Washington Street East
 Post Office Box 50130
 Charleston, WV 25305-0130

Request for Quotation

RFQ NUMBER:
 PSH90063

PAGE
 1

ADDRESS CORRESPONDENCE TO ATTENTION OF
 ROBERTA WAGNER
 304-558-0067

PROPERTY

Longs' Security Camera Systems LLC
 102 38th Street SE
 Charleston, WV 25304

PROPERTY

HEALTH AND HUMAN RESOURCES
 PINECREST HOSPITAL
 105 SOUTH EISENHOWER DRIVE
 BECKLEY, WV 25801
 304-256-6614

DATE PRINTED	TERMS OF SALE	SHIP VIA	F.O.B	FREIGHT TERMS
01/02/2009				

BID OPENING DATE: 01/15/2009 BID OPENING TIME 01:30PM

LINE	QUANTITY	UOP	CAT NO	ITEM NUMBER	UNIT PRICE	AMOUNT
ADDENDUM NO. 1						
1. TO MOVE BID DATE OPENING FROM 1/8/9 TO 1/15/9.						
2. TO CHANGE QUANTITIES:						
ITEM 3.2.1-A TOTAL OF FIVE (5) DIGITAL VIDEO RECORDERS (DVR) WILL BE REQUIRED.						
(THIS WAS CHANGED FROM EIGHT (8) DVR'S THAT WAS LISTED IN THE ORIGINAL SPECIFICATIONS.)						
ITEM 3.7.2-FIVE (5) 16 CHANNEL POWER SUPPLIES WILL BE REQUIRED.						
(THIS WAS CHANGED FROM EIGHT (8) 16 CHANNEL POWER SUPPLIES THAT WAS LISTED IN THE ORIGINAL SPECIFICATIONS.)						
3. QUESTIONS AND ANSWERS ATTACHED.						
4. ADDENDUM ACKNOWLEDGEMENT IS ATTACHED. THIS DOCUMENT SHOULD BE SIGNED AND RETURNED WITH YOUR BID. FAILURE TO SIGN AND RETURN MAY RESULT IN DISQUALIFICATION OF YOUR BID.						
EXHIBIT 10						
REQUISITION NO.: PSH90063						
ADDENDUM ACKNOWLEDGEMENT						
I HEREBY ACKNOWLEDGE RECEIPT OF THE FOLLOWING CHECKED ADDENDUM(S) AND HAVE MADE THE NECESSARY REVISIONS TO MY PROPOSAL, PLANS AND/OR SPECIFICATION, ETC.						
ADDENDUM NO.'S:						
NO. 1 <i>Yes</i>						

SEE REVERSE SIDE FOR TERMS AND CONDITIONS

SIGNATURE <i>Alan E. Long</i>	TELEPHONE 304-925-0338	DATE 1-19-09
TITLE Owner/President	FEIN 203881880	ADDRESS CHANGES TO BE NOTED ABOVE

WHEN RESPONDING TO RFQ, INSERT NAME AND ADDRESS IN SPACE ABOVE LABELED 'VENDOR'



State of West Virginia
 Department of Administration
 Purchasing Division
 2019 Washington Street East
 Post Office Box 50130
 Charleston, WV 25305-0130

Request for Quotation

RFQ NUMBER: PSH90063	PAGE: 2
ADDRESS CORRESPONDENCE TO ATTENTION OF: ROBERTA WAGNER 304-558-0067	

RFQ COPY
 TYPE NAME/ADDRESS HERE

HEALTH AND HUMAN RESOURCES
 PINECREST HOSPITAL
 105 SOUTH EISENHOWER DRIVE
 BECKLEY, WV 25801
 304-256-6614

DATE PRINTED	TERMS OF SALE	SHIP VIA	FOB	FREIGHT TERMS		
01/02/2009						
BID OPENING DATE: 01/15/2009	BID OPENING TIME 01:30PM					
LINE	QUANTITY	UOP	CAT NO	ITEM NUMBER	UNIT PRICE	AMOUNT
NO. 2						
NO. 3						
NO. 4						
NO. 5						
<p>I UNDERSTAND THAT FAILURE TO CONFIRM THE RECEIPT OF THE ADDENDUM(S) MAY BE CAUSE FOR REJECTION OF BIDS.</p> <p>VENDOR MUST CLEARLY UNDERSTAND THAT ANY VERBAL REPRESENTATION MADE OR ASSUMED TO BE MADE DURING ANY ORAL DISCUSSION HELD BETWEEN VENDOR'S REPRESENTATIVES AND ANY STATE PERSONNEL IS NOT BINDING. ONLY THE INFORMATION ISSUED IN WRITING AND ADDED TO THE SPECIFICATIONS BY AN OFFICIAL ADDENDUM IS BINDING.</p> <p><i>Adam Long</i> SIGNATURE Long's Security Camera Systems LLC COMPANY 1-15-09 DATE</p> <p>REV 11/96</p> <p>END OF ADDENDUM NO. 1</p>						
SEE REVERSE SIDE FOR TERMS AND CONDITIONS					TELEPHONE	DATE
SIGNATURE			ADDRESS CHANGES TO BE NOTED ABOVE			
TITLE			FEIN			
WHEN RESPONDING TO RFQ, INSERT NAME AND ADDRESS IN SPACE ABOVE LABELED 'VENDOR'						

ACORD™ CERTIFICATE OF LIABILITY INSURANCE

DATE(MM/DD/YYYY)

01/14/2009

THIS CERTIFICATE IS ISSUED AS A MATTER OF INFORMATION ONLY AND CONFERS NO RIGHTS UPON THE CERTIFICATE HOLDER. THIS CERTIFICATE DOES NOT AMEND, EXTEND OR ALTER THE COVERAGE AFFORDED BY THE POLICIES BELOW.

PRODUCER

Insurance Intermediaries, Inc
6460 Busch Blvd., Suite 100

Columbus, OH 43229-1737

INSURED Long's Security Camera Systems LLC

102 38th St SE

Charleston, WV 25304

INSURERS AFFORDING COVERAGE

NAIC#

INSURER A: Scottsdale Insurance Co.

41297

INSURER B:

INSURER C:

INSURER D:

INSURER E:

COVERAGES

THE POLICIES OF INSURANCE LISTED BELOW HAVE BEEN ISSUED TO THE INSURED NAMED ABOVE FOR THE POLICY PERIOD INDICATED. NOTWITHSTANDING ANY REQUIREMENT, TERM OR CONDITION OF ANY CONTRACT OR OTHER DOCUMENT WITH RESPECT TO WHICH THIS CERTIFICATE MAY BE ISSUED OR MAY PERTAIN, THE INSURANCE AFFORDED BY THE POLICIES DESCRIBED HEREIN IS SUBJECT TO ALL THE TERMS, EXCLUSIONS AND CONDITIONS OF SUCH POLICIES. AGGREGATE LIMITS SHOWN MAY HAVE BEEN REDUCED BY PAID CLAIMS.

INSR ADD'L LTR INSRD	TYPE OF INSURANCE	POLICY NUMBER	POLICY EFFECTIVE DATE(MM/DD/YY)	POLICY EXPIRATION DATE(MM/DD/YY)	LIMITS	
A	GENERAL LIABILITY <input checked="" type="checkbox"/> COMMERCIAL GENERAL LIABILITY <input type="checkbox"/> CLAIMS MADE <input checked="" type="checkbox"/> OCCUR GEN L AGGREGATE LIMIT APPLIES PER: <input type="checkbox"/> POLICY <input type="checkbox"/> PRO-JECT <input type="checkbox"/> LOC	CIS1460147	03/11/2008	03/11/2009	EACH OCCURRENCE	\$ 300,000
					DAMAGE TO RENTED PREMISES (Ea occurrence)	\$ 100,000
					MED EXP (Any one person)	\$ 5,000
					PERSONAL & ADV INJURY	\$ 300,000
					GENERAL AGGREGATE	\$ 600,000
					PRODUCTS - COMP/OP AGG	\$ 600,000
	AUTOMOBILE LIABILITY				COMBINED SINGLE LIMIT (Ea accident)	\$
	<input type="checkbox"/> ANY AUTO <input type="checkbox"/> ALL OWNED AUTOS <input type="checkbox"/> SCHEDULED AUTOS <input type="checkbox"/> HIRED AUTOS <input type="checkbox"/> NON-OWNED AUTOS				BODILY INJURY (Per person)	\$
					BODILY INJURY (Per accident)	\$
					PROPERTY DAMAGE (Per accident)	\$
	GARAGE LIABILITY				AUTO ONLY - EA ACCIDENT	\$
	<input type="checkbox"/> ANY AUTO				OTHER THAN AUTO ONLY: EA ACC	\$
					AGG	\$
	EXCESS/UMBRELLA LIABILITY				EACH OCCURRENCE	\$
	<input type="checkbox"/> OCCUR <input type="checkbox"/> CLAIMS MADE				AGGREGATE	\$
						\$
						\$
						\$
	WORKERS COMPENSATION AND EMPLOYERS' LIABILITY				WC STATUTORY LIMITS	OTH-ER
	ANY PROPRIETOR/PARTNER/EXECUTIVE OFFICER/MEMBER EXCLUDED? If yes, describe under SPECIAL PROVISIONS below				E.L. EACH ACCIDENT	\$
					E.L. DISEASE - EA EMPLOYEE	\$
					E.L. DISEASE - POLICY LIMIT	\$

DESCRIPTION OF OPERATIONS / LOCATIONS / VEHICLES / EXCLUSIONS ADDED BY ENDORSEMENT / SPECIAL PROVISIONS

CERTIFICATE HOLDER

Health and Human Resources
Pine Crest Hospital
105 South Eisenhower Drive
Beckley, WV 25801

CANCELLATION

SHOULD ANY OF THE ABOVE DESCRIBED POLICIES BE CANCELLED BEFORE THE EXPIRATION DATE THEREOF THE ISSUING INSURER WILL ENDEAVOR TO MAIL 30 DAYS WRITTEN NOTICE TO THE CERTIFICATE HOLDER NAMED TO THE LEFT BUT FAILURE TO DO SO SHALL IMPOSE NO OBLIGATION OR LIABILITY OF ANY KIND UPON THE INSURER ITS AGENTS REPRESENTATIVES.

AUTHORIZED REPRESENTATIVE
Amy Bobb

IMPORTANT

If the certificate holder is an ADDITIONAL INSURED, the policy(ies) must be endorsed. A statement on this certificate does not confer rights to the certificate holder in lieu of such endorsement(s)

If SUBROGATION IS WAIVED, subject to the terms and conditions of the policy, certain policies may require an endorsement. A statement on this certificate does not confer rights to the certificate holder in lieu of such endorsement(s).

DISCLAIMER

The Certificate of Insurance on the reverse side of this form does not constitute a contract between the issuing insurer(s), authorized representative or producer, and the certificate holder, nor does it affirmatively or negatively amend, extend or alter the coverage afforded by the policies listed thereon

Agency Purchasing
REQ. P. O.# PSH90063
Bond # 17862

BID BOND

KNOW ALL MEN BY THESE PRESENTS, That we the undersigned, Long's Security Camera System, LLC.
of 102 38th Street SE, Charleston, WV 25304, as Principal, and American Southern Insurance
Company of 7512 Slate Ridge Blvd. Reynoldsburg, OH 43068, a corporation organized and existing under the laws of the State of Kansas
with its principal office in the City of Atlanta, GA, as Surety, are held and firmly bound unto the State
of West Virginia as Obligees, in the penal sum of Six Thousand Six Hundred and No/100 (\$ 6,600.00) for the payment of which,
well and truly to be made, we jointly and severally bind ourselves, our heirs, administrators, executors, successors and assigns.

The Condition of the above obligation is such that whereas the Principal has submitted to the Purchasing Section of the
Department of Administration a certain bid or proposal, attached hereto and made a part hereof, to enter into a contract in writing for
Pinecrest Hospital - Installation of Hospital Wide Camera System

NOW THEREFORE,

- (a) If said bid shall be rejected, or
- (b) If said bid shall be accepted and the Principal shall enter into a contract in accordance with the bid or proposal attached hereto and shall furnish any other bonds and insurance required by the bid or proposal, and shall in all other respects perform the agreement created by the acceptance of said bid, then this obligation shall be null and void, otherwise this obligation shall remain in full force and effect. It is expressly understood and agreed that the liability of the Surety for any and all claims hereunder shall, in no event, exceed the penal amount of this obligation as herein stated

The Surety, for the value received, hereby stipulates and agrees that the obligations of said Surety and its bond shall be in no way impaired or affected by any extension of the time within which the Obligees may accept such bid, and said Surety does hereby waive notice of any such extension.

IN WITNESS WHEREOF, Principal and Surety have hereunto set their hands and seals, and such of them as are corporations have caused their corporate seals to be affixed hereunto and these presents to be signed by their proper officers. This 15th day of January, 2009.

Principal Corporate Seal

Long's Security Camera System, LLC.
(Name of Principal)

By _____
(Must be President or Vice President)

(Title)
American Southern Insurance Company
(Name of Surety)

Surety Corporate Seal



Attorney-in-Fact

Andrew C. Heaner
Raised corporate seals

IMPORTANT - Surety executing bonds must be licensed in West Virginia to transact surety insurance. Raised corporate seals must be affixed, a power of attorney must be attached.

AMERICAN SOUTHERN INSURANCE COMPANY

Home Office: 200 S W 30th Street
Topeka, Kansas 66611

Mailing Address: 3715 Northside Pkwy, NW
Bldg 400, Ste 800
Atlanta, Georgia 30327

GENERAL POWER OF ATTORNEY

Know all men by these Presents, that the American Southern Insurance Company had made, constituted and appointed, and by these presents does make, constitute and appoint Stefan E. Tauger of Parker, Colorado; Donald J. Kersey of Birmingham, Alabama; Arthur S. Johnson of Atlanta, Georgia; Jessica I. Boone of Locust Grove, Georgia; Mary F. Holland of Chamblee, Georgia; Donald H. Gibbs of Atlanta, Georgia; Andrew C. Heaner of Atlanta, Georgia; Richard L. Shanahan of Atlanta, Georgia; Katherine S. Grimsley of Tampa, Florida; Jeffery L. Booth of Parma, Ohio; James E. Feldner of West Lake, Ohio; Cheryl L. Torrao of Canton, Georgia; Lloyd Randall Deal of Kennesaw, Georgia; Garry W. Black of Murfreesboro, Tennessee; Martha G. Ross of Charlotte, North Carolina; or David R. Brett of Columbia, South Carolina; Diane M. Bailey of Phoenix, Arizona; Diane L. McLain of Fitchburg, Wisconsin, EACH as its true and lawful attorney for it and its name, place and stead to execute on behalf of the said company, as surety, bonds, undertakings and contracts of suretyship to be given to all obligees provided that no bond or undertaking or contract of suretyship executed under this authority shall exceed in amount of the sum of \$1,000,000 (one million dollars), including but not limited to consents of surety for the release of retained percentages and/or final estimates on construction contracts or similar authority requested by the Department of Transportation, State of Florida; and the execution of such undertakings, bonds, recognizances and other surety obligations, in pursuance of the presents, shall be as binding upon the Company as if they had been duly signed by the President and attested by the Secretary of the Company in their own proper persons.

This Power of Attorney is granted and is signed and sealed by facsimile under and by the authority of the following Resolution adopted pursuant to due authorization by the Executive Committee of the Board of Directors of the American Southern Insurance Company on the 26th day of May, 1998:

RESOLVED, that the Chairman, President or any Vice President of the Company be, and that each or any of them hereby is, authorized to execute Powers of Attorney qualifying the attorney named in the given Power of Attorney to execute in behalf of the American Southern Insurance Company bonds, undertakings and all contracts of suretyship; and that any Secretary or any Assistant Secretary be, and that each or any of them hereby is, authorized to attest the execution of any such Power of Attorney, and to attach thereto the seal of the Company.

FURTHER RESOLVED, that the signature of such officers and the seal of the Company may be affixed to any such Power of Attorney or to any certificate relating thereto by facsimile, and any such Power of Attorney or certificate bearing such facsimile signatures or facsimile seal shall be valid and binding upon the Company when so affixed and in the future with respect to any bond undertaking or contract of suretyship to which it is attached.

In Witness Whereof, the American Southern Insurance Company has caused its official seal to be hereto affixed, and these presents to be signed by its President and attested by its Secretary this 24th day of March, 2008

Attest: 
Gail A. Lee, Secretary

By: 
Scott G. Thompson, President

STATE OF GEORGIA
COUNTY OF FULTON SS:

On this 24th day of March, 2008 before me personally came Scott G. Thompson to me known who being by me duly sworn, did depose and that he resides in Atlanta in the County of Fulton, State of Georgia at 421 Hollydale Court; that he knows the seal of the said corporation; that the seal affixed to said instrument is such corporate seal; that it was so affixed and that he signed his name thereto pursuant to due authorization

Melanie Coppola
Notary Public, State of Georgia
Qualified in Cobb County
Commission Expires May 17 2010

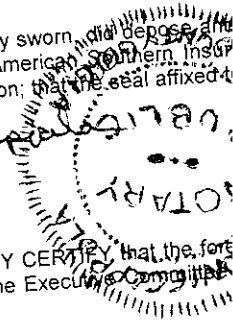

STATE OF GEORGIA
COUNTY OF FULTON SS:

I, the undersigned, a Vice President of American Southern Insurance Company, a Kansas Corporation, DO HEREBY CERTIFY that the foregoing and attached Power of Attorney remains in full force and has not been revoked; and furthermore that the Resolution of the Executive Board of Directors set forth in the Power of Attorney is now in force

Signed and sealed at the City of Atlanta Dated the 15th day of January 2009

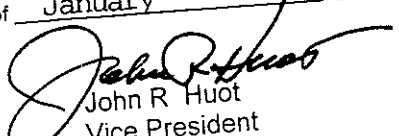
John R. Huot
Vice President

Power No. 17862

STATE OF WEST VIRGINIA
Purchasing Division

PURCHASING AFFIDAVIT

VENDOR OWING A DEBT TO THE STATE:

West Virginia Code §5A-3-10a provides that: No contract or renewal of any contract may be awarded by the state or any of its political subdivisions to any vendor or prospective vendor when the vendor or prospective vendor or a related party to the vendor or prospective vendor is a debtor and the debt owed is an amount greater than one thousand dollars in the aggregate

PUBLIC IMPROVEMENT CONTRACTS & DRUG-FREE WORKPLACE ACT:

West Virginia Code §21-1D-5 provides that: Any solicitation for a public improvement construction contract shall require each vendor that submits a bid for the work to submit at the same time an affidavit that the vendor has a written plan for a drug-free workplace policy in compliance with Article 1D, Chapter 21 of the West Virginia Code. A public improvement construction contract may not be awarded to a vendor who does not have a written plan for a drug-free workplace policy in compliance with Article 1D, Chapter 21 of the West Virginia Code and who has not submitted that plan to the appropriate contracting authority in timely fashion. For a vendor who is a subcontractor, compliance with Section 5, Article 1D, Chapter 21 of the West Virginia Code may take place before their work on the public improvement is begun

ANTITRUST:

In submitting a bid to any agency for the state of West Virginia, the bidder offers and agrees that if the bid is accepted the bidder will convey, sell, assign or transfer to the state of West Virginia all rights, title and interest in and to all causes of action it may now or hereafter acquire under the antitrust laws of the United States and the state of West Virginia for price fixing and/or unreasonable restraints of trade relating to the particular commodities or services purchased or acquired by the state of West Virginia. Such assignment shall be made and become effective at the time the purchasing agency tenders the initial payment to the bidder.

I certify that this bid is made without prior understanding, agreement, or connection with any corporation, firm, limited liability company, partnership or person or entity submitting a bid for the same materials, supplies, equipment or services and is in all respects fair and without collusion or fraud. I further certify that I am authorized to sign the certification on behalf of the bidder or this bid

LICENSING:

Vendors must be licensed and in good standing in accordance with any and all state and local laws and requirements by any state or local agency of West Virginia, including, but not limited to, the West Virginia Secretary of State's Office, the West Virginia Tax Department, West Virginia Insurance Commission, or any other state agencies or political subdivision. Furthermore, the vendor must provide all necessary releases to obtain information to enable the Director or spending unit to verify that the vendor is licensed and in good standing with the above entities.

CONFIDENTIALITY:

The vendor agrees that he or she will not disclose to anyone, directly or indirectly, any such personally identifiable information or other confidential information gained from the agency, unless the individual who is the subject of the information consents to the disclosure in writing or the disclosure is made pursuant to the agency's policies, procedures and rules. Vendors should visit www.state.wv.us/admin/purchase/privacy for the Notice of Agency Confidentiality Policies

Under penalty of law for false swearing (*West Virginia Code* §61-5-3), it is hereby certified that the vendor acknowledges the information in this said affidavit and is in compliance with the requirements as stated.

Vendor's Name: Long's Security Camera Systems LLC
Authorized Signature: *Alan E Long* Date: 1-19-09

CONTRACTOR LICENSE

Authorized by the

West Virginia Contractor Licensing Board

Number: WV040102

Classification:

LOW VOLTAGE SYSTEMS

LONGS SECURITY CAMERA SYSTEMS LLC
102 38TH STREET SE
CHARLESTON, WV 25304

Date Issued

JANUARY 26, 2008

Expiration Date

JANUARY 26, 2009

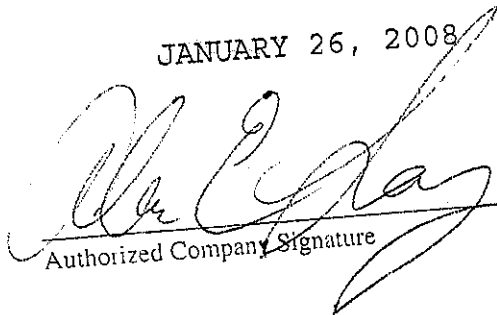

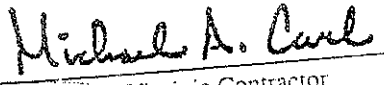
Authorized Company Signature

Chair, West Virginia Contractor
Licensing Board

WEST VIRGINIA
CONTRACTOR
LICENSING
BOARD

This license, or a copy thereof, must be posted in a conspicuous place at every construction site where work performed. This license number must appear in all advertisements, on all bid submissions and on all fully and binding contracts. This license cannot be assigned or transferred by licensee. Issued under provision Virginia Code, Chapter 21, Article 11

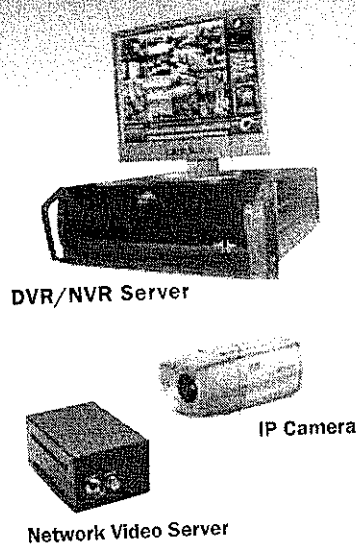
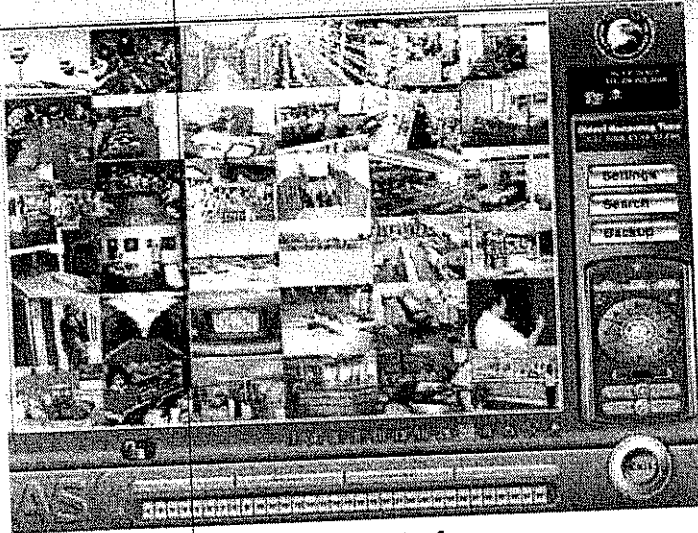
AVS DVR/NVR IP and Analog Cameras on the Same System



Graphical User Interface

- Views and records up to 32 Analog or IP cameras
- MPEG-4 compression
- Supports up to 8 cash registers with optional built-in POS integration
- Integrated with Smart Video Technology
- Multiple audio channels
- Remote multi-server access
- Independent camera selection for recording rate, resolution and compression
- Executable backup files to play on any computer without special software
- Built-in motion detection recording
- High picture quality at lowest storage
- Multi-camera playback (search) in DVR and remote
- Encrypted/watermarked recordings
- Video alarming on motion or sensor; sound activated motion recording
- Draggable camera display windows

**Any ARGUS DVR can be converted
to a hybrid system through a software upgrade,
and any NVR can be converted to a hybrid system
via a hardware upgrade**

AVS DVR/NVR



1280 Kempar Avenue
Madison Heights, MI 480
Phone: 248.398.9888
Fax: 248.398.9887
www.argussecuritytech.com

Hybrid DVR/NVR

System Features

Remote Access

You can connect to multiple sites, and each site can be connected with multiple users at the same time

User-Friendly Operation

Settings and menus are designed for non-expert users, so anybody can navigate the whole system without spending days learning how to operate it

Multiple Picture Qualities and Resolutions

Configurations are so flexible you can set each camera individually for resolution (up to 640x480), compression (including MPEG4), frame rate and recording events.

Multi-Zone Motion Detection

The systems support whole screen motion detection, or user defined area motion detection with several detection areas for each camera

Scheduled Video Recording

Operate with 5 different recording modes including alarm recording, scheduled recording, motion recording, and combinations of each

Live View Shut Down

Shut down the live screen while all the cameras continue to record

Pan/Tilt/Zoom

Control multiple PTZ camera formats locally and from a remote location

Audio

System offers recording, playback and backup audio on one or multiple cameras.

Multiple Camera Simultaneous Recording and Playback
Record up to 32 channels of video with time lapse and event-based recording modes. Record multiple video and audio channels with simultaneous alarm conditions and motion detections. Selectable 1, 4, 6, 9, 10, 13, 16, 25, and 32 screen split.

Camera Display Windows are Dragable: move and rearrange cameras into any position in the live, recorded & RMS display. Each camera can be separately configured for frame rate, motion areas, resolution, compression and recording method. Quick Search Feature allows for a full access to one camera playback while keeping live cameras on the screen.

View Live & Recorded Video Remotely with Advanced Communications Capability

Both live and recorded video is accessible via the included RMS software. Remote software also provides system configuration and PTZ control, supporting up to 32 units. Compatible with both dial-up (PSTN) and computer network (TCP/IP) connections. These systems are fully accessible by password authorized users anywhere in the world. Advanced compression technology ensures the fastest transmission possible over allowable bandwidth.

Benefits:

- Control business from anywhere in the world
- Control multiple systems from one remote computer
- No need for any special video hardware at the remote monitoring location
- PDA RMS software available

ARGUS DVR / NVR Solutions

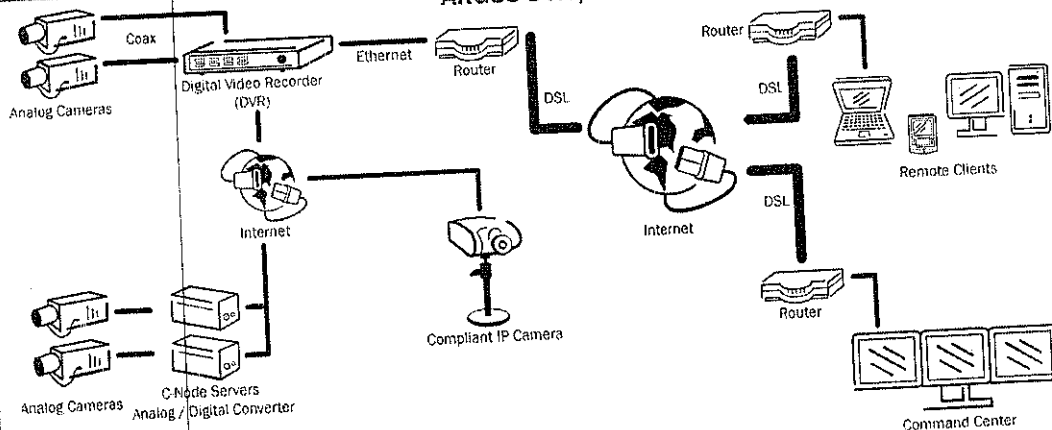

Authorized ARGUS Dealer



1280 Kempar Avenue
Madison Heights, MI 48071
Phone: 248.398.9888
Fax: 248.398.9887
www.argussecuritytech.com

EasyView

Most installer friendly cameras.

INDOOR DOME

GD-S21N/P



Flush Mount

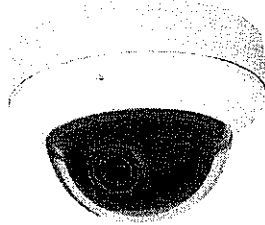

Flush Housing with Surface Mount

Key Features

- 1/3" CCD Sensor
- 550 TV Lines
- 2.8-10mm DC Auto Iris
- 0.1 Lux(Color) 0.002 Lux(DSS On)
- Separate Camera Control Board
 - OSD Menu
 - Service Monitor Output
- 12VDC/24VAC Dual Voltage

Construction

- 4" Polycarbonate Bubble
- 3-Axis Gimbal
- Flush Mount Housing w/ Surface Mount Plate in a single package
- Aluminum Mounting Accessories(Optional)
- Ivory or Black Plastic Housing(Optional)
- Compact Size

Technical Specifications

Item	GD-S21N/P
Video Format	NTSC / PAL
Image Sensor	1/3" CCD
Sync System	Internal / Line Lock(Optional)
Effective Pixels	768(H) x 494(V)(N) / 752(H) x 582(V)(P)
Scanning system	525 Lines 2:1 Interlaced(N) 625 Lines 2:1 Interlaced(P)
Electronic Shutter	1/60 ~ 1/120 000 sec (N) 1/50 ~ 1/120 000 sec (P)
Main Video Output	1.0 Vp-p Composite 75 ohm
Service Monitor Output	1.0 Vp-p Composite 75 ohm
Horizontal Resolution	550 TV Lines
Min. Illumination	0.1 Lux(Color) 0.002 Lux(DSS On)
S/N Ratio	More than 50dB(AGC Off)
Lens (DC Auto Iris)	Vari-focal: 2.8-10mm
Angle of View	132 1°(W) ~ 36°(T)
Camera Control & Setup	OSD Menu
Operating Temperature	-5°C ~ +45°C
Operating Humidity	Within 90% RH
Power Consumption	500mA
Input Voltage	12VDC/24VAC Dual Voltage

Must use specified and regulated 12VDC/24VAC power supply

Available Models

GD-S21N/P-I	Ivory Housing
GD-S21N/P-B	Black Housing

Accessories

CA-SMC30	Service Monitor Cable
CV-WM	Indoor Wall Mount
CA-PM	Pedestal Mount
CA-JB	Junction Box

Dome Inside View

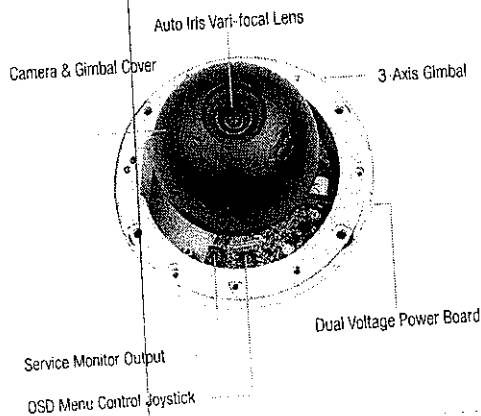

Dimensions (UNIT: mm)

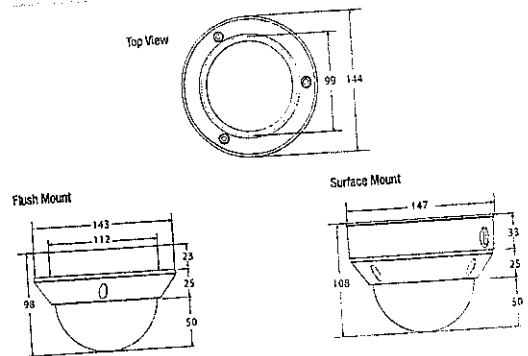

NUVICO

Corporate Headquarters | T 866.523.1700 • 201.541.1605 • sales@nuvico.com
 International Operations | export@nuvico.com
 Customer Service | cs@nuvico.com
 Technical Support | techsupport@nuvico.com



EasyView

Most installer friendly cameras.

DAY/NIGHT • IR LED BULLET

CB-SD21N/P-L

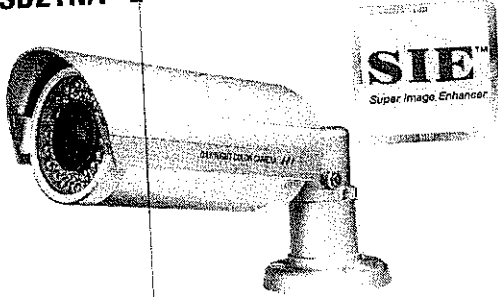

Key Features

- 1/3" CCD Sensor
- 550 TV Lines
- Day/Night function with ICR
- 2.8-10mm, DC Auto Iris
- 0.1 Lux(Color) 0.01 Lux(B/W) 0.002 Lux(DSS On)
- 36 IR LEDs
- Separate Camera Control Board
 - OSD Menu
 - Service Monitor Output
- 12VDC/24VAC Dual Voltage

Construction

- Aluminum Housing(Weatherproof)
- Aluminum Bracket(Wire feed-through)

Technical Specifications

Item	CB-SD21N/P-L
Video Format	NTSC / PAL
Image Sensor	1/3" CCD
Sync System	Internal
Effective Pixels	768(H) x 494(V)(N) / 752(H) x 582(V)(P)
Scanning System	525 Lines 2:1 Interlaced(N) 625 Lines 2:1 Interlaced(P)
Electronic Shutter	1/60 ~ 1/120 000 sec (N) 1/50 ~ 1/120 000 sec (P)
Main Video Output	1.0 Vp-p Composite 75 ohm
Service Monitor Output	1.0 Vp-p Composite 75 ohm
Horizontal Resolution	550 TV Lines
Min Illumination	0.1 Lux(Color) 0.01 Lux(B/W) 0.002 Lux(DSS On)
S/N Ratio	More than 50dB(AGC Off)
Lens (DC Auto Iris)	Vari-focal: 2.8-10mm
Angle of View	132 1°(W) ~ 36°(T)
Day/Night Function	ICR
36 IR LEDs	LED Distance: up to 100ft
LED Illumination Angle	60°
Camera Control & Setup	OSD Menu
Operating Temperature	-5°C ~ +45°C
Operating Humidity	Within 90% RH
Weatherproof	IP66
Power Consumption	500mA (Camera) 1 Amp (w/ LED On)
Input Voltage	12VDC/24VAC Dual Voltage

* Must use specified and regulated 12VDC/24VAC power supply

Dimensions (UNIT: mm)

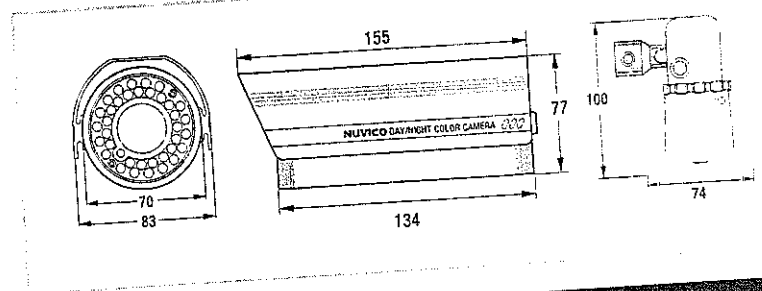

NUVICO

Corporate Headquarters | T 866.523.1700 • 201.541.1605 • sales@nuvico.com • Customer Service | cs@nuvico.com
 International Operations | export@nuvico.com • Technical Support | techsupport@nuvico.com



ALTV2416, ALTV2416CB AC CCTV Power Supply

Rev. DSALTV2416 - A24F

Overview

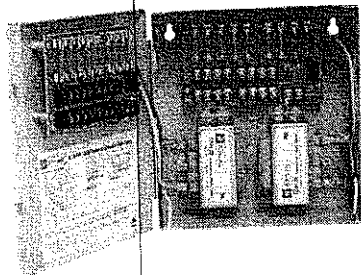

- These Altronix AC Wall Mount CCTV Power Supplies provide 24VAC or 28VAC distributed via sixteen (16) fuse or PTC protected outputs for powering CCTV Cameras, heaters and other video accessories

ALTV2416

- Sixteen (16) fuse protected outputs
- Outputs are rated @ 3.5 amp.

ALTV2416CB

- Sixteen (16) PTC protected outputs.
- Outputs are rated @ 2.5 amp

Specifications

- Input 115VAC, 50/60Hz, 1.9 amp.
- 24VAC @ 8 amp (200VA) or 28VAC @ 7 amp (200VA) supply current.
- Main fuse rated @ 10 amp/250V
- Power ON/OFF switch
- Surge suppression.
- AC power LEDs.
- Spare fuse(s) provided (all models w/primary and/or secondary fuses)
- Unit maintains camera synchronization
- Ease of installation saves time and eliminates costly labor
- Product weight:
 - ALTV2416: 9.5 lbs
 - ALTV2416CB: 9.5 lbs
- Shipping weight:
 - ALTV2416: 10.1 lbs
 - ALTV2416CB: 10.1 lbs

Agency Approvals



European Conformity

Enclosure Dimensions

8.5"H x 7.5"W x 3.5"D

