



State of West Virginia  
 Department of Administration  
 Purchasing Division  
 2019 Washington Street East  
 Post Office Box 50130  
 Charleston, WV 25305-0130

**Request for Quotation**

RFQ NUMBER
LAWN09

PAGE
1

ADDRESSES CORRESPONDENCE TO A REPLY ONLY
JO ANN ADKINS 304-558-8802

RFQ COPY

TYPE NAME/ADDRESS HERE

SARLO POWER MOWERS, INC.  
 P.O. Box 1169  
 Ft. MYERS, FL 33902

ALL STATE AGENCIES  
 AND POLITICAL SUBDIVISIONS  
 VARIOUS LOCALES AS INDICATED  
 BY ORDER

DATE PRINTED	TERMS OF SALE	CPY/PAK	PCF	FRESH TERMS	
06/12/2008					
BID OPENING DATE: 07/10/2008		BID OPENING TIME 01:30PM			
LINE	QUANTITY	UOP	DESCRIPTION	UNIT PRICE	AMOUNT
			<p>REQUEST FOR QUOTATION</p> <p>FOR BLANKET OPEN-END STATEWIDE CONTRACT TO SUPPLY LAWN MAINTENANCE EQUIPMENT TO WEST VIRGINIA STATE AGENCIES AND POLITICAL SUBDIVISIONS....</p> <p>VENDORS SHALL USE THE ATTACHED "PRICING PAGE" LAWN09 TO ENTER THEIR QUOTATION FOR EACH ITEM. AN ELECTRONIC VERSION OF LAWN09 PRICING PAGE CAN BE OBTAINED BY REQUEST TO JO.A.ADKINS@WV.GOV</p> <p>ALL PRICES SHALL BE F.O.B. DESTINATION - SHIPPING PREPAID AND INCLUDED IN THE VENDOR PRICE SHOWN. PLEASE COMPLETE ALL INFORMATION REQUESTED ON THE LAWN09 PRICING PAGES.</p> <p>*****</p> <p>INQUIRIES</p> <p>WRITTEN QUESTIONS SHALL BE ACCEPTED THROUGH CLOSE OF BUSINESS ON WEDNESDAY, JUNE 25, 2008. QUESTIONS MAY BE SENT VIA USPS, FAX, COURIER OR EMAIL. IN ORDER TO ASSURE NO VENDOR RECEIVES AN UNFAIR ADVANTAGE, NO SUBSTANTIVE QUESTIONS WILL BE ANSWERED ORALLY. IF POSSIBLE, E-MAIL QUESTIONS ARE PREFERRED.</p> <p>ADDRESS INQUIRIES TO:</p> <p>JO ANN ADKINS                  DEPARTMENT OF ADMINISTRATION                  PURCHASING DIVISION                  2019 WASHINGTON STREET, EAST                  CHARLESTON, WV 25305                  FAX: 304-558-4115                  E-MAIL: JO.A.ADKINS@WV.GOV</p>		
SEE REVERSE SIDE FOR TERMS AND CONDITIONS					
SIGNATURE	TELEPHONE			DATE	
<i>Eloise Sarlo</i>	239-332-1955			7-9-08	
TITLE	FAX		ADDRESS CHANGES TO BE NOTED ABOVE		
VP	59-0832854				

RECEIVED  
 08 JUL 16 PM 12:01  
 PURCHASING DIVISION  
 STATE OF WV

WHEN RESPONDING TO RFQ, INSERT NAME AND ADDRESS IN SPACE ABOVE LABELED 'VENDOR'

**GENERAL TERMS & CONDITIONS  
REQUEST FOR QUOTATION (RFQ) AND REQUEST FOR PROPOSAL (RFP)**

1. Awards will be made in the best interest of the State of West Virginia.
2. The State may accept or reject in part, or in whole, any bid.
3. All quotations are governed by the *West Virginia Code* and the *Legislative Rules* of the Purchasing Division.
4. Prior to any award, the apparent successful vendor must be properly registered with the Purchasing Division and have paid the required \$125.00 registration fee.
5. All services performed or goods delivered under State Purchase Orders/Contracts are to be continued for the term of the Purchase Order/Contract, contingent upon funds being appropriated by the Legislature or otherwise being made available. In the event funds are not appropriated or otherwise available for these services or goods, this Purchase Order/Contract becomes void and of no effect after June 30.
6. Payment may only be made after the delivery and acceptance of goods or services.
7. Interest may be paid for late payment in accordance with the *West Virginia Code*.
8. Vendor preference will be granted upon written request in accordance with the *West Virginia Code*.
9. The State of West Virginia is exempt from federal and state taxes and will not pay or reimburse such taxes.
10. The Director of Purchasing may cancel any Purchase Order/Contract upon 30 days written notice to the seller.
11. The laws of the State of West Virginia and the *Legislative Rules* of the Purchasing Division shall govern all rights and duties under the Contract, including without limitation the validity of this Purchase Order/Contract.
12. Any reference to automatic renewal is hereby deleted. The Contract may be renewed only upon mutual written agreement of the parties.
13. **BANKRUPTCY:** In the event the vendor/contractor files for bankruptcy protection, this Contract may be deemed null and void, and terminated without further order.
14. **HIPAA Business Associate Addendum:** The West Virginia State Government HIPAA Business Associate Addendum (BAA), approved by the Attorney General, and available online at the Purchasing Division's web site (<http://www.state.wv.us/admin/purchase/vrc/hipaa.htm>) is hereby made part of the agreement. Provided that, the Agency meets the definition of a Covered Entity (45 CFR §160.103) and will be disclosing Protected Health Information (45 CFR §160.103) to the vendor.
15. **West Virginia Alcohol & Drug-Free Workplace Act:** If this Contract constitutes a public improvement construction contract as set forth in Article 1D, Chapter 21 of the West Virginia Code ("The West Virginia Alcohol and Drug-Free Workplace Act"), then the following language shall hereby become part of this Contract: "The contractor and its subcontractors shall implement and maintain a written drug-free workplace policy in compliance with the West Virginia Alcohol and Drug-Free Workplace Act, as set forth in Article 1D, Chapter 21 of the West Virginia Code. The contractor and its subcontractors shall provide a sworn statement in writing, under the penalties of perjury, that they maintain a valid drug-free work place policy in compliance with the West Virginia Alcohol and Drug-Free Workplace Act. It is understood and agreed that this Contract shall be cancelled by the awarding authority if the Contractor: 1) Fails to implement its drug-free workplace policy; 2) Fails to provide information regarding implementation of the contractor's drug-free workplace policy at the request of the public authority; or 3) Provides to the public authority false information regarding the contractor's drug-free workplace policy."

---

**INSTRUCTIONS TO BIDDERS**

1. Use the quotation forms provided by the Purchasing Division.
2. **SPECIFICATIONS:** Items offered must be in compliance with the specifications. Any deviation from the specifications must be clearly indicated by the bidder. Alternates offered by the bidder as EQUAL to the specifications must be clearly defined. A bidder offering an alternate should attach complete specifications and literature to the bid. The Purchasing Division may waive minor deviations to specifications.
3. Complete all sections of the quotation form.
4. Unit prices shall prevail in cases of discrepancy.
5. All quotations are considered F.O.B. destination unless alternate shipping terms are clearly identified in the quotation.
6. **BID SUBMISSION:** All quotations must be delivered by the bidder to the office listed below prior to the date and time of the bid opening. Failure of the bidder to deliver the quotations on time will result in bid disqualifications:  
Department of Administration, Purchasing Division, 2019 Washington Street East, P.O. Box 50130,  
Charleston, WV 25305-0130

Lawn09  
Pricing/Information Page

Item	Description	Brand	Model	Est. Usage	Brand Bid	Model Bid	Unit Cost	Total
Region I - Hancock, Brooke, Ohio, Marshall, Wetzel, Monongalia, Marion, Harrison, Doddridge, Gilmer.								
Company Name: SARLO POWER MOWERS, INC.								
Must be equal to or exceed:								
* 1	Lawn Mower, 4.5 HP, side discharge, push type, 21" Cut Width	Toro	22175	10	SARLO	621-2	\$ 395.20	\$ 3,952.00
* 2	Lawn Mower, 5.5 HP, side discharge, self propelled type, 21" cut width	Toro	22145	10	SARLO	WX624-SP	\$ 744.80	\$ 7,448.00
3	Lawn Mower, 15HP, side discharge, hydrostatic, 36" cut width (walk-behind)	Gravely	HE1536FXP	4	N-B	-	-	-
4	Lawn Mower, 18 HP, side discharge, gear-drive, 48" cut width (walk-behind)	John Deere	7H17	4	N-B	-	-	-
5	Lawn Mower, 20 HP, side discharge, self propelled type, 52" cut width, swivel front wheels, hydro drive	Exmark	TT23KCFMD524	7	N-B	-	-	-
6	Line Trimmer/Brush Cutter, engine displacement 31.4cc engine.	Stihl	FS100RX	30	N-B	-	-	-
7	Line Trimmer/Brush Cutter, engine displacement 36 cc engine minimum.	Stihl	FS130R	40	N-B	-	-	-
7a	Bulk String, 5 lbs .95	Stihl	0000-930-2718	50	N-B	-	-	-
7b	Brush Knife, 3 prong	Stihl	4112-713-4100	10	N-B	-	-	-
7c	Shoulder Strap for item 6 and 7	Stihl		25	N-B	-	-	-

**GENERAL TERMS & CONDITIONS  
REQUEST FOR QUOTATION (RFQ) AND REQUEST FOR PROPOSAL (RFP)**

1. Awards will be made in the best interest of the State of West Virginia.
2. The State may accept or reject in part, or in whole, any bid.
3. All quotations are governed by the *West Virginia Code* and the *Legislative Rules* of the Purchasing Division.
4. Prior to any award, the apparent successful vendor must be properly registered with the Purchasing Division and have paid the required \$125.00 registration fee.
5. All services performed or goods delivered under State Purchase Orders/Contracts are to be continued for the term of the Purchase Order/Contract, contingent upon funds being appropriated by the Legislature or otherwise being made available. In the event funds are not appropriated or otherwise available for these services or goods, this Purchase Order/Contract becomes void and of no effect after June 30.
6. Payment may only be made after the delivery and acceptance of goods or services.
7. Interest may be paid for late payment in accordance with the *West Virginia Code*.
8. Vendor preference will be granted upon written request in accordance with the *West Virginia Code*.
9. The State of West Virginia is exempt from federal and state taxes and will not pay or reimburse such taxes.
10. The Director of Purchasing may cancel any Purchase Order/Contract upon 30 days written notice to the seller.
11. The laws of the State of West Virginia and the *Legislative Rules* of the Purchasing Division shall govern all rights and duties under the Contract, including without limitation the validity of this Purchase Order/Contract.
12. Any reference to automatic renewal is hereby deleted. The Contract may be renewed only upon mutual written agreement of the parties.
13. **BANKRUPTCY:** In the event the vendor/contractor files for bankruptcy protection, this Contract may be deemed null and void, and terminated without further order.
14. **HIPAA Business Associate Addendum -** The West Virginia State Government HIPAA Business Associate Addendum (BAA), approved by the Attorney General, and available online at the Purchasing Division's web site (<http://www.state.wv.us/admin/purchase/vrc/hipaa.htm>) is hereby made part of the agreement. Provided that, the Agency meets the definition of a Covered Entity (45 CFR §160.103) and will be disclosing Protected Health Information (45 CFR §160.103) to the vendor.

---

**INSTRUCTIONS TO BIDDERS**

1. Use the quotation forms provided by the Purchasing Division.
2. **SPECIFICATIONS:** Items offered must be in compliance with the specifications. Any deviation from the specifications must be clearly indicated by the bidder. Alternates offered by the bidder as EQUAL to the specifications must be clearly defined. A bidder offering an alternate should attach complete specifications and literature to the bid. The Purchasing Division may waive minor deviations to specifications.  
*\*SEE ATTACHED SPEC. SHEETS*
3. Complete all sections of the quotation form.
4. Unit prices shall prevail in cases of discrepancy.
5. All quotations are considered F.O.B. destination unless alternate shipping terms are clearly identified in the quotation.
6. **BID SUBMISSION:** All quotations must be delivered by the bidder to the office listed below prior to the date and time of the bid opening. Failure of the bidder to deliver the quotations on time will result in bid disqualifications.

**SIGNED BID TO:**

Department of Administration  
Purchasing Division  
2019 Washington Street East  
Post Office Box 50130  
Charleston, WV 25305-0130

Lawn09  
Pricing/Information Page

Item	Description	Brand	Model	Est. Usage	Brand Bid	Model Bid	Unit Cost	Total
8	Lawn Edger, engine displacement 28.4 cc	Stihl	FC 90	4	N-B	-	-	-
9	Lawn Edger, 4 HP, 9" blade	Troy-bilt	Lawn Edger	8	N-B	-	-	-
10	Heavy Duty 16" chain saw, 56.5 cc (minimum), 3.8 BHP.	Stihl	MS290	5	N-B	-	-	-
11	Heavy Duty 18" Chain Saw, 64.1 cc (minimum) 4.3 BHP	Stihl	MS390	5	N-B	-	-	-
12	Heavy Duty 20" chain saw, 59.0 cc (minimum) 4.4BHP	Stihl	MS361	5	N-B	-	-	-
13	Heavy Duty 25" Chain Saw, 76.5 CC (Minimum) 6.0 BHP	Stihl	MS460	5	N-B	-	-	-
14	Pole Pruner, 12" chain bar, engine displacement 31.4 CC (Minimum), 1.3 BHP	Stihl	HT101	10	N-B	-	-	-
15	Power washer, 3000 PSI, 190 cc, 30' 1/4" high pressure hose	Troy-bilt	3000 PSI MAX	6	N-B	-	-	-
16	Blower, hand-tote, engine displacement 27 CC (Minimum), air volume: 4130 CFM at end of tube	Stihl	BC65 D	5	N-B	-	-	-
17	Blower, back pack, engine displacement - 64CC (Minimum), 530 CFM air volume at the end of the tube, handle with controls mounted on tube, padded shoulder strap.	Stihl	BR550	30	N-B	-	-	-
18	Garden Tractor, 25 HP, side discharge, hydrostatic, 50" cut, 18" turn radius, key choice mowing.	Cub Cadet	LT 1050	4	N-B	-	-	-

Lawn09  
Pricing/Information Page

Item	Description	Brand	Model	Est. Usage	Brand Bid	Model Bid	Unit Cost	Total
19	Lawn Mower, 27 HP, zero turn radius, 60" cut width, 5.5" deep deck, ANSI approved, deluxe roll suspension seat, fuel capacity, 10 gallons(min), Standard foldable rollover protection systems (ROPS), Hydro tracking adjustment	John Deere	Z830A	3	N-13	-	-	-
20	Lawn Mower, 31 HP, zero turn radius, 72" cut width, 5.5" deep deck, ANSI approved, fuel capacity 12 gallons(min.), standard foldable rollover protection systems (ROPS), Hydro tracking adjustment	Gravely	272H XDZ	2	N-13	-	-	-
21	Utility Vehicle, 11 HP, 900 lb. towing capacity, ground clearance of 9.8" from foot platform. Seating capacity of 2.	Gator	TS	2	N-13	-	-	-
	Discount from list for PARTS ONLY:		%					

Vendor Name SARLO POWER MOWERS, INC. Phone # 239-332-1955

P.O. Box 1169 Address Fax # 239-332-7212

F. Myers, FL. 33902 Email: KEN@SARLOMOWER.COM

Company Representative KEN BOYCE  
Authorized Signature [Signature]  
(Please print)

LAWN09  
Pricing/Information Page

Region II - Mason, Cabell, Wayne, Mingo, Logan, Boone, Lincoln, Kanawha, Putnam, Roane and Jackson		Company Name: SARLO POWER MOWERS INC.		Must be equal to or exceed:		Est. Usage	Brand Bid	Model Bid	Unit Cost	Total
Item	Description	Brand	Model	Est. Usage	Brand Bid	Model Bid	Unit Cost	Total		
* 1	Lawn Mower, 4.5 HP, side discharge, push type, 21" Cut Width	Toro	22175	10	SARLO	621-2	\$295.20	\$2952.00		
* 2	Lawn Mower, 5.5 HP, side discharge, self propelled type, 21" cut width	Toro	22145	10	SARLO	624-SP	\$744.80	\$7448.00		
3	Lawn Mower, 15HP, side discharge, hydrostatic, 36" cut width (walk-behind)	Gravelly	HE1536FXP	4	N-B	-	-	-		
4	Lawn Mower, 18 HP, side discharge, gear-drive, 48" cut width (walk-behind)	John Deere	7H17	4	N-B	-	-	-		
5	Lawn Mower, 20 HP, side discharge, self propelled type, 52" cut width, swivel front wheels, hydro drive	Exmark	TT23KCFMD524	7	N-B	-	-	-		
6	Line Trimmer/Brush Cutter, engine displacement 31.4cc engine,	Stihl	FS100RX	30	N-B	-	-	-		
7	Line Trimmer/Brush Cutter, engine displacement 36 cc engine minimum,	Stihl	FS130R	40	N-B	-	-	-		
7a	Bulk String, 5 lbs .95	Stihl	0000-930-2718	50	N-B	-	-	-		
7b	Brush Knife, 3 prong	Stihl	4112-713-4100	10	N-B	-	-	-		
7c	Shoulder Strap for item 6 and 7	Stihl	FC 90	25	N-B	-	-	-		
8	Lawn Edger, engine displacement 28.4 cc	Stihl	FC 90	4	N-B	-	-	-		
9	Lawn Edger, 4 HP, 9" blade	Troy-bilt	Lawn Edger	8	N-B	-	-	-		

LAWN09  
Pricing/Information Page

Item	Description	Brand	Model	Est. Usage	Brand Bid	Model Bid	Unit Cost	Total
10	Heavy Duty 16" chain saw, 56.5 cc (minimum), 3.8 BHP.	Stihl	MS290	5	N-B	-	-	-
11	Heavy Duty 18" Chain Saw, 64.1 cc (minimum) 4.3 BHP	Stihl	MS390	5	N-B	-	-	-
12	Heavy Duty 20" chain saw, 59.0 cc (Minimum) 4.4BHP	Stihl	MS361	5	N-B	-	-	-
13	Heavy Duty 25" Chain Saw, 76.5 CC (Minimum) 6.0 BHP	Stihl	MS460	5	N-B	-	-	-
14	Pole Pruner, 12" chain bar, engine displacement 31.4 CC (Minimum), 1.3 BHP	Stihl	HT101	10	N-B	-	-	-
15	Power washer, 3000 PSI, 190 cc, 30' 1/4" high pressure hose	Troy-bilt	3000 PSI MAX	6	N-B	-	-	-
16	Blower, hand-tote, engine displacement 27 CC (Minimum), air volume: 4r30 CFM at end of tube	Stihl	BG65 D	5	N-B	-	-	-
17	Blower, back pack, engine displacement - 64CC (Minimum), 530 CFM air volume at the end of the tube, handle with controls mounted on tube, padded shoulder strap.	Stihl	BR550	30	N-B	-	-	-
18	Garden Tractor, 25 HP, side discharge, hydrostatic, 50" cut, 18" turn radius, key choice mowing.	Cub Cadet	LT 1050	4	N-B	-	-	-
19	Lawn Mower, 27 HP, zero turn radius, 60" cut width, 5.5" deep deck, ANSI approved, deluxe roll suspension seat, fuel capacity, 10 gallons(min), Standard foldable rollover protection systems (ROPS), Hydro tracking adjustment	John Deere	Z830A	3	N-B	-	-	-



LAWN09  
Pricing/Information Page

Item	Description	Brand	Model	Est. Usage	Brand Bid	Model Bid	Unit Cost	Total
20	Lawn Mower, 31 HP, zero turn radius, 72" cut width, 5.5" deep deck, ANSI approved, fuel capacity 12 gallons(min.), standard foldable rollover protection systems (ROPS), Hydro tracking adjustment	Gravely	272H XDZ	2	N-B	-	-	-
21	Utility Vehicle, 11 HP, 900 lb. towing capacity, ground clearance of 9.8" from foot platform. Seating capacity of 2.	Gator	TS	2	N-B	-	-	-
	Discount from list for PARTS ONLY:	%	N-B		N-B	-	-	-

Vendor Name: SARLO POWER MOWERS, INC.

P.O. Box 1169

Address

Ft. Myers, FL. 33902

Phone # 239-332-1955

Fax # 239-332-7212

Email: KEN@SARLOMOWER.COM

Company Representative Ken Boyce

(Please print)

Authorized Signature 

LAWN09  
Pricing/Information Page

Region III - Lewis, Upshur, Randolph, Pendleton, Hardy, Grant, Hampshire, Mineral, Morgan, Berkeley, Jefferson, Tucker, Barbour, Taylor, and Preston		Company Name: SARLO POWER MOWERS, INC.		Must be equal to or exceed:					
Item	Description	Brand	Model	Est. Usage	Brand Bid	Model Bid	Unit Cost	Total	
* 1	Lawn Mower, 4.5 HP, side discharge, push type, 21" Cut Width	Toro	22175	10	SARLO	621-2	\$ 395. <sup>20</sup>	4	3952. <sup>00</sup>
* 2	Lawn Mower, 5.5 HP, side discharge, self propelled type, 21" cut width	Toro	22145	10	SARLO	MX 624-SP	\$ 744. <sup>80</sup>	4	7448. <sup>00</sup>
3	Lawn Mower, 15HP, side discharge, hydrostatic, 36" cut width (walk-behind)	Gravely	HE1536FXP	4	N-B	-	-	-	-
4	Lawn Mower, 18 HP, side discharge, gear-drive, 48" cut width (walk-behind)	John Deere	7H17	4	N-B	-	-	-	-
5	Lawn Mower, 20 HP, side discharge, self propelled type, 52" cut width, swivel front wheels, hydro drive	Exmark	TT23KCFMDS24	7	N-B	-	-	-	-
6	Line Trimmer/Brush Cutter, engine displacement 31.4cc engine.	Stihl	FS100RX	30	N-B	-	-	-	-
7	Line Trimmer/Brush Cutter, engine displacement 36 cc engine minimum.	Stihl	FS130R	40	N-B	-	-	-	-
7a	Bulk String, 5 lbs .95	Stihl	0000-930-2718	50	N-B	-	-	-	-
7b	Brush Knife, 3 prong	Stihl	4112-713-4100	10	N-B	-	-	-	-
7c	Shoulder Strap for item 6 and 7	Stihl		25	N-B	-	-	-	-
8	Lawn Edger, engine displacement 28.4 cc	Stihl	FC 90	4	N-B	-	-	-	-
9	Lawn Edger, 4 HP, 9" blade	Troy-bilt	Lawn Edger	8	N-B	-	-	-	-

LAWN09  
Pricing/Information Page

Item	Description	Brand	Model	Est. Usage	Brand Bid	Model Bid	Unit Cost	Total
10	Heavy Duty 16" chain saw, 56.5 cc (minimum), 3.8 BHP.	Stihl	MS290	5	N-B	-	-	-
11	Heavy Duty 18" Chain Saw, 64.1 cc (minimum) 4.3 BHP	Stihl	MS390	5	N-B	-	-	-
12	Heavy Duty 20" chain saw, 59.0 cc (Minimum) 4.4BHP	Stihl	MS361	5	N-B	-	-	-
13	Heavy Duty 25" Chain Saw, 76.5 CC (Minimum) 6.0 BHP	Stihl	MS460	5	N-B	-	-	-
14	Pole Pruner, 12" chain bar, engine displacement 31.4 CC (Minimum), 1.3 BHP	Stihl	HT101	10	N-B	-	-	-
15	Power washer, 3000 PSI, 190 cc, 30' 1/4" high pressure hose	Troy-bilt	3000 PSI MAX	6	N-B	-	-	-
16	Blower, hand-tote, engine displacement 27 CC (Minimum), air volume: 4r30 CFM at end of tube	Stihl	BC66 D	5	N-B	-	-	-
17	Blower, back pack, engine displacement - 64CC (Minimum), 530 CFM air volume at the end of the tube, handle with controls mounted on tube, padded shoulder strap.	Stihl	BR550	30	N-B	-	-	-
18	Garden Tractor, 25 HP, side discharge, hydrostatic, 50" cut, 18" turn radius, key choice mowing.	Cub Cadet	LT 1050	4	N-B	-	-	-
19	Lawn Mower, 27 HP, zero turn radius, 60" cut width, 5.5" deep deck, ANSI approved, deluxe roll suspension seat, fuel capacity, 10 gallons(min). Standard foldable rollover protection systems (ROPS), Hydro tracking adjustment	John Deere	Z830A	3	N-B	-	-	-

LAVINC9  
Pricing/Information Page

Item	Description	Brand	Model	Est. Usage	Brand Bid	Model Bid	Unit Cost	Total
20	Lawn Mower, 31 HP, zero turn radius, 72" cut width, 5.5" deep deck, ANSI approved, fuel capacity 12 gallons(min.), standard foldable rollover protection systems (ROPS), Hydro tracking adjustment	Gravely	272H XDZ	2	N-B	-	-	-
21	Utility Vehicle, 11 HP, 900 lb. towing capacity, ground clearance of 9.8" from foot platform. Seating capacity of 2.	Gator	TS	2	N-B	-	-	-
	Discount from list for PARTS ONLY:		%		N-B	-	-	-

Vendor Name SARLO POWER MOWERS, INC. Phone # 239-332-1955

P.O. Box 1169 Fax # 239-332-7212

Address

FT. MYERS, FL. 33902 Email: KEN@SARLOMOWER.COM

Company Representative

Ken Boyce

Authorized Signature

(Please print)  
Ken Boyce

LAWN09  
Pricing/Information Page

Region IV - Braxton, Clay, Nicholas, Fayette, Raleigh, Wyoming, McDowell, Mercer, Summers, Greenbrier, Pocahontas, Webster and Monroe		Company Name: SARLO POWER MOWERS, INC.		Must be equal to or exceed:					
Item	Description	Brand	Model	Est. Usage	Brand Bid	Model Bid	Unit Cost	Total	
* 1	Lawn Mower, 4.5 HP, side discharge, push type, 21" Cut Width	Toro	22175	10	SARLO	621-2	\$395.00	\$39520	
* 2	Lawn Mower, 5.5 HP, side discharge, self propelled type, 21" cut width	Toro	22145	10	SARLO	624-5P	\$744.80	\$74480	
3	Lawn Mower, 15HP, side discharge, hydrostatic, 36" cut width (walk-behind)	Gravely	HE1536FXP	4	N-B	-	-	-	
4	Lawn Mower, 18 HP, side discharge, gear-drive, 48" cut width (walk-behind)	John Deere	7H17	4	N-B	-	-	-	
5	Lawn Mower, 20 HP, side discharge, self propelled type, 52" cut width, swivel front wheels, hydro drive	Exmark	TT23KCFMD524	7	N-B	-	-	-	
6	Line Trimmer/Brush Cutter, engine displacement 31.4cc engine,	Stihl	FS100RX	30	N-B	-	-	-	
7	Line Trimmer/Brush Cutter, engine displacement 36 cc engine minimum,	Stihl	FS130R	40	N-B	-	-	-	
7a	Bulk String, 5 lbs .95	Stihl	0000-930-2718	50	N-B	-	-	-	
7b	Brush Knife, 3 prong	Stihl	4112-713-4100	10	N-B	-	-	-	
7c	Shoulder Strap for item 6 and 7	Stihl		25	N-B	-	-	-	
8	Lawn Edger, engine displacement 28.4 cc	Stihl	FC 90	4	N-B	-	-	-	
9	Lawn Edger, 4 HP, 5" blade	Troy-bilt	Lawn Edger	8	N-B	-	-	-	

LAWN09  
Pricing/Information Page

Item	Description	Brand	Model	Est. Usage	Brand Bid	Model Bid	Unit Cost	Total
10	Heavy Duty 16" chain saw, 56.5 cc (minimum), 3.8 BHP.	Stihl	MS290	5	N-B	-	-	-
11	Heavy Duty 18" Chain Saw, 64.1 cc (minimum) 4.3 BHP	Stihl	MS390	5	N-B	-	-	-
12	Heavy Duty 20" chain saw, 59.0 cc (Minimum) 4.4BHP	Stihl	MS361	5	N-B	-	-	-
13	Heavy Duty 25" Chain Saw, 76.5 CC (Minimum) 6.0 BHP	Stihl	MS460	5	N-B	-	-	-
14	Pole Pruner, 12" chain bar, engine displacement 31.4 CC (Minimum), 1.3 BHP	Stihl	HT101	10	N-B	-	-	-
15	Power washer, 3000 PSI, 190 cc, 30" 1/4" high pressure hose	Troy-bill	3000 PSI MAX	6	N-B	-	-	-
16	Blower, hand-tote, engine displacement 27 CC (Minimum), air volume: 430 CFM at end of tube	Stihl	BG65 D	5	N-B	-	-	-
17	Blower, back pack, engine displacement - 64CC (Minimum), 530 CFM air volume at the end of the tube, handle with controls mounted on tube, padded shoulder strap.	Stihl	BR550	30	N-B	-	-	-
18	Garden Tractor, 25 HP, side discharge, hydrostatic, 50" cut, 18" turn radius, key choice mowing.	Cub Cadet	LT 1050	4	N-B	-	-	-
19	Lawn Mower, 27 HP, zero turn radius, 60" cut width, 5.5" deep deck, ANSI approved, deluxe roll suspension seat, fuel capacity, 10 gallons(min), Standard foldable rollover protection systems (ROPS), Hydro tracking adjustment	John Deere	Z830A	3	N-B	-	-	-

LAWN09 Pricing/Information Page

Item	Description	Brand	Model	Est. Usage	Brand Bid	Model Bid	Unit Cost	Total
20	Lawn Mower, 31 HP, zero turn radius, 72" cut width, 5.5" deep deck, ANSI approved, fuel capacity 12 gallons(min.), standard foldable rollover protection systems (ROPS). Hydro tracking adjustment	Gravely	272H XDZ	2	N-B	-	-	-
21	Utility Vehicle, 11 HP, 900 lb. towing capacity, ground clearance of 9.8" from foot platform. Seating capacity of 2.	Gator	TS	2	N-B	-	-	-
	Discount from list for PARTS ONLY:		%					

Vendor Name SARLO POWER MOWERS, INC.

P.O. BOX 1169

FT MYERS, FL. 33902

Phone # 239-332-1955

Fax # 239-332-7212

Email: KEVIN@SARLOMOWER.COM

Company Representative

Ken Boyce

Authorized Signature

(Please print)  
Ken Boyce



State of West Virginia  
 Department of Administration  
 Purchasing Division  
 2019 Washington Street East  
 Post Office Box 50130  
 Charleston, WV 25305-0130

**Request for  
 Quotation**

BFO NUMBER	PAGE
LAWN09	1

ADDRESS CORRESPONDENCE TO ATTENTION OF
JO ANN ADKINS
304-558-8802

RFQ COPY

TYPE NAME/ADDRESS HERE

SARLO POWER MOWERS, INC.  
 P.O. BOX 1169  
 FT. MYERS, FL. 33902

ALL STATE AGENCIES  
 AND POLITICAL SUBDIVISIONS  
 VARIOUS LOCALES AS INDICATED  
 BY ORDER

DATE PRINTED	TERMS OF SALE	SHIP VIA	FOB	FREIGHT TERMS
06/27/2008				

BID OPENING DATE	BID OPENING TIME
07/10/2008	01:30PM

LINE	QUANTITY	UOP	CAT NO	ITEM NUMBER	UNIT PRICE	AMOUNT
*****ADDENDUM NO. 1*****						
1. LAWN09 PRICING PAGES, REVISED 06/27/08 CLARIFYING DISCOUNT FROM LIST IS FOR PARTS ONLY.						
2. VENDOR'S SHALL FURNISH MANUFACTURER'S CERTIFICATION OR AUTHORIZATION THAT INDICATES THE VENDOR IS ABLE TO SUPPLY NEW EQUIPMENT AND PARTS AS BID.						
3. ADDENDUM ACKNOWLEDGEMENT IS ATTACHED. THIS DOCUMENT SHOULD BE SIGNED AND RETURNED WITH YOUR BID. FAILURE TO SIGN AND RETURN MAY RESULT IN DISQUALIFICATION OF YOUR BID.						
*****END OF ADDENDUM NO. 1*****						

SEE REVERSE SIDE FOR TERMS AND CONDITIONS

SIGNATURE	TELEPHONE	DATE
<i>Elaine Sarno</i>	239-332-1955	7-9-08
TITLE	FEIN	ADDRESS CHANGES TO BE NOTED ABOVE
VP	59-0932854	

WHEN RESPONDING TO RFQ, INSERT NAME AND ADDRESS IN SPACE ABOVE LABELED 'VENDOR'





State of West Virginia  
 Department of Administration  
 Purchasing Division  
 2019 Washington Street East  
 Post Office Box 50130  
 Charleston, WV 25305-0130

**Request for Quotation**

RFQ NUMBER  
**LAWN09**

PAGE  
**2**

ADDRESS/CORRESPONDENCE/DATA/VERSION OF  
**JO ANN ADKINS  
 304-558-8802**

RFQ COPY  
 TYPE NAME/ADDRESS HERE  
**SARLO POWER MOWERS, INC  
 P.O. Box 1169  
 FT. MYERS, FL. 33902**

ALL STATE AGENCIES  
 AND POLITICAL SUBDIVISIONS  
 VARIOUS LOCALES AS INDICATED  
 BY ORDER

DATE PRINTED <b>06/12/2008</b>	TERMS OF SALE	SHIP VIA	FOR	RFQ/TERMS
-----------------------------------	---------------	----------	-----	-----------

BID OPENING DATE: **07/10/2008** BID OPENING TIME **01:30PM**

LINE	QUANTITY	UOM	CAT NO	ITEM NUMBER	UNIT PRICE	AMOUNT
0001	1	EA		515-45		
<p>THIS REQUEST FOR QUOTATION IS PER ALL THE STANDARD TERMS AND CONDITIONS, AND GENERAL SPECIFICATIONS DATED 06/12/2008.</p> <p>PRICING SHALL BE ENTERED ON THE ATTACHED PRICING PAGES, ALL REQUESTED INFORMATION SHOULD BE SUPPLIED.</p> <p><b>GASOLINE POWERED LAWN MAINTENANCE EQUIPMENT</b></p> <p>THE MODEL/BRAND/SPECIFICATIONS NAMED HEREIN ESTABLISH THE ACCEPTABLE LEVEL OF QUALITY ONLY AND ARE NOT INTENDED TO REFLECT A PREFERENCE OR FAVOR ANY PARTICULAR BRAND OR VENDOR. VENDORS WHO ARE BIDDING ALTERNATES SHOULD SO STATE AND INCLUDE PERTINENT LITERATURE AND SPECIFICATIONS. FAILURE TO PROVIDE INFORMATION FOR ANY ALTERNATES MAY BE GROUNDS FOR REJECTION OF THE BID. THE STATE RESERVES THE RIGHT TO WAIVE MINOR IRREGULARITIES IN BIDS OR SPECIFICATION IN ACCORDANCE WITH SECTION 148-1-4(F) OF THE WEST VIRGINIA LEGISLATIVE RULES AND REGULATIONS.</p> <p>EXHIBIT 3</p> <p>LIFE OF CONTRACT: THIS CONTRACT BECOMES EFFECTIVE ON ..... AND EXTENDS FOR A PERIOD OF ONE (1</p>						

SEE REVERSE SIDE FOR TERMS AND CONDITIONS

SIGNATURE **Uelene Sarlo** TELEPHONE **239-332-1955** DATE **7-9-08**

TITLE **VP** FEIN **59-0832954** ADDRESS CHANGES TO BE NOTED ABOVE

WHEN RESPONDING TO RFQ, INSERT NAME AND ADDRESS IN SPACE ABOVE LABELED 'VENDOR'



State of West Virginia  
Department of Administration  
Purchasing Division  
2019 Washington Street East  
Post Office Box 50130  
Charleston, WV 25305-0130

### Request for Quotation

RFQ NUMBER  
**LAWN09**

PAGE  
**3**

ADDRESS OF RESPONDENCE  
**JO ANN ADKINS  
304-558-8802**

RFQ COPY  
TYPE NAME/ADDRESS HERE  
**SARLO POWER MOWERS, INC.  
P.O. Box 1169  
FT. MYERS, FL. 33902**

ALL STATE AGENCIES  
AND POLITICAL SUBDIVISIONS  
VARIOUS LOCALES AS INDICATED  
BY ORDER

DATE PRINTED <b>06/12/2008</b>	TERMS OF SALE	SHIP VIA	FCB	FREIGHT TERMS
BID OPENING DATE: <b>07/16/2008</b>	BID OPENING TIME <b>01:30PM</b>			

LINE	QUANTITY	TOP	CA	ITEM NUMBER	UNIT PRICE	AMOUNT
<p>YEAR OR UNTIL SUCH "REASONABLE TIME" THEREAFTER AS IS NECESSARY TO OBTAIN A NEW CONTRACT OR RENEW THE ORIGINAL CONTRACT. THE "REASONABLE TIME" PERIOD SHALL NOT EXCEED TWELVE (12) MONTHS. DURING THIS "REASONABLE TIME" THE VENDOR MAY TERMINATE THIS CONTRACT FOR ANY REASON UPON GIVING THE DIRECTOR OF PURCHASING 30 DAYS WRITTEN NOTICE.</p> <p>UNLESS SPECIFIC PROVISIONS ARE STIPULATED ELSEWHERE IN THIS CONTRACT DOCUMENT, THE TERMS, CONDITIONS AND PRICING SET HEREIN ARE FIRM FOR THE LIFE OF THE CONTRACT.</p> <p>RENEWAL: THIS CONTRACT MAY BE RENEWED UPON THE MUTUAL WRITTEN CONSENT OF THE SPENDING UNIT AND VENDOR, SUBMITTED TO THE DIRECTOR OF PURCHASING THIRTY (30) DAYS PRIOR TO THE EXPIRATION DATE. SUCH RENEWAL SHALL BE IN ACCORDANCE WITH THE TERMS AND CONDITIONS OF THE ORIGINAL CONTRACT AND SHALL BE LIMITED TO TWO (2) ONE (1) YEAR PERIODS.</p> <p>CANCELLATION: THE DIRECTOR OF PURCHASING RESERVES THE RIGHT TO CANCEL THIS CONTRACT IMMEDIATELY UPON WRITTEN NOTICE TO THE VENDOR IF THE COMMODITIES AND/OR SERVICE SUPPLIED ARE OF AN INFERIOR QUALITY OR DO NOT CONFORM TO THE SPECIFICATIONS OF THE BID AND CONTRACT HEREIN.</p> <p>OPEN MARKET CLAUSE: THE DIRECTOR OF PURCHASING MAY AUTHORIZE A SPENDING UNIT TO PURCHASE ON THE OPEN MARKET, WITHOUT THE FILING OF A REQUISITION OR COST ESTIMATE, ITEMS SPECIFIED ON THIS CONTRACT FOR IMMEDIATE DELIVERY IN EMERGENCIES DUE TO UNFORESEEN CAUSES (INCLUDING BUT NOT LIMITED TO DELAYS IN TRANSPORTATION OR AN UNANTICIPATED INCREASE IN THE VOLUME OF WORK.)</p>						

SEE REVERSE SIDE FOR TERMS AND CONDITIONS

SIGNATURE: **Elwood Sarlo** TELEPHONE: **239-332-1955** DATE: **7-9-08**

TITLE: **VP** FERN: **39-0832854** ADDRESS CHANGES TO BE NOTED ABOVE

WHEN RESPONDING TO RFQ, INSERT NAME AND ADDRESS IN SPACE ABOVE LABELED 'VENDOR'



State of West Virginia  
 Department of Administration  
 Purchasing Division  
 2019 Washington Street East  
 Post Office Box 50130  
 Charleston, WV 25305-0130

**Request for  
 Quotation**

RFQ NUMBER  
 LAWND9

PAGE  
 4

ADDRESS TO BE RESPONDED TO (ATTENTION OF)  
 JO ANN ADKINS  
 304-556-8802

RFQ COPY  
 TYPE NAME/ADDRESS HERE  
**SARLO POWER MOWERS, INC**  
**P. O. Box 1169**  
**FT. MYERS, FL. 33902**

ALL STATE AGENCIES  
 AND POLITICAL SUBDIVISIONS  
 VARIOUS LOCALES AS INDICATED  
 BY ORDER

DATE PRINTED	TERMS OF SALE	SHIP VIA	PO#	FREIGHT TERMS
06/12/2008				
BID OPENING DATE: 07/10/2008		BID OPENING TIME 01:30PM		
LINE	QUANTITY	UOM	UNIT PRICE	AMOUNT
<p>QUANTITIES: QUANTITIES LISTED IN THE REQUISITION ARE APPROXIMATIONS ONLY, BASED ON ESTIMATES SUPPLIED BY THE STATE SPENDING UNIT. IT IS UNDERSTOOD AND AGREED THAT THE CONTRACT SHALL COVER THE QUANTITIES ACTUALLY ORDERED FOR DELIVERY DURING THE TERM OF THE CONTRACT, WHETHER MORE OR LESS THAN THE QUANTITIES SHOWN.</p> <p>ORDERING PROCEDURE: SPENDING UNIT(S) SHALL ISSUE A WRITTEN STATE CONTRACT ORDER (FORM NUMBER WV-39) TO THE VENDOR FOR COMMODITIES COVERED BY THIS CONTRACT. THE ORIGINAL COPY OF THE WV-39 SHALL BE MAILED TO THE VENDOR AS AUTHORIZATION FOR SHIPMENT, A SECOND COPY MAILED TO THE PURCHASING DIVISION, AND A THIRD COPY RETAINED BY THE SPENDING UNIT.</p> <p>BANKRUPTCY: IN THE EVENT THE VENDOR/CONTRACTOR FILES FOR BANKRUPTCY PROTECTION, THIS CONTRACT IS AUTOMATICALLY NULL AND VOID, AND IS TERMINATED WITHOUT FURTHER ORDER.</p> <p>THE TERMS AND CONDITIONS CONTAINED IN THIS CONTRACT SHALL SUPERSEDE ANY AND ALL SUBSEQUENT TERMS AND CONDITIONS WHICH MAY APPEAR ON ANY ATTACHED PRINTED DOCUMENTS SUCH AS PRICE LISTS, ORDER FORMS, SALES AGREEMENTS OR MAINTENANCE AGREEMENTS, INCLUDING ANY ELECTRONIC MEDIUM SUCH AS CD-ROM.</p> <p>REV. 04/11/2001</p> <p>PURCHASING CARD ACCEPTANCE: THE STATE OF WEST VIRGINIA CURRENTLY UTILIZES A VISA PURCHASING CARD PROGRAM WHICH IS ISSUED THROUGH A BANK. THE SUCCESSFUL VENDOR MUST ACCEPT THE STATE OF WEST VIRGINIA VISA PURCHASING CARD FOR PAYMENT OF ALL ORDERS PLACED BY ANY STATE AGENCY AS A CONDITION OF AWARD.</p>				
SEE REVERSE SIDE FOR TERMS AND CONDITIONS				
SIGNATURE	TELEPHONE		DATE	
<i>Clare Sarlo</i>	239-332-1955		7-09-08	
TITLE	FAX		ADDRESS CHANGES TO BE NOTED ABOVE	
VP	59-0852854			

WHEN RESPONDING TO RFQ, INSERT NAME AND ADDRESS IN SPACE ABOVE LABELED 'VENDOR'



State of West Virginia  
 Department of Administration  
 Purchasing Division  
 2019 Washington Street East  
 Post Office Box 50130  
 Charleston, WV 25305-0130

**Request for  
 Quotation**

RFQ NUMBER  
**LAWND9**

PAGE  
**5**

ADDRESS CORRESPONDENCE TO AT VENDOR OF  
**JO ANN ADKINS  
 304-556-8802**

RFQ COPY  
 TYPE NAME/ADDRESS HERE  
**SARLO POWER MOWERS, INC.  
 P.O. Box 1169  
 Ft. Myers, FL 33902**

ALL STATE AGENCIES  
 AND POLITICAL SUBDIVISIONS  
 VARIOUS LOCALES AS INDICATED  
 BY ORDER

DATE PRINTED <b>06/12/2008</b>	TERMS OF SALE	SHIP VIA	FOB	FREIGHT TERMS
-----------------------------------	---------------	----------	-----	---------------

BID OPENING DATE: **07/10/2008** BID OPENING TIME **01:30PM**

LINE	QUANTITY	UNIT	DATE NO.	ITEM NUMBER	UNIT PRICE	AMOUNT
<p><b>VENDOR PREFERENCE CERTIFICATE</b></p> <p>CERTIFICATION AND APPLICATION* IS HEREBY MADE FOR PREFERENCE IN ACCORDANCE WITH WEST VIRGINIA CODE, 5A-3-37 (DOES NOT APPLY TO CONSTRUCTION CONTRACTS).</p> <p>A. APPLICATION IS MADE FOR 2.5% PREFERENCE FOR THE REASON CHECKED:</p> <p>( ) BIDDER IS AN INDIVIDUAL RESIDENT VENDOR AND HAS RESIDED CONTINUOUSLY IN WEST VIRGINIA FOR FOUR (4) YEARS IMMEDIATELY PRECEDING THE DATE OF THIS CERTIFICATION; OR</p> <p>( ) BIDDER IS A PARTNERSHIP, ASSOCIATION OR CORPORATION RESIDENT VENDOR AND HAS MAINTAINED ITS HEAD-QUARTERS OR PRINCIPAL PLACE OF BUSINESS CONTINUOUSLY IN WEST VIRGINIA FOR FOUR (4) YEARS IMMEDIATELY PRECEDING THE DATE OF THIS CERTIFICATION; OR 80% OF THE OWNERSHIP INTEREST OF BIDDER IS HELD BY ANOTHER INDIVIDUAL, PARTNERSHIP, ASSOCIATION OR CORPORATION RESIDENT VENDOR WHO HAS MAINTAINED ITS HEADQUARTERS OR PRINCIPAL PLACE OF BUSINESS CONTINUOUSLY IN WEST VIRGINIA FOR FOUR (4) YEARS IMMEDIATELY PRECEDING THE DATE OF THIS CERTIFICATION; OR</p> <p>( ) BIDDER IS A CORPORATION NONRESIDENT VENDOR WHICH HAS AN AFFILIATE OR SUBSIDIARY WHICH EMPLOYS A MINIMUM OF ONE HUNDRED STATE RESIDENTS AND WHICH HAS MAINTAINED ITS HEADQUARTERS OR PRINCIPAL PLACE OF BUSINESS WITHIN WEST VIRGINIA CONTINUOUSLY FOR THE FOUR (4) YEARS IMMEDIATELY PRECEDING THE DATE OF THIS CERTIFICATION.</p>						

SEE REVERSE SIDE FOR TERMS AND CONDITIONS

SIGNATURE **C. Woodward** TELEPHONE **339-332-1955** DATE **7-9-08**

TITLE **VP** FEIN **59-0838854** ADDRESS CHANGES TO BE NOTED ABOVE

WHEN RESPONDING TO RFQ, INSERT NAME AND ADDRESS IN SPACE ABOVE LABELED 'VENDOR'



State of West Virginia  
 Department of Administration  
 Purchasing Division  
 2019 Washington Street East  
 Post Office Box 50130  
 Charleston, WV 25305-0130

**Request for Quotation**

RFQ NUMBER  
**LAWN09**

PAGE  
**6**

ADDRESS CORRESPONDENCE TO ATTENTION OF  
**JD ANN ADKINS  
 304-558-8802**

RFQ COPY  
 TYPE NAME/ADDRESS HERE  
**SARLO POWER MOWERS, INC.  
 P.O. Box 1169  
 FT. MYERS, FL. 33902**

ALL STATE AGENCIES  
 AND POLITICAL SUBDIVISIONS  
 VARIOUS LOCALES AS INDICATED  
 BY ORDER

DATE PRINTED	TERMS OF SALE	SHIP VIA	F.O.B.	FREIGHT TERMS
06/12/2008				
BID OPENING DATE: 07/10/2008		BID OPENING TIME 01:30PM		

LINE	QUANTITY	U.S.P.	UNIT NO.	ITEM NUMBER	UNIT PRICE	AMOUNT
<p>B. APPLICATION IS MADE FOR 2.5% PREFERENCE FOR THE REASON CHECKED:</p> <p>( ) BIDDER IS A RESIDENT VENDOR WHO CERTIFIES THAT, DURING THE LIFE OF THE CONTRACT, ON AVERAGE AT LEAST 75% OF THE EMPLOYEES WORKING ON THE PROJECT BEING BID ARE RESIDENTS OF WEST VIRGINIA WHO HAVE RESIDED IN THE STATE CONTINUOUSLY FOR THE TWO YEARS IMMEDIATELY PRECEDING SUBMISSION OF THIS BID;</p> <p>OR</p> <p>( ) BIDDER IS A NONRESIDENT VENDOR EMPLOYING A MINIMUM OF ONE HUNDRED STATE RESIDENTS OR IS A NONRESIDENT VENDOR WITH AN AFFILIATE OR SUBSIDIARY WHICH MAINTAINS ITS HEADQUARTERS OR PRINCIPAL PLACE OF BUSINESS WITHIN WEST VIRGINIA EMPLOYING A MINIMUM OF ONE HUNDRED STATE RESIDENTS WHO CERTIFIES THAT, DURING THE LIFE OF THE CONTRACT, ON AVERAGE AT LEAST 75% OF THE EMPLOYEES OR BIDDERS' AFFILIATE'S OR SUBSIDIARY'S EMPLOYEES ARE RESIDENTS OF WEST VIRGINIA WHO HAVE RESIDED IN THE STATE CONTINUOUSLY FOR THE TWO YEARS IMMEDIATELY PRECEDING SUBMISSION OF THIS BID.</p> <p>BIDDER UNDERSTANDS IF THE SECRETARY OF TAX &amp; REVENUE DETERMINES THAT A BIDDER RECEIVING PREFERENCE HAS FAILED TO CONTINUE TO MEET THE REQUIREMENTS FOR SUCH PREFERENCE, THE SECRETARY MAY ORDER THE DIRECTOR OF PURCHASING TO: (A) RESCIND THE CONTRACT OR PURCHASE ORDER ISSUED; OR (B) ASSESS A PENALTY AGAINST SUCH BIDDER IN AN AMOUNT NOT TO EXCEED 5% OF THE BID AMOUNT AND THAT SUCH PENALTY WILL BE PAID TO THE CONTRACTING AGENCY OR DEDUCTED FROM ANY UNPAID BALANCE ON THE CONTRACT OR PURCHASE ORDER.</p> <p>BY SUBMISSION OF THIS CERTIFICATE, BIDDER AGREES TO DISCLOSE ANY REASONABLY REQUESTED INFORMATION TO THE</p>						

SEE REVERSE SIDE FOR TERMS AND CONDITIONS

SIGNATURE: *[Signature]* TELEPHONE: **239-332-1955** DATE: **7-9-08**

TITLE: **VP** FAX: **59-0832854** ADDRESS CHANGES TO BE NOTED ABOVE

WHEN RESPONDING TO RFQ, INSERT NAME AND ADDRESS IN SPACE ABOVE LABELED 'VENDOR'



State of West Virginia  
 Department of Administration  
 Purchasing Division  
 2019 Washington Street East  
 Post Office Box 50130  
 Charleston, WV 25305-0130

# Request for Quotation

RFQ NUMBER:  
**LAWN09**

PAGE  
**7**

ADDRESS CORRESPONDENCE TO ATTENTION OF:  
**JO ANN ADKINS  
 304-558-8802**

RFQ COPY

TYPE NAME/ADDRESS HERE

**SARLO POWER MOWERS, INC.  
 P.O. Box 1169  
 Ft. Myers, FL 33902**

ALL STATE AGENCIES  
 AND POLITICAL SUBDIVISIONS  
 VARIOUS LOCALES AS INDICATED  
 BY ORDER

DATE PRINTED	TERMS OF SALE	SHIP VIA	FOB	FREIGHT TERMS
06/12/2008				

BID OPENING DATE: **07/10/2008** BID OPENING TIME **01:30PM**

LINE	QUANTITY	UOP	CAT NO	ITEM NUMBER	UNIT PRICE	AMOUNT
<p>PURCHASING DIVISION AND AUTHORIZES THE DEPARTMENT OF TAX AND REVENUE TO DISCLOSE TO THE DIRECTOR OF PURCHASING APPROPRIATE INFORMATION VERIFYING THAT BIDDER HAS PAID THE REQUIRED BUSINESS TAXES, PROVIDED THAT SUCH INFORMATION DOES NOT CONTAIN THE AMOUNTS OF TAXES PAID NOR ANY OTHER INFORMATION DEEMED BY THE TAX COMMISSIONER TO BE CONFIDENTIAL.</p> <p>UNDER PENALTY OF LAW FOR FALSE SWEARING (WEST VIRGINIA CODE 61-5-3), BIDDER HEREBY CERTIFIES THAT THIS CERTIFICATE IS TRUE AND ACCURATE IN ALL RESPECTS; AND THAT IF A CONTRACT IS ISSUED TO BIDDER AND IF ANYTHING CONTAINED WITHIN THIS CERTIFICATE CHANGES DURING THE TERM OF THE CONTRACT, BIDDER WILL NOTIFY THE PURCHASING DIVISION IN WRITING IMMEDIATELY.</p> <p>BIDDER: <b>SARLO POWER MOWERS INC.</b></p> <p>DATE: <b>7-9-2008</b></p> <p>SIGNED: <b>[Signature]</b></p> <p>TITLE: <b>VP</b></p> <p>* CHECK ANY COMBINATION OF PREFERENCE CONSIDERATION(S) IN EITHER "A" OR "B", OR BOTH "A" AND "B" WHICH YOU ARE ENTITLED TO RECEIVE. YOU MAY REQUEST UP TO THE MAXIMUM 5% PREFERENCE FOR BOTH "A" AND "B". (REV. 12/00)</p> <p>NOTICE</p>						

SEE REVERSE SIDE FOR TERMS AND CONDITIONS			
SIGNATURE <b>[Signature]</b>	TELEPHONE <b>239-332-1955</b>	DATE <b>7-9-08</b>	
TITLE <b>VP</b>	FEIN <b>59-0832854</b>	ADDRESS CHANGES TO BE NOTED ABOVE	

WHEN RESPONDING TO RFQ, INSERT NAME AND ADDRESS IN SPACE ABOVE LABELED 'VENDOR'



State of West Virginia  
Department of Administration  
Purchasing Division  
2019 Washington Street East  
Post Office Box 50130  
Charleston, WV 25305-0130

### Request for Quotation

RFQ NUMBER  
**LAWN09**

CASE  
**8**

ADDRESS FOR CORRESPONDENCE TO ATTENTION OF:  
**JD ANN ADKINS  
304-558-8802**

RFQ COPY  
TYPE NAME/ADDRESS HERE  
**SARLO POWER MOVERS, INC.  
P.O. BOX 1169  
Ft. MYERS, FL. 33902**

ALL STATE AGENCIES  
AND POLITICAL SUBDIVISIONS  
VARIOUS LOCALES AS INDICATED  
BY ORDER

DATE PRINTED	TERMS OF SALE	SHIP VIA	F.O.B.	FREIGHT TERMS		
06/12/2008						
BID OPENING DATE: 07/10/2008		BID OPENING TIME 01:30PM				
LINE	QUANTITY	U.P.	CAT. NO.	ITEM NUMBER	UNIT PRICE	AMOUNT
<p>A SIGNED BID MUST BE SUBMITTED TO:</p> <p>DEPARTMENT OF ADMINISTRATION PURCHASING DIVISION BUILDING 15 2019 WASHINGTON STREET, EAST CHARLESTON, WV 25305-0130</p> <p>THE BID SHOULD CONTAIN THIS INFORMATION ON THE FACE OF THE ENVELOPE OR THE BID MAY NOT BE CONSIDERED:</p> <p>SEALED BID</p> <p>BUYER: FILE 42</p> <p>RFQ. NO.: LAWN09</p> <p>BID OPENING DATE: JULY 10, 2008</p> <p>BID OPENING TIME: 1:30PM</p> <p>PLEASE PROVIDE A FAX NUMBER IN CASE IT IS NECESSARY TO CONTACT YOU REGARDING YOUR BID: ----- 239-332-7212 -----</p> <p>CONTACT PERSON (PLEASE PRINT CLEARLY): ----- <b>KEN BOYCE</b> -----</p>						
SEE REVERSE SIDE FOR TERMS AND CONDITIONS						
SIGNATURE <b>Clayton</b>				TELEPHONE <b>239-332-1955</b>	DATE <b>7-9-08</b>	
TITLE <b>VP</b>		FAX <b>59-0832854</b>		ADDRESS CHANGES TO BE NOTED ABOVE		

WHEN RESPONDING TO RFQ, INSERT NAME AND ADDRESS IN SPACE ABOVE LABELED 'VENDOR'



**LAWN09 General Specifications/Information:**

1. **Grade of equipment:** All commercial grade equipment shall be designed for long hours of continuous use with very few equipment failures. Gasoline powered hand-held tools shall be powerful and light in weight and easily controlled. Engine shall have full crank shafts supported with heavy duty ball bearings on each end.
2. In order to assure the availability of required lawn equipment, the State has been divided geographically into four regions as follows:

Region I: Hancock, Brooke, Ohio, Marshall, Wetzel, Monongalia, Marion, Harrison, Doddridge, Ritchie, Gilmer, Pleasants, Calhoun, Wirt, Wood, and Tyler Counties;

Region II: Mason, Cabell, Wayne, Mingo, Logan, Boone, Lincoln, Kanawha, Putnam, Roane and Jackson Counties;

Region III: Lewis, Upshur, Randolph, Pendleton, Hardy, Grant, Hampshire, Mineral, Morgan, Berkeley, Jefferson, Tucker, Barbour, Taylor and Preston Counties; and

Region IV: Braxton, Clay, Nicholas, Fayette, Raleigh, Wyoming, McDowell, Mercer, Summers, Greenbrier, Pocahontas, Webster and Monroe Counties.

Vendors may bid on one or more regions at their discretion based on their ability to adequately serve specified regions.

**Quote single percent discount from price list for all OEM Parts.**

All equipment shall have operator safety warning labels attached as recommended by the outdoor power equipment institute (OEPI).

2. All equipment shall be furnished with operator's manual and parts list (if available). If, for example, one agency purchases (10) of one unit of the same model, then there shall be ten (10) operator's manuals, but one parts list is sufficient.
3. **Warranty:** A minimum warranty period of 1 year shall be provided for all commercial equipment including parts, labor, and faulty workmanship. A copy of the manufacturer's warranty should be provided with the vendor bid response.
4. **Service/repair facilities:** On this request for quotation, the bidder must identify at least four authorized service and repair facilities located in



various areas of the State of West Virginia. Provide name, location, phone and fax number. This information shall be entered on the pricing/information pages.

5. All orders from this contract totaling \$250.00 or more shall be delivered FOB: Destination. Delivery shall be within fourteen (14) days after receipt of order by vendor. All equipment orders less than \$250.00 shall be delivered FOB: Shipping Point. Any transportation costs will be invoiced as a separate charge with the original freight bill attached to the invoice.
6. Bidder is required to supply information on the contract coordinator(s) in the event they are the successful bidder. This information shall be entered on the pricing/information pages and shall include name, telephone number and fax number.
7. Pricing: All pricing is firm for a period of one (1) year. If the manufacturer should change or discontinue a model number, then the vendor shall provide an alternate model with the same performance and construction features at the original bid price.
8. The item(s) as specified is (are) shown only as an example of the quality level and operational characteristics required by the State of West Virginia and not intended to mean the only acceptable brand. Vendors who are bidding alternates must so state and include pertinent literature and specifications. Failure to provide information covering any alternates bid may be grounds for rejection of the bid.
9. If any proprietary, trade, brand, or manufacturer's name or part number is used here in describing the required equipment, it shall be understood to indicate the minimum standard of composition and quality required and shall not be construed to exclude equipment that equals or exceeds the functional capability and quality of the named equipment.
10. The equipment bid herein shall be of standard manufacturer and shall be new and shall be of the current production year model.
11. Each vendor should provide detailed specifications for the make and model offered with their bid.
12. Verification of product quality is the responsibility of the vendor. The State of West Virginia may require certified mail test data, certifications or samples for testing of material bid.

13. Successful vendor is to provide a nine (9) month summary report of procurement volumes by item and dollar amounts. This report must also include any purchases made by any political subdivision as well as state agencies in the State of West Virginia. This is a single annual report which is to be furnished at the beginning of the tenth month of the contract. The report is to be delivered to Jo Ann Adkins, Senior Buyer, Purchasing Division, 2019 Washington Street, East, Charleston, West Virginia 25305-0130 or [jo.a.adkins@wv.gov](mailto:jo.a.adkins@wv.gov).
14. Vendor shall furnish manufacturer's certification that indicates you are able to supply new equipment as bid. This certification must have been in effect at the time of this bid.
15. Evaluation Procedure: All bids will be evaluated as to the lowest pricing on equipment which meets the specifications and is capable of being serviced and/or repaired at a minimum of four service locations within the State of West Virginia.
16. Previous annual purchases against the contract amount to approximately \$65,000. Subject annual dollar amount is shown for informational purposes only and is not intended to be construed as any guarantee of future contract usage.

## LAWN09 Item Specifications

### Items 1-5 – Lawn Mowers: Commercial Grade, Push & Walk – Behind, Rotary -Type:

- a. Engine: Gasoline Powered, 4 cycle, over-head valve (OHV), cast iron cylinder sleeve, full pressure lubrication, horsepower (minimum) is indicated on each line item.
- b. Deck: 12 to 14 gauge stamped steel or cast metal.
- c. Handles: Minimum 7/8" diameter, 14 gauge or 1" or 16 gauge continuous lopped, tubular steel.
- d. Controls: Positive control from the operator's position; variable running speeds, stoop, "Dead man" bar or lever to disengage the blade/engine.
- e. Wheels: Metal hubs with ball bearings on steel axel; rear wheel diameter: Minimum 8" semi-pneumatic wheel.
- f. Cutting: 3/4 inches to 4 inches acceptable; adjustable by hand without the use of hand tools. Minimum cutting width is indicated below.
- g. Equipment shall meet 2005 CA emission test

### Items 6-7 – Trimmer and Brush Cutters: Commercial Grade

- a. Engine: Two or four cycle, gasoline powered; piston ported engine, aluminum piston with two piston rings, full crank shaft supported with heavy duty ball bearings on each end; recoil starter, 18 ounce (minimum) fuel tank capacity. Engine displace (minimum) is indicated below.
- b. Controls: Positive controls from the operator's position; variable running speeds, stop.
- c. Shaft: Straight solid steel shaft.
- d. Head: String trimmer with shield, 17" Minimum
- e. Warranty: One year commercial warranty, with lifetime clutch and shaft warranty.
- f. Accessories: Mandrel, t-wrench, safety glasses, with barrier bar.

### Item 8-9 Lawn Edger

- a. Engine: Two or four cycle, gasoline powered, full crank shaft Supported with heavy duty ball bearings on each end; recoil starter, 18 ounce (minimum) fuel tank capacity.
- b. Shaft: Item 8 has a curved shaft
- c. Warranty: One year commercial warranty.

### Items 10-13 – Chain Saws

- a. Engine: Two cycle, gasoline powered; chrome cylinder and aluminum; piston with two piston rings, full crank shaft supported with ball bearings on each end; recoil starter, solid state ignition, 1 pint (minimum) fuel tank capacity. Engine displacement (minimum) is indicated below. Anti-vibration; chain brake, outboard mounted sprocket, fully automatic oiler.
- b. Bar scabbard and t-wrench
- c. Must meet EPA emissions standards.

**LAWN09 Item Specifications****Item 14 - Pole Pruner**

- a. **Engine:** Two cycle, Gasoline Powered; chrome cylinder liner, piston with two piston rings, full crank shaft supported with ball bearings on each end; recoil starter, solid state ignition, 18 ounce minimum fuel tank capacity, automatic gear driver oiler.
- b. **Extension:** Adjustable extension shaft to 11.5 feet.

**Item 15 - Power Washer**

- a. **Engine:** Gasoline Powered; 2 cycle, recoil starter, XXXX ounce Minimum fuel tank capacity.
- b. **Controls:** Positive control of throttle lever and shut-off switch from Operator's position.
- c. **Hose:** High pressure hose.
- d. **Warranty:** 2 year commercial warranty.

**Item 16-17 - Blower: Commercial Grade**

- a. **Engine:** Gasoline Powered; 2 cycle, recoil starter, 16 ounce minimum fuel tank capacity. Engine displacement is indicated on each line item.
- b. **Blower:** Centrifugal type, metal housing or material of equivalent strength/durability.
- c. **Controls:** Positive control of throttle lever and shut-off switch from operator's position.
- d. **Nozzles and Tubes:** Detachable sections attached at blower discharge-flexible coupling on back pack type.
- e. **Shoulder Harness Kit:** Required on back pack type.

**Item 18 - Garden Tractor**

- a. **Frame:** Heavy duty 10 gauge welded steel frame.
- b. **Engine:** 25 HP twin cylinder engine with power steering.
- c. **Transmission:** Hydrostatic with cruise control.
- d. **Deck:** Free floating mower deck with full width rollers and quick hitch attachment removal system
- e. **RMO:** Reverse mowing option and 18" turn radius.

**Item 19 - Garden Tractor - Zero Turn Radius**

- a. **Engine:** 27 HP twin-cylinder engine with power steering.
- b. **Transmission:** Hydrostatic with cruise control.
- c. **Speed:** Up to 12 MPH forward and 8 MPH reverse.
- d. **Cutting Deck:** 60" cut ANSI-approved, 5.5" deep deck
- e. **ROPS:** Foldable rollover protection system
- f. **Parking Brake:** Lever actuated drum and band integrated with transmission neutral interlock.

**Item 20 - Garden Tractor - Zero Turn Radius**

- a. **Engine:** 31 HP twin-cylinder engine with power steering.
- b. **Transmission:** Hydrostatic
- c. **Speed:** Up to 13 MPH forward and 8 MPH reverse.
- d. **Cutting Deck:** 72" cut, ANSI-approved, 5.5" deep deck
- e. **ROPS:** Foldable rollover protection system
- f. **Parking Brake:**

**LAWN09 Item Specifications**

**Item 21 – Utility Vehicle**

- a. Engine: 11 HP / 4 cycle gasoline engine. OHV
  - b. Towing Capacity: 900 lb on level terrain.
- Speed: Up to 20 MPH forward.

Pricing/Information Page

Item	Description	Brand	Model	Est. Usage	Brand Bid	Model Bid	Unit Cost	Total
Region I - Hancock, Brooke, Ohio, Marshall, Wetzel, Monongalia, Marion, Harrison, Doddridge, Gilmer,								
Company Name: SARLO POWER MOWERS, INC.								
Must be equal to or exceed:								
* 1	Lawn Mower, 4.5 HP, side discharge, push type, 21" Cut Width	Toro	22175	10	SARLO	621-2	\$ 395. <sup>00</sup>	\$ 395. <sup>00</sup>
* 2	Lawn Mower, 5.5 HP, side discharge, self propelled type, 21" cut width	Toro	22145	10	SARLO	WX624-SP	\$ 744. <sup>00</sup>	\$ 744. <sup>00</sup>
3	Lawn Mower, 15HP, side discharge, hydrostatic, 36" cut width (walk-behind)	Gravely	HE1536FXP	4	N-B	-	-	-
4	Lawn Mower, 18 HP, side discharge, gear-drive, 48" cut width (walk-behind)	John Deere	7H17	4	N-B	-	-	-
5	Lawn Mower, 20 HP, side discharge, self propelled type, 52" cut width, swivel front wheels, hydro drive	Exmark	TT23KCFMD524	7	N-B	-	-	-
6	Line Trimmer/Brush Cutter, engine displacement 31.4cc engine,	Stihl	FS100RX	30	N-B	-	-	-
7	Line Trimmer/Brush Cutter, engine displacement 36 cc engine minimum,	Stihl	FS130R	40	N-B	-	-	-
7a	Bulk String, 5 lbs .95	Stihl	0000-930-2718	50	N-B	-	-	-
7b	Brush Knife, 3 prong	Stihl	4112-713-4100	10	N-B	-	-	-
7c	Shoulder Strap for item 6 and 7	Stihl		25	N-B	-	-	-

Lawn09  
Pricing/Information Page

Item	Description	Brand	Model	Est. Usage	Brand Bid	Model Bid	Unit Cost	Total
8	Lawn Edger, engine displacement 28.4 cc	Stihl	FC 90	4	N-B	-	-	-
9	Lawn Edger, 4 HP, 9" blade	Troy-bilt	Lawn Edger	8	N-B	-	-	-
10	Heavy Duty 16" chain saw, 56.5 cc (minimum), 3.8 BHP.	Stihl	MS290	5	N-B	-	-	-
11	Heavy Duty 18" Chain Saw, 64.1 cc (minimum) 4.3 BHP	Stihl	MS390	5	N-B	-	-	-
12	Heavy Duty 20" chain saw, 59.0 cc (Minimum) 4.4BHP	Stihl	MS361	5	N-B	-	-	-
13	Heavy Duty 25" Chain Saw, 76.5 CC (Minimum) 6.0 BHP	Stihl	MS460	5	N-B	-	-	-
14	Pole Pruner, 12" chain bar, engine displacement 31.4 CC (Minimum), 1.3 BHP	Stihl	HT101	10	N-B	-	-	-
15	Power washer, 3000 PSI, 190 cc, 30' 1/4" high pressure hose	Troy-bilt	3000 PSI MAX	6	N-B	-	-	-
16	Blower, hand-tote, engine displacement 27 CC (Minimum), air volume: 4r30 CFM at end of tube	Stihl	BG65 D	5	N-B	-	-	-
17	Blower, back pack, engine displacement - 64CC (Minimum), 530 CFM air volume at the end of the tube, handle with controls mounted on tube, padded shoulder strap.	Stihl	BR550	30	N-B	-	-	-
18	Garden Tractor, 25 HP, side discharge, hydrostatic, 50" cut, 18" turn radius, key choice mowing,	Cub Cadet	LT 1050	4	N-B	-	-	-

LAWN09  
Pricing/Information Page

Item	Description	Brand	Model	Est. Usage	Brand Bid	Model Bid	Unit Cost	Total
20	Lawn Mower, 31 HP, zero turn radius, 72" cut width, 5.5" deep deck, ANSI approved, fuel capacity 12 gallons (min.), standard foldable rollover protection systems (ROPS), Hydro tracking adjustment	Gravely	272H XDZ	2	A-B	-	-	-
21	Utility Vehicle, 11 HP, 900 lb. towing capacity, ground clearance of 9.8" from foot platform. Seating capacity of 2.	Gator	TS	2	A-B	-	-	-
	Discount from list:		%		A-B	-	-	-

Vendor Name SARLO POWER MOWERS, INC.

P.O. Box 1169

Address

FT. MYERS, FL. 33902

Phone # 239-332-1955

Fax # 239-332-7212

Email LEX@SARLOMOWER.COM

Company Representative [Signature]

(Please print)

Authorized Signature [Signature]



Lawn09  
Pricing/Information Page

Item	Description	Brand	Model	Est. Usage	Brand Bid	Model Bid	Unit Cost	Total
19	Lawn Mower, 27 HP, zero turn radius, 60" cut width, 5.5" deep deck, ANSI approved, deluxe roll suspension seat, fuel capacity, 10 gallons(min), Standard foldable rollover protection systems (ROPS), Hydro tracking adjustment	John Deere	Z830A	3	N-B	-	-	-
20	Lawn Mower, 31 HP, zero turn radius, 72" cut width, 5.5" deep deck, ANSI approved, fuel capacity 12 gallons(min.), standard foldable rollover protection systems (ROPS), Hydro tracking adjustment	Gravely	272H XDZ	2	N-B	-	-	-
21	Utility Vehicle, 11 HP, 900 lb. towing capacity, ground clearance of 9.8" from foot platform. Seating capacity of 2.	Gator	TS	2	N-B	-	-	-
					N-B	-	-	-
	Discount from list:							
		%						

Vendor Name: SARLO POWER MOWERS, INC.

Phone # 239-332-1955

P.O. Box 1169

Fax # 239-332-7212

Address

F. MYERS, FL. 33902

Email: KEN@SARLOMOWER.COM

Company Representative KEN BOYCE

Authorized Signature *Ken Boyce*  
(Please print)

LAWN09  
Pricing/Information Page

Region II - Mason, Cabell, Wayne, Mingo, Logan, Boone, Lincoln, Kanawha, Putnam, Roane and Jackson									
Company Name: SARCO POWER MOWERS, INC.									
Item	Description	Brand	Model	Est. Usage	Brand Bid	Model Bid	Unit Cost	Total	
		Must be equal to or exceed:							
* 1	Lawn Mower, 4.5 HP, side discharge, push type, 21" Cut Width	Toro	22175	10	SARCO	621-2	\$395. <sup>20</sup>	\$3952. <sup>20</sup>	
2	Lawn Mower, 5.5 HP, side discharge, self propelled type, 21" cut width	Toro	22145	10	SARCO	KK-62145P	\$748. <sup>20</sup>	7482. <sup>20</sup>	
3	Lawn Mower, 15HP, side discharge, hydrostatic, 36" cut width (walk-behind)	Gravely	HE1536FXP	4	N-B	-	-	-	
4	Lawn Mower, 18 HP, side discharge, gear-drive, 48" cut width (walk-behind)	John Deere	7H17	4	N-B	-	-	-	
5	Lawn Mower, 20 HP, side discharge, self propelled type, 52" curt width, swivel front wheels, hydro drive	Exmark	TT23KCFMD524	7	N-B	-	-	-	
6	Line Trimmer/Brush Cutter, engine displacement 31.4cc engine,	Stihl	FS100RX	30	N-B	-	-	-	
7	Line Trimmer/Brush Cutter, engine displacement 36 cc engine minimum,	Stihl	FS130R	40	N-B	-	-	-	
7a	Bulk String, 5 lbs .95	Stihl	0000-930-2718	50	N-B	-	-	-	
7b	Brush Knife, 3 prong	Stihl	4112-713-4100	10	N-B	-	-	-	
7c	Shoulder Strap for item 6 and 7			25	N-B	-	-	-	
8	Lawn Edger, engine displacement 28.4 cc	Stihl	FC 90	4	N-B	-	-	-	
9	Lawn Edger, 4 HP, 9" blade	Troy-bilt	Lawn Edger	8	N-B	-	-	-	

LAWN09  
Pricing/Information Page

Item	Description	Brand	Model	Est. Usage	Brand Bid	Model Bid	Unit Cost	Total
10	Heavy Duty 16" chain saw, 56.5 cc (minimum), 3.8 BHP,	Stihl	MS290	5	N-B	-	-	-
11	Heavy Duty 18" Chain Saw, 64.1 cc (minimum) 4.3 BHP	Stihl	MS390	5	N-B	-	-	-
12	Heavy Duty 20" chain saw, 59.0 cc (Minimum) 4.4BHP	Stihl	MS361	5	N-B	-	-	-
13	Heavy Duty 25" Chain Saw, 76.5 CC (Minimum) 6.0 BHP	Stihl	MS460	5	N-B	-	-	-
14	Pole Pruner, 12" chain bar, engine displacement 31.4 CC (Minimum), 1.3 BHP	Stihl	HT101	10	N-B	-	-	-
15	Power washer, 3000 PSI, 190 cc, 30' 1/4" high pressure hose	Troy-bilt	3000 PSI MAX	6	N-B	-	-	-
16	Blower, hand-tote, engine displacement 27 CC (Minimum), air volume: 4r30 CFM at end of tube	Stihl	BG65 D	5	N-B	-	-	-
17	Blower, back pack, engine displacement - 64CC (Minimum), 530 CFM air volume at the end of the tube handle with controls mounted on tube, padded shoulder strap.	Stihl	BR550	30	N-B	-	-	-
18	Garden Tractor, 25 HP, side discharge, hydrostatic, 50" cut, 18" turn radius, key choice mowing.	Cub Cadet	LT 1050	4	N-B	-	-	-
19	Lawn Mower, 27 HP, zero turn radius, 60" cut width, 5.5" deep deck, ANSI approved, deluxe roll suspension seat, fuel capacity, 10 gallons(min), Standard foldable rollover protection systems (ROPS), Hydro tracking adjustment	John Deere	Z630A	3	N-B	-	-	-

Region III - Lewis, Upshur, Randolph, Pendleton, Hardy, Grant, Hampshire, Mineral, Morgan, Berkeley, Jefferson, Tucker, Barbour, Taylor, and Preston		Company Name: SARCO Power Mowers, Inc.		Must be equal to or exceed:					
Item	Description	Brand	Model	Est. Usage	Brand Bid	Model Bid	Unit Cost	Total	
1	Lawn Mower, 4.5 HP, side discharge, push type, 21" Cut Width	Toro	22175	10	SARCO	621-2	\$ 395.20	\$ 2952.00	
2	Lawn Mower, 5.5 HP, side discharge, self propelled type, 21" cut width	Toro	22145	10	SARCO	6245A	\$ 744.80	\$ 7448.00	
3	Lawn Mower, 15HP, side discharge, hydrostatic, 36" cut width (walk-behind)	Gravely	HE1536FXP	4	N-13				
4	Lawn Mower, 18 HP, side discharge, gear-drive, 48" cut width (walk-behind)	John Deere	7H17	4	N-13				
5	Lawn Mower, 20 HP, side discharge, self propelled type, 52" curt width, swivel front wheels, hydro drive	Exmark	TT23KCFMD524	7	N-13				
6	Line Trimmer/Brush Cutter, engine displacement 31.4cc engine,	Stihl	FS100RX	30	N-13				
7	Line Trimmer/Brush Cutter, engine displacement 36 cc engine minimum,	Stihl	FS130R	40	N-13				
7a	Bulk String, 5 lbs .95	Stihl	0000-930-2718	50	N-13				
7b	Brush Knife, 3 prong	Stihl	4112-713-4100	10	N-13				
7c	Shoulder Strap for item 6 and 7			25	N-13				
8	Lawn Edger, engine displacement 28.4 cc	Stihl	FC 90	4	N-13				
9	Lawn Edger, 4 HP, 9" blade	Troy-bilt	Lawn Edger	8	N-13				

LAWN09  
Pricing/Information Page

Item	Description	Brand	Model	Est. Usage	Brand Bid	Model Bid	Unit Cost	Total
10	Heavy Duty 16" chain saw, 56.5 cc (minimum), 3.8 BHP,	Stihl	MS290	5	N-B	-	-	-
11	Heavy Duty 18" Chain Saw, 64.1 cc (minimum) 4.3 BHP	Stihl	MS390	5	N-B	-	-	-
12	Heavy Duty 20" chain saw, 59.0 cc (Minimum) 4.4BHP	Stihl	MS361	5	N-B	-	-	-
13	Heavy Duty 25" Chain Saw, 76.5 CC (Minimum) 6.0 BHP	Stihl	MS460	5	N-B	-	-	-
14	Pole Pruner, 12" chain bar, engine displacement 31.4 CC (Minimum), 1.3 BHP	Stihl	HT101	10	N-B	-	-	-
15	Power washer, 3000 PSI, 190 cc, 30' 1/4" high pressure hose	Troy-bilt	3000 PSI MAX	6	N-B	-	-	-
16	Blower, hand-tole, engine displacement 27 CC (Minimum), air volume: 4r30 CFM at end of tube	Stihl	BG65 D	5	N-B	-	-	-
17	Blower, back pack, engine displacement - 64CC (Minimum), 530 CFM air volume at the end of the tube, handle with controls mounted on tube, padded shoulder strap.	Stihl	BR550	30	N-B	-	-	-
18	Garden Tractor, 25 HP, side discharge, hydrostatic, 50" cut, 18" turn radius, key choice mowing,	Cub Cadet	LT 1050	4	N-B	-	-	-
19	Lawn Mower, 27 HP, zero turn radius, 60" cut width, 5.5" deep deck, ANSI approved, deluxe roll suspension seat, fuel capacity, 10 gallons(min), Standard foldable rollover protection systems (ROPS), Hydro tracking adjustment	John Deere	Z830A	3	N-B	-	-	-

LAWN09  
Pricing/Information Page

Item	Description	Brand	Model	Est. Usage	Brand Bid	Model Bid	Unit Cost	Total
20	Lawn Mower, 31 HP, zero turn radius, 72" cut width, 5.5" deep deck, ANSI approved, fuel capacity 12 gallons(min.), standard foldable rollover protection systems (ROPS), Hydro tracking adjustment	Gravely	272H XDZ	2	N-B	-	-	-
21	Utility Vehicle, 11 HP, 900 lb. towing capacity, ground clearance of 9.8" from foot platform. Seating capacity of 2.	Gator	TS	2	N-B	-	-	-
	Discount from list:		%		N-B	-	-	-

Vendor Name SARLO POWER MOWERS, INC Phone # 239-332-1955  
P.O. Box 1169 Address Fax # 239-332-7212  
F. Myers, Jr. 33902 Email: KEN@SARLOPOWER.COM

Company Representative KEN BOYCE  
(Please print)  
Authorized Signature [Signature]

Region IV - Braxton, Clay, Nicholas, Fayette, Raleigh, Wyoming, McDowell, Mercer, Summers, Greenbrier, Pocahontas, Webster and Monroe		Company Name: SARLO Power Mowers, Inc.						
Item	Description	Brand	Model	Est. Usage	Brand Bid	Model Bid	Unit Cost	Total
		Must be equal to or exceed:						
1	Lawn Mower, 4.5 HP, side discharge, push type, 21" Cut Width	Toro	22175	10	SARLO	621-2	\$ 395. <sup>20</sup>	\$ 3952. <sup>20</sup>
2	Lawn Mower, 5.5 HP, side discharge, self propelled type, 21" cut width	Toro	22145	10	SARLO	60X-62Y-5P	\$ 744. <sup>80</sup>	\$ 7448. <sup>80</sup>
3	Lawn Mower, 15HP, side discharge, hydrostatic, 36" cut width (walk-behind)	Gravely	HE1536FXP	4	N-B			
4	Lawn Mower, 18 HP, side discharge, gear-drive, 48" cut width (walk-behind)	John Deere	7H17	4	N-B			
5	Lawn Mower, 20 HP, side discharge, self propelled type, 52" curt width, swivel front wheels, hyciro drive	Exmark	TT23KCFMD524	7	N-B			
6	Line Trimmer/Brush Cutter, engine displacement 31.4cc engine,	Stihl	FS100RX	30	N-B			
7	Line Trimmer/Brush Cutter, engine displacement 36 cc engine minimum,	Stihl	FS130R	40	N-B			
7a	Bulk String, 5 lbs .95	Stihl	0000-930-2718	50	N-B			
7b	Brush Knife, 3 prong	Stihl	4112-713-4100	10	N-B			
7c	Shoulder Strap for item 6 and 7			25	N-B			
8	Lawn Edger, engine displacement 28.4 cc	Stihl	FC 90	4	N-B			
9	Lawn Edger, 4 HP, 9" blade	Troy-bilt	Lawn Edger	8	N-B			

LAVN09  
Pricing/Information Page

Item	Description	Brand	Model	Est. Usage	Brand Bid	Model Bid	Unit Cost	Total
10	Heavy Duty 16" chain saw, 56.5 cc (minimum), 3.8 BHP,	Stihl	MS290	5	N-B	—	—	—
11	Heavy Duty 18" Chain Saw, 64.1 cc (minimum) 4.3 BHP	Stihl	MS390	5	N-B	—	—	—
12	Heavy Duty 20" chain saw, 59.0 cc (Minimum) 4.4BHP	Stihl	MS361	5	N-B	—	—	—
13	Heavy Duty 25" Chain Saw, 76.5 CC (Minimum) 6.0 BHP	Stihl	MS460	5	N-B	—	—	—
14	Pole Pruner, 12" chain bar, engine displacement 31.4 CC (Minimum), 1.3 BHP	Stihl	HT101	10	N-B	—	—	—
15	Power washer, 3000 PSI, 190 cc, 30' 1/4" high pressure hose	Troy-bilt	3000 PSI MAX	6	N-B	—	—	—
16	Blower, hand-tote, engine displacement 27 CC (Minimum), air volume: 4:30 CFM at end of tube	Stihl	BG65 D	5	N-B	—	—	—
17	Blower, back pack, engine displacement - 64CC (Minimum), 530 CFM air volume at the end of the tube, handle with controls mounted on tube, padded shoulder strap.	Stihl	BR550	30	N-B	—	—	—
18	Garden Tractor, 25 HP, side discharge, hydrostatic, 50" cut, 18" turn radius, key choice mowing.	Cub Cadet	LT 1050	4	N-B	—	—	—
19	Lawn Mower, 27 HP, zero turn radius, 60" cut width, 5.5" deep deck, ANSI approved, deluxe roll suspension seat, fuel capacity, 10 gallons(min), Standard foldable rollover protection systems (ROPS), Hydro tracking adjustment	John Deere	Z830A	3	N/B	—	—	—



LAWN09  
Pricing/Information Page

Item	Description	Brand	Model	Est. Usage	Brand Bid	Model Bid	Unit Cost	Total
20	Lawn Mower, 31 HP, zero turn radius, 72" cut width, 5.5" deep deck, ANSI approved, fuel capacity 12 gallons(min.), standard foldable rollover protection systems (ROPS), Hydro tracking adjustment	Gravely	272H XDZ	2	A-B	-	-	-
21	Utility Vehicle, 11 HP, 900 lb. towing capacity, ground clearance of 9.8" from foot platform. Seating capacity of 2.	Gator	TS	2	A-B	-	-	-
					A-B	-	-	-
	Discount from list:							
		%						

Vendor Name SARLO TRACTOR MOWERS, INC. Phone # 239-332-1955

P.O. Box 1168 Fax # 239-332-7212

Address

FE MEYER, P.O. 33902 Email: BEN@SARLOMOWER.COM

Company Representative

Ken Boyce

Authorized Signature

(Please print)  
Ken Boyce

LAWN09 SERVICE / REPAIR FACILITIES

Northern West Virginia  
Company Name \_\_\_\_\_  
Address \_\_\_\_\_  
Telephone \_\_\_\_\_  
Fax \_\_\_\_\_  
E-mail \_\_\_\_\_

Western West Virginia  
Company Name COBE TIMBER CO  
Address 100 BEESON RUN ROAD  
WALKER WV. 26180  
Telephone 304-679-3461  
Fax 304-679-5650  
E-mail COBETIMBERCO@ATTN.NET

Eastern West Virginia  
Company Name \_\_\_\_\_  
Address \_\_\_\_\_  
Telephone \_\_\_\_\_  
Fax \_\_\_\_\_  
E-mail \_\_\_\_\_

Southern West Virginia  
Company Name \_\_\_\_\_  
Address \_\_\_\_\_  
Telephone \_\_\_\_\_  
Fax \_\_\_\_\_  
E-mail \_\_\_\_\_

Central West Virginia  
Company Name 191 EQUIP. & REPAIR  
Address 650X WV 25123  
Telephone 304-4458-2550  
Fax \_\_\_\_\_  
E-mail \_\_\_\_\_

\* We will authorize any Briggs & Stratton Dealer

STATE OF WEST VIRGINIA  
Purchasing Division

**PURCHASING AFFIDAVIT**

**West Virginia Code §5A-3-10a states:** No contract or renewal of any contract may be awarded by the state or any of its political subdivisions to any vendor or prospective vendor when the vendor or prospective vendor or a related party to the vendor or prospective vendor is a debtor and the debt owed is an amount greater than one thousand dollars in the aggregate

**DEFINITIONS:**

"Debt" means any assessment, premium, penalty, fine, tax or other amount of money owed to the state or any of its political subdivisions because of a judgment, fine, permit violation, license assessment, defaulted workers' compensation premium, penalty or other assessment presently delinquent or due and required to be paid to the state or any of its political subdivisions, including any interest or additional penalties accrued thereon.

"Debtor" means any individual, corporation, partnership, association, limited liability company or any other form or business association owing a debt to the state or any of its political subdivisions. "Political subdivision" means any county commission; municipality; county board of education; any instrumentality established by a county or municipality; any separate corporation or instrumentality established by one or more counties or municipalities, as permitted by law; or any public body charged by law with the performance of a government function or whose jurisdiction is coextensive with one or more counties or municipalities. "Related party" means a party, whether an individual, corporation, partnership, association, limited liability company or any other form or business association or other entity whatsoever, related to any vendor by blood, marriage, ownership or contract through which the party has a relationship of ownership or other interest with the vendor so that the party will actually or by effect receive or control a portion of the benefit, profit or other consideration from performance of a vendor contract with the party receiving an amount that meets or exceed five percent of the total contract amount.

**EXCEPTION:** The prohibition of this section does not apply where a vendor has contested any tax administered pursuant to chapter eleven of this code, workers' compensation premium, permit fee or environmental fee or assessment and the matter has not become final or where the vendor has entered into a payment plan or agreement and the vendor is not in default of any of the provisions of such plan or agreement.

**LICENSING:** Vendors must be licensed and in good standing in accordance with any and all state and local laws and requirements by any state or local agency of West Virginia, including, but not limited to, the West Virginia Secretary of State's Office, the West Virginia Tax Department, West Virginia Insurance Commission, or any other state agencies or political subdivision. Furthermore, the vendor must provide all necessary releases to obtain information to enable the Director or spending unit to verify that the vendor is licensed and in good standing with the above entities.

**CONFIDENTIALITY:** The vendor agrees that he or she will not disclose to anyone, directly or indirectly, any such personally identifiable information or other confidential information gained from the agency, unless the individual who is the subject of the information consents to the disclosure in writing or the disclosure is made pursuant to the agency's policies, procedures and rules. Vendors should visit [www.state.wv.us/admin/purchase/privacy](http://www.state.wv.us/admin/purchase/privacy) for the Notice of Agency Confidentiality Policies.

Under penalty of law for false swearing (West Virginia Code, §61-5-3), it is hereby certified that the vendor acknowledges the information in this said affidavit and are in compliance with the requirements as stated.

Vendor's Name: SARLO POWER MOWERS, INC.

Authorized Signature: Elvis Sarlo Date: 7-9-08



## West Virginia State Pricing 2008

# Diesel Power

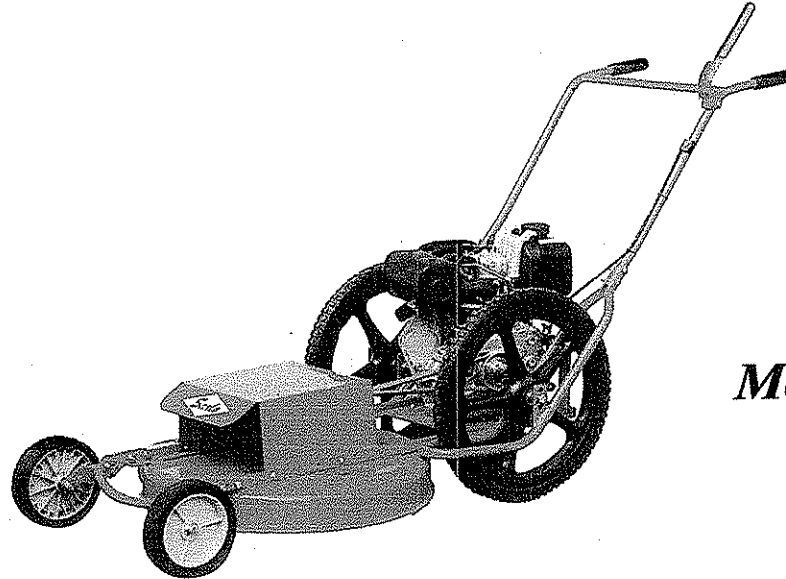

**Model 624D**

Mow all day on less than 1 gallon of fuel

	Diesel	Gas
• Life expectancy, engine	10,000 hours	1,500 hours
• Fuel consumption per hour	1/2 quart	1.5 quarts
• Fuel consumption per day (8 hour)	1 gallon	3 gallons
• Fuel Savings per mower after 3 years use - \$1649.00		

## State Price \$1,786.00

### LEASE options:

**36 months @\$ 53.00 per month**

Call for current rate

P.O. Box 1169.. Fort Myers, FL 33902 239-332-1955 Fax 239-332-7212 [www.sarlomower.com](http://www.sarlomower.com)

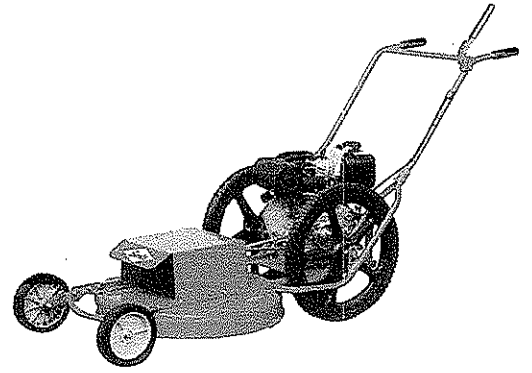
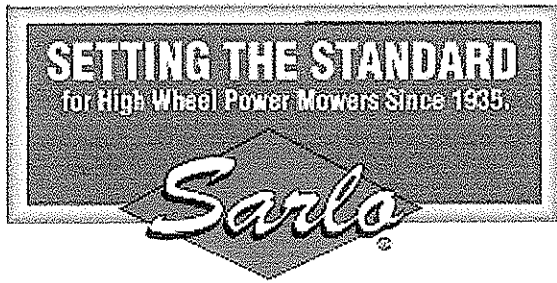

## Model 624D

- 24" Cut
- Diesel Power
- Compression release starting
- 10,000 hour engine life
- 8 hour run time per 1 gallon tank
- Field performance tested 36 months
- Pressure Lubrication with Trochoid Pump
  - Allowable inclination for continuous use - 20 degrees
- Side Discharge, Steel side chute
- 20" Heavy duty, 5 spoke wheels-w/ ball bearings
- 8" front wheels
- Plow style handles 14 gauge
- Quick height adjustment on front end
- Belt driven blade, wrapped, premium belt
- Steel belt cover 18 gauge
- 13 gauge steel deck w/ flanged lower edge
- Low resistance- double edge cutting blade
- Grease fittings on blade hub
- 3/16" welded- angle iron frame
- Maintenance free solid tires

Sarlo Power Mowers, Inc  
239-332-1955

PO Box 1169  
239-332-7212 (fax)

Fort Myers, Florida 33902  
[www.sarlomower.com](http://www.sarlomower.com)

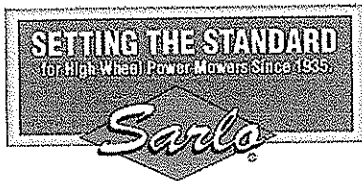

## West Virginia State Pricing 2008

# High Wheel Mowers 26" & 30" Self-Propelled

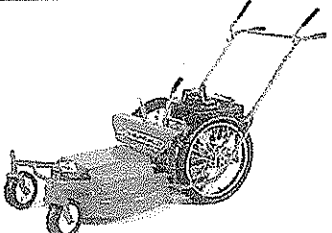
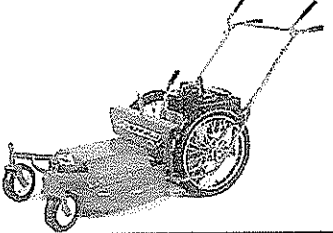
	
<p><b>1026-3SPSW</b>  26" Cut 11.5 Hp Briggs w/ AVS  Side Discharge 20" Heavy Duty Spoke Wheels, Heavy Duty-Tires W/ Sealed Heavy Duty Precision Ball Bearing, 8" Swivel Front Wheels, Plow Style Handles, Quick Height Adjustment, Self-propelled, 3 Speed Peerless Transmission Full Differential</p> <p><b>Retail \$1669.99      Contract Price \$1269.20</b></p>	<p><b>1030-3SPSW</b>  30" Cut 11.5 Hp Briggs w/ AVS  Side Discharge 20" Heavy Duty Spoke Wheels, Heavy Duty-Tires W/ Sealed Heavy Duty Precision Ball Bearing 8" Swivel Front Wheels, Plow Style Handles, Quick Height Adjustment, Self-propelled, 3 Speed Peerless Transmission Full Differential</p> <p><b>Retail \$1769.99      Contract Price \$1345.20</b></p>

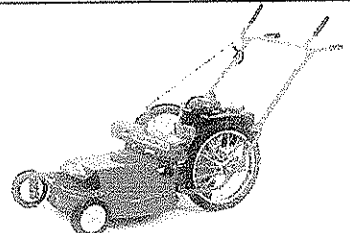
<p><b>1026SS</b>  26" Cut 11.5 Hp Briggs INTEK w/ AVS  Side Discharge 20" Heavy Duty Spoke Wheels, Heavy Duty-Tires W/ Sealed Heavy Duty Precision Ball Bearing  Plow Style Handles, Self-Propelled Full Differential  8" Swivel Front Wheels.</p> <p><b>Retail \$1449.99 Contract Price \$1102.00</b>  <b>NEW Engine from Briggs and Stratton</b>  <b>11.5 -HP OHV Engine with AVS</b></p> <p>This engine delivers power to the most demanding jobs  Standard Engine on 1026SS, 1026-3SPSW and  1030-3SPSW</p>

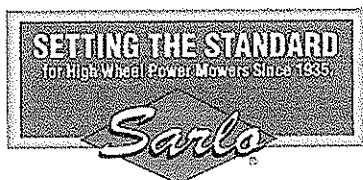

## West Virginia State Pricing 2008

### High Wheel Mowers 24"

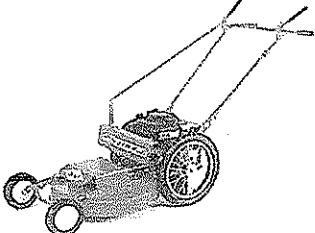
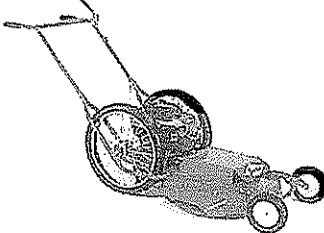
	
<p><b>WX24SP1/C</b>            24" Cut 6.75 Briggs            16" Heavy Duty Spoke Wheels            8" Front Wheels            Plow Style Handles, Quick Height Adjustment            Self-propelled, Full Differential</p> <p><b>Retail \$979.99    Contract Price \$744.80</b></p>	<p><b>624</b>            24" Cut 6.75 Briggs            Side Discharge            20" Heavy Duty Spoke Wheels            W/ Sealed Heavy Duty Precision Ball Bearings            8" Front Wheels            Plow Style Handles, Quick Height Adjustment</p> <p><b>Retail \$889.99    Contract Price \$676.40</b></p>

### High Wheel Mowers 24" Self-Propelled

<p><b>624SPSW</b>            24" Cut 6.5 HP Briggs            Side Discharge, Plow Style Handles            20" Heavy Duty Spoke Wheels, Heavy Duty-Tires            W/ Sealed Heavy Duty Precision Ball Bearing            7" Swivel Front Wheels            Self-Propelled Full Differential</p> <p><b>Retail \$1079.99    Contract Price \$820.80</b></p>

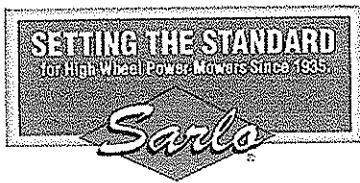

## West Virginia State Pricing 2008

### Walk Behind String Trimmers

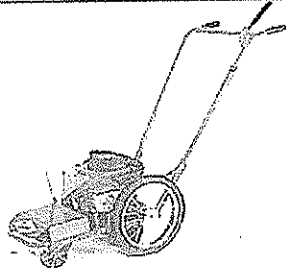
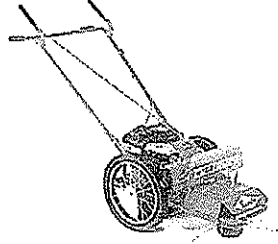
	
<p><b>SST6</b> String Trimmer Mower, Push 6 .75 Briggs, 16" Heavy Duty Spoke Wheels, Ball Bearing Aluminum Spin Head, Plow Style Handles</p> <p>Retail \$610.99      Contact Price \$464.36</p>	<p><b>SST6SP</b> String-Trimmer/Mower, Self-propelled 6 .75 Briggs 16" Heavy Duty Spoke Wheels, Ball Bearings Aluminum Spin Head, Plow Style Handles</p> <p>Retail \$920.99      Contact Price \$699.96</p>

### High Wheel Mowers 22" Push

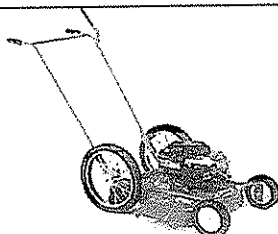
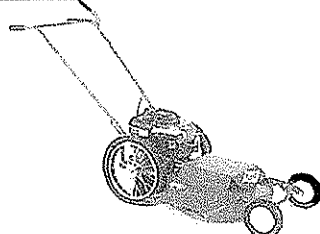
	
<p><b>621-2</b> 22" Cut 6 .5 HP Briggs Side Discharge, 16" Rear Wheels w/ 8" Stationary Front Wheels, Plow Style Handles, Quick Height Adjustment</p> <p>Retail \$519.99      Contact Price \$395.20</p>	<p><b>622</b> 22" Cut 6 .75 Briggs Side Discharge 16" Heavy Duty Spoke Wheels 8" Front Wheels Plow Style Handles, Quick Height Adjustment</p> <p>Retail \$829.99      Contact Price \$630.80</p>





State of West Virginia  
 Department of Administration  
 Purchasing Division  
 2019 Washington Street East  
 Post Office Box 50130  
 Charleston, WV 25305-0130

# Request for Quotation

RFQ NUMBER  
LAWN09

PAGE  
1

ADDRESS CORRESPONDENCE TO ATTENTION OF  
 JO ANN ADKINS  
 304-558-8802

RFQ COPY  
 TYPE NAME/ADDRESS HERE

ALL STATE AGENCIES  
 AND POLITICAL SUBDIVISIONS  
 VARIOUS LOCALES AS INDICATED  
 BY ORDER

DATE PRINTED 07/10/2008	TERMS OF SALE	SHIP VIA	FOB	FREIGHT TERMS
BID OPENING DATE: 07/17/2008		BID OPENING TIME 01:30PM		

LINE	QUANTITY	UOP	CAT NO	ITEM NUMBER	UNIT PRICE	AMOUNT
*****ADDENDUM NO. 2*****						
1. BID OPENING DATE HAS BEEN MOVED TO 07/17/2008.						
2. UNIT PRICING IS TO REMAIN FIRM FOR A PERIOD OF ONE YEAR.						
*****END OF ADDENDUM NO. 2*****						
0001	1	EA		515-45		
GASOLINE POWERED LAWN MAINTENANCE EQUIPMENT						

SEE REVERSE SIDE FOR TERMS AND CONDITIONS

SIGNATURE: *Elaine Sanko* TELEPHONE: 239-332-1955 DATE: 7-10-08

TITLE: VP FEIN: 59-0832854 ADDRESS CHANGES TO BE NOTED ABOVE

WHEN RESPONDING TO RFQ, INSERT NAME AND ADDRESS IN SPACE ABOVE LABELED 'VENDOR'

*EX BACK TO - 304-558-3970*

*7-10-08*