



State of West Virginia
 Department of Administration
 Purchasing Division
 2019 Washington Street East
 Post Office Box 50130
 Charleston, WV 25305-0130

Request for Quotation

RFQ NUMBER: **DJS010253**

PAGE: **1**

ADDRESS CORRESPONDENCE TO ATTENTION OF:
JOHN ABBOTT
304-558-2544

VENDOR

RFQ COPY
 TYPE NAME/ADDRESS HERE
The Systems Depot
610 E STREET
So. Chas. WV 25303

SHIP TO

DIVISION OF JUVENILE SERVICES
SECOND FLOOR
1200 QUARRIER STREET
CHARLESTON, WV
25301 304-558-6029

DATE PRINTED	TERMS OF SALE	SHIP VIA	FOB	FREIGHT TERMS
08/13/2008				

BID OPENING DATE: **08/28/2008** BID OPENING TIME: **01:30PM**

LINE	QUANTITY	UOP	CAT NO	ITEM NUMBER	UNIT PRICE	AMOUNT
0001	1	LS		840-84		45,435.00
<p>VIDEO SURVEILLANCE SYSTEMS</p> <p>OPEN-END CONTRACT TO PROVIDE VIDEO SURVEILLANCE EQUIPMENT TO THE WEST VIRGINIA DIVISION OF JUVENILE SERVICES, PER THE SPECIFICATIONS.</p> <p>EXHIBIT 4</p> <p>LOCAL GOVERNMENT BODIES: UNLESS THE VENDOR INDICATES IN THE BID HIS REFUSAL TO EXTEND THE PRICES, TERMS, AND CONDITIONS OF THE BID TO COUNTY, SCHOOL, MUNICIPAL AND OTHER LOCAL GOVERNMENT BODIES, THE BID SHALL EXTEND TO POLITICAL SUBDIVISIONS OF THE STATE OF WEST VIRGINIA. IF THE VENDOR DOES NOT WISH TO EXTEND THE PRICES, TERMS, AND CONDITIONS OF THE BID TO ALL POLITICAL SUBDIVISIONS OF THE STATE, THE VENDOR MUST CLEARLY INDICATE SUCH REFUSAL IN HIS BID. SUCH REFUSAL SHALL NOT PREJUDICE THE AWARD OF THIS CONTRACT IN ANY MANNER.</p> <p>REV. 3/88</p> <p>EXHIBIT 3</p> <p>LIFE OF CONTRACT: THIS CONTRACT BECOMES EFFECTIVE ON AND EXTENDS FOR A PERIOD OF ONE (1) YEAR OR UNTIL SUCH "REASONABLE TIME" THEREAFTER AS IS NECESSARY TO OBTAIN A NEW CONTRACT OR RENEW THE ORIGINAL CONTRACT. THE "REASONABLE TIME" PERIOD SHALL NOT EXCEED TWELVE (12) MONTHS. DURING THIS "REASONABLE</p>						

RECEIVED
08 AUG 28 AM 10:40
 PURCHASING DIVISION
 STATE OF WV

SEE REVERSE SIDE FOR TERMS AND CONDITIONS

SIGNATURE: *Gregory C. Legg* TELEPHONE: **304-746-8820** DATE: **8/28/08**

TITLE: *Branch Manager* FEIN: **562228173** ADDRESS CHANGES TO BE NOTED ABOVE

WHEN RESPONDING TO RFQ, INSERT NAME AND ADDRESS IN SPACE ABOVE LABELED 'VENDOR'

**GENERAL TERMS & CONDITIONS
REQUEST FOR QUOTATION (RFQ) AND REQUEST FOR PROPOSAL (RFP)**

1. Awards will be made in the best interest of the State of West Virginia.
2. The State may accept or reject in part, or in whole, any bid.
3. All quotations are governed by the *West Virginia Code* and the *Legislative Rules* of the Purchasing Division.
4. Prior to any award, the apparent successful vendor must be properly registered with the Purchasing Division and have paid the required \$125 fee.
5. All services performed or goods delivered under State Purchase Order/Contracts are to be continued for the term of the Purchase Order/Contracts, contingent upon funds being appropriated by the Legislature or otherwise being made available. In the event funds are not appropriated or otherwise available for these services or goods, this Purchase Order/Contract becomes void and of no effect after June 30.
6. Payment may only be made after the delivery and acceptance of goods or services.
7. Interest may be paid for late payment in accordance with the *West Virginia Code*.
8. Vendor preference will be granted upon written request in accordance with the *West Virginia Code*.
9. The State of West Virginia is exempt from federal and state taxes and will not pay or reimburse such taxes.
10. The Director of Purchasing may cancel any Purchase Order/Contract upon 30 days written notice to the seller.
11. The laws of the State of West Virginia and the *Legislative Rules* of the Purchasing Division shall govern all rights and duties under the Contract, including without limitation the validity of this Purchase Order/Contract.
12. Any reference to automatic renewal is hereby deleted. The Contract may be renewed only upon mutual written agreement of the parties.
13. **BANKRUPTCY:** In the event the vendor/contractor files for bankruptcy protection, this Contract may be deemed null and void, and terminated without further order.
14. **HIPAA BUSINESS ASSOCIATE ADDENDUM:** The West Virginia State Government HIPAA Business Associate Addendum (BAA), approved by the Attorney General, and available online at the Purchasing Division's web site (<http://www.state.wv.us/admin/purchase/vrc/hipaa.htm>) is hereby made part of the agreement. Provided that, the Agency meets the definition of a Cover Entity (45 CFR §160.103) and will be disclosing Protected Health Information (45 CFR §160.103) to the vendor.
15. **WEST VIRGINIA ALCOHOL & DRUG-FREE WORKPLACE ACT:** If this Contract constitutes a public improvement construction contract as set forth in Article 1D, Chapter 21 of the West Virginia Code ("The West Virginia Alcohol and Drug-Free Workplace Act"), then the following language shall hereby become part of this Contract: "The contractor and its subcontractors shall implement and maintain a written drug-free workplace policy in compliance with the West Virginia Alcohol and Drug-Free Workplace Act, as set forth in Article 1D, Chapter 21 of the West Virginia Code. The contractor and its subcontractors shall provide a sworn statement in writing, under the penalties of perjury, that they maintain a valid drug-free work place policy in compliance with the West Virginia and Drug-Free Workplace Act. It is understood and agreed that this Contract shall be cancelled by the awarding authority if the Contractor: 1) Fails to implement its drug-free workplace policy; 2) Fails to provide information regarding implementation of the contractor's drug-free workplace policy at the request of the public authority; or 3) Provides to the public authority false information regarding the contractor's drug-free workplace policy."

INSTRUCTIONS TO BIDDERS

1. Use the quotation forms provided by the Purchasing Division.
2. **SPECIFICATIONS:** Items offered must be in compliance with the specifications. Any deviation from the specifications must be clearly indicated by the bidder. Alternates offered by the bidder as **EQUAL** to the specifications must be clearly defined. A bidder offering an alternate should attach complete specifications and literature to the bid. The Purchasing Division may waive minor deviations to specifications.
3. Complete all sections of the quotation form.
4. Unit prices shall prevail in case of discrepancy.
5. All quotations are considered F.O.B. destination unless alternate shipping terms are clearly identified in the quotation.
6. **BID SUBMISSION:** All quotations must be delivered by the bidder to the office listed below prior to the date and time of the bid opening. Failure of the bidder to deliver the quotations on time will result in bid disqualifications: Department of Administration, Purchasing Division, 2019 Washington Street East, P.O. Box 50130, Charleston, WV 25305-0130



State of West Virginia
 Department of Administration
 Purchasing Division
 2019 Washington Street East
 Post Office Box 50130
 Charleston, WV 25305-0130

Request for Quotation

RFQ NUMBER
DJS010253

PAGE
2

ADDRESS CORRESPONDENCE TO ATTENTION OF
**JOHN ABBOTT
 304-558-2544**

RFQ COPY

TYPE NAME/ADDRESS HERE
**The Systems Depot
 610 E Street
 So. Chas. WV 25303**

DIVISION OF JUVENILE SERVICES
 SECOND FLOOR
 1200 QUARRIER STREET
 CHARLESTON, WV
 25301 304-558-6029

DATE PRINTED 08/13/2008	TERMS OF SALE	SHIP VIA	FOB	FREIGHT TERMS
-----------------------------------	---------------	----------	-----	---------------

BID OPENING DATE: **08/28/2008** BID OPENING TIME **01:30PM**

LINE	QUANTITY	UOP	CAT NO	ITEM NUMBER	UNIT PRICE	AMOUNT
<p>TIME" THE VENDOR MAY TERMINATE THIS CONTRACT FOR ANY REASON UPON GIVING THE DIRECTOR OF PURCHASING 30 DAYS WRITTEN NOTICE.</p> <p>UNLESS SPECIFIC PROVISIONS ARE STIPULATED ELSEWHERE IN THIS CONTRACT DOCUMENT, THE TERMS, CONDITIONS AND PRICING SET HEREIN ARE FIRM FOR THE LIFE OF THE CONTRACT.</p> <p>RENEWAL: THIS CONTRACT MAY BE RENEWED UPON THE MUTUAL WRITTEN CONSENT OF THE SPENDING UNIT AND VENDOR, SUBMITTED TO THE DIRECTOR OF PURCHASING THIRTY (30) DAYS PRIOR TO THE EXPIRATION DATE. SUCH RENEWAL SHALL BE IN ACCORDANCE WITH THE TERMS AND CONDITIONS OF THE ORIGINAL CONTRACT AND SHALL BE LIMITED TO TWO (2) ONE (1) YEAR PERIODS.</p> <p>CANCELLATION: THE DIRECTOR OF PURCHASING RESERVES THE RIGHT TO CANCEL THIS CONTRACT IMMEDIATELY UPON WRITTEN NOTICE TO THE VENDOR IF THE COMMODITIES AND/OR SERVICES SUPPLIED ARE OF AN INFERIOR QUALITY OR DO NOT CONFORM TO THE SPECIFICATIONS OF THE BID AND CONTRACT HEREIN.</p> <p>OPEN MARKET CLAUSE: THE DIRECTOR OF PURCHASING MAY AUTHORIZE A SPENDING UNIT TO PURCHASE ON THE OPEN MARKET, WITHOUT THE FILING OF A REQUISITION OR COST ESTIMATE, ITEMS SPECIFIED ON THIS CONTRACT FOR IMMEDIATE DELIVERY IN EMERGENCIES DUE TO UNFORESEEN CAUSES (INCLUDING BUT NOT LIMITED TO DELAYS IN TRANSPORTATION OR AN UNANTICIPATED INCREASE IN THE VOLUME OF WORK.)</p> <p>QUANTITIES: QUANTITIES LISTED IN THE REQUISITION ARE APPROXIMATIONS ONLY, BASED ON ESTIMATES SUPPLIED BY THE STATE SPENDING UNIT. IT IS UNDERSTOOD AND AGREED THAT THE CONTRACT SHALL COVER THE QUANTITIES ACTUALLY</p>						

SEE REVERSE SIDE FOR TERMS AND CONDITIONS

SIGNATURE <i>Gregory C. Legg</i>	TELEPHONE 304-746-8820	DATE 8/28/08
TITLE BRANCH MANAGER	FEIN 562228173	ADDRESS CHANGES TO BE NOTED ABOVE

WHEN RESPONDING TO RFQ, INSERT NAME AND ADDRESS IN SPACE ABOVE LABELED 'VENDOR'



State of West Virginia
 Department of Administration
 Purchasing Division
 2019 Washington Street East
 Post Office Box 50130
 Charleston, WV 25305-0130

Request for Quotation

RFQ NUMBER
DJS010253

PAGE
3

ADDRESS CORRESPONDENCE TO ATTENTION OF
JOHN ABBOTT
304-558-2544

RFQ COPY

TYPE NAME/ADDRESS HERE

The Systems Depot
610 E Street
So. Chas. WV 25303

DIVISION OF JUVENILE SERVICES

SECOND FLOOR
 1200 QUARRIER STREET
 CHARLESTON, WV
 25301 304-558-6029

DATE PRINTED	TERMS OF SALE	SHIP VIA	FOB	FREIGHT TERMS
08/13/2008				

BID OPENING DATE: **08/28/2008** BID OPENING TIME **01:30PM**

LINE	QUANTITY	UOP	CAT NO.	ITEM NUMBER	UNIT PRICE	AMOUNT
<p>ORDERED FOR DELIVERY DURING THE TERM OF THE CONTRACT, WHETHER MORE OR LESS THAN THE QUANTITIES SHOWN.</p> <p>ORDERING PROCEDURE: SPENDING UNIT(S) SHALL ISSUE A WRITTEN STATE CONTRACT ORDER (FORM NUMBER WV-39) TO THE VENDOR FOR COMMODITIES COVERED BY THIS CONTRACT. THE ORIGINAL COPY OF THE WV-39 SHALL BE MAILED TO THE VENDOR AS AUTHORIZATION FOR SHIPMENT, A SECOND COPY MAILED TO THE PURCHASING DIVISION, AND A THIRD COPY RETAINED BY THE SPENDING UNIT.</p> <p>BANKRUPTCY: IN THE EVENT THE VENDOR/CONTRACTOR FILES FOR BANKRUPTCY PROTECTION, THIS CONTRACT IS AUTOMATICALLY NULL AND VOID, AND IS TERMINATED WITHOUT FURTHER ORDER.</p> <p>THE TERMS AND CONDITIONS CONTAINED IN THIS CONTRACT SHALL SUPERSEDE ANY AND ALL SUBSEQUENT TERMS AND CONDITIONS WHICH MAY APPEAR ON ANY ATTACHED PRINTED DOCUMENTS SUCH AS PRICE LISTS, ORDER FORMS, SALES AGREEMENTS OR MAINTENANCE AGREEMENTS, INCLUDING ANY ELECTRONIC MEDIUM SUCH AS CD-ROM.</p> <p>REV. 04/11/2001</p> <p>VENDOR PREFERENCE CERTIFICATE</p> <p>CERTIFICATION AND APPLICATION* IS HEREBY MADE FOR PREFERENCE IN ACCORDANCE WITH WEST VIRGINIA CODE, 5A-3-37 (DOES NOT APPLY TO CONSTRUCTION CONTRACTS).</p> <p>A. APPLICATION IS MADE FOR 2.5% PREFERENCE FOR THE REASON CHECKED:</p> <p>() BIDDER IS AN INDIVIDUAL RESIDENT VENDOR AND HAS RESIDED CONTINUOUSLY IN WEST VIRGINIA FOR FOUR</p>						

SEE REVERSE SIDE FOR TERMS AND CONDITIONS

SIGNATURE *Gregory C. Legg* TELEPHONE **304-746-8920** DATE **8/28/08**

TITLE **BRANCH MANAGER** FEIN **362228173** ADDRESS CHANGES TO BE NOTED ABOVE

WHEN RESPONDING TO RFQ, INSERT NAME AND ADDRESS IN SPACE ABOVE LABELED 'VENDOR'



State of West Virginia
 Department of Administration
 Purchasing Division
 2019 Washington Street East
 Post Office Box 50130
 Charleston, WV 25305-0130

**Request for
 Quotation**

RFQ NUMBER
DJS010253

PAGE
4

ADDRESS CORRESPONDENCE TO ATTENTION OF
**JOHN ABBOTT
 304-558-2544**

RFQ COPY

TYPE NAME/ADDRESS HERE

**The Systems Depot
 610 E Street
 So. CHAS. WV 25303**

DIVISION OF JUVENILE SERVICES

SECOND FLOOR
 1200 QUARRIER STREET
 CHARLESTON, WV
 25301 304-558-6029

DATE PRINTED	TERMS OF SALE	SHIP VIA	FOB	FREIGHT TERMS
08/13/2008				

BID OPENING DATE: **08/28/2008** BID OPENING TIME **01:30PM**

LINE	QUANTITY	UOP	CAT NO	ITEM NUMBER	UNIT PRICE	AMOUNT
<p>(4) YEARS IMMEDIATELY PRECEDING THE DATE OF THIS CERTIFICATION; OR</p> <p>() BIDDER IS A PARTNERSHIP, ASSOCIATION OR CORPORATION RESIDENT VENDOR AND HAS MAINTAINED ITS HEAD-QUARTERS OR PRINCIPAL PLACE OF BUSINESS CONTINUOUSLY IN WEST VIRGINIA FOR FOUR (4) YEARS IMMEDIATELY PRECEDING THE DATE OF THIS CERTIFICATION; OR 80% OF THE OWNERSHIP INTEREST OF BIDDER IS HELD BY ANOTHER INDIVIDUAL, PARTNERSHIP, ASSOCIATION OR CORPORATION RESIDENT VENDOR WHO HAS MAINTAINED ITS HEADQUARTERS OR PRINCIPAL PLACE OF BUSINESS CONTINUOUSLY IN WEST VIRGINIA FOR FOUR (4) YEARS IMMEDIATELY PRECEDING THE DATE OF THIS CERTIFICATION; OR</p> <p>() BIDDER IS A CORPORATION NONRESIDENT VENDOR WHICH HAS AN AFFILIATE OR SUBSIDIARY WHICH EMPLOYS A MINIMUM OF ONE HUNDRED STATE RESIDENTS AND WHICH HAS MAINTAINED ITS HEADQUARTERS OR PRINCIPAL PLACE OF BUSINESS WITHIN WEST VIRGINIA CONTINUOUSLY FOR THE FOUR (4) YEARS IMMEDIATELY PRECEDING THE DATE OF THIS CERTIFICATION.</p> <p>B. APPLICATION IS MADE FOR 2.5% PREFERENCE FOR THE REASON CHECKED:</p> <p>() BIDDER IS A RESIDENT VENDOR WHO CERTIFIES THAT, DURING THE LIFE OF THE CONTRACT, ON AVERAGE AT LEAST 75% OF THE EMPLOYEES WORKING ON THE PROJECT BEING BID ARE RESIDENTS OF WEST VIRGINIA WHO HAVE RESIDED IN THE STATE CONTINUOUSLY FOR THE TWO YEARS IMMEDIATELY PRECEDING SUBMISSION OF THIS BID;</p> <p>OR</p> <p>() BIDDER IS A NONRESIDENT VENDOR EMPLOYING A MINIMUM OF ONE HUNDRED STATE RESIDENTS OR IS A NONRESIDENT VENDOR WITH AN AFFILIATE OR SUBSIDIARY</p>						

SEE REVERSE SIDE FOR TERMS AND CONDITIONS

SIGNATURE <i>Gregory C. Leagy</i>	TELEPHONE 304-746-8820	DATE 8/28/08
TITLE BRANCH MANAGER	FAX 562228173	ADDRESS CHANGES TO BE NOTED ABOVE

WHEN RESPONDING TO RFQ, INSERT NAME AND ADDRESS IN SPACE ABOVE LABELED 'VENDOR'



State of West Virginia
 Department of Administration
 Purchasing Division
 2019 Washington Street East
 Post Office Box 50130
 Charleston, WV 25305-0130

Request for Quotation

RFQ NUMBER
DJS010253

PAGE
5

ADDRESS CORRESPONDENCE TO ATTENTION OF
**JOHN ABBOTT
 304-558-2544**

RFQ COPY

TYPE NAME/ADDRESS HERE

**The Systems Depot
 610 E Street
 So. Chas. WV 25303**

DIVISION OF JUVENILE SERVICES

SECOND FLOOR
 1200 QUARRIER STREET
 CHARLESTON, WV
 25301 304-558-6029

DATE PRINTED	TERMS OF SALE	SHIP VIA	F.O.B.	FREIGHT TERMS
08/13/2008				
BID OPENING DATE: 08/28/2008		BID OPENING TIME 01:30PM		

LINE	QUANTITY	UQP	CAT NO	ITEM NUMBER	UNIT PRICE	AMOUNT
<p>WHICH MAINTAINS ITS HEADQUARTERS OR PRINCIPAL PLACE OF BUSINESS WITHIN WEST VIRGINIA EMPLOYING A MINIMUM OF ONE HUNDRED STATE RESIDENTS WHO CERTIFIES THAT, DURING THE LIFE OF THE CONTRACT, ON AVERAGE AT LEAST 75% OF THE EMPLOYEES OR BIDDERS' AFFILIATE'S OR SUBSIDIARY'S EMPLOYEES ARE RESIDENTS OF WEST VIRGINIA WHO HAVE RESIDED IN THE STATE CONTINUOUSLY FOR THE TWO YEARS IMMEDIATELY PRECEDING SUBMISSION OF THIS BID.</p> <p>BIDDER UNDERSTANDS IF THE SECRETARY OF TAX & REVENUE DETERMINES THAT A BIDDER RECEIVING PREFERENCE HAS FAILED TO CONTINUE TO MEET THE REQUIREMENTS FOR SUCH PREFERENCE, THE SECRETARY MAY ORDER THE DIRECTOR OF PURCHASING TO: (A) RESCIND THE CONTRACT OR PURCHASE ORDER ISSUED; OR (B) ASSESS A PENALTY AGAINST SUCH BIDDER IN AN AMOUNT NOT TO EXCEED 5% OF THE BID AMOUNT AND THAT SUCH PENALTY WILL BE PAID TO THE CONTRACTING AGENCY OR DEDUCTED FROM ANY UNPAID BALANCE ON THE CONTRACT OR PURCHASE ORDER.</p> <p>BY SUBMISSION OF THIS CERTIFICATE, BIDDER AGREES TO DISCLOSE ANY REASONABLY REQUESTED INFORMATION TO THE PURCHASING DIVISION AND AUTHORIZES THE DEPARTMENT OF TAX AND REVENUE TO DISCLOSE TO THE DIRECTOR OF PURCHASING APPROPRIATE INFORMATION VERIFYING THAT BIDDER HAS PAID THE REQUIRED BUSINESS TAXES, PROVIDED THAT SUCH INFORMATION DOES NOT CONTAIN THE AMOUNTS OF TAXES PAID NOR ANY OTHER INFORMATION DEEMED BY THE TAX COMMISSIONER TO BE CONFIDENTIAL.</p> <p>UNDER PENALTY OF LAW FOR FALSE SWEARING (WEST VIRGINIA CODE 61-5-3), BIDDER HEREBY CERTIFIES THAT THIS CERTIFICATE IS TRUE AND ACCURATE IN ALL RESPECTS; AND THAT IF A CONTRACT IS ISSUED TO BIDDER AND IF ANYTHING CONTAINED WITHIN THIS CERTIFICATE CHANGES DURING THE TERM OF THE CONTRACT, BIDDER WILL NOTIFY THE</p>						

SEE REVERSE SIDE FOR TERMS AND CONDITIONS

SIGNATURE *Gregory C. Legg* TELEPHONE **304-746-8820** DATE **8/28/08**

TITLE **BRANCH MANAGER** FEIN **562228173** ADDRESS CHANGES TO BE NOTED ABOVE

WHEN RESPONDING TO RFQ, INSERT NAME AND ADDRESS IN SPACE ABOVE LABELED 'VENDOR'



State of West Virginia
 Department of Administration
 Purchasing Division
 2019 Washington Street East
 Post Office Box 50130
 Charleston, WV 25305-0130

Request for Quotation

RFQ NUMBER
DJS010253

PAGE
6

ADDRESS: CORRESPONDENCE TO ATTENTION OF
**JOHN ABBOTT
 304-558-2544**

VENDOR

RFQ COPY
 TYPE NAME/ADDRESS HERE
**The Systems Depot
 610 E Street
 So. Chas. WV 25303**

SHIP TO

**DIVISION OF JUVENILE SERVICES
 SECOND FLOOR
 1200 QUARRIER STREET
 CHARLESTON, WV
 25301 304-558-6029**

DATE PRINTED 08/13/2008	TERMS OF SALE	SHIP VIA	F.O.B.	FREIGHT TERMS
-----------------------------------	---------------	----------	--------	---------------

BID OPENING DATE: **08/28/2008** BID OPENING TIME **01:30PM**

LINE	QUANTITY	UQP	CAT NO	ITEM NUMBER	UNIT PRICE	AMOUNT
PURCHASING DIVISION IN WRITING IMMEDIATELY.						
BIDDER: The Systems Depot DATE: 8/28/08 SIGNED: <i>Gregory C. Leagy</i> TITLE: BRANCH MANAGER						
* CHECK ANY COMBINATION OF PREFERENCE CONSIDERATION(S) IN EITHER "A" OR "B", OR BOTH "A" AND "B" WHICH YOU ARE ENTITLED TO RECEIVE. YOU MAY REQUEST UP TO THE MAXIMUM 5% PREFERENCE FOR BOTH "A" AND "B". (REV. 12/00)						
NOTICE A SIGNED BID MUST BE SUBMITTED TO: DEPARTMENT OF ADMINISTRATION PURCHASING DIVISION BUILDING 15 2019 WASHINGTON STREET, EAST CHARLESTON, WV 25305-0130						
THE BID SHOULD CONTAIN THIS INFORMATION ON THE FACE OF THE ENVELOPE OR THE BID MAY NOT BE CONSIDERED:						

SEE REVERSE SIDE FOR TERMS AND CONDITIONS

SIGNATURE <i>Gregory C. Leagy</i>	TELEPHONE 304-746-8820	DATE 8/28/08
TITLE BRANCH MANAGER	FAX 562228173	ADDRESS CHANGES TO BE NOTED ABOVE

WHEN RESPONDING TO RFQ, INSERT NAME AND ADDRESS IN SPACE ABOVE LABELED 'VENDOR'



State of West Virginia
 Department of Administration
 Purchasing Division
 2019 Washington Street East
 Post Office Box 50130
 Charleston, WV 25305-0130

**Request for
 Quotation**

RFQ NUMBER
DJS010253

PAGE
7

ADDRESS CORRESPONDENCE TO ATTENTION OF
JOHN ABBOTT 304-558-2544

RFQ COPY

TYPE NAME/ADDRESS HERE

*The Systems Depot
 610 E Street
 So. Chas. W.V. 25303*

DIVISION OF JUVENILE SERVICES

SECOND FLOOR
 1200 QUARRIER STREET
 CHARLESTON, WV
 25301 304-558-6029

DATE PRINTED	TERMS OF SALE	SHIP VIA	F.O.B.	FREIGHT TERMS
08/13/2008				

BID OPENING DATE: 08/28/2008 BID OPENING TIME 01:30PM

LINE	QUANTITY	UOP	CAT NO.	ITEM NUMBER	UNIT PRICE	AMOUNT
	SEALED BID					
	BUYER:			JOHN ABBOTT		
	RFQ. NO.:			DJS010253		
	BID OPENING DATE:			08/28/2008		
	BID OPENING TIME:			1:30 PM		
	PLEASE PROVIDE A FAX NUMBER IN CASE IT IS NECESSARY TO CONTACT YOU REGARDING YOUR BID:					
				<u>304-746-8823</u>		
	CONTACT PERSON (PLEASE PRINT CLEARLY):					
				<u>Greg Legg</u>		
***** THIS IS THE END OF RFQ DJS010253 *****						TOTAL: \$45,435.00

SEE REVERSE SIDE FOR TERMS AND CONDITIONS		
SIGNATURE <u>Gregory C. Legg</u>	TELEPHONE <u>304-746-8820</u>	DATE <u>8/28/08</u>
TITLE <u>BRANCH MANAGER</u>	FAX <u>562228173</u>	ADDRESS CHANGES TO BE NOTED ABOVE

WHEN RESPONDING TO RFQ, INSERT NAME AND ADDRESS IN SPACE ABOVE LABELED 'VENDOR'

**BID SUBMISSION WORKSHEET FOR
DJS 010253
ALL QUANTITIES ARE ESTIMATES ONLY**

ITEM
NO.

EQUAL

	ESTIMATED QUANTITY	ITEM	MODEL	UNIT PRICE	AMOUNT
1.	90	COLOR VARI-FOCAL MINI DOME CAMERA	Hunt HTC105E	96.00	8640.00
2.	20	COLOR VARI-FOCAL DAY/NIGHT INFRARED MINI DOME CAMERA	Hunt HTC15G28D1D	174.00	3480.00
3.	10	16 CAMERA 12VCD POWER SUPPLY	Altronix ALTV615DC1016	143.00	1430.00
4.	5	8 CAMERA 12VCD POWER SUPPLY	Altronix ALTV615DC8UL	103.00	515.00
5.	5	4 CAMERA 12VCD POWER SUPPLY	Altronix ALTV615DC4UL	56.00	280.00
6.	5	4 CHANNEL NETWORKABLE TRIPLEX DVR WITH CD-R/W	Hunt HVRM5400E520	887.00	4435.00
7.	5	8 CHANNEL NETWORKABLE TRIPLEX DVR WITH CD-R/W	HUNT HVRMD800E520	1195.00	5975.00
8.	10	16 CHANNEL NETWORKABLE TRIPLEX DVR WITH CD-R/W	HUNT HVRMD1600Q520	1680.00	16800.00
9.	20	COLOR VARI-FOCAL INFRARED BULLET CAMERA	Hunt HTC5AH2810C	194.00	3880.00

TOTAL \$ 45,435.00

EQUAL

STATE OF WEST VIRGINIA
Purchasing Division

PURCHASING AFFIDAVIT

VENDOR OWING A DEBT TO THE STATE:

West Virginia Code §5A-3-10a provides that: No contract or renewal of any contract may be awarded by the state or any of its political subdivisions to any vendor or prospective vendor when the vendor or prospective vendor or a related party to the vendor or prospective vendor is a debtor and the debt owed is an amount greater than one thousand dollars in the aggregate.

PUBLIC IMPROVEMENT CONTRACTS & DRUG-FREE WORKPLACE ACT:

West Virginia Code §21-1D-5 provides that: Any solicitation for a public improvement construction contract shall require each vendor that submits a bid for the work to submit at the same time an affidavit that the vendor has a written plan for a drug-free workplace policy in compliance with Article 1D, Chapter 21 of the West Virginia Code. A public improvement construction contract may not be awarded to a vendor who does not have a written plan for a drug-free workplace policy in compliance with Article 1D, Chapter 21 of the West Virginia Code and who has not submitted that plan to the appropriate contracting authority in timely fashion. For a vendor who is a subcontractor, compliance with Section 5, Article 1D, Chapter 21 of the West Virginia Code may take place before their work on the public improvement is begun.

ANTITRUST:

In submitting a bid to any agency for the state of West Virginia, the bidder offers and agrees that if the bid is accepted the bidder will convey, sell, assign or transfer to the state of West Virginia all rights, title and interest in and to all causes of action it may now or hereafter acquire under the antitrust laws of the United States and the state of West Virginia for price fixing and/or unreasonable restraints of trade relating to the particular commodities or services purchased or acquired by the state of West Virginia. Such assignment shall be made and become effective at the time the purchasing agency tenders the initial payment to the bidder.

I certify that this bid is made without prior understanding, agreement, or connection with any corporation, firm, limited liability company, partnership or person or entity submitting a bid for the same materials, supplies, equipment or services and is in all respects fair and without collusion or fraud. I further certify that I am authorized to sign the certification on behalf of the bidder or this bid.

LICENSING:

Vendors must be licensed and in good standing in accordance with any and all state and local laws and requirements by any state or local agency of West Virginia, including, but not limited to, the West Virginia Secretary of State's Office, the West Virginia Tax Department, West Virginia Insurance Commission, or any other state agencies or political subdivision. Furthermore, the vendor must provide all necessary releases to obtain information to enable the Director or spending unit to verify that the vendor is licensed and in good standing with the above entities.

CONFIDENTIALITY:

The vendor agrees that he or she will not disclose to anyone, directly or indirectly, any such personally identifiable information or other confidential information gained from the agency, unless the individual who is the subject of the information consents to the disclosure in writing or the disclosure is made pursuant to the agency's policies, procedures and rules. Vendors should visit www.state.wv.us/admin/purchase/privacy for the Notice of Agency Confidentiality Policies.

Under penalty of law for false swearing (*West Virginia Code* §61-5-3), it is hereby certified that the vendor acknowledges the information in this said affidavit and is in compliance with the requirements as stated.

Vendor's Name: The Systems Depot

Authorized Signature: Gregory C. Legg Date: 8/28/08

INTELLIGENT
DESIGN
Patent No. 117542

15 SERIES

DIGITAL DOME CAMERA

- ◆ Full digital process of BLC
- ◆ Auto Tracing White Balance
- ◆ 2H Mode of H.V. aperture correction
- ◆ Digital process of color matrix
- ◆ Electronic Shutter up to 1/100,000
- ◆ 24VAC Optional

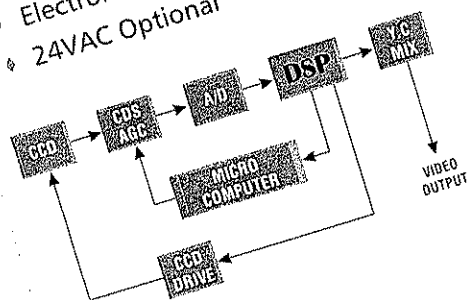
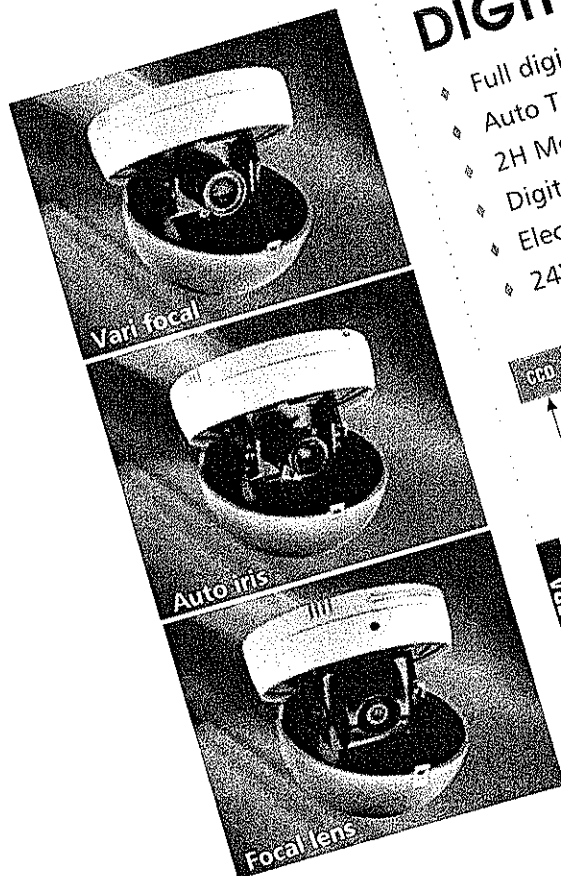

BUILDING A NEW SECURE ERA



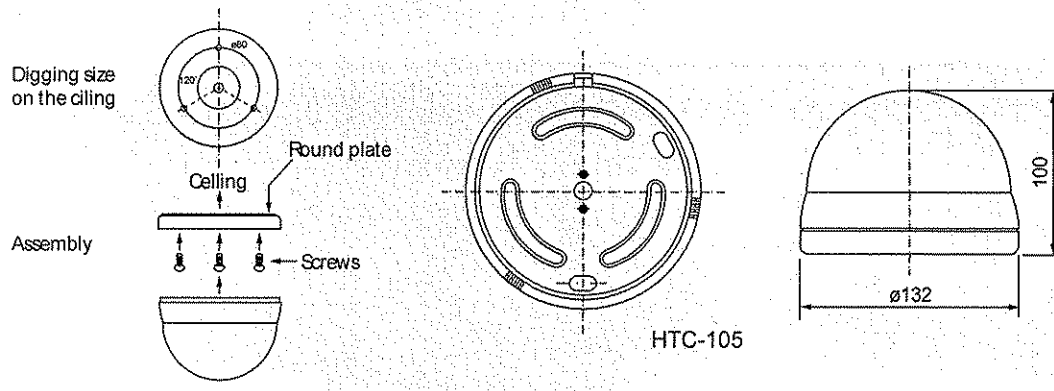

SPECIFICATIONS

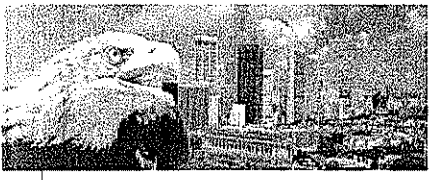

One More Eye to Ensure Your Security

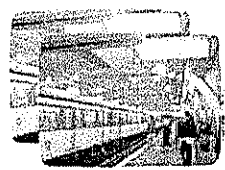
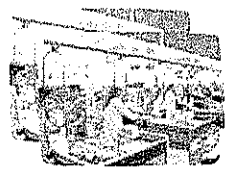

ITEMS	COLOR
PICK UP DEVICE	1/3" CCD image sensor
IMAGE SIZE HXVmm	3.64 x 482
PICTURE ELEMENTS	NTSC (EIA) 510 x 492, PAL (CCIR) 512 x 582 Medium Resolution
PICTURE ELEMENTS	NTSC (EIA) 771 x 494, PAL (CCIR) 753 x 582 High Resolution
H . SYNC FREQUENCY	NTSC / EIA 15.734 K Hz, PAL / CCIR 15.625 K Hz
SYNCHRONIZATION	Internal / DC type, Line-lock / AC type
V. FREQUENCY	NTSC / EIA 60 Hz, PAL / CCIR 50 Hz
H. RESOLUTION TV-LINE	400 / 540 Hi-Res
B. LIGHT COMPENSATION	ON/OFF Switch
AUTO GAIN CONTROL	ON/OFF Switch
ELECTRONIC SHUTTER	ON/OFF Switch Range : 1/50 (1/60) ~ 1/100.000 sec
AUTO IRIS MODE	DC/VIDEO drive Switch
APERTURE CORRECTION	2H mode enhancement
WHITE BALANCE	Auto trance white balance
POWER CONSUMPTION	220mA / 240mA Hi-Res at 12 DC V
POWER CONSUMPTION	4W / 4.5W Hi-Res at AC power
GAMMA CORRECTION	0.45
S/N RATIO	More than 48 dB
LINE-LOCK	With 270 degree V phase adjustment
VIDEO OUTPUT	1 Vp-p, 75 Ohms composite
POWER SUPPLY	12 VDC , 24/ 110/220/240 VAC ±10% optional
DIMENSIONS	5" ∅
WEIGHT g	DC 320 AC 380
STORAGE TEMPERATURE	-30°C TO +60°C
OPERATING TEMPERATURE	-10°C TO +45°C

Specifications are Subject to Change without Notice.

Model Number	Color	Monochrome	Hi-Res.	Medium Res.	DC	AC	Focal Lens	Auto Iris DC Dr.	Manual Lens	Line lock	Sensitivity
HTC-105E	Y		Y		Y		Y				0.05
HTC-105A	Y			Y	Y		Y				1



HUNT ELECTRONIC USA, INC.

<http://www.huntcctv.com>

Hunt Electronic is registered trademark of Hunt Electronic USA Incorporated, 2002 All rights reserved.

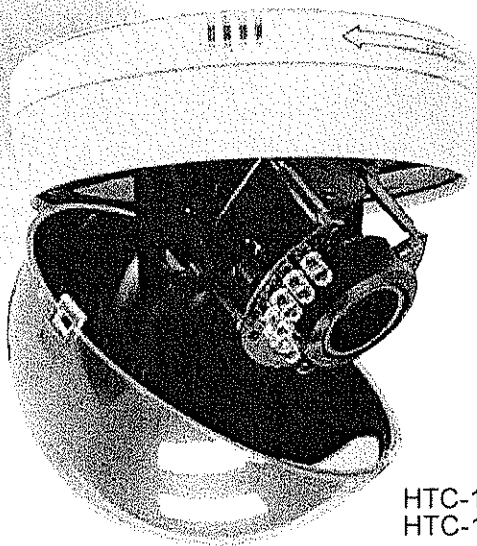

HTC-15G28DID
HTC-15C28DID

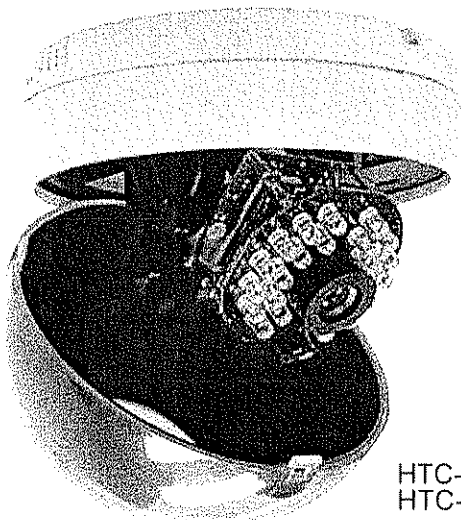

HTC-15G36
HTC-15C36

DAY/NIGHT IR DOME CAMERA

- ◆ Day/ Night feature with built in IR illuminator
- ◆ Built in 2.8~10mm auto iris push filter D/N lens DC Dr.
- ◆ Sensitive to 850~940nm of IR ray
- ◆ Auto Trace White Balance
- ◆ 2H mode of H.V. aperture correction
- ◆ Digital process of color matrix
- ◆ Electronic Shutter up to 1/100,000
- ◆ 24VAC with line lock

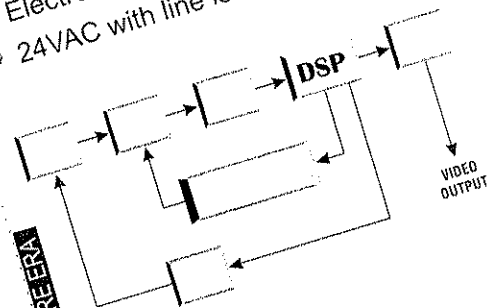

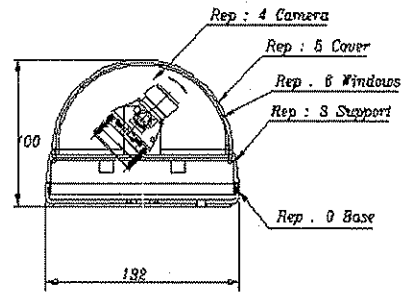
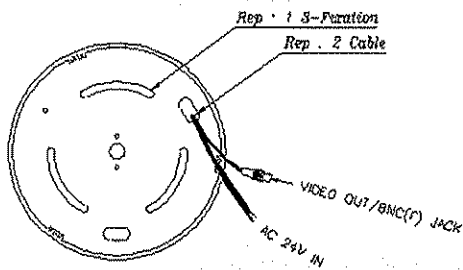

SPECIFICATIONS

ITEM NO	HTC-15G28DID	HTC-15C28DID	HTC-15G36	HTC-15C36
PICK UP DEVICE	CCD Image Sensor 1/3"			
IMAGE SIZE SIZE H x V mm	3.64 x 4.82			
PICTURE ELEMENTS	NTSC 771H x 494V PAL 753 x 582 High Resolution			
PICTURE ELEMENTS	NTSC 512H x 494V PAL 512 x 582 Medium Resolution			
ENVIRONMENT	Interior use			
HORIZONTAL RESOLUTION	540 TV Lines	400 TV Lines	540 TV Lines	400 TV Lines
CAMERA RESOLUTION	High Res.	Medium Res.	High Res.	Medium Res.
H. SYNC. FREQUENCY	NTSC 15.734 KHz /60 Hz, PAL 15.625 KHz / 50 Hz			
CLOCK FREQUENCY	NTSC 28.636 MHz, PAL 28.5 MHz			
SENSITIVITY D/N	0 Lux when IR on			
DAY/ NIGHT	Normal image, Day/Night CDS auto switch			
IR CUT FILTER	Built in		N/A	
IR ILLUMINATOR	Built in 12 IR illuminator		Built in 24 IR illuminator	
IR RAY	Sensitive IR wave 850-940nm			
AUTO IRIS LENS	2.8-10mm auto iris IR cut filter D/N lens DC drive		3.6mm	
SYNCHRONIZATION	Line Lock AC type			
SCANNING SYSTEM	2:1 Interlace			
AUTO GAIN CONTROL	Automatic			
S/N RATIO	More Than 48dB			
ELECTRONIC SHUTTER	On/ Off Switch (1/10,000 sec.)			
GAMMA	0.45			
VIDEO OUT	1 Vp-p, 75 Ohms Composite			
APERTURE CORRECTION	2H mode enhancement			
POWER SUPPLY	24V AC			
POWER COMSUMPTION	6W	5W	6W	5W
WHITE BALANCE	Auto tracing white balance			
BACK LIGHT COMPENSATION	On/Off Switch		Internal	
DIMENSION (mm)	Ø137 * H97mm			
WEIGHT g	850g	850g	830g	830g
STORAGE TEMPERATURE	-30° C~+60° C			
OPERATING TEMPERATURE	-10° C~+45° C			

Specifications are Subject to Change without notice.

Model Number	D/ N	IR	Cut Filter	Color	Hi-Res.	Med-Res.	AC w/ L.L.	Auto iris DC.Dr.	Sensitivity	IR Sensitivity	Environment
HTC-15G28DID	Y	12	Y	Y	Y		Y	Y	0 Lux	850~940nm	Interior
HTC-15C28DID	Y	12	Y	Y		Y	Y	Y	0 Lux	850~940nm	Interior
HTC-15G36	Y	24	N/A	Y	Y		Y		0 Lux	850~940nm	Interior
HTC-15C36	Y	24	N/A	Y		Y	Y		0 Lux	850~940nm	Interior



HUNT ELECTRONIC USA, INC.

<http://www.huntcctv.com>

Hunt Electronic is registered trademark of Hunt Electronic USA Incorporated, 2002 All rights reserved.

Products >>

Bullet Cameras - High Resolution

Browse Categories

- > Digital Video Recorder & Network Cameras
- > Speed Dome Cameras
- > Box Type CCD Cameras
- > Wide Dynamic Range Cameras
- > Day-Night Cameras
- > IP Cameras
- > Dome Cameras
- > **Bullet, Rearview Cameras**
- > Hidden Type Cameras
- > Board Cameras
- > Security Monitor & Monitor Mount
- > Video Transceiver, Transmission, Distributor & Power Converter
- > CCTV Camera Lens
- > Video Processor
- > Camera Housing & Mounts
- > CCTV Power Supply
- > CCTV Accessories

HTC-5AH2810

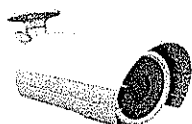

Description

1/3" Color High Resolution Bullet Cameras, pick up Device: 1/3" CCD image sensor for **High Resolution: 540TVL**, auto White Balance, BLC, AES, 1/50~1/100,000 sec., AGC 2H mode enhancement of H.V. aperture correction
 Lens: Auto iris **vari-focal 2.8~10mm** Direct Drive, **external adjustment**
 Power Supply: AC 24V/DC12V, dual voltage

User's Manual User's Manual
 PDF N/A

Key Features

1. Full digital process of BLC
2. Auto White Balance
3. 2H mode of H.V. aperture correction
4. Digital process of color matrix

Specifications

	Color	Monochrome
Item Number	HTC-5AH2810	HTC-5AH36
Pick Up Device	1/3" CCD Sensor	
Image Size H * V mm	3.61*2.72	
Picture Elements	NTSC:771H*494V	
Horizontal Resolution	540 TV Lines	
Horizontal Frequency	NTSC:15.734 KHz	
Vertical Frequency	NTSC:60Hz	
Scanning System	2:1 Interlace	
Sensitivity	0.08 Lux F=1.4	
Sync. System	Internal	
S/N Ratio	More Than 46dB (AGC Off)	
Electronic Shutter	Up To 1/100,000 sec. (Linear)	
White Balance	Auto White Balance	
Gamma Correction	0.45	
Back Light Compensation	Automatic	
Video Output	1 Vpp,75 Ohms Composite	
Mount Lens	2.8~10mm	3.6mm
Auto Gain Control	Automatic	
Power Supply	AC 24V/DC 12V	DC 12V
Power Consumption	220mA for 12V DC	115mA
Weight	1.45 lbs	0.55 lbs
Storage Temperature	-30°C~+60°C	
Operating Temperature	-10°C~+45°C	

Specifications are subject to change without notice.

HVRM Series High Performance Digital Video Recorder - Mpeg 4

32/ 16 Channel Digital Video Recorder

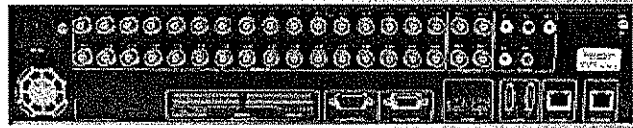

HVRM Series supports 32/ 16 analog video channels. Video, Audio, and Text Event-Logs are digitized and stored on 4 SATA hard-drives. Using advanced Mpeg 4 Compression average file size is 3-6KB while still maintaining enough clarity for facial-recognition. Due to our Mpeg 4 video compression HVRM series processes video into crisp, clear, 720x480 resolution up to 30 images per second (full D1).

Order Information	HVRM-H3200M HVRM-H1600L HVRM-H1600M HVRM-D1600Q
Certificate	FCC, CE, MIC, RoHS
Dimension	445(W) x 388(D) x 88(H)
Shipping Weight	10.4 Kgs
Unit per ctn	1 pcs

Key Features

- 32/ 16 channel Stand-alone DVR with MPEG4 and JPEG dual codec
- 32 Channel Max. 960/800ips recording with 2CIF (Half D1) resolution (30/25ips per channel)
- 16 Channel Max. 480ips recording with (Full D1) resolution (30ips per channel)
- Adjustable resolution (CIF, 2CIF, 4CIF/D1) and frame rate per channel
- Support JPEG encoding for multi channel network monitoring
- 2 internal and 2 Hot-swappable SATA HDDs (Max. 4 HDDs can be installed)
- Support external storage with Max. 8TB via eSATA or IEEE1394B
- Storage extension via IEEE1394B (800Mbps) for RAID support
- Up to 4ch audio inputs for recording and 1ch output for two-way audio
- Built-in 4 BNC Monitor outputs (each monitor support 1/4/9/16ch and sequential mode)
- Built-in multiplexer for 16ch live monitoring and playback (1/4/9/16ch mode)
- Built-in DVD Writer, USB and eSATA port for data backup
- Support large scaled storage
- PTZ control (support preset) via RS485 / 232
- Support static and dynamic IP for xDSL, Cable-modem user
- Support IR remote controller and external keyboard/joystick via RS485 / 232
- Provide remote monitoring software (Control Center Lite-D Software)
- Built-in Web Server for Web Browser viewing and playback
- Support NTP (Network Time Protocol) for time synchronization

Control Center Standard Software (Optional Software)

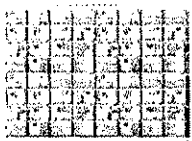

Control center

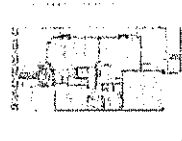

Mapping feature

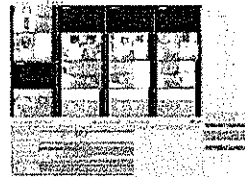

Playback



Configuration tool

- Dual Monitor support
- Support Max 128ch simultaneous monitoring (when using dual monitor)
- Various screen division (1/4/9/16/25/36/49/64)
- Alarm Popup and Sequential switch monitor
- Support DirectX Display (Full screen Display is possible)
- Managing and controlling site on Tree GUI
- View Set mode (Group and Map mode for management of each channel)
- Recording (.re3)
- Smart search
- Instant Recording (.re3)
- Image Export (Saving the recorded image in bitmap or jpg)
- Audio in/out
- On Screen PTZ
- Event history Log & Status Panel
- Event Log Search Utility (Searching for relevant image)
- Surveillance Mode
- Map Mode
- Text search

SPECIFICATIONS

ITEM	HVRM-H3200M	HVRM-H1600L	HVRM-H1600M	HVRM-D1600Q
Operating System	Embedded Linux			
Video Input (BNC, 1Vp-p)	32	16	16	16
Video Output	4 BNC (Main, Spot), 1 VGA	4 BNC (Main, Spot), 1 VGA	2 BNC (Main, Spot), 1 VGA	1 Main BNC, 1 Spot BNC, 1 VGA
Loop Out (BNC, 1Vp-p)	N/A	16 with Auto-termination		
Live Displays	1, 4, 9, 16			
Playback Displays	1, 4, 9, 16			
Video Compression	MPEG4, JPEG			
File Size	2-3KB @ (CIF), 13K @ (Full D1)			
Live Display Speed	960/ 800ips (NTSC/PAL)	480/400ips (NTSC/PAL)		
Record Resolution	D1, HALF D1, CIF			
Record Speed	960/960@720x240 (Half D1)	480/480 @ 720x480 (Full D1)	480/240 @ 720x480 (Full D1)	480/120 @ 720x480 (Full D1)
			480/480 @ 720x240 (Half D1)	480/240 @ 720x240 (Half D1)
				480/480 @ 360 x240 (CIF)
Alarm In/Out(Relay)	16 / 4			
Emergency Record Mode	Yes			
System Control	Key buttons, Remote Client, IR Remote			
System Control SW	Control Center, Web Browser			
PTZ control	RS485/ RS232			RS485
Video Format	NTSC/PAL			
Audio	4ch Input, 1ch Output			
Display	Brightness, Contrast and Covert Feature			
Camera Title	22 Characters per Channel			
Recording Mode	Schedule, Event (Pre/Post)			Schedule, Event (Pre/Post), Manual(Emergency)
Recording Quality	5 Levels of Compression Rate / Record Frame Rate Adjustment			
Pre/Post Recording	Pre: 5 sec / Post: 60 sec			
Motion Detection	22x15 NTSC/ 22x18 PAL			
Search Mode	Date/Time, Event alarm, Text, Smart search (motion)			
Playback Modes	Forward, Reverse, Pause, 1x, 2x, 4x, 8x, 16x, 32x, 64x			
Multiplex Function	Simultaneous Live Display, Playback, Record, Remote Monitoring/Playback			
Alarm Notification	Automatic E-mail, Internal Buzzer, Relay-Out, Pop-Up Screen, Network Event			
Support IPFR	Intelligent Power failure recovery			
Watermark	Yes			
Password Protection	2 Level Password (Admin/User)			
Interface	2 RS-232C, 2 RS-422/485, 1 Ethernet, 1 USB			1 RS-232C, 2 RS-485, 1 Ethernet, 1 USB
Storage	2 Hot Swappable SATA HDD Plus 2 SATA HDD			4 SATA HDD
IEEE 1394 port for storage	Yes			
Maximum Storage	8TB			
Storage Extension	IEEE1394, eSATA			
Back up	USB, DVDRW, Network, eSATA, 1394B			USB, DVDRW, Network, eSATA, 1394A
Network	LAN, WAN(xDSL), DHCP, ARP, ICMP, PPPoE, WESP, UDP, TCP/IP, SMTP, FTP			
Remote Client	Control Center Lite-D, Control Center Pro (optional)			
Power	Input: 100-230VAC, 50/60 Hz.			
Power Consumption	Max 85W, Average 60W	Max 85W, Average 60W	Max 85W, Average 60W	Max 85W, Average 60W
Operation Temperature	0 °C ~ +40°C			
Storage Temperature	-20 °C~ +60°C			
Operation Humidity	93% RH Below			
Storage Humidity	95% RH Below			
Dimension / Weight	445(W) x 420(D) x 88(H) / 8.8 Kg			



HUNT ELECTRONIC USA, INC.

Hunt Electronic is registered trademark of Hunt Electronic USA Incorporated, 2002 All rights reserved.

<http://www.huntcctv.com>

HVRM Series High Performance Digital Video Recorder - Mpeg 4

8/ 4 Channel Digital Video Recorder

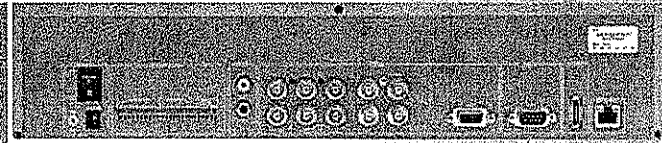
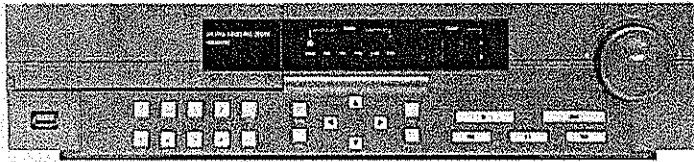

HVRM Series supports 8/ 4 analog video channels. Video, Audio, and Text Event-Logs are digitized and stored on 2 internal hard-drives. Using advanced Mpeg 4 Compression average file size is 2-3KB while still maintaining enough clarity for facial-recognition . Due to our Mpeg 4 video compression HVRM series processes video into crisp, clear, 720x240 resolution up to 30 images per second (Half D1).

Order Information	HVRM-D800E HVRM-S400E
Certificate	FCC, CE, MIC, RoHS
Dimension	445(W) x 388(D) x 88(H)
Shipping Weight	22.88 lbs
Unit per ctn	1 pcs

Key Features

- 8/ 4 channel Stand-alone DVR with MPEG4 and JPEG dual codec
- 8 channel max. 240ips recording with 30ips per channel
- 4 channel max. 120ips recording with 30ips per channel
- Adjustable resolution (CIF, 2CIF, 4CIF/D1) and frame rate per channel
- Support JPEG encoding for multi channel network monitoring
- 2 internal HDDs
- Support external storage via eSATA or 1394B up to 8TB on 8 channel
- Built-in multiplexer for live monitoring and playback
- Built-in DVD Writer, USB and eSATA port for data backup
- PTZ control (support preset) via RS485
- Support static and dynamic IP for xDSL, Cable-modem user
- Support IR remote controller and external keyboard/joystick via RS485 / 232
- Provide remote monitoring software (Control Center Software)
- Built-in Web Server for Web Browser viewing and playback*
- Support NTP (Network Time Protocol) for time synchronization
- Support USB utility (Firmware & configuration value uploading)
- Date/Time, Log, Text, Smart search available from Control Center Software
- Support IPFR (Intelligent Power Failure Recovery)

Control Center Standard Software (Optional Software)

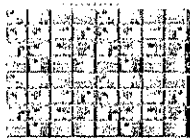

Control center



Mapping feature

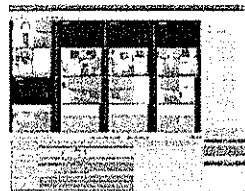

Playback

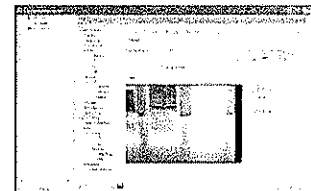

Configuration tool

- Dual Monitor support
- Support Max 128ch simultaneous monitoring (when using dual monitor)
- Various screen division (1/4/9/16/25/36/49/64)
- Alarm Popup and Sequential switch monitor
- Support DirectX Display (Full screen Display is possible)
- Managing and controlling site on Tree UI
- View Set mode (Group and Map mode for management of each channel)
- Recording (.re3)
- Smart search
- Instant Recording (.re3)
- Image Export (Saving the recorded image in bitmap or jpg)
- Audio in/out
- On Screen PTZ
- Event history Log & Status Panel
- Event Log Search Utility (Searching for relevant image)
- Surveillance Mode
- Map Mode
- Text search

SPECIFICATIONS

ITEM	HVRM-D800E	HVRM-S400E
Operating System	Embedded Linux	Embedded Linux
Video Input (BNC, 1Vp-p)	8	4
Video Output	2BNC, 1 VGA	1BNC, 1 VGA
Loop Out (BNC, 1Vp-p)	N/A	4 with Auto-termination
Live Displays	1, 4, 9	1, 4
Playback Displays	1, 4, 9	1, 4
Video Compression	MPEG4, JPEG	
File Size	2-3KB @ (CIF), 13K @ (full D1)	2-3KB @ (CIF), 13K @ (full D1)
Live Display Speed	240/240ips (NTSC/PAL)	120/100ips (NTSC/PAL)
Record Resolution	D1, HALF D1, CIF	
Record Speed	240/240 @ 720x240 (Half D1), 240/120 @720x480 (Full D1)	120/120 @ 360x240 (CIF), 120/60 @ 720x240 (Half D1), 120/30 @720x480 (Full D1)
Alarm In/Out(Relay)	8 alarm inputs, 4 relay outs	4 alarms inputs, 4 relays outs.
Emergency Record Mode	Yes	N/A
System Control	Key buttons, Remote Client, IR Remote	Key buttons, Remote Client, IR Remote, Keyboard Controller
System Control SW	Control Center, Web Browser	
PTZ control	RS485	RS232
Video Format	NTSC/PAL	
Audio	1ch Input, 1ch Output	4ch Input, 1ch Output
Display	Brightness, Contrast and Covert Feature	Brightness, Contrast
Camera Title	16 Characters per Channel	
Recording Mode	Schedule, Event (Pre/Post)	Schedule, Event (Pre/Post)
Recording Quality	5 Levels of Compression Rate / Record Frame Rate Adjustment	
Pre/Post Recording	Pre: 5 sec / Post: 60 sec	Pre: 30 sec / Post: 120 sec
Motion Detection	22x15 NTSC/ 22x18 PAL	16x12 NTSC/ 16x12 PAL
Search Mode	Date/Time, Event alarm, Text, Smart search (motion)	
Playback Modes	Forward, Reverse, Pause, 1x, 2x, 4x, 8x, 16x, 32x, 64x	Forward, Reverse, Pause, 1x, 2x, 4x, 8x, 16x, 32x
Multiplex Function	Simultaneous Live Display, Playback, Record, Remote Monitoring/Playback	
Alarm Notification	Automatic E-mail, Internal Buzzer, Relay-Out, Pop-Up Screen, Network Event	Automatic E-mail, Internal Buzzer, Relay-Out, Pop-Up Screen, Network Event
Support IPFR	Intelligent Power failure recovery	
Watermark	Yes	
Password Protection	2 Level Password (Admin/User)	
Interface	1 RS-232C, 2 RS-485, 1 USB, 1 Ethernet	1 RS-232C, 1 Ethernet, 3 USB
Storage	2 SATA HDD	2 IDE HDD
Maximum Storage	8TB	1.5TB
Storage Extension	eSATA	N/A
Back up	USB, DVD/CDRW, Network, eSATA	USB, CDRW, Network
Network	LAN, WAN(xDSL), DHCP, ARP, ICMP, PPPoE, WESP, UDP, TCP/IP, SMTP, FTP	
Remote Client	Control Center Lite-D, Control Center Pro (optional)	
Power	Input: 100-230VAC, 50/60 Hz,	
Power Consumption	Max 60W, Average 35W	
Operation Temperature	0 °C ~ +40°C	
Storage Temperature	-20 °C ~ +60°C	
Operation Humidity	93% RH Below	
Storage Humidity	95% RH Below	
Dimension / Weight	420(W) x 294(D) x 98(H) / 12.1 lbs	

© 2002 HUNT ELECTRONIC USA, INC. ALL RIGHTS RESERVED.



HUNT ELECTRONIC USA, INC.

Hunt Electronic is registered trademark of Hunt Electronic USA Incorporated, 2002 All rights reserved.

<http://www.huntcctv.com>

HVRM Series High Performance Digital Video Recorder - Mpeg 4

8/ 4 Channel Digital Video Recorder

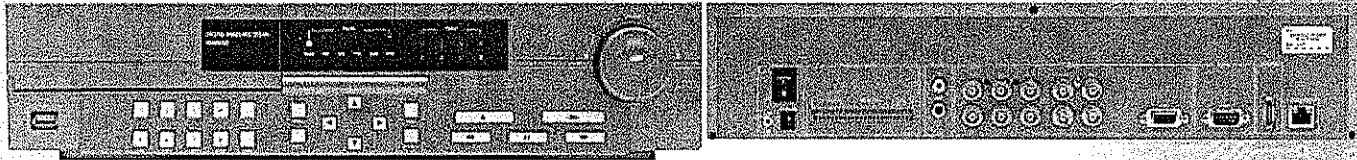

HVRM Series supports 8/ 4 analog video channels. Video, Audio, and Text Event-Logs are digitized and stored on 2 internal hard-drives. Using advanced Mpeg 4 Compression average file size is 2-3KB while still maintaining enough clarity for facial-recognition . Due to our Mpeg 4 video compression HVRM series processes video into crisp, clear, 720x240 resolution up to 30 images per second (Half D1).

Order information	HVRM-D800E HVRM-S400E
Certificate	FCC, CE, MIC, RoHS
Dimension	445(W) x 388(D) x 88(H)
Shipping Weight	22.88 lbs
Unit per ctn	1 pcs

Key Features

- 8/ 4 channel Stand-alone DVR with MPEG4 and JPEG dual codec
- 8 channel max. 240ips recording with 30ips per channel
- 4 channel max. 120ips recording with 30ips per channel
- Adjustable resolution (CIF, 2CIF, 4CIF/D1) and frame rate per channel
- Support JPEG encoding for multi channel network monitoring
- 2 internal HDDs
- Support external storage via eSATA or 1394B up to 8TB on 8 channel
- Built-in multiplexer for live monitoring and playback
- Built-in DVD Writer, USB and eSATA port for data backup
- PTZ control (support preset) via RS485
- Support static and dynamic IP for xDSL, Cable-modem user
- Support IR remote controller and external keyboard/joystick via RS485 / 232
- Provide remote monitoring software (Control Center Software)
- Built-in Web Server for Web Browser viewing and playback*
- Support NTP (Network Time Protocol) for time synchronization
- Support USB utility (Firmware & configuration value uploading)
- Date/Time, Log, Text, Smart search available from Control Center Software
- Support IPFR (Intelligent Power Failure Recovery)

Control Center Standard Software (Optional Software)

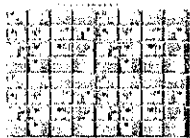

Control center



Mapping feature

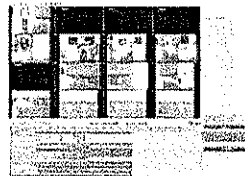

Playback

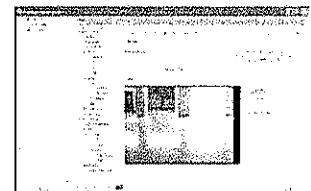

Configuration tool

- Dual Monitor support
- Support Max 128ch simultaneous monitoring (when using dual monitor)
- Various screen division (1/4/9/16/25/36/49/64)
- Alarm Popup and Sequential switch monitor
- Support DirectX Display (Full screen Display is possible)
- Managing and controlling site on Tree UI
- View Set mode (Group and Map mode for management of each channel)
- Recording (.re3)
- Smart search
- Instant Recording (.re3)
- Image Export (Saving the recorded image in bitmap or jpg)
- Audio in/out
- On Screen PTZ
- Event history Log & Status Panel
- Event Log Search Utility (Searching for relevant image)
- Surveillance Mode
- Map Mode
- Text search

SPECIFICATIONS

ITEM	HVRM-D800E	HVRM-S400E
Operating System	Embedded Linux	Embedded Linux
Video Input (BNC, 1Vp-p)	8	4
Video Output	2BNC, 1 VGA	1BNC, 1 VGA
Loop Out (BNC, 1Vp-p)	N/A	4 with Auto-termination
Live Displays	1, 4, 9	1, 4
Playback Displays	1, 4, 9	1, 4
Video Compression	MPEG4, JPEG	
File Size	2~3KB @ (CIF), 13K @ (full D1)	2~3KB @ (CIF), 13K @ (full D1)
Live Display Speed	240/240ips (NTSC/PAL)	120/100ips (NTSC/PAL)
Record Resolution	D1, HALF D1, CIF	
Record Speed	240/240 @ 720x240 (Half D1), 240/120 @720x480 (Full D1)	120/120 @ 360x240 (CIF), 120/60 @ 720x240 (Half D1), 120/30 @720x480 (Full D1)
Alarm In/Out(Relay)	8 alarm inputs, 4 relay outs	4 alarms inputs, 4 relays outs.
Emergency Record Mode	Yes	N/A
System Control	Key buttons, Remote Client, IR Remote	Key buttons, Remote Client, IR Remote, Keyboard Controller
System Control SW	Control Center, Web Browser	
PTZ control	RS485	RS232
Video Format	NTSC/PAL	
Audio	1ch Input, 1ch Output	4ch Input, 1ch Output
Display	Brightness, Contrast and Covert Feature	Brightness, Contrast
Camera Title	16 Characters per Channel	
Recording Mode	Schedule, Event (Pre/Post)	Schedule, Event (Pre/Post)
Recording Quality	5 Levels of Compression Rate / Record Frame Rate Adjustment	
Pre/Post Recording	Pre: 5 sec / Post: 60 sec	Pre: 30 sec / Post: 120 sec
Motion Detection	22x15 NTSC/ 22x18 PAL	16x12 NTSC/ 16x12 PAL
Search Mode	Date/Time, Event alarm, Text, Smart search (motion)	
Playback Modes	Forward, Reverse, Pause, 1x, 2x, 4x, 8x, 16x, 32x, 64x	Forward, Reverse, Pause, 1x, 2x, 4x, 8x, 16x, 32x
Multiplex Function	Simultaneous Live Display, Playback, Record, Remote Monitoring/Playback	
Alarm Notification	Automatic E-mail, Internal Buzzer, Relay-Out, Pop-Up Screen, Network Event	Automatic E-mail, Internal Buzzer, Relay-Out, Pop-Up Screen, Network Event
Support IPFR	Intelligent Power failure recovery	
Watermark	Yes	
Password Protection	2 Level Password (Admin/User)	
Interface	1 RS-232C, 2 RS-485, 1 USB, 1 Ethernet	1 RS-232C, 1 Ethernet, 3 USB
Storage	2 SATA HDD	2 IDE HDD
Maximum Storage	8TB	1.5TB
Storage Extension	eSATA	N/A
Back up	USB, DVD/RW, Network, eSATA	USB, CDRW, Network
Network	LAN, WAN(xDSL), DHCP, ARP, ICMP, PPPoE, WESP, UDP, TCP/IP, SMTP, FTP	
Remote Client	Control Center Lite-D, Control Center Pro (optional)	
Power	Input: 100-230VAC, 50/60 Hz.	
Power Consumption	Max 60W, Average 35W	
Operation Temperature	0 °C ~ +40°C	
Storage Temperature	-20 °C ~ +60°C	
Operation Humidity	93% RH Below	
Storage Humidity	95% RH Below	
Dimension / Weight	420(W) x 294(D) x 98(H) / 12.1 lbs	

For Additional Information, Please Contact Us at 1-800-368-1111



HUNT ELECTRONIC USA, INC.

Hunt Electronic is registered trademark of Hunt Electronic USA Incorporated, 2002 All rights reserved.

<http://www.huntcctv.com>

Altronix®
More than just power.™

Security • Fire • Access • CCTV • Video Call • Automation

ALTV615DC1016

CCTV DC Wall Mount 16 Output Power Supply

Print This Page

Overview

Model ALTV615DC1016 provides 6-15VDC distributed via sixteen (16) fuse protected outputs.

Features/Specifications

- 6-15VDC selectable output.
- 10 amp supply current.
- Sixteen (16) fuse protected outputs.
- Output fuses are rated @ 3.5 amp.
- 115VAC 50/60Hz, 1.9 amp input.
- Filtered and electronically regulated outputs.
- Short circuit and thermal overload protection.
- AC power LED indicator.
- Illuminated Power Disconnect Circuit Breaker with manual reset.
- Unit maintains camera synchronization.
- Lifetime Warranty.

Enclosure

- Dimensions: 15.5"H x 12"W x 4.5"D.
- 1/2" and 3/4" combination knockouts.

Applications

- 6-15VDC power for CCTV cameras, heaters, and other video accessories.

Similar Altronix Products

ALTV615DC1016CB PTC Outputs. 6-15VDC @ 10 amp.

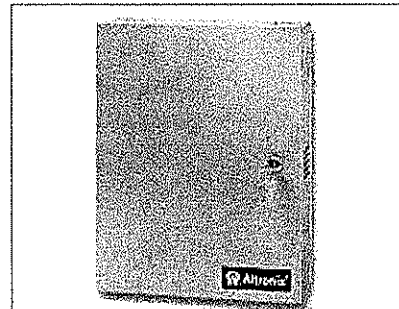

RoHS Compliant

 Installation
Instructions

 CAD
Drawing

Altronix®
More than just power.™

Security - Fire - Access - CCTV - Video Call - Automation

ALTV615DC8UL

UL/CUL Listed CCTV DC Wall Mount 8 Output Power Supply

Print This Page

Overview

Model ALTV615DC8UL provides 6-15VDC distributed via eight (8) fuse protected outputs.

Agency Listings

- UL Listed UL Listed for Commercial CCTV Equipment (UL2044), CUL Listed - CSA Standard C22.2 No.1-98, Audio, Video and Similar Equipment. File# E148639.
- CE Approved.

Features/Specifications

- 6-15VDC selectable output.
- 4 amp supply current.
- Eight (8) fuse protected Class 2 Rated power limited outputs.
- Output fuses are rated @ 3.5 amp.
- 115VAC 50/60Hz, .9 amp input.
- Filtered and electronically regulated outputs.
- Short circuit and thermal overload protection.
- AC power LED indicator.
- Power On/Off switch.
- Unit maintains camera synchronization.
- Lifetime Warranty.

Enclosure

- Dimensions: 13.5"H x 13"W x 3.25"D.
- 1/2" and 3/4" combination knockouts.

Applications

- 6-15VDC power for CCTV cameras, heaters, and other video accessories.

Similar Altronix Products

- ALTV615DC8ULCB PTC Outputs. 6-15VDC @ 4 amp.
- ALTV615DC48ULM Fused Outputs. 6-15VDC @ 4 amp. Smaller Enclosure.
- ALTV615DC48ULCBM PTC Outputs. 6-15VDC @ 4 amp. Smaller Enclosure.

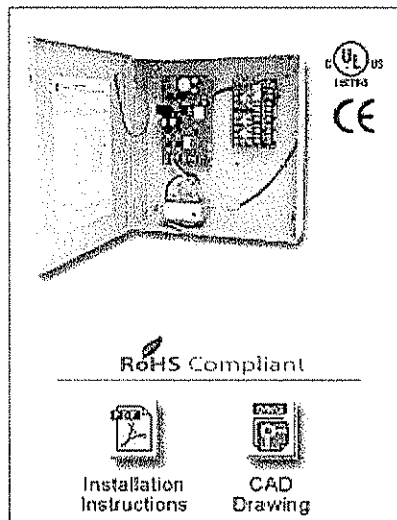

Altronix
More than just power.

Security - Fire - Access - CCTV - Nurse Call - Automation

ALTV615DC4UL

UL/CUL Listed CCTV DC Wall Mount 4 Output Power Supply

Print This Page

Overview

Model ALTV615DC4UL provides 6-15VDC distributed via four (4) fuse protected outputs.

Agency Listings

- UL Listed UL Listed for Commercial CCTV Equipment (UL2044), CUL Listed - CSA Standard C22.2 No.1-98, Audio, Video and Similar Equipment. File# E148639.
- CE Approved.

Features/Specifications

- 6-15VDC selectable output.
- 2.5 amp @ 6-12VDC or 2 amp @ 12-15VDC supply current.
- Four (4) Class 2 fuse protected Rated power limited outputs.
- Output fuses are rated @ 1 amp.
- 24VAC 40VA or 24VAC 50VA input (Altronix Model # TP2440 or TP2450).
- Filtered and electronically regulated outputs.
- Short circuit and thermal overload protection.
- AC power LED indicator.
- Power ON/OFF switch.
- Unit maintains camera synchronization.
- Lifetime Warranty.

Enclosure

- Dimensions: 8.5"H x 7.5"W x 3.5"D.
- 1/2" and 3/4" combination knockouts.

Applications

- 6-15VDC power for CCTV cameras, heaters, and other video accessories.

Similar Altronix Products

- ALTV615DC44ULM Fused Outputs. 6-15VDC @ 4 amp. Smaller Enclosure.
- ALTV615DC44ULCBM PTC Outputs. 6-15VDC @ 4 amp. Smaller Enclosure.

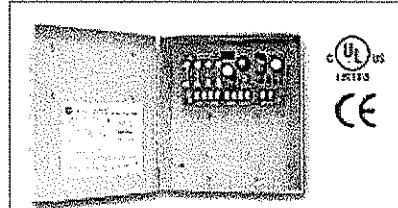

RoHS Compliant

 Installation
Instructions

 CAD
Drawing