

HMB Professional Engineers, Inc.

Statement of Qualifications to the

West Virginia Department of Environmental Protection

Venus (Hamilton) Drainage
DEP 14480

November 20, 2008

RECEIVED

2008 NOV 18 A 10:46

PROCURING DIVISION
STATE OF WV

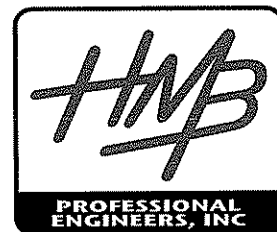



November 20, 2008

Mr. Chuck Bowman, Buyer
Purchasing Division
2019 Washington Street, East
P.O. Box 50130
Charleston, WV 25305-0130

RE: DEP14480 – Venus (Hamilton) Drainage

Dear Mr. Bowman,

HMB Professional Engineers, Inc. (HMB) is pleased to submit our Expression of Interest for the subject project. Our submittal reveals a long history of working with the West Virginia Office of Abandoned Mine Lands. Our experience includes over 40 AML projects that are similar to the subject project. Twenty seven (27) of those similar projects were completed for the West Virginia Office of Abandoned Mine Lands. Our past experience proves that we are capable of providing quality AML designs, and we are eager to continue that tradition.

HMB has long been a multi-disciplined firm, with a staff of over twenty (20) civil, structural, water and wastewater engineers capable of designing quality solutions for a wide variety of projects. HMB's engineering staff is complimented by an impressive staff of environmental engineers, environmental scientists, geologists, biologists and chemists that have the experience and capability to analyze the environmental impacts of this project and obtain the permits needed before construction can begin. Our environmental staff has expertise in stream restoration, wetlands delineation, wetlands creation and mitigation, 401 and 404 permits, biological assessment, and all environmental analysis required to prepare NEPA documents.

HMB has the capacity in our South Charleston, WV office to provide the services for this project. Our office in Frankfort, KY has a multi-disciplined staff that will provide the support to the WV office necessary to make this project a success. We hope that you consider using HMB's professional engineering services for this project.

Sincerely,
HMB PROFESSIONAL ENGINEERS, INC.

Greg Boleyn, PE
West Virginia Office Manager

KENTUCKY ■ WEST VIRGINIA ■ INDIANA ■ ALABAMA ■ TENNESSEE

325 Sixth Ave.
South Charleston, WV
25303
Office: (304) 744-5200
Fax: (304) 744-3955

Abandoned Mine Land

Highway Engineering

Structural Engineering

Water & Wastewater

Site Development

Right-of-Way

Master Planning

Environmental Planning

Surveying

Project Management

Cost Estimation

Stream Restoration

Construction Inspection

Aviation Services

Environmental Remediation

**WEST VIRGINIA DEPARTMENT OF ENVIRONMENTAL PROTECTION
AML CONSULTANT CONFIDENTIAL QUALIFICATION QUESTIONNAIRE Attachment "B"**

PROJECT NAME - DEP14480 Venus (Hamilton) Drainage		DATE (DAY, MONTH, YEAR) 11/20/08	FEIN 61-0968333
1. FIRM NAME - Haworth-Meyer-Boleyn Professional Engineers, Inc. d.b.a. HMB Professional Engineers, Inc.		3. FORMER FIRM NAME N/A	
4. HOME OFFICE TELEPHONE 502-695-9800	5. ESTABLISHED (YEAR) 1979	6. TYPE OWNERSHIP Individual <u>Corporation</u> Partnership Joint-Venture YES <u>NO</u>	
7. PRIMARY AML DESIGN OFFICE: ADDRESS/ TELEPHONE/ PERSON IN CHARGE/ NO. AML DESIGN PERSONNEL EACH OFFICE 325 Sixth Avenue South Charleston, WV / 304-744-5200 / Greg Boleyn, P.E. / 5 Secondary AML design office: 3 HMB Circle Frankfort, KY / 502-695-9800 / Joe Grider, P.E. / 2			
8. NAMES OF PRINCIPAL OFFICERS OR MEMBERS OF FIRM Brad Meyer, President Karen Wood, CFO Bob Blankenship, Principal-in-Charge		8a. NAME, TITLE, & TELEPHONE NUMBER - OTHER PRINCIPALS Greg Boleyn, WV Regional Office Manager 304-774-5200	
9. PERSONNEL BY DISCIPLINE			
5 ADMINISTRATIVE ARCHITECTS	ECOLOGISTS	LANDSCAPE ARCHITECTS	2 STRUCTURAL ENGINEERS
3 BIOLOGIST	ECONOMISTS	MECHANICAL ENGINEERS	2 SURVEYORS
7 CADD OPERATORS	ELECTRICAL ENGINEERS	MINING ENGINEERS	TRAFFIC ENGINEERS
CHEMICAL ENGINEERS	ENVIRONMENTALISTS	PHOTOGRAMMETRISTS	2 OTHER (R/W acquisition)
17 CIVIL ENGINEERS	ESTIMATORS	PLANNERS: URBAN/REGIONAL	
3 CONSTRUCTION INSPECTORS	1 GEOLOGISTS	SANITARY ENGINEERS	
DESIGNERS	HISTORIANS	SOILS ENGINEERS	48 TOTAL PERSONNEL
(3) DRAFTSMEN	(8) HYDROLOGISTS	WRITERS	

TOTAL NUMBER OF WV REGISTERED PROFESSIONAL ENGINEERS IN PRIMARY OFFICE: 3
 *RPEs other than Civil and Mining must provide supporting documentation that qualifies them to supervise and perform this type of work.

Numbers shown in parenthesis indicate staff with multiple areas of experience and responsibilities. Those numbers are not included in the total personnel figure.

All AML design work will be done by our civil engineering staff. HMB's staff includes Sanitary and Structural engineers that will not be working on any AML projects, unless a specific need arises for their expertise.

10. HAS THIS JOINT-VENTURE WORKED TOGETHER BEFORE? YES NO

11. OUTSIDE KEY CONSULTANTS/SUB-CONSULTANTS ANTICIPATED TO BE USED. Attach "AML Consultant Confidential Qualification Questionnaire".

NAME AND ADDRESS:	SPECIALTY:	WORKED WITH BEFORE
Novel Geo-environmental 806 B Street St. Albans, WV 25177	Subsurface investigations and geotechnical engineering See attached CCQQ forms.	<input checked="" type="checkbox"/> Yes No
NAME AND ADDRESS: Photo Science 2670 Wilhite Drive Lexington, KY 40503	SPECIALTY: Photogrammetry and digital mapping services See attached CCQQ forms.	WORKED WITH BEFORE <input checked="" type="checkbox"/> Yes No
NAME AND ADDRESS:	SPECIALTY:	WORKED WITH BEFORE <input type="checkbox"/> Yes <input type="checkbox"/> No
NAME AND ADDRESS:	SPECIALTY:	WORKED WITH BEFORE <input type="checkbox"/> Yes <input type="checkbox"/> No
NAME AND ADDRESS:	SPECIALTY:	WORKED WITH BEFORE <input type="checkbox"/> Yes <input type="checkbox"/> No
NAME AND ADDRESS:	SPECIALTY:	WORKED WITH BEFORE <input type="checkbox"/> Yes <input type="checkbox"/> No

12. A. Is your firm experienced in Abandoned Mine Lands Remediation/Mine Reclamation Engineering?

YES - HMB has completed over 80 AML projects in WV, KY, VA and IN. Several of those projects involved regrading refuse piles, stabilizing stream banks, and designing drainage channels. See Schedule "A" for a list of HMB's past AML projects.

NO

B. Is your firm experienced in Soil Analysis?

YES Description and Number of Projects:

NO - HMB is teaming with Novel Geo-Environmental, who will be providing subsurface investigations, geotechnical testing and geotechnical design. Their CCQQ is attached to this submittal.

C. Is your firm experienced in hydrology and hydraulics?

YES - Most of our past AML projects require hydrologic and hydraulic analysis. The attached Schedule "A" indicates which AML projects required hydrologic and hydraulic analysis.

NO

D. Does your firm produce its own Aerial Photography and Develop Contour Mapping?

YES Description and Number of Projects:

NO - HMB is teaming with Photo Science, who will be providing photogrammetry and digital mapping services. Their CCQQ is attached to this submittal.

E. Is your firm experienced in domestic waterline design? (Include any experience your firm has in the evaluation of aquifer degradation as a result of mining.)

YES - HMB has an extensive list of past projects where the feasibility of extending water lines was analyzed and documented. HMB also has completed numerous water line extension projects in WV, KY, IN & TN. See the Similar Projects Section of this submittal for a list of past water line feasibility projects.

NO

F. Is your firm experienced in Acid Mine Drainage Evaluation and Abatement Design?

YES - HMB has completed several projects where AMD was a problem. See the Similar Projects Section of this submittal for a list of past AML projects that involved AMD.

NO

<p>13. PERSONAL HISTORY STATEMENT OF PRINCIPALS AND ASSOCIATES RESPONSIBLE FOR AML PROJECT DESIGN (Furnish complete data but keep to essentials)</p>			
<p>NAME & TITLE (Last, First, Middle Int.)</p> <p>Grider, Joe PE, PLS - Surveying Manager</p>	<p>YEARS OF AML DESIGN EXPERIENCE:</p> <p>4 years</p>	<p>YEARS OF AML RELATED DESIGN EXPERIENCE:</p> <p>20+ years</p>	<p>YEARS OF DOMESTIC WATERLINE DESIGN EXPERIENCE:</p> <p>12 years</p>
<p>Brief Explanation of Responsibilities</p> <p>Joe is responsible for managing HMB's surveying division, as well as the engineering design and plan preparation for land development projects. The land development projects involve site grading, State and Federal permitting, stream drainage design, storm sewer design, storm water management, erosion control design. These land development projects start with project planning, continue through design, permitting and construction, and conclude when the construction receives final acceptance by the local governing authority.</p>			
<p>EDUCATION (Degree, Year, Specialization)</p> <ul style="list-style-type: none"> B.S.C.E. University of Kentucky, 1982 			
<p>MEMBERSHIP IN PROFESSIONAL ORGANIZATIONS / TRAINING</p> <p>Highway Capacity Workshop Lessons in Professional Liability Contract Review & Revisions Preparation of Survey Reports Fundamentals of GPS Research techniques for boundary surveys</p>			
<p>13. PERSONAL HISTORY STATEMENT OF PRINCIPALS AND ASSOCIATES RESPONSIBLE FOR AML PROJECT DESIGN (Furnish complete data but keep to essentials)</p>			
<p>NAME & TITLE (Last, First, Middle Int.)</p> <p>Boleyn, Greg PE, WV Regional Office Manager</p>	<p>YEARS OF AML DESIGN EXPERIENCE:</p> <p>1 year</p>	<p>YEARS OF AML RELATED DESIGN EXPERIENCE:</p> <p>14 years</p>	<p>YEARS OF DOMESTIC WATERLINE DESIGN EXPERIENCE:</p> <p>2 years</p>
<p>Brief Explanation of Responsibilities</p> <p>Greg is currently Manager of HMB's West Virginia Branch office in South Charleston. The son of one of our firm's founders, he began his full-time career at HMB in 1982. Pursuing his professional education while working part-time, he successfully completed his degree in 1994. His design experience includes highways, waterlines, and airports, as well as drainage and highway capacity analysis and geometric design.</p>			
<p>EDUCATION (Degree, Year, Specialization)</p> <ul style="list-style-type: none"> BS/Civil Engineering/University of Kentucky/1994 			
<p>MEMBERSHIP IN PROFESSIONAL ORGANIZATIONS / TRAINING</p> <ul style="list-style-type: none"> PSMJ Marketing Workshop/2005 PSMJ Strategic Planning Workshop/May 2002 PSMJ Principals Bootcamp/2002 Thinking Beyond the Pavement/1999 INDOT/Bridge Backwater Computer Program Class/1996 CAD & In-Express Productivity 3-Day Workshop/Nashville/1996 			
<p>REGISTRATION (Type, Year, State)</p> <ul style="list-style-type: none"> West Virginia/Civil/P.E. #15216/2002 Kentucky/Civil/P.E. #20693/1999 Ohio/Civil/P.E. #66767/2002 Georgia/Civil/P.E. #027690/2002 			

13. PERSONAL HISTORY STATEMENT OF PRINCIPALS AND ASSOCIATES RESPONSIBLE FOR AML PROJECT DESIGN (Furnish complete data but keep to essentials)

NAME & TITLE (Last, First, Middle Int.)	YEARS OF AML DESIGN EXPERIENCE:	YEARS OF AML RELATED DESIGN EXPERIENCE:	YEARS OF DOMESTIC WATERLINE DESIGN EXPERIENCE:
Blankenship, Bob PE, Principal In Charge			29 years
<p>Brief Explanation of Responsibilities Bob joined HMB in 1989 as Manager of the Water and Wastewater Division. Currently, he is Principal-In-Charge of this division, as well as Vice President in charge of contracting, scheduling and production for HMB's Water and Wastewater, Construction and Environmental Remediation Divisions in Kentucky, Indiana, West Virginia, Tennessee and Alabama. As Vice President, Bob has direct oversight of these divisions to ensure professional and timely delivery of services to our clients. With over 29 years of experience as a Consulting Engineer, he has served as Project Manager on numerous projects from Ohio to Florida. In addition, he served as an Engineer Officer in the U.S. Marine Corps for eight years and then for an additional six years in the Marine Corps Reserves. He is Vice Chairman of the Versailles/Woodford Co. Planning & Zoning Commission, having served on this Commission since 1993. Bob currently serves on the HMB Board of Directors.</p>			
<p>EDUCATION (Degree, Year, Specialization)</p> <ul style="list-style-type: none"> BS/Civil Engineering/University of Kentucky/1970 			
<p>MEMBERSHIP IN PROFESSIONAL ORGANIZATIONS</p> <ul style="list-style-type: none"> National Society of Professional Engineers Kentucky Rural Water Association Kentucky Society of Professional Engineers American Water Works Association American Council of Engineering Companies Society of American Military Engineers 		<p>REGISTRATION (Type, Year, State)</p> <ul style="list-style-type: none"> Kentucky/Civil/P.E. #11972 W Virginia/Surveying/ P.S. #1362 Indiana/Civil/P.E. #60890487 W Virginia/Civil/P.E. 010801 Ohio/Civil/ P.E. #E60154 Tennessee/Civil/P.E. #00021081 N Carolina/Civil/P.E. #016115 	
<p>13. PERSONAL HISTORY STATEMENT OF PRINCIPALS AND ASSOCIATES RESPONSIBLE FOR AML PROJECT DESIGN (Furnish complete data but keep to essentials)</p>			
Stewart, Chris PE, Division Manager			8 years
<p>Brief Explanation of Responsibilities Chris' experience as a consulting engineer includes design of water and wastewater treatment facilities, water distribution systems, water booster stations, sewage collection/transmission systems and force mains. He is also experienced in all aspects of water and wastewater related project management including system analysis and recommendation, preliminary engineering and study, funding procurement, cost estimating, project budgeting, detailed technical design, preparation of project specifications and bidding documents, advertising and bidding, construction administration, construction observation coordination and project close out.</p>			
<p>EDUCATION (Degree, Year, Specialization)</p> <ul style="list-style-type: none"> BS/Civil Engineering/University of Kentucky/1999 			
<p>MEMBERSHIP IN PROFESSIONAL ORGANIZATIONS / TRAINING</p> <ul style="list-style-type: none"> National Society of Professional Engineers PSMJ Project Manager Bootcamp/2002 American Society of Civil Engineers ACEC-KY Retreat/2005 Order of the Engineer Fundamentals of Erosion Protection and Sediment Control/2005 		<p>REGISTRATION (Type, Year, State)</p> <ul style="list-style-type: none"> Kentucky/Civil/P.E. #23423 	

13. PERSONAL HISTORY STATEMENT OF PRINCIPALS AND ASSOCIATES RESPONSIBLE FOR AML PROJECT DESIGN (Furnish complete data but keep to essentials)			
NAME & TITLE (Last, First, Middle Int.) Rice, Steve Biologist, Project Manager	YEARS OF AML DESIGN EXPERIENCE: 0 years	YEARS OF AML RELATED DESIGN EXPERIENCE: 20+ years	YEARS OF DOMESTIC WATERLINE DESIGN EXPERIENCE: 0 years
Brief Explanation of Responsibilities <p>Steve joined HMB in 2003 and serves as a Project Manager and Biologist in our Highway Environmental Division. He is experienced in stream restoration assessment, design, and monitoring field sampling and identification of aquatic and terrestrial animals and plants; wetland delineation and design; environmental impact analyses; and 404 and 401 Water Quality Certification permit applications including design of stream mitigation. During his 28 year career with the Kentucky Transportation Cabinet, Division of Environmental Analysis, Steve wrote over 50 ecological impact analysis documents and numerous biological assessments for federally endangered animals and plants. He conducted biological field surveys throughout Kentucky, identified animals and plants, managed the Aquatic Ecology Section and directed the 401 Water Quality Certification program. In the final four years of his career, he was a member of the 404 Permits Section, where he partnered on the assessment and design of several natural channel design projects.</p>			
EDUCATION (Degree, Year, Specialization) <ul style="list-style-type: none"> • BS/Biology/Eastern Kentucky University/1973 • Graduate Studies in Biology/Eastern Kentucky University/44 hours 			
MEMBERSHIP IN PROFESSIONAL ORGANIZATIONS / TRAINING <ul style="list-style-type: none"> • PSMJ Marketing Workshop/2005 • Natural Channel Design Construction Workshop-Canaan Valley Institute & American Council of Engineering Companies of WV/2003 • Soil Bioengineering Workshop-Big Sandy Resource Conservation & Development Area Inc. & Kentucky Waterways Alliance/2003 • Stream Classification Using Natural Channel Design (N.C. State University--Buck Engineering/2002 			
13. PERSONAL HISTORY STATEMENT OF PRINCIPALS AND ASSOCIATES RESPONSIBLE FOR AML PROJECT DESIGN (Furnish complete data but keep to essentials)			
NAME & TITLE (Last, First, Middle Int.) Heck, Jason Geologist	YEARS OF AML DESIGN EXPERIENCE: 0 years	YEARS OF AML RELATED DESIGN EXPERIENCE: 2 years	YEARS OF DOMESTIC WATERLINE DESIGN EXPERIENCE: 0 years
Brief Explanation of Responsibilities <p>Jason joined HMB in 2006, bringing a fresh point of view to the Environmental Division. He works along with seasoned Biologists and Environmental professionals assisting as a technician. Jason brings an experienced background after working with the Kentucky Geological Survey, Alltech Biotechnology Inc. and his proficiency with ESRI ArcView GIS, Bentley Microstation programs.</p>			
EDUCATION (Degree, Year, Specialization) <ul style="list-style-type: none"> • B.S. Geology, University of Kentucky, 2006 			
MEMBERSHIP IN PROFESSIONAL ORGANIZATIONS / TRAINING <ul style="list-style-type: none"> • Publication and presentation at southeast Geological Society of America of senior research project, The Petrology and Mineral Chemistry of select Lamprophyre Dike intrusions in Western Kentucky. 			

13. PERSONAL HISTORY STATEMENT OF PRINCIPALS AND ASSOCIATES RESPONSIBLE FOR AML PROJECT DESIGN (Furnish complete data but keep to essentials)

NAME & TITLE (Last, First, Middle Int.)	YEARS OF EXPERIENCE	YEARS OF DOMESTIC WATERLINE DESIGN EXPERIENCE: 0 years
Stopper, Bryan Structural Engineer Division Manager	YEARS OF AML DESIGN EXPERIENCE: 5 years	YEARS OF AML RELATED DESIGN EXPERIENCE: 0 years

Brief Explanation of Responsibilities
 Bryan joined HMB in 1982, after working for five years with the Kentucky Department of Transportation, Division of Bridges. He has served as engineering manager for a range of designs including bridges, structural plate arches, toll plazas and storm sewer systems. He has performed in-depth structural inspections and hydraulic analyses encompassing complex roadway designs and has performed studies and evaluations of unusual design problems for the purpose of incorporating new design techniques as office practice. Bryan served as Highway Division Manager for five years prior to his current position as the Structures Division Manager.

EDUCATION (Degree, Year, Specialization)

- BS/Civil Engineering/University of Kentucky/1977

MEMBERSHIP IN PROFESSIONAL ORGANIZATIONS / TRAINING	REGISTRATION (Type, Year, State)
<ul style="list-style-type: none"> National Society of Professional Engineers American Concrete Institute Association of Drilled Shaft Contractors PSMJ Marketing Workshop/2005 LFRD Bridge Design Training - Beyond the Basics/2003 Thinking Beyond the Pavement/1999 KYTC/Constructability Review Process Workshop/1996 KYTC/Consultant Industry Partnering Workshop/1996 University of Wisconsin-Madison/Improving Bridge Inspections & Safety Evaluations Workshop/1987 	<ul style="list-style-type: none"> Kentucky/Civil/P.E. #12531/1981 West Virginia/Civil/P.E. #9898/1986 Ohio/Civil/P.E. #E-53735/1990 Indiana/Civil/P.E. #60910203/1991 Tennessee/Civil/P.E. #108534/2003 Georgia/Civil/P.E. #029403/2004 Alabama/Civil/P.E. #25355/2002

13. PERSONAL HISTORY STATEMENT OF PRINCIPALS AND ASSOCIATES RESPONSIBLE FOR AML PROJECT DESIGN (Furnish complete data but keep to essentials)

NAME & TITLE (Last, First, Middle Int.)	YEARS OF EXPERIENCE	YEARS OF DOMESTIC WATERLINE DESIGN EXPERIENCE: 8 years
Brown, Sandi Technician	YEARS OF AML DESIGN EXPERIENCE: 2 years	YEARS OF AML RELATED DESIGN EXPERIENCE: 3 years

Brief Explanation of Responsibilities
 Sandi brings 8 years of technical experience to HMB's Water/Wastewater Division. She possesses a broad range of knowledge in AutoCAD, Micro Station, and Eagle Point engineering design software programs. In addition to her 8 years of water line design experience, Sandi also has hands on design experience in residential street design, sanitary sewer gravity line design, sanitary pump station and force main design and structural detailing.

EDUCATION (Degree, Year, Specialization)

- Franklin County High School, Diploma 1984

MEMBERSHIP IN PROFESSIONAL ORGANIZATIONS / TRAINING	REGISTRATION (Type, Year, State)

13. PERSONAL HISTORY STATEMENT OF PRINCIPALS AND ASSOCIATES RESPONSIBLE FOR AML PROJECT DESIGN (Furnish complete data but keep to essentials)			
NAME & TITLE (Last, First, Middle Int.)	YEARS OF AML DESIGN EXPERIENCE:	YEARS OF EXPERIENCE	
		YEARS OF AML RELATED DESIGN EXPERIENCE:	YEARS OF DOMESTIC WATERLINE DESIGN EXPERIENCE:
Howard, Craig Survey Crew Chief	0 years	15+ years	0 years
Brief Explanation of Responsibilities Supervises field crew for boundary, control, topographic and construction staking projects. Also acts as primary contact for property owners, clients and contractors at project sites.			
EDUCATION (Degree, Year, Specialization)			
<ul style="list-style-type: none"> • Lees Junior College, 1986-87 • Mayo State Vocational Technical School, 1988-1990 			
MEMBERSHIP IN PROFESSIONAL ORGANIZATIONS / TRAINING			
<ul style="list-style-type: none"> • HAZWOPER Trained - OSHA 40 hour course, 2007 • CPR, First Aid and Bloodborne Pathogens Training-American Red Cross, 2007 			
13. PERSONAL HISTORY STATEMENT OF PRINCIPALS AND ASSOCIATES RESPONSIBLE FOR AML PROJECT DESIGN (Furnish complete data but keep to essentials)			
NAME & TITLE (Last, First, Middle Int.)	YEARS OF AML DESIGN EXPERIENCE:	YEARS OF EXPERIENCE	
		YEARS OF AML RELATED DESIGN EXPERIENCE:	YEARS OF DOMESTIC WATERLINE DESIGN EXPERIENCE:
Perry, Patrick Survey Instrumentman & Rodman	0 years	0 years	0 years
Brief Explanation of Responsibilities Survey instrumentman and rodman for boundary, control, topographic and construction staking projects. Also acts as primary contact for property owners, clients and contractors at project sites.			
EDUCATION (Degree, Year, Specialization)			
<ul style="list-style-type: none"> • BS/Civil Engineering/University of Kentucky/2006 • AS/Lexington Community College/2003 			
MEMBERSHIP IN PROFESSIONAL ORGANIZATIONS / TRAINING			
<ul style="list-style-type: none"> • American Society of Civil Engineers • Order of the Engineer • Association of General Contractors 			
		REGISTRATION (Type, Year, State)	
		<ul style="list-style-type: none"> • Kentucky/Civil/EIT #12938/2006 	

14. PROVIDE A LIST OF SOFTWARE AND EQUIPMENT AVAILABLE IN THE PRIMARY OFFICE WHICH WILL BE USED TO COMPLETE AML DESIGN SERVICES

Surveying Equipment: Trimble 5700 GPS Receivers; (3) Trimble 5600 Fully Robotic Total Stations; Nikon DTM 550 Total Station; Leica 800 Total Station; Range TDS Survey Pro Data Collector; TSC1 Trible Survey Controller; HP 48 with SMI Construction 5 Robotic Software; Lietz Automatic Level; CADD-AUTOCADD, LDD2 & Microstation; Star*Net; Trimble Geomatics Office Software; GPS Vector Analysis; (3) Ziess Levels; (1) Wild Level; (1) Paulin Altimeter; (2) Survey Trucks; Trimble GEOXH; Trimble Pathfinder Office

Testing Equipment: (4) Concrete Air Meters; (1) Concrete Cylinder Breaker; (5) Slump Cones; (3) Speedy Moisture Testers; (1) Asphalt Extractor & 2 Sieve Shakers; (3) Nuclear Density Meters

Drilling Equipment: Mobile Sounding Rig

Noise Analysis Equipment: Bruel & Kjaer 2236A Type I Sound Level Meter; Skymate Anemometer; FHWA TNM 1.1/2.5 Noise Prediction (Computer Program); RION NL-20 Sound Level Meter

Air Analysis Equipment: Computer programs- Mobile 6.0/6.2; CAL3QHC (Carbon Monoxide Prediction Model); Microstation V8 and Descartes V8

Aquatic & Water Quality Equipment: Olympus LMS225R Bi-ocular Dissecting Microscope; HACH pH meter; Hach DREL/2010 Aquaculture Laboratory; Zoon Stereo Microscope w/Fiber Optic Light Sources; Seine & Dip Nets-Portable Lab Kits; HACH TDS/Conductivity Meter; HACH Spectrophotometer

Terrestrial Equipment: TRX 1000S Radio Receiver; Plant Presses; Holohil Systems, Ltd; LB2N Radio Transmitter; LTM Radio Transmitters, Soil Augers; Anabat II Bat Detector, Bat Nets & Poles; Soil Sieves

Hardware: (100) Engineering/CADD workstation; (20) Administrative workstation; (19) Laptop computers; (10) Large Format Plotters; VPN between Main Office and Regional Offices; Corporate Intranet and Internet e-mail; (6) Novell 5 Servers; (3) Color Laser Printers; (7) Linux Servers; (1) Linux Mail Server; (1) Color Copier/Scanner/Printer; (4) Window Servers

Software: Bentley; Microstation; Descartes InRoads, InRoads Survey, Geopak Survey, SewerCad and Watercad, Integraph InXpress Roadway Design, EaglePoint Hydraulic/Site Development/Storm & Sanitary Sewer Design/Roadway Design, CAL3QHC/Mobile6/TNM 2.5 Air Quality/Noise, KyHydro, KyPipe, HEC - 2 HC-RAS, WSPRO - Highway and Environmental Hydraulic Design, HCM - Highway Traffic Analysis, Passer 2 - Highway Traffic Analysis, MSTRUDL, STAAD3, CONSPAN, TRAPS, Merlin DASH - RC Pier Structural Design, MATHCAD - general mathematical modeling software, Microstation Office Office Suite; Word, Excel, Outlook, PowerPoint, Project, Publisher, Front Page

CorelDraw - graphic/presentation, Adobe, Acrobat, Photoshop E S R I - ARCGIS - ARC Editor, Deltek Vision (Accounting and CRM), Acutate e.Report Designer Professional, Trend Micro Client/Server Anti-Virus, HAESTAD: Watercad, Stormcad, Culvertmaster, Pondpack and Flowmaster, Hydrain for Windows: Hydrologic & Hydraulic Modeling,

Anabat - Env. Bat Echolocation species identification hardware/software package.

Global Mapper 8, Visualization: Autodesk 3DS Max, Visual Nature Studio, Adobe Creative Suite

Auto Desk; Auto Cad, Civil 3-D, Civil 3 P Pro, Survey

KyCOGO - Coordinate geometry / highway design

15. CURRENT ACTIVITIES ON WHICH YOUR FIRM IS THE DESIGNATED ENGINEER OF RECORD

PROJECT NAME, TYPE AND LOCATION	NAME AND ADDRESS OF OWNER	NATURE OF YOUR FIRM'S RESPONSIBILITY	ESTIMATED CONSTRUCTION COST	PERCENT COMPLETE
West Virginia Rt 10 Upgrade to 4 Lanes Cabell County, WV	WV Department of Transportation Charleston, WV	Highway Design	\$12,000,000 (Placed on hold October 2000)	95%
Corridor H Design new 4-lane highway Grant County, WV	WV Department of Transportation Charleston, WV	Highway Design	\$12,000,000	95%
Burner Mountain Upgrade to 2 lanes Pocahontas County, WV	WV Department of Transportation Charleston, WV	Highway Design	\$1,500,000	Not Scoped
Mt Gay Bridge Bridge Replacement Logan County, WV	WV Department of Transportation Charleston, WV	Structural Design	\$5,600,000	85%
Midkiff Bridge Bridge Replacement Lincoln County, WV	WV Department of Transportation Charleston, WV	Structural Design	\$2,100,000	30%
Barren County I-65 5.1 Miles	KY Transportation Cabinet Frankfort, KY	Highway Design	\$6,250,000	60%
US 127, Relocation, 4.3 Miles Clinton County, KY	KY Transportation Cabinet Frankfort, KY	Highway Design	\$26,600,000	90%

TOTAL NUMBER OF PROJECTS: 7	TOTAL ESTIMATED CONSTRUCTION COSTS: \$66,050,000
-----------------------------	--

15. CURRENT ACTIVITIES ON WHICH YOUR FIRM IS THE DESIGNATED ENGINEER OF RECORD

PROJECT NAME, TYPE AND LOCATION	NAME AND ADDRESS OF OWNER	NATURE OF YOUR FIRM'S RESPONSIBILITY	ESTIMATED CONSTRUCTION COST	PERCENT COMPLETE
US 460/KY 80 at Draffin 0.5 Miles Pike County	KY Transportation Cabinet Frankfort, KY	Highway Design	\$7,100,000	90%
I-66 London to Somerset Env. and Prem. Design 20 miles Laurel and Pulaski Counties	KY Transportation Cabinet Frankfort, KY	Highway Design	\$60,000,000	98%
Scott County US 460 0.9 Mile	KY Transportation Cabinet Frankfort, KY	Highway Design	\$3,200,000	75%
Hart County 1.0 Miles	KY Transportation Cabinet Frankfort, KY	Highway Design	\$14,000,000	40%
KY 80 Over CSRR & Russell Fork 0.4 Miles Pike County, KY	KY Transportation Cabinet Frankfort, KY	Highway Design	\$4,000,000	95%
KY 22 Over Licking River 0.5 Miles Pendleton County, KY	KY Transportation Cabinet Frankfort, KY	Highway Design	\$4,500,000	75%
Hal Rodgers Parkway Safety Improvements 2.2 miles Leslie County, KY	KY Transportation Cabinet Frankfort, KY	Highway Design	\$15,000,000	30%

TOTAL NUMBER OF PROJECTS: 7

TOTAL ESTIMATED CONSTRUCTION COSTS: \$107,800,000

15. CURRENT ACTIVITIES ON WHICH YOUR FIRM IS THE DESIGNATED ENGINEER OF RECORD

PROJECT NAME, TYPE AND LOCATION	NAME AND ADDRESS OF OWNER	NATURE OF YOUR FIRM'S RESPONSIBILITY	ESTIMATED CONSTRUCTION COST	PERCENT COMPLETE
Widen KY 1848 to 5 lanes 0.9 Miles Shelby County, KY	KY Transportation Cabinet Frankfort, KY	Highway Design	\$3,700,000	90%
Marion County KY 1231	KY Transportation Cabinet Frankfort, KY	Highway Design	\$7,500,000	40%
Laurel County US 25 0.8 Miles	KY Transportation Cabinet Frankfort, KY	Highway Design	\$3,500,000	40%
Knott County KY 1231	KY Transportation Cabinet Frankfort, KY	Highway Design	\$5,500,000	25%
Owsley County US 25	KY Transportation Cabinet Frankfort, KY	Highway Design	\$20,000,000	10%
Pine Mountain Settlement School Restoration Harlan Co, KY	KY Transportation Cabinet Frankfort, KY	Highway Design	\$900,000	50%
TOTAL NUMBER OF PROJECTS: 6			TOTAL ESTIMATED CONSTRUCTION COSTS: \$41,100,000	

16. CURRENT ACTIVITIES ON WHICH YOUR FIRM IS SERVING AS A SUB-CONSULTANT TO OTHERS

PROJECT NAME, TYPE AND LOCATION	NATURE OF FIRMS RESPONSIBILITY	NAME AND ADDRESS OF OWNER	ESTIMATED COMPLETION DATE	ESTIMATED CONSTRUCTION COST	
				ENTIRE PROJECT	YOUR FIRMS RESPONSIBILITY
I-64 7 Miles Widening and Rehabilitation Jefferson-Shelby County	Final Design	KY Transportation Cabinet Frankfort, KY	2008	\$45,000,000	
Whitley County Welcome Center	Final Design	KY Transportation Cabinet Frankfort, KY	2008	\$10,000,000	
Carter Co I-64	Scoping Study	KY Transportation Cabinet Frankfort, KY	2008	N/A	
I-69/I-66 Spur Daviess County	Scoping Study	KY Transportation Cabinet Frankfort, KY	2008	N/A	

17. COMPLETED WORK WITHIN LAST 5 YEARS ON WHICH YOUR FIRM WAS THE DESIGNATED ENGINEER OF RECORD					
PROJECT NAME, TYPE AND LOCATION	NAME AND ADDRESS OF OWNER	ESTIMATED CONSTRUCTION COST	YEAR	CONSTRUCTED (YES OR NO)	
SR-10 Melissa Huntington Rd Demolition Plans Cabell County, WV	WV Department of Transportation Charleston, WV	\$300,000	2004	YES	
I-71 4-mile widening to 6 Lanes and entrance to Nascar Race Track Roadway/Bridge Design Gallatin County, KY	KY Transportation Cabinet Frankfort, KY	\$35,000,000	2003	NO	
Rowlesburg Bridge & Approaches (CR 1) Roadway/Bridge Plans Preston County, WV	WV Department of Transportation Charleston, WV	\$3,000,000	2003	YES	
Robertson County KY 165 4 miles 2-lane on new Location Roadway and Bridge	KY Transportation Cabinet Frankfort, KY	\$6,000,000	2004	YES	
Sullivan County SR357	Tennessee Department Of Transportation Nashville, TN		2005	NO	
Grays Run Natural Channel Design Cynthiana Bypass, KY	KY Transportation Cabinet Frankfort, KY	\$210,000	2004	NO	
Kess Creek Natural Channel Design KY 121 Graves Co, KY	KY Transportation Cabinet Frankfort, KY	\$300,000	2005	NO	
Parks Branch Natural Channel Design Whitley Co, KY	KY Transportation Cabinet Frankfort, KY	\$360,000	2005	NO	

18. COMPLETED WORK WITHIN LAST 5 YEARS ON WHICH YOUR FIRM HAS BEEN A SUB-CONSULTANT TO OTHER FIRMS (INDICATE PHASE OF WORK FOR WHICH YOUR FIRM WAS RESPONSIBLE)

PROJECT NAME, TYPE AND LOCATION	NAME AND ADDRESS OF OWNER	ESTIMATED CONSTRUCTION COST OF YOUR FIRM'S PORTION	YEAR	CONSTRUCTED (YES OR NO)	FIRM ASSOCIATED WITH
Locust Creek Stream Mitigation and Monitoring KY 19 Bracken Co, KY	KY Transportation Cabinet Frankfort, KY	\$160,000	2002	YES	
Rush Fork Creek Stream Restoration US 23 Johnson Co, KY	KY Transportation Cabinet Frankfort, KY	\$340,000	2001	YES	
Dix River Tributary Stream Mitigation and Monitoring US 150 Lincoln Co, KY	KY Transportation Cabinet Frankfort, KY	\$540,000	2000	YES	
Lick Fork Stream Mitigation and Monitoring KY 7 Morgan Co, KY	KY Transportation Cabinet Frankfort, KY	\$220,000	2001	YES	
Reed Fork Creek Stream Restoration US 119 Pike Co, KY	KY Transportation Cabinet Frankfort, KY	\$240,000	2002	YES	
Roundstone Creek Tributary Stream Mitigation and Monitoring I-75 Rockcastle Co, KY	KY Transportation Cabinet Frankfort, KY	\$500,000	2002	YES	

19. Use this space to provide any additional information or description of resources supporting your firm's qualifications to perform work for the West Virginia Abandoned Mine Lands Program.

The projects listed on this page only are Steve Rice's personal experience that he gained with a previous employer.

20. The foregoing is a statement of facts.

Signature: Greg Boleyn

Title: WV Office Manager

Date: November 20, 2008

Printed Name: Greg Boleyn, PE

**WEST VIRGINIA DEPARTMENT OF ENVIRONMENTAL PROTECTION
AML CONSULTANT CONFIDENTIAL QUALIFICATION QUESTIONNAIRE Attachment "B"**

PROJECT NAME: DEP 14480 Venus (Hamilton) Drainage
 DATE: November 20, 2008
 FEIN: 52-2365940

1. FIRM NAME: Novel Geo-Environmental, LLC
 2. HOME OFFICE BUSINESS ADDRESS: 171 Montour Road Moon Township, PA 15108
 3. FORMER FIRM NAME: NA

4. HOME OFFICE TELEPHONE: (412) 722-1970
 5. ESTABLISHED: 2002
 6. TYPE OWNERSHIP: Limited Liability Corporation
 6a. WV REGISTERED DBE: YES

7. PRIMARY AML DESIGN OFFICE: ADDRESS/ TELEPHONE/ PERSON IN CHARGE/ NO. AML DESIGN PERSONNEL EACH OFFICE:
 806 B Street Office Manager: John E. Nottingham, P.E.
 St. Albans, WV 25177 No. AML Design Personnel in St. Albans, WV: 5
 304-201-5180 No. AML Design Personnel in Moon Township, PA : 5

8. NAMES OF PRINCIPAL OFFICERS OR MEMBERS OF FIRM: 8a. NAME, TITLE, & TELEPHONE NUMBER - OTHER PRINCIPALS
 Amy L. Veltri - President
 John E. Nottingham - Vice President

9. PERSONNEL BY DISCIPLINE (Bold Lettering Indicates Minimum Design Team Members)

— ADMINISTRATIVE	— ECOLOGISTS	— LANDSCAPE ARCHITECTS	— STRUCTURAL ENGINEERS
— ARCHITECTS	— ECONOMISTS	— MECHANICAL ENGINEERS	— SURVEYORS
— BIOLOGIST	— ELECTRICAL ENGINEERS	— MINING ENGINEERS	— TRAFFIC ENGINEERS
1 CADD OPERATORS	4 ENVIRONMENTALISTS	— PHOTOGRAMMETRISTS	4 DRILLERS & HELPERS
— CHEMICAL ENGINEERS	ESTIMATORS	— PLANNERS: URBAN/REGIONAL	5 OTHER PERSONNEL
2 CIVIL ENGINEERS	2 GEOLOGISTS	— SANITARY ENGINEERS	
4 CONSTRUCTION INSPECTORS	HISTORIANS	2 SOILS ENGINEERS	
— DESIGNERS	HYDROLOGISTS	— SPECIFICATION WRITERS	20 TOTAL PERSONNEL
— DRAFTSMEN			

TOTAL NUMBER OF WV REGISTERED PROFESSIONAL ENGINEERS IN PRIMARY OFFICE: 2
 *RPEs other than Civil and Mining must provide supporting documentation that qualifies them to supervise and perform this type of work.

10. HAS THIS JOINT-VENTURE WORKED TOGETHER BEFORE? YES

11. OUTLINE KEY CONSULTANTS/SUB-CONSULTANTS ANTICIPATED TO BE USED. Attach "AML Consultant Confidential Qualification Questionnaire" for each if copy is not on file with AM.

<p>NAME AND ADDRESS:</p>	<p>SPECIALTY:</p>	<p>WORKED WITH BEFORE</p> <p>____ Yes</p> <p>____ No</p>
<p>NAME AND ADDRESS:</p>	<p>SPECIALTY:</p>	<p>WORKED WITH BEFORE</p> <p>____ Yes</p> <p>____ No</p>
<p>NAME AND ADDRESS:</p>	<p>SPECIALTY:</p>	<p>WORKED WITH BEFORE</p> <p>____ Yes</p> <p>____ No</p>
<p>NAME AND ADDRESS:</p>	<p>SPECIALTY:</p>	<p>WORKED WITH BEFORE</p> <p>____ Yes</p> <p>____ No</p>
<p>NAME AND ADDRESS:</p>	<p>SPECIALTY:</p>	<p>WORKED WITH BEFORE</p> <p>____ Yes</p> <p>____ No</p>
<p>NAME AND ADDRESS:</p>	<p>SPECIALTY:</p>	<p>WORKED WITH BEFORE</p> <p>____ Yes</p> <p>____ No</p>
<p>NAME AND ADDRESS:</p>	<p>SPECIALTY:</p>	<p>WORKED WITH BEFORE</p> <p>____ Yes</p> <p>____ No</p>
<p>NAME AND ADDRESS:</p>	<p>SPECIALTY:</p>	<p>WORKED WITH BEFORE</p> <p>____ Yes</p> <p>____ No</p>
<p>NAME AND ADDRESS:</p>	<p>SPECIALTY:</p>	<p>WORKED WITH BEFORE</p> <p>____ Yes</p> <p>____ No</p>

12. Is your firm experienced in Abandoned Mine La' Remediation/Mine Reclamation Engineering?

NO: Note that Novel Geo-Environmental (NGE) has not performed any AML design work to date, but our WV Office Manager (John E. Nottingham) and project geologist (Chuck Montgomery) have extensive AML experience with their former firm. Additionally, NGE currently holds a contract with WVDEP-AML for geotechnical drilling for the northern district of WV and has completed several drilling projects under this contract.

B. Is your firm experienced in Soil Analysis?

YES: NGE specializes in Geotechnical Engineering including foundation investigations, subsurface investigations, cut slope design, fill embankment analysis and design, slope stability analysis, landslide analysis and corrective design, mine subsidence investigations, geologic studies, groundwater seepage analysis, foundation design, retaining wall design, pavement design, subsurface drilling and monitoring well installation. NGE has performed a total of several hundred geotechnical engineering related projects since the company was formed in 2002.

C. Is your firm experienced in hydrology and hydraulics?

NO: While our firm has not performed any hydrology/hydraulics projects to date, our personnel have experience with former employers.

D. Does your firm produce its own Aerial Photography and Develop Contour Mapping?

NO

E. Is your firm experienced in domestic waterline design? (Include any experience your firm has in evaluation of aquifer degradation as a result of mining.)

NO

F. Is your firm experienced in Acid Mine Drainage Evaluation and Abatement Design?

NO

13. PERSONAL HISTORY STATEMENT OF PRINCIPALS AND ASSOCIATES RESPONSIBLE FOR AML PROJECT DESIGN (Furnish complete data but keep to essentials)			
NAME & TITLE (Last, First, Middle Int.)	YEARS OF EXPERIENCE		YEARS OF DOMESTIC WATERLINE DESIGN EXPERIENCE:
	YEARS OF AML DESIGN EXPERIENCE:	YEARS OF AML RELATED DESIGN EXPERIENCE:	
<p>Nottingham, John, E. Principal Engineer, Vice President</p> <p>Brief Explanation of Responsibilities</p> <p>Mr. Nottingham was responsible for supervising field and design work for numerous AML related landslide abatement projects for the WVDEP while under the employment of Triad Engineering, Inc. In addition to landslide abatement projects, Mr. Nottingham was involved in subsidence determination investigations and subsidence abatement projects. Mr. Nottingham worked extensively on "emergency" projects which required quick field investigations and corrective designs.</p>	12	4	0
<p>EDUCATION (Degree, Year, Specialization)</p> <p>Bachelor of Science in Civil Engineering, 1987, WVU, Specialization - Civil and Geotechnical Engineering Masters of Science in Civil Engineering, 1995, WVU, Specialization - Geotechnical Engineering</p>			
<p>MEMBERSHIP IN PROFESSIONAL ORGANIZATIONS</p> <p>American Society of Civil Engineering (ASCE) West Virginia Chapter of AIA</p>			
<p>13. PERSONAL HISTORY STATEMENT OF PRINCIPALS AND ASSOCIATES RESPONSIBLE FOR AML PROJECT DESIGN (Furnish complete data but keep to essentials)</p>			
NAME & TITLE (Last, First, Middle Int.)	YEARS OF EXPERIENCE		YEARS OF DOMESTIC WATERLINE DESIGN EXPERIENCE:
	YEARS OF AML DESIGN EXPERIENCE:	YEARS OF AML RELATED DESIGN EXPERIENCE:	
<p>Montgomery, Charles, E. Project Manager</p> <p>Brief Explanation of Responsibilities</p> <p>Mr. Montgomery was responsible for coordinating field activities for AML landslide abatement projects for the WVDEP while employed with Triad Engineering, Inc. Mr. Montgomery has also participated in all project phases for other AML work involving subsidence determinations/abatement and impounded mine pools.</p>	10	4	0
<p>EDUCATION (Degree, Year, Specialization)</p> <p>Bachelor of Science, Geology, 1991, Marshall University</p>			
<p>MEMBERSHIP IN PROFESSIONAL ORGANIZATIONS</p> <p>Association of Engineering Geologists Geological Society of America</p>			
<p>REGISTRATION (Type, Year, State)</p> <p>Professional Geologist, 1999, Kentucky</p>			

13. PERSONAL HISTORY STATEMENT OF PRINCIPALS AND ASSOCIATES RESPONSIBLE FOR AML PROJECT DESIGN (Furnish complete data, but keep to essentials)			
NAME & TITLE (Last, First, Middle Int.) Nottingham, Larry C. Senior Engineer	YEARS OF AML DESIGN EXPERIENCE: 15	YEARS OF AML RELATED DESIGN EXPERIENCE: 5	YEARS OF DOMESTIC WATERLINE DESIGN EXPERIENCE: 0
	Brief Explanation of Responsibilities Dr. Nottingham planned and supervised several AML investigation and reclamation projects for WVDEP while employed by Triad Engineering. Projects included burning refuse pile investigations, unstable refuse pile investigations and remedial designs, landslide investigations and remedial designs, subsidence investigations, and underground mine fire investigations.		
EDUCATION (Degree, Year, Specialization) Bachelor of Science in Civil Engineering, 1965, Civil Engineering, West Virginia Institute of Technology Master of Science in Civil Engineering, 1966, Geotechnical Engineering, University of Pittsburgh Doctor of Philosophy, 1975, Geotechnical Engineering, University of Florida			
MEMBERSHIP IN PROFESSIONAL ORGANIZATIONS Member, American Society of Civil Engineers Member, National Society of Professional Engineers			
13. PERSONAL HISTORY STATEMENT OF PRINCIPALS AND ASSOCIATES RESPONSIBLE FOR AML PROJECT DESIGN (Furnish complete data but keep to essentials)			
NAME & TITLE (Last, First, Middle Int.) Christopher Dunlap Engineering Technician	YEARS OF AML DESIGN EXPERIENCE: 0	YEARS OF AML RELATED DESIGN EXPERIENCE: 0	YEARS OF DOMESTIC WATERLINE DESIGN EXPERIENCE: 0
	Brief Explanation of Responsibilities Mr. Dunlap has served as an engineering technician/field inspector on numerous government and commercial construction projects. His duties on these projects have included quality assurance/quality control (QA/QC), construction oversight and testing, coordination of field activities, liaison between general contractor and engineer, and project reporting.		
EDUCATION (Degree, Year, Specialization): A.S., Mechanical Engineering Technology, WVUIT; American Concrete Institute (ACI) Certified; WVDOH Certification for Fill Compaction Technician; WVDOH Certification for Concrete Technician; WVDOH Certification for Asphalt Inspector.			
MEMBERSHIP IN PROFESSIONAL ORGANIZATIONS: NA			
REGISTRATION (Type, Year, State): NA			

14. PROVIDE A LIST OF SOFTWARE AND EQUIPMENT AVAILABLE IN THE PRIMARY OFFICE WHICH WILL BE USED TO COMPLETE THE DESIGN SERVICES

Three rotary drill rigs, one mounted on a four wheel drive one-ton truck, and two track-mounted rigs. Drills are equipped with hollow stem augers, split-spoon soil sampling equipment, and rock coring tools.

Portable dynamic cone penetrometer.

Electric concrete coring drill.

Two equipment hauling trailers.

Software includes: Word processing, PCSTABL - Slope Stability Analysis, LPILE Plus 4.0 - Pile Foundation Analysis, PYWALL 2.0 - Retaining Wall Analysis, RESSA 2.0 - Reinforced Soil Slope Analysis, Reslope 3.0 - Reinforced Soil Slope Design

Soil Laboratory Equipment: Soil Oven, Scales, Sieves, Liquid and Plastic Limits Machine

15. CURRENT ACTIVITIES ON WHICH YOUR FIRM IS THE DESIGNATED ENGINEER OF RECORD

PROJECT NAME, TYPE AND LOCATION	NAME AND ADDRESS OF OWNER	NATURE OF YOUR FIRM'S RESPONSIBILITY	ESTIMATED CONSTRUCTION COST	PERCENT COMPLETE
Chesapeake Energy Office & Shop Complex, Geotechnical Investigation, Inez, KY	Chesapeake Energy Corporation, 6100 N. Western Avenue, Oklahoma City, OK 73154	Perform subsurface investigation, develop and provide recommendations for building foundation design	Unknown, Fee = \$6600.00	5
Annual Geotechnical Drilling Contract, Northern West Virginia	West Virginia Department of Environmental Protection	Perform geotechnical (drilling) investigations of abandoned mine land sites as directed by WVDEP/AML personnel.	Unknown	30
TOTAL NUMBER OF PROJECTS: 2			TOTAL ESTIMATED CONSTRUCTION COSTS: \$	Unknown

16. CURRENT ACTIVITIES ON WHICH YOUR FIRM IS SERVING AS A CONSULTANT TO OTHERS

PROJECT NAME, TYPE AND LOCATION	NATURE OF FIRMS RESPONSIBILITY	NAME AND ADDRESS OF OWNER	ESTIMATED COMPLETION DATE	ESTIMATED CONSTRUCTION COST	
				ENTIRE PROJECT	YOUR FIRMS RESPONSIBILITY
Ten Cell Tower Sites, Geotechnical Investigations, Various Locations Throughout WV	Determine Site Subsurface Conditions, Provide Foundation Design Recommendations.	Terradon Corp. Nitro, WV	March, 2008	Unknown	Fee \$33,000
Six Cell Tower Sites, Geotechnical Investigations, Various Locations Throughout WV	Determine Site Subsurface Conditions	PSI, Inc. 153 Williams Hwy Parkersburg, WV	March, 2008	Unknown	Fee ≈ \$12,000
Toyota Meeting Room, Geotechnical Investigation, Buffalo, WV	Geotechnical Investigation for New Building Structure	Toyota Corp. Buffalo, WV	March, 2008	Unknown	Fee \$4000
I-64 Over Hal Greer Blvd. Bridge, CSL Testing, Huntington, WV	Perform Cross-Hole Sonic Logging of New Foundation Drilled Piers	West Virginia Dept. of Highways, Charleston, WV	August, 2008	Unknown	Fee ≈ \$17,000
Harrison Co. EMS Station, Geotechnical Investigation, Clarksburg, WV	Determine Site Subsurface Conditions, Provide Foundation Design Recommendations	Harrison Co. EMS Clarksburg, WV	February, 2008	Unknown	Fee \$4000
Corridor H Highway Construction, Quality Control Testing, Grant Co., WV	Perform soil compaction and concrete quality control tests.	West Virginia Dept. of Highways, Charleston, WV	November, 2008	Unknown	Fee ≈ \$75,000
Water Storage Tank, Subsurface Investigation, Gilbert, WV	Determine Site Subsurface Conditions	Gilbert PSD Gilbert, WV	March, 2008	Unknown	Fee \$3000

18. COMPLETED WORK WITHIN LAST 5 YEARS ON WHICH YOUR FIRM HAS BEEN A SUB-CONSULTANT TO OTHER FIRMS (INDICATE PHASE OF WORK FOR WHICH YOUR FIRM WAS RESPONSIBLE)

PROJECT NAME, TYPE AND LOCATION	NAME AND ADDRESS OF OWNER	ESTIMATED CONSTRUCTION COST OF YOUR FIRM'S PORTION	YEAR	CONSTRUCTED (YES OR NO)	FIRM ASSOCIATED WITH
S. Mineral Wells Interchange, Geotechnical Study, Mineral Wells, WV	WV Department of Highways Charleston, WV	\$5,000,000	2007	In Process	L. A. Gates Co.
Winefrede RR Overpass Bridge, Geotechnical Investigation, Winefrede, WV	WV Department of Highways Charleston, WV	\$1,500,000	2005	Yes	HNTB Corporation
Performing Arts Center. Geotechnical Investigation, Buckhannon, WV	West Virginia Wesleyan College, Buckhannon, WV	\$500,000	2007	Yes	R. D. Zande & Associates, Inc.
Mt. Gay Overpass Bridge, Geotechnical Investigation, Logan, WV	WV Department of Highways Charleston, WV	\$1,000,000	2004	Yes	HMB Professional Engineers, Inc.
Water Tanks, Geotechnical Investigation, Iager, WV	Iager PSD Iager, WV	\$100,000	2006	Yes	Stafford Consultants
5th Avenue Bridge, Geotechnical Investigation, Huntington, WV	WV Department of Highways Charleston, WV	\$2,500,000	2003	Yes	Modjeski & Masters, Charleston, WV

19. Use this space to provide any additional information or description of resources supporting your firm's qualifications to perform work for the West Virginia Abandoned Mine Lands Program.

20. The foregoing is a statement of facts.

Signature: John E. Nottingham Title: Vice President

Printed Name: John E. Nottingham

Date: November 20, 2008

WEST VIRGINIA DEPARTMENT OF ENVIRONMENTAL PROTECTION
 AML CONSULTANT CONFIDENTIAL QUALIFICATION QUESTIONNAIRE

Attachment "B"

PROJECT NAME
DEP14480 - Venus (Hamilton) Drainage

DATE (DAY, MONTH, YEAR)
20, November, 2008

FEIN
61-1183895

1. FIRM NAME
**GMR Aerial Surveys, Inc.
 dba Photo Science**

2. HOME OFFICE BUSINESS ADDRESS
**2670 Wilhite Drive
 Lexington, KY 40503**

3. FORMER FIRM NAME
Photo Science of Kentucky, Inc.

4. HOME OFFICE TELEPHONE
859-277-8700

5. ESTABLISHED (YEAR)
1974

6. TYPE OWNERSHIP
 Individual Partnership Corporation Joint-Venture YES NO

6a. WV REGISTERED DBE
 YES NO

7. PRIMARY AML DESIGN OFFICE: ADDRESS/ TELEPHONE/ PERSON IN CHARGE/ NO. PERSONNEL EACH OFFICE

2670 Wilhite Drive / Lexington, KY 40503 / 859-277-8700 / G. Michael Ritchie / 75

1410 Indian Trail Road / Norcross, GA 30093 / 770-564-9843 / Jeffrey S. Simmons / 46

67 Pine Street, Suite 2 / Bangor, ME 04401 / 207-262-3232 / Kristina Ivey / 1

6200 Metrowest Boulevard, Suite 206 / Orlando, FL 32835 / 407-521-2262 / Nickolas R. Fusco / 2

10033 MLK Street N, Suite 200 / St. Petersburg, FL 33716 / 727-576-9500 / Gary R. Florence / 35

4801 Telsa Drive, Suite J / Bowie, MD 20715 / 301-262-9400 / Kurt W. Allen / 17

104 South Church Street / West Chester, PA 19382 / 610-344-0890 / Robert J. Hickey / 2

8. NAMES OF PRINCIPAL OFFICIALS OR MEMBERS OF FIRM

G. Michael Ritchie / President / 859-277-8700

Mark E. Meade / Vice President / 859-277-8700

Jeffrey S. Simmons / Vice President / 770-564-9843

Kurt W. Allen / Vice President / 301-262-9400

Robert J. Hickey / Vice President / 610-344-0890

8a. NAME, TITLE, & TELEPHONE NUMBER - OTHER PRINCIPALS
N/A

9. PERSONNEL BY DISCIPLINE

ADMINISTRATIVE	ECOLOGISTS	LANDSCAPE ARCHITECTS	STRUCTURAL ENGINEERS
ARCHITECTS	ECONOMISTS	MECHANICAL ENGINEERS	17 SURVEYORS
BIOLOGIST	ELECTRICAL ENGINEERS	MINING ENGINEERS	TRAFFIC ENGINEERS
18 CADD OPERATORS	ENVIRONMENTALISTS	15 PHOTOGRAMMETRISTS	OTHER
CHEMICAL ENGINEERS	ESTIMATORS	PLANNERS: URBAN/REGIONAL	
CIVIL ENGINEERS	GEOLOGISTS	SANITARY ENGINEERS	
CONSTRUCTION INSPECTORS	HISTORIANS	SOILS ENGINEERS	
DESIGNERS	HYDROLOGISTS	SPECIFICATION WRITERS	178 TOTAL PERSONNEL
DRAFTSMEN			

TOTAL NUMBER OF WV REGISTERED PROFESSIONAL ENGINEERS IN PRIMARY OFFICE: **2**

*RPEs other than Civil and Mining must provide supporting documentation that qualifies them to supervise and perform this type of work

10. HAS THIS JOINT-VENTURE WORKED TOGETHER BEFORE? YES NO

11. OUTSIDE KEY CONSULTANTS/ASSOCIATES ANTICIPATED TO BE USED. Attach "Consultant Confidential Qualification Questionnaire" for each if copy is not on with the Division.

NAME AND ADDRESS	SPECIALITY	WORKED WITH BEFORE
NAME AND ADDRESS	SPECIALITY	WORKED WITH BEFORE <input type="checkbox"/> YES <input type="checkbox"/> NO
NAME AND ADDRESS	SPECIALITY	WORKED WITH BEFORE <input type="checkbox"/> YES <input type="checkbox"/> NO
NAME AND ADDRESS	SPECIALITY	WORKED WITH BEFORE <input type="checkbox"/> YES <input type="checkbox"/> NO
NAME AND ADDRESS	SPECIALITY	WORKED WITH BEFORE <input type="checkbox"/> YES <input type="checkbox"/> NO
NAME AND ADDRESS	SPECIALITY	WORKED WITH BEFORE <input type="checkbox"/> YES <input type="checkbox"/> NO
NAME AND ADDRESS	SPECIALITY	WORKED WITH BEFORE <input type="checkbox"/> YES <input type="checkbox"/> NO

12. A. Is your firm experienced in Abandoned Mine Lands Remediation / Mine Reclamation Engineering?

YES Description and Number of Projects: _____

NO

B. Is your firm experienced in Soil Analysis?

YES Description and Number of Projects: _____

NO

C. Is your firm experienced in Hydrology and hydraulics?

YES Description and Number of Projects: _____

NO

D. Does your firm produce its own Aerial Photography and Develop Contour Mapping?

YES Description and Number of Projects: See description of services on following pages.

NO

E. Is your firm experienced in domestic waterline design? (Include any experience your firm has in evaluation of aquifer degradation as a result of mining.)

YES Description and Number of Projects: _____

NO

F. Is your firm experienced in Acid Mine Drainage Evaluation and Abatement Design?

YES Description and Number of Projects: _____

NO

COMPANY BACKGROUND

Founded in 1974, Photo Science is a *Geospatial Services* firm, specializing in aerial imaging and data collection, photogrammetric mapping, GIS, remote sensing, and surveying services.

Initially, the company consisted of one (1) aircraft, ten (10) employees, and offered aerial photography and photogrammetric mapping services, predominantly to local area engineers and the coalfields of eastern Kentucky and throughout West Virginia. Through decades of planning and disciplined growth, Photo Science currently owns and operates nine (9) aircraft, employs more than 170 professional and technical staff in seven (7) production facilities across the country, and provides full-service geospatial solutions to our diversified client base.

The firm is currently registered to conduct business in 22 states, including West Virginia since 1998. We are registered in West Virginia to offer and provide engineering services (C01583) and land surveying services (6-5358). In addition, our staff consists of West Virginia registered Professional Engineers and registered Professional Land Surveyors.

We currently have a strong group of professionals, including 15 Certified Photogrammetrists, 18 Professional Land Surveyors, 3 Professional Surveyor and Mappers, 2 Professional Engineers, and 2 Certified Planners with many years of experience in all facets of geospatial solutions.

We have invested millions of dollars in state-of-the-art equipment over the past decade to stay current with the ever changing geospatial industry. Our aircraft are equipped with conventional precision film cameras; large-format Z/I Imaging Digital Mapping Cameras (DMC) — *being only one of five firms in the country to own this high-end large-format digital imaging capability*; medium-format Applanix Digital Sensor System (DSS) 322, and Leica ALS-50 LIDAR sensors. These sensors are integrated with our flight management systems, airborne GPS, and Inertial Measurement Unit technology. Additionally, we maintain a diversified platform of photogrammetric workstations and production resources that enables efficient, multi-task-order operations.

Photo Science has the equipment, staffing, and experience to meet the needs of the West Virginia Office of Abandoned Mine Lands. We offer:

- ♦ aircraft, sensors, and processors that are the most innovative equipment in the photogrammetric arena today;
- ♦ mapping and GIS professionals totaling more than 180 with a total of over 1,300 years of combined work experience and an average of over 10 years of experience working together;
- ♦ 30+ years of experience providing the same services as requested to various municipal, county, state, and federal agencies.

LOCATION

The corporate headquarters of Photo Science is located in Lexington, Kentucky. Our principal offices are located at:

Address: 2670 Wilhite Drive
Lexington, Kentucky 40503

Phone: 859-277-8700
FAX: 859-277-8901
Web Page: www.photoscience.com

Our corporate headquarters' facilities currently occupy over 21,000 square feet with some of the most modern equipment used in photogrammetry. We now have seven (7) branch offices; located in Bangor, Maine; Colorado Springs, Colorado; Norcross, Georgia; Orlando and St. Petersburg, Florida; and Bowie, Maryland; and Exton, Pennsylvania.

CORE SERVICES	
Aerial Imaging and Data Collection	Aerial Photography Digital Aerial Imaging LIDAR Terrain Mapping
Photogrammetric Mapping	Aerotriangulation Stereocompilation / Feature Extraction Digital Orthophotography
Geographic Information Systems	Photographic Laboratory / Scanning Data Capture / Conversion Database Design Application Software Development Training
Remote Sensing	3-D Visualization Thematic Mapping Image Processing / Analysis Photointerpretation Change Detection
Surveys	Airborne GPS / IMU GPS Surveys / Geodetic Control Conventional Surveys

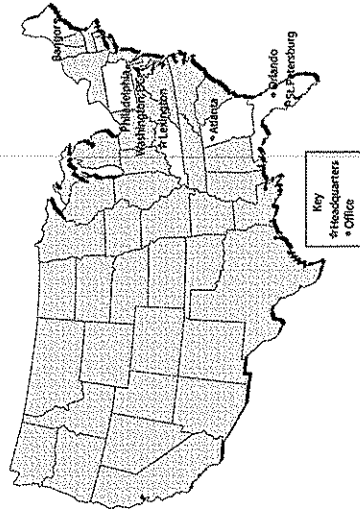

PROJECT STAFFING

G. Michael Ritchie, PE, PLS, PSM, CP is Principal-In-Charge and President of Photo Science. He has over 30 years of transportation engineering, surveying, and computer mapping experience. He has been responsible for many presentations and papers regarding digital base mapping and information mapping for various communities. He is qualified in all areas of technical expertise required for this project. He is a licensed civil engineer in 15 states, a licensed land surveyor in 7 states, and he is a nationally recognized Certified Photogrammetrist. **He is currently licensed in West Virginia as a Professional Engineer (8679) and as a Professional Land Surveyor (1163).**

Other key staff members include:

1. Jack L. Mitchell, PLS, CP Project Manager
2. Marcus G. Penrod, CP Assistant Project Manager
3. Mark E. Meade, PE, PLS, CP Survey Manager
4. Clay D. Smith, PLS, CP Production Manager
5. William R. Mitchell, CP QA/QC Manager
6. Forrest E. Godby, PLS Flight Coordinator

EXPERIENCE

Photo Science has been completing aerial photography and mapping projects since it opened 30 years ago. Our staff has vast experience completing projects with similar requirements to yours. We currently have nine statewide open-end contracts with various Departments of Transportation utilizing the same type services as those requested by the West Virginia Department of Transportation. The table below highlights those contracts and illustrates relative services being provided.

EQUIPMENT

Airworthy Aircraft. Photo Science owns and operates nine FAA-certified aircraft to provide aerial photo missions. Each aircraft is capable of supporting virtually any type of traditional and digital aerial photogrammetric mission and is equipped with airborne Global Positioning Systems (GPS) receivers, Inertial Measurement Units (IMU), Forward-Motion Compensation (FMC), and gyro-stabilized camera mounts.

Traditional and Digital Aerial Photography Acquisition. In support of traditional aerial photo missions, Photo Science offers four USGS tested and calibrated analog photogrammetric cameras. Additionally, Photo Science's state-of-the-art Z/I DMC provides for the direct capture of high-resolution, large-format, multispectral (R,G,B, NIR) aerial imagery. The DMC is the industry's most innovative and precise turnkey digital camera system supporting aerial photogrammetric missions for the broadest range of GIS and remote sensing applications. Photo Science is only one of five firms in the country to own this high-end, large-format digital imaging capability.

	SERVICES							
	Aerial Photography	Mapping & DTMs	Ground Control	Digitized U.S.G.S Quad Maps and DTM	Raster Images	Quality Control	LIDAR	Digital Mapping Camera
Relative Statewide Contracts								
West Virginia DOT (2 contracts)								
	◆	◆	◆	◆	◆	◆	◆	◆
Florida DOT Turnpike Commission	◆	◆	◆	◆	◆	◆	◆	◆
Georgia DOT	◆	◆	◆	◆	◆	◆	◆	◆
Kentucky Transportation Cabinet	◆	◆	◆	◆	◆	◆	◆	◆
Maine DOT	◆	◆	◆	◆	◆	◆	◆	◆
Maryland DOT	◆	◆	◆	◆	◆	◆	◆	◆
South Carolina DOT	◆	◆	◆	◆	◆	◆	◆	◆
Tennessee DOT	◆	◆	◆	◆	◆	◆	◆	◆

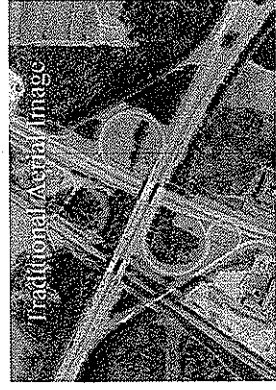
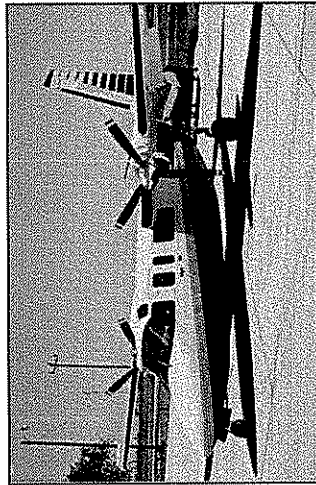
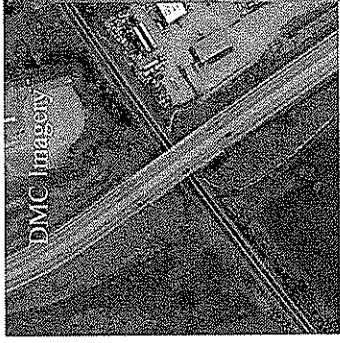

Photo Science's most recent acquisition is the latest in aerial imaging – the Applianx DSS 322. The DSS 322 system is technology engineered to maximize the system's capability in generating high-quality color and color infrared (CIR) digital geospatial imaging products. The DSS is a ready-to-use, directly georeferenced, medium-format, airborne digital camera system.

LIDAR Data Acquisition. Photo Science is an industry leader in the collection and processing of airborne Light Detection and Ranging (LiDAR) information. LiDAR is an active remote sensing system that uses airborne laser scanning technology to emit pulses of light to illuminate the terrain. Photo Science utilizes the latest in LiDAR technology, employing the Leica Geosystems ALS50 II sensor. In addition to acquisition, Photo Science utilizes a variety of technologies to process the acquired, raw LiDAR information—converting ASCII point samplings to finished digital elevation models, surface terrain models, and digital contour products.



Aircraft

Tail Number	1. 840 Turbine Commander	2. 690B Turbine Commander	3. PA-31 Navajo	4. Cessna T-310R	5. Cessna T-210N	6. Cessna T-210N	7. Cessna U-206G	8. Cessna U-206G	9. Cessna U-206H
N910FC	N167R	N101UF	N2737U	N6479Y	N5425A	N7320G	N9471R	N2448G	
Manufacturer	Rockwell International	Piper	Cessna	Cessna	Cessna	Cessna	Cessna	Cessna	Cessna
Engine Configuration	Twin	Twin	Twin	Twin	Single	Single	Single	Single	Single
Turbo Charged	Turbine	Turbine	Yes	Yes	Yes	No	No	No	No
Cruise Speed (knots)	300	270	180	185	160	130	130	130	140
Airborne GPS Equipped	Yes	Yes	Yes	Yes	Yes	Yes	Yes	Yes	Yes
Flight-Management System	Yes	Yes	Yes	Yes	Yes	Yes	Yes	Yes	Yes
Service Ceiling (feet)	34,500	31,000	26,300	27,400	28,500	16,700	16,700	16,700	15,700

Serial Number	Aerial Cameras				Digital Cameras			
	1. Zeiss RMK-TOP-15	2. Zeiss RMK-TOP-15	3. Zeiss LMK-2000	4. Zeiss LMK-1000D	6. Z/I Imaging DMC	7. Z/I Imaging DMC	8. Applanix DSS-322	
144117	Yes	Yes	Yes	Yes	13	33	78	
IMU Unit	No	Yes	Yes	Yes	Yes	Yes	Yes	
Forward-Motion Compensation	Yes	Yes	Yes	Yes	Yes	Yes	N/A	
Gyro-Stabilized Mount	Yes	Yes	Yes	Yes	Yes	Yes	Azimuth Mount	
Dual Magazine	Yes	Yes	Yes	Yes	N/A	N/A	N/A	
Calibration Date	08/28/07	09/30/06	06/21/06	01/03/07	10/04	06/06	01/06	
AWAR	107	100	97	97	N/A	N/A	N/A	
Format	Large	Large	Large	Large	Large	Large	Medium	

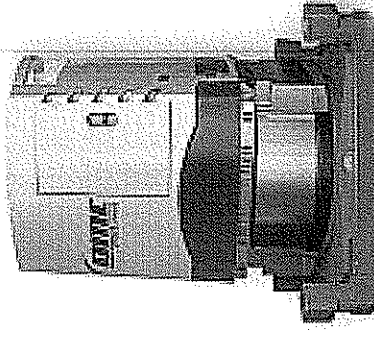

Photo Lab. Photo Science maintains two full-service photographic laboratories for film processing, precision photographic reproductions, enlargements, and color proofing. We own two state-of-the-art Vexcel 4000 high-resolution image scanners, as well as a Z/I PhotoScan 2000 roll-feed, high-resolution image scanner. These scanners represent two of the top scanners in the photogrammetric marketplace today. They are capable of bearing multiple resolutions up to 7.5 microns including 14 microns as specified. Additionally, these scanners can operate as roll-feed or with single or dual film diapositives. In addition, by staffing the lab 24 hours per day during the peak flying seasons (spring and fall), Photo Science is able to maintain direct control of project schedules.

Field Control Surveys. Photo Science performs aerial photography and photogrammetric services over the eastern United States and as such, has completed survey requirements of all types in a variety of locations. We have worked with hundreds of consulting engineers who perform their own control surveys. We have 20 Trimble GPS receivers available immediately for this project including RTK capability. We have complete software including the GeoSurv software for better vertical adjustments and Trimble GP Survey.

Aerotriangulation. Photo Science has complete in-house facilities for analytical triangulation control extension. Our team has performed in-house aerotriangulation to support photogrammetric compilation and orthophoto production for many years. Intergraph ISAT aerotriangulation software is the software package most often utilized by our staff to determine the position and rotation angles of each of the acquired aerial photos and to establish their relationship to the ground.

Stereo Compilation (Digital Data Capture). Photo Science has 34 stereo plotters with experienced staff and computers to assign to this project. We utilize KORK and Atlas mapping software to insure exact project specifications and formatting of data. Our stereo compilation experts are highly experienced providing both large scale (1"=20') and small scale (1"=2,000') planimetric and terrain feature extraction in support of topographic mapping. The scope of our project experience ranges from small, engineering level survey and mapping projects to comprehensive and extensive statewide mapping initiatives. We have performed hundreds of DTM corridor-type projects including CEAL translations for the West Virginia Department of Transportation as well as for a wide variety of consultants.

Interactive Graphics - Photo Science utilizes the latest equipment for data processing and formatting to clients' needs. We utilize software capable of delivery in the several formats. Final ink-on-mylar drawings are produced on Hewlett Packard inkjet drum plotters. Services are available for laser or electrostatic plots.

Digital Terrain Modeling. DTM experience is an everyday occurrence at Photo Science; all of our projects are compiled using DTM techniques. Photo Science uses a combination of breaklines and mass points for a true and accurate Triangulation Irregular Network (TIN) file for contour generation. Photo Science uses the Plus III Terramodel software for contour generation at every stereoplotter for instant on-line quality control checks. In addition, our raw data is easily loaded into our Intergraph "select" system for processing in the "In Roads," "Road Works", or "Engineering Site Package" and "In-Roads Select" as well. We routinely provide this data to clients who use ArcInfo, AutoCAD, Intergraph, and other modeling software systems. We also produce TTN files on our Intergraph ImageStations and have produced this data in ArcInfo, ASCII, CEAL, GeoPak, and Caice formats.

Metric Data. Photo Science has completed several hundred projects requiring data in metric units. All of our equipment can readily fulfill this requirement.

Airborne GPS. Photo Science is a leader in airborne GPS services, using our considerable knowledge and experience to make effective use of this new technology. All of our aircraft are equipped for airborne GPS (ABGPS) and Inertial Measurement Unit (IMU) missions and have undergone rigorous testing to ensure accurate determination of the three-dimensional position of each photographic exposure.

TIME SCHEDULE

Photo Science is committed to assign adequate resources to complete the West Virginia Department of Transportation projects in a timely manner. We would recommend progressive delivery of specific priority projects so as to allow you and your consultants to meet design schedules.

13. PERSONAL HISTORY STATEMENT OF PRINCIPALS AND ASSOCIATES (Furnish complete data but keep to essentials)			
NAME (Last, First, Middle Initial) Adkins, Lonnal Photogrammetrist Photo Lab Manager	YEARS OF EXPERIENCE		
	AS PRINCIPAL IN THIS FIRM 0	AS PRINCIPAL IN OTHER FIRMS 0	OTHER THAN PRINCIPAL >30
EDUCATION (Degree, Year, Specialization) Engineering Studies, 1.5 Years			
MEMBERSHIP IN PROFESSIONAL ORGANIZATIONS ASPRS		REGISTRATION (Type, Year, State) Certified Photogrammetrist: 1985 National	
13. PERSONAL HISTORY STATEMENT OF PRINCIPALS AND ASSOCIATES (Furnish complete data but keep to essentials)			
NAME (Last, First, Middle Initial) Brock, Allen Photogrammetrist Project Manager	YEARS OF EXPERIENCE		
	AS PRINCIPAL IN THIS FIRM 0	AS PRINCIPAL IN OTHER FIRMS 0	OTHER THAN PRINCIPAL 23
EDUCATION (Degree, Year, Specialization)			
MEMBERSHIP IN PROFESSIONAL ORGANIZATIONS ASPRS		REGISTRATION (Type, Year, State) Photogrammetric Surveyor: 2005 SC Certified Photogrammetrist: 1996 National	
13. PERSONAL HISTORY STATEMENT OF PRINCIPALS AND ASSOCIATES (Furnish complete data but keep to essentials)			
NAME (Last, First, Middle Initial) Florence, Gary Photogrammetrist Project Manager	YEARS OF EXPERIENCE		
	AS PRINCIPAL IN THIS FIRM 0	AS PRINCIPAL IN OTHER FIRMS 0	OTHER THAN PRINCIPAL 27
EDUCATION (Degree, Year, Specialization) MS 1980 Remote Sensing / Vegetation Survey; BS 1975 Geography			
MEMBERSHIP IN PROFESSIONAL ORGANIZATIONS N/A		REGISTRATION (Type, Year, State) Photogrammetric Surveyor: 2005 SC Certified Photogrammetrist: 2005 National	

13. PERSONAL HISTORY STATEMENT OF PRINCIPALS AND ASSOCIATES (Furnish complete data but keep to essentials)

NAME (Last, First, Middle Initial) Hickey, Robert Vice President Photogrammetrist	YEARS OF EXPERIENCE		
	AS PRINCIPAL IN THIS FIRM 1	AS PRINCIPAL IN OTHER FIRMS 0	OTHER THAN PRINCIPAL 19
EDUCATION (Degree, Year, Specialization) MS 2001 Business Administration; BS 1983 MIS			

MEMBERSHIP IN PROFESSIONAL ORGANIZATIONS
ASPRS
REGISTRATION (Type, Year, State)
Certified Photogrammetrist: 1997 National

13. PERSONAL HISTORY STATEMENT OF PRINCIPALS AND ASSOCIATES (Furnish complete data but keep to essentials)

NAME (Last, First, Middle Initial) Logan, Douglas Photogrammetrist Digital Orthophoto Specialist	YEARS OF EXPERIENCE		
	AS PRINCIPAL IN THIS FIRM 0	AS PRINCIPAL IN OTHER FIRMS 0	OTHER THAN PRINCIPAL 25
EDUCATION (Degree, Year, Specialization) AS 1982 Electronic Engineering			

MEMBERSHIP IN PROFESSIONAL ORGANIZATIONS
ACSM, ASPRS
REGISTRATION (Type, Year, State)
Professional Land Surveyor: 1999 NC
Photogrammetric Surveyor: 2005 SC
Certified Photogrammetrist: 1997 National

13. PERSONAL HISTORY STATEMENT OF PRINCIPALS AND ASSOCIATES (Furnish complete data but keep to essentials)

NAME (Last, First, Middle Initial) Meade, Mark Vice President Photogrammetrist	YEARS OF EXPERIENCE		
	AS PRINCIPAL IN THIS FIRM 10	AS PRINCIPAL IN OTHER FIRMS 0	OTHER THAN PRINCIPAL 14
EDUCATION (Degree, Year, Specialization) MS 1987 Business Administration; BS 1983 Civil Engineering			

MEMBERSHIP IN PROFESSIONAL ORGANIZATIONS
ACEC, ASPRS, Kentucky Engineering Foundation
REGISTRATION (Type, Year, State)
Professional Engineer: 1987 KY; 1988 WV
Professional Land Surveyor: 1989 KY; 1995 WV; 1997 GA
Photogrammetric Surveyor: 2005 SC
Certified Photogrammetrist: 1997 National

13. PERSONAL HISTORY STATEMENT OF PRINCIPALS AND ASSOCIATES (Furnish complete data but keep to essentials)

NAME (Last, First, Middle Initial) Mitchell, Jack	YEARS OF EXPERIENCE		
Photogrammetrist Project Manager	AS PRINCIPAL IN THIS FIRM 0	AS PRINCIPAL IN OTHER FIRMS 0	OTHER THAN PRINCIPAL >30

EDUCATION (Degree, Year, Specialization)
N/A

MEMBERSHIP IN PROFESSIONAL ORGANIZATIONS
ASPRS
REGISTRATION (Type, Year, State)
Professional Land Surveyor: 1999 NC
Photogrammetric Surveyor: 2005 SC
Certified Photogrammetrist: 1991 National

13. PERSONAL HISTORY STATEMENT OF PRINCIPALS AND ASSOCIATES (Furnish complete data but keep to essentials)

NAME (Last, First, Middle Initial) Mitchell, William	YEARS OF EXPERIENCE		
Photogrammetrist Sr Project Manager	AS PRINCIPAL IN THIS FIRM 0	AS PRINCIPAL IN OTHER FIRMS 0	OTHER THAN PRINCIPAL >30

EDUCATION (Degree, Year, Specialization)
1972 Principles of Photogrammetry; 1967 Advanced Photogrammetry; 1958 - 1960 Civil Engineering

MEMBERSHIP IN PROFESSIONAL ORGANIZATIONS

ASPRS
REGISTRATION (Type, Year, State)
Certified Photogrammetrist: 1992 National

13. PERSONAL HISTORY STATEMENT OF PRINCIPALS AND ASSOCIATES (Furnish complete data but keep to essentials)

NAME (Last, First, Middle Initial) Penrod, Marcus	YEARS OF EXPERIENCE		
Photogrammetrist Project Manager	AS PRINCIPAL IN THIS FIRM 0	AS PRINCIPAL IN OTHER FIRMS 0	OTHER THAN PRINCIPAL >30

EDUCATION (Degree, Year, Specialization)
N/A

MEMBERSHIP IN PROFESSIONAL ORGANIZATIONS

ASPRS
REGISTRATION (Type, Year, State)
Certified Photogrammetrist: 1998 National

13. PERSONAL HISTORY STATEMENT OF PRINCIPALS AND ASSOCIATES (Furnish complete data but keep to essentials)

NAME (Last, First, Middle Initial) **Ricks, Keith** YEARS OF EXPERIENCE
Photogrammetrist | Digital Orthophoto Specialist AS PRINCIPAL IN THIS FIRM 0 AS PRINCIPAL IN OTHER FIRMS 0 OTHER THAN PRINCIPAL 28

EDUCATION (Degree, Year, Specialization)
N/A

MEMBERSHIP IN PROFESSIONAL ORGANIZATIONS
ASPRS REGISTRATION (Type, Year, State)
Professional Land Surveyor: 1999 NC
Certified Photogrammetrist: 1997 National

13. PERSONAL HISTORY STATEMENT OF PRINCIPALS AND ASSOCIATES (Furnish complete data but keep to essentials)

NAME (Last, First, Middle Initial) **Ritchie, G. Michael** YEARS OF EXPERIENCE
President | Principal-In-Charge | Photogrammetrist AS PRINCIPAL IN THIS FIRM 17 AS PRINCIPAL IN OTHER FIRMS 13 OTHER THAN PRINCIPAL 8

EDUCATION (Degree, Year, Specialization)
BS 1972 Civil Engineering

MEMBERSHIP IN PROFESSIONAL ORGANIZATIONS
ACEC, ACSM, ASCE, ASPRS, GITA, KSPE, MAPPS, NSPE, PEPP, SAME, TAPS REGISTRATION (Type, Year, State)
Professional Engineer: 1979 AL; 2000 CO; 1998 FL; 1999 GA; 2000 IL; 1974 KY; 1979 LA; 1979 MS; 1980 MO; 1978 NC; 2000 OH; 2000 PA; 1998 SC; 1979 TN; 1971 WV
Professional Land Surveyor: 1981 AL; 1974 KY; 1979 MS; 1979 NC; 1995 WV; 2001 FL-PSM
Certified Photogrammetrist: 1997 National

13. PERSONAL HISTORY STATEMENT OF PRINCIPALS AND ASSOCIATES (Furnish complete data but keep to essentials)

NAME (Last, First, Middle Initial) **Shillenn, Michael** YEARS OF EXPERIENCE
Photogrammetrist | Project Manager AS PRINCIPAL IN THIS FIRM 0 AS PRINCIPAL IN OTHER FIRMS 0 OTHER THAN PRINCIPAL 20

EDUCATION (Degree, Year, Specialization)
BS 1987 Geography

MEMBERSHIP IN PROFESSIONAL ORGANIZATIONS
ASPRS REGISTRATION (Type, Year, State)
Certified Photogrammetrist: 1997 National

13. PERSONAL HISTORY STATEMENT OF PRINCIPALS AND ASSOCIATES (Furnish complete data but keep to essentials)			
NAME (Last, First, Middle Initial) Smith, Clay Photogrammetrist Production Manager	YEARS OF EXPERIENCE		
	AS PRINCIPAL IN THIS FIRM 0	AS PRINCIPAL IN OTHER FIRMS 0	OTHER THAN PRINCIPAL 29
EDUCATION (Degree, Year, Specialization) AS 1986 Photogrammetry			
MEMBERSHIP IN PROFESSIONAL ORGANIZATIONS ASPRS REGISTRATION (Type, Year, State) Professional Land Surveyor: 1999 NC Photogrammetric Surveyor: 2005 SC Certified Photogrammetrist: 1994 National			
13. PERSONAL HISTORY STATEMENT OF PRINCIPALS AND ASSOCIATES (Furnish complete data but keep to essentials)			
NAME (Last, First, Middle Initial) Smothers, Jerry Photogrammetrist Flight Coordinator	YEARS OF EXPERIENCE		
	AS PRINCIPAL IN THIS FIRM 0	AS PRINCIPAL IN OTHER FIRMS 0	OTHER THAN PRINCIPAL >30
EDUCATION (Degree, Year, Specialization) 1989 Pre-Engineering			
MEMBERSHIP IN PROFESSIONAL ORGANIZATIONS ASPRS REGISTRATION (Type, Year, State) Certified Photogrammetrist: 1991 National			
13. PERSONAL HISTORY STATEMENT OF PRINCIPALS AND ASSOCIATES (Furnish complete data but keep to essentials)			
NAME (Last, First, Middle Initial) Veit, Jacob Photogrammetrist	YEARS OF EXPERIENCE		
	AS PRINCIPAL IN THIS FIRM 0	AS PRINCIPAL IN OTHER FIRMS 0	OTHER THAN PRINCIPAL >30
EDUCATION (Degree, Year, Specialization) N/A			
MEMBERSHIP IN PROFESSIONAL ORGANIZATIONS ASPRS REGISTRATION (Type, Year, State) Certified Photogrammetrist: 1984 National			

14. PROVIDE A LIST OF SOFTWARE AND EQUIPMENT AVAILABLE IN THE PRIMARY OFFICE WHICH WILL BE USED TO COMPLETE AML DESIGN SERVICES

SEE ENCLOSED EQUIPMENT LIST.

15. CURRENT ACTIVITIES ON WHICH YOUR FIRM IS THE DESIGNATED ENGINEER OF RECORD

PROJECT NAME, TYPE AND LOCATION & NATURE OF RESPONSIBILITY	NAME AND ADDRESS OF OWNER	ESTIMATED FEES (as of 11/30/07)	PERCENT COMPLETE
<ul style="list-style-type: none"> ➤ Aerial Photography for Photogrammetric Mapping ➤ Mapping Services & Related Svcs Statewide - West Virginia 	West Virginia Department of Transportation 1900 Kanawha Boulevard, East Charleston, WV 25305	\$246,811.00	On-Going
Aerial Photography & Related Svcs Statewide - Florida	Florida Department of Transportation 605 Suwannee Street Tallahassee, FL 32399	\$374,712.00	On-Going
Photogrammetric Mapping Statewide - Florida	Florida Turnpike Enterprise PO Box 9828 Ft. Lauderdale, FL 33310	\$159,033.00	On-Going
Aerial Photography & Related Svcs Various Counties	Florida Department of Revenue 725 South Calhoun Street Tallahassee, FL 32399	\$153,359.00	On-Going
Aerial & Photogrammetric Svcs Statewide - Kentucky	Kentucky Transportation Cabinet 501 High Street, Room 908 Frankfort, KY 40622	\$856,718.00	On-Going
Aerial Photography & Related Svcs Statewide - Maine	Maine Department of Transportation 16 State House Station Augusta, ME 04333	\$47,406.00	On-Going
Photogrammetric Services Statewide - South Carolina	South Carolina Department of Transportation 955 Park Street, Room 425 Columbia, SC 29216	\$19,800.00	On-Going
Aerial Photogrammetry, Reconnaissance, Mapping, & Related Services Statewide - Tennessee	Tennessee Department of Transportation 521 Olen Tayler Drive Nashville, TN 37217	\$40,202.00	On-Going
Photogrammetric Mapping And Aerial Photography Huntington District Boundaries	USACE Huntington District 502 Eighth Street Huntington, WV 25701	\$30,727.00	On-Going
Photogrammetric Mapping And Aerial Photography Nashville District Boundaries	USACE Nashville District 801 Broadway Nashville, TN 37202	\$150,000.00	On-Going
Photogrammetric Mapping And Aerial Photography Pittsburgh District Boundaries	USACE Pittsburgh District 1000 Liberty Avenue Pittsburgh, PA 15222	\$313,867.00	On-Going

15. CURRENT ACTIVITIES ON WHICH YOUR FIRM IS THE DESIGNATED ENGINEER OF RECORD

PROJECT NAME, TYPE AND LOCATION & NATURE OF RESPONSIBILITY	NAME AND ADDRESS OF OWNER	ESTIMATED FEES (as of 11/30/07)	PERCENT COMPLETE
NAIP & PSU Services Various Locations	USDA Farm Service Agency 2222 W. 2300 Street Salt Lake City, UT 84119	\$1,619,421.00	On-Going
GIS Services Various Locations	USDA Forest Service 2222 W. 2300 Street Salt Lake City, UT 84119	\$494,303.00	On-Going
Photogrammetric & Mapping Sciences Various Locations	USGS 1400 Independence Road Rolla, MO 65401	\$821,581.00	On-Going
Aerial Photography & Related Svcs Charleston, West Virginia	Charleston Sanitary Board 208 26th Street Charleston, WV 25324	\$219,790.00	On-Going
Aerial Photography & Related Svcs Cherokee County, Georgia	Cherokee County Government 90 North Street Canton, GA 30114	\$43,950.00	On-Going
Aerial Photography & Related Svcs Coweta County, Georgia	Coweta County Board of Commissioners 22 East Broad Street Newnan, GA 30263	\$249,500.00	On-Going
Aerial Photography & Related Svcs Henry County, Georgia	Henry County Board of Commissioners 140 Henry Parkway McDonough, GA 30523	\$245,000.00	On-Going
Miscellaneous Surveying & Mapping Hillsborough County, Florida	Hillsborough County Board of Commissioners P. O. Box 1110 Tampa, FL 33601	\$68,195.00	On-Going
Digital Orthophotography Newton County, Georgia	Newton County Board of Commissioners 113 Usher Street Covington, GA 30014	\$103,300.00	On-Going
Aerial Photography & Related Svcs Campbell & Kenton Counties, Kentucky	Northern KY Area Planning Commission 2332 Royal Drive Ft. Mitchell, KY 41017	\$103,090.00	On-Going
Aerial Photography & Related Svcs Various Locations	R.J. Corman Railroad Group, LLC P.O. Box 788 Nicholasville, KY 40340	\$171,260.00	On-Going

15. CURRENT ACTIVITIES ON WHICH YOUR FIRM IS THE DESIGNATED ENGINEER OF RECORD

PROJECT NAME, TYPE AND LOCATION & NATURE OF RESPONSIBILITY	NAME AND ADDRESS OF OWNER	ESTIMATED FEES (as of 11/30/07)	PERCENT COMPLETE
Aerial Seagrass Mapping Tarpon Springs south to Boca Grande, Florida	Southwest Florida Water Management District 2379 Broad Street Brooksville, FL 34604	\$132,855.00	On-Going
Aerial Photography & Related Svcs Various Locations	Colonial Pipeline Company 945 East Paces Ferry Rd Atlanta, GA 30326	\$134,023.00	On-Going
Aerial Photography & Related Svcs Various Locations	Columbia Gas Transmission Corporation 1700 MacCorkle Avenue Charleston, WV 25314	\$491,395.00	On-Going
GIS Program Various Locations	Dalton Utilities 1200 VD Parrott Jr Pkwy Dalton, GA 30722	\$8,990.00	On-Going
Aerial Photography & Related Svcs Various Locations	Duke Energy 5400 Westheimer Court Houston, TX 77056	\$219,338.00	On-Going
Aerial Photography & Related Svcs Kentucky	East Kentucky Power Cooperative 4775 Lexington Road Winchester, KY 40391	\$19,445.00	On-Going
Aerial Photography & Related Svcs Various Locations	El Paso Energy 1001 Louisiana Street Houston, TX 77002	\$962,320.00	On-Going
Aerial Photography & Related Svcs Thomas Ranch Mapping	Fourth Quarter Properties 211 N. Main Street, Suite 201 Alpharetta, GA 30004	\$224,800.00	On-Going
Aerial Photography & Related Svcs Various Locations	Georgia Power Company 241 Ralph McGill Boulevard NE Atlanta, GA 30308	\$279,200.00	On-Going
GIS Program Various Locations	Georgia Transmission Corporation 2100 East Exchange Place Tucker, GA 30084	\$5,361,140.00	On-Going
Aerial Photography & Related Svcs Lexington, Kentucky	Kentucky Utilities One Quality Street Lexington, KY 40507	\$55,508.00	On-Going

15. CURRENT ACTIVITIES ON WHICH YOUR FIRM IS THE DESIGNATED ENGINEER OF RECORD			
PROJECT NAME, TYPE AND LOCATION & NATURE OF RESPONSIBILITY	NAME AND ADDRESS OF OWNER	ESTIMATED FEES (as of 11/30/07)	PERCENT COMPLETE
Aerial Photography & Related Svcs Various Locations	Southern Union Panhandle 5444 Westheimer Road Houston, TX 77056	\$160,945.00	On-Going
Aerial Photography & Related Svcs Various Locations	Texas Gas Transmission, LLC 3800 Frederica Street Owensboro, KY 42301	\$321,529.00	On-Going
TOTAL NUMBER PROJECTS: 38		TOTAL ESTIMATED FEES: \$17,164,542.00	

NOTE: These are various projects Photo Science is currently working on; we perform services for hundreds of projects at a given time.

16. CURRENT ACTIVITIES ON WHICH YOUR FIRM IS SERVING AS A SUB-CONSULTANT TO OTHERS

PROJECT NAME, TYPE AND LOCATION	NATURE OF FIRMS RESPONSIBILITY	NAME AND ADDRESS OF OWNER	ESTIMATED COMPLETION DATE	ESTIMATED CONSTRUCTION COST	
				ENTIRE PROJECT	YOUR FIRMS RESPONSIBILITY
Various Projects & Locations	Aerial Photography & Related Svcs	Various, Sub to: American Engineers, PLC	Unknown	Unknown	\$14,575.00
Various Projects & Locations	Aerial Photography & Related Svcs	Various, Sub to: Arcadis Geraghty & Miller	Unknown	Unknown	\$100,541.00
Various Projects & Locations	Aerial Photography & Related Svcs	Various, Sub to: Carter & Burgess	Unknown	Unknown	\$51,793.00
Various Projects & Locations	Aerial Photography & Related Svcs	Various, Sub to: Carter & Sloope Consulting Engineers	Unknown	Unknown	\$37,455.00
Various Projects & Locations	Aerial Photography & Related Svcs	Various, Sub to: Hatch Mott MacDonald	Unknown	Unknown	\$64,635.00
Various Projects & Locations	Aerial Photography & Related Svcs	Various, Sub to: HNTB Corporation	Unknown	Unknown	\$25,290.00
Various Projects & Locations	Aerial Photography and Related Services	Various, Sub to: Infotech Enterprises America	Unknown	Unknown	\$76,252.00
Various Projects & Locations	Aerial Photography & Related Svcs	Various, Sub to: Kisinger Campo & Associates	Unknown	Unknown	\$70,962.00
Various Projects & Locations	Aerial Photography & Related Svcs	Various, Sub to: SAM, Inc.	Unknown	Unknown	\$89,037.00
Various Projects & Locations	Aerial Photography & Related Svcs	Various, Sub to: Thomas & Hutton Engineering	Unknown	Unknown	\$60,780.00
TOTAL NUMBER PROJECTS: 10				TOTAL ESTIMATED FEES: \$591,320.00	

NOTE: These are various projects Photo Science is currently working on; we perform services for hundreds of projects at a given time.

17. COMPLETED WORK WITHIN LAST 5 YEARS ON WHICH YOUR FIRM WAS THE DESIGNATED ENGINEER OF RECORD

PROJECT NAME, TYPE AND LOCATION	NAME AND ADDRESS OF OWNER	ESTIMATED CONSTRUCTION COST FEE	YEAR	CONSTRUCTED (YES OR NO)
<ul style="list-style-type: none"> ➤ Aerial Photography for Photogrammetric Mapping ➤ Mapping Services & Related Svcs Statewide - West Virginia Statewide Since 1992 	West Virginia Department of Transportation 1900 Kanawha Boulevard, East Charleston, WV 25305	\$432,292.00 \$229,473.00 \$305,000.00 \$184,000.00 \$676,000.00	2006 2005 2004 2003 2002	Unknown
Photogrammetric Mapping Statewide - Florida	Florida DOT 605 Suwannee Street, MS 20 Tallahassee, FL 32399-6544	\$106,925.00 \$42,718.00	2006 2005	Unknown
Aerial & Photogrammetric Services Statewide - Kentucky Since 1981	Kentucky Transportation Cabinet 501 High Street, Room 908 Frankfort, KY 40622	\$484,846.00 \$135,445.00 \$101,000.00 \$681,000.00 \$1,921,000.00	2006 2005 2004 2003 2002	Unknown
Survey & Mapping Services Statewide - Maine Since 2000	Maine DOT 16 State House Station Augusta, ME 04333	\$96,899.00 \$57,150.00 \$13,000.00 \$3,000.00	2006 2005 2003 2002	Unknown
Photogrammetric Services Statewide - South Carolina Since 2002	South Carolina DOT 955 Park Street, Room 425 Columbia, SC 29216	\$192,364.00 \$77,550.00 \$243,000.00 \$150,000.00	2006 2005 2004 2003	Unknown
Aerial Photogrammetry, Reconnaissance, Mapping, & Related Services Statewide - Tennessee Since 1996	Tennessee DOT 521 Olen Taylor Drive Nashville, TN 37217	\$60,003.00 \$163,625.00 \$44,000.00 \$25,000.00 \$64,000.00	2006 2005 2004 2003 2002	Unknown
Aerial Photography & Related Svcs Baldwin County, Alabama	Baldwin County Government 175 Courthouse Square Bay Minette, AL 36507	\$71,213.00 \$112,828.44	2006 2005	Unknown
Photogrammetric Base Mapping Bartow County, Georgia	Bartow County Government 135 West Cherokee Avenue Cartersville, GA 30120	\$97,750.00 \$392,250.00	2006 2005	Unknown
Aerial Photography & Related Svcs Charleston, West Virginia	Charleston Sanitary Board 208 26 th Street Charleston, WV 25324	\$109,479.00	2006	Unknown
Aerial Photography & Related Svcs Reading, Pennsylvania	City of Reading, PA 815 Washington Street Reading, PA 19601	\$128,321.00 \$157,939.00	2006 2005	Unknown

17. COMPLETED WORK WITHIN LAST 5 YEARS ON WHICH YOUR FIRM WAS THE DESIGNATED ENGINEER OF RECORD

PROJECT NAME, TYPE AND LOCATION	NAME AND ADDRESS OF OWNER	ESTIMATED CONSTRUCTION COST FEE	YEAR	CONSTRUCTED (YES OR NO)
Aerial Photography & Related Svcs Various Locations	Colonial Pipeline Company 945 East Paces Ferry Rd Atlanta, GA 30326	\$719,032.00 \$872,562.00 \$250,000.00 \$76,000.00	2006 2005 2004 2002	Unknown
Aerial Photography & Related Svcs Various Locations	Columbia Gas Transmission Corporation 1700 MacCorkle Avenue Charleston, WV 25314	\$1,295,577.00 \$414,799.00 \$487,000.00 \$373,000.00 \$481,000.00	2006 2005 2004 2003 2002	Unknown
Aerial Photography & Related Svcs Various Locations	Dalton Utilities 1200 VD Parrott Jr Pkwy Dalton, GA 30722	\$30,000.00 \$283,704.00 \$147,000.00 \$118,000.00 \$152,000.00	2006 2005 2004 2003 2002	Unknown
Aerial Photography & Related Svcs Various Locations	Duke Energy 5400 Westheimer Court Houston, TX 77056	\$309,222.00 \$30,130.00 \$334,000.00 \$468,000.00 \$861,000.00	2006 2005 2004 2003 2002	Unknown
Aerial Photography & Related Svcs Kentucky	East Kentucky Power Cooperative 4775 Lexington Road Winchester, KY 40391	\$205,365.00 \$344,894.00	2006 2005	Unknown
Aerial Photography & Related Svcs Various Locations	El Paso Energy 1001 Louisiana Street Houston, TX 77002	\$839,640.00 \$1,046,359.00 \$249,000.00 \$640,000.00 \$917,000.00	2006 2005 2004 2003 2002	Unknown
Aerial Photography & Related Svcs Various Locations	Georgia Transmission Corporation 2100 East Exchange Place Tucker, Georgia 30084	\$3,890,620.00 \$2,976,417.00 \$4,597,000.00 \$3,212,000.00 \$4,881,000.00	2006 2005 2004 2003 2002	Unknown
Miscellaneous Surveying & Mapping Hillsborough County, Florida	Hillsborough County Board of Commissioners P. O. Box 1110 Tampa, FL 33601	\$76,605.00 \$223,496.00 \$261,000.00 \$204,000.00	2006 2005 2004 2003	Unknown

17. COMPLETED WORK WITHIN LAST 5 YEARS ON WHICH YOUR FIRM WAS THE DESIGNATED ENGINEER OF RECORD

PROJECT NAME, TYPE AND LOCATION	NAME AND ADDRESS OF OWNER	ESTIMATED CONSTRUCTION COST FEE	YEAR	CONSTRUCTED (YES OR NO)
Aerial Photography & Related Svcs Lexington, Kentucky	Kentucky Utilities One Quality Street Lexington, KY 40507	\$337,814.00 \$562,852.00	2006 2005	Unknown
Digital Orthophotography Newton County, Georgia	Newton County Board of Commissioners 113 Usher Street Covington, GA 30014	\$167,330.00 \$62,000.00 \$89,000.00 \$566,000.00	2006 2005 2004 2003	Unknown
Science & Technology Contract Miami-Dade and Broward County, Florida	South Florida Water Management District 3301 Gun Club Road West Palm Beach, FL 33406	\$294,976.00 \$317,911.00	2006 2005	Unknown
Aerial Photography & Related Svcs Various Sites	Southern Star Central Gas Pipeline, Inc. 3800 Frederica Street Owensboro, KY 42301	\$233,009.00 \$220,745.00 \$184,000.00 \$232,000.00	2006 2005 2004 2003	Unknown
Aerial Photography & Related Svcs Various Sites	Texas Gas Transmission LLC 3800 Frederica Street Owensboro, KY 42302	\$315,440.00 \$213,694.00 \$148,000.00	2006 2005 2003	Unknown
IDC Contract for Photogrammetric Mapping And Aerial Photography St. Louis District Boundaries	USACE St. Louis District 1222 Spruce Street St. Louis, MO 63103-2833	\$302,941.00 \$290,000.00	2006 2005	Unknown
NAIP and PSU Services Various Sites	USDA Farm Service Agency 2222 W. 2300 Street Salt Lake City, UT 84119	\$1,490,605.00 \$1,017,663.00 \$917,000.00 \$470,000.00	2006 2005 2004 2003	Unknown
GIS Services Various Sites	USDA Forest Service 2222 W. 2300 Street Salt Lake City, UT 84119	\$588,894.00 \$958,381.00 \$3,462,000.00	2006 2005 2004	Unknown
Photogrammetric & Mapping Sciences Svcs Various Sites	USGS 1400 Independence Road Rolla, MO 65401	\$1,635,019.00 \$1,412,078.00	2006 2005	Unknown
Aerial Photography & Related Svcs Georgia and Florida Sites	Florida Rock Industries 700 Palmetto Street Jacksonville, FL 32202	\$195,443.00 \$127,000.00 \$157,000.00	2005 2004 2003	Unknown

17. COMPLETED WORK WITHIN LAST 5 YEARS ON WHICH YOUR FIRM WAS THE DESIGNATED ENGINEER OF RECORD

PROJECT NAME, TYPE AND LOCATION	NAME AND ADDRESS OF OWNER	ESTIMATED CONSTRUCTION COST FEE	YEAR	CONSTRUCTED (YES OR NO)
Aerial Photography & Related Svcs Georgetown, Kentucky	Georgetown / Scott County Planning Commission 101 E. Main Street Georgetown, KY 40324	\$220,708.00	2005	Unknown
Mapping Program Orange County, Florida	Orange County Government 4200 South John Young Parkway Orlando, FL 32839	\$376,667.00	2005	Unknown
Aerial Photography & Related Svcs Roanoke County, Virginia	Roanoke County Government P.O. Box 29800 Roanoke, VA 24018-0798	\$290,142.00 \$364,510.00	2005 2004	Unknown
Aerial Photography & Related Svcs Various Locations	Tennessee Valley Authority 1101 Market Street Chattanooga, TN 37402	\$9,944.00 \$111,000.00	2005 2003	Unknown
IDC Contract for Photogrammetry and Related Services Huntington District Boundaries	USACE Huntington District 502 Eighth Street Huntington, WV 25701	\$479,055.00 \$577,000.00 \$176,000.00 \$81,000.00	2005 2004 2003 2002	Unknown
IDC for Surveying and Mapping Louisville District Boundaries	USACE Louisville District 600 M.L. King, Jr., Pl., Room 821 Louisville, KY 40202-2230	\$2,064.00 \$243,000.00 \$454,000.00 \$777,000.00	2005 2004 2003 2002	Unknown
Developing & Populating a Graphical Interactive Database, Survey Engineering, Mapping, & Related Svcs Memphis District Boundaries	USACE Memphis District 167 N. Main Street, B202 Memphis, TN 38103-1894	\$122,791.00	2005	Unknown
Aerial Photography & Related Svcs City of Paducah and McCracken County, Kentucky	City of Paducah, Kentucky 300 South Fifth Street Paducah, KY 42002	\$29,000.00 \$482,000.00	2004 2003	Unknown
Digital Orthophotography Henry County, Georgia	Henry County Purchasing Department 140 Henry Parkway McDonough, GA 30253	\$18,000.00 \$206,000.00	2004 2003	Unknown
Surveying and Mapping Services Wilmington District Boundaries	USACE Wilmington District 69 Darlington Avenue Wilmington, NC 28403	\$15,000.00 \$180,000.00 \$296,000.00	2004 2003 2002	Unknown
Aerial Photography & Related Svcs Various Locations	Williams Natural Gas Company One Williams Center Tulsa, OK 74101	\$364,000.00	2002	Unknown

17. COMPLETED WORK WITHIN LAST 5 YEARS ON WHICH YOUR FIRM WAS THE DESIGNATED ENGINEER OF RECORD

PROJECT NAME, TYPE AND LOCATION	NAME AND ADDRESS OF OWNER	ESTIMATED CONSTRUCTION COST FEE	YEAR	CONSTRUCTED (YES OR NO)
Aerial Photography & Related Svcs Elizabethtown, Kentucky	City of Elizabethtown, Kentucky 200 West Dixie Avenue Elizabethtown, KY 42701	\$86,000.00 \$61,000.00 \$20,000.00 \$1,000.00 \$18,000.00	2003 2002 2001 1998 1997	Unknown
Aerial Photography & Related Svcs Jasper, Indiana and Surrounding Area	City of Jasper, Indiana 610 Main Street Jasper, IN 47547	\$30,000.00 \$7,000.00	2003 2002	Unknown

18. COMPLETED WORK WITHIN LAST 5 YEARS ON WHICH YOUR FIRM HAS BEEN A SUB-CONSULTANT TO OTHER FIRMS (INDICATE PHASE OF WORK FOR WHICH YOUR FIRM WAS RESPONSIBLE)

PROJECT NAME, TYPE AND LOCATION	NAME AND ADDRESS OF OWNER	ESTIMATED CONSTRUCTION COST OF YOUR FIRM'S PORTION	YEAR	CONSTRUCTED (YES OR NO)	FIRM ASSOCIATED WITH
Aerial Photography & Related Svcs Various Projects and Locations	Various Projects	\$10,526.00 10,610.00 12,920.00	2006 2004 2002	Unknown	Aero-Metric
Aerial Photography & Related Svcs Various Projects and Locations	Various Projects	\$12,885.00 \$14,019.00 \$7,540.00 \$1,200.00 \$19,735.00	2006 2005 2004 2003 2002	Unknown	Alpha Associates, Inc.
Aerial Photography & Related Svcs Various Projects and Locations	Various Projects	\$10,244.00 \$152,431.00 \$1,572.00	2006 2004 2003	Unknown	American Consulting Engineers
Aerial Photography & Related Svcs Various Projects and Locations	Various Projects	\$9,852.00 \$21,620.00 \$8,635.00 \$30,235.00 \$5,823.00	2006 2005 2004 2003 2002	Unknown	American Engineers
Aerial Photography & Related Svcs Various Projects and Locations	Various Projects	\$276,134.00 \$387,787.00 \$145,531.00 \$141,104.00 \$156,767.00	2006 2005 2004 2003 2002	Unknown	Arcadis Geraghty & Miller
Aerial Photography & Related Svcs Various Projects and Locations	Various Projects	\$1,003,105.00 \$494,813.00 \$2,187,183.00	2006 2005 2004	Unknown	Autometric
Aerial Photography & Related Svcs Various Projects and Locations	Various Projects	\$2,066,545.00 \$739,320.00 \$304,826.00 \$349,550.00	2006 2005 2004 2003	Unknown	BAE Systems ADR
Aerial Photography & Related Svcs Various Projects and Locations	Various Projects	\$5,605.00 \$99,613.00 \$14,493.00	2006 2003 2002	Unknown	Burgess & Niple

18. COMPLETED WORK WITHIN LAST 5 YEARS ON WHICH YOUR FIRM HAS BEEN A SUB-CONSULTANT TO OTHER FIRMS (INDICATE PHASE OF WORK FOR WHICH YOUR FIRM WAS RESPONSIBLE)

PROJECT NAME, TYPE AND LOCATION	NAME AND ADDRESS OF OWNER	ESTIMATED CONSTRUCTION COST OF YOUR FIRM'S PORTION	YEAR	CONSTRUCTED (YES OR NO)	FIRM ASSOCIATED WITH
Aerial Photography & Related Svcs Various Projects and Locations	Various Projects	\$27,870.00 \$20,500.00 \$188,700.00 \$50,450.00 \$49,650.00	2006 2005 2004 2003 2002	Unknown	Carter & Sloope Consulting Eng
Aerial Photography & Related Svcs Various Projects and Locations	Various Projects	\$20,955.00 \$59,641.00 \$32,740.00 \$7,222.00 \$395.00	2006 2005 2004 2003 2002	Unknown	CDP Engineers, Inc.
Aerial Photography & Related Svcs Various Projects and Locations	Various Projects	\$21,069.00 \$7,250.00 \$3,700.00 \$7,478.00 \$10,600.00	2006 2005 2004 2003 2002	Unknown	CH2M Hill
Aerial Photography & Related Svcs Various Projects and Locations	Various Projects	\$16,012.00 \$4,100.00 \$60,083.00 \$25,938.00	2006 2005 2004 2003	Unknown	Day Wilburn Associates
Aerial Photography & Related Svcs Various Projects and Locations	Various Projects	\$30,973.00 \$9,797.00 \$77,495.00 \$41,021.00	2006 2005 2004 2002	Unknown	Dunn Engineers
Aerial Photography & Related Svcs Various Projects and Locations	Various Projects	\$22,900.00 \$21,307.00 \$19,343.00 \$16,368.00 \$40,372.00	2006 2005 2004 2003 2002	Unknown	E. L. Robinson Engineering
Aerial Photography & Related Svcs Various Projects and Locations	Various Projects	\$17,610.00 \$8,400.00 \$5,220.00 \$8,205.00 \$11,285.00	2006 2005 2004 2003 2002	Unknown	Eagle Engineers

18. COMPLETED WORK WITHIN LAST 5 YEARS ON WHICH YOUR FIRM HAS BEEN A SUB-CONSULTANT TO OTHER FIRMS (INDICATE PHASE OF WORK FOR WHICH YOUR FIRM WAS RESPONSIBLE)

PROJECT NAME, TYPE AND LOCATION	NAME AND ADDRESS OF OWNER	ESTIMATED CONSTRUCTION COST OF YOUR FIRM'S PORTION	YEAR	CONSTRUCTED (YES OR NO)	FIRM ASSOCIATED WITH
Aerial Photography & Related Svcs Various Projects and Locations	Various Projects	\$18,991.00 \$2,720.00 \$1,970.00 \$2,125.00	2006 2005 2004 2003	Unknown	Fuller Mossbarger Scott & May Eng
Aerial Photography & Related Svcs Various Projects and Locations	Various Projects	\$74,581.00 \$7,000.00 \$18,000.00 \$5,450.00 \$120,492.00	2006 2005 2004 2003 2002	Unknown	Gresham Smith & Partners
Aerial Photography & Related Svcs Various Projects and Locations	Various Projects	\$14,529.00 \$130,758.00 \$14,779.00 \$118,596.00 \$77,086.00	2006 2005 2003 2000 1997	Unknown	H.W. Lochner Engineers
Aerial Photography & Related Svcs Various Projects and Locations	Various Projects	\$85,500.00 \$20,100.00 \$182,573.00 \$49,860.00	2006 2005 2004 2003	Unknown	Hatch Mott MacDonald
Aerial Photography & Related Svcs Various Projects and Locations	Various Projects	\$19,822.00 \$1,187.00 \$19,951.00	2006 2005 2003	Unknown	HDR Engineering
Aerial Photography & Related Svcs Various Projects and Locations	Various Projects	\$45,300.00 \$13,200.00 \$700.00 \$13,250.00 \$20,050.00	2006 2005 2004 2003 2002	Unknown	Highland Engineering
Aerial Photography & Related Svcs Various Projects and Locations	Various Projects	\$13,588.00	2006	Unknown	HMB, Inc.
Aerial Photography & Related Svcs Various Projects and Locations	Various Projects	\$213,105.00 \$28,333.00 \$41,298.00	2006 2005 2004	Unknown	HNTB Corporation
Aerial Photography & Related Svcs Various Projects and Locations	Various Projects	\$12,254.00 \$89,260.00	2006 2005	Unknown	J.B. Trimble & Associates
Aerial Photography & Related Svcs Various Projects and Locations	Various Projects	\$121,083.00 \$180,246.21 \$344,069.00 \$17,400.00	2006 2005 2004 2002	Unknown	Jordan Jones & Goulding

18. COMPLETED WORK WITHIN LAST 5 YEARS ON WHICH YOUR FIRM HAS BEEN A SUB-CONSULTANT TO OTHER FIRMS (INDICATE PHASE OF WORK FOR WHICH YOUR FIRM WAS RESPONSIBLE)

PROJECT NAME, TYPE AND LOCATION	NAME AND ADDRESS OF OWNER	ESTIMATED CONSTRUCTION COST OF YOUR FIRM'S PORTION	YEAR	CONSTRUCTED (YES OR NO)	FIRM ASSOCIATED WITH
Aerial Photography & Related Svcs Various Projects and Locations	Various Projects	\$12,555.00	2006	Unknown	KBM, Inc.
		\$7,040.00	2005		
		\$8,160.00	2004		
		\$50,352.00	2003		
		\$42,300.00	2002		
Aerial Photography & Related Svcs Various Projects and Locations	Various Projects	\$255,782.00	2006	Unknown	Keck & Wood, Inc.
		\$62,800.00	2005		
Aerial Photography & Related Svcs Various Projects and Locations	Various Projects	\$54,865.00	2006	Unknown	Kenviron, Inc.
		\$52,161.00	2005		
		\$41,972.00	2004		
		\$49,261.00	2003		
		\$68,482.00	2002		
Aerial Photography & Related Svcs Various Projects and Locations	Various Projects	\$2,825.00	2006	Unknown	Leo Miller & Associates
		\$15,879.00	2004		
		\$6,687.00	2002		
Aerial Photography & Related Svcs Various Projects and Locations	Various Projects	\$13,777.00	2006	Unknown	Lowe Engineers
		\$28,209.00	2005		
		\$74,471.00	2004		
		\$58,074.00	2002		
Aerial Photography & Related Svcs Various Projects and Locations	Various Projects	\$3,681.00	2006	Unknown	McGee Partners
		\$159,254.00	2004		
Aerial Photography & Related Svcs Various Projects and Locations	Various Projects	\$24,600.00	2006	Unknown	Michael Baker Jr., Inc.
		\$262,307.00	2005		
		\$96,082.00	2002		
Aerial Photography & Related Svcs Various Projects and Locations	Various Projects	\$24,499.00	2006	Unknown	Monarch Engineering
		\$9,972.00	2005		
		\$10,248.00	2004		
		\$18,773.00	2003		
		\$11,125.00	2002		
Aerial Photography & Related Svcs Various Projects and Locations	Various Projects	\$76,541.00	2006	Unknown	Morgan Worldwide Mining Consul
		\$15,719.00	2005		
		\$23,998.00	2004		
		\$13,908.00	2003		
Aerial Photography & Related Svcs Various Projects and Locations	Various Projects	\$30,303.00	2002	Unknown	Qk4
		\$33,739.00	2006		
		\$216,174.00	2004		
		\$34,177.00	2003		
Aerial Photography & Related Svcs Various Projects and Locations	Various Projects	\$72,581.00	2002	Unknown	Qk4
			2002		

18. COMPLETED WORK WITHIN LAST 5 YEARS ON WHICH YOUR FIRM HAS BEEN A SUB-CONSULTANT TO OTHER FIRMS (INDICATE PHASE OF WORK FOR WHICH YOUR FIRM WAS RESPONSIBLE)

PROJECT NAME, TYPE AND LOCATION	NAME AND ADDRESS OF OWNER	ESTIMATED CONSTRUCTION COST OF YOUR FIRM'S PORTION	YEAR	CONSTRUCTED (YES OR NO)	FIRM ASSOCIATED WITH
Aerial Photography & Related Svcs Various Projects and Locations	Various Projects	\$38,918.00 \$65,938.00 \$19,683.00 \$28,932.00 \$22,585.00	2006 2005 2004 2003 2002	Unknown	Quest Engineers
Aerial Photography & Related Svcs Various Projects and Locations	Various Projects	\$34,617.00 \$27,536.00 \$5,571.00	2006 2005 2004	Unknown	Rettew Associates, Inc.
Aerial Photography & Related Svcs Various Projects and Locations	Various Projects	\$3,640.00 \$7,815.00 \$45,565.00 \$9,290.00 \$21,780.00	2006 2005 2004 2003 2002	Unknown	Sherman Carter Barnhart Architects
Aerial Photography & Related Svcs Various Projects and Locations	Various Projects	\$15,515.00 \$27,125.00 \$9,059.00 \$9,154.00 \$6,020.00	2006 2005 2004 2003 2002	Unknown	Sisler Maggard Engineering
Aerial Photography & Related Svcs Various Projects and Locations	Various Projects	\$30,300.00 \$111,101.00 \$30,100.00 \$2,600.00	2006 2005 2004 2002	Unknown	Thomas & Hutton Engineering
Aerial Photography & Related Svcs Various Projects and Locations	Various Projects	\$225,212.00 \$157,654.00 \$8,685.00	2006 2004 2002	Unknown	Vaughn & Melton Consulting Eng
Aerial Photography & Related Svcs Various Projects and Locations	Various Projects	\$34,443.00 \$61,962.00 \$69,798.00 \$184,767.00	2006 2005 2004 2003	Unknown	Volkert & Associates
Aerial Photography & Related Svcs Various Projects and Locations	Various Projects	\$11,898.00 \$25,345.00 \$3,503.00 \$12,372.00	2006 2005 2004 2002	Unknown	Wilbur Smith & Associates
Aerial Photography & Related Svcs Various Projects and Locations	Various Projects	\$29,808.00 \$43,648.00	2006 2005	Unknown	Woolpert Consultants

18. COMPLETED WORK WITHIN LAST 5 YEARS ON WHICH YOUR FIRM HAS BEEN A SUB-CONSULTANT TO OTHER FIRMS (INDICATE PHASE OF WORK FOR WHICH YOUR FIRM WAS RESPONSIBLE)

PROJECT NAME, TYPE AND LOCATION	NAME AND ADDRESS OF OWNER	ESTIMATED CONSTRUCTION COST OF YOUR FIRM'S PORTION	YEAR	CONSTRUCTED (YES OR NO)	FIRM ASSOCIATED WITH
Aerial Photography & Related Svcs Various Projects and Locations	Various Projects	\$10,227.00	2005	Unknown	A/E Associates
Aerial Photography & Related Svcs Various Projects and Locations	Various Projects	\$51,700.00 \$42,800.00 \$35,650.00	2005 2004 2002	Unknown	Arundel Corporation
Aerial Photography & Related Svcs Various Projects and Locations	Various Projects	\$46,205.00 \$25,366.00 \$1,500.00 \$30,427.00	2005 2004 2003 2002	Unknown	Chapman Technical Group
Aerial Photography & Related Svcs Various Projects and Locations	Various Projects	\$2,525.00 \$42,227.00	2005 2002	Unknown	H.A. Spalding Engineers
Aerial Photography & Related Svcs Various Projects and Locations	Various Projects	\$38,584.00 \$17,574.00 \$58,405.00 \$5,255.00	2005 2004 2003 2002	Unknown	Haworth Meyer & Boleyn
Aerial Photography & Related Svcs Various Projects and Locations	Various Projects	\$1,175.00 \$16,384.00 \$23,118.00 \$30,268.00	2005 2004 2003 2002	Unknown	Howard K Bell Consulting Eng
Aerial Photography & Related Svcs Various Projects and Locations	Various Projects	\$12,976.00 \$43,066.00	2005 2003	Unknown	L.A. Gates
Aerial Photography & Related Svcs Various Projects and Locations	Various Projects	\$118,900.00 \$159,700.00 \$150,305.00 \$111,652.00	2005 2004 2003 2002	Unknown	LaFarge
Aerial Photography & Related Svcs Various Projects and Locations	Various Projects	\$6,553.00 \$18,121.00 \$104,624.00	2005 2004 2002	Unknown	Palmer Engineers
Aerial Photography & Related Svcs Various Projects and Locations	Various Projects	\$550.00 \$3,920.00	2005 2003	Unknown	The Gateway Engineers
Aerial Photography & Related Svcs Various Projects and Locations	Various Projects	\$136,069.00 \$60,552.00 \$5,200.00	2005 2004 2003	Unknown	Wolverton Associates
Aerial Photography & Related Svcs Various Projects and Locations	Various Projects	\$1,624,711.00	2004	Unknown	BAE Systems Mission Solutions
Aerial Photography & Related Svcs Various Projects and Locations	Various Projects	\$42,204.00 \$42,204.00 \$16,722.00	2004 2003 2002	Unknown	Coleman Aerial Imaging

18. COMPLETED WORK WITHIN LAST 5 YEARS ON WHICH YOUR FIRM HAS BEEN A SUB-CONSULTANT TO OTHER FIRMS (INDICATE PHASE OF WORK FOR WHICH YOUR FIRM WAS RESPONSIBLE)

PROJECT NAME, TYPE AND LOCATION	NAME AND ADDRESS OF OWNER	ESTIMATED CONSTRUCTION COST OF YOUR FIRM'S PORTION	YEAR	CONSTRUCTED (YES OR NO)	FIRM ASSOCIATED WITH
Aerial Photography & Related Svcs Various Projects and Locations	Various Projects	\$10,727.00 \$51,060.00	2004 2003	Unknown	CTE Engineers
Aerial Photography & Related Svcs Various Projects and Locations	Various Projects	\$6,367.00 \$4,993.00 \$5,114.00	2004 2003 2002	Unknown	Parsons Brinckerhoff Quade Douglas
Aerial Photography & Related Svcs Various Projects and Locations	Various Projects	\$38,100.00 \$28,262.00	2003 2002	Unknown	HDR / WL Jordan
Aerial Photography & Related Svcs Various Projects and Locations	Various Projects	\$44,753.00 \$97,378.00	2003 2002	Unknown	Hoffman & Company

19. Use this space to provide any additional information or description of resources supporting your firm's qualifications to perform work for the West Virginia Division of Highways.

20. The foregoing is a statement of facts.

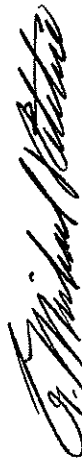

Signature: _____

Title: President _____

Printed Name: G. Michael Ritchie, PE, PLS, PSM, CP

Date: November 20, 2008

Project #	Project Name	County	State	Year Completed	Design Drainage Control Channels	Seal Portals	Eliminate High Walls	Regrade Refuse Piles	Restore Damaged Streams	Correct Slope Stability Problems	Structure Demolition	Impoundment Removal
630	Buck Run	Taylor	WV	1988-90		X				X	X	
631	Peck's Run Specs	Upshur	WV	1988-90	X	X		X			X	
632	Ream Refuse Pile	McDowell	WV	1988-90	X	X		X				X
633	Boissevain Maintenance	Tazewell	VA	1989	X			X				X
634	Clifton "C" Portals	Mason	WV	1989-91		X						
635	Spriggs Land Slide & Portals	Mingo	WV	1989-90		X				X		
636	Nealy Ridge Water Feasibility Study	Dickenson	VA	1989-91								
637	Oneida Water System Improvements	Clay	KY	1989-93								
638	Big Creek Area Water Study	Clay	KY	1989-90		X		X			X	
639	Grafton # 5	Taylor	WV	1990-92	X			X				
640	Mabie Tipple & Refuse	Randolph	WV	1990-91	X			X				
641	Richmond VA-Shaft Study	Chesterfield	VA	1990-92		X						
642	Morgan Co. Water Study	Morgan	KY	1990-94								
643	Boldmen Slides	Pike	KY	1990-93						X		
644	Dony Refuse & Slide	Floyd	KY	1990-93	X	X		X			X	
645	Barker Branch Hollow fill	Morgan	KY	1990-93	X			X		X		
646	Tolar Portals/Slide-Floyd	Floyd	KY	1990-92	X	X		X	X	X		
647	Laurel Fork Sediment Deposits	Tazewell	VA	1991-93	X			X	X			
648	Pocahontas Sediment Deposits	Tazewell	VA	1991-95								
649	Rocklick Refuse Highwall	Fayette	WV	1991-93	X			X				X
650	Greggville AMD	Ohio	WV	1991-94		X		X				
651	Horton Ridge Water Feasibility Study	Multiple	VA	1991								
652	Noseman Branch Refuse Piles	Wyoming	WV	1991-94	X	X		X			X	
653	Messer Slide	Perry	KY	1991-95						X		
654	Kodak Slides	Perry	KY	1991-94					X	X		
655	Watkins Landing Shafts	Multiple	VA	1992-95		X						
656	Alphe Mine Portals & Refuse	Harrison	WV	1992-94	X	X		X		X		
657	Middle Fork Church	Leslie	KY	1992-94								
658	George Wooton Park	Leslie	KY	1992-94		X			X	X		

Ford's Run #1 – Barbour County, WV

State:

- *West Virginia*

Agency:

- *Department of Energy –
Abandoned Mine Lands &
Reclamation*

Dates:

- *1988-1989*

Project Team:

- *Joe Grider, PE, PLS, Design
Engineer*
- *Amy Dearing,
Draftsperson*

The *West Virginia Office of Abandoned Mine Lands & Reclamation* selected HMB to provide a full range of services for the design of this reclamation project. HMB provided surveying services, designed preliminary and final plans, prepared contract plans and specifications, prepared detailed construction cost estimates and attended Pre-Bid and Pre-Construction meetings. Whenever necessary, site visits were made during construction to monitor progress and conformance to plans. HMB also coordinated the work done by the geotechnical consultant and the sampling and testing laboratories.

The site is located approximately two miles north of Philippi on County Route 24, adjacent to the Badger Coal Mine Complex. The site consisted of three mine openings. One of the mine openings located along the railroad tracks blew out two different times: the first time in 1981 and again in February 1986. These mines posed a threat to users of the area. Adjacent to the mine openings are several coke ovens, which are open and partially collapsed. Because of their location, they pose a danger to children who might be playing in the area. On the other side of Ford's Run, a large seven (7) acre refuse pile exists. The slopes on the pile are very steep and reach 40 feet in height at its tallest point. The site is located approximately 500 yards from the Tygarts Valley River, which is a heavily used river for boating, swimming, and fishing. Because of its proximity to this area, it posed a danger to users of the area.

The three mine openings were excavated and the mine was completely dewatered. Water treatment was required during dewatering. Wet seals were installed at each of the mine openings and rock lined drainage channels were constructed to carry discharge to Ford's Run. The coke ovens were demolished and the adjacent area was regraded. The refuse pile was bordered closely by the county road and a railroad track. Because of its location, the refuse was hauled to an adjacent waste area. The regraded and reshaped refuse pile was covered with soil and revegetated.

Skitter Creek Dam – Fayette County, WV

State:

- *West Virginia*

Agency:

- *Department of Energy –
Abandoned Mine Lands &
Reclamation*

Dates:

- *1988-1989*

Project Team:

- *Joe Grider, PE, PLS, Design
Engineer*
- *Amy Dearing,
Draftsperson*
- *Sandi Brown, Draftsperson*

The *West Virginia Office of Abandoned Mine Lands & Reclamation* selected HMB to provide a full range of services for the design of this reclamation project. HMB provided surveying services, designed preliminary and final plans, prepared contract plans and specifications, prepared detailed construction cost estimates and attended Pre-Bid and Pre-Construction meetings. Whenever necessary, site visits were made during construction to monitor progress and conformance to plans. HMB also coordinated the work done by the geotechnical consultant and the sampling and testing laboratories.

The site is located on County Rt. 15 approximately 1 1/2 miles from Milburn. The problem area consisted of a large refuse pile, measuring approximately 2 acres in area, and two small sidehill refuse piles, each measuring approximately 0.1 acre. The large pile was the subject of a Corps of Engineer's report because of its potential to impound a large amount of water. The pile did not impound water due to the coarse nature of the refuse material, but it was feared that eventually, sediment deposits could eventually block water flow through the base of the dam, causing water to impound. Since there was no spillway, this posed a serious threat to the communities downstream from this dam. In addition, the two small refuse piles adjacent to Skitter Creek were heavily eroded and posed a threat to the stream quality.

The large refuse dam was regraded to eliminate the threat of an impoundment. The excavated refuse was placed on the adjacent sides of the hollow and covered with soil material. The two small refuse piles were graded in place and covered with suitable soil material. Vegetation was established on all disturbed areas.

Iroquois Refuse Pile – Wyoming County, WV

State:

- *West Virginia*

Agency:

- *Department of Energy-
Abandoned Mine Lands &
Reclamation*

Dates:

- *1988-89*

Project Team:

- *Joe Grider, PE, PLS, Design
Engineer*
- *Sandi Brown, Draftsperson*

The West Virginia Office of Abandoned Mine Lands & Reclamation selected HMB to provide a full range of services for the design of this reclamation project. HMB provided surveying services, designed preliminary and final plans, prepared contract plans and specifications, prepared detailed construction cost



estimates and attended Pre-Bid and Pre-Construction meetings. Whenever necessary, site visits were made during construction to monitor progress and conformance to plans. HMB also coordinated the work done by the geotechnical consultant and the sampling and testing laboratories. The site is

located adjacent to WV 16 and the Norfolk and Western Railroad, near the community of Iroquois in Wyoming County. The problem area consisted of a large refuse pile, measuring approximately ten acres. A portion of the pile was burning, with numerous vent holes emitting smoke and fumes. The local residents had voiced numerous complaints about the fumes and smoke coming from the pile. Some of the comments stated that the pile has burned for years. One resident reported that work crews tried to extinguish the fire in 1968. Correspondence from the West Virginia Air Pollution Control Commission stated that in 1966 through 1968, a mixture of liquid petroleum asphalt, stone, flyash, sand and asbestos cement was spread over the pile in an attempt to extinguish the burning. This attempt was unsuccessful.

The majority of the work associated with the design was a site restoration plan that included excavation of all areas of burning, extinguishing the burning material, and regrading the entire refuse pile to a stabilized configuration. The site was vegetated after placement of soil cover over the pile. Also, adequate drainage channels and structures were designed as needed for proper site drainage.

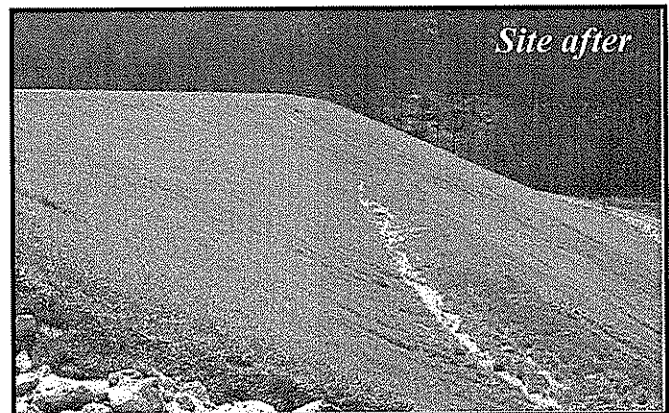

Raleigh Refuse Piles – Raleigh County, WV

State:

- *West Virginia*

Agency:

- *Department of Energy-
Abandoned Mine Lands and
Reclamation*

Dates:

- *1988-1992*

Project Team:

- *Joe Grider, PE, PLS, Design
Engineer*
- *Sandi Brown, Draftsperson*
- *Amy Dearing,
Draftsperson*

The *West Virginia Office of Abandoned Mine Lands & Reclamation* selected HMB to provide a full range of services for the design of this reclamation project. HMB provided surveying services, designed preliminary and final plans, prepared contract plans and specifications, prepared detailed construction cost estimates and attended Pre-Bid and Pre-Construction meetings. Whenever necessary, site visits were made during construction to monitor progress and conformance to plans. HMB also coordinated the work done by the geotechnical consultant and the sampling and testing laboratories.

This site is located south of Beckley on County Road 19/66. The site was last mined in 1950 by Raleigh Coal and Coke. The site consisted of six refuse piles and two refuse dams. The six refuse piles were washing sediment into nearby streams and roadways. In addition, the refuse piles were adjacent to dwellings, and local residents were concerned that children playing on the piles would injure themselves.

The first refuse dam was 80' high, 500' long, and 20' wide on the crest. There was no spillway or other designed means to pass floodwaters. The second refuse dam was approximately 60' high, 80' long, and 15' wide at the crest. There was a marginally functional culvert running underneath this second dam. The water from this culvert carried the runoff to Piney Creek. Local residents were concerned that if either dam should begin to impound water, those dams could be breached or collapse, which would endanger their lives.

The refuse dams were regraded to allow runoff to flow through them without the threat of impounding water. The refuse that was removed from the two dam areas was hauled to the adjacent refuse piles. The refuse piles were all regraded to establish stable slopes. The disturbed area was then covered with suitable soil to provide adequate vegetation.

Accoville Refuse Pile – Logan County, WV

State:

- *West Virginia*

Agency:

- *Department of Energy -
Abandoned Mine Lands &
Reclamation*

Dates:

- *1988-89*

Project Team:

- *Joe Grider, PE, PLS, Design
Engineer*
- *Sandi Brown, Draftsperson*
- *Amy Dearing, Draftsperson*

The *West Virginia Office of Abandoned Mine Lands & Reclamation* selected HMB to provide a full range of services for the design of this reclamation project. HMB provided surveying services, designed preliminary and final plans, prepared contract plans and specifications, prepared detailed construction cost estimates and attended Pre-Bid and Pre-Construction meetings. Whenever necessary, site visits were made during construction to monitor progress and conformance to plans. HMB also coordinated the work done by the geotechnical consultant and the sampling and testing laboratories.

This project consisted of a large burning sidehill refuse pile located along the Buffalo Creek, parallel to County Road 16/1, just east of the community of Accoville, in southeastern Logan County. Across Buffalo Creek hollow from this refuse pile were three portals and an old tippie. The refuse pile was a long, (3500') sidehill dump that was once heavily vegetated. The refuse had ignited, and widespread burning existed at the pile. The smoke and noxious fumes produced by this burning filled the Buffalo Creek hollow, which created a health hazard to the many residents. The tippie was old and badly deteriorated. This structure presented a safety hazard to the surrounding residents and businesses. The portals



were also a safety hazard to the residences in the Buffalo Creek hollow. HMB included the following measures for the project design: removal of



all vegetation on the refuse pile, thorough extinguishing of all burning refuse, regrading and revegetation of refuse to stable slope, demolition of tippie, and sealing of three portals.

Buck Run Slides & Portals – Taylor County, WV

State:

- *West Virginia*

Agency:

- *Department of Energy –
Abandoned Mine Lands &
Reclamation*

Dates:

- *1988-1990*

Project Team:

- *Joe Grider, PE, PLS, Design
Engineer*
- *Sandi brown, Draftsperson*
- *Amy Dearing, Draftsperson*

The *West Virginia Office of Abandoned Mine Lands & Reclamation* selected *HMB* to provide a full range of services for the design of this reclamation project. *HMB* provided surveying services, designed preliminary and final plans, prepared contract plans and specifications, prepared detailed construction cost estimates and attended Pre-Bid and Pre-Construction meetings. Whenever necessary, site visits were made during construction to monitor progress and conformance to plans. *HMB* also coordinated the work done by the geotechnical consultant and the sampling and testing laboratories.

This project consisted of two sites adjacent to County Road 34. Site #1 contained two collapsed portals and a slide measuring 100' x 150', with an estimated depth of 8'. The collapsed portals appeared to be draining through the spoil and saturating the ground below. County Road 34 ran between the portals and slide area. The drainage from the portals was entering the spoil above the road, which caused the slide to develop below the road.

Site #2 consisted of an abandoned wooden tippie. The tippie was immediately adjacent to the road and was a hazard to motorists and residents. Site #2 also had a slide measuring 400' x 100', with an estimated depth of 6'. County Road 34 was being heavily damaged by the slope instability at both sites. Numerous repairs to the road had been made by the Department of Highways.

As part of the design solution for this project, the portals were wet sealed and proper drainage was established to the adjacent creek. The tippie was dismantled and properly disposed. The slide material was excavated and stable slopes were established. CR 34 was repaired and repaved after construction. All disturbed areas were revegetated.

Peck's Run Tipple - Upshur County, WV

State:

- *West Virginia*

Agency:

- *Department of Energy –
Abandoned Mine Lands &
Reclamation*

Dates:

- *1988-1990*

Project Team:

- *Joe Grider, PE, PLS, Design
Engineer*
- *Sandi Brown, Draftsperson*
- *Amy Dearing, Draftsperson*

The *West Virginia Office of Abandoned Mine Lands & Reclamation* selected HMB to provide a full range of services for the design of this reclamation project. HMB provided surveying services, designed preliminary and final plans, prepared contract plans and specifications, prepared detailed construction cost estimates and attended Pre-Bid and Pre-Construction meetings. Whenever necessary, site visits were made during construction to monitor progress and conformance to plans. HMB also coordinated the work done by the geotechnical consultant and the sampling and testing laboratories.

The Peck's Run project is located in Upshur County, approximately five miles north of Buckhannon and two miles east of Hodgesville. The property was located within 100 yards of two residences, one of which has small children. The site was a danger to local residents because of the dangerous features that existed on the property. The site contained two strip ponds, both which were easily accessible to people walking in the area. Both ponds were approximately 50' x 75' x 5'. The site also contained approximately 8 acres of exposed refuse, some showing signs of past burning. In the middle of the refuse there was a 6" high pressure gas line. The burning refuse posed a danger to this utility. The site also contained several structures, consisting of a scale house, two storage buildings, a foundation of the office building, a coal truck dump, several pieces of abandoned equipment, and a large steel tipple that had partially collapsed. The site also contained approximately 1000' of highwall with an opening appearing at the base of one section of the wall. The site contained extensive acid mine drainage (AMD) from the water seeping from the exposed refuse. The AMD had drained to a low point on the property. This burnt several trees and has created a large AMD swamp.

HMB designed and prepared project plans that included the following work items: removing all existing structures; regrading all exposed refuse to establish stable slopes; drain and backfilled the strip pond; sealed the mine portal, installed underdrains as necessary; installed drainage ditches to control surface water; and revegetated the entire area.

Ream Refuse Piles - McDowell County, WV

State:

- *West Virginia*

Agency:

- *Department of Energy –
Abandoned Mine Lands &
Reclamation*

Dates:

- *1988-1990*

Project Team:

- *Joe Grider, PE, PLS, Design
Engineer*
- *Greg Boleyn, Draftsman*
- *Amy Dearing,
Draftsperson*

The *West Virginia Office of Abandoned Mine Lands & Reclamation* selected HMB to provide a full range of services for the design of this reclamation project. HMB provided surveying services, designed preliminary and final plans, prepared contract plans and specifications, prepared detailed construction cost estimates and attended Pre-Bid and Pre-Construction meetings. Whenever necessary, site visits were made during construction to monitor progress and conformance to plans. HMB also coordinated the work done by the geotechnical consultant and the sampling and testing laboratories.

The site is located south of Gary on Route 13 toward the Township of Ream. It had two areas consisting of several structures, refuse piles, portals and a vertical opening. The structures were two small buildings, each 8' x 10', and the remains of a loadout. The structures were in a state of collapse and were very unstable and dangerous. In addition, there were several foundations scattered throughout the site. There were four refuse piles with slopes that were very steep and unstable. All of these piles contained several large erosion gullies. Several area residents were using the piles to dispose of household garbage. Nearby streams received large amounts of sediment, which presented water quality as well as possible flood conditions for the community of Ream. The most easterly refuse pile had a 5' arched cut stone culvert through the middle of the pile. Also, on this site were three open portals which have approximately 5' x 8' openings. They were easily accessible and showed signs of entry. The portal roofs appeared to be in a deteriorating condition. These portal openings were supported by wooden mine timbers that had rotted and fallen. The water draining from these portals had a pH of 6.0 and Fe concentrations of 4 PPM. The site also contained a vertical opening that was filled with sawdust. It appeared to be about 6' in diameter.

The refuse pile was regraded to establish smooth and stable slopes. Some of the refuse was wasted along a highwall located above the refuse pile and Route 13. Disturbed areas had soil placed and vegetation established. Structures were dismantled and disposed in an approved manner. Also, foundations were disposed in an approved manner. Portals were wet sealed and drainage channels established. The vertical opening was filled with suitable material and drainage channel established.

Clifton "C" Portals – Mason County, WV

State:

- *West Virginia*

Agency:

- *Department of Energy –
Abandoned Mine Lands &
Reclamation*

Dates:

- *1989-1991*

Project Team:

- *Joe Grider, PE, PLS, Design
Engineer*
- *Greg Boleyn, Draftsman*
- *Amy Dearing, Draftsperson*

The *West Virginia Office of Abandoned Mine Lands & Reclamation* selected HMB to provide a full range of services for the design of this reclamation project. HMB designed preliminary and final plans, prepared contract plans and specifications, prepared detailed construction cost estimates and attended Pre-Bid and Pre-Construction meetings. Whenever necessary, site visits were made during construction to monitor progress and conformance to plans.

The site consisted of a rock fall, caused by a subsiding deep mine, several portals, and a small impoundment near West Columbia, Mason County. This site was last mined in 1965 by the Old Pittsburg Coal Company. A deep mine had been driven at the base of a coarse sandstone cliff. The roof support for the abandoned coal mine had failed, resulting in subsidence of the rock structure above. The face of the cliff broke away as a result from the subsidence. As a result, a very large amount of rock had fallen. The boulders, some as large as a house, threatened the homes and lives of residents living below. One family was forced to move from their home. Several large rock structures remained hanging on the cliff, showing signs of possible failure. This situation endangered the homes directly below, as well as traffic on Route 62.

Approximately six open portals were located along the cliff where the rock fall has occurred. These portals not only presented the same problem as the rock fall, but they also posed a hazard to neighborhood children who frequented the area. These portals were not draining. Five additional portals were located in a valley approximately 1/2 mile north of the rock fall. Water draining from these portals had a pH 7.0 and Iron concentration of 3 ppm. This drainage is running into a small dug-out impoundment (20' x 20'). The sides of this impoundment are very steep and dangerous. If a person or animal were to fall into this impoundment there would be no way out. A small amount of refuse is located near this second group of portals.

The plans and specifications for this project had been formulated earlier, but these plans include excavation of the highwall above the portals. Reconsideration of this project by the Abandoned Mine Lands & Reclamation created a need to delete the tremendous amount of rock excavation and formulate new plans and specifications for sealing the portals only. HMB was contracted to prepare the plans and specifications for sealing and de-watering the portals, treating the acid mine drainage, regrading the refuse pile, and eliminating the small impoundment. The disturbed areas were covered with soil, seeded and mulched.

Alphe Portals & Refuse - Harrison Co., WV

State:

- *West Virginia*

Agency:

- *Division of Environmental Protection - Abandoned Mine Lands & Reclamation*

Dates:

- *1992-1994*

Project Team:

- *Mike Gill, PLS, Project Manager*
- *C.P. Luttrell, Designer*

The *West Virginia Office of Abandoned Mine Lands & Reclamation* selected HMB to provide a full range of services for the design of this reclamation project. HMB provided surveying services, designed preliminary and final plans, prepared contract plans and specifications, prepared detailed construction cost estimates and attended Pre-Bid and Pre-Construction meetings. Whenever necessary, site visits were made during construction to monitor progress and conformance to plans. HMB also coordinated the work done by the geotechnical consultant and the sampling and testing laboratories.

This site is near County Route 25/3, north of Mount Clare, West Virginia. The site was last mined in the 1950's by Penn Alphe, Stout & Simms, and Woodsdale Coal Companies. Mine maps indicate at least thirteen (13) openings around the head of the hollow. The site bench immediately above, and to the north of the Hawkins' residence was approximately 600' long and composed of out-stacked spoil banks 85' wide. The site also contained an open pit, 20' to 30' deep from the spoil side, and a vertical highwall 45' high. The spoil bank was vegetated by volunteer locust and briars. The pit floor was 20' wide and held Acid Mine Drainage (AMD) and sludge of unknown depth. The pit top width from top of the spoil bank to the highwall was 85'. The AMD appeared to be seeping through the spoil bank and saturating the area around the Hawkins' residence, causing severe foundation problems. The old mine access road was made of spoil and refuse and formed a dike to hold AMD at the lower end of the Hawkins' yard. This further saturated that area and had flooded the septic system.

Drainage from the pit was approximately 200 gpm, with a field tested 8.0 pH and 2.0 ppm Fe. Immediately to the west of this was a huge iron sludge area where the flow from two more portals (+200gpm) fanned out over the surface. At least four collapsed portals along the southern side of the hollow also contributed AMD for an approximate flow of 200 gpm (7.5 pH and 10+ ppm Fe). Refuse is scattered throughout the site, with the largest refuse pile measuring approximately 200' X 300' X 40'. That pile spilled into a stream, with slopes approaching 1:1. Stream blockage was a danger there. A smaller refuse pile was located across the stream at the entrance of the access road. The site was readily accessible by the open access road to any type of vehicular or foot traffic. The site was heavily used by deer hunters. The community has several small school aged children living within 300' of the site. Evidence of visitation was obvious by the numerous foot and vehicle tracks throughout the site. Also associated with this site was the railroad loadout area. This 5-acre area adjoined the railroad at the end of the hollow by the access road. The area consisted of the remains of the wooden loadout facility and spoil and coal refuse scattered around the surface. The site was a favorite gathering spot for neighborhood children riding BMX bicycles and ATVs.

HMB developed plans and specifications to correct the conditions listed above. The plans included: 1) Excavating to locate and wet seal the portals on the site. 2) Constructing an outlet for the wet sealed portals in the existing via underdrains constructed through the existing pit & spoil banks. 3) Backfilling the existing pit and highwall with the existing spoil banks. 4) Open surface drains were designed to drain the remaining portals. 5) Regrade and cover the refuse piles. 6) Remove/regrade the haulroad to eliminate impounding capabilities. 7) Condition and revegetate all disturbed areas. 8) Remove the loadout facility. 9) Regrade and revegetate the associated spoil and refuse.

Scott Tipple – Barbour County, WV

State:

- *West Virginia*

Agency:

- *Division of Environmental Protection – Abandoned Mine Lands & Reclamation*

Dates:

- *1995-1996*

Project Team:

- *Ron Williams, PE, Office Manager*
- *Jonathan Fowler, PE, Project Manager*
- *Joe Crittenden, PE, Project Designer*

The *West Virginia Office of Abandoned Mine Lands & Reclamation* selected HMB to provide a full range of services for the design of this reclamation project. HMB provided surveying services, designed preliminary and final plans, prepared contract plans and specifications, prepared detailed construction cost estimates and attended Pre-Bid and Pre-Construction meetings. Whenever necessary, site visits were made during construction to monitor progress and conformance to plans. HMB also coordinated the work done by the geotechnical consultant and the sampling and testing laboratories.

Scott Tipple is located in Barbour County, West Virginia at the intersection of US Route 119 and County Route 119/16, near the community of Century. This project contained two distinct areas that required reclamation. Site 1 was east of US Route 119 and Site 2 was west of US 119. Site 1 consisted of rusted metal debris, railroad ties scattered throughout the site, dilapidated buildings, sediment clogged drainage structures, a small sediment clogged stream, an eroded access road, scattered refuse piles that appeared to be contaminating the small stream, a road made from coal refuse, steep/eroded slopes, and an inadequate culvert under a farm access road (Big Run) that caused flooding of US Route 119 during intense rainfalls. Site 2 consisted of two areas of impounded water, a three acre coal refuse pile, coal refuse that was washing into Big Run, and a clogged culvert at the northwest end of the site that was causing drainage problems. In addition, there were two coal piles beyond the project limits.

HMB designed the following remedial measures: 1) Establish positive drainage at both sites to a nearby stream. 2) Excavate and regrade the refuse piles at both sites. 3) Provide soil cover and revegetate the refuse piles and all disturbed areas at both sites. 4) Establish erosion control measures throughout the entire project. 5) Delineate the contractors access to the sites. 6) Delineate the work limits. 7) Regrade the access road through Site 1. 8) Size the culvert under the farm access road. 9) Place erosion control matting on the steep slopes.

Little Slate Creek Refuse Pile – McDowell Co.

State:

- *West Virginia*

Agency:

- *Division of Environmental Protection – Abandoned Mine Lands & Reclamation*

Dates:

- *1994-1995*

Project Team:

- *Ron Williams, PE, Office Manager*
- *Jonathan Fowler, PE, Project Manager*
- *Joe Crittenden, PE, Project Designer*

The *West Virginia Office of Abandoned Mine Lands & Reclamation* selected HMB to provide a full range of services for the design of this reclamation project. HMB provided surveying services, designed preliminary and final plans, prepared contract plans and specifications, prepared detailed construction cost estimates and attended Pre-Bid and Pre-Construction meetings. Whenever necessary, site visits were made during construction to monitor progress and conformance to plans. HMB also coordinated the work done by the geotechnical consultant and the sampling and testing laboratories.

The project site was last mined in the 1950's by Island Creek Coal Company. The site is located along Route 83 in Raysal, McDowell County. The site consisted of a six-acre refuse pile. The pile had very unstable slopes, which during heavy rainfalls, caused refuse material to be deposited onto the adjacent road. The site was easily accessible due to its proximity to a main road. Years ago, Jane Cooper was seriously injured in a motor vehicle accident at the site. Area residents were concerned that another automobile accident might occur due to sediment washing into the road. There were numerous site visitations made by the local residents, as evidenced by tire tracks.

HMB designed the following remedial measures for this site: 1) The refuse pile was regraded to establish stable slopes. 2) Drainage channels were designed to carry surface runoff to a nearby stream. 3) Soil material was placed on all disturbed areas, which were then seeded.

Minden Mine Dump – Fayette County, WV

State:

- *West Virginia*

Agency:

- *Division of Environmental Protection – Abandoned Mine Lands & Reclamation*

Dates:

- *1993-1995*

Project Team:

- *Ron Williams, PE, Project Manager*
- *Joe Crittenden, PE, Project Designer*

The *West Virginia Office of Abandoned Mine Lands & Reclamation* selected *HMB* to provide a full range of services for the design of this reclamation project. *HMB* provided surveying services, designed preliminary and final plans, prepared contract plans and specifications, prepared detailed construction cost estimates and attended Pre-Bid and Pre-Construction meetings. Whenever necessary, site visits were made during construction to monitor progress and conformance to plans. *HMB* also coordinated the work done by the geotechnical consultant and the sampling and testing laboratories.

The Minden Mine Dump is located near the village of Minden, West Virginia. On site problems included: 1) Two partially collapsed mine portals that were draining, 2) Local flooding caused by silt-laden drainage channels with inadequate drainage structures, 3) A dangerous highwall that was accessible from County Route 17, and 4) Refuse piles with unstable slopes and large erosion gullies.

HMB prepared plans and specifications for the following corrective measures: 1) Install wet seals to permanently lower the water level in the mine. 2) Establish positive drainage from these portals to a nearby stream. 3) Excavate and regrade the refuse piles. 4) Provide soil cover and revegetate the refuse areas and all disturbed areas.

Red Star Refuse & Coke Ovens – Fayette Co.

State:

- *West Virginia*

Agency:

- *Division of Environmental Protection – Abandoned Mine Lands & Reclamation*

Dates:

- *1992-1993*

Project Team:

- *Mike Gill, PLS, Project Manager*
- *C.P. Luttrell, Design Technician*

The *West Virginia Office of Abandoned Mine Lands & Reclamation* selected HMB to provide a full range of services for the design of this reclamation project. HMB provided surveying services, designed preliminary and final plans, prepared contract plans and specifications, prepared detailed construction cost estimates and attended Pre-Bid and Pre-Construction meetings. Whenever necessary, site visits were made during construction to monitor progress and conformance to plans. HMB also coordinated the work done by the geotechnical consultant and the sampling and testing laboratories.

The project site was last mined in the 1940's by Red Star Coal Company. At least 60 abandoned coke ovens were located in a densely populated area of Fayette County. The coke ovens were easily accessible and many of them were unstable. Several of these coke ovens were especially dangerous because it is possible to walk over and above them. Children playing above these ovens are in danger of collapsing the soil cover over the oven and falling inside. There were also three refuse piles located in the problem area. The first pile (Area 1) covered approximate 3-acres, and was located nearest the ovens. Refuse Area No. 2 was located west of Area 1 and covered approximately 3 acres. Approximately 250 l.f. of Area 2 was located adjacent to Red Star road and had a potential to slide onto the road. The refuse area was graded on the top and was used for equipment storage. Refuse Area 3 was located northwest of Area 2. That area had some vegetative cover but could still present some drainage problems.

HMB prepared plans and specifications for the following work items: 1) All coke ovens were backfilled, soil covered, and revegetated. 2) Refuse areas were regraded and vegetative cover established on all disturbed areas. Material from the refuse piles was used to backfill the coke ovens. 3) Construct surface drainage channels and 4) Seal all open portals encountered.