



State of West Virginia
 Department of Administration
 Purchasing Division
 2019 Washington Street East
 Post Office Box 50130
 Charleston, WV 25305-0130

Request for Quotation

RFQ NUMBER
DCH09069

PAGE
1

ADDRESS CORRESPONDENCE TO ATTENTION OF:
SHELLY MURRAY 304-558-8801

VENDOR

*709015300
 FILTECH INCORPORATED
 276 VALLEYMILLS ROAD
 PARKERSBURG WV 26104

SHIP TO

DIVISION OF CULTURE & HISTORY
 CULTURAL CENTER
 1900 KANAWHA BOULEVARD, EAST
 CHARLESTON, WV
 25305-0300 558-0220

DATE PRINTED 01/28/2009	TERMS OF SALE NET 30 DAYS	SHIP VIA FRT CARRIER	F.O.B. DESTINATION	FREIGHT TERMS FRT ALLOWED
BID OPENING DATE: 02/12/2009		BID OPENING TIME 01:30PM		

LINE	QUANTITY	UOP	CAT NO	ITEM NUMBER	UNIT PRICE	AMOUNT
0001	1	LS		031-45		
<p>THE WV PURCHASING DIVISION, FOR THE AGENCY, THE WV DIVISION OF CULTURE & HISTORY, IS SOLICITING BIDS FOR AIR FILTERING MEDIA FOR THE HVAC SYSTEM LOCATED IN THE CULTURAL CENTER ON THE CAPITOL COMPLEX IN CHARLESTON, WV PER THE ATTACHED SPECIFICATIONS.</p> <p>FILTERS AND FILTER MEDIA</p> <p>EXHIBIT 3</p> <p>LIFE OF CONTRACT: THIS CONTRACT BECOMES EFFECTIVE UPON AWARD AND EXTENDS FOR A PERIOD OF ONE (1) YEAR OR UNTIL SUCH "REASONABLE TIME" THEREAFTER AS IS NECESSARY TO OBTAIN A NEW CONTRACT OR RENEW THE ORIGINAL CONTRACT. THE "REASONABLE TIME" PERIOD SHALL NOT EXCEED TWELVE (12) MONTHS. DURING THIS "REASONABLE TIME" THE VENDOR MAY TERMINATE THIS CONTRACT FOR ANY REASON UPON GIVING THE DIRECTOR OF PURCHASING 30 DAYS WRITTEN NOTICE.</p> <p>UNLESS SPECIFIC PROVISIONS ARE STIPULATED ELSEWHERE IN THIS CONTRACT DOCUMENT, THE TERMS, CONDITIONS AND PRICING SET HEREIN ARE FIRM FOR THE LIFE OF THE CONTRACT.</p> <p>RENEWAL: THIS CONTRACT MAY BE RENEWED UPON THE MUTUAL</p>						

RECEIVED
 2009 FEB 12 AM 8:41
 WV PURCHASING DIVISION

SEE REVERSE SIDE FOR TERMS AND CONDITIONS

SIGNATURE <i>Janie Whelan</i>	TELEPHONE 412-461-1400	DATE 2-11-09
TITLE INSIDE SALES	FEIN 25-1199724	ADDRESS CHANGES TO BE NOTED ABOVE

WHEN RESPONDING TO RFQ, INSERT NAME AND ADDRESS IN SPACE ABOVE LABELED 'VENDOR'

**GENERAL TERMS & CONDITIONS
REQUEST FOR QUOTATION (RFQ) AND REQUEST FOR PROPOSAL (RFP)**

1. Awards will be made in the best interest of the State of West Virginia.
2. The State may accept or reject in part, or in whole, any bid.
3. All quotations are governed by the *West Virginia Code* and the *Legislative Rules* of the Purchasing Division.
4. Prior to any award, the apparent successful vendor must be properly registered with the Purchasing Division and have paid the required \$125 fee.
5. All services performed or goods delivered under State Purchase Order/Contracts are to be continued for the term of the Purchase Order/Contracts, contingent upon funds being appropriated by the Legislature or otherwise being made available. In the event funds are not appropriated or otherwise available for these services or goods, this Purchase Order/Contract becomes void and of no effect after June 30.
6. Payment may only be made after the delivery and acceptance of goods or services.
7. Interest may be paid for late payment in accordance with the *West Virginia Code*.
8. Vendor preference will be granted upon written request in accordance with the *West Virginia Code*.
9. The State of West Virginia is exempt from federal and state taxes and will not pay or reimburse such taxes.
10. The Director of Purchasing may cancel any Purchase Order/Contract upon 30 days written notice to the seller.
11. The laws of the State of West Virginia and the *Legislative Rules* of the Purchasing Division shall govern all rights and duties under the Contract, including without limitation the validity of this Purchase Order/Contract.
12. Any reference to automatic renewal is hereby deleted. The Contract may be renewed only upon mutual written agreement of the parties.
13. **BANKRUPTCY:** In the event the vendor/contractor files for bankruptcy protection, this Contract may be deemed null and void, and terminated without further order.
14. **HIPAA BUSINESS ASSOCIATE ADDENDUM:** The West Virginia State Government HIPAA Business Associate Addendum (BAA), approved by the Attorney General, and available online at the Purchasing Division's web site (<http://www.state.wv.us/admin/purchase/vrc/hipaa.htm>) is hereby made part of the agreement. Provided that, the Agency meets the definition of a Cover Entity (45 CFR §160.103) and will be disclosing Protected Health Information (45 CFR §160.103) to the vendor.
15. **WEST VIRGINIA ALCOHOL & DRUG-FREE WORKPLACE ACT:** If this Contract constitutes a public improvement construction contract as set forth in Article 1D, Chapter 21 of the West Virginia Code ("The West Virginia Alcohol and Drug-Free Workplace Act"), then the following language shall hereby become part of this Contract: "The contractor and its subcontractors shall implement and maintain a written drug-free workplace policy in compliance with the West Virginia Alcohol and Drug-Free Workplace Act, as set forth in Article 1D, Chapter 21 of the West Virginia Code. The contractor and its subcontractors shall provide a sworn statement in writing, under the penalties of perjury, that they maintain a valid drug-free work place policy in compliance with the West Virginia and Drug-Free Workplace Act. It is understood and agreed that this Contract shall be cancelled by the awarding authority if the Contractor: 1) Fails to implement its drug-free workplace policy; 2) Fails to provide information regarding implementation of the contractor's drug-free workplace policy at the request of the public authority; or 3) Provides to the public authority false information regarding the contractor's drug-free workplace policy."

INSTRUCTIONS TO BIDDERS

1. Use the quotation forms provided by the Purchasing Division.
2. **SPECIFICATIONS:** Items offered must be in compliance with the specifications. Any deviation from the specifications must be clearly indicated by the bidder. Alternates offered by the bidder as **EQUAL** to the specifications must be clearly defined. A bidder offering an alternate should attach complete specifications and literature to the bid. The Purchasing Division may waive minor deviations to specifications.
3. Complete all sections of the quotation form.
4. Unit prices shall prevail in case of discrepancy.
5. All quotations are considered F.O.B. destination unless alternate shipping terms are clearly identified in the quotation.
6. **BID SUBMISSION:** All quotations must be delivered by the bidder to the office listed below prior to the date and time of the bid opening. Failure of the bidder to deliver the quotations on time will result in bid disqualifications: Department of Administration, Purchasing Division, 2019 Washington Street East, P.O. Box 50130, Charleston, WV 25305-0130



State of West Virginia
 Department of Administration
 Purchasing Division
 2019 Washington Street East
 Post Office Box 50130
 Charleston, WV 25305-0130

Request for Quotation

RFQ NUMBER
DCH09069

PAGE
2

ADDRESS CORRESPONDENCE TO ATTENTION OF
SHELLY MURRAY 304-558-8801

VENDOR

*709015300
 FILTECH INCORPORATED
 276 VALLEYMILLS ROAD

 PARKERSBURG WV 26104

SHIP TO

DIVISION OF CULTURE & HISTORY

 CULTURAL CENTER
 1900 KANAWHA BOULEVARD, EAST
 CHARLESTON, WV
 25305-0300 558-0220

DATE PRINTED	TERMS OF SALE	SHIP VIA	F.O.B.	FREIGHT TERMS
01/28/2009				

BID OPENING DATE: 02/12/2009 BID OPENING TIME 01:30PM

LINE	QUANTITY	UOP	CAT NO.	ITEM NUMBER	UNIT PRICE	AMOUNT
<p>WRITTEN CONSENT OF THE SPENDING UNIT AND VENDOR, SUBMITTED TO THE DIRECTOR OF PURCHASING THIRTY (30) DAYS PRIOR TO THE EXPIRATION DATE. SUCH RENEWAL SHALL BE IN ACCORDANCE WITH THE TERMS AND CONDITIONS OF THE ORIGINAL CONTRACT AND SHALL BE LIMITED TO TWO (2) ONE (1) YEAR PERIODS.</p> <p>CANCELLATION: THE DIRECTOR OF PURCHASING RESERVES THE RIGHT TO CANCEL THIS CONTRACT IMMEDIATELY UPON WRITTEN NOTICE TO THE VENDOR IF THE COMMODITIES AND/OR SERVICES SUPPLIED ARE OF AN INFERIOR QUALITY OR DO NOT CONFORM TO THE SPECIFICATIONS OF THE BID AND CONTRACT HEREIN.</p> <p>OPEN MARKET CLAUSE: THE DIRECTOR OF PURCHASING MAY AUTHORIZE A SPENDING UNIT TO PURCHASE ON THE OPEN MARKET, WITHOUT THE FILING OF A REQUISITION OR COST ESTIMATE, ITEMS SPECIFIED ON THIS CONTRACT FOR IMMEDIATE DELIVERY IN EMERGENCIES DUE TO UNFORESEEN CAUSES (INCLUDING BUT NOT LIMITED TO DELAYS IN TRANSPORTATION OR AN UNANTICIPATED INCREASE IN THE VOLUME OF WORK.)</p> <p>QUANTITIES: QUANTITIES LISTED IN THE REQUISITION ARE APPROXIMATIONS ONLY, BASED ON ESTIMATES SUPPLIED BY THE STATE SPENDING UNIT. IT IS UNDERSTOOD AND AGREED THAT THE CONTRACT SHALL COVER THE QUANTITIES ACTUALLY ORDERED FOR DELIVERY DURING THE TERM OF THE CONTRACT, WHETHER MORE OR LESS THAN THE QUANTITIES SHOWN.</p> <p>ORDERING PROCEDURE: SPENDING UNIT(S) SHALL ISSUE A WRITTEN STATE CONTRACT ORDER (FORM NUMBER WV-39) TO THE VENDOR FOR COMMODITIES COVERED BY THIS CONTRACT. THE ORIGINAL COPY OF THE WV-39 SHALL BE MAILED TO THE VENDOR AS AUTHORIZATION FOR SHIPMENT, A SECOND COPY MAILED TO THE PURCHASING DIVISION, AND A THIRD COPY RETAINED BY THE SPENDING UNIT.</p>						

SEE REVERSE SIDE FOR TERMS AND CONDITIONS

SIGNATURE	TELEPHONE	DATE
TITLE	FEIN	ADDRESS CHANGES TO BE NOTED ABOVE

WHEN RESPONDING TO RFQ, INSERT NAME AND ADDRESS IN SPACE ABOVE LABELED 'VENDOR'



State of West Virginia
 Department of Administration
 Purchasing Division
 2019 Washington Street East
 Post Office Box 50130
 Charleston, WV 25305-0130

Request for Quotation

RFQ NUMBER
DCH09069

PAGE
3

ADDRESS CORRESPONDENCE TO ATTENTION OF
SHELLY MURRAY 304-558-8801

VENDOR

*709015300
 FILTECH INCORPORATED
 276 VALLEYMILLS ROAD

 PARKERSBURG WV 26104

SHIP TO

DIVISION OF CULTURE & HISTORY

 CULTURAL CENTER
 1900 KANAWHA BOULEVARD, EAST
 CHARLESTON, WV
 25305-0300 558-0220

DATE PRINTED	TERMS OF SALE	SHIP VIA	F.O.B.	FREIGHT TERMS
01/28/2009				

BID OPENING DATE: 02/12/2009 BID OPENING TIME 01:30PM

LINE	QUANTITY	UOP	CAT NO	ITEM NUMBER	UNIT PRICE	AMOUNT
<p>BANKRUPTCY: IN THE EVENT THE VENDOR/CONTRACTOR FILES FOR BANKRUPTCY PROTECTION, THIS CONTRACT IS AUTOMATICALLY NULL AND VOID, AND IS TERMINATED WITHOUT FURTHER ORDER.</p> <p>THE TERMS AND CONDITIONS CONTAINED IN THIS CONTRACT SHALL SUPERSEDE ANY AND ALL SUBSEQUENT TERMS AND CONDITIONS WHICH MAY APPEAR ON ANY ATTACHED PRINTED DOCUMENTS SUCH AS PRICE LISTS, ORDER FORMS, SALES AGREEMENTS OR MAINTENANCE AGREEMENTS, INCLUDING ANY ELECTRONIC MEDIUM SUCH AS CD-ROM.</p> <p>REV. 04/11/2001</p> <p>EXHIBIT 6</p> <p>PRICE ADJUSTMENT PROVISION: THE STATE OF WEST VIRGINIA WILL CONSIDER BIDS THAT CONTAIN PROVISIONS FOR PRICE ADJUSTMENTS PRIOR TO THE ORIGINAL EXPIRATION OF THE CONTRACT, PROVIDED THAT SUCH PRICE ADJUSTMENT COVERS BOTH UPWARD AND DOWNWARD MOVEMENT OF THE COMMODITY PRICE, AND THAT ADJUSTMENT IS BASED ON THE "PASS THROUGH" INCREASE OR DECREASE OF RAW MATERIALS AND/OR LABOR, WHICH MAKE UP ALL OR A SUBSTANTIAL PART OF A PRODUCT. ADJUSTMENTS ARE TO BE BASED UPON AN ACTUAL DOLLAR FIGURE, NOT A PERCENTAGE. ALL PRICE ADJUSTMENT REQUESTS MUST BE SUBSTANTIATED IN A MANNER ACCEPTABLE TO THE DIRECTOR PURCHASING, E.G. GOVERNMENTAL BENCH MARKS, GENERAL MARKET INCREASE, PUBLISHED PRICE LISTS. SUCH REQUESTS FOR AND INCREASE SHOULD BE RECEIVED IN WRITING BY THE DIRECTOR OF PURCHASING AT LEAST 30 DAYS IN ADVANCE OF THE EFFECTIVE DATE OF THE INCREASE. ANY TIME THE VENDOR REQUESTS A PRICE ADJUSTMENT, THE PURCHASING DIVISION MAY EITHER</p>						

SEE REVERSE SIDE FOR TERMS AND CONDITIONS			
SIGNATURE	TELEPHONE	DATE	
TITLE	FEIN	ADDRESS CHANGES TO BE NOTED ABOVE	

WHEN RESPONDING TO RFQ, INSERT NAME AND ADDRESS IN SPACE ABOVE LABELED 'VENDOR'



State of West Virginia
 Department of Administration
 Purchasing Division
 2019 Washington Street East
 Post Office Box 50130
 Charleston, WV 25305-0130

Request for Quotation

RFQ NUMBER
DCH09069

PAGE
4

ADDRESS CORRESPONDENCE TO ATTENTION OF:
SHELLY MURRAY 304-558-8801

VENDOR

*709015300
 FILTECH INCORPORATED
 276 VALLEYMILLS ROAD

 PARKERSBURG WV 26104

SHIP TO

DIVISION OF CULTURE & HISTORY

 CULTURAL CENTER
 1900 KANAWHA BOULEVARD, EAST
 CHARLESTON, WV
 25305-0300 558-0220

DATE PRINTED	TERMS OF SALE	SHIP VIA	F.O.B.	FREIGHT TERMS
01/28/2009				

BID OPENING DATE: 02/12/2009 BID OPENING TIME 01:30PM

LINE	QUANTITY	UOP	CAT NO	ITEM NUMBER	UNIT PRICE	AMOUNT
<p>ACCEPT THE PRICE ADJUSTMENT AND AMEND THE CONTRACT ACCORDINGLY OR REJECT THE ADJUSTMENT IN ITS ENTIRETY AND CANCEL THE CONTRACT.</p> <p>PREFERRED TERMS: IT IS PREFERRED THAT THE PRICES ON THIS CONTRACT ARE FIRM FOR LIFE OF THE CONTRACT, AS INDICATED IN THE LIFE OF CONTRACT CLAUSE CONTAINED HEREIN, NOT TO EXCEED ONE (1) YEAR.</p> <p>PASS THROUGH PRICE INCREASES WILL BE CONSIDERED AT TIME OF CONTRACT RENEWAL ONLY.</p> <p>PURCHASING CARD ACCEPTANCE: THE STATE OF WEST VIRGINIA CURRENTLY UTILIZES A VISA PURCHASING CARD PROGRAM WHICH IS ISSUED THROUGH A BANK. THE SUCCESSFUL VENDOR MUST ACCEPT THE STATE OF WEST VIRGINIA VISA PURCHASING CARD FOR PAYMENT OF ALL ORDERS PLACED BY ANY STATE AGENCY AS A CONDITION OF AWARD.</p> <p style="text-align: center;">NOTICE</p> <p>A SIGNED BID MUST BE SUBMITTED TO:</p> <p style="text-align: center;">DEPARTMENT OF ADMINISTRATION PURCHASING DIVISION BUILDING 15 2019 WASHINGTON STREET, EAST CHARLESTON, WV 25305-0130</p> <p>THE BID SHOULD CONTAIN THIS INFORMATION ON THE FACE OF</p>						

SEE REVERSE SIDE FOR TERMS AND CONDITIONS

SIGNATURE	TELEPHONE	DATE
TITLE	FEIN	ADDRESS CHANGES TO BE NOTED ABOVE

WHEN RESPONDING TO RFQ, INSERT NAME AND ADDRESS IN SPACE ABOVE LABELED 'VENDOR'



State of West Virginia
 Department of Administration
 Purchasing Division
 2019 Washington Street East
 Post Office Box 50130
 Charleston, WV 25305-0130

Request for Quotation

RFQ NUMBER
DCH09069

PAGE
5

ADDRESS CORRESPONDENCE TO ATTENTION OF:
SHELLY MURRAY
304-558-8801

VENDOR

*709015300
FILTECH INCORPORATED
276 VALLEYMILLS ROAD

PARKERSBURG WV 26104

SHIP TO

DIVISION OF CULTURE & HISTORY

CULTURAL CENTER
1900 KANAWHA BOULEVARD, EAST
CHARLESTON, WV
25305-0300 558-0220

DATE PRINTED	TERMS OF SALE	SHIP VIA	F.O.B	FREIGHT TERMS
01/28/2009				

BID OPENING DATE: **02/12/2009** BID OPENING TIME **01:30PM**

LINE	QUANTITY	UOP	CAT NO	ITEM NUMBER	UNIT PRICE	AMOUNT
<p>THE ENVELOPE OR THE BID MAY NOT BE CONSIDERED: SEALED BID</p> <p>BUYER: SHELLY MURRAY / FILE 31</p> <p>RFQ. NO.: DCH09069</p> <p>BID OPENING DATE: 02/12/2009</p> <p>BID OPENING TIME: 1:30 PM</p> <p>PLEASE PROVIDE A FAX NUMBER IN CASE IT IS NECESSARY TO CONTACT YOU REGARDING YOUR BID: 412-461-2846</p> <p>CONTACT PERSON (PLEASE PRINT CLEARLY): JANIE WHELAN</p> <p>***** THIS IS THE END OF RFQ DCH09069 ***** TOTAL: <u>\$22,597.12</u> AS SPECIFIED</p> <p><u>\$21,696.64</u> ALTERNATE</p>						

SEE REVERSE SIDE FOR TERMS AND CONDITIONS			
SIGNATURE	TELEPHONE	DATE	
TITLE	FEIN	ADDRESS CHANGES TO BE NOTED ABOVE	

WHEN RESPONDING TO RFQ, INSERT NAME AND ADDRESS IN SPACE ABOVE LABELED 'VENDOR'

West Virginia Division of Culture and History
Request for Quotation-DCH09069
HVAC Air Filtering Media

The West Virginia Division of Culture and History is soliciting bids for procurement of air filtering media required for the HVAC system located in the Cultural Center on the Capitol Complex in Charleston, West Virginia.

It is anticipated that the Agency will require 448 units of each type of media annually. Minimum individual order for each type of media will be Fifty-Six (56) units. Piecemeal ordering is due to lack of storage space for the full procurement quantity. Media shall meet the specifications below.

Vendor shall be required to accept a VISA/State of West Virginia Purchasing Card as payment in arrears for the commodity delivered. Bid shall include the cost of shipping to the point of delivery and any other charges required for delivery. Prices shall remain constant for the life of the contract.

SPECIFICATION

- **Pre-Filter:** Fiberbond Dustlok filter panel, synthetic media w/ internal wire support, w/ SPOR-AX Anti-microbial agent or, approved equal.
 - **Nominal Size:** 24 "x 24" x 1-1/2"
 - **Construction:**
 - Multi-layered, air laid 100% polyester media securely heat-sealed around an internal wire support grid.
 - Panel shall contain four (4) long, continuous parallel internal seal bars to prevent media fluttering.
 - Panel shall provide three distinct progressive layers for dust entrapment. Final stage shall be tightly needled and shall contain a non-migratory, non-drying adhesive throughout the entire final layer.
 - Panel shall contain an anti-microbial that -effectively controls the growth of mold, algae, mildew, and fungi on the media. Anti-microbial agent shall not off gas, migrate, or leach into the air stream.
 - Filter shall be Underwriters Laboratory (UL) listed as Class II
 - Panel shall provide a minimum ASHRAE efficiency of 25 %.
- **Primary Filter:** Airflow Products: extended surface self supported mini-pleat box filter: AMFP95-24244, 95% efficiency or, approved equal.
 - **Nominal Size:** 24" x 24" x 4"
 - **Construction:**
 - Frame construction shall be composed of injection molded polypropylene
 - Filter pack shall consist of non-shredding, gradient density, polypropylene media.

West Virginia Division of Culture and History
Request for Quotation-DCH09069
HVAC Air Filtering Media

- Media shall cover a minimum of 120 Square Feet Media shall be bonded to the frame using polypropylene adhesive.
- Filter shall be rated for at least 2,000 CFM.
- Filter shall provide a minimum ASHRAE efficiency of 95%.
- Filter shall be Underwriters Laboratories rated Class II per UL 900 standard.
- Filter shall be suitable for Variable Air Volume (VAV) Systems. Filter shall be able to withstand turbulent airflow conditions.

West Virginia Division of Culture and History
Request for Quotation-DCH09069
HVAC Air Filtering Media

- Media shall cover a minimum of 120 Square Feet Media shall be bonded to the frame using polypropylene adhesive.
- Filter shall be rated for at least 2,000 CFM.
- Filter shall provide a minimum ASHRAE efficiency of 95%.
- Filter shall be Underwriters Laboratories rated Class II per UL 900 standard.
- Filter shall be suitable for Variable Air Volume (VAV) Systems. Filter shall be able to withstand turbulent airflow conditions.

West Virginia Division of Culture and History
Request for Quotation-DCH09069
HVAC Air Filtering Media

BID COST SHEET:

PRODUCT	ESTIMATED QUANTITY	UNIT COST	EXTENDED COST
PRE-FILTER PANEL	448	\$ 4.11 EACH AS SPECIFIED	\$ 1,841.28
PRIMARY MINI PLEAT BOX FILTER	448	\$ 46.33 EACH AS SPECIFIED	\$ 20,755.84
TOTAL			\$ 22,597.12

VENDOR: FILTECH, INC.

SIGNATURE: Janie Whelan DATE: 2-11-09

ALTERNATE BID:

PRE-FILTER PANEL 448 EA \$ 3.65 EACH \$ 1,635.20
 SERIES 66 ANTIMICROBIAL
 MERV 8 3-PLY
 PN 01662424
 AIRFLOW TECHNOLOGY

PRIMARY BOX FILTER 448 \$ 44.78 EACH \$ 20,061.44
 DOMINATOR
 HIGH EFFICIENCY RIGID CELL
 MERV 14
 PN DR954404
 PUROLATOR

TOTAL \$ 21,696.64

STATE OF WEST VIRGINIA
Purchasing Division

PURCHASING AFFIDAVIT

VENDOR OWING A DEBT TO THE STATE:

West Virginia Code §5A-3-10a provides that: No contract or renewal of any contract may be awarded by the state or any of its political subdivisions to any vendor or prospective vendor when the vendor or prospective vendor or a related party to the vendor or prospective vendor is a debtor and the debt owed is an amount greater than one thousand dollars in the aggregate.

PUBLIC IMPROVEMENT CONTRACTS & DRUG-FREE WORKPLACE ACT:

If this is a solicitation for a public improvement construction contract, the vendor, by its signature below, affirms that it has a written plan for a drug-free workplace policy in compliance with Article 1D, Chapter 21 of the *West Virginia Code*. The vendor **must** make said affirmation with its bid submission. Further, public improvement construction contract may not be awarded to a vendor who does not have a written plan for a drug-free workplace policy in compliance with Article 1D, Chapter 21 of the *West Virginia Code* and who has not submitted that plan to the appropriate contracting authority in timely fashion. For a vendor who is a subcontractor, compliance with Section 5, Article 1D, Chapter 21 of the *West Virginia Code* may take place before their work on the public improvement is begun.

ANTITRUST:

In submitting a bid to any agency for the state of West Virginia, the bidder offers and agrees that if the bid is accepted the bidder will convey, sell, assign or transfer to the state of West Virginia all rights, title and interest in and to all causes of action it may now or hereafter acquire under the antitrust laws of the United States and the state of West Virginia for price fixing and/or unreasonable restraints of trade relating to the particular commodities or services purchased or acquired by the state of West Virginia. Such assignment shall be made and become effective at the time the purchasing agency tenders the initial payment to the bidder.

I certify that this bid is made without prior understanding, agreement, or connection with any corporation, firm, limited liability company, partnership or person or entity submitting a bid for the same materials, supplies, equipment or services and is in all respects fair and without collusion or fraud. I further certify that I am authorized to sign the certification on behalf of the bidder or this bid.

LICENSING:

Vendors must be licensed and in good standing in accordance with any and all state and local laws and requirements by any state or local agency of West Virginia, including, but not limited to, the West Virginia Secretary of State's Office, the West Virginia Tax Department, West Virginia Insurance Commission, or any other state agencies or political subdivision. Furthermore, the vendor must provide all necessary releases to obtain information to enable the Director or spending unit to verify that the vendor is licensed and in good standing with the above entities.

CONFIDENTIALITY:

The vendor agrees that he or she will not disclose to anyone, directly or indirectly, any such personally identifiable information or other confidential information gained from the agency, unless the individual who is the subject of the information consents to the disclosure in writing or the disclosure is made pursuant to the agency's policies, procedures and rules. Vendor further agrees to comply with the Confidentiality Policies and Information Security Accountability Requirements, set forth in <http://www.state.wv.us/admin/purchase/privacy/noticeConfidentiality.pdf>.

Under penalty of law for false swearing (*West Virginia Code* §61-5-3), it is hereby certified that the vendor affirms and acknowledges the information in this affidavit and is in compliance with the requirements as stated.

Vendor's Name: FILTECH, INC
Authorized Signature: *Janie Whelan* Date: 2-11-09



State of West Virginia
DRUG FREE WORKPLACE CONFORMANCE AFFIDAVIT
West Virginia Code §21-1D-5

STATE OF WEST VIRGINIA,

COUNTY OF _____, TO-WIT:

I, Harry C. Elinsky Jr., after being first duly sworn, depose and state as follows:

- 1. I am an employee of Filtech Inc; and,
(Company Name)
- 2. I do hereby attest that Filtech Inc
(Company Name)

maintains a valid written drug free workplace policy and that such policy is in compliance with **West Virginia Code** §21-1D-5.

The above statements are sworn to under the penalty of perjury.

Filtech Inc
(Company Name)

By: [Signature]

Title: President

Date: 2/11/09

Taken, subscribed and sworn to before me this 11 day of Feb, 2009.

By Commission expires Jan 8, 2012

(Seal)

COMMONWEALTH OF PENNSYLVANIA
Notarial Seal
Debra S. Kale, Notary Public
City of Pittsburgh, Allegheny County
My Commission Expires Jan. 8, 2012

Debra S. Kale
(Notary Public)

THIS AFFIDAVIT MUST BE SUBMITTED WITH THE BID IN ORDER TO COMPLY WITH WV CODE PROVISIONS. FAILURE TO INCLUDE THE AFFIDAVIT WITH THE BID SHALL RESULT IN DISQUALIFICATION OF THE BID.



FILTERS FOR AIR, GAS & LIQUIDS

CLEAN ROOM & FILTER TESTING

February 11, 2009

Division of Culture & History
Cultural Center
1900 Kanawha Blvd, East
Charleston, WV 25305-0300

Attn: Shelly Murray, Buyer

Subject: RFQ Number DCH09069
Sealed Bid Opening 2/1/09, 1:30 PM

Dear Ms. Murray,

Enclosed we are pleased to include our bid package for RFQ# DCH09069. You will notice we have quoted as specified and have also offered an alternate.

We offer the Purolator Dominator as an alternate on item 2. The Dominator filter represents the next generation of technological advances in the 4" high-efficiency box filter. It will fit your existing housings with no modifications to the current frame arrangement.

The unique Channel-Flow synthetic media construction not only provides low resistance (.46" vs .62" @ 2000 CFM) but allows more even dust loading for longer filter life and more importantly, significant energy savings over your current style of filter. Furthermore the media (as well as the rigid cell plastic frame), is unaffected by moisture and some chemicals. Filtech would be happy to provide a sample for evaluation by the end user.

I am enclosing descriptive literature on all items quoted for your review.

Please note that the prices quoted are firm for a one year period. For the remainder of the contract any price increases would be based on manufacturer's escalation. A 30 day written notice would be given prior to any changes.

Thank you for giving us this opportunity to earn your valued business. If you have any questions or we can be of further assistance please contact Dave Wright your Field Technical Representative or me direct.

Sincerely,

A handwritten signature in black ink that reads "Janie Whelan". The signature is written in a cursive, flowing style.

Janie Whelan
Filtech, Inc.

Encl.

FIBERBOND

HIGH QUALITY FILTRATION
WE MAKE MEDIA "ONE ROLL AT A TIME"

DUSTLOK® 3-PLY PANEL & LINK

SINGLE AND CONTINUOUS FILTERS - NO DIRT BY-PASS

MERV 8

FOR RETENTION OF SMALL AIR BORNE PARTICULATE

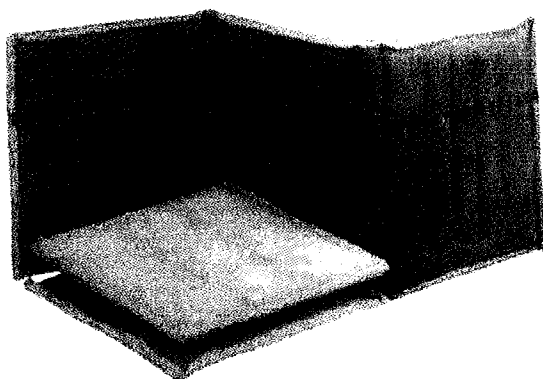

NO DIRT AROUND OR BETWEEN FILTERS

Replacing chipboard framed filters with self-sealing panels and continuous panel links will eliminate dirt from passing around or between filters.

100% filtering area - air-borne contaminants must enter the panel or panel link.

SECURITY OF DUSTLOK MEDIA

Dual-ply Dustlok media, manufactured at Fiber Bond combines performance with strength. The dual-density media with Dustlok adhesive stops and retains small particulate.

Dustlok adhesive re-activates throughout its service life.

WHY 3-PLY DUSTLOK PANEL

- ◆ TRAPS & HOLDS SMALL PARTICULATE
- ◆ NO DIRT BY-PASS
- ◆ NO DAMAGE FROM MOISTURE
- ◆ THREE PLY DEPTH LOADING
- ◆ DUSTLOK ADHESIVE
- ◆ SPOR-AX® ANTIMICROBIAL
- ◆ 100% FILTERING AREA
- ◆ MERV 8

NO MOLD GROWTH ON THE MEDIA

Spor-Ax antimicrobial is a biocide that effectively controls growth of mold, mildew, algae and fungi on the media.. Otherwise, mold growing in a filter media will increase resistance, reducing service life.

APPLICATIONS

Used in commercial and industrial air filtration systems. When clean air is important.

- | | |
|---------------|--------------------|
| ☆ APARTMENTS | ☆ LIGHT INDUSTRY |
| ☆ MALLS | ☆ OFFICE BUILDINGS |
| ☆ BANKS | ☆ SCHOOLS |
| ☆ RESTAURANTS | ☆ HOTELS |
| ☆ FAST FOOD | ☆ FOOD PROCESSING |

**"THE BEST FILTERS
 COME FROM THE BEST MEDIA"**

TECHNICAL DATA

- MERV 8 - ASHRAE 52.2-1999
- Operating temperature up to 200° F.
- Initial resistance at 295 fpm - 0.21" w.g.
- Initial resistance at 492 fpm - 0.42" w.g.
- Recommended discard point 1.0" w.g.

RESISTANCE VS AIRFLOW

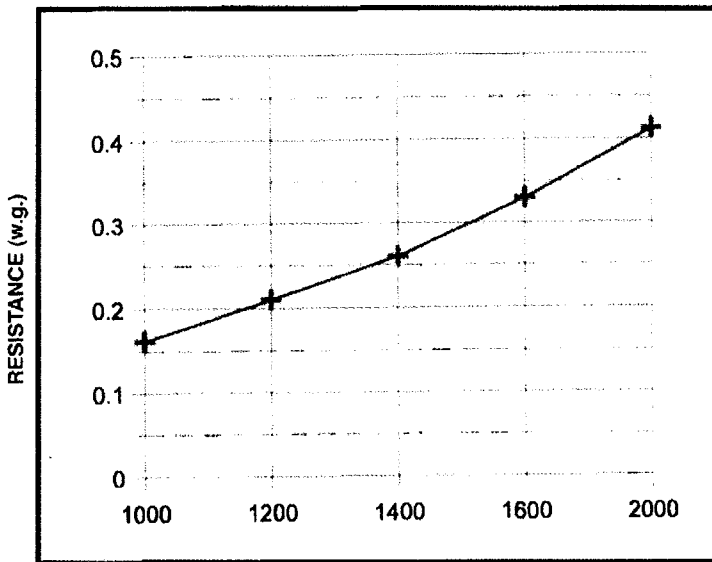

AIR FLOW (CFM)

REMOVAL EFFICIENCY VS PARTICLE SIZE

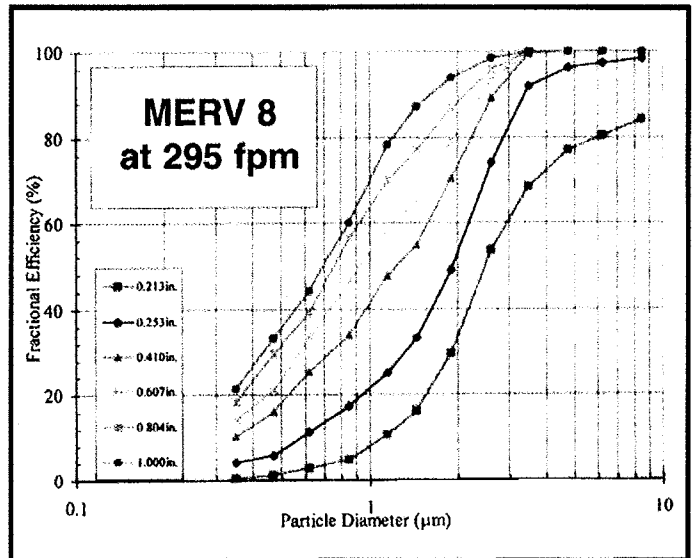

Particle Size Removal Efficiency Conducted by LMS Technologies.

REMOVAL EFFICIENCY VS PARTICLE SIZE

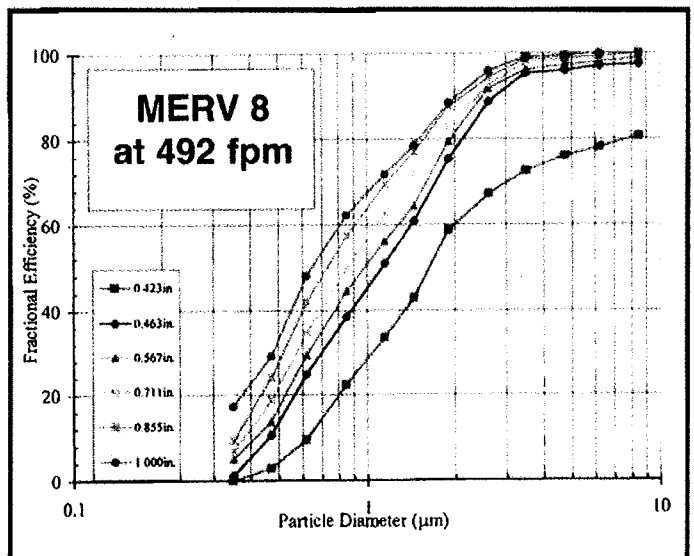

Particle Size Removal Efficiency Conducted by LMS Technologies.

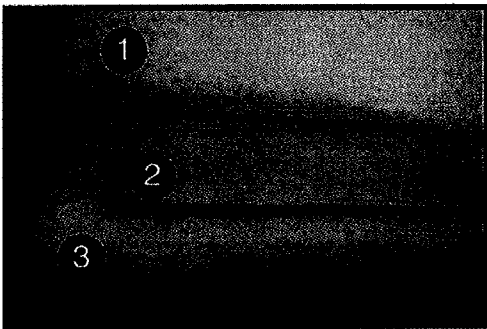

- 1.) Coarse upstream layer.
- 2.) 9 gauge wire grid.
- 3.) Downstream layer - 1" Dual-Ply Dustlok.

Dustlok® and Spor-Ax® are registered trademarks of Fiber Bond Corporation.

Fiber Bond Corporation 110 Menke Road Michigan City, IN 46360
 Tel: (219) 879-4541 Fax: (219) 874-7502 www.fiberbond.net email: info@fiberbond.net



Features:

Non-shedding,
gradient density
polypropylene media

Polypropylene injection
molded frame -
Nominal 2" & 4" depths

Polypropylene polymer
thermally bonded
separators

Media bonded to
frame using
polypropylene
adhesive

Available in 65%, 85%,
95% and 98%
efficiencies as per
ASHRAE 51.2

MERV ratings 11, 13,
14 and 15 as per
ASHRAE 52.2

UL Class II rated as
per UL 900 standard

AIRFLOW MiniPLEAT

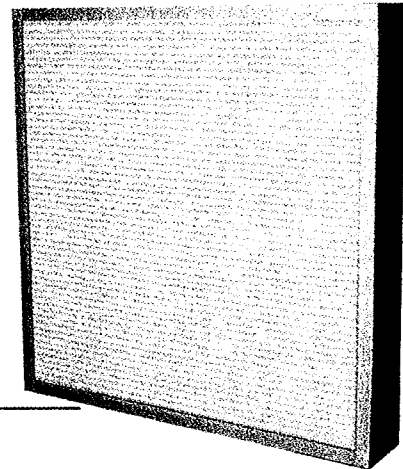

Extended surface self-supported mini-pleat filter

AIRFLOW MINI PLEAT extended surface self-supported mini pleat filters are designed for use in air filtration systems and equipment where medium to high efficiency filtration is required. Available in a wide variety of standard sizes and nominal 2" & 4" depths, the AIRFLOW MINI PLEAT provides optimal performance in variable air volume systems.

The injection molded polypropylene frame and thermally bonded polypropylene media separators provide strength and rigidity to this product.

The media pack, comprised of non-shedding, gradient density polypropylene fibers, is bonded to the inside perimeter of the enclosure frame by a moisture resistant adhesive, providing a continuous and positive seal.

The all synthetic composition of frame, media pack and separators are not adversely affected by moisture and do not support the growth of microbial organisms such as bacteria, mold and fungi, etc.

The standard offering is rated by Underwriters Laboratories as Class II, per UL Standard 900.

Rigid construction, extended surface, low initial pressure drop measured in inches w.g., long service life, savings in energy costs and shipping costs are features and benefits which make the AIRFLOW MINI PLEAT an excellent option for meeting the requirements of medium to high efficiency filtration.

AIRFLOW MiniPLEAT

The Airflow MiniPleat is made from 100% synthetic polypropylene media bonded with a water resistant adhesive to a 100% polypropylene plastic frame. The Airflow MiniPleat is available in standard sizes in nominal 2" & 4" depth in 65%, 85%, 95% and 98% efficiencies per ASHRAE 52.1.

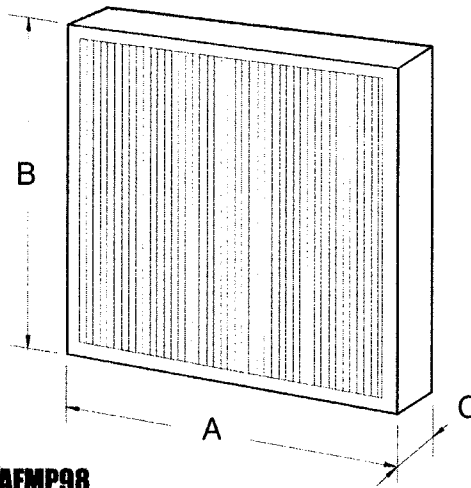

Typical Size Chart - AFMP65, AFMP85, AFMP95 and AFMP98

Model Number	Width "A"	Height "B"	Depth "C"
AFMPxx-24244	23-3/8"	23-3/8"	3-3/4"
AFMPxx-20254	19-1/2"	24-1/2"	3-3/4"
AFMPxx-20244	19-1/2"	23-3/8"	3-3/4"
AFMPxx-20204	19-1/2"	19-1/2"	3-3/4"
AFMPxx-16254	15-1/2"	24-1/2"	3-3/4"
AFMPxx-16204	15-1/2"	19-1/2"	3-3/4"
AFMPxx-12244	11-3/8"	23-3/8"	3-3/4"

Note: Also available in nominal 2" depths.

Pressure Drop vs. Flow Rate

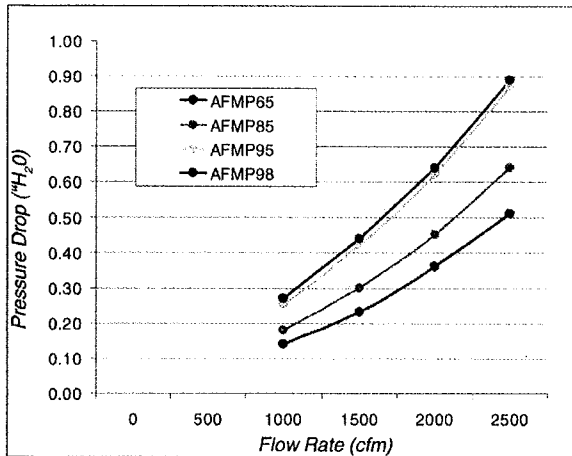

Efficiency vs. Particle Diameter

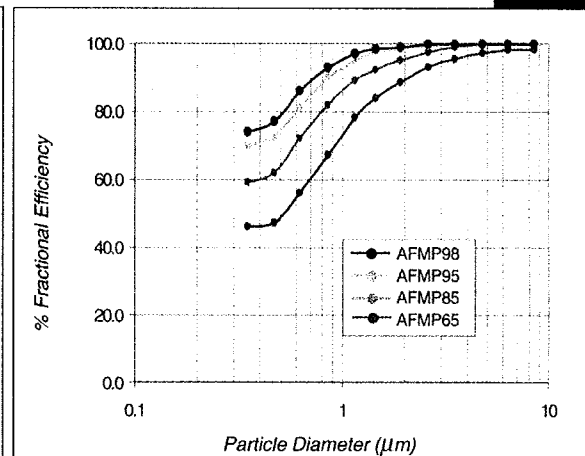

100 Oak Tree Drive
 Selma, North Carolina 27576
 (919) 975-0240 Tel
 (919) 975-0250 Fax

Distributed by:

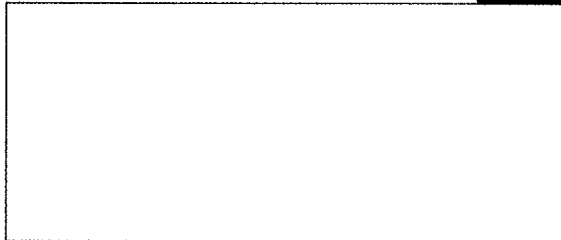

National
 Air
 Filtration
 Association



PRE-FILTER PANEL

INTERNAL SUPPORT PANELS, LINKS, & SLEEVE ROLLS & PADS

AFT's complete line of panels & links allows our customers to choose the best performance option for each particular application. The 100% polyester panels and links are unaffected by humidity and are inherently resistant to microbial growth. The various media options are heat-sealed to a heavy-duty internal support frame. They can be utilized as stand alone filters or as prefiltration in combination with high efficiency bag or rigid box filter systems. When packed in cartons, the panel design creates a space savings that results in a **50% reduction** in shipping, handling and warehousing over a standard case of 12 2" cardboard frame flat panel or pleated filters.

SERIES 625

Series 625 panels and links are designed for heavy duty commercial and industrial HVAC applications. The Series 625 filter offers a durable 3-ply structure with an internal tackifier for enhanced performance.

- MERV 8 based on 52.2-1999
- Rigid media design for high velocity application

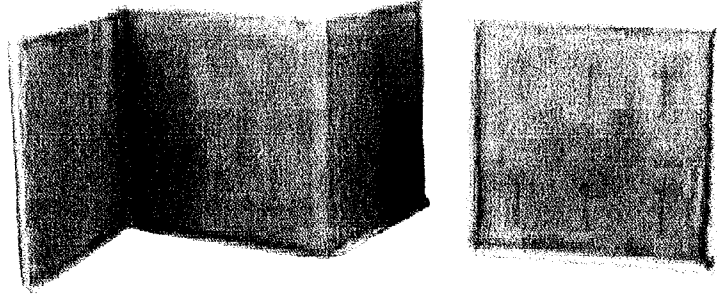
**SERIES 66 ANTIMICROBIAL ***

Series 66 panels and links are designed with an antimicrobial agent for applications where potential microbial growth may be present. Each Series 66 3-ply filter is constructed to provide MERV 8 efficiency and the added security offered by the antimicrobial agent.

- MERV 8 based on 52.2-1999
- Available in cube design as well

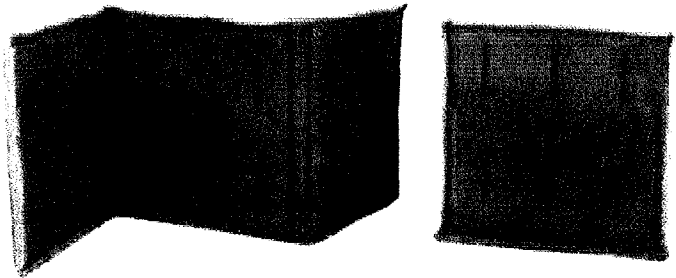
**SLEEVE ROLLS AND PADS**

AFT's dual layer sleeve rolls and pads are available in multiple styles providing several efficiency ranges (MERV 6-8) for all HVAC applications. Sleeve filters are best suited as replacements for polyester pad/frames, fiberglass and polyester disposable filters.

- 600 Series – 2 ply dry light commercial 1"
- 605 Series – 2 ply dry light commercial 1/2"
- 615 Series – 2 ply with internal tack 1" (MERV 7)
- 635 Series – 3 ply industrial with dual tack 1 1/2" (MERV 8)
- 625 Series – 3 ply industrial with internal tack 1 1/2" (MERV 8)
- 66 Series – 3 ply tacky with antimicrobial agent 1 1/2" (MERV 8)
- 2/3 CB Series – 2-3 ply with internal tack and 3/8" carbon impregnated polyester

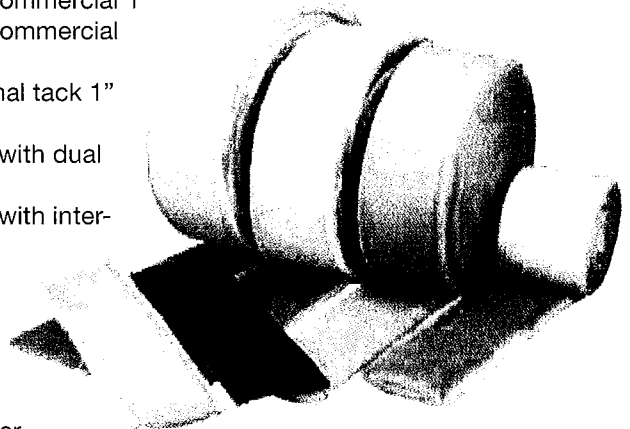

ALTERNATE BID

PRIMARY BOX FILTER

Purolator®

a CLARCOR company

PUROLATOR, a CLARCOR Company, is very excited to announce the release of a "NEW" filter called **DOMINATOR™** 4" and 12" High Efficiency Rigid Cell Extended Surface Filter.

* 4" offered in MERV 11 & 14 and 12" offered in MERV 11 & 15

The new PUROLATOR **DOMINATOR™** high efficiency filter is a perfect sustainable component for your next LEED/Green Building initiative. The **DOMINATOR™** is a MERV 15 (Standard 52.2 Minimum Efficiency Reporting Value) product with extremely low initial resistance characteristics. MERV 15 is hospital compliant for full patient care. The **DOMINATOR™** will help you increase your overall filter efficiency, to exceed LEED requirements of MERV 13, while maintaining or lowering your energy costs.

For more information regarding the new **DOMINATOR™** from PUROLATOR, please contact your nearest **PUROLATOR Stocking Distributor**, local PUROLATOR Territory Manager or a Customer Service Associate at 1-866-925-2247. You can also click the **Distributor Locator Button** at www.purolatorair.com

12" with
Single Header

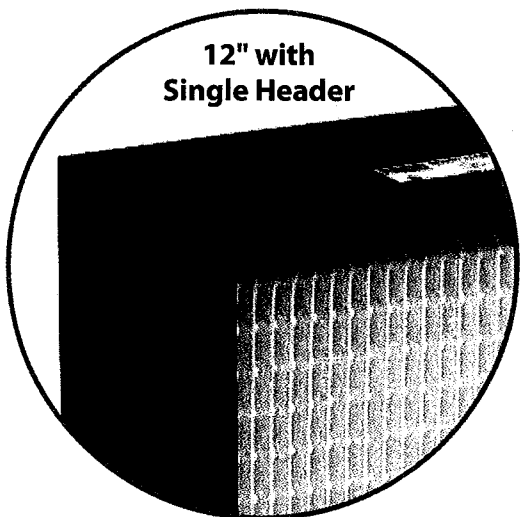

FILTECH, INC.

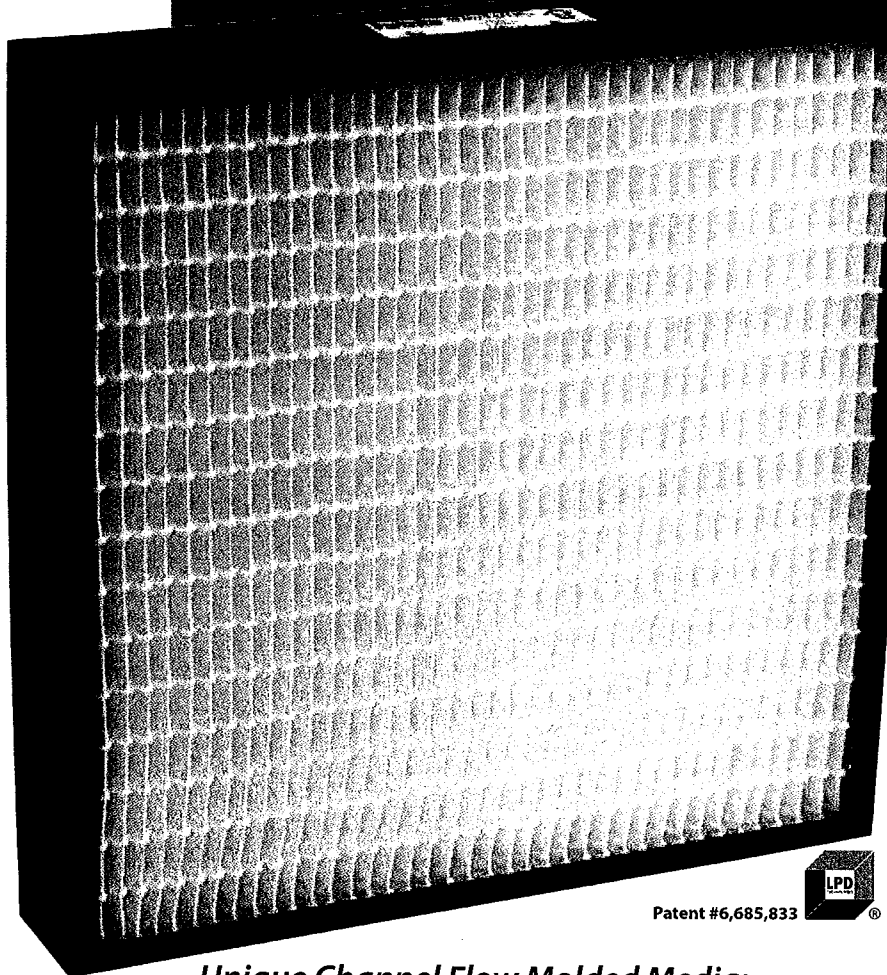

Patent #6,685,833



Unique Channel Flow Molded Media:

- 4" is MERV 11 & 14 and 12" is MERV 11 & 15
- Class 1 per U.L. Standard 900
- Very Low Resistance
- High Dust Holding Capacity
- All Plastic Construction
- Light Weight

LEED/Green Building

- Sustainable Component for a LEED/Green Building Initiative (Leadership in Engineering and Environment Design)
- Exceeds LEED/Green requirement of MERV 13
- Lower Energy Cost



4" Deep Filters - MERV 11 & 14

For use where space is limited. 4" deep DOMINATOR filters operate at 500 FPM at substantially lower resistance than competitive 4" - 6" deep filters.

12" Deep Filters - MERV 11 & 15 Single Header Construction

DOMINATOR filters replace traditional 12" deep rigid cell filters operating at 500 - 625 FPM with substantially lower resistance.

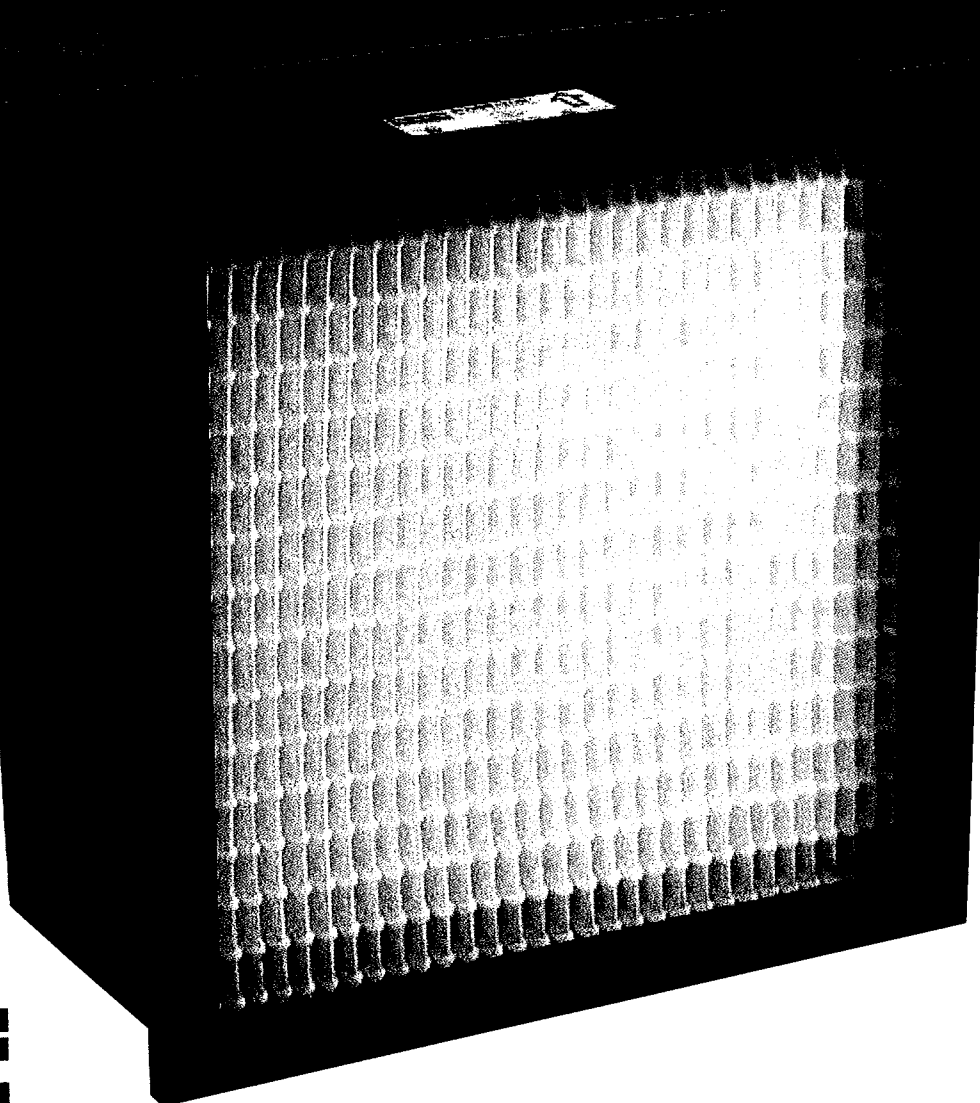

Purolator
a CLARCOR company

Unique Channel-Flow Molded Media Produces Lowest Resistance

DOMINATOR media is molded into a series of preformed channels that direct the air smoothly through the filter. This unique process results in the lowest resistance of any high efficiency filter on the market. Low resistance maximizes energy savings.

DOMINATOR Close up view shows how beads of adhesive applied to the media hold the channels open to permit free flow of air for low resistance and complete use of the media.

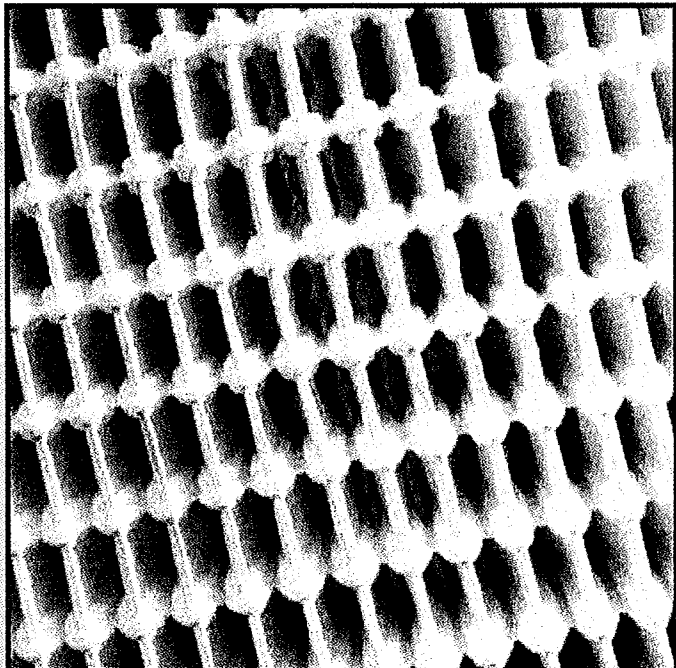

Reverse Flow Installation For Front Load Applications (12" Deep Filters)

For front load installations, or where there is no down stream access, 12" deep DOMINATOR filters are available in a reverse flow model.

Glue Bead Adhesive Strips Stabilize Pleat Pack

Beads of adhesive applied to the media bond the pleats into a totally rigid, solid pack. The pleats hold their shape and the molded channels are held open for free flow of air in all types of operating conditions. No pleat deformation, no blocking off.

Rigid Cell Design Handles Difficult Operating Conditions

Rigid cell design, all plastic components and Dura-Tuff 100% synthetic media make DOMINATOR filters ideal for the most demanding operating conditions, including variable air volume systems, high air flow, turbulence, repeated fan shut down, high moisture, and some chemical or corrosive conditions. These filters are designed for tough installations.

Full Media Exposure Produces High Dust Holding Capacity

The Channel-Flow molded media design not only produces low resistance, it also allows the media to be completely exposed to dirt laden air. Dirt loads evenly over every square foot of filter surface area for maximum dust holding capacity and long service life.

All Plastic Construction – Completely Incinerable, Light Weight

The cell sides are made of high strength, high impact polystyrene plastic. They are moisture, chemical and corrosion resistant. DOMINATOR filters contain no metal components – no rust, no corrosion. The elimination of metal also makes these filters completely incinerable and light weight.

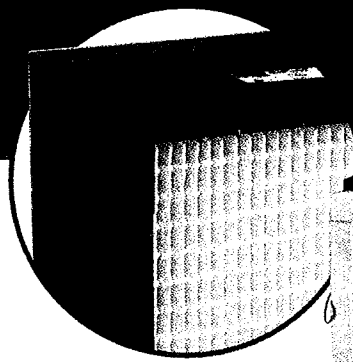

Spring latches are used to secure the 12" Reverse Flow DOMINATOR filter to the holding frame.

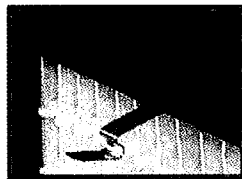

2" & 4" pre-filter clips hold the pre-filter to the Reverse Flow DOMINATOR filter.

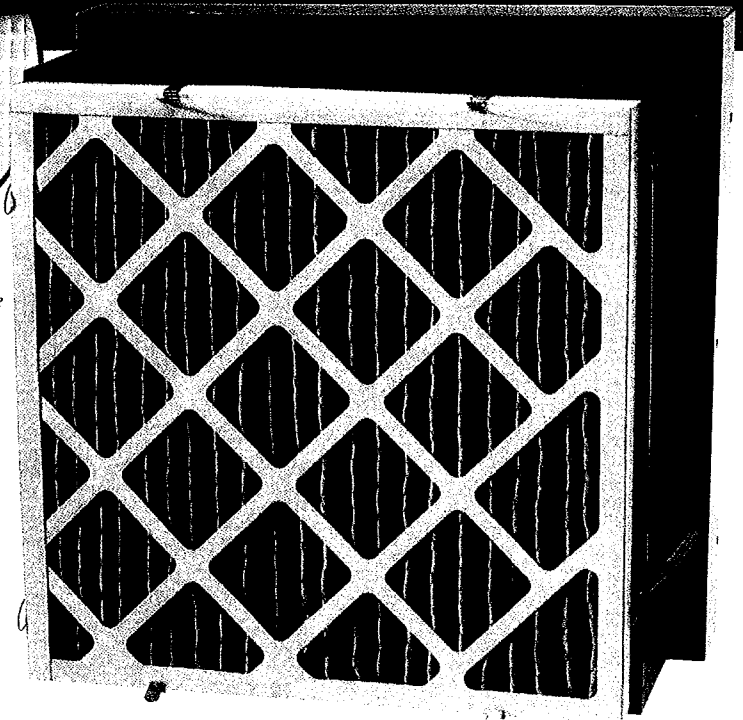

Various sized metal frames are available to make the DOMINATOR suitable for most any application.

Dura-Tuff™ 100% Synthetic Media

DOMINATOR filters are made with Dura-Tuff synthetic media. It is extremely durable, resists tearing, abrasion and is highly damage resistant. No more media damage during shipping, handling or installation. Dura-Tuff media is also unaffected by exposure to moisture and some chemicals. This media is just plain tough.

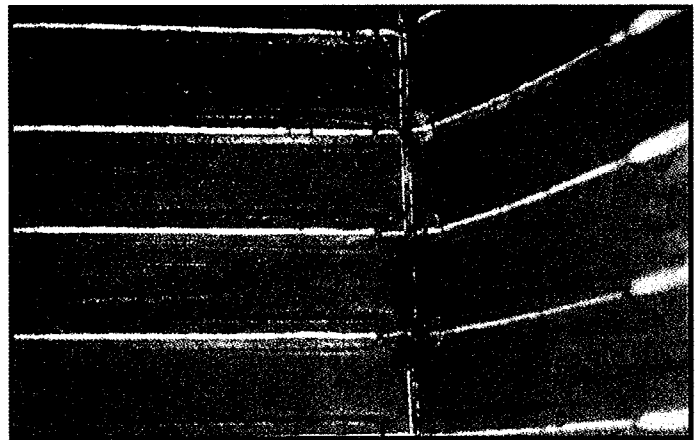

See how the preformed channels allow dirt to be collected all the way to the back of the pleats. Every square foot of media is fully utilized for maximum dust capacity.

Model Number	Nominal Size (HxWxD) Inches	Actual Size (HxWxD) Inches	Rated Air Flow Capacity (CFM)	Initial Resistance (In. W. G.) @Rated Air Flow MERV 14,15	Initial Resistance (In. W. G.) @Rated Air Flow MERV 11	Recommended Final Resistance (In. W. G.)
--------------	-----------------------------	----------------------------	-------------------------------	-----------------------------------------------------------	--------------------------------------------------------	------------------------------------------

12" Packs - Single Header

DR65-4412	24x24x12	23 ³ / ₈ x 23 ³ / ₈ x 11 ¹ / ₂	2000	-	.26"	1.5"
DR65-0412	20x24x12	19 ³ / ₈ x 23 ³ / ₈ x 11 ¹ / ₂	1650	-	.26"	1.5"
DR65-0012	20x20x12	19 ³ / ₈ x 19 ³ / ₈ x 11 ¹ / ₂	1400	-	.26"	1.5"
DR65-2412	12x24x12	11 ³ / ₈ x 23 ³ / ₈ x 11 ¹ / ₂	1000	-	.26"	1.5"
DR95-4412	24x24x12	23 ³ / ₈ x 23 ³ / ₈ x 11 ¹ / ₂	2000	.34"	-	1.5"
DR95-0412	20x24x12	19 ³ / ₈ x 23 ³ / ₈ x 11 ¹ / ₂	1650	.34"	-	1.5"
DR95-0012	20x20x12	19 ³ / ₈ x 19 ³ / ₈ x 11 ¹ / ₂	1400	.34"	-	1.5"
DR95-2412	12x24x12	11 ³ / ₈ x 23 ³ / ₈ x 11 ¹ / ₂	1000	.34"	-	1.5"

4" Packs

DR65-4404	24x24x4	23 ³ / ₈ x 23 ³ / ₈ x 3 ³ / ₄	2000	-	.23"	1.5"
DR65-0504	20x25x4*	19 ³ / ₈ x 24 ³ / ₈ x 3 ³ / ₄	1750	-	.23"	1.5"
DR65-0404	20x24x4	19 ³ / ₈ x 23 ³ / ₈ x 3 ³ / ₄	1650	-	.23"	1.5"
DR65-0004	20x20x4	19 ³ / ₈ x 19 ³ / ₈ x 3 ³ / ₄	1400	-	.23"	1.5"
DR65-6504	16x25x4*	15 ³ / ₈ x 24 ³ / ₈ x 3 ³ / ₄	1400	-	.23"	1.5"
DR65-6004	16x20x4	15 ³ / ₈ x 19 ³ / ₈ x 3 ³ / ₄	1100	-	.23"	1.5"
DR65-2404	12x24x4	11 ³ / ₈ x 23 ³ / ₈ x 3 ³ / ₄	1100	-	.23"	1.5"
DR95-4404	24x24x4	23 ³ / ₈ x 23 ³ / ₈ x 3 ³ / ₄	2000	.43"	-	1.5"
DR95-0504	20x25x4*	19 ³ / ₈ x 24 ³ / ₈ x 3 ³ / ₄	1750	.43"	-	1.5"
DR95-0404	20x24x4	19 ³ / ₈ x 23 ³ / ₈ x 3 ³ / ₄	1650	.43"	-	1.5"
DR95-0004	20x20x4	19 ³ / ₈ x 19 ³ / ₈ x 3 ³ / ₄	1400	.43"	-	1.5"
DR95-6504	16x25x4*	15 ³ / ₈ x 24 ³ / ₈ x 3 ³ / ₄	1400	.43"	-	1.5"
DR95-6004	16x20x4	15 ³ / ₈ x 19 ³ / ₈ x 3 ³ / ₄	1100	.43"	-	1.5"
DR95-2404	12x24x4	11 ³ / ₈ x 23 ³ / ₈ x 3 ³ / ₄	1100	.43"	-	1.5"

* Reverse size pleat on 25" height product.

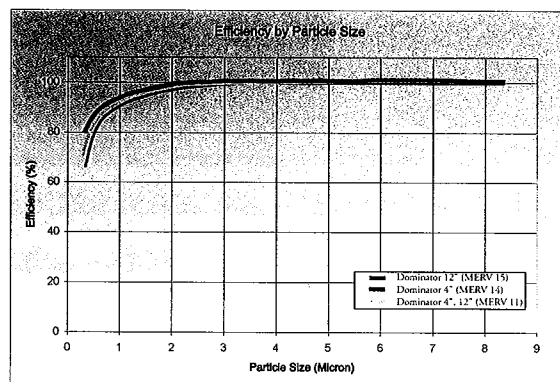
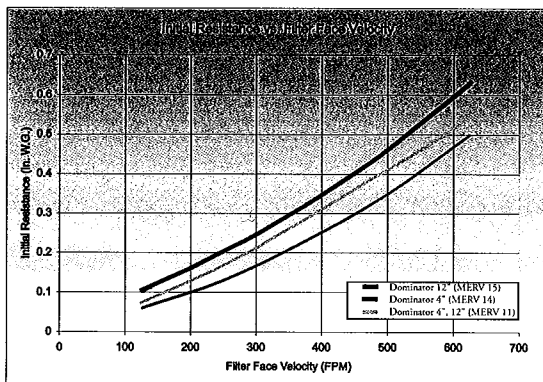

IMPORTANT NOTES:

1. All performance data is based on the ASHRAE 52.2 Test Standard
2. Width and height dimensions are interchangeable. DOMINATOR filters can be installed with the pleats vertical or horizontal
3. Continuous Operating Temperature: 140°F (60°C).

Underwriters Laboratories Inc. Classification:

DOMINATOR filters are classified Class 1 per U.L. Standard 900.

Energy Savings Calculator available online at www.purolatorair.com

Sustainable Component for a LEED/Green Building Initiative.
Exceeds LEED/Green requirement of MERV 13.
 (Leadership in Engineering and Environment Design) www.usgbc.org

P-DOM-0208

Purolator
 a CLARCOR company

www.purolatorair.com



CLARCOR Air Filtration Products
 P.O. Box 32578 • Louisville, KY 40232
 Customer Service Team: 1-866-925-2247 • Fax: 1-800-784-3458
 Email: info@purolatorair.com • www.purolatorair.com

Distributed by:

© 2008 CLARCOR Air Filtration Products.
 CLARCOR Air Filtration Products has a policy of continuous product research and development and reserves the right to change design and specifications without notice. Terms and Conditions of Sale can be accessed in the "LOGIN" section at www.purolatorair.com

Dominator 4" Depth

HIGH CAPACITY EXTENDED SURFACE MINI-PLEAT FILTERS

1.0 Scope

This specification covers extended surface, mini-pleat filters that are a component of heating, ventilating and air conditioning systems.

2.0 Construction

The filters consist of a pleated synthetic media pack contained in cell sides made of high impact plastic.

2.1 Media

The media shall be made of a continuous sheet of Dura-Tuff™ 100% synthetic media pleated to form an extended surface, mini-pleat media pack. The media shall be molded into a series of preformed channels that will direct airflow through the pack.

The media shall be water resistant. Humidity or exposure to sensible moisture shall have no affect on the performance of the filters other than a temporary rise in resistance.

The media shall be very durable and highly resistant to tearing or abrasion.

2.2 Media Pack

The media shall be molded into a series of preformed channels that shall form the pleats. Beads of adhesive shall be applied to the media, bonding the pleats into a rigid pack.

2.3 Cell Sides

The cell sides shall be made of a high strength, high impact polystyrene plastic. The frame shall be moisture, chemical and corrosion resistant. The frame shall mechanically lock together at each corner.

2.4 Adhesive

The media pack shall be sealed into the cell sides by foamed hot-melt adhesive, preventing bypass between the pack and frame.

2.6 Media Area

The filters shall contain a minimum amount of media per the following schedule:

24x24x4 49 ft²

3.0 Performance

The filters shall meet the following minimum performance requirements based on the ASHRAE 52.2 Test Standards. Tests conducted on 24x24 size filters shall be representative of the performance of all sizes purchased.

Performance Requirements	Model	
	DR95-4404 24x24x4	DR65-4404 24x24x4
Rated Air Flow Capacity (CFM)	2000	2000
Initial Resistance @ 500 FPM (In. W.G.)	.43"	.23"
Final Resistance (In. W.G.)	1.50"	1.50"
MERV Rating	14	11

4.0 Underwriters Laboratories Classification

The filters shall be classified Class 1 per U.L. Standard 900.

5.0 Incinerable

The filters shall be totally incinerable. No metal components are acceptable.

6.0 Operating Temperature Limits

The filter shall operate at temperatures up to 140°F (60°C) without materially affecting filter integrity or performance.

7.0 Bid Attachments

One (1) ASHRAE 52.2 test report from a commercially operated test lab or a private test facility with an ISO 9001 Registration.

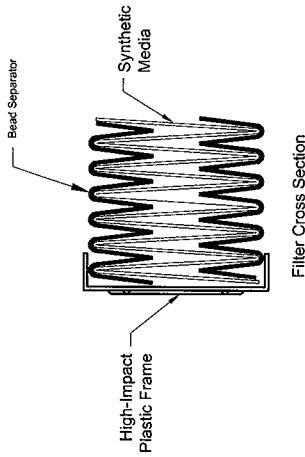
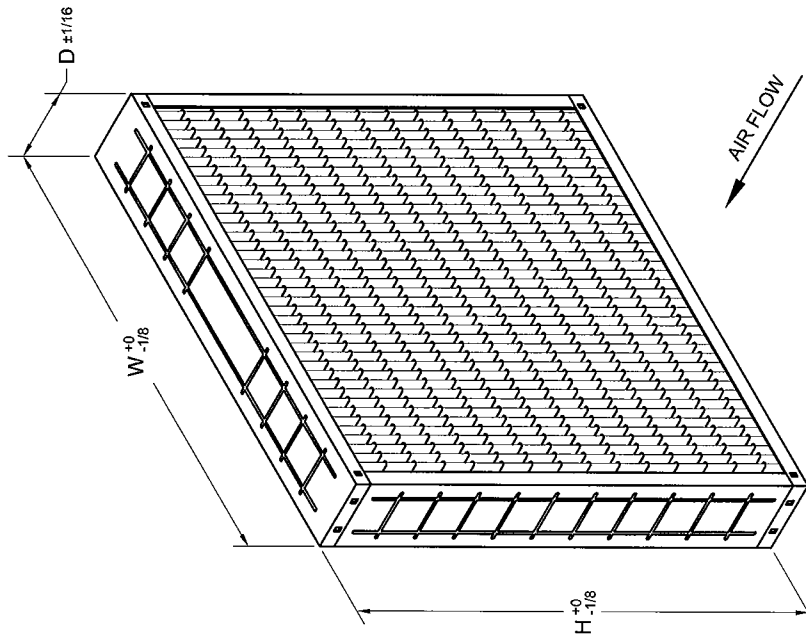

MODEL NUMBER	NOMINAL SIZE (INCHES) HXWXD	ACTUAL SIZE (INCHES) HXWXD	RATED AIR FLOW (CFM)	95% INITIAL RESISTANCE (in. W.G.)	MEDIA AREA (SQUARE FEET)	MERV RATING
DR95-4404	24X24X4	23-3/8X23-3/8X3-3/4	2000	.43	49.1	14
DR95-0504	20X25X4	19-3/8X24-3/8X3-3/4	1750	.43	42.7	14
DR95-0404	20X24X4	19-3/8X23-3/8X3-3/4	1650	.43	40.9	14
DR95-0004	20X20X4	19-3/8X19-3/8X3-3/4	1400	.43	33.9	14
DR95-6504	16X25X4	15-3/8X24-3/8X3-3/4	1400	.43	34.1	14
DR95-6004	16X20X4	15-3/8X19-3/8X3-3/4	1100	.43	27.1	14
DR95-2404	12X24X4	11-3/8X23-3/8X3-3/4	1000	.43	23.4	14
DR65-4404	24X24X4	23-3/8X23-3/8X3-3/4	2000	.23	49.1	11
DR65-0504	20X25X4	19-3/8X24-3/8X3-3/4	1750	.23	42.7	11
DR65-0404	20X24X4	19-3/8X23-3/8X3-3/4	1650	.23	40.9	11
DR65-0004	20X20X4	19-3/8X19-3/8X3-3/4	1400	.23	33.9	11
DR65-6504	16X25X4	15-3/8X24-3/8X3-3/4	1400	.23	34.1	11
DR65-6004	16X20X4	15-3/8X19-3/8X3-3/4	1100	.23	27.1	11
DR65-2404	12X24X4	11-3/8X23-3/8X3-3/4	1000	.23	23.4	11

STANDARD CONSTRUCTION

1. 100% Synthetic Media
2. Bead Separator Packs
3. High-Impact Plastic Frame Panels
4. Foamed Hot Melt Sealant

NOTES

1. Testing per ASHRAE 52.2-1999
2. Final Resistance: 1.5" W.G.
3. Rated Velocity - 500 FPM
4. Maximum Operating Temperature: 140 deg. F
5. Class 1 Filter per UL Standard 900
6. Special Sizes Not Available

Purolator
a CLAYCOX company
 P.O. Box 32578
 Louisville, KY 40232
 P: 866-925-2247
 F: 502-961-0930
 www.purolatorair.com

CONTACT FACTORY TO
 VERIFY REVISION LEVEL

TOLERANCES UNLESS OTHERWISE SPECIFIED	
FRACTIONAL	-
DECIMAL	-
ANGLES	-
ALL DIMENSIONS IN INCHES	

DRAWING NAME 4" DOMINATOR	
APPROVED BY <i>K. Coleman</i>	SPECIFICATION NO. MKT-P-00527
SCALE NONE	DWG. SIZE A
REVISION B	REVISION DATE 01-23-2008
PAGE 1 OF 1	

CONFIDENTIAL - DO NOT COPY. THIS MATERIAL IS TRADE SECRET AND PROPRIETARY BEING EXCLUSIVELY OWNED BY PuroLator. THE INFORMATION CONTAINED HEREIN IS PROTECTED UNDER FEDERAL COPYRIGHT LAWS AND ALL COPYING IS PROHIBITED AND MAY BE SUBJECT TO CRIMINAL PENALTIES.