



State of West Virginia
 Department of Administration
 Purchasing Division
 2019 Washington Street East
 Post Office Box 50130
 Charleston, WV 25305-0130

Request for Quotation

RFQ NUMBER
ABC95

PAGE
1

ADDRESS CORRESPONDENCE TO ATTENTION OF
SHELLY MURRAY
304-558-8801

RFQ COPY
TYPE NAME/ADDRESS HERE

Camel Technologies, LLC
 1326 Ohio Avenue
 Dunbar, WV 25064

ALCOHOL BEVERAGE CONTROL
COMMISSION
HUB INDUSTRIAL PARK
RIVER ROAD
NITRO, WV
25143 **558-2487**

DATE PRINTED	TERMS OF SALE	SHIP VIA	F.O.B.	FREIGHT TERMS
05/01/2008				

BID OPENING DATE: **06/18/2008** BID OPENING TIME **01:30PM**

LINE	QUANTITY	UOP	CAT. NO.	ITEM NUMBER	UNIT PRICE	AMOUNT
<p>REQUEST FOR QUOTATION</p> <p>THE WEST VIRGINIA PURCHASING DIVISION, FOR THE AGENCY, WV ALCOHOL BEVERAGE CONTROL ADMINISTRATION, IS SOLICITING BIDS TO PROVIDE AND INSTALL A SECURITY SYSTEM AT THE ABC WAREHOUSE LOCATED IN NITRO, WV.</p> <p>ATTACHMENTS: SPECIFICATIONS BID BOND INSTRUCTIONS PURCHASING AFFIDAVIT</p> <p>A MANDATORY PRE-BID CONFERENCE WILL BE HELD 5/28/08 AT 3:00 PM AT 500 RIVER ROAD, HUB INDUSTRIAL PARK, NITRO, WV 25143.</p> <p>FAILURE TO ATTEND THIS MANDATORY PRE-BID CONFERENCE WILL RESULT IN BID DISQUALIFICATION.</p> <p>INQUIRES: WRITTEN QUESTIONS SHALL BE ACCEPTED THROUGH CLOSE OF BUSINESS ON 5/30/08. QUESTIONS MAY BE SENT VIA USPS, FAX, COURIER, OR EMAIL. IN ORDER TO ASSURE NO VENDOR RECEIVES AN UNFAIR ADVANTAGE, NO SUBSTANTIVE QUESTIONS WILL BE ANSWERED ORALLY. IF POSSIBLE, EMAIL QUESTIONS ARE PREFERRED. ADDRESS INQUIRES TO:</p> <p>SHELLY MURRAY DEPARTMENT OF ADMINISTRATION PURCHASING DIVISION 2019 WASHINGTON STREET, EAST CHARLESTON, WV 25311 FAX: 304-558-4115 EMAIL: SHELLY.L.MURRAY@WV.GOV</p>						

SEE REVERSE SIDE FOR TERMS AND CONDITIONS

SIGNATURE 	TELEPHONE 304-776-8063	DATE 7-1-2008
TITLE Manager	FEIN 55-0771021	ADDRESS CHANGES TO BE NOTED ABOVE

WHEN RESPONDING TO RFQ, INSERT NAME AND ADDRESS IN SPACE ABOVE LABELED 'VENDOR'

RECEIVED

08 JUL -2 AM 10: 14

PURCHASING DIVISION
STATE OF WY



State of West Virginia
 Department of Administration
 Purchasing Division
 2019 Washington Street East
 Post Office Box 50130
 Charleston, WV 25305-0130

Request for Quotation

RFQ NUMBER
ABC95

PAGE
2

ADDRESS CORRESPONDENCE TO ATTENTION OF
SHELLY MURRAY
304-558-8801

RFQ COPY

TYPE NAME/ADDRESS HERE

Camel TEchnologies, LLC
 1326 Ohio Avenue
 Dunbar, WV 25064

SHIP TO

ALCOHOL BEVERAGE CONTROL
 COMMISSION
 HUB INDUSTRIAL PARK
 RIVER ROAD
 NITRO, WV
 25143
 558-2487

DATE PRINTED	TERMS OF SALE	SHIP VIA	F.O.B.	FREIGHT TERMS
05/01/2008				

BID OPENING DATE: **06/18/2008** BID OPENING TIME **01:30PM**

LINE	QUANTITY	UOP	CAT NO	ITEM NUMBER	UNIT PRICE	AMOUNT
0001	1	LS		906-78		
<p>SECURITY SYSTEMS</p> <p>EXHIBIT 5</p> <p>NOTICE TO PROCEED: THIS CONTRACT IS TO BE PERFORMED WITHIN 60 CALENDAR DAYS AFTER THE NOTICE TO PROCEED IS RECEIVED. UNLESS OTHERWISE SPECIFIED, THE FULLY EXECUTED PURCHASE ORDER WILL BE CONSIDERED NOTICE TO PROCEED.</p> <p>CANCELLATION: THE DIRECTOR OF PURCHASING RESERVES THE RIGHT TO CANCEL THIS CONTRACT IMMEDIATELY UPON WRITTEN NOTICE TO THE VENDOR IF THE MATERIALS OR WORKMANSHIP SUPPLIED ARE OF AN INFERIOR QUALITY OR DO NOT CONFORM WITH THE SPECIFICATIONS OF THE BID AND CONTRACT HERE IN.</p> <p>WAGE RATES: THE CONTRACTOR OR SUBCONTRACTOR SHALL PAY THE HIGHER OF THE U.S. DEPARTMENT OF LABOR MINIMUM WAGE RATES AS ESTABLISHED FOR PUTNAM COUNTY, PURSUANT TO WEST VIRGINIA CODE 21-5A, ET, SEQ. (PREVAILING WAGE RATES APPLY TO THIS PROJECT)</p> <p>ARBITRATION: ANY REFERENCES MADE TO ARBITRATION OR INTEREST FOR PAYMENTS DUE (EXCEPT FOR ANY INTEREST REQUIRED BY STATE LAW) CONTAINED IN THIS CONTRACT OR IN ANY AMERICAN INSTITUTE OF ARCHITECTS DOCUMENTS PERTAINING TO THIS CONTRACT ARE HEREBY DELETED.</p> <p>WORKERS' COMPENSATION: VENDOR IS REQUIRED TO PROVIDE A CERTIFICATE FROM WORKERS' COMPENSATION IF SUCCESSFUL.</p>						

SEE REVERSE SIDE FOR TERMS AND CONDITIONS

SIGNATURE 	TELEPHONE 304-776-8063	DATE 7-1-2008
TITLE Manager	FEIN 5500771021	ADDRESS CHANGES TO BE NOTED ABOVE

WHEN RESPONDING TO RFQ, INSERT NAME AND ADDRESS IN SPACE ABOVE LABELED 'VENDOR'



State of West Virginia
 Department of Administration
 Purchasing Division
 2019 Washington Street East
 Post Office Box 50130
 Charleston, WV 25305-0130

Request for Quotation

RFQ NUMBER
ABC95

PAGE
3

ADDRESS CORRESPONDENCE TO ATTENTION OF
**SHELLY MURRAY
 304-558-8801**

**RFQ COPY
 TYPE NAME/ADDRESS HERE**

Camel Technologies, LLC
 1326 Ohio Avenue
 Dunbar, WV 25064

**ALCOHOL BEVERAGE CONTROL
 COMMISSION
 HUB INDUSTRIAL PARK
 RIVER ROAD
 NITRO, WV
 25143 558-2487**

DATE PRINTED	TERMS OF SALE	SHIP VIA	FOB	FREIGHT TERMS
05/01/2008				

BID OPENING DATE: **06/18/2008** BID OPENING TIME **01:30PM**

LINE	QUANTITY	UOP	CAT NO	ITEM NUMBER	UNIT PRICE	AMOUNT
<p>ALL OF THE ITEMS CHECKED BELOW WILL BE A REQUIREMENT OF THIS CONTRACT:</p> <p>(XX) INSURANCE: SUCCESSFUL VENDOR SHALL FURNISH PROOF OF COMMERCIAL GENERAL LIABILITY INSURANCE PRIOR TO ISSUANCE OF CONTRACT. UNLESS OTHERWISE SPECIFIED IN THE BID DOCUMENTS, THE MINIMUM AMOUNT OF INSURANCE COVERAGE REQUIRED IS \$250,000.</p> <p>() BUILDERS RISK INSURANCE: SUCCESSFUL VENDOR SHALL FURNISH PROOF OF BUILDERS RISK - ALL RISK INSURANCE IN AN AMOUNT EQUAL TO 100% OF THE AMOUNT OF THE CONTRACT.</p> <p>(XX) BONDS: FIVE PERCENT (5%) OF THE TOTAL AMOUNT OF THE BID PAYABLE TO THE STATE OF WEST VIRGINIA, SHALL BE SUBMITTED WITH EACH BID AS A BID BOND. THE SUCCESSFUL BIDDER SHALL ALSO FURNISH A PERFORMANCE BOND AND LABOR/MATERIAL BOND FOR 100% OF THE AMOUNT OF THE CONTRACT. BONDS MAY BE PROVIDED IN THE FORM OF A CERTIFIED CHECK, IRREVOCABLE LETTER OF CREDIT, OR BOND FURNISHED BY A SOLVENT SURETY COMPANY AUTHORIZED TO DO BUSINESS IN THE STATE OF WEST VIRGINIA. A LETTER OF CREDIT SUBMITTED IN LIEU OF A PERFORMANCE AND LABOR & MATERIAL BOND WILL ONLY BE ALLOWED FOR PROJECTS UNDER \$100,000. PERSONAL OR BUSINESS CHECKS ARE NOT ACCEPTABLE IN LIEU OF THE 5% BID BOND, PERFORMANCE BOND, OR LABOR AND MATERIAL BOND.</p> <p>() MAINTENANCE BOND: A TWO (2) YEAR MAINTENANCE BOND COVERING THE ROOFING SYSTEM WILL BE A REQUIREMENT OF THE SUCCESSFUL VENDOR.</p> <p>REV. 11/00</p> <p>EXHIBIT 7</p>						

SEE REVERSE SIDE FOR TERMS AND CONDITIONS

SIGNATURE 	TELEPHONE 304-776-8063	DATE 7-1-2008
TITLE Manager	FEBN 5500771021	ADDRESS CHANGES TO BE NOTED ABOVE

WHEN RESPONDING TO RFQ, INSERT NAME AND ADDRESS IN SPACE ABOVE LABELED 'VENDOR'



State of West Virginia
 Department of Administration
 Purchasing Division
 2019 Washington Street East
 Post Office Box 50130
 Charleston, WV 25305-0130

Request for Quotation

RFQ NUMBER
ABC95

PAGE
4

ADDRESS CORRESPONDENCE TO ATTENTION OF
SHELLY MURRAY 304-558-8801

VENDOR

RFQ COPY
 TYPE NAME/ADDRESS HERE

Camel Technologies, LLC
 1326 Ohio Avenue
 Dunbar, WV 25064

SHIP TO

ALCOHOL BEVERAGE CONTROL
 COMMISSION
 HUB INDUSTRIAL PARK
 RIVER ROAD
 NITRO, WV
 25143 558-2487

DATE PRINTED	TERMS OF SALE	SHIP VIA	F.O.B.	FREIGHT TERMS
05/01/2008				

BID OPENING DATE: 06/18/2008 BID OPENING TIME 01:30PM

LINE	QUANTITY	UOP	CAT NO	ITEM NUMBER	UNIT PRICE	AMOUNT
<p>DOMESTIC ALUMINUM, GLASS & STEEL IN PUBLIC WORKS PROJECTS</p> <p>IN ACCORDANCE WITH WEST VIRGINIA CODE 5-19-1 ET., SEQ., EVERY CONTRACT FOR CONSTRUCTION, RECONSTRUCTION, ALTERATION, REPAIR, IMPROVEMENT OR MAINTENANCE OF PUBLIC WORKS, WHERE THE COST IS MORE THAN \$50,000 AND, IN THE CASE OF STEEL ONLY, WHERE THE COST OF STEEL IS MORE THAN \$50,000 OR WHERE MORE THAN 10,000 POUNDS OF STEEL ARE REQUIRED, THE STATE WILL ACCEPT ONLY ALUMINUM GLASS, OR STEEL PRODUCTS PRODUCED IN THE UNITED STATES IN ADDITION, ITEMS OF MACHINERY OR EQUIPMENT PURCHASED FOR USE AT THE SITE OF PUBLIC WORKS SHALL BE MADE OF DOMESTIC ALUMINUM, GLASS OR STEEL, UNLESS THE COST OF THE PRODUCT IS LESS THAN \$50,000 OR LESS THAN 10,000 POUNDS OF STEEL ARE USED IN PUBLIC WORKS PROJECTS.</p> <p>FOREIGN MADE ALUMINUM, GLASS OR STEEL PRODUCTS MAY BE ACCEPTED ONLY IF THE COST OF DOMESTIC PRODUCTS IS FOUND TO BE UNREASONABLE. SUCH COST IS UNREASONABLE IF IT IS 20% OR MORE HIGHER THAN THE BID PRICE FOR FOREIGN MADE PRODUCTS. IF THE DOMESTIC ALUMINUM, GLASS OR STEEL PRODUCTS TO BE SUPPLIED OR PRODUCED IN A "SUBSTANTIAL LABOR SURPLUS AREA", AS DEFINED BY THE UNITED STATES DEPARTMENT OF LABOR, FOREIGN PRODUCTS MAY BE SUPPLIED ONLY IF DOMESTIC PRODUCTS ARE 30% OR MORE HIGHER IN PRICE THAN THE FOREIGN MADE PRODUCTS.</p> <p>IF, PRIOR TO THE AWARD OF A CONTRACT UNDER THE ABOVE PROVISIONS, THE SPENDING OFFICER OF THE SPENDING UNIT DETERMINES THAT THERE EXISTS A BID FOR LIKE FOREIGN ALUMINUM, GLASS OR STEEL THAT IS REASONABLE AND LOWER THAN THE LOWEST BID DOMESTIC PRODUCTS, THE SPENDING OFFICE MAY REQUEST, IN WRITING, A REEVALUATION AND REDUCTION IN THE LOWEST BID FOR SUCH DOMESTIC PRODUCTS</p>						

SEE REVERSE SIDE FOR TERMS AND CONDITIONS

SIGNATURE	TELEPHONE	DATE
	304-776-8063	7-1-2008
TITLE	FEIN	ADDRESS CHANGES TO BE NOTED ABOVE
Manager	55-0771021	

WHEN RESPONDING TO RFQ, INSERT NAME AND ADDRESS IN SPACE ABOVE LABELED 'VENDOR'



State of West Virginia
 Department of Administration
 Purchasing Division
 2019 Washington Street East
 Post Office Box 50130
 Charleston, WV 25305-0130

Request for Quotation

RFQ NUMBER
ABC95

PAGE
5

ADDRESS CORRESPONDENCE TO ATTENTION OF
**SHELLY MURRAY
 304-558-8801**

BIDDING

RFQ COPY
TYPE NAME/ADDRESS HERE
 Camel Technologies, LLC
 1326 Ohio Avenue
 Dunbar, WV 25064

SHIP TO

**ALCOHOL BEVERAGE CONTROL
 COMMISSION
 HUB INDUSTRIAL PARK
 RIVER ROAD
 NITRO, WV
 25143** **558-2487**

DATE PRINTED	TERMS OF SALE	SHIP VIA	FOB	FREIGHT TERMS
05/01/2008				
BID OPENING DATE: 06/18/2008		BID OPENING TIME 01:30PM		

LINE	QUANTITY	UOF	CAT. NO.	ITEM NUMBER	UNIT PRICE	AMOUNT
<p>ALL VENDORS MUST INDICATE IN THEIR BID IF THEY ARE SUPPLYING FOREIGN ALUMINUM, GLASS OR STEEL.</p> <p>REV. 3/88</p> <p>EXHIBIT 9</p> <p>NOTICE FOR ISSUANCE & ACKNOWLEDGEMENT OF CONSTRUCTION PROJECT ADDENDA</p> <p>THE ARCHITECT/ENGINEER AND/OR AGENCY SHALL BE REQUIRED TO ABIDE BY THE FOLLOWING SCHEDULE IN ISSUING CONSTRUCTION PROJECT ADDENDA FOR STATE AGENCIES:</p> <p>(1) THE ARCHITECT/ENGINEER SHALL PREPARE THE ADDENDUM AND A LIST OF ALL PARTIES THAT HAVE PROCURED DRAWINGS AND SPECIFICATIONS FOR THE PROJECT. THE ADDENDUM AND LIST SHALL BE FORWARDED TO THE BUYER IN THE STATE PURCHASING DIVISION. THE ARCHITECT/ENGINEER SHALL ALSO SEND A COPY OF THE ADDENDUM TO THE STATE AGENCY FOR WHICH THE CONTRACT IS ISSUED.</p> <p>(2) THE BUYER SHALL SEND THE ADDENDUM TO ALL INTERESTED PARTIES AND, IF NECESSARY, EXTEND THE BID OPENING DATE. ANY ADDENDUM SHOULD BE RECEIVED BY THE BUYER WITHIN FOURTEEN (14) DAYS PRIOR TO THE BID OPENING DATE.</p> <p>(3) ALL ADDENDA SHOULD BE FORMALLY ACKNOWLEDGED BY ALL BIDDERS AND SUBMITTED TO THE STATE PURCHASING DIVISION. THE SAME RULES AND REGULATIONS THAT APPLY TO THE ORIGINAL BIDDING DOCUMENT SHALL ALSO APPLY TO AN ADDENDUM DOCUMENT. THE ONLY EXCEPTION MAY BE FOR AN ADDENDUM THAT IS ISSUED FOR THE SOLE PURPOSE OF CHANGING A BID OPENING TIME AND/OR</p>						

SEE REVERSE SIDE FOR TERMS AND CONDITIONS

SIGNATURE 	TELEPHONE 304-776-8063	DATE 7-1-2008
TITLE Manager	FEIN 55-0771021	ADDRESS CHANGES TO BE NOTED ABOVE

WHEN RESPONDING TO RFQ, INSERT NAME AND ADDRESS IN SPACE ABOVE LABELED 'VENDOR'



State of West Virginia
 Department of Administration
 Purchasing Division
 2019 Washington Street East
 Post Office Box 50130
 Charleston, WV 25305-0130

Request for Quotation

RFQ NUMBER
ABC95

PAGE
6

ADDRESS CORRESPONDENCE TO ATTENTION OF
SHELLY MURRAY
304-558-8801

RFQ COPY
TYPE NAME/ADDRESS HERE

Camel Technologies, LLC
 1326 Ohio Avenue
 Dunbar, WV 25064

ALCOHOL BEVERAGE CONTROL
COMMISSION
HUB INDUSTRIAL PARK
RIVER ROAD
NITRO, WV
25143 **558-2487**

DATE PRINTED	TERMS OF SALE	SHIP VIA	FOB	FREIGHT TERMS
05/01/2008				

BID OPENING DATE: **06/18/2008** BID OPENING TIME **01:30PM**

LINE	QUANTITY	UOP	CAT NO	ITEM NUMBER	UNIT PRICE	AMOUNT																																			
<p>DATE. REV. 11/96 EXHIBIT 10 ADDENDUM ACKNOWLEDGEMENT I HEREBY ACKNOWLEDGE RECEIPT OF THE FOLLOWING CHECKED ADDENDUM(S) AND HAVE MADE THE NECESSARY REVISIONS TO MY PROPOSAL, PLANS AND/OR SPECIFICATION, ETC. ADDENDUM NOS.:</p> <table border="0"> <tr> <td>NO. 1</td> <td>...</td> <td>X</td> <td>.....</td> <td></td> <td></td> <td></td> </tr> <tr> <td>NO. 2</td> <td>...</td> <td>X</td> <td>.....</td> <td></td> <td></td> <td></td> </tr> <tr> <td>NO. 3</td> <td>.....</td> <td></td> <td></td> <td></td> <td></td> <td></td> </tr> <tr> <td>NO. 4</td> <td>.....</td> <td></td> <td></td> <td></td> <td></td> <td></td> </tr> <tr> <td>NO. 5</td> <td>.....</td> <td></td> <td></td> <td></td> <td></td> <td></td> </tr> </table> <p>I UNDERSTAND THAT FAILURE TO CONFIRM THE RECEIPT OF THE ADDENDUM(S) MAY BE CAUSE FOR REJECTION OF THE BIDS. VENDOR MUST CLEARLY UNDERSTAND THAT ANY VERBAL REPRESENTATION MADE OR ASSUMED TO BE MADE DURING ANY ORAL DISCUSSION HELD BETWEEN VENDOR'S REPRESENTATIVES AND ANY STATE PERSONNEL IS NOT BINDING. ONLY THE INFORMATION ISSUED IN WRITING AND ADDED TO THE SPECIFICATIONS BY AN OFFICIAL ADDENDUM IS BINDING.</p>							NO. 1	...	X				NO. 2	...	X				NO. 3						NO. 4						NO. 5					
NO. 1	...	X																																						
NO. 2	...	X																																						
NO. 3																																								
NO. 4																																								
NO. 5																																								

SEE REVERSE SIDE FOR TERMS AND CONDITIONS

SIGNATURE TELEPHONE **304-776-8063** DATE **7-1-2008**
 TITLE **Manager** FEIN **55-0771021** ADDRESS CHANGES TO BE NOTED ABOVE

WHEN RESPONDING TO RFQ, INSERT NAME AND ADDRESS IN SPACE ABOVE LABELED 'VENDOR'



State of West Virginia
 Department of Administration
 Purchasing Division
 2019 Washington Street East
 Post Office Box 50130
 Charleston, WV 25305-0130

Request for Quotation

RFQ NUMBER:
ABC95

PAGE:
7

ADDRESS CORRESPONDENCE TO ATTENTION OF:
**SHELLY MURRAY
 304-558-8801**

RFQ COPY

TYPE NAME/ADDRESS HERE

Camel Technologies, LLC

1326 Ohio Avenue

Dunbar, WV 25064

**ALCOHOL BEVERAGE CONTROL
 COMMISSION
 HUB INDUSTRIAL PARK
 RIVER ROAD
 NITRO, WV
 25143 558-2487**

DATE PRINTED	TERMS OF SALE	SHIP VIA	FOB	FREIGHT TERMS
05/01/2008				

BID OPENING DATE: **06/18/2008** BID OPENING TIME **01:30PM**

LINE	QUANTITY	UOP	CAT NO	ITEM NUMBER	UNIT PRICE	AMOUNT
<p>.....SIGNATURE</p> <p>Camel Technologies, LLC</p> <p>.....COMPANY</p> <p>7-1-2008</p> <p>.....DATE</p> <p>REV. 11/96</p> <p>CONTRACTORS LICENSE</p> <p>WEST VIRGINIA STATE CODE 21-11-2 REQUIRES THAT ALL PERSONS DESIRING TO PERFORM CONTRACTING WORK IN THIS STATE MUST BE LICENSED. THE WEST VIRGINIA CONTRACTORS LICENSING BOARD IS EMPOWERED TO ISSUE THE CONTRACTORS LICENSE. APPLICATIONS FOR A CONTRACTORS LICENSE MAY BE MADE BY CONTACTING THE WEST VIRGINIA DIVISION OF LABOR CAPITOL COMPLEX, BUILDING 3, ROOM 319, CHARLESTON, WV 25305. TELEPHONE: (304) 558-7890.</p> <p>WEST VIRGINIA STATE CODE 21-11-11 REQUIRES ANY PROSPECTIVE BIDDER TO INCLUDE THE CONTRACTORS LICENSE NUMBER ON THEIR BID.</p> <p>BIDDER TO COMPLETE:</p> <p>CONTRACTORS NAME: Camel Technologies, LLC</p> <p>CONTRACTORS LICENSE NO.: .MVD33278</p> <p>THE SUCCESSFUL BIDDER WILL BE REQUIRED TO FURNISH A COPY OF THEIR CONTRACTORS LICENSE PRIOR TO ISSUANCE OF A PURCHASE ORDER/CONTRACT</p> <p>APPLICABLE LAW</p>						

SEE REVERSE SIDE FOR TERMS AND CONDITIONS

SIGNATURE	TELEPHONE	DATE
	304-776-8063	7-1-2008
TITLE	FEIN	ADDRESS CHANGES TO BE NOTED ABOVE
Manager	55-0771021	

WHEN RESPONDING TO RFQ, INSERT NAME AND ADDRESS IN SPACE ABOVE LABELED 'VENDOR'



State of West Virginia
 Department of Administration
 Purchasing Division
 2019 Washington Street East
 Post Office Box 50130
 Charleston, WV 25305-0130

Request for Quotation

RFQ NUMBER
ABC95

PAGE
8

ADDRESS CORRESPONDENCE TO ATTENTION OF
**SHELLY MURRAY
 304-558-8801**

VENDOR

RFQ COPY
TYPE NAME/ADDRESS HERE
 Camel Technologies, LLC
 1326 Ohio Avenue
 Dunbar, WV 25064

SHIP TO

**ALCOHOL BEVERAGE CONTROL
 COMMISSION
 HUB INDUSTRIAL PARK
 RIVER ROAD
 NITRO, WV
 25143**
558-2487

DATE PRINTED	TERMS OF SALE	SHIP VIA	FOB	FREIGHT TERMS
05/01/2008				

BID OPENING DATE: **06/18/2008** **BID OPENING TIME 01:30PM**

LINE	QUANTITY	UOP	CAT NO	ITEM NUMBER	UNIT PRICE	AMOUNT
<p>THE WEST VIRGINIA STATE CODE, PURCHASING DIVISION RULES AND REGULATIONS, AND THE INFORMATION PROVIDED IN THE "REQUEST FOR QUOTATION" ISSUED BY THE PURCHASING DIVISION IS THE SOLE AUTHORITY GOVERNING THIS PROCUREMENT.</p> <p>ANY INFORMATION PROVIDED IN SPECIFICATION MANUALS, OR ANY OTHER SOURCE, VERBAL OR WRITTEN, WHICH CONTRADICTS OR ALTERS THE INFORMATION PROVIDED FROM THE SOURCES AS DESCRIBED IN THE ABOVE PARAGRAPH IS VOID AND OF NO EFFECT.</p> <p>BANKRUPTCY: IN THE EVENT THE VENDOR/CONTRACTOR FILES FOR BANKRUPTCY PROTECTION, THIS CONTRACT IS AUTOMATICALLY NULL AND VOID, AND IS TERMINATED WITHOUT FURTHER ORDER.</p> <p>REV. 1/2005</p> <p style="text-align: center;">NOTICE</p> <p>A SIGNED BID MUST BE SUBMITTED TO:</p> <p style="text-align: center;">DEPARTMENT OF ADMINISTRATION PURCHASING DIVISION BUILDING 15 2019 WASHINGTON STREET, EAST CHARLESTON, WV 25305-0130</p> <p>THE BID SHOULD CONTAIN THIS INFORMATION ON THE FACE OF THE ENVELOPE OR THE BID MAY NOT BE CONSIDERED:</p> <p>SEALED BID</p>						

SEE REVERSE SIDE FOR TERMS AND CONDITIONS

SIGNATURE 	TELEPHONE 304-776-8063	DATE 7-1-2008
TITLE Manager	FEIN 5500771021	ADDRESS CHANGES TO BE NOTED ABOVE

WHEN RESPONDING TO RFQ, INSERT NAME AND ADDRESS IN SPACE ABOVE LABELED 'VENDOR'



State of West Virginia
 Department of Administration
 Purchasing Division
 2019 Washington Street East
 Post Office Box 50130
 Charleston, WV 25305-0130

Request for Quotation

BFO NUMBER
ABC95

PAGE
9

ADDRESS CORRESPONDENCE TO ATTENTION OF
SHELLY MURRAY
304-558-8801

RFQ COPY

TYPE NAME/ADDRESS HERE

Camel Technologies, LLC
 1326 Ohio Avenue
 Dunbar, WV 25064

V
E
N
D
O
R

S
H
I
P
T
O

ALCOHOL BEVERAGE CONTROL
 COMMISSION
 HUB INDUSTRIAL PARK
 RIVER ROAD
 NITRO, WV
 25143
 558-2487

DATE PRINTED	TERMS OF SALE	SHIP VIA	FOB	FREIGHT TERMS
05/01/2008				

BID OPENING DATE: **06/18/2008** BID OPENING TIME **01:30PM**

LINE	QUANTITY	UOP	CAT NO	ITEM NUMBER	UNIT PRICE	AMOUNT
BUYER:				SHELLY MURRAY / FILE 31		
REQ. NO.:				ABC95		
BID OPENING DATE:				06/18/2008		
BID OPENING TIME:				1:30 PM		
PLEASE PROVIDE A FAX NUMBER IN CASE IT IS NECESSARY TO CONTACT YOU REGARDING YOUR BID:						
304-776-8095						

PLEASE PRINT OR TYPE NAME OF PERSON TO CONTACT CONCERNING THIS QUOTE:						
Jeff West						

***** THIS IS THE END OF RFQ ABC95 ***** TOTAL:						\$48,044.00

SEE REVERSE SIDE FOR TERMS AND CONDITIONS

SIGNATURE  TELEPHONE 304-776-8063 DATE 7-1-2008

TITLE Manager FEIN 55-0771021 ADDRESS CHANGES TO BE NOTED ABOVE

WHEN RESPONDING TO RFQ, INSERT NAME AND ADDRESS IN SPACE ABOVE LABELED 'VENDOR'

West Virginia Alcohol Beverage Control Administration
Warehouse Security System
Equipment/Parts List
Revised 06/16/08

Equipment/parts are to be the same as or equivalent to the items listed below.

Quantity	Brand and Model or Equivalent	Description
4	IEI Doorguard 234	Electronic Touch Pads/Reader
1	DSC Maxsys PC4020	Security Control Panel
1 set	Optex AX-130T	Twin Beam Photoelectric Detectors (front gate motion sensors installed to trigger front gate closer)
2	QSCO Model: HSLG 1 hp.	1 hp 480 three phase gate motors
10	Bolide BC2002HQDN/12/24	Sony HQ High Resolution Box Camera
6	Bolide BP0034	Cameras for Indoor and outdoor use 15" Weatherproof Outdoor Housing w/Heater and Blower Housing for outdoor cameras
10	Bolide BP0019-12 1/3"	2.8mm – 12mm F1.4 Varifocal Auto Iris Lens For indoor and outdoor cameras
19	Lorex Mfr" SG620R B&H# LOSG620R	Simulated Dome Camera Fake cameras
1	Toshiba EVR32-240-1000	Digital Recording System (with 32 camera recording capacity)
1	American Dynamics 17" CCTV Model# ADMNM1LCD17	Multiple Screen Viewer (Should permit viewer to switch between 32 camera views)
1	Spectra Alert P1224MC	Horn/Strobe 12 volt
25	GE Security 2300 Series Sentrol	Overhead Door Contacts Door sensors

10	GE Sentrol 1085T	Screw Mount Terminal Contacts Door sensors
2	RCI 6 Series	Universal Electric Striker
2	Arrow S1800 Rime Exit Devises	Panic bar exit devices
1	Great Lakes GL48WMS	48" x 21.25 x 24.5 Rack with Plexiglas door
1	Great Lakes WM 7217WS	Fan assembly w/fan guards and two 75 CFM fans
1	Great Lakes WM 7206-FM	Stationary front mount shelf – 17.25 x 18
2	3 5/8 Pieso Super Siren 12vdc 120db	Indoor/Outdoor Sirens
1	Internet Connection: Suddenlink Business Connection with static IP, no slower than 6Mbps	Internet

West Virginia Alcohol Beverage Control Administration
Warehouse Security System
Bid Schedule

Revised June 16, 2008

Please list the pricing for all equipment listed below (total cost is to include all fees associated with installation and materials):

QUANTITY	DESCRIPTION	UNIT COST	TOTAL COST
4	Electric Touch Pads/Reader	\$347.42	\$5,828.00
1	Motion Sensor (installed to trigger front gate closer)	\$120.00	\$640.00
1	Security Control Panel	\$1,160.77	\$5,861.00
2	Front Gate Motors	\$400.00	\$1,320.00
10	480+ Resolution Interior/Exterior Cameras "Day, Night and DSP"	\$219.52	\$5,005.00
6	Weatherproof Outdoor Camera Housing	\$72.80	\$1,087.00
10	2.8 - 12mm Varifocal Auto Iris Lens	\$65.60	\$1,306.00
19	Fake Cameras	\$21.00	\$1,635.00
1	Digital Recording System (with 18 camera recording capacity)	\$7,488.60	\$9,226.00
1	Multiple Screen Viewer (should permit viewer to switch between 32 camera views)	\$476.00	\$606.00
1	Security Horn with strobe	\$50.00	\$115.00
25	Overhead Door Sensors	\$35.00	\$2,500.00
10	Screw Mount Terminal Contact Door Sensors	\$7.00	\$720.00
2	Electric Strike	\$350.00	\$1,220.00
2	Exit Devices	\$816.20	\$2,152.00
1	Year One Maintenance Contract (Starting and paid for on completion of Security System)	N/C	N/C
1	Year Two Maintenance Contract (Payment to be made upon renewal date)	\$333.33	\$4,000.00
1	Year Three Maintenance Contract (Payment to be made upon renewal date)	\$333.33	\$4,000.00

2	Indoor Outdoor 12 vdc Siren	\$11.20	\$153.00
1	Internet Connection	\$150.00	\$670.00
TOTALS			\$48,044.00

See attached Warehouse Security System Equipment/Parts List.

THIS CHECK CONTAINS THE FOLLOWING SECURITY FEATURES: MULTI-COLOR PRINTING ON FACE, WATERMARK IN PAPER, AND MICROPRINTING ON BORDER.



69-467/519

011144

DATE 07/01/2008

PAY TO THE ORDER OF

STATE OF WEST VIRGINIA PURCHASING DIVISION

\$ 2,402.20

2,402.20 DOLLARS

***** DOLLAR TWO COMMA FOUR ZERO TWO ZERO ZERO

REMITTER

Sherry McCombs
AUTHORIZED SIGNATURE



CASHIER'S CHECK

BOLIDE TECHNOLOGY GROUP

"QUALITY DOESN'T HAVE TO BE SO COSTLY"

Sony HQ High Resolution Box Camera

The new BC2002HQDN/12/24 camera features an aesthetically pleasing and compact design that is perfectly suited for commercial and fashionable facilities such as retail sales, shopping malls, stadiums, arenas, banks and office buildings. Incorporating the latest Sony HQ technology, this camera produces images with high picture quality and remarkable sensitivity with a S/N ratio of more than 50 dB. In addition, this camera offers dual power capability (AC 24V and DC 12V) to safeguard against unwanted power supply compatibility issues. This camera also features 1/3" Sony Super HAD CCD and with 540 Lines of Resolution. With the built in Day & Night function, the light sensitivity rated as low as 0.14 lux.

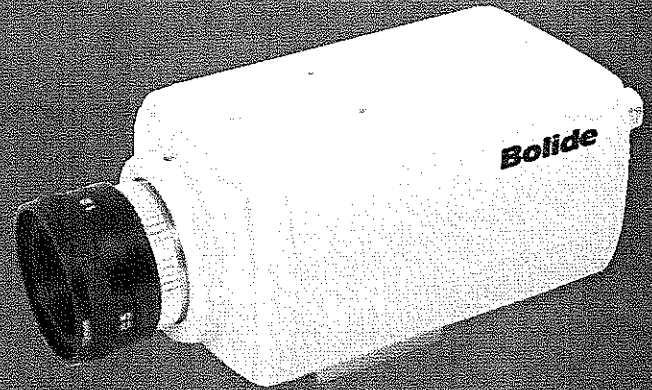

Model No. BC2002HQDN/12/24

Features:

- 1/3" Sony Super HAD CCD
- 540 TVL, 0.14 Lux
- DSP: Sony HQ1
- Automatic Day & Night Function
- Dual Voltage 12VDC/24VAC
- BLC, AGC and Flickerless control



TV System	NTSC
Image Sensor	Sony 1/3" Super HAD CCD
Horizontal Resolution	540 TV Lines
DSP	SONY HQ1
Min. Illumination	0.14 Lux/F1.0
Electronic Shutter	1/60 ~ 1/100,000 sec
Sync. System	Internal Sync
S/N Ratio	More than 50dB (AGC OFF)
Video Out	BNC, 1.0Vp-p, 75 ohm
Special Effect	B.L.C. / A.G.C. / AWB / Flickerless
Operating Temperature	-10°C ~ +50°C
Storage Temperature	-20°C ~ +60°C
Power Supply	12VDC / 24VAC
Power Consumption	2.0w

Specifications are subject to change without notice.

For more information, please visit us on the web www.bolideco.com

18605 E. Gale Ave Suite 168, City of Industry, CA 91748

Tel: 626 820 8800 Fax: 626 912 1515

Bolide Technology Group

In/Outdoor Housing

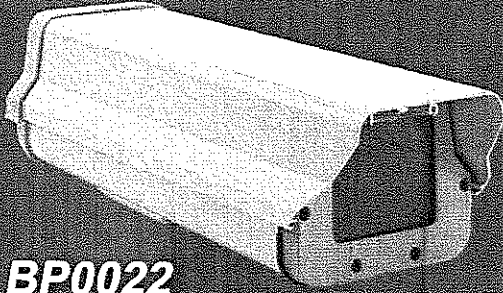

BP0022

15" Environmental Outdoor Housing

- * Lockable Rear Latch Adjustment
- * Come with Camera Tray
- * Bracket included

Pro-Grade Cables

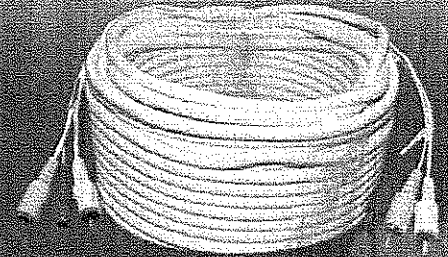

BP0013

60Ft Super grade RCA cable with power cord

BP 0014

100Ft super grade RCA cable with power cord

BP0015

300 Ft super grade RCA cable with power cord

In/Outdoor beacket

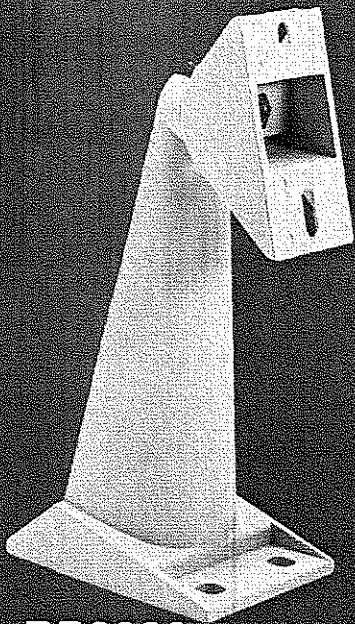

BP0020

Heavy-Duty Construction

Adjustable Pan and Tilt Head

Max. Adjustment: 380 pan / 90 tilt



BP0022/13" (12"-15")

BP0021/39" (24"-42")

Aluminum Mont

Heavy-Duty In/Outdoor

Max-Load 8.5 Lbs

Swivel Angle 360°

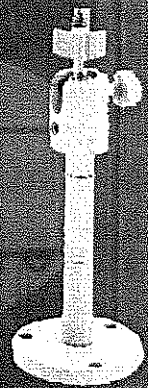

BP0009

Indoor Mounting Bracket



7 Inch indoor
Mounting bracket

www.Bolideco.com

18605 E. Gale Ave City of Industry, CA 91748

Tel: 800 355 0895 Fax: 626 912 1515

Specification subject to change without notice © Copyright 2003 Bolide Technology Group

Bolide Technology Group

Bolide Quality Lenses

www.Bolideco.com

• Fixed Lenses

SPECIFICATION

Model Number	Focal Length (mm)	Aperture (F)	Mount	Angle of view (HOR)	M.O.D (m)	Weight (g)
BP0002-2.5	2.5	1.8	CS	107.1	0.2	36
BP0002-4.0	4.0	1.6	CS	70.6	0.1	51
BP0002-6.0	6.0	1.6	CS	48.1	0.1	54
BP0002-8.0	8.0	1.6	CS	33.4	0.1	59
BP0002-12.0	12.0	1.6	CS	22.1	0.1	42
BP0002-16.0	16.0	1.6	CS	17.1	0.1	47

• Spherical Zoom Lenses (Vari-Focal)

Model Number	Focal Length (mm)	Aperture (F)	Mount	Angle of view (HOR)	M.O.D (m)	Weight (g)
BP00019-12	2.8-12	1.4	CS	95.6-22.1	0.1	156
BP00019-8.0	3.5-8.0	1.4	CS	81.9-35	0.1	104
BP00019-15	6.0-15	1.4	CS	48.1-18.6	0.1	133
BP00019-30	12-30	1.6	CS	21.9-9.6	0.2	128
BP00019-60	6.0-60	1.6	CS	49.3-4.7	0.2	167
BP00019-100	16.05.0-100	1.8	CS	50.1-2.8	0.2	242

• Board Lenses

Model Number	Focal Length (mm)	Aperture (F)	Mount	Angle of view (HOR)	M.O.D (m)	Weight (g)
BP0001-3.6	3.6	2.0	12*0.5	92	0.2	5
BP0001-8.0	6.0	2.0	12*0.5	54	0.2	5
BP0001-8.0	8.0	2.0	12*0.5	43	0.2	5
BP0001-12.0	12.0	2.0	12*0.5	29	0.2	5
BP0001-16.0	16.0	2.0	12*0.5	21	0.2	5

FEATURES

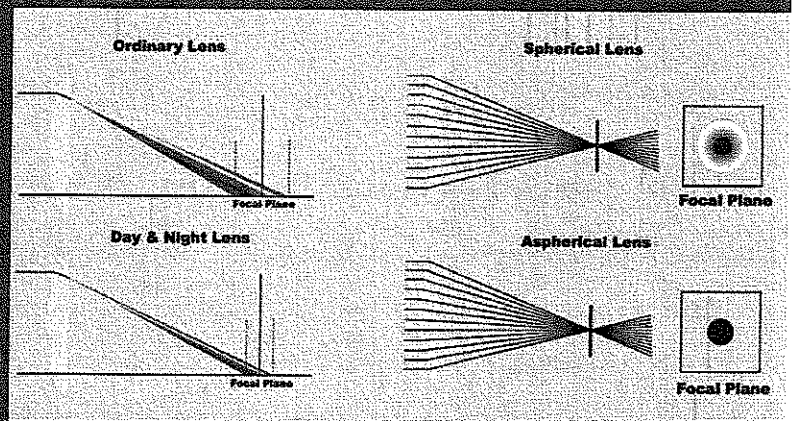

18605 E. Gale Ave
 City of Industry, CA 91748
 Tel: 800 355 0895 Fax: 626 912 1515

Most installer friendly cameras.

INDOOR DOME

CD-SD21N/P



Flush Mount

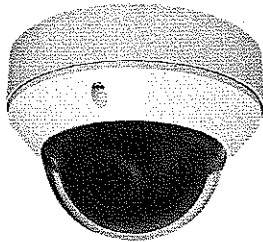

Flush Housing with Surface Mount

Key Features

- 1/3" CCD Sensor
- 550 TV Lines
- Day/Night function with ICR
- 2.8~10mm, DC Auto Iris
- 0.1 Lux (Color), 0.01 Lux (B/W), 0.002 Lux (DSS On)
- Separate Camera Control Board
 - OSD Menu
 - Service Monitor Output
- 12VDC/24VAC Dual Voltage

Construction

- 4" Polycarbonate Bubble
- 3-Axis Gimbal
- Flush Mount Housing w/ Surface Mount Plate in a single package
- Aluminum Mounting Accessories(Optional)
- Ivory or Black Plastic Housing(Optional)
- Compact Size

Dome Inside View

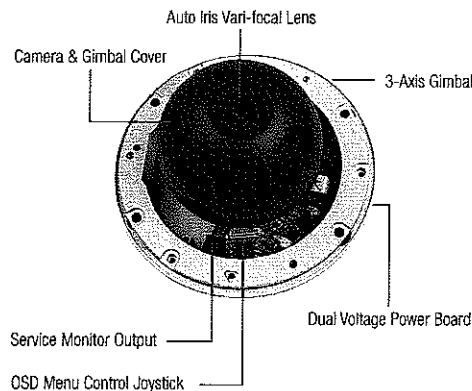

Technical Specifications

NTSC = (N), PAL = (P)

Item	CD-SD21N/P
Video Format	NTSC / PAL
Image Sensor	1/3" CCD
Sync System	Internal / Line Lock(Optional)
Effective Pixels	768(H) x 494(V)(N) / 752(H) x 582(V)(P)
Scanning system	525 Lines. 2:1 Interlaced(N), 625 Lines. 2:1 Interlaced(P)
Electronic Shutter	1/60 ~ 1/120,000 sec.(N), 1/50 ~ 1/120,000 sec.(P)
Main Video Output	1.0 Vp-p Composite, 75 ohm
Service Monitor Output	1.0 Vp-p Composite, 75 ohm
Horizontal Resolution	550 TV Lines
Min. Illumination	0.1 Lux(Color), 0.01 Lux (B/W) 0.002 Lux(DSS On)
S/N Ratio	More than 50dB(AGC Off)
Lens (DC Auto Iris)	Vari-focal: 2.8-10mm
Angle of View	132.1°(W) ~ 36°(T)
Day/Night Function	ICR
Camera Control & Setup	OSD Menu
Operating Temperature	-5°C ~ +45°C
Operating Humidity	Within 90% RH
Power Consumption	500mA
Input Voltage	12VDC/24VAC Dual Voltage

* Must use specified and regulated 12VDC/24VAC power supply.

Available Models

CD-SD21N/P-I	Ivory Housing
CD-SD21N/P-B	Black Housing

Accessories

CA-SMC30	Service Monitor Cable
CV-WM	Indoor Wall Mount
CA-PM	Pedestal Mount
CA-JB	Junction Box

Dimensions (UNIT: mm)

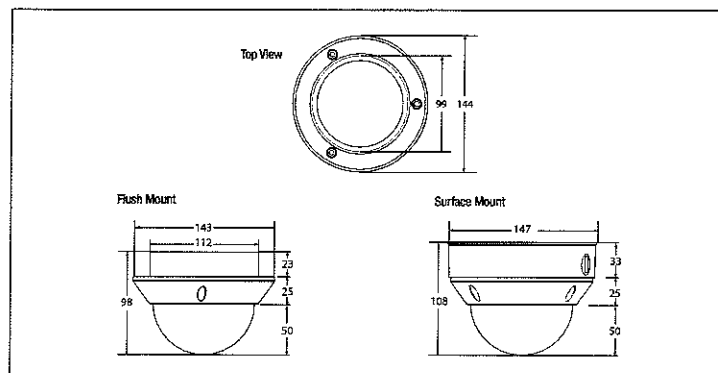

EASYVIEW

APEX DVR

Experience peak performance with the APEX DVR.

AP-F3200

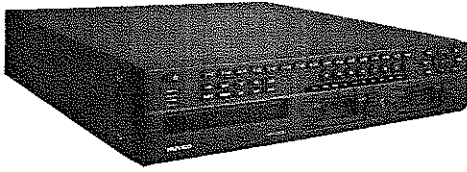

Key Features

- 32 channel
- Support NTSC & PAL Standards
- Embedded Linux operating system
- Built-in multiplexer
- Quadruplex function - simultaneous record / playback / network / backup
- Recording compression method: MPEG-4
- Network transmission method: MPEG-4 / M-JPEG selectable
- Real-time live display & recording per channel
- Up to 960pps recording @ Half D1 (720 x 240) resolution
- Multiple main video outputs: 4 composite, 1 VGA
- User friendly graphic menu
- Hidden / Covert camera function
- Built-in backup device: DVD-RW
- External backup device support: USB Thumbdrive
- Internal storage bays: 4
2 Internal and 2 Removable(SATA)
- Expandable storage: Support up to 8 AP-ES units
- Mirror recording
- Mini player: auto installation into DVD during backup
- Watch dog / power failure recovery
- RS-422/485 for PTZ speed dome and keypad controller(NVCK-3X)
- Support various PTZ protocols
- Time synchronization between multiple DVRs
- 4 Channel audio with 2-way audio over network
- Firmware upgrade via USB or network
- IR remote controller
- Optional SDK available for large integration support
- Proprietary Dynamic DNS Service for Plug-n-Play Remote Connection

System Configuration

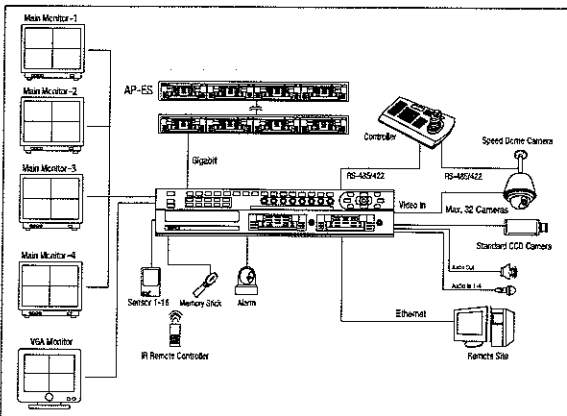

Technical Specifications

SPECIFICATIONS	AP-F3200
Video Format	NTSC/PAL auto detect
Operating System	Embedded Linux
Quadruplex Function	Simultaneous record / playback / network / backup
Video Input	32
Multiple Main Monitor Outputs	4 composite, 1 VGA
Channel Allocation per Monitor Outputs*	Channels: 1~16 Channels: 17~32 Channels: 1~16 Channels: 17~32 Channels: 1~16
Channel Display Options*	Channels: 1~16 Channels: 1~16 Channels: 1~16 Channels: 1~16 Channels: 1~16
Video Compression Method	MPEG-4
Network Transmission Method	MPEG-4 / M-JPEG selectable
Average File Size	1.7 - 17KB
Maximum Recording Rate & Resolution	960pps @ 360 x 240(NTSC) / 800pps @ 360 x 288(PAL) 960pps @ 720 x 240(NTSC) / 800pps @ 720 x 288(PAL) 480pps @ 720 x 480(NTSC) / 400pps @ 720 x 576(PAL)
Alarm In / Out	16 / 4
System Control	Key buttons, IR remote controller, remote client PC, NVCK-3X
Audio In / Out	4 / 1
PTZ Dome & Controller Interface	RS-422/485
FEATURES	AP-F3200
Display Settings	Brightness, contrast, color adjustments, hidden/covert per channel
Camera Title	22 characters per channel
Recording Modes	Continuous, schedule, alarm, motion, and panic recording
Recording Adjustments	Resolution, frame rate, and picture quality per channel
Pre-Alarm & Post Alarm Recording	Pre-alarm: 5 sec. per channel / Post-Alarm: 60 sec. per channel
Motion Detection	22 x 15 (NTSC), 22 x 18(PAL) selectable grids / 10 sensitivity levels
Search Mode	Time/Date, Calendar, Log
Playback Speed	Up to 32x
Power Failure Recovery	Auto reboot while maintaining system settings
Alarm Notification	Pop up, system buzzer, alarm relay, email
User Level	1 admin, 5 configurable users, 1 admin, 10 configurable remote users
Communication Port	2 RS-232C, 2 RS-485, ethernet
Internal Storage Bays	2 internal, 2 Removable bays(SATA)
Expandable Storage	Support up to 8 AP-ES units
Built-in Backup Device	DVD-RW
Mini-Player For Backup	Auto installation into DVD during backup
External Backup Device Support	USB Thumbdrive
Watermark	Yes
Audio Over Network	2-way
Power Failure Recovery	Auto reboot while maintaining previous record settings
GENERAL	AP-F3200
Rack Mount Kit	Yes
Power	100~240VAC(50/60Hz), universal
Dimensions (mm)	445(W) x 388(D) x 88(H)
Weight	11Kg
Power Consumption	AC 100~240V, 50/60Hz, 85W max, typical 60W

* To operate and view all 32 channels simultaneously, DVR unit requires 2 separate monitors.

Rear View

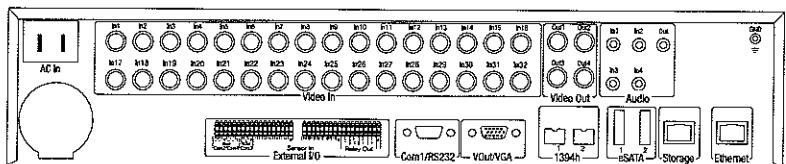

NUVICO

Corporate Headquarters | T 866.523.1700 • 201.541.1605 • sales@nuvico.com
International Operations | export@nuvico.com

Customer Service | cs@nuvico.com
Technical Support | techsupport@nuvico.com

speco technologies®

15", 17", 19" High Resolution TFT Color LCD Monitors

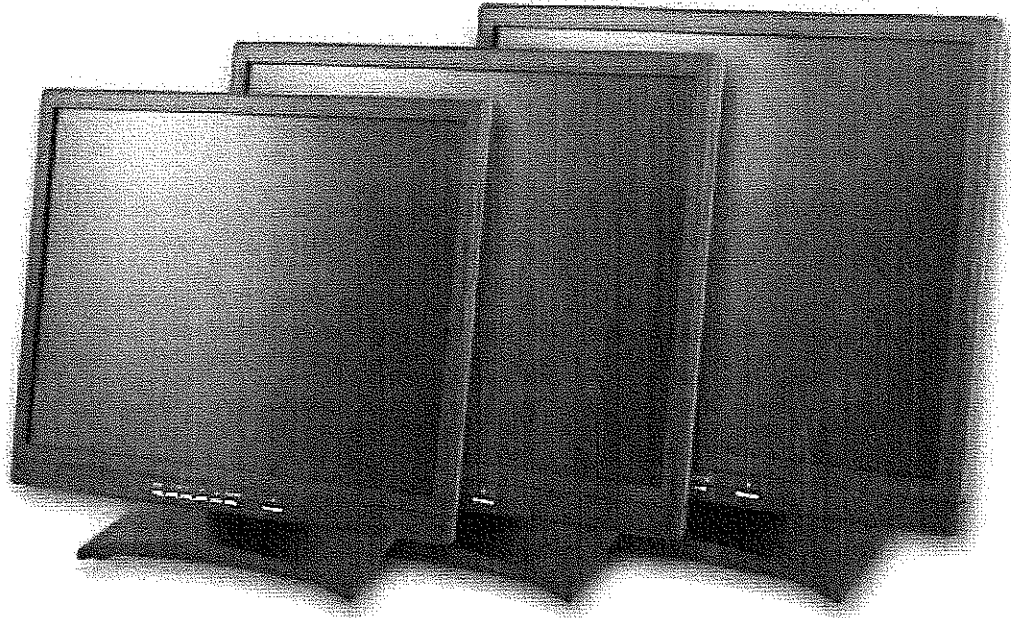

VM-15LCD • VM-17LCD • VM-19LCD

Features

- Displays up to 16.2 million colors
- Convenient front controls for on-screen programming
- Stereo speakers
- VGA (D-Sub 15 pins), loop through stereo audio (RCA), loop through video (BNC), PC audio input, video inputs
- Input signal detection provides easy connection
- 500:1 Contrast ratio
- VESA compatible
- Regulated 12V DC 40W power supply (UL & CSA listed) included
- Embedded comb filter

Specifications

- | | | |
|---|---|---|
| • Screen: 15" TFT | • Screen: 17" TFT | • Screen: 19" TFT |
| • 1024(H) x 768(V)
SXGA resolution | • 1280(H) x 1024(V)
SXGA resolution | • 1280(H) x 1024(V)
SXGA resolution |
| • 225cd/m2 Brightness | • 290cd/m2 Brightness | • 250cd/m2 Brightness |
| • Dimensions:
15.9" H x 16.3" W x 5.7" D | • Dimensions:
16.7" H x 16.4" W x 6.1" D | • Dimensions:
17.9" H x 17.8" W x 6.1" D |
| • Weight: 5.51 lbs. | • Weight: 8.4 lbs. | • Weight: 10.1 lbs. |

Specifications subject to change

For more information contact us at:

Speco Technologies 200 New Highway, Amityville, NY 11701 Web: www.specotech.com
Toll Free: 1-800-645-5516 In Metro NY: 631-957-8700 Fax: 631-957-9142 or 631-957-3880



Altronix

More than just power.™

Keyword Search

Product Search

Language Support | English | Español

R2416ULCB
CCTV AC Rack Mount 16 Output Power Supply

Product Search Page	Printable Version
PDF Data Sheet	E-mail This Page

Overview

Model R2416ULCB provides 24VAC or 28VAC distributed via sixteen (16) PTC protected Class 2 Rated power limited outputs.

Agency Listings

- UL Listed UL Listed for Commercial CCTV Equipment (UL2044), CUL Listed - CSA Standard C22.2 No.1-98, Audio, Video and Similar Equipment.
File# E148639.
- CE Approved.

Features/Specifications

- 24VAC or 28VAC output.
- 7 amp @ 24VAC or 6 amp @ 28VAC (170VA) supply current.
- Class 2 Rated power limited outputs.
- Sixteen (16) PTC protected outputs.
- Output PTCs are rated @ 2.5 amp.
- 115VAC 50/60Hz, 3 amp input.
- Surge suppression.
- AC power LED indicator.
- Illuminated Power Disconnect Circuit Breaker with manual reset.
- Unit maintains camera synchronization.
- Removable terminal blocks w/locking screw flange.
- Lifetime Warranty.

Rack Chassis

- Modular 2U standard EIA 19" rack mount chassis.
- Dimensions: 3.25"H x 19.125"W x 8.5"D.

Similar Altronix Products

- R2416UL Fused Outputs. 24VAC @ 7 amp or 28VAC @ 6 amp.
- R2416300UL Fused Outputs. 24VAC @ 12.5A or 28VAC @ 10 amp.
- R2416300ULCB PTC Outputs. 24VAC @ 12.5A or 28VAC @ 10 amp.
- R2416600UL Fused. 24VAC @ 25A or 28VAC @ 20 amp.
- R2416600ULCB PTC Outputs. 24VAC @ 25A or 28VAC @ 20 amp.

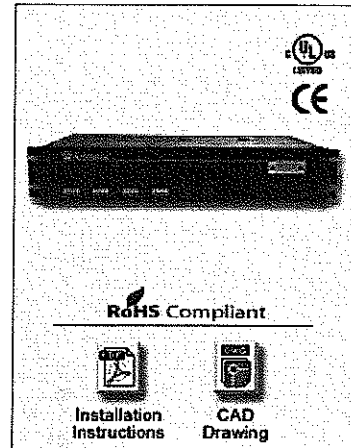

- Home
- New Products
- Products Search
- Support
- Current Events
- Tech Tools
- Company Profile
- Contact Us

Career Opportunities

ISO 9001:2000 REGISTERED FIRM	CONTRACT HOLDER

[Home](#) [New Products](#) [Product Search](#) [Support](#) [Current Events](#) [Tech Tools](#) [Company Profile](#) [Contact Us](#)



Altronix®

Plug-In Transformers

Specification Chart (all transformers listed are 120VAC input):

Model #	Output	Amp	UL Listed	Approx. Ship Wt.
TP1220	12VAC/20VA	1.7	X	1 lb.
TP1620	16.5VAC/20VA	1.2	X	12.9 oz.
TP1640	16.5VAC/40VA	2.4	X	1.8 lbs.
TP1650	16.5VAC/50VA	3	X	1.95 lbs.
TP2420	24VAC/20VA	.8	X	1.2 lbs.
TP2440	24VAC/40VA	1.67	X	1.7 lbs.
TP2450	24VAC/50VA	2	X	1.9 lbs.

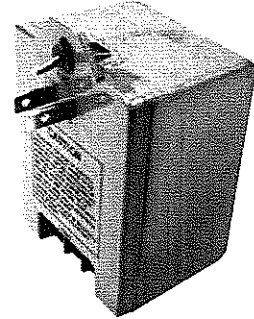

Installation Instructions:

1. Connect wires to plug-in transformer.
2. Plug in the transformer to an outlet and secure transformer with screw provided.

Note: Measure output voltage before connecting devices. This helps avoid potential damage.

WARNING: This installation should be made by qualified service personnel and should conform to all local codes and in accordance with the National Electrical Codes.

Altronix is not responsible for any typographical errors. Product specifications are subject to change without notice.

140 58th Street, Brooklyn, New York 11220 USA, 718-567-8181, fax: 718-567-9056
website: www.altronix.com, e-mail: info@altronix.com, Made in U.S.A.

IIPlug-In - Rev. 092602

A03G





AccessPlus™ Type I Double-Hinged Wall-Mount Cabinets

TYPE I DOUBLE-HINGED
WALL-MOUNT CABINETS

Bulletin
DWDHI

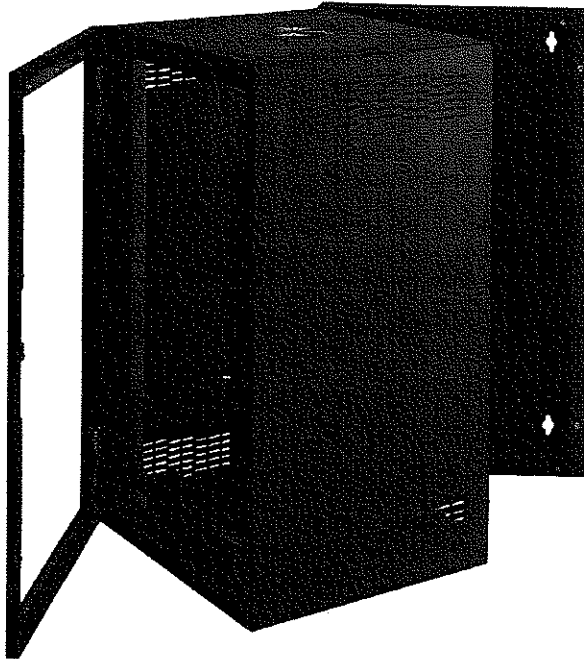

Application

The AccessPlus™ Type I Double-Hinged DataCom Wall-Mount Cabinet is perfect for applications where security and accessibility are required and floor space is at a premium. This versatile cabinet mounts to a wall or can be pole-mounted with optional pole-mounting kit. Designed to hold multiple pieces of voice/data equipment comfortably, it can be mounted to be left- or right-hinged and comes completely assembled and ready to mount.

Features

- Double-hinged for easy equipment access
- Solid or window front door with keylock
- Window on window door is tinted safety glass
- Front access to center body hinging and back section latches
- Latch on front door eliminates need to access sides to open door or back section latches
- Latch-free sides permit cabinet to be installed tightly into a corner
- Vented sides improve heat dissipation
- Knockouts on enclosure top and bottom for optional 4 inch cooling fan or filter kit when increased heat dissipation is needed
- Available with knockouts or gland plates on top and bottom of enclosure for cable entry
- Knockout models have center section to rear section adjustable stop to keep center section from opening too far and hitting adjacent equipment and to provide a solid position when mounting cables on patch panels
- Gland plate models allow installing prewired patch panels into enclosure without removing cables

- Door and center sections can be removed for easy, one-person mounting to wall
- Hidden hinges with removable, retained hinge pins provide sleek appearance and improved security
- Rack angles movable front to back in center section for increased equipment mounting versatility
- Self-grounding rack angles meet grounding requirements
- Cable tie down slots throughout cabinet facilitate cable system maintenance
- Raised pads on back of enclosure provide mounting means for accessories
- Accommodates wall mounting or pole mounting (kit needed)

Construction

- Quality welded 16 and 14 gauge steel construction
- Rack angles made of self-grounding plated steel and tapped with 10-32 threads
- Twenty 10-32 fasteners included

Finish

Phosphatized steel coated with RAL 9005 black textured, low gloss polyester powder paint. Other finishes available—contact Hoffman Customer Service.

Industry Standards

EIA 310-D
UL 508A File No. E61997: Type I
UL 1863 Listed, File No. E230874
cUL CSA C22.2 No. 182.4, File No. E230874
NEMA Type I

Load Rating

Models With Knockouts

2 and 3 ft (.61 and .91m) tall units rated at 125 lb (56.7 kg)
4 ft (1.22m) tall units rated at 175 lb (79.4 kg)
5 and 6 ft (1.52 and 1.83m) tall units rated at 200 lb. (90.7 kg)

Models With Gland Plate

2 and 3 ft (.61 and .91m) tall units rated at 100 lb (45.4 kg)
4 ft (1.22m) tall units rated at 125 lb (56.7 kg)

DataCom Products

AccessPlus™ Type I Double-Hinged Wall-Mount Cabinets

TYPE I DOUBLE-HINGED
WALL-MOUNT CABINETS

Bulletin
DWDHI

Standard Sizes DataCom AccessPlus™ Type I Double-Hinged Wall-Mount Cabinet

Solid Door with Knockouts Catalog Number	Solid Door with Gland Plate Catalog Number	Window Door with Knockouts Catalog Number	Window Door with Gland Plate Catalog Number	Rack Units	A (in.)	A (mm)	B (in.)	B (mm)	C (in.)	C (mm)	No. of Latches	Additional Rack Angles
EWMS242215	EWMSGP242215	EWMW242215	EWMWGP242215	12	25.00	635	22.00	559	16.00	381	1	ERA1924TPLWM
EWMS362215	EWMSGP362215	EWMW362215	EWMWGP362215	19	37.25	946	22.00	559	15.00	381	1	ERA1936TPLWM
EWMS482215	EWMSGP482215	EWMW482215	EWMWGP482215	26	49.50	1257	22.00	559	15.00	381	2	ERA1948TPLWM
EWMS602215	—	EWMW602215	—	32	60.00	1524	22.00	559	15.00	381	2	ERA1960TPLWM
EWMS722215	—	EWMW722215	—	39	72.00	1829	22.00	559	15.00	381	2	ERA1972TPLWM
EWMS242225	EWMSGP242225	EWMW242225	EWMWGP242225	12	25.00	635	22.00	559	25.00	635	1	ERA1924TPLWM
EWMS362225	EWMSGP362225	EWMW362225	EWMWGP362225	19	37.25	946	22.00	559	25.00	635	1	ERA1936TPLWM
EWMS482225	EWMSGP482225	EWMW482225	EWMWGP482225	26	49.50	1257	22.00	559	25.00	635	2	ERA1948TPLWM
EWMS602225	—	EWMW602225	—	32	60.00	1524	22.00	559	25.00	635	2	ERA1960TPLWM
EWMS722225	—	EWMW722225	—	39	72.00	1829	22.00	559	25.00	635	2	ERA1972TPLWM

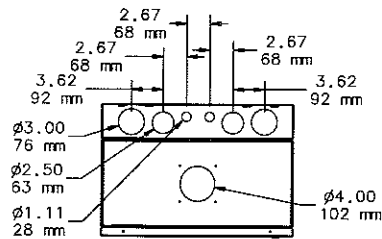

TOP VIEW WITH KNOCKOUTS

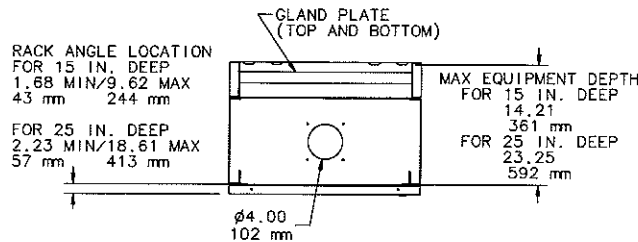

TOP VIEW WITH GLAND PLATE

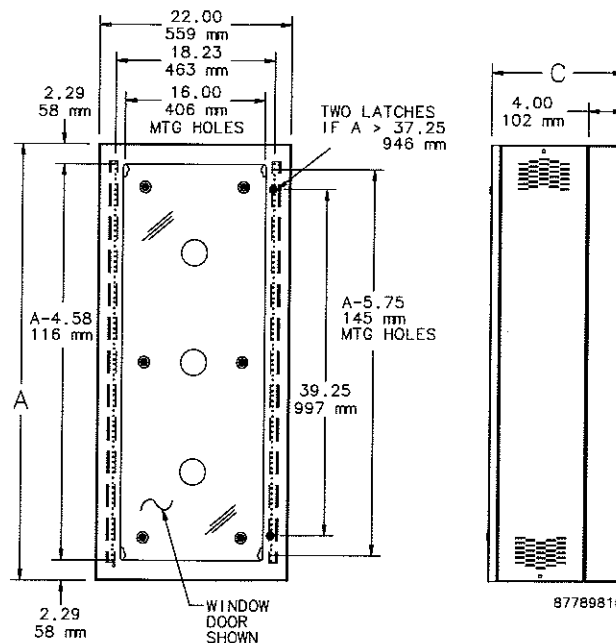

87789810

AccessPlus™ Type I Double-Hinged Wall-Mount Cabinets

TYPE I DOUBLE-HINGED
WALL-MOUNT CABINETS

Bulletin
DWDHI

DataCom Wall-Mount Cabinet with Gland Plate Application

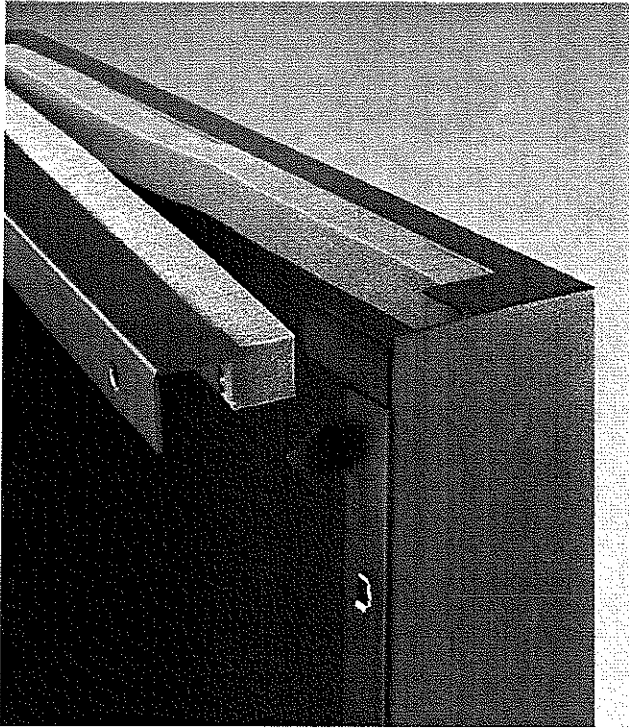

This cabinet offers significant advantages in retrofit applications. It can be mounted with the gland plate both at the top and the bottom to accommodate cable runs from above or below. The gland plate casing can be removed while patch panels and associated wiring are brought to the cabinet.

1. Lay in patch panel.

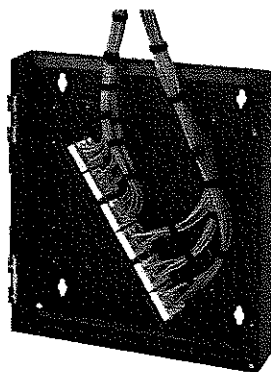

2. Install the cabinet case, securing the cable in the gland plate.

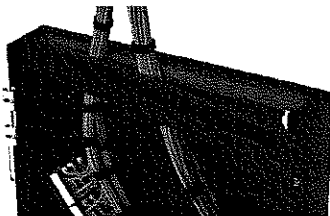

3. Use wire ties or cable wraps to secure cable to the cabinet.

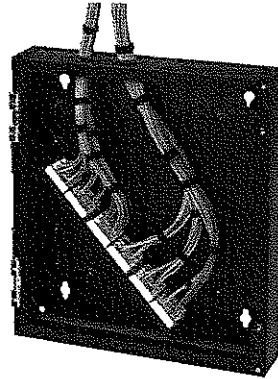

4. Install center section, then mount patch panels on rack angles.

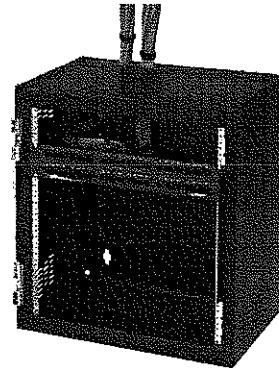

5. Attach hinged door and lock with key lock.

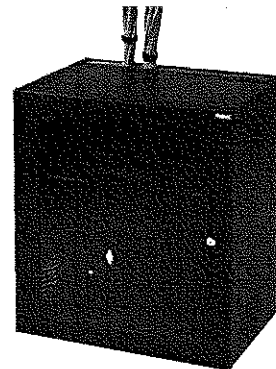

DataCom Products



AccessPlus™ Type I Double-Hinged Wall-Mount Cabinets

TYPE I DOUBLE-HINGED
WALL-MOUNT CABINETS

Bulletin
DWDHI

Selected Accessories

See the Accessories chapter for accessory specifications and additional accessories.

Description	Accessory Catalog Numbers
Shelves	
One-sided Solid Shelf, black painted steel, 8 in. deep, rack mtd.	ESH198
One-sided Solid Shelf, black painted steel, 17 in. deep, rack mtd.	ESH1917
Cable Management	
19 in. Horizontal Cable Manager, with fingers and cover	ECM19F2U
Horizontal Cable Manager, black painted steel	ECK19H
Horizontal Cable Manager Cover, black painted steel	ECKCVR19
Cable Spool, 1-1/2 in. high, 10/pkg., includes mounting screws	PSP00L
Cable Spool, 4 in. high, 10/pkg., includes mounting screws	P4SP00L
Fans	
4 in. Standard Fan, corded, 115VAC, 100 cfm	A4AXFNP6
4 in. Quiet Fan, corded, 115VAC, 49.4 cfm	A4AXFNG0
4 in. Filter Package	AFLTR4LD
Power Distribution Units (PDUs)	See Cable/Power Management
Mounting	
Patch Panel Rack Angles, swivel 45° down, galvanized steel, 2/pkg.	DBPRA4U
Pole Mounting Kit	CPMK24
Mounting Foot Kits	
Steel	CMFK
Stainless Steel	CMFKSS
Composite	CMTGFT
Strut Wall-Mounting Kit, mounts cabinet to wall	DB24WMTK
Fasteners	
Screw Kit, 10-32 x 5/8 in. combo head, silver, 20 per package	AS1032
Screw Kit, 10-32 x 5/8 in. combo head, silver, 250 per package	AS1032250
Velcro™ Wrap, Black - 8 in./12 in.	ECW8B/ECW12B
Velcro™ Wrap, Red - 8 in./12 in.	ECW8R/ECW12R
Velcro™ Wrap, Blue - 8 in./12 in.	ECW8BL/ECW12BL
Velcro™ Wrap, Yellow - 8 in./12 in.	ECW8Y/ECW12Y

Velcro™ is a trademark of Velcro Industries B.V.



HOFFMAN
2100 Hoffman Way, Anoka, MN 55303-1745 USA
(763) 421-2661 • Fax (763) 422-2588 • www.hoffmanonline.com
Customer Service (763) 422-2211

MAXSYS®

INTEGRATED SYSTEMS TECHNOLOGY

PC4020

16 TO 128 ZONE CONTROL PANEL

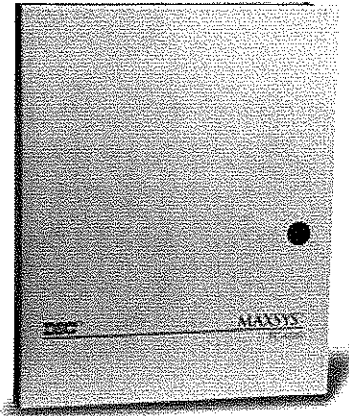

The PC4020 is a 16 zone panel which is expandable to 128 zones. Expansion can be accomplished over a 4-wire Combus using a variety of input/output and functional modules. The base panel includes two addressable loops which can accommodate up to 112 addressable input devices and the system can also be expanded with a 64 zone wireless receiver which connects to the system via the 4-wire Combus. Addressable, hardwired and wireless expansion can be used in any combination that suits the application.

The MAXSYS is software ready to implement all the security, access control, automation and residential fire functions by simply adding conventional or addressable devices, access control modules, and automation interface components.

PC4020 Panel Features

- **16 programmable zones...** zones can be NC with no EOLR, NO/NC with single EOLR or NC with double EOLR.
 - 30 programmable zone types & 8 zone options
- **2 PGM outputs...** each with 2 application choices :
 - as standard PGM output – 59 programmable options
 - as addressable loop – up to 112 addressable devices.
- **1 supervised bell circuit...** 59 programmable options
- **1 unswitched auxiliary power supply**
- **1 switched auxiliary power supply**
- **supervised digital alarm communicator with 4 formats :**
 - 20 bps, 1400/2300Hz handshake
 - Contact ID - SIA with auto-reporting codes
- **3 telephone numbers...** 32 digits each
- **3 event initiated pager formats**
- **supervised battery charger**
- **PC-Link connector...** for local upload/download
- **8 system partitions...** 9 account codes
- **1,000 user/card codes...** 64 access levels
- **user/card codes assignable by partition**
- **3,000 event buffer...** 2,800 viewable on keypad
- **59 programmable output options for :**
 - bell zone, PGM outputs, relay outputs, transistor outputs
- **comprehensive scheduling :**
 - 99 date schedules - 50 arm/disarm schedules
 - 16 automation schedules - 4 two year holiday schedules
 - 99 open/close suppression schedules
 - 50 addressable smoke detector test schedules
- **multiple communication capabilities :**
 - built in digital dialer
 - optional module for DVAC - optional cellular communications
 - optional Long-range radio communication
- **upload/download capability...** full featured with separate upload/download phone number

System Expansion

The PC4020 is easily expanded by adding input/output and functional modules onto the 4-wire communications bus (Combus).

- **Combus...** up to four runs of 1,000 feet (305 m), can be t-tapped and is supervised for low voltage and module communication.
- **up to 16 LCD keypads...** 32 character display
 - complete system programming via keypads
 - keypads can be 'partition' or 'global' operation
 - Ready, Armed, and Trouble indicators – LCD4501
 - 5 programmable function keys – LCD-4501
 - 27 function key options
 - Trouble and Armed indicators – LCD4500
 - piezo buzzer for audible feedback and trouble
 - 4 keypad activated alarms – Panic, Emergency, Fire, Duress
- **up to 128 hardwired zones...** using PC4108A/PC4116 eight and sixteen zone expansion modules.
- **up to 64 wireless zones...** using the PC4164RS wireless receiver and DSC wireless sensors and control devices.
- **up to 112 addressable zones...** using the main panel PGM outputs as addressable loops and DSC addressable sensors.

Hardwired, Wireless and Addressable zones may be mixed on the system up to the total system capacity of 128 zones.

- **up to 144 low current outputs...** using PC4216 modules – 16 outputs per module – 9 modules per system.
- **up to 64 relay outputs...** using PC4204 quad relay/power supply modules – up to 16 modules/system – each PC4204 also provides up to 1 amp of auxiliary power and can be used to repower the Combus.
- **point/graphic annunciation...** using PC4632/PC4664 remote annunciators for system, partition and zone annunciation
- **up to 32 access controlled doors...** using up to 16 PC4820 two reader access control modules with stand alone capability.
- **X-10 automation...** using the Escort PC4580 module – controls up to thirty two X-10 devices and provides voice assisted system status and control from any touchtone telephone.
- **system printer or DVACS communicator...** using the PC4400 printer/DVACS interface module.
- **backup alarm communication using :**
 - Links 1000™ cellular communicator
 - Links 2150™ or Links 2450™ long-range radio transmitters.

All of the features, functions, and expansion capabilities of the PC4020 control panel are included in the PC4020CF versions.

Electrical Specifications

- **bell output...** 12VDC, 700mA max. continuous
 - up to 2A for 4 minutes using battery assist.
 - PTC over current protected – self-restoring.
 - **AUX+ output...** 12VDC, 500mA max.
 - **SAUX+ output...** 12VDC, 300mA max.
 - SAUX+ output is normally +12VDC and power is removed upon activation. Typically used to reset 4-wire smoke detectors.

Note... total for AUX+ output and SAUX+ output is 500mA max. e.g. If the SAUX+ output is loaded to 200mA then only 300mA remains for the AUX+ output.
 - **AUX+ and SAUX+ outputs protected by a common PTC over current device which is self-restoring.**
 - **PGM outputs :**
 - as standard PGM outputs... 12VDC, 50mA max. each. PGM outputs are normally unpowered and switch to +12VDC upon activation.
 - as addressable outputs... 12VDC, 170mA max. each

Note... PGM outputs are individually programmable as addressable loops or as general purpose PGM outputs.
 - **Combus...** 500mA max. from the PC4020 main panel
 - additional power is provided by PC4204 modules. Maximum Combus capacitance is 80nF which is typically 4,000 feet (1,219m) of 22AWG wire. Consult wire manufacturer for specifications of wire to be used.
- Note... total loading for the Bell output, AUX+, SAUX+, PGM1, PGM2 and the Combus must not exceed 900mA. This limit may be exceeded by bell output if extra current required is drawn from the battery.**
- **battery charger...** up to 350mA to charge 12volt lead-acid batteries up to 14Ah capacity. Battery charger is supervised for opens and is protected by PTC over current device which is self-restoring.
 - **input power...** 16VAC, 40VA
 - **ground fault detection...** built-in and enabled by connecting earth ground to EGND terminal on PC4020 main panel. (use for 'CF' version panels only)

Mechanical Specifications

- **operating environment** - 32 to 122°F (0 to 50°C)
- 90% RH non-condensing
- **PC4050C beige cabinet :**
 - surface mount
 - hinged door with screw closure.
 - provision for door keylock
 - provision for door and wall tamper switches.
 - space for two 12volt 7Ah lead-acid rechargeable batteries.
 - 14.8"H x 12.0"W x 4.9"D (37.6 x 30.5 x 12.5cm)

Typical System Arrangement

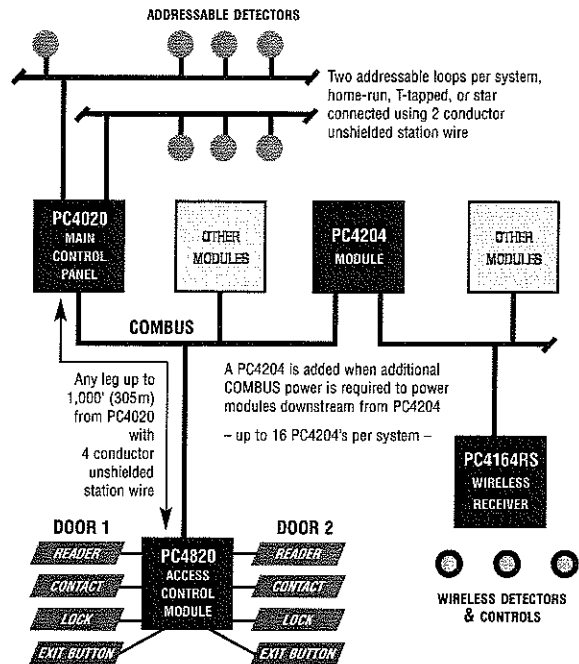

Ordering Information

PC4020... security control panel which includes :

- PC4020... main control module
- PC4050C... beige cabinet
- installation manual, user manual, and programming worksheets
- module mounting hardware and 32 EOL resistors

PC4020CAR... as PC4020 but with PC4050CAR attack resistant cabinet

Keypads are not supplied with the main panel – at least one keypad is required per system. Select from the following keypad types :

LCD4500... alphanumeric keypad without function keys

LCD4500T... as LCD4500 but with wall tamper switch

LCD4501... alphanumeric keypad with 5 function keys

LCD4501T... as LCD4501 but with wall tamper switch

LCD4520/20T, LCD4500R/TR, LCD4521/21T, LCD4501R/TR... identical to the above but have red bezels for use with PC4020CF fire panels.

Listings

USA⁽¹⁾

UL1610 Central Station Burglar Alarm
 UL609 Local Burglar Alarm
 UL365 Police Station Burglar Alarm
 UL985 Household Fire Warning
 UL1023 Household Burglar Alarm

CANADA

ULC-S527 Central Station Fire Alarm
 ULC-S302 Central & Monitoring Station Burglar Alarm
 ULC-S303 Local Alarm (Commercial Burglary)
 ULC-S310 Household Burglar Alarm
 ULC-S545 Household Fire Warning
 UL294 Access Control

⁽¹⁾ At least one fire version keypad must be used with Maxsys UL listed 'CF' commercial fire panels

⁽²⁾ The Links1000™ Cellular Communicator has not been investigated by UL



©2002 Digital Security Controls Ltd.
 Toronto, Canada
 www.dsc.com
 An ISO9001 registered company

MAXSYS®

INTEGRATED SYSTEMS TECHNOLOGY

PC4820

DUAL READER ACCESS CONTROL MODULE

The PC4820 enhances the value of MAXSYS by tightly integrating access control with MAXSYS security and fire features.

Providing 2 door access control, the PC4820 provides the ultimate in security system ease of use and maximum reduction of false alarms by allowing users to arm/disarm the security system while locking/unlocking the door from outside of the protected space.

Up to 16 PC4820 modules, controlling up to 32 doors, can be added to PC4010/4020 systems via the systems 4-wire Combus using standard, unshielded station wire up to 1,000ft (305m) from the control panel .

System Capacities

- **PC4010, PC4010CF, PC4020, and PC4020CF control panels :**
 - up to 16 PC4820 modules... for up to 32 readers
 - 1,000 access cards

Reader Technologies Supported

- **Polaris...** mag-stripe readers & cards
- **Shadow Prox...** proximity readers & cards
- **HID...** proximity readers & cards
- **Wiegand...** standard 26 bit
- **readers may be located up to 500ft. (152m) from PC4820**
 - shielded cable always required

PC4820 Features

- **2 reader access control**
 - 2 single reader doors or 1 door with entry/exit readers
- **flexible card holder privileges**
 - assign individual access privileges by door & by schedule
 - define user rights to permit arming & disarming by partition
 - designate "privileged" users who are authorized to validate access for "wait for privileged" users (guardian function)



- **full stand-alone operation... complete card database & all programming is maintained in the PC4820's non-volatile memory**
 - each module has its own time clock
 - in the event of power failure or PC4010/4020 system failure, each PC4820 access control module is capable of full operation on battery as a stand-alone access control system
 - **arm/disarm partitions & postpone autoarm by access card or access card and code...from outside the protected space**
 - arm & disarm from outside the protected partition to reduce false alarms caused by entry/exit errors
 - to disarm...** use a valid* card on a reader assigned to a partition to unlock the door and disarm the partition when the user opens the door.
 - to arm...** ensure that partition is secure, then use a valid* card on reader and activate the ARM input (usually a supervised pushbutton).
 - to postpone autoarm...** while a partition's autoarm pre-alert is sounding, use a valid* card on any reader assigned to the partition and activate the POST input (usually a supervised pushbutton). Autoarm will be postponed for up to 255 minutes, after which the system will attempt to autoarm again.
- * a valid card is one which has been programmed to perform the indicated function on a specified partition during a valid time for that user
- **64 access levels**
 - **99 seven-day schedules**
 - 4 time intervals per schedule
 - **4 two year holiday groups - 730 holidays**
 - **individual door-unlock schedules**
 - **automatic switching between daylight savings & standard time**
 - **program via keypad, or via computer with DLS-2 downloading software**
 - **non-volatile RAM**
 - does not lose programming when powered down
 - **fully supervised by PC4010/CF & PC4020/CF control panels for :**
 - lock trouble
 - low battery
 - tamper
 - reader low power trouble
 - AC failure
 - auxiliary power trouble
 - **door held open activates reader sounder**
 - **door forced open activates reader sounder and sets off zone alarm if system is armed**

Electrical Specifications

- **battery required...** 12 volt, 7.0Ah rechargeable lead acid
- **transformer required...** 16.5 VAC, 40VA
- **1.5A regulated power supply**
 - provides auxiliary power, and power to readers and door locks
 - provides electronic shutdown protection of battery, auxiliary output, reader power supplies, and lock device power output
- **power capacity per door :**
 - reader...** 125 mA max. @ 5VDC ...or... 125 mA max. @ 12VDC
 - lock...** 250 mA max. @ 12VDC
(Can be set to fail-safe or fail-secure modes. 12VDC, low current, continuous duty electric strikes recommended. **Check local regulations before installing electric locks**)
- **auxiliary power...** 125 mA max. @ 12VDC
- **4 wire QUAD connection to COMBUS**
 - up to 1,000ft (305m) from PC4010/CF & PC4020/CF control panels
- **2 low current outputs per door :**
 - open collector outputs switched to ground 25mA max.
 - LED...** to reader LED input
 - BUZ...** to reader piezo or other local door sounder
- **4 inputs per door...**
 - DOOR... door-contact input**
 - supervised alarm zone (N/C loop, single or double EOL resistors)
 - program to any partition and alarm zone from zones 9 to 64 on PC4010/CF panels and zones 17 to 128 on PC4020/CF panels
 - program as standard or auxiliary delay zone types
 - REX... request-to-exit input**
 - shunts or unlocks door for programmed door unlock time
 - N/C loop or single EOL resistor supervision
 - ARM... arm input**
 - permits arming by access card
 - N/C loop or single EOL resistor supervision
 - POST... autoarm postpone input**
 - permits autoarm postponement by access card
 - N/C loop or single EOL resistor supervision
- **current draw...** 35 mA (from Combus)

Mechanical Specifications

- **operating environment** - 32 to 122°F (0 to 50°C)
 - 90% RH non-condensing
- **PC4053 beige cabinet :**
 - surface mount
 - hinged door with screw closure.
 - provision for door keylock
 - provision for door and wall tamper switches.
 - space for two 12volt 7Ah rechargeable lead acid batteries.
 - 11.5"H x 11.0"W x 2.5"D (29.2 x 27.9 x 6.4 cm)

Typical System Arrangement

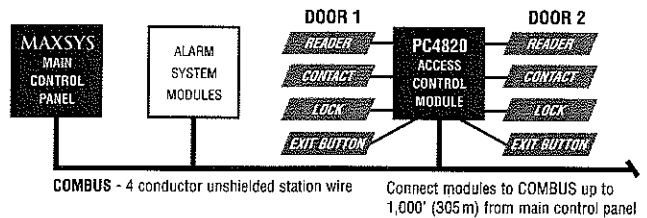

Ordering Information

PC4820... Dual Reader Panel c/w :

- PC4053 beige cabinet
- PC4820 dual reader module
- installation manual
- mounting hardware

Polaris... Mag-Stripe Readers/Cards

POL-1	Reader – indoor
POL-1W	Reader – outdoor
POL-2	Reader – indoor/outdoor
POL-2KP	Reader & keypad – indoor/outdoor
POL-C1CN	Mag-stripe card

Shadow Prox... Proximity Readers/Cards

SH-VR	Std size reader – indoor/outdoor
SH-1	Slim-line mullion size reader 4" (10cm) range – indoor/outdoor
SH-2	Wall-switch size reader 4" (10cm) range – indoor/outdoor
SH-5	Reader 16" (40cm) range – indoor
SH-X1	Reader 5" (13cm) mullion style
SH-X2	Reader 5" (13cm) single or double gang box mount
SH-C1	Proximity card
SH-K1	Proximity keytag

HID... Proximity Readers/Cards

HID-MP5365	Slimline reader 4-5" (10-13cm) range – indoor
HID-PR5355	Reader 5-9" (13-23 cm) range – indoor/outdoor
HID-PR5355KP.. ..	Reader w/ keypad 5-9" (13-23 cm) range – indoor/outdoor
HID-MX5375	Reader 18-24" (45-61 cm) range – indoor/outdoor
HID-C1325KSF	Proximity card
HID-C1345KSF	Proximity keytag

T.Rex... Request-to-Exit Detectors

KT-TREX-XL	Complete with piezo buzzer & tamper
KT-TREX-LT	No piezo, no tamper

Listing

UL294 – Access Control ... *in USA and Canada*



©2002 Digital Security Controls Ltd.
Toronto, Canada
www.dsc.com
An ISO9001 registered company

MAXSYS®

INTEGRATED SYSTEMS TECHNOLOGY

LCD4500/4501

PLAIN LANGUAGE KEYPADS

MAXSYS system keypads provide a plain language interface using a large 32 character LCD display with adjustable brightness and contrast.

All system programming and user operations can be performed using the LCD keypads. Keypads are connected to PC4010/4020 control panels via a 4-wire system communications bus (Combus) which provides power for the keypads and acts as the system communication channel.

Keypads are enrolled onto the system at the time of installation, and are supervised for low voltage and presence by the main panel.

Keypads Per System

PC4010, PC4010CF, PC4020, and PC4020CF control panels :

- up to 16 keypads
- any mix of LCD4500/4501 keypads can be used in a system
- keypads can be assigned as "global" – for system wide control or "partition" – for operation of a specific partition only

LCD4500 Series Keypads – Features

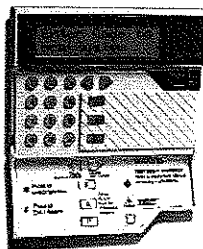
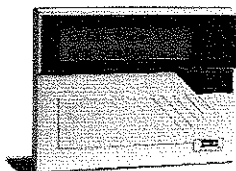

- two line, 32 character LCD display
- programmable LCD display contrast and brightness
- LCD display and keys backlit for low light viewing
- individual LED indicators for Trouble and Armed
- piezo buzzer provides audible feedback for correct/incorrect key entries, entry/exit alert, and system trouble conditions
- three dedicated keys for keypad activated alarms :
 - Fire, Panic, Auxiliary
- keypad activated Duress code... user code programmed as a Duress code.
- keys 1 to 5 programmable as function keys... see *Function Key Options* for a complete list of available functions.
- other keypad versions in LCD4500 series (R = Canadian version) :
 - LCD4500T..... keypad with wall tamper
 - LCD4520/4500R keypad with red bezel for fire panels
 - LCD4520T/4500TR keypad w/ wall tamper & red bezel for fire panels

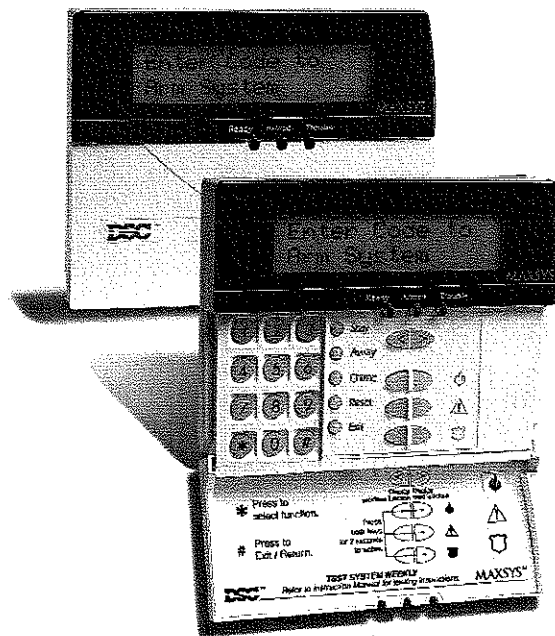

LCD4501

LCD4501 Series Keypads – Features

- two line, 32 character LCD display
- programmable LCD display contrast and brightness
- LCD display and keys backlit for low light viewing
- 'backlighting boost' provides extra key back-lighting when any key is pressed
- individual LED indicators for Trouble, Armed, and Ready
- piezo buzzer provides audible feedback for correct/incorrect key entries, entry/exit alert, and system trouble conditions
- three dedicated keys for keypad activated alarms :
 - Fire, Panic, Auxiliary
 - each key individually enabled via programming
 - each key individually programmable to activate the bell output with a choice of steady or pulsing output
 - each key individually programmable to activate the keypad buzzer to provide 3 beeps on a keypress.
- keypad activated Duress code... user code programmed as a Duress code.
- 5 individual programmable function keys...see *Function Key Options* for a complete list of available functions.

LCD4501 Keypad...factory default functions are :

1. Stay..... Stay arming
2. Away Away arming
3. Chime Door chime on/off
4. Reset..... Reset smoke detectors
5. Exit Activate quick exit

LCD4521/4501R series keypads (fire)...factory default functions are :

1. Silence Trouble
2. Silence Bells
3. Fire Reset
4. Fire Drill
5. Lamp Test

- other keypad versions in LCD4501 series (R = Canadian version) :
 - LCD4501T..... keypad with wall tamper
 - LCD4521/4501R keypad with red bezel for fire panels
 - LCD4521T/4501TR keypad w/ wall tamper & red bezel for fire panels

Function Key Options

The following is a complete list of functions that can be programmed for the five dedicated function keys on LCD4501 series keypads or for keys 1 through 5 on LCD4500 series keypads. Each keypad can be programmed with a different set of functions if desired.

- Null (no function)
- Stay Arm
- Away Arm
- No-Entry Arm
- Door Chime On/Off
- System Test
- Bypass Mode
- Trouble Display
- Alarm Memory
- Programming Access Codes
- User Functions
- Quick Exit
- Reactivate Stay/Away Zones
- Command Output Option #1-8
- Silence Trouble
- Silence Bells
- Fire Reset
- Fire Drill
- Lamp Test
- Fire Inspection Test

Specifications

- **operating environment** - 32 to 122°F (0 to 50°C)
- 90% RH non-condensing
- **current draw** ...55mA (from Combus)
...90mA with backlighting boost on LCD4501 series
- **dimensions** ...5.75" x 4.5" x 1" deep (14.4 x 11.4 x 2.5cm)

Listings

USA*

UL1610 Central Station Burglar Alarm
 UL609 Local Burglar Alarm
 UL365 Police Station Burglar Alarm
 UL985 Household Fire Warning
 UL1023 Household Burglar Alarm

In addition, the LCD4520/21 is listed :

UL864 Control Units System
 (L, CS, -A, M, SS, WF)

* At least one fire version keypad must be used with Maxsys UL listed 'CF' commercial fire panels

CANADA

ULC-S527 Central Station Fire Alarm
 ULC-S302 Central & Monitoring Station Burglar Alarm
 ULC-S303 Local Alarm (Commercial Burglary)
 ULC-S310 Household Burglar Alarm
 ULC-S545 Household Fire Warning
 UL294 Access Control

Typical System Arrangement

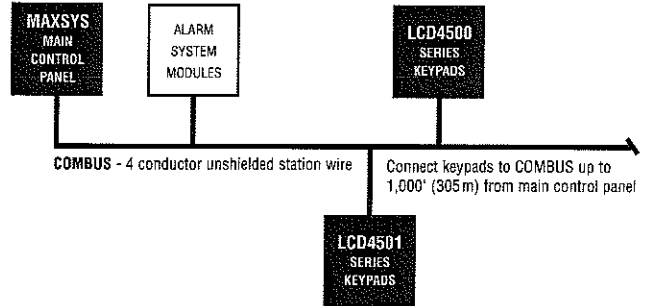

Ordering Information

LCD4500 Series... without dedicated function keys :

- LCD4500 LCD keypad
 LCD4500T LCD keypad with wall tamper
 LCD4520 LCD keypad with red bezel for fire panels
 LCD4520T LCD keypad with red bezel and wall tamper

Canadian Version

- LCD4500R LCD keypad with red bezel for fire panels (CND)
 LCD4500TR LCD keypad with red bezel and wall tamper (CND)

LCD4501 Series... with 5 dedicated function keys :

- LCD4501 LCD keypad with 5 function keys
 LCD4501T LCD keypad with 5 function keys & wall tamper
 LCD4521 LCD keypad with 5 function keys & red bezel for fire panels
 LCD4521T keypad with 5 function keys, wall tamper & red bezel for fire panels

Canadian Version

- LCD4501R LCD keypad with 5 function keys & red bezel for fire panels (CND)
 LCD4501TR keypad with 5 function keys, wall tamper & red bezel for fire panels (CND)



Digital Security Controls
 1645 Flint Road, Downsview, ON Canada M3J 2J6

Distributed by :

ioProx Proximity Readers

Features That Make a Difference:

- Choose from Kantech™ eXtended Secure Format (XSF) or 26-bit Wiegand format
- Digital Signal Processing (DSP) for enhanced security
- Weatherproof design for indoor and outdoor applications
- Integrated piezo buzzer & bicolor LED
- Integrated tamper switch on P600 (optional on other models)
- The use of quick connect terminal blocks (P225 and P325 series) allows for easy wiring and saves you time and money
- Use the keypad's * and # buttons in conjunction with the EntraPass software to arm and disarm external alarm panels
- Up to 73 cm (29 in) read range (P600)

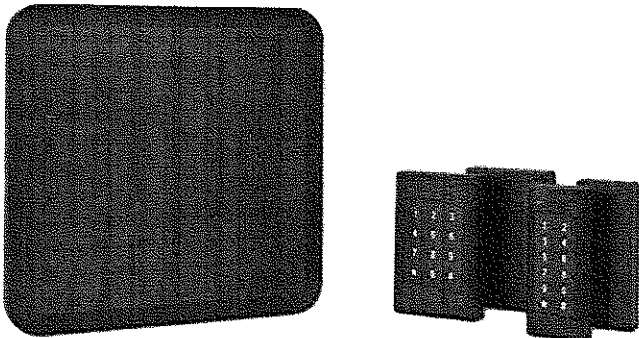

Choose from five ioProx readers that easily meet the demands of any application. The readers are attractive, compact, weatherized, and vandal-resistant, making them suitable for installation in a variety of environments.

Easy Installation

Snap-and-lock terminal blocks (P225 and P325 series) allow for easy wiring, saving time and money.

Voltage Requirements

Depending on the model selected, power requirements range from 4.5 to 14 VDC (P225 and P325 series) or 12 to 28 VDC (P600), providing compatibility with virtually any controller on the market. This allows a system to be upgraded simply by changing readers and cards without rewiring.

Integrated 12-Button Keypad

Integrated keypad models are ADA-compliant and based on the 8-bit burst industry standard. Convenient features such as arming/disarming and alarm triggering are pre-programmed for use with Kantech EntraPass software.

Read Range

Depending on the model selected and the environmental conditions, read range varies from 16.5 cm to 73 cm (6.5 in to 29 in). With its extended range, the P600 Long Range Reader is ideal for parking lots and applications where an extended read range is needed to facilitate access.

Unshielded Cable

ioProx readers can be installed using unshielded cable to a distance of up to 300 m (1000 ft) from the controller. Using this type of cable significantly reduces installation costs.

XSF Security

Kantech eXtended Secure Format (XSF) readers are compatible only with Kantech EntraPass software which includes access to over four billion unique codes. Kantech's XSF cards provide increased security against card duplication.

	P225/P225KP Mullion	P325/P325KP Single Gang	P600 Long Range
Typical Read Range	Up to 16.5 cm (6.5 in)	Up to 20.5 cm (8 in)	Up to 73 cm (29 in)
Input Voltage	4.5 to 14 VDC	4.5 to 14 VDC	12 to 28 VDC
Current DC Maximum	45 mA	45 mA	1 A
Dimensions (H x W x D)	114.3 x 44.5 x 21.3 cm (4.50 x 1.75 x 0.84 in)	115.6 x 71.1 x 21.3 cm (4.55 x 2.80 x 0.84 in)	285 x 285 x 31.5 cm (11.25 x 11.25 x 1.25 in)
Weight	90 g (3.2 oz)	150 g (5.3 oz)	1085 g (38.3 oz)
Format	XSF or 26-bit Wiegand	XSF or 26-bit Wiegand	Field configurable for XSF or 26-bit Wiegand
Maximum Distance From Controller:			
Reader Power 5 VDC	137 m (450 ft)	150 m (500 ft)	—
Reader Power 12 VDC	300 m (1000 ft)	300 m (1000 ft)	150 m (500 ft)
Reader Power 28 VDC	—	—	300 m (1000 ft)
Cable Type	#22 AWG Belden ref #8742 3 twisted pairs, unshielded	#22 AWG Belden ref #8742 3 twisted pairs, unshielded	#18 AWG Belden ref #5304UE 6 wires, unshielded
Tamper Switch	Optional P-TAMP	Optional P-TAMP	Integrated
High Endurance Braille Keypad	P225KP only	P325KP only	N/A

Common Specifications

Color	Black	Operating Temperature	-35°C to 65°C (-30°F to 150°F)
Transmit Frequency	125 kHz	Certifications	FCC Part 15 Class B, CE, UL
LED Indicator	Bicolor (Red, Green)	Environmental	RoHS, WEEE
Piezo Buzzer	Integrated		

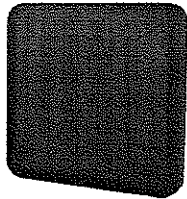

P600

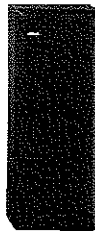

P225XSF
P225W26

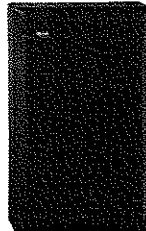

P325XSF
P325W26



P225KPXSF
P225KPW26

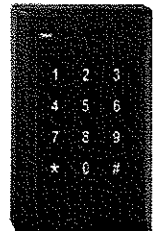

P325KPXSF
P325KPW26



P50TAG
Self-Adhesive
Tag



P40KEY
Keypad

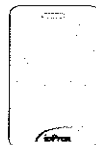

P105HL
Standard Shell Card

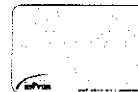

P200YE
Dye-sub Card



P300MG
Dye-sub Card
with Mag Stripe

Cards and readers shown are not to scale
XSF = Kantech eXtended Secure Format
W26 = 26-bit Wiegand format
ioProx cards are compatible with both XSF and 26-bit Wiegand format ioProx readers

Product offerings and specifications are subject to change without notice. Actual products may vary from photos. Not all products include all features. Availability varies by region; contact your sales representative. Certain product names mentioned herein may be trade names and/or registered trademarks of other companies.

© 2007 Tyco Safety Products, Canada, Ltd. All rights reserved. KT0085-DS-200710-R01-LT-EN

www.kantech.com



tyco

P325W26 / P325KPW26

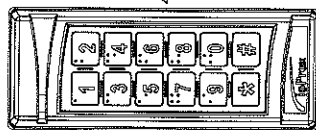
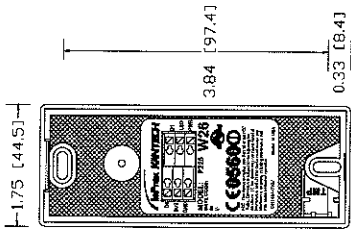
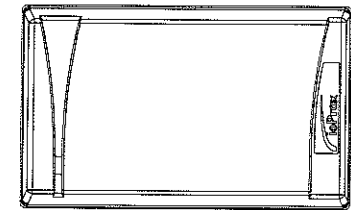
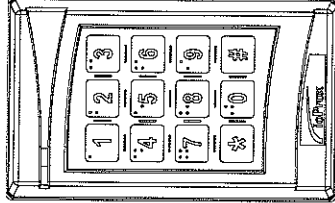
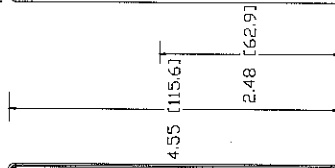
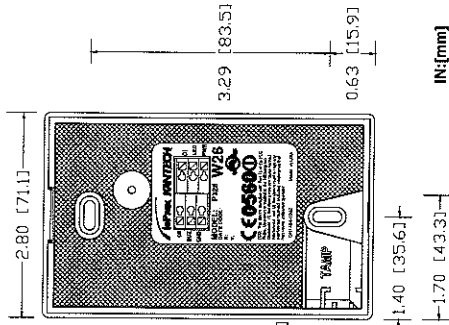

P325W26
P325KPW26
Cajetina simple

P325KP
Montantes de
puertas

P325
Montantes de porte

P325KP
Mullion

P325KP
Mullion

P325KP
Mullion

P325
Montantes de porte

Especificaciones Técnicas

Specifications Techniques

Technical Specifications

P325W26 P325KPW26 Cajetina simple	Hasta 16.5 cm (6.5") 4.5 a 14 VCC 45 mA 114.3 x 44.5 x 21.3 115.6 x 71.1 x 21.3 4.55 x 2.8 x 0.84 90 g (3.2 oz) Negro 125 kHz Bicolor (rojo y verde) Integrado -35°C a 65°C (-30°F a 150°F) Wiegand 26 bits *	P325W26 P325KPW26 Montantes de puertas	Hasta 16.5 cm (6.5") 4.5 a 14 VCC 45 mA 114.3 x 44.5 x 21.3 115.6 x 71.1 x 21.3 4.55 x 2.8 x 0.84 90 g (3.2 oz) Negro 125 kHz Bicolor (rojo y verde) Integrado -35°C a 65°C (-30°F a 150°F) Wiegand 26 bits *	P325W26 P325KPW26 Cajetina simple	Hasta 20.5 cm (8") 4.5 a 14 VCC 45 mA 115.6 x 71.1 x 21.3 115.6 x 71.1 x 21.3 4.55 x 2.8 x 0.84 150 g (5.3 oz) Negro 125 kHz Bicolor (rojo y verde) Integrado -35°C a 65°C (-30°F a 150°F) Wiegand 26 bits *
---	--	---	--	---	---

P325W26 P325KPW26 Cajetina simple	Jusqu'à 20.5 cm (8") 4.5 à 14 VCC 45 mA 115.6 x 71.1 x 21.3 115.6 x 71.1 x 21.3 4.55 x 2.8 x 0.84 150 g (5.3 oz) Noir 125 kHz Bicolore (rouge et vert) Intégré -35°C à 65°C (-30°F à 150°F) Wiegand 26 bits *	P325W26 P325KPW26 Montantes de porte	Jusqu'à 16.5 cm (6.5") 4.5 à 14 VCC 45 mA 114.3 x 44.5 x 21.3 115.6 x 71.1 x 21.3 4.5 x 1.75 x 0.84 90 g (3.2 oz) Noir 125 kHz Bicolore (rouge et vert) Intégré -35°C à 65°C (-30°F à 150°F) Wiegand 26 bits *	P325W26 P325KPW26 Cajetina simple	Jusqu'à 20.5 cm (8") 4.5 à 14 VCC 45 mA 115.6 x 71.1 x 21.3 115.6 x 71.1 x 21.3 4.55 x 2.8 x 0.84 150 g (5.3 oz) Noir 125 kHz Bicolore (rouge et vert) Intégré -35°C à 65°C (-30°F à 150°F) Wiegand 26 bits *
---	--	--	---	---	--

P325W26 P325KPW26 Cajetina simple	Up to 20.5cm (8") 4.5 to 14 VDC 45 mA 115.6 x 71.1 x 21.3 115.6 x 71.1 x 21.3 4.55 x 2.8 x 0.84 150 g (5.3 oz) Black 125 kHz Bicolor (red and green) Integrated -35°C to 65°C (-30°F to 150°F) 26-bit Wiegand *	P325W26 P325KPW26 Montantes de porte	Up to 16.5 cm (6.5") 4.5 to 14 VDC 45 mA 114.3 x 44.5 x 21.3 115.6 x 71.1 x 21.3 4.5 x 1.75 x 0.84 90 g (3.2 oz) Black 125 kHz Bicolor (red and green) Integrated -35°C to 65°C (-30°F to 150°F) 26-bit Wiegand *	P325W26 P325KPW26 Cajetina simple	Up to 20.5cm (8") 4.5 to 14 VDC 45 mA 115.6 x 71.1 x 21.3 115.6 x 71.1 x 21.3 4.55 x 2.8 x 0.84 150 g (5.3 oz) Black 125 kHz Bicolor (red and green) Integrated -35°C to 65°C (-30°F to 150°F) 26-bit Wiegand *
---	--	--	--	---	--

*Formato estándar Wiegand de 26 bits

*Formato Wiegand 26 bits estándar

*Standard 26-bit Wiegand format

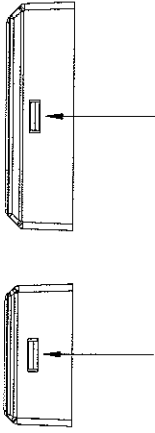
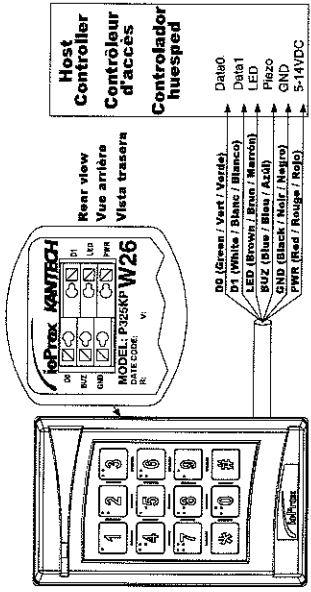
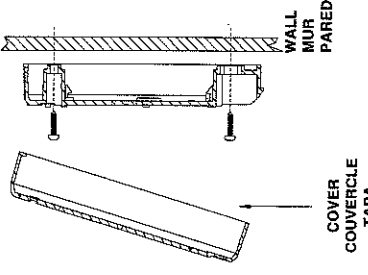
<p style="text-align: center;">2</p> <p style="text-align: center;">P225 / P225KP P325 / P325KP</p>  <p style="text-align: center;">LOCKING TAB LANGUETTE DE VEROUILLAGE LENGÜETA</p> <p style="text-align: center;"><small>Note: UL has only verified compatibility with specific UL listed Access Control Units. Please consult the Access Control Unit's Installation Instructions for more information.</small></p>	<p style="text-align: center;">3</p>  <p style="text-align: center;">READER LECTEUR LECTOR</p> <p style="text-align: center;"><small>Note importante : Veuillez noter que UL a seulement vérifié la compatibilité des lecteurs loProx avec certaines unités spécifiques de contrôle des accès déjà certifiées UL. Veuillez consulter les instructions d'installation de ces unités de contrôle des accès pour obtenir de plus amples informations sur le sujet.</small></p>	<p style="text-align: center;">4-5</p>  <p style="text-align: center;">COVER COUVERCLE TAPA</p> <p style="text-align: center;"><small>Note : UL ha verificado solamente la compatibilidad de los lectores loProx con especificadas unidades de control de acceso con certificación UL. Consulte, por favor, las instrucciones de instalación de las unidades de control de acceso para más información.</small></p>
<p style="text-align: center;">Mounting Instructions</p> <p>Follow these instructions to install reader:</p> <ol style="list-style-type: none"> 1. Pull controller's wires out of the wall. 2. Using a flat screwdriver, unlock the cover by gently pressing the tab located at the base of the reader while pulling it forward to remove the plastic cover. This provides access to the mounting holes located in the reader's transparent case. 3. Connect the reader by fully inserting in their respective positions each of the quick connect terminal block's wires. Using a small flat screwdriver, firmly press the corresponding terminal block's button to insert or remove a wire. 4. Mount reader on wall using #6 (M3.5) screws. Using screws of a larger caliber could cause damage to the reader. 5. Starting with the top portion, replace the reader's plastic cover. Firmly press cover at the base of the reader. The "click" sound will inform you that the cover has been properly shut. 	<p style="text-align: center;">Instructions pour montage</p> <p>Effectuer les étapes suivantes pour l'installation du lecteur :</p> <ol style="list-style-type: none"> 1. Sortir les fils du contrôleur hors du mur. 2. À l'aide d'un tournevis plat, déverrouiller le couvercle en appuyant légèrement sur la languette située à la base du lecteur tout en le tirant vers l'avant pour en retirer le couvercle de plastique. Ceci permet d'accéder aux trous de fixation situés dans le boîtier transparent du lecteur. 3. Brancher le lecteur en insérant à fond dans sa position respective chaque fil du terminal à connexion rapide (quick connect terminal block). Enfoncer fermement le bouton du bornier correspondant à l'aide d'un petit tournevis plat pour l'insertion ou le retrait d'un fil (voir diagramme). 4. Fixer le lecteur au mur en utilisant des vis #6 (M3.5). Attention, l'utilisation de vis de plus gros calibre pourrait endommager le lecteur de façon irréversible! 5. Remplacer le couvercle de plastique sur le lecteur en prenant soins d'ancrer la partie supérieure en premier. Sécuriser le couvercle en appuyant fermement à la base du lecteur jusqu'à ce qu'un clic se fasse entendre. 	<p style="text-align: center;">Instrucciones de instalación</p> <p>Siga las siguientes instrucciones para instalar el lector:</p> <ol style="list-style-type: none"> 1. Tire los cables del controlador fuera del muro. 2. Con un tornillador plano, abra cuidadosamente la cubierta apoyando ligeramente sobre la lengüeta situada en la base del lector, tirándolo hacia adelante para así retirar la cubierta plástica. Esto le permitirá acceder a los agujeros de fijación ubicados en la caja transparente del lector. 3. Conectar el lector insertando los cables en su posición respectiva en el terminal de conexión rápida. Presione firmemente el botón del borne correspondiente con la ayuda de un tornillador plano para la inserción o retirada de un cable. 4. Fijar al muro usando los tornillos #6 (M3.5). Atención : el uso de tornillos más grandes puede dañar el lector de forma irreparable. 5. Reubicar la cubierta de plástico sobre el lector tomando la precaución de montar la parte superior en primer lugar. Asegure la base del lector apoyando firmemente hasta que oiga un clic.

Addressable Detection

Power & Communications

via

Two-Wire Addressable

Multiplex Loop

AMP-700 Series Contact Modules

Turn ordinary detectors into
ADDRESSABLE DEVICES!

Flexible
to fit a host of
applications!

For use with :

MAXSYS®

Hybrid Addressable Security System

and

Power 832 & 864

Security Systems Equipped with PC5100 Module



© 1999 Digital Security Controls Ltd.
Toronto, Canada
www.dscgrp.com

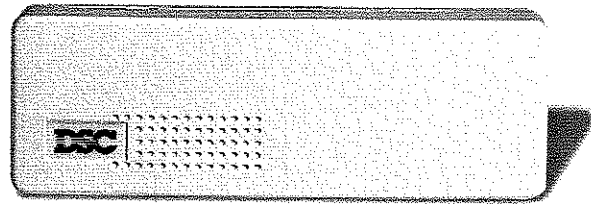

AMP-700 Magnetic Door/Window Contact

- Magnetic contact with internal tamper switch to monitor both alarm and tamper states

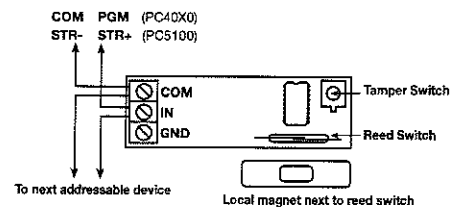

AMP-701 Contact Input Module

- Connect an external device to monitor alarm, tamper, and trouble
- External devices must have N/C dry contact outputs

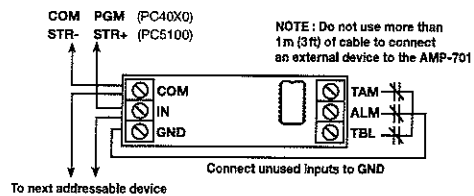

AMP-702 Fire Point Module

- Has a 5.6Ω EOL supervised loop that monitors N/O contacts
- An open on the loop initiates a trouble and a short initiates an alarm

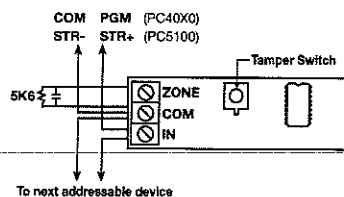

Specifications AMP-700 Series

	700 & 701		702	
	Standby	In Alarm	Standby	In Alarm
• Current rating.....	0.8mA	1.1mA	1.1mA	1.6mA
• Operating environment	32 to 120°F (0 to 49°C) 5%-95% non-condensing			
• Dimensions.....	3 3/8" L x 1 1/8" W x 3/4" D (8.5 x 2.7 x 1.9cm)			



- News / Updates
- Indoor Products
- Outdoor Products
- Sales / Support
- Training
- About Us
- Contact Us

- Security Products**
- ▶ Indoor Products
 - Residential
 - Commercial
 - Dual Technology
 - Wireless
 - Photobeams
 - ▶ Outdoor Products
 - Outdoor PIR
 - Wireless
 - Photobeams
 - AX-100/200Plus
 - AX-100/200TF
 - AX-250/500Plus
 - AX-350/650TF
 - AX-70/130/200TN
 - BX-100Plus
 - Redwall
 - Sensor Camera
 - Beam Tower

- Resources**
- ▶ Quick Selection Guide
 - ▶ Product Spec Matrix

Home > Outdoor Products > Photobeams > AX-70/130/200TN

AX-70/130/200TN

Photoelectric detectors are widely used for perimeter surveillance in severe outdoor environmental conditions. Therefore, the highly durable structure is considered a key factor for accurate operation to prevent false alarms.

Our new AX-TN Series achieves the IP65 high durable structure by using the rubber packing for all conceivable points and it prevents the rain, dust, and tiny insects getting into the unit.



Model
AX-70TN: 70ft, AX-130TN: 130ft, AX-200TN: 200ft

Features

- IP65 structure with high sealing rubber packing
- Lightning protection
- Anti-frost hood cover
- Easy angle adjustment
- High grade spherical lens
- 99% beam blocking stability
- A.G.C. (Automatic Gain Control) Circuit
- Adjustable beam interruption period

Dimension

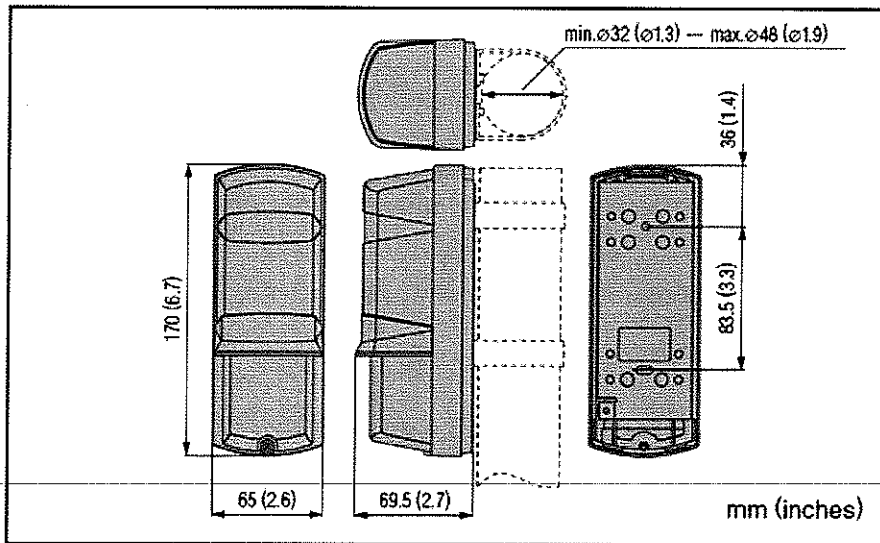



Specification

	AX-130TN	AX-200TN	AX-70TN
Status	New	New	New
Detection Method	AIR	AIR	AIR
Detection Range Outdoor	130ft. (40m)	200ft. (60m)	70ft. (20m)
Beam	Twin	Twin	Twin
Beam Characteristics	Pulsed infrared	Pulsed infrared	Pulsed infrared

Beam Blocking Ratio	0.99	0.99	0.99
Interruption Period	50 - 500msec	50 - 500msec	50 - 500msec
Mounting	Wall / Pole	Wall / Pole	Wall / Pole
Alignment Angle	+/- 90° Horizontal	+/- 90° Horizontal	+/- 90° Horizontal
Alignment Angle 2	+/- 5° Vertical	+/- 5° Vertical	+/- 5° Vertical
View Finder	X	X	X
Monitor Jack for Alignment	X	X	X
Automatic Gain Control	X	X	X
Lightning Protection	14kV	14kV	14kV
Power Input	10.5 - 28V DC	10.5 - 28V DC	10.5 - 28V DC
Current Consumption	41mA max	45mA max	38mA max
Alarm Output	N.C.	N.C.	N.C.
Alarm Indication LED	X	X	X
Anti-frost design	X	X	X
Optional Heating Unit	HU-3	HU-3	HU-3
IP Rating	IP65	IP65	IP65
Operating Temperature	-30°F - +140°F (-35°C - +60°C)	-30°F - +140°F (-35°C - +60°C)	-30°F - +140°F (-35°C - +60°C)
Operating Humidity	95% max	95% max	95% max
Dimensions (W x H x D)	2.6 x 6.7 x 2.7inches (65 x 170 x 69.5mm)	2.6 x 6.7 x 2.7inches (65 x 170 x 69.5mm)	2.6 x 6.7 x 2.7inches (65 x 170 x 69.5mm)
Coverage	130ft	200ft	70ft

DOWNLOAD

-  [Download AX TN Series Full Color Brochure](#)
-  [Download AX TN Installers Manual](#)

[Back to top](#)

[| Privacy | Contact |](#)

OPTEX INC. COPYRIGHT(C) 2007 OPTEx INC. ALL RIGHTS RESERVED.