



State of West Virginia
 Department of Administration
 Purchasing Division
 2019 Washington Street East
 Post Office Box 50130
 Charleston, WV 25305-0130

Request for Quotation

RFQ NUMBER
PTR07004

PAGE
1

ADDRESS CORRESPONDENCE TO ATTENTION OF:
**KRISTA FERRELL
 304-558-2596**

VENDOR

RFQ COPY
 TYPE NAME/ADDRESS HERE
*SOLAR SIGNALS
 556 O'CONNOR DR.
 KINGSTON ONTARIO
 K7P 1N3
 CANADA*

SHIP TO

DIVISION OF PUBLIC TRANSIT
 BUILDING 5, ROOM 830
 1900 KANAWHA BOULEVARD, EAST
 CHARLESTON, WV
 25305-0432 304-558-0428

DATE PRINTED 08/07/2006	TERMS OF SALE	SHIP VIA	F.O.B.	FREIGHT TERMS
BID OPENING DATE: 08/31/2006		BID OPENING TIME 01:30PM		

LINE	QUANTITY	UOP	CAT. NO.	ITEM NUMBER	UNIT PRICE	AMOUNT
0001	1	EA		155-12 <i>OPTION 4</i>		<i>SER PAGE 15</i>
<p>PRE-ENGINEERED BUS SHELTERS AND SOLAR LIGHTING</p> <p>REQUEST FOR QUOTATION</p> <p>THE WEST VIRGINIA PURCHASING DIVISION FOR THE AGENCY, THE WEST VIRGINIA DIVISION OF PUBLIC TRANSIT, IS SOLICITING BIDS FOR AN OPEN END CONTRACT TO PROVIDE THE AGENCY WITH PRE-ENGINEERED BUS PASSENGER SHELTERS, SOLAR LIGHTING SYSTEM FOR BUS SHELTERS, AND SOLAR POWERED TRANSIT STOPS PER THE ATTACHED SPECIFICATIONS.</p> <p>EXHIBIT 3</p> <p>LIFE OF CONTRACT: THIS CONTRACT BECOMES EFFECTIVE ON UPON AWARD AND EXTENDS FOR A PERIOD OF ONE (1) YEAR OR UNTIL SUCH "REASONABLE TIME" THEREAFTER AS IS NECESSARY TO OBTAIN A NEW CONTRACT OR RENEW THE ORIGINAL CONTRACT. THE "REASONABLE TIME" PERIOD SHALL NOT EXCEED TWELVE (12) MONTHS. DURING THIS "REASONABLE TIME" THE VENDOR MAY TERMINATE THIS CONTRACT FOR ANY REASON UPON GIVING THE DIRECTOR OF PURCHASING 30 DAYS WRITTEN NOTICE.</p> <p>UNLESS SPECIFIC PROVISIONS ARE STIPULATED ELSEWHERE IN THIS CONTRACT DOCUMENT, THE TERMS, CONDITIONS AND PRICING SET HEREIN ARE FIRM FOR THE LIFE OF THE CONTRACT.</p> <p>RENEWAL: THIS CONTRACT MAY BE RENEWED UPON THE MUTUAL</p>						

SEE REVERSE SIDE FOR TERMS AND CONDITIONS

SIGNATURE <i>[Signature]</i>	TELEPHONE (514) 695-1546	DATE Aug. 29 2006
TITLE SALES DIRECTOR	ADDRESS CHANGES TO BE NOTED ABOVE	

WHEN RESPONDING TO RFQ, INSERT NAME AND ADDRESS IN SPACE ABOVE LABELED 'VENDOR'

**GENERAL TERMS & CONDITIONS
REQUEST FOR QUOTATION (RFQ) AND REQUEST FOR PROPOSAL (RFP)**

1. Awards will be made in the best interest of the State of West Virginia.
2. The State may accept or reject in part, or in whole, any bid.
3. All quotations are governed by the *West Virginia Code* and the *Legislative Rules* of the Purchasing Division.
4. Prior to any award, the apparent successful vendor must be properly registered with the Purchasing Division and have paid the required \$125.00 registration fee.
5. All services performed or goods delivered under State Purchase Orders/Contracts are to be continued for the term of the Purchase Order/Contract, contingent upon funds being appropriated by the Legislature or otherwise being made available. In the event funds are not appropriated or otherwise available for these services or goods, this Purchase Order/Contract becomes void and of no effect after June 30.
6. Payment may only be made after the delivery and acceptance of goods or services.
7. Interest may be paid for late payment in accordance with the *West Virginia Code*.
8. Vendor preference will be granted upon written request in accordance with the *West Virginia Code*.
9. The State of West Virginia is exempt from federal and state taxes and will not pay or reimburse such taxes.
10. The Director of Purchasing may cancel any Purchase Order/Contract upon 30 days written notice to the seller.
11. The laws of the State of West Virginia and the *Legislative Rules* of the Purchasing Division shall govern all rights and duties under the Contract, including without limitation the validity of this Purchase Order/Contract.
12. Any reference to automatic renewal is hereby deleted. The Contract may be renewed only upon mutual written agreement of the parties.
13. **BANKRUPTCY:** In the event the vendor/contractor files for bankruptcy protection, this contract is automatically null and void, and is terminated without further order.
14. **HIPAA Business Associate Addendum** - The West Virginia State Government HIPAA Business Associate Addendum (BAA), approved by the Attorney General, and available online at the Purchasing Division's web site (<http://www.state.wv.us/admin/purchase/vrc/hipaa.htm>) is hereby made part of the agreement. Provided that, the Agency meets the definition of a Covered Entity (45 CFR §160.103) and will be disclosing Protected Health Information (45 CFR §160.103) to the vendor.

INSTRUCTIONS TO BIDDERS

1. Use the quotation forms provided by the Purchasing Division.
2. **SPECIFICATIONS:** Items offered must be in compliance with the specifications. Any deviation from the specifications must be clearly indicated by the bidder. Alternates offered by the bidder as **EQUAL** to the specifications must be clearly defined. A bidder offering an alternate should attach complete specifications and literature to the bid. The Purchasing Division may waive minor deviations to specifications.
3. Complete all sections of the quotation form.
4. Unit prices shall prevail in cases of discrepancy.
5. All quotations are considered F.O.B. destination unless alternate shipping terms are clearly identified in the quotation.
6. **BID SUBMISSION:** All quotations must be delivered by the bidder to the office listed below prior to the date and time of the bid opening. Failure of the bidder to deliver the quotations on time will result in bid disqualifications.

SIGNED BID TO:

Department of Administration
Purchasing Division
2019 Washington Street East
Post Office Box 50130
Charleston, WV 25305-0130



State of West Virginia
 Department of Administration
 Purchasing Division
 2019 Washington Street East
 Post Office Box 50130
 Charleston, WV 25305-0130

Request for Quotation

RFQ NUMBER
PTR07004

PAGE
2

ADDRESS CORRESPONDENCE TO ATTENTION OF:
**KRISTA FERRELL
 304-558-2596**

VENDOR

RFQ COPY
 TYPE NAME/ADDRESS HERE

SHIP TO

DIVISION OF PUBLIC TRANSIT
 BUILDING 5, ROOM 830
 1900 KANAWHA BOULEVARD, EAST
 CHARLESTON, WV
 25305-0432 304-558-0428

DATE PRINTED 08/07/2006	TERMS OF SALE	SHIP VIA	F.O.B.	FREIGHT TERMS
-----------------------------------	---------------	----------	--------	---------------

BID OPENING DATE: **08/31/2006** BID OPENING TIME **01:30PM**

LINE	QUANTITY	UOP	CAT. NO.	ITEM NUMBER	UNIT PRICE	AMOUNT
<p>WRITTEN CONSENT OF THE SPENDING UNIT AND VENDOR, SUBMITTED TO THE DIRECTOR OF PURCHASING THIRTY (30) DAYS PRIOR TO THE EXPIRATION DATE. SUCH RENEWAL SHALL BE IN ACCORDANCE WITH THE TERMS AND CONDITIONS OF THE ORIGINAL CONTRACT AND SHALL BE LIMITED TO TWO (2) ONE (1) YEAR PERIODS.</p> <p>CANCELLATION: THE DIRECTOR OF PURCHASING RESERVES THE RIGHT TO CANCEL THIS CONTRACT IMMEDIATELY UPON WRITTEN NOTICE TO THE VENDOR IF THE COMMODITIES AND/OR SERVICES SUPPLIED ARE OF AN INFERIOR QUALITY OR DO NOT CONFORM TO THE SPECIFICATIONS OF THE BID AND CONTRACT HEREIN.</p> <p>OPEN MARKET CLAUSE: THE DIRECTOR OF PURCHASING MAY AUTHORIZE A SPENDING UNIT TO PURCHASE ON THE OPEN MARKET, WITHOUT THE FILING OF A REQUISITION OR COST ESTIMATE, ITEMS SPECIFIED ON THIS CONTRACT FOR IMMEDIATE DELIVERY IN EMERGENCIES DUE TO UNFORESEEN CAUSES (INCLUDING BUT NOT LIMITED TO DELAYS IN TRANSPORTATION OR AN UNANTICIPATED INCREASE IN THE VOLUME OF WORK.)</p> <p>QUANTITIES: QUANTITIES LISTED IN THE REQUISITION ARE APPROXIMATIONS ONLY, BASED ON ESTIMATES SUPPLIED BY THE STATE SPENDING UNIT. IT IS UNDERSTOOD AND AGREED THAT THE CONTRACT SHALL COVER THE QUANTITIES ACTUALLY ORDERED FOR DELIVERY DURING THE TERM OF THE CONTRACT, WHETHER MORE OR LESS THAN THE QUANTITIES SHOWN.</p> <p>BANKRUPTCY: IN THE EVENT THE VENDOR/CONTRACTOR FILES FOR BANKRUPTCY PROTECTION, THIS CONTRACT IS AUTOMATICALLY NULL AND VOID, AND IS TERMINATED WITHOUT FURTHER ORDER.</p> <p>THE TERMS AND CONDITIONS CONTAINED IN THIS CONTRACT</p>						

SEE REVERSE SIDE FOR TERMS AND CONDITIONS

SIGNATURE	TELEPHONE	DATE
TITLE	FEIN	ADDRESS CHANGES TO BE NOTED ABOVE

WHEN RESPONDING TO RFQ, INSERT NAME AND ADDRESS IN SPACE ABOVE LABELED 'VENDOR'



State of West Virginia
 Department of Administration
 Purchasing Division
 2019 Washington Street East
 Post Office Box 50130
 Charleston, WV 25305-0130

Request for Quotation

RFO NUMBER
PTR07004

PAGE
3

ADDRESS CORRESPONDENCE TO ATTENTION OF:
**KRISTA FERRELL
 304-558-2596**

RFQ COPY
 TYPE NAME/ADDRESS HERE

VENDOR

SHIP TO

**DIVISION OF PUBLIC TRANSIT
 BUILDING 5, ROOM 830
 1900 KANAWHA BOULEVARD, EAST
 CHARLESTON, WV
 25305-0432 304-558-0428**

DATE PRINTED 08/07/2006	TERMS OF SALE	SHIP VIA	F.O.B.	FREIGHT TERMS
-----------------------------------	---------------	----------	--------	---------------

BID OPENING DATE: **08/31/2006** BID OPENING TIME **01:30PM**

LINE	QUANTITY	UOP	CAT. NO.	ITEM NUMBER	UNIT PRICE	AMOUNT
<p>SHALL SUPERSEDE ANY AND ALL SUBSEQUENT TERMS AND CONDITIONS WHICH MAY APPEAR ON ANY ATTACHED PRINTED DOCUMENTS SUCH AS PRICE LISTS, ORDER FORMS, SALES AGREEMENTS OR MAINTENANCE AGREEMENTS, INCLUDING ANY ELECTRONIC MEDIUM SUCH AS CD-ROM.</p> <p>REV. 04/11/2001</p> <p>EXHIBIT 6</p> <p>PRICE ADJUSTMENT PROVISION: THE STATE OF WEST VIRGINIA WILL CONSIDER BIDS THAT CONTAIN PROVISIONS FOR PRICE ADJUSTMENTS PRIOR TO THE ORIGINAL EXPIRATION OF THE CONTRACT, PROVIDED THAT SUCH PRICE ADJUSTMENT COVERS BOTH UPWARD AND DOWNWARD MOVEMENT OF THE COMMODITY PRICE, AND THAT ADJUSTMENT I BASED ON THE "PASS THROUGH" INCREASE OR DECREASE OF RAW MATERIALS AND/OR LABOR, WHICH MAKE UP ALL OR A SUBSTANTIAL PART OF A PRODUCT. ADJUSTMENTS ARE TO BE BASED UPON AN ACTUAL DOLLAR FIGURE, NOT A PERCENTAGE. ALL PRICE ADJUSTMENT REQUESTS MUST BE SUBSTANTIATED IN A MANNER ACCEPTABLE TO THE DIRECTOR PURCHASING, E.G. GOVERNMENTAL BENCH MARKS, GENERAL MARKET INCREASE, PUBLISHED PRICE LISTS. SUCH REQUESTS FOR AND INCREASE SHOULD BE RECEIVED IN WRITING BY THE DIRECTOR OF PURCHASING AT LEAST 30 DAYS IN ADVANCE OF THE EFFECTIVE DATE OF THE INCREASE. ANY TIME THE VENDOR REQUESTS A PRICE ADJUSTMENT, THE PURCHASING DIVISION MAY EITHER ACCEPT THE PRICE ADJUSTMENT AND AMEND THE CONTRACT ACCORDINGLY OR REJECT THE ADJUSTMENT IN ITS ENTIRETY AND CANCEL THE CONTRACT.</p> <p>PREFERRED TERMS:</p>						

SEE REVERSE SIDE FOR TERMS AND CONDITIONS

SIGNATURE	TELEPHONE	DATE
-----------	-----------	------

TLE	FEIN	ADDRESS CHANGES TO BE NOTED ABOVE
-----	------	-----------------------------------

WHEN RESPONDING TO RFQ, INSERT NAME AND ADDRESS IN SPACE ABOVE LABELED 'VENDOR'



State of West Virginia
 Department of Administration
 Purchasing Division
 2019 Washington Street East
 Post Office Box 50130
 Charleston, WV 25305-0130

Request for Quotation

RFQ NUMBER
PTR07004

PAGE
4

ADDRESS CORRESPONDENCE TO ATTENTION OF:
KRISTA FERRELL 304-558-2596

RFQ COPY
 TYPE NAME/ADDRESS HERE

VENDOR

SHIP TO

DIVISION OF PUBLIC TRANSIT
 BUILDING 5, ROOM 830
 1900 KANAWHA BOULEVARD, EAST
 CHARLESTON, WV
 25305-0432 304-558-0428

DATE PRINTED	TERMS OF SALE	SHIP VIA	F.O.B.	FREIGHT TERMS
08/07/2006				

BID OPENING DATE: 08/31/2006 BID OPENING TIME 01:30PM

LINE	QUANTITY	UOP	CAT. NO.	ITEM NUMBER	UNIT PRICE	AMOUNT
<p>IT IS PREFERRED THAT THE PRICES ON THIS CONTRACT ARE FIRM FOR LIFE OF THE CONTRACT, AS INDICATED IN THE LIFE OF CONTRACT CLAUSE CONTAINED HEREIN, NOT TO EXCEED ONE (1) YEAR. PRICE INCREASES WILL BE CONSIDERED AT THE TIME OF RENEWAL ONLY.</p> <p>THE MODEL/BRAND/SPECIFICATIONS NAMED HEREIN ESTABLISH THE ACCEPTABLE LEVEL OF QUALITY ONLY AND ARE NOT INTENDED TO REFLECT A PREFERENCE OR FAVOR ANY PARTICULAR BRAND OR VENDOR. VENDORS WHO ARE BIDDING ALTERNATES SHOULD SO STATE AND INCLUDE PERTINENT LITERATURE AND SPECIFICATIONS. FAILURE TO PROVIDE INFORMATION FOR ANY ALTERNATES MAY BE GROUNDS FOR REJECTION OF THE BID. THE STATE RESERVES THE RIGHT TO WAIVE MINOR IRREGULARITIES IN BIDS OR SPECIFICATIONS IN ACCORDANCE WITH SECTION 148-1-4(F) OF THE WEST VIRGINIA LEGISLATIVE RULES AND REGULATIONS.</p> <p>VENDOR PREFERENCE CERTIFICATE</p> <p>CERTIFICATION AND APPLICATION* IS HEREBY MADE FOR PREFERENCE IN ACCORDANCE WITH WEST VIRGINIA CODE, 5A-3-37 (DOES NOT APPLY TO CONSTRUCTION CONTRACTS).</p> <p>A. APPLICATION IS MADE FOR 2.5% PREFERENCE FOR THE REASON CHECKED:</p> <p>() BIDDER IS AN INDIVIDUAL RESIDENT VENDOR AND HAS RESIDED CONTINUOUSLY IN WEST VIRGINIA FOR FOUR (4) YEARS IMMEDIATELY PRECEDING THE DATE OF THIS CERTIFICATION; OR</p> <p>() BIDDER IS A PARTNERSHIP, ASSOCIATION OR CORPORATION RESIDENT VENDOR AND HAS MAINTAINED ITS HEAD-</p>						

SIGNATURE				TELEPHONE		DATE
TITLE		FEIN		ADDRESS CHANGES TO BE NOTED ABOVE		

WHEN RESPONDING TO RFQ, INSERT NAME AND ADDRESS IN SPACE ABOVE LABELED 'VENDOR'



State of West Virginia
 Department of Administration
 Purchasing Division
 2019 Washington Street East
 Post Office Box 50130
 Charleston, WV 25305-0130

Request for Quotation

RFQ NUMBER
PTR07004

PAGE
5

ADDRESS CORRESPONDENCE TO ATTENTION OF:
**KRISTA FERRELL
 304-558-2596**

VENDOR

RFQ COPY
 TYPE NAME/ADDRESS HERE

SHIP TO

DIVISION OF PUBLIC TRANSIT
 BUILDING 5, ROOM 830
 1900 KANAWHA BOULEVARD, EAST
 CHARLESTON, WV
 25305-0432 304-558-0428

DATE PRINTED 08/07/2006	TERMS OF SALE	SHIP VIA	F.O.B.	FREIGHT TERMS
-----------------------------------	---------------	----------	--------	---------------

BID OPENING DATE: **08/31/2006** BID OPENING TIME **01:30PM**

LINE	QUANTITY	UOP	CAT. NO.	ITEM NUMBER	UNIT PRICE	AMOUNT
	<p>QUARTERS OR PRINCIPAL PLACE OF BUSINESS CONTINUOUSLY IN WEST VIRGINIA FOR FOUR (4) YEARS IMMEDIATELY PRECEDING THE DATE OF THIS CERTIFICATION; OR 80% OF THE OWNERSHIP INTEREST OF BIDDER IS HELD BY ANOTHER INDIVIDUAL, PARTNERSHIP, ASSOCIATION OR CORPORATION RESIDENT VENDOR WHO HAS MAINTAINED ITS HEADQUARTERS OR PRINCIPAL PLACE OF BUSINESS CONTINUOUSLY IN WEST VIRGINIA FOR FOUR (4) YEARS IMMEDIATELY PRECEDING THE DATE OF THIS CERTIFICATION; OR</p> <p>() BIDDER IS A CORPORATION NONRESIDENT VENDOR WHICH HAS AN AFFILIATE OR SUBSIDIARY WHICH EMPLOYS A MINIMUM OF ONE HUNDRED STATE RESIDENTS AND WHICH HAS MAINTAINED ITS HEADQUARTERS OR PRINCIPAL PLACE OF BUSINESS WITHIN WEST VIRGINIA CONTINUOUSLY FOR THE FOUR (4) YEARS IMMEDIATELY PRECEDING THE DATE OF THIS CERTIFICATION.</p> <p>B. APPLICATION IS MADE FOR 2.5% PREFERENCE FOR THE REASON CHECKED:</p> <p>() BIDDER IS A RESIDENT VENDOR WHO CERTIFIES THAT, DURING THE LIFE OF THE CONTRACT, ON AVERAGE AT LEAST 75% OF THE EMPLOYEES WORKING ON THE PROJECT BEING BID ARE RESIDENTS OF WEST VIRGINIA WHO HAVE RESIDED IN THE STATE CONTINUOUSLY FOR THE TWO YEARS IMMEDIATELY PRECEDING SUBMISSION OF THIS BID;</p> <p>OR</p> <p>() BIDDER IS A NONRESIDENT VENDOR EMPLOYING A MINIMUM OF ONE HUNDRED STATE RESIDENTS OR IS A NONRESIDENT VENDOR WITH AN AFFILIATE OR SUBSIDIARY WHICH MAINTAINS ITS HEADQUARTERS OR PRINCIPAL PLACE OF BUSINESS WITHIN WEST VIRGINIA EMPLOYING A MINIMUM OF ONE HUNDRED STATE RESIDENTS WHO CERTIFIES THAT, DURING THE LIFE OF THE CONTRACT, ON AVERAGE AT LEAST 75% OF THE EMPLOYEES OR BIDDERS' AFFILIATE'S OR</p>					

SEE REVERSE SIDE FOR TERMS AND CONDITIONS

SIGNATURE	TELEPHONE	DATE
-----------	-----------	------

TITLE	FEIN	ADDRESS CHANGES TO BE NOTED ABOVE
-------	------	-----------------------------------

WHEN RESPONDING TO RFQ, INSERT NAME AND ADDRESS IN SPACE ABOVE LABELED 'VENDOR'



State of West Virginia
 Department of Administration
 Purchasing Division
 2019 Washington Street East
 Post Office Box 50130
 Charleston, WV 25305-0130

Request for Quotation

RFQ NUMBER
PTR07004

PAGE
6

ADDRESS CORRESPONDENCE TO ATTENTION OF:
**KRISTA FERRELL
 304-558-2596**

VENDOR

RFQ COPY
 TYPE NAME/ADDRESS HERE

SHIP TO

DIVISION OF PUBLIC TRANSIT
 BUILDING 5, ROOM 830
 1900 KANAWHA BOULEVARD, EAST
 CHARLESTON, WV
 25305-0432 304-558-0428

DATE PRINTED 08/07/2006	TERMS OF SALE	SHIP VIA	F.O.B.	FREIGHT TERMS
BID OPENING DATE: 08/31/2006 BID OPENING TIME 01:30PM				

LINE	QUANTITY	UOP	CAT NO.	ITEM NUMBER	UNIT PRICE	AMOUNT
<p>SUBSIDIARY'S EMPLOYEES ARE RESIDENTS OF WEST VIRGINIA WHO HAVE RESIDED IN THE STATE CONTINUOUSLY FOR THE TWO YEARS IMMEDIATELY PRECEDING SUBMISSION OF THIS BID.</p> <p>BIDDER UNDERSTANDS IF THE SECRETARY OF TAX & REVENUE DETERMINES THAT A BIDDER RECEIVING PREFERENCE HAS FAILED TO CONTINUE TO MEET THE REQUIREMENTS FOR SUCH PREFERENCE, THE SECRETARY MAY ORDER THE DIRECTOR OF PURCHASING TO: (A) RESCIND THE CONTRACT OR PURCHASE ORDER ISSUED; OR (B) ASSESS A PENALTY AGAINST SUCH BIDDER IN AN AMOUNT NOT TO EXCEED 5% OF THE BID AMOUNT AND THAT SUCH PENALTY WILL BE PAID TO THE CONTRACTING AGENCY OR DEDUCTED FROM ANY UNPAID BALANCE ON THE CONTRACT OR PURCHASE ORDER.</p> <p>BY SUBMISSION OF THIS CERTIFICATE, BIDDER AGREES TO DISCLOSE ANY REASONABLY REQUESTED INFORMATION TO THE PURCHASING DIVISION AND AUTHORIZES THE DEPARTMENT OF TAX AND REVENUE TO DISCLOSE TO THE DIRECTOR OF PURCHASING APPROPRIATE INFORMATION VERIFYING THAT BIDDER HAS PAID THE REQUIRED BUSINESS TAXES, PROVIDED THAT SUCH INFORMATION DOES NOT CONTAIN THE AMOUNTS OF TAXES PAID NOR ANY OTHER INFORMATION DEEMED BY THE TAX COMMISSIONER TO BE CONFIDENTIAL.</p> <p>UNDER PENALTY OF LAW FOR FALSE SWEARING (WEST VIRGINIA CODE 61-5-3), BIDDER HEREBY CERTIFIES THAT THIS CERTIFICATE IS TRUE AND ACCURATE IN ALL RESPECTS; AND THAT IF A CONTRACT IS ISSUED TO BIDDER AND IF ANYTHING CONTAINED WITHIN THIS CERTIFICATE CHANGES DURING THE TERM OF THE CONTRACT, BIDDER WILL NOTIFY THE PURCHASING DIVISION IN WRITING IMMEDIATELY.</p> <p style="text-align: right;">BIDDER: -----</p>						

SEE REVERSE SIDE FOR TERMS AND CONDITIONS

SIGNATURE	TELEPHONE	DATE
TITLE	FEIN	ADDRESS CHANGES TO BE NOTED ABOVE

WHEN RESPONDING TO RFQ, INSERT NAME AND ADDRESS IN SPACE ABOVE LABELED 'VENDOR'



State of West Virginia
 Department of Administration
 Purchasing Division
 2019 Washington Street East
 Post Office Box 50130
 Charleston, WV 25305-0130

Request for Quotation

RFQ NUMBER
PTR07004

PAGE
7

ADDRESS CORRESPONDENCE TO ATTENTION OF:
KRISTA FERRELL 304-558-2596

VENDOR

RFQ COPY
 TYPE NAME/ADDRESS HERE

SHIP TO

DIVISION OF PUBLIC TRANSIT
 BUILDING 5, ROOM 830
 1900 KANAWHA BOULEVARD, EAST
 CHARLESTON, WV
 25305-0432 304-558-0428

DATE PRINTED	TERMS OF SALE	SHIP VIA	F.O.B.	FREIGHT TERMS
08/07/2006				

BID OPENING DATE: 08/31/2006 BID OPENING TIME 01:30PM

LINE	QUANTITY	UOP	CAT. NO.	ITEM NUMBER	UNIT PRICE	AMOUNT
<p>DATE: -----</p> <p>SIGNED: -----</p> <p>TITLE: -----</p> <p>* CHECK ANY COMBINATION OF PREFERENCE CONSIDERATION(S) IN EITHER "A" OR "B", OR BOTH "A" AND "B" WHICH YOU ARE ENTITLED TO RECEIVE. YOU MAY REQUEST UP TO THE MAXIMUM 5% PREFERENCE FOR BOTH "A" AND "B". (REV. 12/00)</p> <p>NOTICE</p> <p>A SIGNED BID MUST BE SUBMITTED TO:</p> <p>DEPARTMENT OF ADMINISTRATION PURCHASING DIVISION BUILDING 15 2019 WASHINGTON STREET, EAST CHARLESTON, WV 25305-0130</p> <p>THE BID SHOULD CONTAIN THIS INFORMATION ON THE FACE OF THE ENVELOPE OR THE BID MAY NOT BE CONSIDERED:</p> <p>SEALED BID</p> <p>BUYER: 21</p>						

SEE REVERSE SIDE FOR TERMS AND CONDITIONS

SIGNATURE	TELEPHONE	DATE
-----------	-----------	------

TITLE	FEIN	ADDRESS CHANGES TO BE NOTED ABOVE
-------	------	-----------------------------------

WHEN RESPONDING TO RFQ, INSERT NAME AND ADDRESS IN SPACE ABOVE LABELED 'VENDOR'



State of West Virginia
 Department of Administration
 Purchasing Division
 2019 Washington Street East
 Post Office Box 50130
 Charleston, WV 25305-0130

Request for Quotation

RFQ NUMBER
PTR07004

PAGE
8

ADDRESS CORRESPONDENCE TO ATTENTION OF:
**KRISTA FERRELL
 304-558-2596**

VENDOR

RFQ COPY
 TYPE NAME/ADDRESS HERE

SHIP TO

DIVISION OF PUBLIC TRANSIT
 BUILDING 5, ROOM 830
 1900 KANAWHA BOULEVARD, EAST
 CHARLESTON, WV
 25305-0432 304-558-0428

DATE PRINTED 08/07/2006	TERMS OF SALE	SHIP VIA	F.O.B.	FREIGHT TERMS
-----------------------------------	---------------	----------	--------	---------------

BID OPENING DATE: **08/31/2006** BID OPENING TIME **01:30PM**

LINE	QUANTITY	UOP	CAT. NO.	ITEM NUMBER	UNIT PRICE	AMOUNT
				RFQ. NO. : PTR07004		
				BID OPENING DATE: 08/31/2006		
				BID OPENING TIME: 1:30 PM		
PLEASE PROVIDE A FAX NUMBER IN CASE IT IS NECESSARY TO CONTACT YOU REGARDING YOUR BID:						

CONTACT PERSON (PLEASE PRINT CLEARLY):						

***** THIS IS THE END OF RFQ PTR07004 ***** TOTAL:						

SEE REVERSE SIDE FOR TERMS AND CONDITIONS

SIGNATURE	TELEPHONE	DATE
TITLE	FEIN	ADDRESS CHANGES TO BE NOTED ABOVE

WHEN RESPONDING TO RFQ, INSERT NAME AND ADDRESS IN SPACE ABOVE LABELED 'VENDOR'

OPTION SHEET
 For
 PTR07004

OPTIONS	Estimated number of units	Extended Price
OPTION 1: PERFORATED STEEL SIDE PANELS \$ _____	100	\$ _____
OPTION 2: ALUMINUM SIDE PANELS \$ _____	100	\$ _____
OPTION 3: SHELTER BENCH WITH ANTI-VAGRANT BARS \$ _____	100	\$ _____
OPTION 4: SOLAR LIGHTING SYSTEM \$ <u>1670.00</u>	100	\$ <u>167,000.00</u>
OPTION 5: SOLAR POWERED TRANSIT STOP \$ _____	100	\$ _____
TOTAL FOR BID EVALUATION:		\$ <u>167,000.00 US</u>

Note: Unit pricing above must be firm and will be used for when awarding the contract for these items.

[Signature]
 AUG 29 2006
 015

BID FORM 1
BUY AMERICA CERTIFICATION

Bidder or offerer to complete correct certification.

** TO BE CONFIRMED*

Certificate of Compliance with Section 165(a)

The bidder or offerer hereby certifies that it will comply with the requirements of section 165(a) of the Surface Transportation Act of 1982, as amended, and the applicable regulations in 49 CFR part 661.

Date

Authorized Signature

Company Name

Name

Title

Certificate for Non-Compliance with Section 165(a)

The bidder or offerer hereby certifies that it cannot comply with the requirements of section 165(a) of the Surface Transportation Assistance Act of 1982, as amended, but it may qualify for an exception to the requirement pursuant to section 165(b)(2) or (b)(4) of the Surface Transportation Act of 1982, as amended, and the regulations in 49 CFR 661.7.

Date

Authorized Signature

Company Name

Name

Title

BID FORM 2

VENDOR'S CERTIFICATION OF UNDERSTANDING AND ACCEPTANCE

The Contractor hereby certifies that all Technical Specifications and Contract Terms and Conditions have been carefully reviewed, are fully understood and shall be adhered to in performance and completion of any contract resulting from this bid.

Aug. 29 2006
Date

[Signature]
Authorized Signature

SALES DIRECTOR
Title

SOLAR SIGNALS
Company Name

SPECIFICATION COMPLIANCE

NOTE: Please check if what is offered is in exact compliance with specifications. Any discrepancies must be addressed. Exact dimensions and/or descriptions must be provided. This information should be submitted via attachment.

- Bid proposal submitted meets and/or exceeds all specification requirements.
- Bid proposal submitted contains deviations from specification requirements. Detailed descriptions of these deviations have been provided with this bid proposal.

Spending Unit: Division of Public Transit
Department of Transportation

BID FORM 3

CERTIFICATION OF RESTRICTIONS ON LOBBYING

The undersigned (Vendor, Contractor) certifies, to the best of his or her knowledge and belief, that:

1. No Federal appropriated funds have been paid or will be paid, by or on behalf of the undersigned, to any person for influencing or attempting to influence an officer or employee of an agency, a Member of Congress, an officer or employee of Congress, or an employee of a Member of Congress in connection with the awarding of any Federal contract, the making of any Federal grant, the making of any Federal loan, the entering into of any cooperative agreement, and the extension, continuation, renewal, amendment, or modification of any Federal contract, grant, loan, or cooperative agreement.
2. If any funds other than Federal appropriated funds have been paid or will be paid to any person for making lobbying contacts to an officer or employee of any agency, a Member of Congress, an officer or employee of Congress, or an employee of a Member of Congress in connection with this Federal contract, grant, loan, or cooperative agreement, the undersigned shall complete and submit Standard Form-LLL, "Disclosure Form to Report Lobbying," in accordance with its instructions. [as amended by "Government Wide Guidance for New Restrictions on Lobbying," 61 Fed. Reg. 1413 (1/19/96). Note: Language in paragraph (2) herein has been modified in accordance with Section 10 of the Lobbying Disclosure Act of 1995 (P.L. 104-65, to be codified at 2 U.S.C. 1601, et seq.)]
3. The undersigned shall require that the language of this certification be included in the award documents for all subawards at all tiers (including subcontracts, subgrants, and contracts under grants, loans, and cooperative agreements) and that all subrecipients shall certify and disclose accordingly.

This certification is a material representation of fact upon which reliance was placed when this transaction was made or entered into. Submission of this certification is a prerequisite for making or entering into this transaction imposed by 31 U.S.C. § 1352 (as amended by the Lobbying Disclosure Act of 1995). Any person who fails to file the required certification shall be subject to a civil penalty of not less than \$10,000 and not more than \$100,000 for each such failure. [Note: Pursuant to 31 U.S.C. § 1352(c)(1)-(2)(A), any person who makes a prohibited expenditure or fails to file or amend a required certification or disclosure form shall be subject to a civil penalty of not less than \$10,000 and not more than \$100,000 for each such expenditure or failure.]

The Vendor, SOLAR SIGNALS, certifies or affirms the truthfulness and accuracy of each statement of its certification and disclosure, if any. In addition, the Vendor understands and agrees that the provisions of 31 U.S.C. § 3801, et seq., apply to this certification and disclosure, if any.

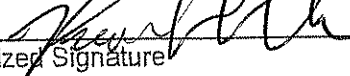
Date Aug 29 2006 Authorized Signature 

Title SALES DIRECTOR

A F F I D A V I T024**West Virginia Code §5A-3-10a states:**

No contract or renewal of any contract may be awarded by the state or any of its political subdivisions to any vendor or prospective vendor when the vendor or prospective vendor or a related party to the vendor or prospective vendor is a debtor and the debt owned is an amount greater than one thousand dollars in the aggregate.

DEFINITIONS:

"Debt" means any assessment, premium, penalty, fine, tax or other amount of money owed to the state or any of its political subdivisions because of a judgment, fine, permit violation, license assessment, defaulted workers' compensation premium, penalty or other assessment presently delinquent or due and required to be paid to the state or any of its political subdivisions, including any interest or additional penalties accrued thereon.

"Debtor" means any individual, corporation, partnership, association, limited liability company or any other form or business association owing a debt to the state or any of its political subdivisions.

"Political subdivision" means any county commission; municipality; county board of education; any instrumentality established by a county or municipality; any separate corporation or instrumentality established by one or more counties or municipalities, as permitted by law; or any public body charged by law with the performance of a government function or whose jurisdiction is coextensive with one or more counties or municipalities.

"Related party" means a party, whether an individual, corporation, partnership, association, limited liability company or any other form or business association or other entity whatsoever, related to any vendor by blood, marriage, ownership or contract through which the party has a relationship of ownership or other interest with the vendor so that the party will actually or by effect receive or control a portion of the benefit, profit or other consideration from performance of a vendor contract with the party receiving an amount that meets or exceeds five percent of the total contract amount.

EXCEPTION:

The prohibition of this section does not apply where a vendor has contested any tax administered pursuant to chapter eleven of this code, workers' compensation premium, permit fee or environmental fee or assessment and the matter has not become final or where the vendor has entered into a payment plan or agreement and the vendor is not in default of any of the provisions of such plan or agreement.

LICENSING:

The vendor must be licensed in accordance with any and all state requirements to do business with the state of West Virginia.

CONFIDENTIALITY:

The vendor agrees that he or she will not disclose to anyone, directly or indirectly, any such personally identifiable information or other confidential information gained from the agency, unless the individual who is the subject of the information consents to the disclosure in writing or the disclosure is made pursuant to the agency's policies, procedures and rules. Vendors should visit www.state.wv.us/admin/purchase/privacy for the Notice of Agency Confidentiality Policies.

Under penalty of law for false swearing (West Virginia Code, §61-5-3), it is hereby certified that the vendor acknowledges the information in this said affidavit and are in compliance with the requirements as stated.

Vendor's Name: SONAR SIGNALS

Authorized Signature: [Signature] Date: Aug 29 2016

SOLAR SIGNALS

August 29, 2006

Quotation# WVA010806

RFQ# PTR07004

BUS SHELTER LIGHTING KITS (OPTION 4)

Systems would consist of the following;

- US64 solar panel (vandal resistant)w/roof mount. qty.1 per system)
- 100 Ahr deep-cycle battery (10 days autonomy @ 75 deg.F w/ 14 hr. runtime per day)
qty.1 per system.
- Programmable solar charge / light controller. (qty.1 per system)
- Epoxy coated lockable steel battery/control enclosure, NEMA rated. (qty.1 per system)
- High efficiency, vandal resistant, long life (approx. 10+ yr.s) White LED light fixtures. (qty.2 per system).

Regards, Ray Lalonde (Dir. Sales)

SOLAR SIGNALS

SOLAR SIGNALS www.solarsignals.com

MTL. Tel; (514) 695-1546 Fx; (514) 630-8938

Head office/ Siege social

556 O'Connor Dr.

Kingston, ON. K7P 1N3

CANADA

FRAMED SOLAR MODULES US-SERIES

- Power Rating For 5W - 64W
- Clear Anodized Aluminum Frame
- Assemble To Meet Virtually Any Load
- Virtually Unbreakable (No Glass)
- Shadow & High Heat Tolerant
- Delivers Up To 20% More Real Energy

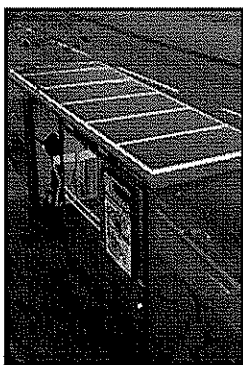
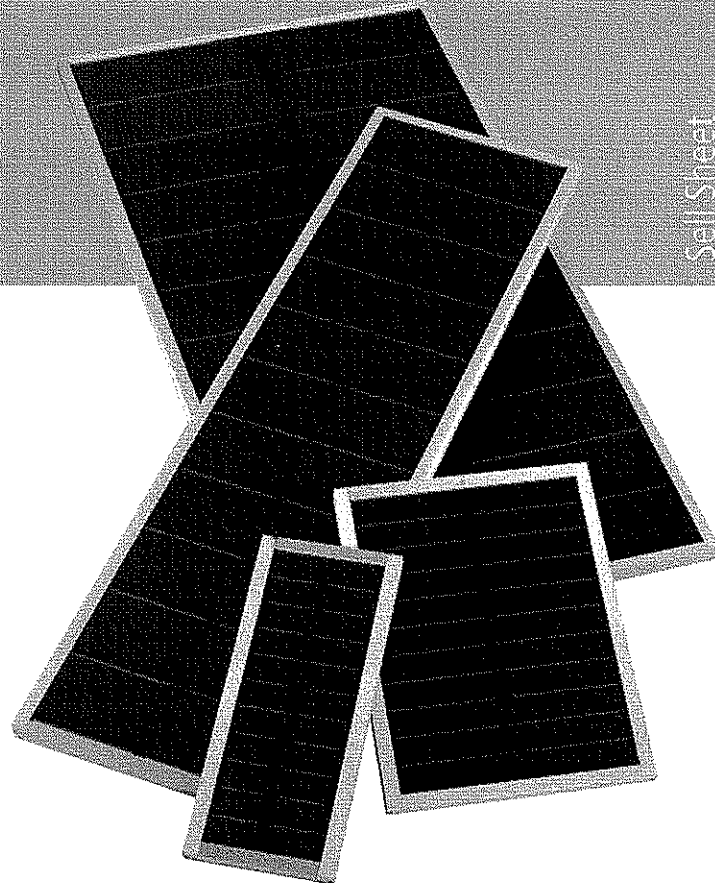

Photo Courtesy of Solar Century (UK)

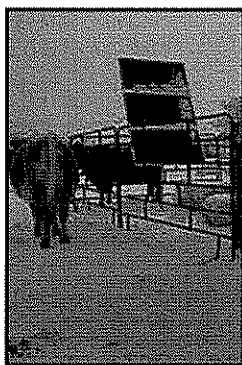
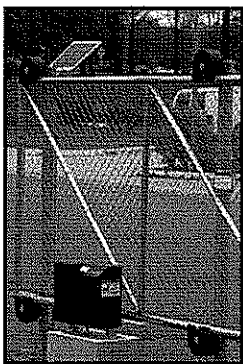

Photo Courtesy of Keim Solar



Gate Operator Photo Courtesy of GTO Inc.



UNI-SOLAR® framed modules are mounted on permanent, fixed position module racks that can be adjusted for optimum tilt, wind resistance and orientation to sunlight. These glass-free vandal resistance modules can be utilized in a wide variety of applications from fence charging to telecommunications.

The larger framed panels are often used as building blocks in photovoltaic arrays, which can be assembled to meet virtually any load from less than 100 watts to multi-megawatts.

Why Do UNI-SOLAR® Products Outperform Others?

All solar panels are rated in terms of peak power output (watts). Outdoors, under normally higher operating temperatures, solar panel performance changes, depending on temperature, solar spectrum (light color) and related effects. UNI-SOLAR® products are less affected by temperature than monocrystalline or polycrystalline solar technology products. The result is up to 20% more delivered energy.**

** Source Solfest, "Module Shoot Out"

Applications

- Battery Charging
- Off-Grid Solar Home Systems
- Water Pumping or Desalination Systems
- Telecommunications
- Gate Opening or Fence Charging
- Bus or Animal Shelters



MORE AMP-HRS



NO-GLASS



DURABLE



SHADOW TOLERANT



HIGH-TEMP PERFORMANCE

SOLAR SIGNALS

Bus Shelter Light Options

Bus shelter light brick

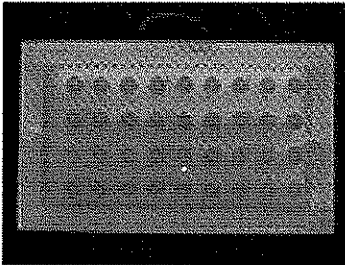

36 White LED (2per shelter) Expected life 10+ yr.s

or

Bus shelter light.

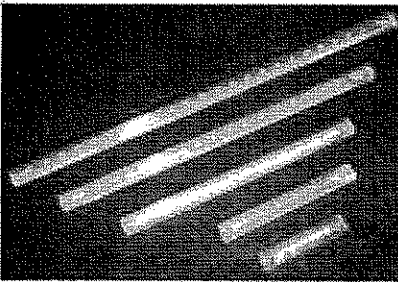

36 White LED (2per shelter) Expected life 10+ yr.s

or

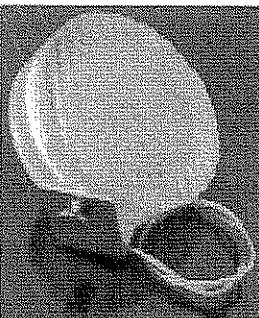

36 White LED (2per shelter) Expected life 10+ yr.s

SOLAR SIGNALS

MTL. Tel; (514) 695-1546 Fx; (514) 630-8938

556 O'Connor Dr. Kingston, ON. K7P 1N3

CANADA



Morningstar's advanced **SunLight** solar lighting controller combines the **SunSaver** design with a microcontroller for automatic lighting control functions.

This technology provides:

- Proven Reliability
- Precise Lighting Control
- PWM Battery Charging

Operation:

- Rotary digital switch to select among 10 lighting options (see back)
- Test button flashes red LED to confirm correct rotary switch selection
- Test button turns lights on for 5 minutes (in LVD limited to 3 times)
- LVD overrides lighting timer
- Sunrise overrides lighting timer
- Timer accuracy is within 2 seconds

Four Versions Available:

- 12 Volt: 10 and 20 amp ratings
- 24 Volt: 10 and 20 amp ratings

Features:

- Microcontroller digital accuracy
- Fully automatic operation
- Ten field adjustable lighting control options
- Special on/off/on functions
- Manual test capability
- LVD override protection
- Detects day and night using the PV array
- Suitable for all 12/24 Vdc lamps
- Sealed/Flooded battery select
- Temperature compensation
- Parallel with a SunSaver for 40 amps solar
- Includes SunSaver battery charging circuit

Lighting Control Options

	SUNSET	NIGHT
• OFF		
• 2 HOURS ON		
• 4 HOURS ON		
• 6 HOURS ON		
• 8 HOURS ON		
• 10 HOURS ON		
• 3 / OFF / 1		
• 4 / OFF / 2		
• 6 / OFF / 2		
• DUSK-to-DAWN		

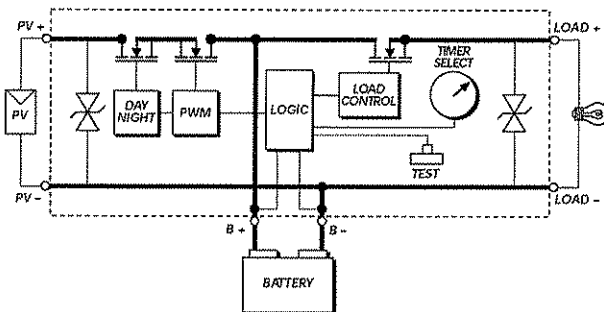
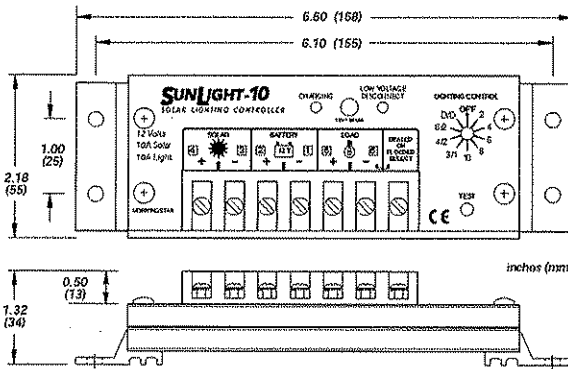

Mechanical

Wire size #10
Anodized aluminum
Marine rated 1/2" thick
Epoxy encapsulated
Weight is 9 oz

Electrical Specifications

Rated Solar Input: 10W
Rated Load: 10W
25% Current Limit
Regulation Voltage: 12V
Sealed Battery Compatible
Flooded Battery Compatible
Load Disconnect
LVD Reconnect
Temp. Comp. (Optional)
Self-consumption: 0.5W
Operating Temperature: -40°C to 85°C