



State of West Virginia  
 Department of Administration  
 Purchasing Division  
 2019 Washington Street East  
 Post Office Box 50130  
 Charleston, WV 25305-0130

# Request for Quotation

RFQ NUMBER  
**LSH70145**

PAGE  
**1**

ADDRESS CORRESPONDENCE TO ATTENTION OF  
**ROBERTA WAGNER**  
**304-558-0067**

VENDOR

RFQ COPY  
 TYPE NAME/ADDRESS HERE

**DIRECT SUPPLY INC.**  
**6767 N. INDUSTRIAL RD.**  
**MILWAUKEE, WI 53223**

SHIP TO

**HEALTH AND HUMAN RESOURCES**  
**LAKIN HOSPITAL**

**1 BATEMAN CIRCLE**  
**LAKIN, WV**  
**25287**

**304-675-0860**

DATE PRINTED	TERMS OF SALE	SHIP VIA	F.O.B.	FREIGHT TERMS
<b>04/30/2007</b>				

BID OPENING DATE: **05/31/2007** BID OPENING TIME **01:30PM**

LINE	QUANTITY	UOP	CAT. NO.	ITEM NUMBER	UNIT PRICE	AMOUNT
0001	120	EA		370-99	\$153.39	\$15,339.00
TO PROVIDE DINNERWARE AND DISPENSING EQUIPMENT FOR LAKIN HOSPITAL. <b>TURBURY INSULATED DOME DINNERWARE</b> SIZED TO FIT 9" PLATE. DOME MUST BE POLYPROPYLENE, DOUBLE WALL CONSTRUCTION WITH OZONE-SAFE URETHANE FOAM INSULATION. DOME MUST BE ONE PIECE CONSTRUCTION. NOTE: ALL ITEMS ARE DINEX INTERNATIONAL OR EQUAL. BRAND NAME IS USED TO IDENTIFY A QUALITY LEVEL. ALL ITEMS ARE TO BE USED IN A HOSPITAL ENVIRONMENT.						
0002	120	EA		370-99	\$113.91	\$13,669.20
<b>INSULATED BASE, SIZED TO</b> FIT A 9" PLATE. BASE MUST BE SINGLE-WALL CONSTRUCTION WITH WAX BASE UNDERLINER.						

SEE REVERSE SIDE FOR TERMS AND CONDITIONS

SIGNATURE 	TELEPHONE <b>806-808-5996</b>	DATE <b>5/14/07</b>
TITLE <b>SENIOR VP</b>	FEIN <b>39-1519806</b>	ADDRESS CHANGES TO BE NOTED ABOVE

WHEN RESPONDING TO RFQ, INSERT NAME AND ADDRESS IN SPACE ABOVE LABELED 'VENDOR'

**GENERAL TERMS & CONDITIONS  
REQUEST FOR QUOTATION (RFQ) AND REQUEST FOR PROPOSAL (RFP)**

1. Awards will be made in the best interest of the State of West Virginia.
2. The State may accept or reject in part, or in whole, any bid.
3. All quotations are governed by the *West Virginia Code* and the *Legislative Rules* of the Purchasing Division.
4. Prior to any award, the apparent successful vendor must be properly registered with the Purchasing Division and have paid the required \$125.00 registration fee.
5. All services performed or goods delivered under State Purchase Orders/Contracts are to be continued for the term of the Purchase Order/Contract, contingent upon funds being appropriated by the Legislature or otherwise being made available. In the event funds are not appropriated or otherwise available for these services or goods, this Purchase Order/Contract becomes void and of no effect after June 30.
6. Payment may only be made after the delivery and acceptance of goods or services.
7. Interest may be paid for late payment in accordance with the *West Virginia Code*.
8. Vendor preference will be granted upon written request in accordance with the *West Virginia Code*.
9. The State of West Virginia is exempt from federal and state taxes and will not pay or reimburse such taxes.
10. The Director of Purchasing may cancel any Purchase Order/Contract upon 30 days written notice to the seller.
11. The laws of the State of West Virginia and the *Legislative Rules* of the Purchasing Division shall govern all rights and duties under the Contract, including without limitation the validity of this Purchase Order/Contract.
12. Any reference to automatic renewal is hereby deleted. The Contract may be renewed only upon mutual written agreement of the parties.
13. **BANKRUPTCY:** In the event the vendor/contractor files for bankruptcy protection, this contract is automatically null and void, and is terminated without further order.
14. **HIPAA Business Associate Addendum -** The West Virginia State Government HIPAA Business Associate Addendum (BAA), approved by the Attorney General, and available online at the Purchasing Division's web site (<http://www.state.wv.us/admin/purchase/vrc/hipaa.htm>) is hereby made part of the agreement. Provided that, the Agency meets the definition of a Covered Entity (45 CFR §160.103) and will be disclosing Protected Health Information (45 CFR §160.103) to the vendor.

---

**INSTRUCTIONS TO BIDDERS**

1. Use the quotation forms provided by the Purchasing Division.
2. **SPECIFICATIONS:** Items offered must be in compliance with the specifications. Any deviation from the specifications must be clearly indicated by the bidder. Alternates offered by the bidder as **EQUAL** to the specifications must be clearly defined. A bidder offering an alternate should attach complete specifications and literature to the bid. The Purchasing Division may waive minor deviations to specifications.
3. Complete all sections of the quotation form.
4. Unit prices shall prevail in cases of discrepancy.
5. All quotations are considered F.O.B. destination unless alternate shipping terms are clearly identified in the quotation.
6. **BID SUBMISSION:** All quotations must be delivered by the bidder to the office listed below prior to the date and time of the bid opening. Failure of the bidder to deliver the quotations on time will result in bid disqualifications.

**SIGNED BID TO:**

Department of Administration  
Purchasing Division  
2019 Washington Street East  
Post Office Box 50130  
Charleston, WV 25305-0130



State of West Virginia  
 Department of Administration  
 Purchasing Division  
 2019 Washington Street East  
 Post Office Box 50130  
 Charleston, WV 25305-0130

# Request for Quotation

RFQ NUMBER  
**LSH70145**

PAGE  
**2**

ADDRESS CORRESPONDENCE TO ATTENTION OF  
**ROBERTA WAGNER**  
**304-558-0067**

RFQ COPY  
 TYPE NAME/ADDRESS HERE

VENDOR

SHIP TO

**HEALTH AND HUMAN RESOURCES**  
**LAKIN HOSPITAL**

**1 BATEMAN CIRCLE**  
**LAKIN, WV**  
**25287**

**304-675-0860**

DATE PRINTED	TERMS OF SALE	SHIP VIA	F.O.B.	FREIGHT TERMS
<b>04/30/2007</b>				

BID OPENING DATE: **05/31/2007** BID OPENING TIME **01:30PM**

LINE	QUANTITY	UOP	CAT NO	ITEM NUMBER	UNIT PRICE	AMOUNT
0003	120	EA		370-99	\$42.79	\$213.95
	9" CHINA DINNER PLATE DESIGNED TO HOLD HEAT.					
0004	24	EA		370-99	\$7.64	\$183.36
	9" DIVIDED (3 COMPARTMENT) PLATE, CHINA OR DESIGNED TO HOLD HEAT.					
0005	144	EA		370-99	\$64.78	\$194.34
	8 OZ. INSULATED MUG (POLYPROPYLENE) WITH PEDESTAL BASE AND CHINA-LIKE APPEARANCE.					
0006	144	EA		370-99	\$64.78	\$194.34
	9 OZ. INSULATED BOWL (POLYPROPYLENE) WITH CHINA-LIKE APPEARANCE.					

SEE REVERSE SIDE FOR TERMS AND CONDITIONS

SIGNATURE	<i>Robert H. Klein Jr.</i>	TELEPHONE	806-808-5996	DATE	5/14/07
TITLE	SENIOR VP	FEIN	39-1519806	ADDRESS CHANGES TO BE NOTED ABOVE	

WHEN RESPONDING TO RFQ, INSERT NAME AND ADDRESS IN SPACE ABOVE LABELED 'VENDOR'



State of West Virginia  
 Department of Administration  
 Purchasing Division  
 2019 Washington Street East  
 Post Office Box 50130  
 Charleston, WV 25305-0130

### Request for Quotation

RFQ NUMBER  
**LSH70145**

PAGE  
**3**

ADDRESS CORRESPONDENCE TO ATTENTION OF  
**ROBERTA WAGNER  
 304-558-0067**

VENDOR

RFQ COPY  
 TYPE NAME/ADDRESS HERE

SHIP TO

**HEALTH AND HUMAN RESOURCES  
 LAKIN HOSPITAL**

**1 BATEMAN CIRCLE  
 LAKIN, WV  
 25287**

**304-675-0860**

DATE PRINTED	TERMS OF SALE	SHIP VIA	F.O.B.	FREIGHT TERMS
04/30/2007				

BID OPENING DATE: **05/31/2007** BID OPENING TIME **01:30PM**

LINE	QUANTITY	UOP	CAT NO	ITEM NUMBER	UNIT PRICE	AMOUNT
0007	144	HR		370-99	\$64.78	\$194.34
5 OZ. INSULATED BOWL (POLYPROPYLENE) WITH CHINA-LIKE APPEARANCE.						
0008	120	EA		370-99	\$150.85	\$1,508.05
15" X 20" LOW PROFILE TRAYS, COMPRESSION MOLDED, STEEL BAND REINFORCED, IVORY COLOR TO MATCH ANY COLOR DOME AND BASE BID ELSEWHERE ON THIS RFQ.						
0009	1	EA		370-99	\$4,278.64	\$4,278.64
HEATED PLATE AND BASE DISPENSING CABINET FOR PLATES 9 1/8"; 114 PLATE CAPACITY. MOBILE CABINET MUST BE STAINLESS STEEL CONSTRUCTION WITH CORNER BUMPERS. CABINET BOTTOM MUST HAVE CENTER CLEAN OUT HOLE. CASTERS MUST BE 4" DIAMETER EXTRA-LOAD SWIVEL (TWO WITH LOCKING BRAKE). DISPENSER TUBES MUST BE OF WELDED STAINLESS STEEL CONSTRUCTION AND MUST DROP INTO						

SEE REVERSE SIDE FOR TERMS AND CONDITIONS

SIGNATURE	ROBERT H. KLEIN JR.	TELEPHONE	866-808-5996	DATE	5/14/07
TITLE	SENIOR VP	FEIN	39-1519806	ADDRESS CHANGES TO BE NOTED ABOVE	

WHEN RESPONDING TO RFQ, INSERT NAME AND ADDRESS IN SPACE ABOVE LABELED 'VENDOR'



State of West Virginia  
 Department of Administration  
 Purchasing Division  
 2019 Washington Street East  
 Post Office Box 50130  
 Charleston, WV 25305-0130

# Request for Quotation

RFQ NUMBER  
**LSH70145**

PAGE  
**4**

ADDRESS CORRESPONDENCE TO ATTENTION OF  
**ROBERTA WAGNER  
 304-558-0067**

RFQ COPY  
 TYPE NAME/ADDRESS HERE

S U P P L I E R

S U P P L I E R

**HEALTH AND HUMAN RESOURCES  
 LAKIN HOSPITAL  
 1 BATEMAN CIRCLE  
 LAKIN, WV  
 25287  
 304-675-0860**

DATE PRINTED	TERMS OF SALE	SHIP VIA	FCB	FREIGHT TERMS
<b>04/30/2007</b>				

BID OPENING DATE: **05/31/2007** BID OPENING TIME **01:30PM**

LINE	QUANTITY	UOP	CAT NO	ITEM NUMBER	UNIT PRICE	AMOUNT
				<p>MOBILE CABINET TOP OPENINGS. DISPENSER MUST HANG FROM CABINET OPENING BY A NOT GREATER THAN 22 GAUGE FLANGE RING AND MUST FEATURE THREE EACH NOT GREATER THAN 22 GAUGE VERTICAL SIDE SUPPORTS WELDED TO A NOT GREATER THAN 22 GAUGE BOTTOM PLATE. SELF LEVELING DISH CARRIAGE MUST BE WELDED STAINLESS STEEL CONSTRUCTION AND MUST TRAVEL VERTICALLY IN DISPENSER TUBE WITH NYLON GUIDES FOR SMOOTH OPERATION. CARRIAGE MUST HAVE A NOT GREATER THAN 22 GAUGE REMOVABLE DISH PLATFORM. DISPENSERS MUST FEATURE FLANGE MOUNTED PERIMETER EXTENSION SPRINGS, WHICH ARE DETACHABLE FROM THE DISH CARRIAGE, TO PROVIDE ADJUSTMENTS WITHOUT TOOLS FOR DIFFERENT WEIGHT DISHES. HEATING UNIT MUST BE 120 VAC 60 HZ AND MUST HAVE A 6' POWER CORD. CABINET MUST HAVE INTERIOR MOUNTED ELECTRICAL JUNCTION BOX WITH TWIST-LOCK RECEPTACLES FOR INDIVIDUAL POWER TO EACH DISPENSER. DISPENSER TUBES MUST BE FULLY ENCLOSED IN NOT GREATER THAN 22 GAUGE STAINLESS STEEL AND MUST HAVE A CIRCULAR BOTTOM MOUNTED 300 TO 450 WATT HEATER ELEMENT TO PROVIDE CONVECTION HEAT. HEATING SYSTEM MUST FEATURE THERMOSTATIC CONTROL IN A TAMPER PROTECTIVE LOCATION WITH SAFE HIGH-END SHUT OFF. CONTROL MUST HAVE INFINITE SETTINGS BETWEEN LOW AND HIGH TEMPERATURE CUT-OFFS. THERMOSTAT MUST BE FIELD ADJUSTABLE FOR AVERAGE INTERIOR AIR TEMPERATURE BETWEEN 100 DEGREES F. AND 175 DEGREES F AT MIDDLE ADJUSTABLE THERMOSTATIC SETTING. ON/OFF SWITCH AND POWER INDICATOR LIGHT MUST BE MOUNTED ON TOP FLANGE OF DISPENSER. AVERAGE DISH TEMPERATURE RISE OF 40 DEGREES F ABOVE AMBIENT MUST BE ACHIEVED WITHIN ONE HOUR OF INITIAL HEATING CYCLE AT HEATING CYCLE AT MIDDLE ADJUSTABLE THERMOSTATIC SETTING. CABINET AND DISPENSER TUBES MUST BE UL LISTED.</p>		

SEE REVERSE SIDE FOR TERMS AND CONDITIONS

SIGNATURE 	TELEPHONE <b>866-808-5996</b>	DATE <b>5/14/07</b>
TITLE <b>SENIOR VP</b>	FEIN <b>39-1519806</b>	ADDRESS CHANGES TO BE NOTED ABOVE

WHEN RESPONDING TO RFQ, INSERT NAME AND ADDRESS IN SPACE ABOVE LABELED 'VENDOR'



State of West Virginia  
 Department of Administration  
 Purchasing Division  
 2019 Washington Street East  
 Post Office Box 50130  
 Charleston, WV 25305-0130

# Request for Quotation

RFQ NUMBER  
**LSH70145**

PAGE  
**5**

ADDRESS CORRESPONDENCE TO ATTENTION OF  
**ROBERTA WAGNER  
 304-558-0067**

RFQ COPY

TYPE NAME/ADDRESS HERE

SHIP TO

**HEALTH AND HUMAN RESOURCES  
 LAKIN HOSPITAL**

**1 BATEMAN CIRCLE  
 LAKIN, WV  
 25287**

**304-675-0860**

DATE PRINTED	TERMS OF SALE	SHIP VIA	F.O.B.	FREIGHT TERMS
<b>04/30/2007</b>				

BID OPENING DATE: **05/31/2007** BID OPENING TIME **01:30PM**

LINE	QUANTITY	UOP	CAT NO.	ITEM NUMBER	UNIT PRICE	AMOUNT
0010	2	EA		370-99	\$1,370.54	\$2,741.08
DOME AND BASE DRYING AND STORAGE RACK/CART  80/160 DOME LID/BASE CAPACITY. CART FRAME MUST BE CONSTRUCTED OF NOT GREATER THAN 22 GAUGE STAINLESS STEEL UPRIGHT FRAME; 1" DIAMETER. CRADLE SUPPORTS MUST BE NOT GREATER THAN 22 GAUGE WELDED AND POLISHED STAINLESS STEEL ANGLE BARS WITH 1" STAINLESS STEEL CENTER SUPPORTS TO HOLD REMOVABLE CRADLE INSERTS. CRADLES MUST BE MADE OF UNCOATED STAINLESS STEEL AND MUST NOT CHIP, SPLIT, OR CORRODE. MUST HAVE SWIVEL CASTERS (TWO MUST HAVE LOCKING BRAKES). APPROX. DIMENSIONS: 40" LONG, X 20 1/4" DEEP X UP TO 65" HIGH WITH CRADLES.						
0011	1	EA		370-99	\$488.56	\$488.56
TRAY AND FLATWARE CART: 114 TRAY CAPACITY.  TRAYS MUST STORE IN BOTTOM OF CART, WITH DIVIDED COMPARTMENTS ON TOP THAT HOLD FLATWARE, NAPKINS AND CONDIMENTS. CARET MUST BE MADE OF SINGLE-MOLDED, SEAMLESS, DOUBLE WALL, HIGH-DENSITY POLYETHYLENE CONSTRUCTION THAT MUST BE IMPACT RESISTANT, WON'T RUST, PEEL, CRACK OR DENT. MUST HAVE FOUR 6" SWIVEL CASTERS, (TWO WITH BRAKES). MUST INCLUDE VINYL COVER FOR ADDED PROTECTION AND SANITARY STORAGE.						

SEE REVERSE SIDE FOR TERMS AND CONDITIONS

SIGNATURE	ROBERT H. KLEIN JR.	TELEPHONE	866-808-5996	DATE	5/14/07
TITLE	SENIOR VP	FEIN	39-1519806	ADDRESS CHANGES TO BE NOTED ABOVE	

WHEN RESPONDING TO RFQ, INSERT NAME AND ADDRESS IN SPACE ABOVE LABELED 'VENDOR'



State of West Virginia  
 Department of Administration  
 Purchasing Division  
 2019 Washington Street East  
 Post Office Box 50130  
 Charleston, WV 25305-0130

# Request for Quotation

RFQ NUMBER  
**LSH70145**

PAGE  
**6**

ADDRESS CORRESPONDENCE TO ATTENTION OF  
**ROBERTA WAGNER  
 304-558-0067**

RFQ COPY

TYPE NAME/ADDRESS HERE

SHIP TO

HEALTH AND HUMAN RESOURCES  
 LAKIN HOSPITAL

1 BATEMAN CIRCLE  
 LAKIN, WV  
 25287

304-675-0860

DATE PRINTED	TERMS OF SALE	SHIP VIA	F.O.B.	FREIGHT TERMS
04/30/2007				

BID OPENING DATE: **05/31/2007** BID OPENING TIME **01:30PM**

LINE	QUANTITY	UGP	CAT. NO.	ITEM NUMBER	UNIT PRICE	AMOUNT
0012	8	EA		370-99	\$3,332.97	\$26,663.76
<p>STAINLESS STEEL, LOW-PROFILE DELIVERY CARTS W/ VENTED SIDES FOR INSULATED/WAX BASE WITH DOME LID. CART MUST ACCOMMODATE TWO TRAYS PER SLIDE. APPROXIMATE DEMENSIONS: LENGTH: 51 1/4" X DEPTH: 33 1/2" X HEIGHT: 49 1/4", WITH A CAPACITY FOR AT LEAST 24 TRAYS. MUST HAVE POLYETHYLENE HEAVY DUTY WRAP AROUND BUMPERS THAT MUST BE MOUNTED ON EACH CORNER. MUST HAVE VENTS ON THREE SIDES. CART DOORS MUST BE DOUBLE WALLED AND INSULATED WITH FULL LENGTH DOOR HANDLES. THE FREE FLOATING DOOR MUST HAVE A FULL 270 DEGREE DOOR SWING. CLOSURE MUST BE BY GRAVITY LOCK DEVICE. MUST HAVE ADJUSTABLE NOT GREATER THAN 22 GAUGE STAINLESS STEEL TRAY SLIDES POSITIONED AT SPECIFIC VERTICAL SPACING AND REMOVABLE FOR CLEANING. SLIDES MUST BE FIELD ADJUSTABLE TO ACCOMMODATE 15" X 20" TRAYS. CASTERS: MUST HAVE FOUR CASTERS, TWO MUST SWIVEL WITH BRAKES AND TWO MUST BE FIXED. ALL MUST HAVE PRECISION SEALED BALL BEARINGS. CASTERS MUST BE PLATE MOUNTED AND BOLTED TO THE BASE.</p> <p>ALL ITEMS ON THE RFQ TO BE DELIVERED WITHIN 90 DAYS OF RECEIPT OF ORDER (ARO).</p> <p>CANCELLATION: THE DIRECTOR OF PURCHASING RESERVES THE RIGHT TO CANCEL THIS CONTRACT IMMEDIATELY UPON WRITTEN NOTICE TO THE VENDOR IF THE COMMODITIES AND/OR SERVICES SUPPLIED ARE OF AN INFERIOR QUALITY OR DO NOT CONFORM TO THE SPECIFICATIONS OF THE BID AND CONTRACT HEREIN.</p>						

SEE REVERSE SIDE FOR TERMS AND CONDITIONS

SIGNATURE 	TELEPHONE 866-808-5996	DATE 5/14/07
TITLE SENIOR VP	FEIN 39-1519806	ADDRESS CHANGES TO BE NOTED ABOVE

WHEN RESPONDING TO RFQ, INSERT NAME AND ADDRESS IN SPACE ABOVE LABELED 'VENDOR'



State of West Virginia  
 Department of Administration  
 Purchasing Division  
 2019 Washington Street East  
 Post Office Box 50130  
 Charleston, WV 25305-0130

# Request for Quotation

RFQ NUMBER  
 LSH70145

PAGE  
 7

ADDRESS CORRESPONDENCE TO ATTENTION OF  
 ROBERTA WAGNER  
 304-558-0067

RFQ COPY  
 TYPE NAME/ADDRESS HERE

HEALTH AND HUMAN RESOURCES  
 LAKIN HOSPITAL  
  
 1 BATEMAN CIRCLE  
 LAKIN, WV  
 25287 304-675-0860

DATE PRINTED 04/30/2007	TERMS OF SALE	SHIP VIA	F.O.B.	FREIGHT TERMS
----------------------------	---------------	----------	--------	---------------

BID OPENING DATE: 05/31/2007 BID OPENING TIME 01:30PM

LINE	QUANTITY	UOP	CAT NO	ITEM NUMBER	UNIT PRICE	AMOUNT
<p>BANKRUPTCY: IN THE EVENT THE VENDOR/CONTRACTOR FILES FOR BANKRUPTCY PROTECTION, THIS CONTRACT IS AUTOMATICALLY NULL AND VOID, AND IS TERMINATED WITHOUT FURTHER ORDER.</p> <p>INQUIRIES            WRITTEN QUESTIONS SHALL BE ACCEPTED THROUGH CLOSE OF BUSINESS ON MAY 16, 2007. QUESTIONS MAY BE SENT VIA USPS, FAX, COURIER OR E-MAIL. IN ORDER TO ASSURE NO VENDOR RECEIVES AN UNFAIR ADVANTAGE, NO SUBSTANTIVE QUESTIONS WILL BE ANSWERED ORALLY. IF POSSIBLE, E-MAIL QUESTIONS ARE PREFERRED. ADDRESS INQUIRIES TO:</p> <p>ROBERTA WAGNER            DEPARTMENT OF ADMINISTRATION            PURCHASING DIVISION            2019 WASHINGTON STREET, EAST            CHARLESTON, WV 25311</p> <p>FAX: 304-558-4115            E-MAIL: RWAGNER@WVADMIN.GOV</p> <p>ALL DINNERWARE SHALL HAVE A 6 (SIX) MONTH WARRANTY.            ALL EQUIPMENT SHALL HAVE A 1 (ONE) YEAR WARRANTY. IT IS PREFERRED THAT THE WARRANTY BE SUBMITTED WITH THE BID.</p> <p>THE MODEL/BRAND/SPECIFICATIONS NAMED HEREIN ESTABLISH THE ACCEPTABLE LEVEL OF QUALITY ONLY AND ARE NOT INTENDED TO REFLECT A PREFERENCE OR FAVOR ANY PARTICULAR BRAND OR VENDOR. VENDORS WHO ARE BIDDING ALTERNATES SHOULD SO STATE AND INCLUDE PERTINENT LITERATURE AND SPECIFICATIONS. FAILURE TO PROVIDE INFORMATION FOR ANY ALTERNATES MAY BE GROUNDS FOR</p>						

SEE REVERSE SIDE FOR TERMS AND CONDITIONS.

SIGNATURE 	TITLE SENIOR VP	TELEPHONE 806-808-5996	DATE 5/17/07
FEIN 39-1519806	ADDRESS CHANGES TO BE NOTED ABOVE		

WHEN RESPONDING TO RFQ, INSERT NAME AND ADDRESS IN SPACE ABOVE LABELED 'VENDOR'





State of West Virginia  
 Department of Administration  
 Purchasing Division  
 2019 Washington Street East  
 Post Office Box 50130  
 Charleston, WV 25305-0130

# Request for Quotation

RFQ NUMBER  
**LSH70145**

PAGE  
**8**

ADDRESS CORRESPONDENCE TO ATTENTION OF  
**ROBERTA WAGNER  
 304-558-0067**

PROJECT

RFQ COPY  
 TYPE NAME/ADDRESS HERE

SHIP TO

HEALTH AND HUMAN RESOURCES  
 LAKIN HOSPITAL  
 1 BATEMAN CIRCLE  
 LAKIN, WV  
 25287  
 304-675-0860

DATE PRINTED	TERMS OF SALE	SHIP VIA	F.O.B.	FREIGHT TERMS
04/30/2007				

BID OPENING DATE: **05/31/2007** BID OPENING TIME **01:30PM**

LINE	QUANTITY	UOP	CAT NO	ITEM NUMBER	UNIT PRICE	AMOUNT
<p>REJECTION OF THE BID. THE STATE RESERVES THE RIGHT TO WAIVE MINOR IRREGULARITIES IN BIDS OR SPECIFICATIONS IN ACCORDANCE WITH SECTION 148-1-4(F) OF THE WEST VIRGINIA LEGISLATIVE RULES AND REGULATIONS.</p> <p>VENDOR PREFERENCE CERTIFICATE</p> <p>CERTIFICATION AND APPLICATION* IS HEREBY MADE FOR PREFERENCE IN ACCORDANCE WITH WEST VIRGINIA CODE, 5A-3-37 (DOES NOT APPLY TO CONSTRUCTION CONTRACTS).</p> <p>A. APPLICATION IS MADE FOR 2.5% PREFERENCE FOR THE REASON CHECKED:</p> <p>( ) BIDDER IS AN INDIVIDUAL RESIDENT VENDOR AND HAS RESIDED CONTINUOUSLY IN WEST VIRGINIA FOR FOUR (4) YEARS IMMEDIATELY PRECEDING THE DATE OF THIS CERTIFICATION; OR</p> <p>( ) BIDDER IS A PARTNERSHIP, ASSOCIATION OR CORPORATION RESIDENT VENDOR AND HAS MAINTAINED ITS HEAD-QUARTERS OR PRINCIPAL PLACE OF BUSINESS CONTINUOUSLY IN WEST VIRGINIA FOR FOUR (4) YEARS IMMEDIATELY PRECEDING THE DATE OF THIS CERTIFICATION; OR 80% OF THE OWNERSHIP INTEREST OF BIDDER IS HELD BY ANOTHER INDIVIDUAL, PARTNERSHIP, ASSOCIATION OR CORPORATION RESIDENT VENDOR WHO HAS MAINTAINED ITS HEADQUARTERS OR PRINCIPAL PLACE OF BUSINESS CONTINUOUSLY IN WEST VIRGINIA FOR FOUR (4) YEARS IMMEDIATELY PRECEDING THE DATE OF THIS CERTIFICATION; OR</p> <p>( ) BIDDER IS A CORPORATION NONRESIDENT VENDOR WHICH HAS AN AFFILIATE OR SUBSIDIARY WHICH EMPLOYS A MINIMUM OF ONE HUNDRED STATE RESIDENTS AND WHICH HAS MAINTAINED ITS HEADQUARTERS OR PRINCIPAL PLACE OF BUSINESS WITHIN WEST VIRGINIA CONTINUOUSLY FOR THE</p>						

SEE REVERSE SIDE FOR TERMS AND CONDITIONS

SIGNATURE <i>Robert H. Klein Jr.</i>	TELEPHONE 866-808-5996	DATE 5/14/07
TITLE SENIOR VP	FEIN 39-1519806	ADDRESS CHANGES TO BE NOTED ABOVE

WHEN RESPONDING TO RFQ, INSERT NAME AND ADDRESS IN SPACE ABOVE LABELED 'VENDOR'



State of West Virginia  
 Department of Administration  
 Purchasing Division  
 2019 Washington Street East  
 Post Office Box 50130  
 Charleston, WV 25305-0130

# Request for Quotation

RFQ NUMBER  
**LSH70145**

PAGE  
**9**

ADDRESS CORRESPONDENCE TO ATTENTION OF  
**ROBERTA WAGNER  
 304-558-0067**

RFQ COPY  
 TYPE NAME/ADDRESS HERE

VENDOR

SUPPLIER

**HEALTH AND HUMAN RESOURCES  
 LAKIN HOSPITAL  
 1 BATEMAN CIRCLE  
 LAKIN, WV  
 25287  
 304-675-0860**

DATE PRINTED	TERMS OF SALE	SHIP VIA	F.O.B.	FREIGHT TERMS
04/30/2007				

BID OPENING DATE: **05/31/2007** BID OPENING TIME **01:30PM**

LINE	QUANTITY	UOP	CAT NO	ITEM NUMBER	UNIT PRICE	AMOUNT
<p>FOUR (4) YEARS IMMEDIATELY PRECEDING THE DATE OF THIS CERTIFICATION.</p> <p>B. APPLICATION IS MADE FOR 2.5% PREFERENCE FOR THE REASON CHECKED:</p> <p>( ) BIDDER IS A RESIDENT VENDOR WHO CERTIFIES THAT, DURING THE LIFE OF THE CONTRACT, ON AVERAGE AT LEAST 75% OF THE EMPLOYEES WORKING ON THE PROJECT BEING BID ARE RESIDENTS OF WEST VIRGINIA WHO HAVE RESIDED IN THE STATE CONTINUOUSLY FOR THE TWO YEARS IMMEDIATELY PRECEDING SUBMISSION OF THIS BID;</p> <p>OR</p> <p>( ) BIDDER IS A NONRESIDENT VENDOR EMPLOYING A MINIMUM OF ONE HUNDRED STATE RESIDENTS OR IS A NONRESIDENT VENDOR WITH AN AFFILIATE OR SUBSIDIARY WHICH MAINTAINS ITS HEADQUARTERS OR PRINCIPAL PLACE OF BUSINESS WITHIN WEST VIRGINIA EMPLOYING A MINIMUM OF ONE HUNDRED STATE RESIDENTS WHO CERTIFIES THAT, DURING THE LIFE OF THE CONTRACT, ON AVERAGE AT LEAST 75% OF THE EMPLOYEES OR BIDDERS' AFFILIATE'S OR SUBSIDIARY'S EMPLOYEES ARE RESIDENTS OF WEST VIRGINIA WHO HAVE RESIDED IN THE STATE CONTINUOUSLY FOR THE TWO YEARS IMMEDIATELY PRECEDING SUBMISSION OF THIS BID.</p> <p>BIDDER UNDERSTANDS IF THE SECRETARY OF TAX &amp; REVENUE DETERMINES THAT A BIDDER RECEIVING PREFERENCE HAS FAILED TO CONTINUE TO MEET THE REQUIREMENTS FOR SUCH PREFERENCE, THE SECRETARY MAY ORDER THE DIRECTOR OF PURCHASING TO: (A) RESCIND THE CONTRACT OR PURCHASE ORDER ISSUED; OR (B) ASSESS A PENALTY AGAINST SUCH BIDDER IN AN AMOUNT NOT TO EXCEED 5% OF THE BID AMOUNT AND THAT SUCH PENALTY WILL BE PAID TO THE CONTRACTING AGENCY OR DEDUCTED FROM ANY UNPAID BALANCE ON THE CONTRACT OR PURCHASE ORDER.</p>						

SEE REVERSE SIDE FOR TERMS AND CONDITIONS

SIGNATURE <i>Robert H. Klein Jr.</i>	TELEPHONE 806-808-5996	DATE 5/14/07
TITLE SENIOR VP.	FEIN 39-1519806	ADDRESS CHANGES TO BE NOTED ABOVE

WHEN RESPONDING TO RFQ, INSERT NAME AND ADDRESS IN SPACE ABOVE LABELED 'VENDOR'



State of West Virginia  
 Department of Administration  
 Purchasing Division  
 2019 Washington Street East  
 Post Office Box 50130  
 Charleston, WV 25305-0130

# Request for Quotation

RFQ NUMBER:  
**LSH70145**

PAGE:  
**10**

ADDRESS CORRESPONDENCE TO ATTENTION OF:  
**ROBERTA WAGNER  
 304-558-0067**

RFQ COPY  
 TYPE NAME/ADDRESS HERE

PURCHASER

SUPPLIER

HEALTH AND HUMAN RESOURCES  
 LAKIN HOSPITAL

1 BATEMAN CIRCLE  
 LAKIN, WV  
 25287

304-675-0860

DATE PRINTED	TERMS OF SALE	SHIP VIA	F.O.B.	FREIGHT TERMS
04/30/2007				

BID OPENING DATE: **05/31/2007** BID OPENING TIME **01:30PM**

LINE	QUANTITY	UOP	CAT NO	ITEM NUMBER	UNIT PRICE	AMOUNT
<p>BY SUBMISSION OF THIS CERTIFICATE, BIDDER AGREES TO DISCLOSE ANY REASONABLY REQUESTED INFORMATION TO THE PURCHASING DIVISION AND AUTHORIZES THE DEPARTMENT OF TAX AND REVENUE TO DISCLOSE TO THE DIRECTOR OF PURCHASING APPROPRIATE INFORMATION VERIFYING THAT BIDDER HAS PAID THE REQUIRED BUSINESS TAXES, PROVIDED THAT SUCH INFORMATION DOES NOT CONTAIN THE AMOUNTS OF TAXES PAID NOR ANY OTHER INFORMATION DEEMED BY THE TAX COMMISSIONER TO BE CONFIDENTIAL.</p> <p>UNDER PENALTY OF LAW FOR FALSE SWEARING (WEST VIRGINIA CODE 61-5-3), BIDDER HEREBY CERTIFIES THAT THIS CERTIFICATE IS TRUE AND ACCURATE IN ALL RESPECTS; AND THAT IF A CONTRACT IS ISSUED TO BIDDER AND IF ANYTHING CONTAINED WITHIN THIS CERTIFICATE CHANGES DURING THE TERM OF THE CONTRACT, BIDDER WILL NOTIFY THE PURCHASING DIVISION IN WRITING IMMEDIATELY.</p> <p>BIDDER: <u>Direct Supply Inc</u></p> <p>DATE: _____</p> <p>SIGNED: _____</p> <p>TITLE: _____</p> <p>* CHECK ANY COMBINATION OF PREFERENCE CONSIDERATION(S) IN EITHER "A" OR "B", OR BOTH "A" AND "B" WHICH YOU ARE ENTITLED TO RECEIVE. YOU MAY REQUEST UP TO THE MAXIMUM 5% PREFERENCE FOR BOTH "A" AND "B". (REV. 12/00)</p> <p>NOTICE</p>						
						N/A

SEE REVERSE SIDE FOR TERMS AND CONDITIONS

SIGNATURE 	ROBERT H. KLEIN JR.	TELEPHONE 806-808-5996	DATE 5/14/07
TITLE SENIOR VP	FEIN 39-1519806	ADDRESS CHANGES TO BE NOTED ABOVE	

WHEN RESPONDING TO RFQ, INSERT NAME AND ADDRESS IN SPACE ABOVE LABELED 'VENDOR'



State of West Virginia  
 Department of Administration  
 Purchasing Division  
 2019 Washington Street East  
 Post Office Box 50130  
 Charleston, WV 25305-0130

# Request for Quotation

RFQ NUMBER:  
**LSH70145**

PAGE:  
**11**

ADDRESS CORRESPONDENCE TO ATTENTION OF:  
**ROBERTA WAGNER  
 304-558-0067**

PURCHASER

RFQ COPY  
 TYPE NAME/ADDRESS HERE

SHIP TO

**HEALTH AND HUMAN RESOURCES  
 LAKIN HOSPITAL  
 1 BATEMAN CIRCLE  
 LAKIN, WV  
 25287  
 304-675-0860**

DATE PRINTED	TERMS OF SALE	SHIP VIA	F.O.B.	FREIGHT TERMS
04/30/2007				

BID OPENING DATE: **05/31/2007** BID OPENING TIME **01:30PM**

LINE	QUANTITY	UOP	CAT NO	ITEM NUMBER	UNIT PRICE	AMOUNT
<p>A SIGNED BID MUST BE SUBMITTED TO:</p> <p>DEPARTMENT OF ADMINISTRATION            PURCHASING DIVISION            BUILDING 15            2019 WASHINGTON STREET, EAST            CHARLESTON, WV 25305-0130</p> <p>PLEASE NOTE: A CONVENIENCE COPY WOULD BE APPRECIATED.</p> <p>THE BID SHOULD CONTAIN THIS INFORMATION ON THE FACE OF THE ENVELOPE OR THE BID MAY NOT BE CONSIDERED:</p> <p>SEALED BID</p> <p>BUYER:-----ROBERTA WAGNER/FILE 22-----</p> <p>RFQ. NO.:-----LSH70145-----</p> <p>BID OPENING DATE:---MAY 31, 2007-----</p> <p>BID OPENING TIME:---1:30 PM-----</p> <p>PLEASE PROVIDE A FAX NUMBER IN CASE IT IS NECESSARY TO CONTACT YOU REGARDING YOUR BID:</p> <p>-----800-770-1707-----</p> <p>CONTACT PERSON (PLEASE PRINT CLEARLY):</p> <p>-----DOUG KNOTSON-----</p>						

SEE REVERSE SIDE FOR TERMS AND CONDITIONS

SIGNATURE 	ROBERT H. KLEIN JR.	TELEPHONE 806-808-5996	DATE 5/14/07
TITLE SENIOR VP	FEIN 39-1519806	ADDRESS CHANGES TO BE NOTED ABOVE	

WHEN RESPONDING TO RFQ, INSERT NAME AND ADDRESS IN SPACE ABOVE LABELED 'VENDOR'

**STATE OF WEST VIRGINIA  
PURCHASE CONTINUATION SHEET**

Page 1 of 3 Pages

Requisition/P.O No :  
LSH70145

Vendor: DIRECT SUPPLY INC. P O Date: \_\_\_\_\_

File: <b>RW22</b>	Acct. No.: <b>5156/2007-2842-335-034</b>
Spending Unit: <b>DHHR - LAKIN HOSPITAL</b>	

Item No.	Quantity	Description	Unit Price	Amount
		REQUEST TO PURCHASE THE FOLLOWING DINNERWARE:		
1	120 EA.	INSULATED DOME DINNERWARE SIZED TO FIT A 9" PLATE - DOME MUST BE POLYPROPYLENE, DOUBLE-WALL CONSTRUCTION WITH OZONE-SAFE URETHANE FOAM INSULATION. DOME MUST BE ONE PIECE CONSTRUCTION FOR A 90 MINUTE TRAY SYSTEM.		
2.	120 EA.	INSULATED BASE SIZED TO FIT A 9" PLATE. BASE MUST BE SINGLE-WALL CONSTRUCTION WITH WAX BASE UNDERLINER.		
3.	120 EA.	9" CHINA DINNER PLATE DESIGNED TO HOLD HEAT		
4.	24 EA.	9" DIVIDED (3 COMPARTMENTS) PLATE DESIGNED TO HOLD HEAT.		
5	144 EA.	8 OZ. INSULATED MUG - MUST BE POLYPROPYLENE WITH PEDESTAL BASE AND CHINA LIKE APPEARANCE.		
6.	144 EA.	9 OZ. INSULATED BOWL - MUST BE POLYPROPYLENE WITH CHINA LIKE APPEARANCE		
7	144 EA.	5 OZ. INSULATED BOWL - MUST BE POLYPROPYLENE WITH CHINA LIKE APPEARANCE.		
8.	120 EA.	15" X 20" LOW PROFILE TRAYS - MUST BE COMPRESSION MOLDED, STEEL BAND REINFORCED; IVORY COLOR TO MATCH ANY COLOR DOME AND BASE BID ON REMAINING ITEMS ON THIS REQUEST		
9.	1 EA.	HEATED PLATE AND BASE DESPENSING CABINET FOR PLATES 9 1/8"; 114 PLATE CAPACITY. MOBILE CABINET MUST BE STAINLESS STEEL CONSTRUCTION WITH CORNER BUMPERS. CABINET BOTTOM MUST HAVE CENTER CLEAN OUT HOLE. CASTERS MUST BE EXTRA LOAD SWIVEL (TWO WITH LOCKING BRAKES). DISPENSER TUBES MUST BE OF WELDED STAINLESS STEEL CONSTRUCTION AND MUST DROP INTO MOBILE CABINET TOP OPENINGS. DISPENSER MUST HANG FROM CABINET OPENING BY A NOT GREATER THAN 22 GAUGE FLANGE RING AND FEATURE THREE EACH NOT GREATER THAN 22 GAUGE VERTICAL SIDE SUPPORTS WELDED TO A NOT GREATER THAN 22 GAUGE BOTTOM PLATE. SELF LEVELING DISH CARRIAGE MUST BE OF WELDED STAINLESS STEEL CONSTRUCTION AND MUST TRAVEL VERTICALLY IN DISPENSER TUBE WITH NYLON GUIDES FOR SMOOTH OPERATION. CARRIAGE MUST HAVE A NOT GREATER THAN 22 GAUGE REMOVABLE DISH PLATFORM. DISPENSERS MUST FEATURE FLANGE MOUNTED PERIMETER EXTENSION SPRINGS WHICH ARE DETACHABLE FROM THE DISH CARRIAGE, TO PROVIDE ADJUSTMENT WITHOUT TOOLS FOR DIFFERENT WEIGHT DISHES. HEATING UNIT MUST BE 120 VAC 60 HZ AND MUST HAVE A 6' POWER CORD. CABINET MUST HAVE INTERIOR		

STATE OF WEST VIRGINIA

Page 2 of 3 Pages

Requisition / P O. No :  
LSH70145**PURCHASE CONTINUATION SHEET**

File: RW22 Acct. No.: 5156/2007/2842/335/034

Vendor: DIRECT SUPPLY INC. P O. Date: \_\_\_\_\_Spending Unit:  
DHHR - LAKIN HOSPITAL

Item No.	Quantity	Description	Unit Price	Amount
9 CONT.		MOUNTED ELECTRICAL JUNCTION BOX WITH TWIST LOCK RECEPTACLES FOR INDIVIDUAL POWER TO EACH DISPENSER. DISPENSER TUBES MUST BE FULLY ENCLOSED IN NOT GREATER THAN 22 GAUGE STAINLESS STEEL AND HAVE A CIRCULAR BOTTOM MOUNTED 300 OR 450 WATT HEATER ELEMENT TO PROVIDE CONVECTION HEAT. HEATING SYSTEM MUST FEATURE THERMOSTATIC CONTROL IN A TAMPER PROTECTIVE LOCATION WITH SAFE HIGH END SHUT OFF. CONTROL MUST HAVE INFINITE SETTINGS BETWEEN LOW AND HIGH TEMPERATURE CUT OFFS. THERMOSTAT MUST BE FIELD ADJUSTABLE FOR AVERAGE INTERIOR AIR TEMPERATURE BETWEEN 100 DEGREES F. AND 175 DEGREES F. AT MIDDLE ADJUSTABLE THERMOSTATIC SETTING. ON/OFF SWITCH AND POWER INDICATOR LIGHT MUST BE MOUNTED ON TOP FLANGE OF DISPENSER. AVERAGE DISH TEMPERATURE RISE OF 40 DEGREES F. ABOVE AMBIENT MUST BE ACHIEVED WITHIN ONE HOUR OF INITIAL HEATING CYCLE AT MIDDLE ADJUSTABLE THERMOSTATIC SETTING. CABINET AND DISPENSER TUBES MUST BE UL LISTED.		
10.	2 EA.	DOMED AND BASE DRYING AND STORAGE RACK/CART; 80/160 DOME LID/BASE CAPACITY. CART FRAME MUST BE CONSTRUCTED OF NOT GREATER THAN 22 GAUGE STAINLESS STEEL UPRIGHT FRAME; 1" DIAMETER. CRADLE SUPPORTS MUST BE NOT GREATER THAN 22 GAUGE WELDED AND POLISHED STAINLESS STEEL ANGLE BARS AND 1" STAINLESS STEEL CENTER SUPPORTS TO HOLD REMOVABLE CRADLE INSERTS. CRADLES MUST BE UNCOATED STAINLESS STEEL AND MUST NOT CHIP, SPLIT OR CORRODE. MUST HAVE SWIVEL CASTERS WITH TWO LOCKING BRAKES. APPROXIMATE DIMENSIONS: 40" LONG, 20 1/4" DEEP AND UP TO 65" HIGH WITH CRADLES.		
11.	1 EA.	TRAY & FLATWARE CART; 114 TRAY CAPACITY ORGANIZES TRAYS AND ACCESSORIES IN ONE COMPACT UNIT. TRAYS STORE IN BOTTOM OF CART, DIVIDED COMPARTMENTS ON TOP MUST HOLD FLATWARE, NAPKINS AND CONDIMENTS. CART MUST BE MADE OF SINGLE-MOLDED SEAMLESS, DOUBLE WALL, HIGH DENSITY POLYETHYLENE CONSTRUCTION THAT MUST BE IMPACT RESISTENT AND WON'T RUST, PEEL, CRACK OR DENT. MUST HAVE FOUR EACH SWIVEL CASTERS (TWO MUST HAVE BRAKES). MUST INCLUDE VINYL COVER FOR ADDED PROTECTION AND SANITARY STORAGE.		
12.	8 EA.	STAINLESS STEEL LOW PROFILE DELIVERY CARTS WITH VENTED SIDE FOR INSULATED WAX BASE WITH DOME LID. CART TO ACCOMMODATE TWO TRAYS PER SLIDE LENGTH 51 1/4" X DEPTH 33 1/2" X NO HIGHER THAN 49 1/4" WITH A CAPACITY OF 24 TRAYS. MUST HAVE POLYETHYLENE HEAVY DUTY WRAP AROUND BUMPERS THAT MUST BE MOUNTED ON EACH CORNER. MUST HAVE VENTS ON		

STATE OF WEST VIRGINIA

**PURCHASE CONTINUATION SHEET**

Requisition / P O No.: LSH70145

File: RW22

Acct. No.: 5156/2007/2842/335/034

Vendor: DIRECT SUPPLY INC. P.O. Date: \_\_\_\_\_

Spending Unit: DHHR - LAKIN HOSPITAL

Item No.	Quantity	Description	Unit Price	Amount
12 CONT.		<p>THREE SIDES. CART DOORS MUST BE DOUBLE WALLED AND INSULATED WITH FULL LENGTH DOOR HANDLES. THE FREE FLOATING DOOR MUST HAVE A FULL 270 DEGREE DOOR SWING. CLOSURE MUST BE BY GRAVITY LOCK DEVICE. MUST HAVE ADJUSTABLE NOT GREATER THAN 22 GAUGE STAINLESS STEEL TRAY SLIDES POSITIONED AT SPECIFIC VERTICAL SPACING AND REMOVABLE FOR CLEANING. SLIDES MUST BE FIELD ADJUSTABLE TO ACCOMODATE 15" X 20" TRAYS. MUST HAVE FOUR CASTERS; TWO CASTERS MUST SWIVEL WITH BRAKES AND TWO MUST BE FIXED WITH ALL CASTERS BEING WITH PRECISION SEALED BALL BEARINGS. CASTERS MUST BE PLATE MOUNTED AND BOLTED TO THE BASE.</p> <p>VENDOR MUST MAKE DELIVERY FOR ALL ITEMS LISTED WITHIN 90 DAYS AFTER RECEIPT OF THE APPROVED PURCHASE ORDER (ARO)</p> <p>NOTE: ALL ITEMS ARE DINEX INTERNATIONAL OR EQUAL. BRAND NAME IS USED TO IDENTIFY A QUALITY LEVEL ONLY. ALL ITEMS ARE TO BE USED IN A HOSPITAL ENVIRONMENT.</p>		
<i>Grand Total:</i>				<i>\$39,333.87</i>

STATE OF WEST VIRGINIA  
Purchasing Division015**PURCHASING AFFIDAVIT**

**West Virginia Code §5A-3-10a states:** No contract or renewal of any contract may be awarded by the state or any of its political subdivisions to any vendor or prospective vendor when the vendor or prospective vendor or a related party to the vendor or prospective vendor is a debtor and the debt owned is an amount greater than one thousand dollars in the aggregate

**DEFINITIONS:**

"Debt" means any assessment, premium, penalty, fine, tax or other amount of money owed to the state or any of its political subdivisions because of a judgment, fine, permit violation, license assessment, defaulted workers' compensation premium, penalty or other assessment presently delinquent or due and required to be paid to the state or any of its political subdivisions, including any interest or additional penalties accrued thereon.

"Debtor" means any individual, corporation, partnership, association, limited liability company or any other form or business association owing a debt to the state or any of its political subdivisions. "Political subdivision" means any county commission; municipality; county board of education; any instrumentality established by a county or municipality; any separate corporation or instrumentality established by one or more counties or municipalities, as permitted by law; or any public body charged by law with the performance of a government function or whose jurisdiction is coextensive with one or more counties or municipalities. "Related party" means a party, whether an individual, corporation, partnership, association, limited liability company or any other form or business association or other entity whatsoever, related to any vendor by blood, marriage, ownership or contract through which the party has a relationship of ownership or other interest with the vendor so that the party will actually or by effect receive or control a portion of the benefit, profit or other consideration from performance of a vendor contract with the party receiving an amount that meets or exceeds five percent of the total contract amount.

**EXCEPTION:** The prohibition of this section does not apply where a vendor has contested any tax administered pursuant to chapter eleven of this code, workers' compensation premium, permit fee or environmental fee or assessment and the matter has not become final or where the vendor has entered into a payment plan or agreement and the vendor is not in default of any of the provisions of such plan or agreement.

**LICENSING:** Vendors must be licensed and in good standing in accordance with any and all state and local laws and requirements by any state or local agency of West Virginia, including, but not limited to, the West Virginia Secretary of State's Office, the West Virginia Tax Department, West Virginia Insurance Commission, or any other state agencies or political subdivision. Furthermore, the vendor must provide all necessary releases to obtain information to enable the Director or spending unit to verify that the vendor is licensed and in good standing with the above entities.

**CONFIDENTIALITY:** The vendor agrees that he or she will not disclose to anyone, directly or indirectly, any such personally identifiable information or other confidential information gained from the agency, unless the individual who is the subject of the information consents to the disclosure in writing or the disclosure is made pursuant to the agency's policies, procedures and rules. Vendors should visit [www.state.wv.us/admin/purchase/privacy](http://www.state.wv.us/admin/purchase/privacy) for the Notice of Agency Confidentiality Policies.

Under penalty of law for false swearing (West Virginia Code, §61-5-3), it is hereby certified that the vendor acknowledges the information in this said affidavit and are in compliance with the requirements as stated

Vendor's Name: DIRECT SUPPLY INC.

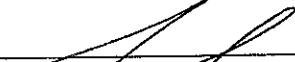
Authorized Signature:  Date: 5/14/07



## THE HERITAGE COLLECTION®

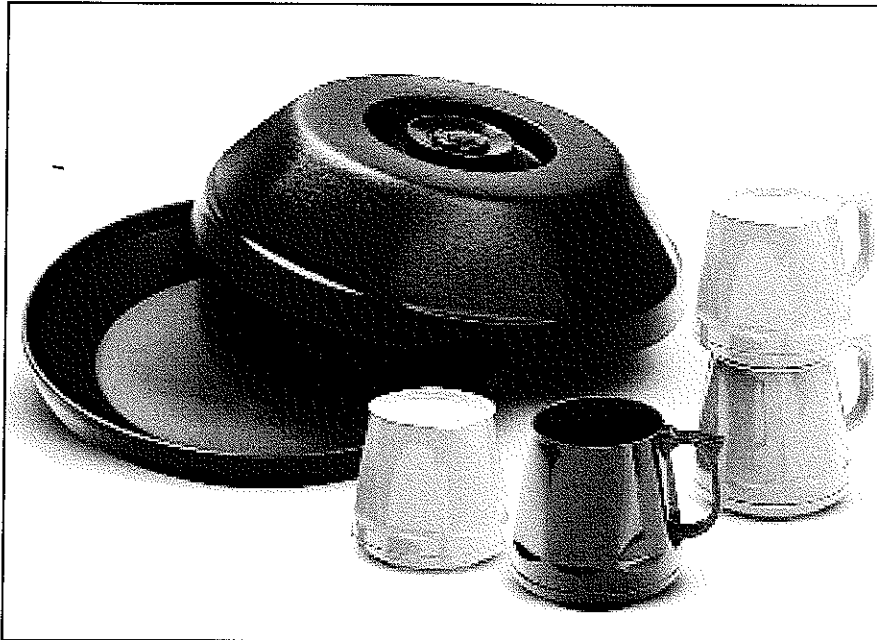

### Application

Patients will welcome a touch of elegance while dining. Rich colors, contemporary faceted styling, and a china-like appearance combine to help de-institutionalize your healthcare food service and making patients feel more at home. Not intended for use in microwave or conventional ovens, hot/cold carts.

### Material

Attractive, durable, and stackable, the Heritage Collection® offers the best temperature retention in the industry - as proven in hospitals and nursing homes. Like all Dinex® insulated products, Heritage is manufactured with ozone-safe urethane foam insulation. Available in a variety of contemporary color choices. Latex free construction.

### Washing Instructions:

Weekly, soaking 6-8 hours. Wash in commercial dishmachine. Do NOT use bleach. Can withstand washing temperatures up to 180°F.

### Item Number for 8 oz. Mug

- 4000/12H - Mauve
- 4000/20H - Cranberry
- 4000/27H - Gray
- 4000/28H - Midnight Blue
- 4000/33H - Teal
- 4000/67H - Cinnamon

### Item Number for 5 oz. Bowl

- 4200/12H - Mauve
- 4200/20H - Cranberry
- 4200/27H - Gray
- 4200/28H - Midnight Blue
- 4200/33H - Teal

### Lids for 8 oz. Mug & 5 oz. Bowl

- 4000/8700 - Clear-View® Flat Lid
- 4000/8714 - Translucent Lid

### Item Number for 8 oz. Tumbler

- 4100/12H - Mauve
- 4100/20H - Cranberry
- 4100/27H - Gray
- 4100/33H - Teal

### Lids for 8 oz. Tumbler

- 4000/8700 - Clear-View® Flat Lid
- 4000/8714 - Translucent Lid

### Item Number for 9 oz. Bowl

- 4300/12H - Mauve
- 4300/20H - Cranberry
- 4300/27H - Gray
- 4300/28H - Midnight Blue
- 4300/33H - Teal
- 4300/67H - Cinnamon

### Lids for 9 oz. Bowl

- 4300/8700 - Clear-View® Flat Lid
- 4300/8714 - Translucent Lid

### Item Number for Insulated Dome

- 4400/12H - Mauve
- 4400/20H - Cranberry
- 4400/27H - Gray
- 4400/28H - Midnight Blue
- 4400/33H - Teal

See spec sheet #370-REV 04/03 for options on Domes, Insul Bases and Underliners.

**DINEX®**  
**International, Inc.**

Building 2, Suite 106  
628 Hebron Avenue  
Glastonbury, CT 06033-5006  
(800) 523-9752 Fax: (860) 652-3135  
<http://www.dinex.com>

# THE HERITAGE COLLECTION®

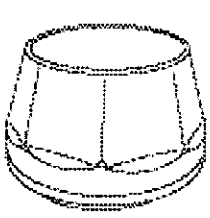

5 oz. Bowl

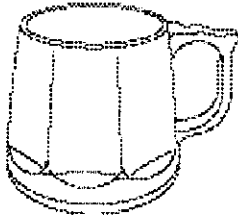

8 oz. Mug

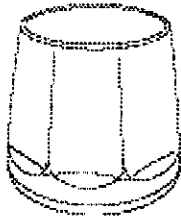

8 oz. Tumbler

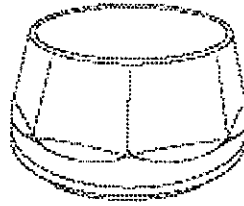

9 oz. Bowl



Dome

## Items and Dimensions

ITEM NUMBER	DIAMETER	OVERALL HEIGHT	PACK	SHIP WEIGHT	SHIP CUBE	CAPACITY	FREIGHT CLASS	MATERIAL
4200/Series (5 oz. Bowl)	3-3/4"	2-1/2"	48	7.1 lbs (3.2kg)	1.1	5 oz.	85	Polypropylene
4000/Series (Mug)	3-3/4"	3-1/2"	48	9.6 lbs (4.4kg)	1.51	8 oz.	85	Polypropylene
4100/Series (Tumbler)	3-3/4"	3-1/2"	48	8.7 lbs (3.9kg)	1.5	8 oz.	85	Polypropylene
4300/Series (9 oz. Bowl)	4-1/2"	2-1/2"	48	8.8 lbs (4.0kg)	1.5	9 oz.	85	Polypropylene
4400/Series (Dome)	10"	2-3/4"	12	9.6 lbs (4.4kg)	1.0	-	85	Polypropylene
4000/8700 (Lid)	-	-	2,000	6.7 lbs (3.0kg)	2.2	-	150	Polystyrene
4000/8714 (Lid)	-	-	2,000	6.4 lbs (2.9kg)	2.2	-	250	Polystyrene
4300/8700 (Lid)	-	-	1,000	4.8 lbs (2.2kg)	1.5	-	150	Polystyrene
4300/8714 (Lid)	-	-	1,000	4.7 lbs (2.1kg)	1.5	-	150	Polystyrene

Note: Heritage Insulated Dome serving height (measured on a standard patient tray) with:

- Insul Base 4-1/8"
- Wax Base Underliner 4-7/16"
- Dome only 2-7/8"

Please confirm that you have the most current specification sheet by visiting [www.dinex.com](http://www.dinex.com).

Dinex® reserves the right to change specifications and product design without notice. Such revisions do not entitle the buyer to corresponding changes, improvements, additions or replacements for previously purchased equipment.

Printed in USA

**DINEX®**  
International, Inc.

Building 2, Suite 106

628 Hebron Avenue

Glastonbury, CT 06033-5006

(800) 523-9752 Fax: (860) 652-3135

<http://www.dinex.com>

320-REV 06/04

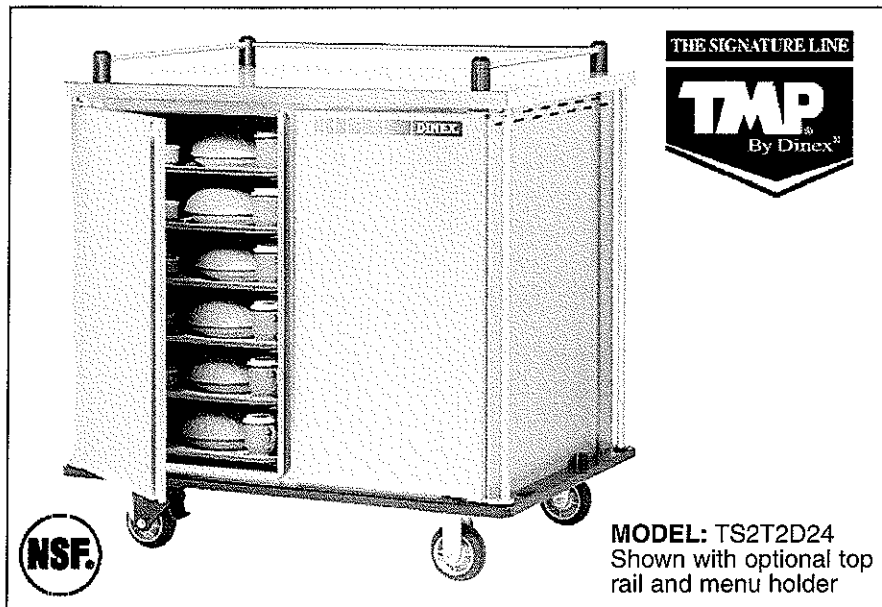
**LOW PROFILE DELIVERY CARTS  
(Two Door, Two Trays Per Slide)****Model Numbers**

- TS2T2D24
- TS2T2D28
- TS2T2D32
- TS2T2D36

**Application**

Low Profile Tray Delivery Base Cart(s) for insulated base, wax base or induction systems. These carts are compatible with all Dinex products for 14" x 18", 15" x 20", 12" x 19", and 12" x 20" trays. These models accommodate two trays per slide.

**Construction**

Carts shall be constructed with 304 No. 3 finish stainless steel, all welds are ground and polished. Meal delivery carts shall be heavy duty stainless steel construction as follows:

<b>Top</b>	20 gauge, 304 No 4 Finish
<b>End/Back Panels</b>	20 gauge, 304 No 4 Finish
<b>Base</b>	20 gauge, 304 No 4 Finish
<b>Door Front</b>	22 gauge, 304 No 4 Finish
<b>Door Back</b>	22 gauge, 304 No. 4 Finish

Top and base shall be welded to body of the unit for added strength. All exterior welds shall be ground and polished. Chassis has 14 gauge stainless steel caster channels.

The 1 5" thick, non-marking, polyethylene heavy-duty wrap around bumpers shall be mounted at full perimeter of the base. Four vertical push handles will be mounted on each corner for optimal ergonomic position when pushing the cart. Vents on three sides are standard.

**Cam Action Style Door**

The door on all models shall be double-walled and insulated. The free floating door has a full 270° door swing. Closure shall be by gravity lock device, which retains the door in both the 270° open position as well as the 0° closed position.

**Adjustable Tray Slides**

Stainless steel tray slides, 20 gauge shall be positioned at specified vertical spacing and removable for cleaning. Slides shall be field adjustable to accommodate 15" x 20", 14" x 18", 12" x 19", and 12" x 20" trays.

**Casters**

Four 6" Colson Performa casters, 2 swivel w/brakes and 2 fixed all with precision sealed ball bearings shall be standard. Casters are plate mounted and bolted to the base.

**Special Features**

- 6" Performa Casters w/Precision sealed ball bearing
- 2-locking casters
- Vertical push handles
- Full length door handle
- Pre-drilled holes for additional caster options
- Adjustable tray slides

**Warranty**

One year parts and labor.

**DINEX.  
International, Inc.**

Building 2, Suite 106  
628 Hebron Avenue  
Glastonbury, CT 06033-5006  
(800) 523-9752 Fax: (860) 652-3135  
<http://www.dinex.com>

# LOW PROFILE DELIVERY CARTS (Two Door, Two Trays Per Slide)

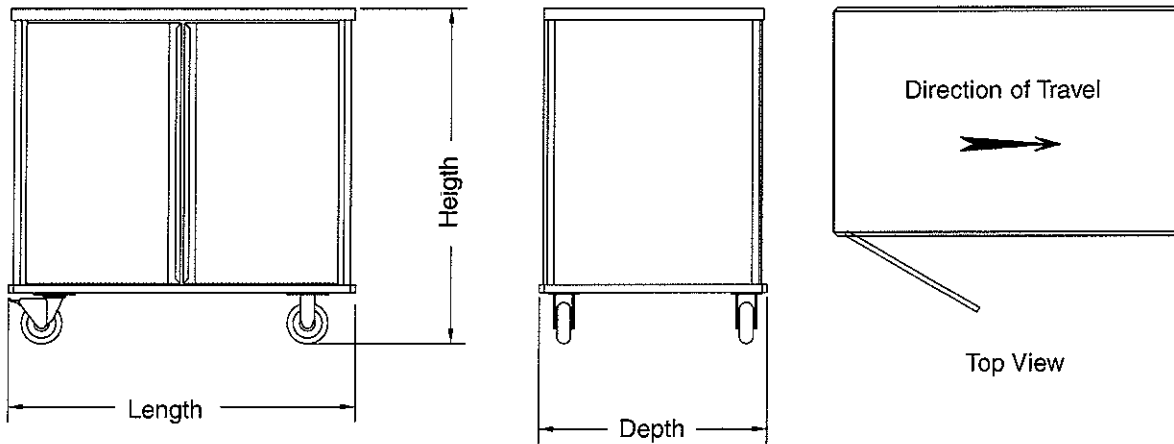

## Items and Dimensions

MODEL NUMBER	LENGTH	DEPTH	HEIGHT	SHIP WEIGHT	SHIP CUBE	TRAY SPACING	TRAY CAPACITY
TS2T2D24	51.25" (130cm)	33.5" (85cm)	49.25" (125cm)	323 lbs. (146.6kg)	43.50	5.875" (15cm)	24
TS2T2D28	51.25" (130cm)	33.5" (85cm)	49.25" (125cm)	323 lbs. (146.6kg)	43.50	5.0" (13cm)	28
TS2T2D32	51.25" (130cm)	33.5" (85cm)	57.5" (146cm)	331 lbs. (150.3kg)	52.00	5.375" (14cm)	32
TS2T2D36	51.25" (130cm)	33.5" (85cm)	57.5" (146cm)	331 lbs. (150.3kg)	52.00	4.75" (12cm)	36

## Optional Accessories

### Casters

- Polyurethane (8")
- Performa (8")
- 6" Carpet casters
- 8" Carpet casters

### Top Rail

- 2.3" high (6cm), 3-sided
- 2.3" high (6cm), 4-sided

### Other Options

- Floor drain
- Menu card holder
- Transport latch
- Tow hitch
- Wall saver (corner bumper)
- Pass-thru doors



Please confirm that you have the most current specification sheet by visiting [www.dinex.com](http://www.dinex.com).  
Dinex® reserves the right to change specifications and product design without notice.  
Such revisions do not entitle the buyer to corresponding changes, improvements, additions or replacements for previously purchased equipment

Printed in USA

## **DINEX** International, Inc.

Building 2, Suite 106  
628 Hebron Avenue  
Glastonbury, CT 06033-5006  
(800) 523-9752 Fax: (860) 652-3135  
<http://www.dinex.com>

TMP-007-REV 09/05

# DINEX®

JOB \_\_\_\_\_ ITEM # \_\_\_\_\_

## TURNBURY®

*Introduces china-like elegance to food service.*

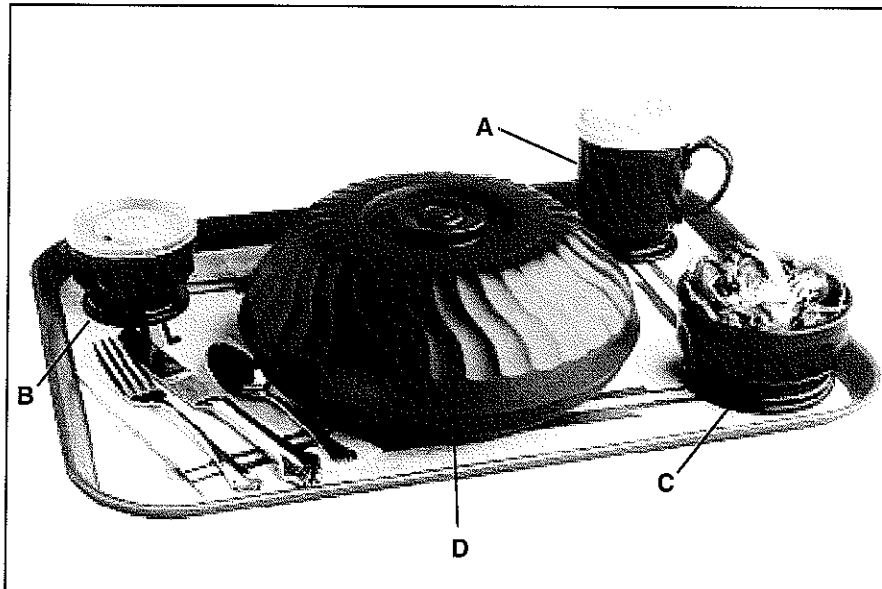

### Application

The distinctive sculptured design adds an air of refinement to patient service by fusing the elegant look of china with the superior temperature retention of foam insulation. Six popular color choices coordinate beautifully with a wide selection of other Dinex® traytop products, including high quality Traycovers, Napkins and Patient Menus. The stylish collection for hot or cold beverages/meals, features contemporary "swirl" design with pedestal base and china-like appearance. Not intended for use in microwave or conventional ovens, hot/cold carts.

### Material

Polypropylene, double-wall construction with ozone-safe urethane foam insulation. Dome features, one piece construction with molded knob. Not stackable. Latex free construction.

### Washing Instructions:

Weekly, soaking 6-8 hours. Wash in commercial dishmachine. Do NOT use bleach. Can withstand washing temperatures up to 180°F.

### EZ-Sip™ Lid:

Keep hot beverages hot and cold drinks cold more effectively with the Dinex® EZ-Sip™ Lid. This disposable drink-through lid, designed to fit the Turnbury® mug, features snug, snap-fit styling for better temperature retention. The drink-through slot will also accommodate a drinking straw.

### 8 oz. Mug (A)

- 3000/11 - Onyx
- 3000/12 - Mauve
- 3000/20 - Cranberry
- 3000/27 - Gray
- 3000/28 - Midnight Blue
- 3000/33 - Teal
- 3000/36 - Hunter Green

### Lids for 8 oz. Mug

- 3000/8775 - EZ Sip™ Lid
- 3000/8714 - Translucent Lid

### 5 oz. Bowl (B)

- 3200/11 - Onyx
- 3200/12 - Mauve
- 3200/20 - Cranberry
- 3200/27 - Gray
- 3200/28 - Midnight Blue
- 3200/33 - Teal
- 3200/36 - Hunter Green

### Lids for 5 oz. Bowl (B)

- 3000/8714 - Translucent Lid

### 9 oz. Bowl (C)

- 3300/11 - Onyx
- 3300/12 - Mauve
- 3300/20 - Cranberry
- 3300/27 - Gray
- 3300/28 - Midnight Blue
- 3300/33 - Teal
- 3300/36 - Hunter Green

### Lids for 9 oz. Bowl

- 3300/8714 - Translucent Lid
- 1183/0174 - Dome Lid

### Insulated Dome (D)

- 3400/11 - Onyx
- 3400/12 - Mauve
- 3400/20 - Cranberry
- 3400/27 - Gray
- 3400/28 - Midnight Blue
- 3400/33 - Teal
- 3400/36 - Hunter Green

See spec sheet #370 for options on Domes, Insul Bases and Underliners

## DINEX® International, Inc.

Building 2, Suite 106  
628 Hebron Avenue  
Glastonbury, CT 06033-5006  
(800) 523-9752 Fax: (860) 652-3135  
<http://www.dinex.com>

# TURNBURY®

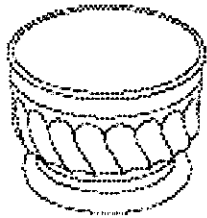

5 oz. Bowl

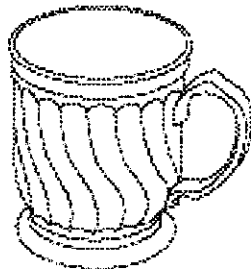

8 oz. Mug

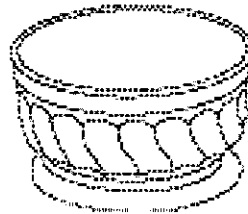

9 oz. Bowl

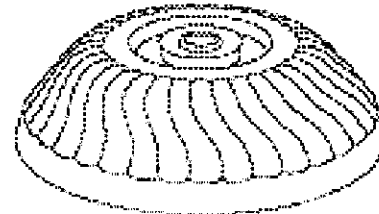

Dome

## Items and Dimensions

ITEM NUMBER	DIAMETER	OVERALL HEIGHT	PACK	SHIP WEIGHT	SHIP CUBE	CAPACITY	FREIGHT CLASS	MATERIAL
3000/Series (Mug)	3-1/2"	4"	48	11.9 lbs. (5.4kg)	1.5	8 oz.	85	Polypropylene
3200/Series (Bowl)	3-1/2"	2-3/8"	48	7.8 lbs. (3.5kg)	.90	5 oz.	85	Polypropylene
3300/Series (Bowl)	4-3/8"	2-3/8"	48	11.2 lbs. (5.1kg)	1.4	9 oz.	85	Polypropylene
3400/Series (Dome)	10"	2-7/8"	12	10.0 lbs. (4.5kg)	.90	-	85	Polypropylene
3000/8775 (EZ-Sip™ Lid)	-	3/8"	1,000	7.5 lbs. (3.4kg)	2.1	-	250	Polystyrene
3000/8714 (Lid)	-	-	1,500	7.5 lbs. (3.4kg)	2.5	-	250	Polystyrene
3300/8714 (Lid)	-	-	1,000	7.1 lbs. (3.2kg)	2.1	-	250	Polystyrene
1183/0174 (Dome Lid)	-	-	1,000	8.6 lbs. (3.9kg)	1.1	-	150	Polystyrene

Note: Turnbury® Tray serving height (measured on a standard patient tray) with:

- Insul Base 4-1/4"
- Wax Base Underliner 4-7/16"
- Dome only 3"
- Tray height with EZ-Sip™ Lid 4-1/2"

Please confirm that you have the most current specification sheet by visiting [www.dinex.com](http://www.dinex.com).  
Dinex® reserves the right to change specifications and product design without notice.  
Such revisions do not entitle the buyer to corresponding changes, improvements, additions or replacements for previously purchased equipment.

Printed in USA

## **DINEX®** International, Inc.

Building 2, Suite 106  
628 Hebron Avenue  
Glastonbury, CT 06033-5006  
(800) 523-9752 Fax: (860) 652-3135  
<http://www.dinex.com>

301-REV 05/06

# Quality, affordable narrow rim china beautifully frames food



A Narrow rim, undecorated bright white



A Narrow rim dunes

## **A** NARROW RIM CHINA

The narrow rim provides maximum space for food. Oneida quality and warranty at an economical price. Available in undecorated bright white and a speckled brown Dunes pattern.

### Undecorated - Bright White

#02983	10 3/8" Plate, Bright White	\$ case of 12
1. #02982	9" Plate, Bright White	\$ case of 24
#02981	6 3/8" Plate, Bright White	\$ case of 36
2. #02978	4 1/2 Oz. Fruit, Bright White	\$ case of 36
#02980	7 Oz. Bouillon, Bright White	\$ case of 36
#03019	13 1/2 Oz. Nappie, Bright White	\$ case of 36
#02979	12 Oz. Grapefruit, Bright White	\$ case of 36
#02934	11 Oz. Mug, Bright White	\$ case of 36
3. #02977	7 Oz. Cup, Bright White	\$ case of 36
4. #02996	5 1/2" Saucer, Bright White	\$ case of 36

### Dunes Pattern

#02974	10 3/8" Plate	\$ case of 12
5. #02891	9" Plate	\$ case of 24
#02890	6 3/8" Plate	\$ case of 36
6. #02887	4 1/2 Oz. Fruit	\$ case of 36
#02888	12 Oz. Grapefruit	\$ case of 36
#02889	7 Oz. Bouillon	\$ case of 36
#02884	8 Oz. Cafe Mug	\$ case of 36
7. #02886	7 Oz. Cup	\$ case of 36
8. #02885	5 3/4" Saucer	\$ case of 36

Log on to [www.DirectSupply.net](http://www.DirectSupply.net) for additional china accessories and tips on extending the life of your china  
**SEARCH: china or extending china**

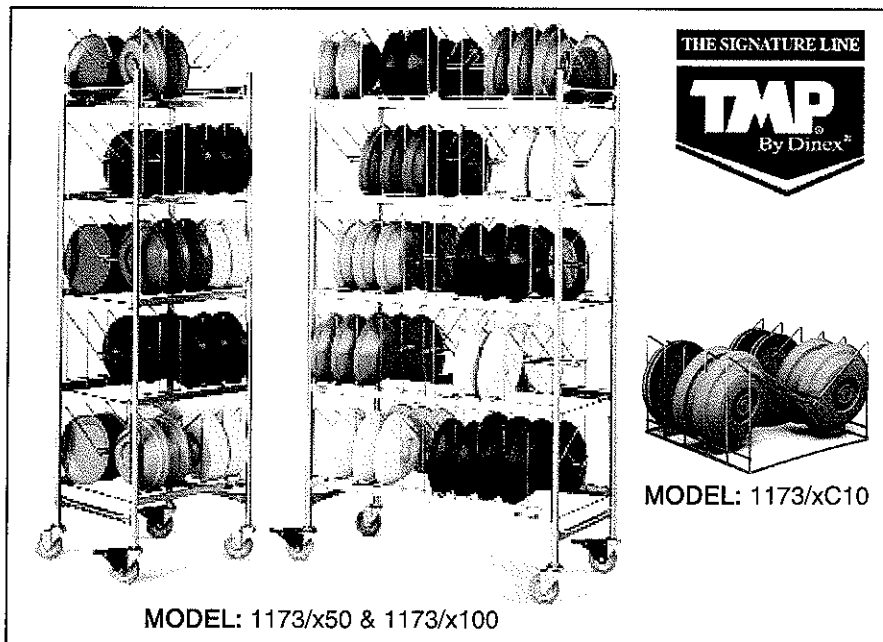
**DRYING AND STORAGE CARTS****Model Numbers**

- 1173/x50
- 1173/x80
- 1173/x100

**For Induction Bases**

- 1173/x90
- 1173/x144
- 1173/x180

**Cradle Inserts**

- 1173/xC10
- 1173/xC11

**Application**

The TMP<sup>®</sup> Drying and Storage Carts come fully assembled and ready to use. The frame is constructed of 1" tubular stainless steel for light weight and maximum strength. Cradle supports are 14 gauge welded and polished stainless steel. Cradles are uncoated stainless steel, and will not chip, split or corrode.

**Construction****Frame:**

16-gauge stainless steel upright frame, 1" diameter

**Cradle Support:**

14-gauge stainless steel angle bars and 1" stainless steel center supports to hold removable cradle inserts (shipped with cart)

**Casters:**

Four-4" swivel casters: Two have locking brakes

**Features**

- Industrial-strength swivel-stem casters provide easy maneuverability. Locking wheels on 2 casters will secure cart in place.
- Carts feature a unique cradle design for easy loading, efficient drying and storage.
- Cradles are removable for easier ware washing in dish machine
- Dry and store combinations for domes, insul-bases or Quick•Temp plastic bases and underliners on the same cart for convenient storage, transport and tray make-up.
- Three sizes are available to meet your space requirements and storage needs

**Warranty**

One year parts and labor.

**DINEX.  
International, Inc.**

Building 2, Suite 106  
628 Hebron Avenue  
Glastonbury, CT 06033-5006  
(800) 523-9752 Fax: (860) 652-3135  
<http://www.dinex.com>



# DRYING AND STORAGE CARTS

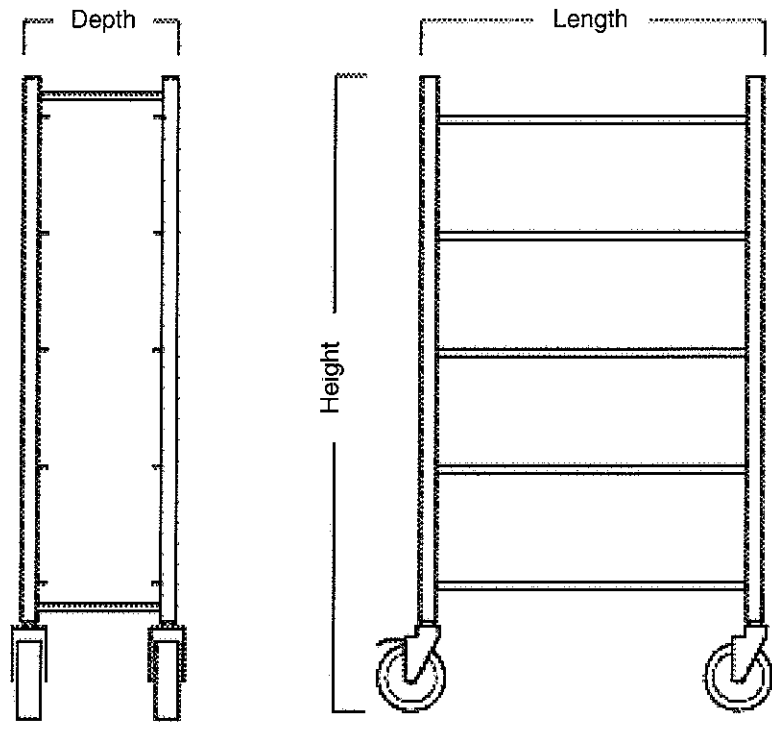

## Items and Dimensions

MODEL NUMBER	LENGTH	DEPTH	HEIGHT	WITH CRADLES	SHIP WEIGHT	SHIP CUBE	CRADLES SPACING	SHELF SPACING	NUMBER OF CRADLES	DOMES/ UNDERLINERS PER CRADLE	TOTAL CAP. DOMES/ UNDERLINERS
1173/x50	19.5" (50cm)	20 25" (51cm)	73" (185cm)	79" (201cm)	115 lbs. (52.2kg)	19.2	3.5" (9cm)	13" (33cm)	5	10/20	50/100
1173/x80	40" (102cm)	20 25" (51cm)	59" (150cm)	65" (165cm)	125 lbs. (56.8kg)	29.9	3.5" (9cm)	13" (33cm)	8	10/20	80/160
1173/x100	40" (102cm)	20 25" (51cm)	73" (185cm)	79" (201cm)	145 lbs. (65.8kg)	36.3	3.5" (9cm)	13" (33cm)	10	10/20	100/200

MODEL NUMBER	LENGTH	DEPTH	HEIGHT	WITH CRADLES	SHIP WEIGHT	SHIP CUBE	CRADLES SPACING	SHELF SPACING	NUMBER OF CRADLES	INDUCTION BASES PER CRADLE	TOTAL CAP. INDUCTION BASES
1173/x90	19.5" (50cm)	20 25" (51cm)	73" (185cm)	79" (201cm)	115 lbs. (52.2kg)	19.2	2" (5cm)	13" (33cm)	5	18	90
1173/x144	40" (102cm)	20 25" (51cm)	59" (150cm)	65" (165cm)	125 lbs. (56.8kg)	29.9	2" (5cm)	13" (33cm)	8	18	144
1173/x180	40" (102cm)	20 25" (51cm)	73" (185cm)	79" (201cm)	145 lbs. (65.8kg)	36.3	2" (5cm)	13" (33cm)	10	18	180

### Cradle Insert

Model Number	Length	Depth	Height
1173/xC10	18"	17.5"	10.5"
1173/xC11	18"	17.5"	10.5"

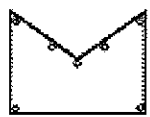

Front View

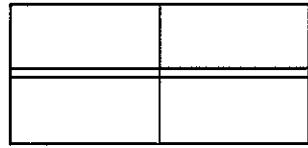

Side View

Stainless steel cradle insert 14-gauge (uncoated) stainless steel

# DINEX<sup>®</sup>

## International, Inc.

Building 2, Suite 106  
 628 Hebron Avenue  
 Glastonbury, CT 06033-5006  
 (800) 523-9752 Fax: (860) 652-3135  
<http://www.dinex.com>

Please confirm that you have the most current specification sheet by visiting [www.dinex.com](http://www.dinex.com)  
 Dinex<sup>®</sup> reserves the right to change specifications and product design without notice.  
 Such revisions do not entitle the buyer to corresponding changes, improvements,  
 additions or replacements for previously purchased equipment.

## Tray & Silver Cart

- Use to neatly organize trays and accessories for self-service
- Eight clear Camwear® food pans hold flatware, napkins and non-perishable condiments
- Protective vinyl cover included

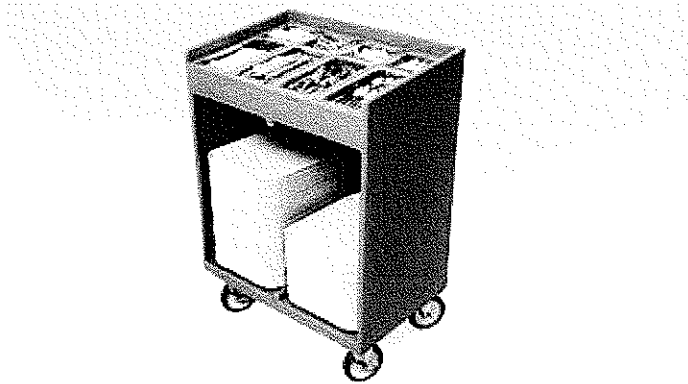

TC1418

14" x 18"

180-200, stacked side by side 500 lbs

32 3/8" x 21 1/4" x 45 1/2"

# Virtually unbreakable and dishwasher-safe dinnerware



Tough polycarbonate dinnerware is easy to clean, dishwasher safe up to 210°F, resists stains and odors, and is even fire resistant. Available in 5 colors (shown below) plus clear.

COOKING EQUIPMENT  
FOOD PREPARATION  
ICE & REFRIGERATION  
DINING SERVICES  
STORAGE & TRANSPORT  
DISHROOM

**SMALLWARES**

## C OVAL PLATTERS & COMPARTMENT PLATES

- #23849 Small Oval Platter, 9¼" x 6¼" \$ ea.
- #23850 Large Oval Platter, 12" x 8½" \$ ea.
- #23852 Compartment Plate, 9½" \$ ea.
- (available in beige only)
- #23853 Compartment Plate, 11" \$ ea.

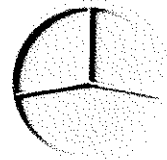

C #23852

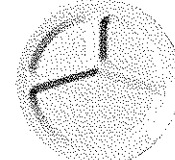

C #23853

## D PLATES

- #23861 5½" Rimmed Plate \$ ea.
- #23860 6½" Rimmed Plate \$ ea.
- #23859 7¼" Rimmed Plate \$ ea.
- #23858 8" Rimless Plate \$ ea.
- #23857 8¼" Rimmed Plate \$ ea.
- #23856 9" Rimmed Plate \$ ea.
- #23855 9" Rimless Plate \$ ea.
- #23854 10" Rimmed Plate \$ ea.



D #23855

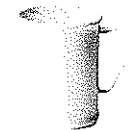

E #23870

## E MUGS, CUPS & SAUCERS

- #23868 Standard Cup, 7 Oz \$ ea.
- #23869 Stacking Cup, 7½ Oz \$ ea.
- #23870 Mug, 9½ Oz \$ ea.
- #23871 Standard Saucer \$ ea.
- #23872 Stacking Saucer \$ ea.

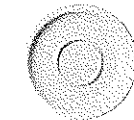

E #23871



E #23872

## F BOWLS

- #23862 Bouillon Bowl, 8½ Oz \$ ea.
- #23863 Fruit Bowl, 5 Oz \$ ea.
- #23866 Small Fruit Bowl, 3½ Oz. \$ ea.
- #23864 Nappie Bowl, 15 Oz. \$ ea.
- #23867 Small Nappie Bowl, 12½ Oz \$ ea.
- #23865 Grapefruit Bowl, 10 Oz \$ ea.



E #23868



E #23869



F #23862



F #23865

beige	slate blue	navy	black
white	clear	<b>CAMBRO</b>	